

# NEED HELP?

This book has all the feature operation and troubleshooting you need to install and operate your new VTech phone. Please take the time to review thoroughly to ensure proper installation and the benefit of this VTech innovative and feature rich product. You can also visit our website at [www.vtechphones.com](http://www.vtechphones.com) for support, shopping, and everything new at VTech. In Canada, please visit [www.vtechcanada.com](http://www.vtechcanada.com).

VTech toll free 1-800-595-9511  
In Canada dial 1-800-267-7377

# Parts Check List

## Parts Check List:

1. Handset(2)
2. Base Unit
3. Telephone line cord
4. Batteries(2)
5. Base Power Adapter
6. Handset Charger
7. Charger Power Adapter
8. User's Manual

To purchase replacement batteries, visit us on the web at [www.vtechphones.com](http://www.vtechphones.com) or call VTech Communications, Inc. at 1-800-595-9511. In Canada, contact VTech Telecommunications Canada Ltd. at [www.vtechcanada.com](http://www.vtechcanada.com) or 1-800-267-7377.



HANDSET

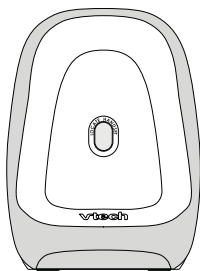

BASE UNIT

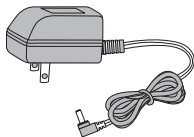

BASE POWER ADAPTER

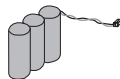

BATTERY



CHARGER

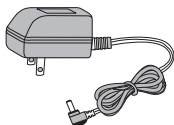

CHARGER POWER ADAPTER

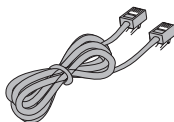

TELEPHONE LINE CORD

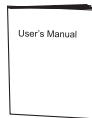

USER'S MANUAL

# Installation

## Install Handset Battery

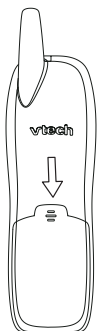

- a) Remove battery compartment cover by pressing on the indentation and sliding downwards.

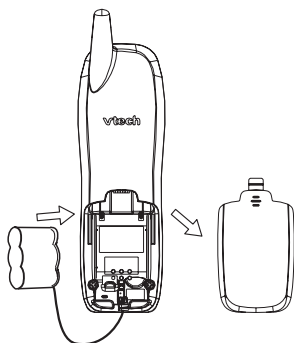
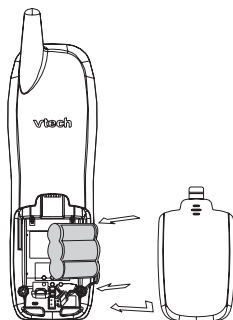

- b) Align the two holes in the plug with the socket pins, then snap the plug into place.
- c) Place the battery in the compartment with the wires in the lower right corner. Angle the top of the battery under the top claws first, then snap the bottom of the pack in. Place the wires under the guide, located below the battery.
- d) Replace cover by sliding it up into place.
- e) Place the handset in its base when not in use to ensure maximum daily performance.

## Choose Location

For maximum performance of your cordless telephone system:

1. Choose a central location for your base unit.
2. Install your base unit and extension handsets away from electronic equipment, such as personal computers, television sets and microwave ovens.
3. In locations where there are multiple cordless telephones, separate base units as much as possible.
4. Install your telephone equipment away from heat sources and sunlight.
5. Avoid excessive moisture, dust or extreme cold.

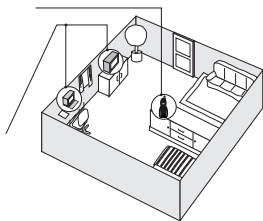

# Installation

## Table/Desk Installation

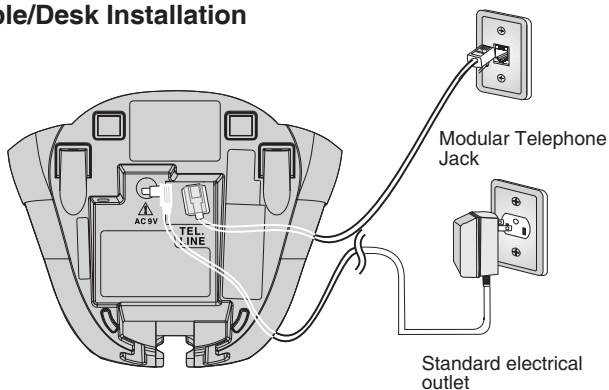

After charging the battery for at least 12 hours, connect the telephone line cord. Connect the power cord.

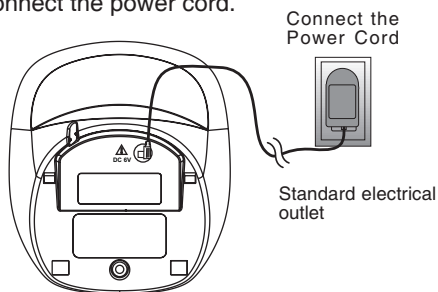

## Wall Mounting

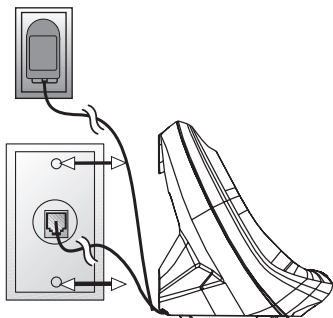

1. Run the power and telephone cords through the slot, then connect them to the jacks located on the underside of the base.
2. Plug the AC adapter into an electrical outlet. If the battery has not been previously charged, place the handset in the base, and allow it to charge for 12 hours (or overnight). Connect the telephone line cord to the wall jack.

# Installation

---

3. Mount the base on the wall. Position the base unit so the mounting studs will fit into the holes on the wall mount bracket. Slide the base unit down on the mounting studs until it locks into place.

## Charge the Handset Battery

Place the handset in the base. Charge the battery for at least 15 hours the first time.

## Set Language Mode

- Press **PROG**, and then press ▼ or ▲ until **LANGUAGE** is displayed. Press **SELECT**.
- The current setting blinks. Press ▼ or ▲ until the screen displays the correct language( English or Spanish).
- Press **SELECT** to save the language mode.

## Check for Dial Tone

After the batteries are charged, pick up the handset and press **PHONE**; you should hear a dial tone. If you do not, try this phone in another phone jack.

## Set the Dial Mode

If you have touch tone service, the phone is ready to use as soon as the batteries are charged.

If you have dial pulse (rotary) service, you'll need to change the dial mode.

- Press **PROG** on the handset.
- Press ▼ or ▲ until the screen displays **DIAL MODE:** and the currently selected mode.
- Press **SELECT**. The current setting blinks.
- Press ▲ to select **TONE** or **PULSE**.
- Press **SELECT** to save.

## Set Handset Date and Time

If you subscribe to caller ID service, the date and time will be set automatically with the first incoming call. If you do not have CID service, you can set the date and time manually.

- Press **PROG** on the handset.
- Press ▼ or ▲ until **DATE/TIME** is displayed. Press **SELECT**.
- The month is flashing. Press ▼ or ▲ until the screen displays the correct month. Press **SELECT**.
- The day is flashing. Press ▼ or ▲ until the screen displays the correct day. Press **SELECT**.
- The hour is flashing. Press ▼ or ▲ until the screen displays the correct hour. Press **SELECT**.
- The minute is flashing. Press ▼ or ▲ until the screen displays the

# Installation

correct minute. Press **SELECT**.

- **AM** or **PM** is flashing. Press ▼ or ▲ to choose between **AM** or **PM**. Press **SELECT**.

## Handset Ringer Style/Battery Save

You can select from four different handset ringer styles, or turn the ringer off and extend the battery life.

1. With the handset in idle (off) mode, press **PROG**.
2. Press ▲ until the screen displays **RINGER:** and the currently selected ringer.
3. Press **SELECT**. The current setting blinks, and you will hear a sample of the ring.
4. Press ▲ or ▼ to select **RINGER: 1, 2, 3, 4** or **OFF**. You will hear a sample of each ring tone.
5. Press **SELECT** to choose the displayed ringer setting.

## Clear Message Waiting Alert

- Press **PROG**.
- Press ▲ or ▼ until screen displays **MESSAGES WAITING**. Press **SELECT**.
- **MSG ALERT OFF** and the current setting will display.

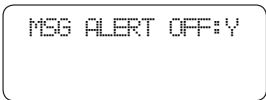

MSG ALERT OFF:Y

- Press ▲ or ▼ to change from **YES** or **NO**.
- Press **SELECT** to choose the desired setting.

# Telephone Operation

## Handset Operation

1. **Make a Call**  
Press before or after dialing number to place a call.
2. **Flash/Call Waiting**  
Press to begin a call, then dial a number. During a call, press to receive an incoming call, if Call Waiting is activated.
3. **Channel**
4. **Delete**  
Press to mute microphone. While reviewing call log, press

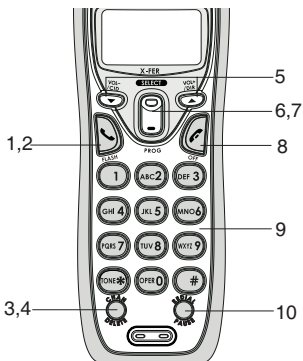

# Telephone Operation

---

and hold to clear Caller ID log.

5. **Handset Volume**

Use the directional arrows to adjust the volume of the handset speaker.

6. **Select**

Press to display menu, or to select highlighted item from menu.

7. **Program**

8. **Off**

During a call, press to hang up. While using menus, press to cancel an operation, back up, or exit the menu display

9. **Answer a Call (any key)**

Press any key to answer a call.

10. **Redial/Pause**

Press to view redial memory. While entering numbers, press and hold to insert a dialing pause.

## Base Operation

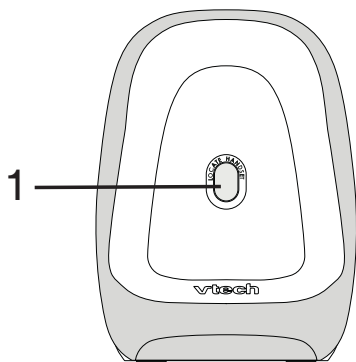

### 1. Page Key

- Press the **Locate handset** key to page the handset.
- Press it second time to cancel a page.
- The base will ring the handset for one minute before ending the page automatically.
- The handset can also cancel the page by pressing the **OFF** key.

## Temporary Tone Dialing

If you have pulse (rotary) service, you can change from pulse dialing to touch tone dialing during a call by pressing \* **TONE**. This is useful if you need to send touch tone signals for access to telephone banking or long distance services.

1. Dial the number.
2. Press \* **TONE**. Buttons pressed after this send touch tone signals.
3. After you hang up, the phone automatically returns to pulse service.

## Call Forward

An external call can be forwarded from one Handset (HS1) to the other Handset (HS2).

# Telephone Operation

1. While on a call, press **SELECT** to forward the call to HS2. HS1 will display:

TRANSFERRING CALL

HS2 will ring and show:

CALL TRANSFERRING

- NOTE:** If HS2 can not be found, HS1 will generate a sad tone and continue the call automatically. Before HS2 answers, HS1 can press **PHONE** to cancel the forward function and continue the external call.
2. Press any key except **OFF** on HS2 to answer the forwarded call. HS1 will return to the idle screen.

**NOTE:** If HS1 does not respond within **30** seconds, HS1 will start ringing until you press **PHONE** to pick up the returned call. If the returned call is not answered within another 30 seconds, the external call will end automatically.

## Display Screen Messages

Screen Displays:	When:
** RINGING **	There is a call coming in.
CONNECTING...	The handset is waiting for dial tone.
PHONE ON	The handset is in use.
MESSAGES WAITING	You have been alerted by the telephone company that you have receive new voice mail.
** PAGING **	The base is paging the handset.
BATTERY LOW	The battery needs to be recharged.
SCANNING...	The handset is changing to another of the 30 channels available.
NO CONNECT	Displays and a sad tone sounds when the base power is off and <b>PHONE</b> is pressed.
RINGER OFF	The handset ringer is turned off.



# Speed Dialing

You can store telephone numbers you call frequently in two different ways, as speed dial numbers, or in the directory. Each number can have up to 24 digits. You will program names to go with the numbers, each can have up to 15 characters.

Up to ten numbers and names can be stored, total. You can store as many as nine numbers with names into speed dial memory locations you assign (1 through 9). You can also store numbers with names alphabetically in the directory. See Telephone Directory for instructions.

## Store a Number/Name in Memory:

1. Press **PROG** on the handset.
2. Press ▼ or ▲ until the screen displays **SPEED DIAL**.
3. Press **SELECT**. The screen displays **ENTER 1-9**.  
**NOTE:** When memory is full the screen displays **MEMORY FULL**, an error tone sounds, and you cannot store a new number until you delete a record in speed dial memory or telephone directory.
4. Press the key (1 through 9) for the memory location where you want to store this entry, the screen displays **ENTER NAME**.  
**NOTE:** If the location is not empty, your new entry will be stored in place of the old and the first entry will be deleted. Take caution to not save over entries you do not wish to delete from memory.
5. Using the chart below, enter up to 15 characters for the name you're storing with the number. Use ▼ to backspace and make corrections; use ▲ to advance and add a space.

Press	Once	Twice	3 Times	4 Times	5 Times	6 Times
1	1					
2	A	B	C	2		
3	D	E	F	3		
4	G	H	I	4		
5	J	K	L	5		
6	M	N	O	6		
7	P	Q	R	S	7	
8	T	U	V	8		
9	W	X	Y	Z	9	
0	0					
*	*					
#	&	'	,	-	.	#

6. When you finish entering the name, press **SELECT** or **PROG**. The screen displays **ENTER NUMBER**.
7. Enter the telephone number using the number keys. Use ▼ to backspace and make corrections. After at least one digit has been entered, press **REDIAL/PAUSE** to store pauses in the dialing sequence, if necessary.

# Speed Dialing

---

8. Press **SELECT** or **PROG** to store your entry. The screen displays **DISTINCT RING?** and the current setting.
9. Press ▼ or ▲ to change the setting. Choose **Y** (for yes) if you wish the phone to alert you to calls from this number by changing to a distinctive ringing pattern after the first ring. Choose **N** for a normal ringing pattern.
10. Press **SELECT** or **PROG** to confirm your selection. If you chose **Y**, a **D** will be displayed with the directory entry.

## Edit a Number/Name Stored in Speed Dial Memory

1. Press and hold the memory location key (1 through 9) of the entry you wish to edit.
2. When the screen displays the entry you want to edit, press **SELECT**. Then press ▼ or ▲ until **EDIT** flashes.

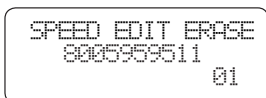

3. Press **SELECT**. The screen displays the name and number. The cursor appears at the end of the name. Use ▼, ▲ and the dial pad keys to edit the name. Press **SELECT** to move on to edit the number. Use ▼ to backspace and make corrections. Press **SELECT** to move to edit the distinctive ring setting. Press **SELECT** to save.

## Delete a Number/Name Stored in Memory

1. Press and hold the memory location key (1 through 9) of the entry you wish to delete.
2. When the screen displays the entry you want to delete, press **SELECT**. Then press ▲ or ▼ until **ERASE** flashes.

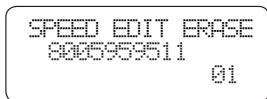
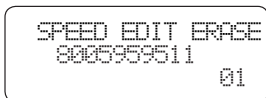

3. Press **SELECT**. The screen displays
4. Press ▲ or ▼ until **YES** flashes.
5. Press **SELECT**. You'll hear a confirmation beep.

## Dial a Memory Number

- Press and hold the memory location key (1 through 9) of the entry you wish to dial.

# Speed Dialing

---

- Press **PHONE** to dial the displayed memory number.

## Reassign Locations in Memory

1. Press and hold the memory location key (1 through 9) of the entry you wish to reassign.
2. When the screen displays the entry you want to reassign, press **SELECT**. Then press **▲** until **SPEED** flashes.

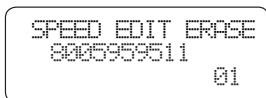

3. Press **SELECT**. The screen displays **ENTER 1-9**.
4. Press the keys (1 through 9) to reassign this entry into another memory location.

# Telephone Directory

---

Your phone can store 30 (including the nine speed dial entries) numbers with names (up to 15 characters for the name and 24 digits for the number) in each handset.

## Store a Number/Name in the Directory

1. Press **PROG**. The screen displays **DIRECTORY**.
2. Press **SELECT**. The screen displays **ENTER NAME**.
3. Using the chart in pg10, enter up to 15 characters for the name you're storing with the number. Use **▼** to backspace and make corrections; use **▲** to advance and add a space.
4. When you finish entering the name, press **SELECT** or **PROG**. The screen displays **ENTER NUMBER**.
5. Enter the telephone number. Use **▼** to backspace and make corrections.  
Press **REDIAL/PAUSE** to store a pause in the dialing sequence.  
-OR-  
Press **REDIAL/PAUSE** to display the last number dialed from this phone.
6. Press **SELECT** or **PROG**. The screen displays **DISTINCT RING?** and the current setting.
7. Press **▼** or **▲** to change the setting. Choose **Y** (for yes) if you wish the phone to alert you to calls from this number by changing to a distinctive ringing pattern after the first ring. Choose **N** for a normal ringing pattern.

# Telephone Directory

---

8. Press **SELECT** or **PROG** to confirm your selection. If you chose **Y**, a **D** will be displayed with the directory entry.

## Edit a Number/Name Stored in the Directory

1. Press **▲** (**DIR**). The screen displays **DIRECTORY**.
2. Press **▼** or **▲** to scroll alphabetically through the entries stored in the directory.

**-OR-**

Press the dial pad key for the first letter of the entry you want to edit.

3. When the screen displays the entry you want to edit, press **SELECT**. Then press **▼** or **▲** until **EDIT** flashes.



```
SPEED EDIT ERASE
8005959511
01
```

4. Press **SELECT**. The screen displays the name and number. The cursor appears at the end of the name. Use **▼**, **▲** and the dial pad keys to edit the name. Press **SELECT** to move on to edit the number. Use **▼** to back space and make corrections. Press **SELECT** to move on to edit the distinctive ring setting.
5. Press **SELECT** to save the edited information.

## Delete a Number/Name Stored in the Directory

1. Press **▲** (**DIR**). The screen displays **DIRECTORY**.
2. Press **▼** or **▲** to scroll alphabetically through entries in the directory.

**-OR-**

Press the dial pad key for the first letter of the entry you want to delete.



```
SPEED EDIT ERASE
8005959511
01
```

3. When the screen displays the entry you want to delete, press **SELECT**. Then press **▼** or **▲** until **ERASE** flashes.
4. Press **SELECT**. The screen displays **ERASE NO YES** and the number. The current choice flashes.
5. Press **▼** or **▲** until **YES** flashes.
6. Press **SELECT**. You'll hear a confirmation beep.

# Telephone Directory

---

## Dial a Number from the Directory

1. Press ▲ (DIR). The screen displays **DIRECTORY**.
2. Press ▼ or ▲ to scroll alphabetically through entries stored in directory.

**-OR-**

Press the dial pad key for the first letter of the entry you want to dial.

3. When the number you want to dial is displayed, press **PHONE**.

## Move a Number/Name to the Memory

1. Press ▲ (DIR). The screen displays **DIRECTORY**.
2. Press ▼ or ▲ to scroll alphabetically through directory.

**-OR-**

Press the dial pad key for the first letter of the entry you want to move.

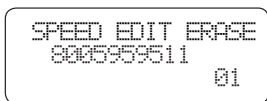

3. When the screen displays the entry you want to move, press **SELECT**. Then press ▲ until **SPEED** flashes
4. Press **SELECT**. The screen displays **ENTER 1-9**.
5. Press the key (1 through 9) to move this entry from the normal directory to the speed dial memory and assign the memory location. You'll hear a confirmation beep. A memory location number (01 through 09) will be displayed with this entry. You'll hear a confirmation beep.

## Caller ID Operation

---

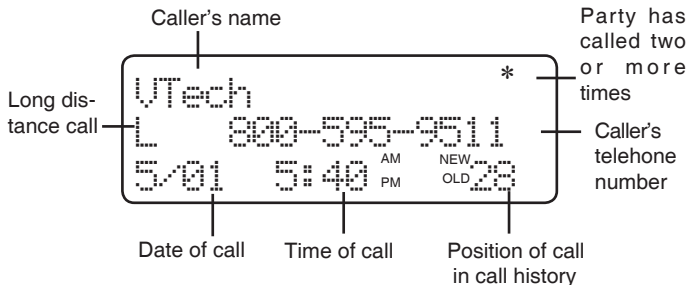

# Caller ID Operation

---

## About Call History (Caller ID)

Your phone can store up to **30** calls in its caller ID memory. The most recent call will have the highest number. When the memory is full, the oldest call will be deleted to make room for new incoming call information.

For each call that comes in, the screen displays the following information between the first and second rings:

- Your caller's name (15 letters are sent by your telephone company).
- The caller's area code and telephone number.
- The time and date of the call.
- The repeat tag (\*) in the upper right corner, indicating the party has called more than once.

If you answer a call before the information appears on the screen, it will not be in the call history.

## Review Call History

1. Press ▼ (CID) to view call history.
2. Use ▼ and ▲ to scroll through records in call history.

## Delete Records from Call History

### Delete a Specific Call:

1. Locate the record you want to delete from call history.
2. Press **DELETE**. You'll hear a confirmation beep.

### Delete All Calls:

1. With the handset in idle (**OFF**) mode, press and hold **DELETE**. The screen displays **ERASE ALL NO YES**. The current choice flashes.
2. Press ▼ or ▲ until **YES** flashes.
3. Press **SELECT**. You'll hear a confirmation beep.

## Dial a Displayed Number

1. Locate the record in call history that you want to dial.
2. If you wish to change how the number is dialed, press #. The screen displays alternate dialing options:

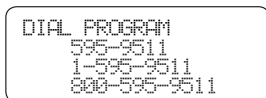

3. Press **SELECT**. Press ▲ until **DIAL** flashes.

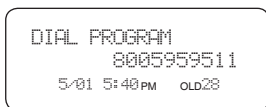

# Caller ID Operation

4. Press **SELECT**. again. The number is automatically dialed.  
-OR-

When the number is correctly displayed for dialing, press **PHONE**.

## Store a Call History Record in the Directory

1. Locate the record in the call history you want to store in the directory.
2. If you wish to change how the number is dialed, press #. The screen displays alternate dialing options:

```
DIAL PROGRAM
595-9511
1-595-9511
800-595-9511
```

3. Press **SELECT**. then press ▲ until **PROGRAM** flashes.

```
DIAL PROGRAM
      8005959511
5/01 5:40PM  OLD28
```

4. Press **SELECT** three times. The screen displays:

```
DIAL PROGRAM
      8005959511
5/01 5:40PM  OLD28
```

5. Press ▼ or ▲ to select Y or N for distinctive ringer.
6. Press **SELECT**. You will hear a confirmation beep. If you choose **Y** in step 5 a **D** will be displayed with the directory entry.

## Display Screen Messages

Screen Displays:	When:
PRIVATE	The other party is blocking name information.
	The other party is blocking name and number information.
UNKNOWN	Your phone company is unable to receive information about this caller's name and/or number.
	Your phone company is unable to receive information about this caller name and number.

# Batteries

## Battery Care and Maintenance

- A fully charged battery provides an average talk time of about six hours.
- The battery needs charging when:
  - A new battery is installed in the handset.
  - The phone beeps twice every five seconds.
  - The screen displays **BATTERY LOW** and the low battery icon.
- Place the handset in the base so the **CHARGING** light turns on. The battery is typically fully charged in 12 hours.
- You can keep the battery fully charged by returning the handset to the base after each use.



**CAUTION:** To reduce the risk of fire or injury to persons or damage to the telephone, read and follow these instructions carefully: Charge the battery provided with or identified for use with this product only in accordance with the instructions and limitations specified in the User's Manual.

## Replacing the Handset Battery

1. Remove the battery compartment cover on the handset by pressing on the indentation and sliding the cover downward.
2. Lift out the old battery and disconnect.
3. Align the two holes in the new battery's plug with the socket pins, and snap the plug into place. Snap the battery in the compartment, as described in Installation, on page 5.
4. Replace the cover by sliding it up into place.
5. The new battery must be charged before using the phone. Place the handset in the base and allow it to charge for at least 12 hours the first charge. The telephone might operate before that, but for best performance, let the battery charge fully.

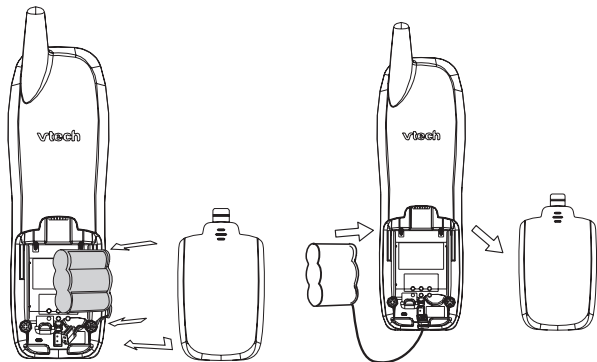



# Troubleshooting

If you have difficulty operating your phone, the suggestions below should solve the problem. If you still have difficulty after trying these suggestions, call VTech Communications at 1-800-595-9511. In Canada, call VTech Telecommunications Canada Ltd. at 1-800-267-7377.

Problem	Suggestion
My phone doesn't work at all.	<ul style="list-style-type: none"><li>• Make sure the power cord is plugged in.</li><li>• Make sure the telephone line cord is plugged firmly into the base unit and the telephone wall jack.</li><li>• Charge the battery in the handset for 12 hours. For optimum daily performance, return the handset to its base when not in use.</li><li>• Reset the base. Unplug the unit's electrical power. Wait for 15 seconds then plug it back in. Allow up to one minute for the handset and base to reset.</li><li>• You may need to purchase a new battery, please refer to the <b>Batteries</b> section of this user's manual.</li></ul>
I cannot get a dial tone.	<ul style="list-style-type: none"><li>• First try all the suggestions above.</li><li>• Move the handset closer to the base. You might have moved out of range.</li><li>• Reset the base. Unplug the unit's electrical power. Wait for 15 seconds then plug it back in. Allow up to one minute for the handset and base to reset.</li><li>• Your line cord might be malfunctioning. Try installing a new line cord.</li><li>• You may need to purchase a new battery, please refer to the <b>Batteries</b> section of this user's manual.</li><li>• If the previous suggestions don't work, disconnect the base unit from the telephone jack and connect a different phone. If there is no dial tone on that phone either, the problem is in your wiring or local service. Contact your local telephone company.</li></ul>
I cannot dial out.	<ul style="list-style-type: none"><li>• Make sure you have a dial tone before dialing. The handset may take a second or two to find the base and produce a dial tone. This is normal. Wait an extra second before dialing.</li><li>• Make sure your phone is set to the correct dial mode for the type of service that you have (pulse or touchtone). Refer to the <b>Installation</b> section of this user's manual to set the dial mode.</li></ul>

# Troubleshooting

Problem	Suggestion
I cannot dial out.	<ul style="list-style-type: none"><li>• If the other phones in your home are having the issue, the problem is in your wiring or local service. Contact your local telephone company (charges may apply.)</li><li>• Eliminate any background noise. Noise from a television, radio or other appliance may cause the phone to not dial out properly. If you cannot eliminate the background noise, first try muting the handset before dialing, or dialing from another room in your home with less background noise.</li></ul>
My handset beeps four times and isn't performing normally.	<ul style="list-style-type: none"><li>• Make sure the power cord is securely plugged into the base. Plug the unit into a different, working outlet not controlled by a wall switch.</li><li>• Move the handset closer to the base. You might have moved out of range.</li><li>• If the handset is in its base and the charging light does not come on, refer to <b>Charge Light is Off</b> in this troubleshooting guide.</li><li>• Reset the base. Unplug the unit's electrical power. Wait for 15 seconds then plug it back in. Allow up to one minute for the handset and base to reset.</li><li>• Other electronic products can cause interference with your cordless phone. Try installing your phone as far away from these types of electronic devices as possible: radios, radio towers, pager towers, cell phones, intercoms, room monitors, televisions, personal computers, kitchen appliances and other cordless phones.</li></ul>
No Connect displays on my handset.	<ul style="list-style-type: none"><li>• Move the handset closer to the base. You might have moved out of range.</li><li>• If the handset is in its base and the charging light does not come on, refer to <b>The charge light is off</b> in this troubleshooting guide.</li><li>• Reset the base. Unplug the unit's electrical power. Wait for 15 seconds then plug it back in. Allow up to one minute for the handset and base to reset.</li><li>• Other electronic products can cause interference with your cordless phone. Try installing your phone as far away from these types of electronic devices as possible: radios, radio towers, pager towers, cell phones, intercoms, room monitors, televisions, personal computers, kitchen appliances and other cordless phones.</li></ul>

# Troubleshooting

Problem	Suggestion
The batteries will not hold a charge.	<ul style="list-style-type: none"><li>• Charge the battery in the handset for 12 hours. For optimum daily performance, return the handset to its base when not in use.</li><li>• You may need to purchase a new battery, please refer to the <b>Batteries</b> section of this user's manual.</li><li>• Your phone might be malfunctioning. Please refer to the <b>Warranty</b> section of this user's manual for further instruction.</li></ul>
I get noise, static, or weak signal even when I'm near the base.	<ul style="list-style-type: none"><li>• Press the <b>CHAN</b> button while on a call until the interference has been eliminated.</li><li>• Other electronic products can cause interference with your cordless phone. Try installing your phone as far away from these types of electronic devices as possible: radios, radio towers, pager towers, cell phones, intercoms, room monitors, televisions, personal computers, kitchen appliances and other cordless phones.</li><li>• Microwaves operate on the same frequency as your phone. It is normal to experience static on your phone while the microwave is running. Do not install this phone in the same outlet or near the microwave.</li><li>• If your phone is plugged in with a modem or surge protector, plug the phone (or modem/surge protector) into a different location. If this solves the problem, re-locate your phone or modem farther apart from one another, or use a different surge protector.</li><li>• Relocate your phone to a higher location. The phone will likely get better reception not installed in a low area.</li><li>• If the other phones in your home are having the issue, the problem is in your wiring or local service. Contact your local telephone company (charges may apply.)</li></ul>
My handset does not ring when I receive a call.	<ul style="list-style-type: none"><li>• Make sure you have the ringer activated. Refer to the section(s) on ringer selection in this User's Manual.</li><li>• Make sure the telephone line cord is plugged firmly into the base unit and the telephone jack. Make sure the power cord is plugged in.</li></ul>

# Troubleshooting

Problem	Suggestion
<p>My handset does not ring when I receive a call.</p>	<ul style="list-style-type: none"><li>• You may be too far from the base unit.</li><li>• Charge the battery in the handset for 12 hours. For optimum daily performance, return the handset to its base when not in use.</li><li>• You may have too many extension phones on your telephone line to allow all of them to ring. Try unplugging some of the other phones.</li><li>• The layout of your home or office might be limiting the operating range. Try moving the base to another location, preferably on an upper floor.</li><li>• If the other phones in your home are having the issue, the problem is in your wiring or local service. Contact your local telephone company (charges may apply.)</li><li>• Test a working phone at the phone jack. If another phone has the same problem, the problem is the phone jack. Contact your local telephone company (charges may apply.)</li><li>• Other electronic products can cause interference with your cordless phone. Try installing your phone as far away from these types of electronic devices as possible: radios, radio towers, pager towers, cell phones, intercoms, room monitors, televisions, personal computers, kitchen appliances and other cordless phones</li><li>• Your line cord might be malfunctioning. Try <b>installing</b> a new line cord.</li></ul>
<p>My calls fade or cut in and out while I'm using my handset.</p>	<ul style="list-style-type: none"><li>• Press the <b>CHAN</b> button while on a call until the interference has been eliminated.</li><li>• Other electronic products can cause interference with your cordless phone. Try installing your phone as far away from these types of electronic devices as possible: radios, radio towers, pager towers, cell phones, intercoms, room monitors, televisions, personal computers, kitchen appliances and other cordless phones</li><li>• Microwaves operate on the same frequency as your phone. It is normal to experience static on your phone while the microwave is running. Do not install this phone in the same outlet or near the microwave.</li></ul>

# Troubleshooting

Problem	Suggestion
My calls fade or cut in and out while I'm using my handset.	<ul style="list-style-type: none"><li>• If your phone is plugged in with a modem or surge protector, plug the phone (or modem/surge protector) into a different location. If this solves the problem, re-locate your phone or modem farther apart from one another, or use a different surge protector.</li><li>• Relocate your phone to a higher location. The phone will get better reception not installed in a low area.</li><li>• If the other phones in your home are having the issue, the problem is in your wiring or local service. Contact your local telephone company (charges may apply.)</li></ul>
I hear other calls while using my phone.	<ul style="list-style-type: none"><li>• Disconnect your base unit from the telephone jack, and plug in a regular telephone. If you still hear other calls, the problem is probably in your wiring or local service. Call your local telephone company.</li></ul>
I hear noise in the handset, and none of the keys or buttons work.	<ul style="list-style-type: none"><li>• Make sure the power cord is plugged in.</li></ul>
The charge light is off.	<ul style="list-style-type: none"><li>• Clean the handset and base charging contact each month using a pencil eraser or cloth.</li><li>• Make sure the power and line cords are plugged in correctly and firmly.</li><li>• Reset the base. Unplug the unit's electrical power. Wait for 15 seconds then plug it back in. Allow up to one minute for the handset and base to reset.</li><li>• Your phone might be malfunctioning. Please refer to the <b>Warranty</b> section of this user's manual for further instruction.</li></ul>
My Caller ID isn't working.	<ul style="list-style-type: none"><li>• Caller ID is a subscription service. You must subscribe to this service for this feature to work on your phone.</li><li>• Your caller must be calling from an area that supports caller ID.</li><li>• Both you and your caller's telephone companies must use caller ID compatible equipment.</li></ul>

# Troubleshooting

Problem	Suggestion
Common cure for electronic equipment.	<p>If the unit does not seem to be responding normally, then try putting the handset in its base. If it does not seem to respond, do the following (in the order listed):</p> <ol style="list-style-type: none"><li>1. Disconnect the power to the base.</li><li>2. Disconnect the handset battery, and spare battery, if applicable.</li><li>3. Wait a few minutes.</li><li>4. Connect power to the base.</li><li>5. Re-install the battery (ies).</li><li>6. Wait for the handset to re-establish its link with the base. To be safe, allow up to one minute for this to take place.</li></ol>

## Maintenance

### Taking care of your telephone

Your cordless telephone contains sophisticated electronic parts, so it must be treated with care.

### Avoid rough treatment

Place the handset down gently. Save the original packing materials to protect your telephone if you ever need to ship it.

### Avoid water

Your telephone can be damaged if it gets wet. Do not use the handset outdoors in the rain, or handle it with wet hands. Do not install your base unit near a sink, bathtub or shower.

### Electrical storms

Electrical storms can sometimes cause power surges harmful to electronic equipment. For your own safety, use caution when using electric appliances during storms.

### Cleaning your telephone

Your telephone has a durable plastic casing that should retain its luster for many years. Clean it only with a soft cloth slightly dampened with water or a mild soap. Do not use excess water or cleaning solvents of any kind.

## Warranty Statement

Remember that electrical appliances can cause serious injury if used when you are wet or standing in water. If your base unit should fall into water, DO NOT RETRIEVE IT UNTIL YOU UNPLUG THE POWER CORD AND TELEPHONE LINE CORDS FROM THE WALL. Then pull the unit out by the unplugged cords.

### What does this limited warranty cover?

- The manufacturer of this VTech product, VTech Communications, warrants to the holder of a valid proof of purchase ("Consumer" or "you") that the product and all accessories provided by VTech in the sales package ("Product") are free from material defects in material and workmanship, pursuant to the following terms and conditions, when installed and used normally and in accordance with operation instructions. This limited warranty extends only to the Consumer for Products purchased and used in the United States of America.

### What will VTech Communications do if the Product is not free from material defects in materials and workmanship during the limited warranty period ("Materially Defective Product")?

- During the limited warranty period, VTech's authorized service representative will repair or replace at VTech's option, without charge, a Materially Defective Product. If we repair this product, we may use new or refurbished replacement parts. If we choose to replace this product, we may replace it with a new or refurbished product of the same or similar design. VTech will return repaired or replacement products to you in working condition.

# Warranty Statement

VTech will retain defective parts, modules, or equipment. Repair or replacement of Product, at VTech's option, is your exclusive remedy. You should expect the repair or replacement to take approximately 30 days.

## How long is the limited warranty period?

- The limited warranty period for the product extends for ONE (1) YEAR from the date of purchase if we repair or replace a Materially Defective Product under the terms of this limited warranty. This limited warranty also applies to repaired or replacement Products for a period of either (a) 90 days from the date the repaired or replacement Product is shipped to you or (b) the time remaining on the original one-year warranty; whichever is longer.

## What is not covered by this limited warranty?

This limited warranty does not cover

1. Product that has been subjected to misuse, accident, shipping or other physical damage, improper installation, abnormal operation or handling, neglect, inundation, fire, water or other liquid intrusion; or
2. Product that has been damaged due to repair, alteration or modification by anyone other than an authorized service representative of VTech; or
3. Product to the extent that the problem experienced is caused by signal conditions, network reliability or cable or antenna systems; or
4. Product to the extent that the problem is caused by use with non-VTech electrical accessories; or
5. Product whose warranty/quality stickers, Product serial numbers plates or electronic serial numbers have been removed, altered or rendered illegible; or
6. Product purchased, used, serviced, or shipped for repair from outside the United States, or used for commercial or institutional purposes (including but not limited to Products used for rental purposes ); or
7. Product returned without valid proof of purchase (see 2 below); or
8. Charges for installation or set up, adjustment of customer controls, and installation or repair of systems outside the unit.

## How do you get warranty service?

- To obtain warranty service in the United States of America, call 1-800-595-9511 for instructions regarding where to return the Product. Before calling for service, please check the user's manual. A check of the Product controls and features may save you a service call.
- Except as provided by applicable law, you assume the risk of loss or damage during transit and transportation and are responsible for delivery or handling charges incurred in the transport of Product (s) to the service location. VTech will return repaired or replaced product under this limited warranty to you, transportation, delivery or handling charges prepaid. VTech assumes no risk for damage or loss of the Product in transit.
- If the Product failure is not covered by this limited warranty, or proof of purchase does not meet the terms of this limited warranty, VTech will notify you and will request that you authorize the cost of repair prior to any further repair activity. You must pay for the cost of repair and return shipping costs for the repair of Products that are not covered by this limited warranty.

## What must you return with the Product to get warranty service?

1. Return the entire original package and contents including the Product to the VTech service location along with a description of the malfunction or difficulty;
2. Include "valid proof of purchase" (sales receipt) identifying the Product purchased (Product model) and the date of purchase or receipt; and
3. Provide your name, complete and correct mailing address, and telephone number.

## Other Limitations

- This warranty is the complete and exclusive agreement between you and VTech. It supersedes all other written or oral communications related to this Product. VTech provides no other warranties for this product. The warranty exclusively describes all of VTech's responsibilities regarding the product. There are no other express warranties. No one is authorized to make modifications to this limited warranty and you should not rely on any such modification.

**State Law Rights:** This warranty gives you specific legal rights, and you may also have other rights which vary from state to state.

Limitations: Implied warranties, including those of fitness for a particular purpose and merchantability (an unwritten warranty that the product is fit for ordinary use) are limited to one year from date of purchase. Some states do not allow limitations on how long an implied warranty lasts, so the above limitation may not apply to you.

- In no event shall VTech be liable for any indirect, special, incidental, consequential, or similar damages (including, but not limited to lost profits or revenue, inability to use the product, or other associated equipment, the cost of substitute equipment, and claims by third parties) resulting from the use of this product. Some states do not allow the exclusion or limitation of incidental or consequential damages, so the above limitation or exclusion may not apply to you.

# Important Safety Instructions

---

When using your telephone equipment, basic safety precautions should always be followed to reduce the risk of fire, electric shock and injury, including the following:

1. Read and understand all instructions.
2. Follow all warnings and instructions marked on the product.
3. Unplug this product from the wall outlet before cleaning. Do not use liquid or aerosol cleaners. Use a damp cloth for cleaning.
4. Do not use this product near water (for example, near a bath tub, kitchen sink or swimming pool).
5. Do not place this product on an unstable surface, such as a table, shelf or stand. The product may fall, causing serious damage.
6. Slots and openings in the back or bottom of the base unit and handset are provided for ventilation. To protect them from overheating, these openings must not be blocked by placing the product on a soft surface such as a bed, sofa or rug. This product should never be placed near or over a radiator or heat register. This product should not be placed in any area where proper ventilation is not provided.
7. This product should be operated only from the type of power source indicated on the marking label. If you are not sure of the type of power supply in your home, consult your dealer or local power company.
8. Do not allow anything to rest on the power cord. Do not install this product where the cord may have anyone walking on it.
9. Never push objects of any kind into this product through slots in the base or handset as they may touch dangerous voltage points or short out parts that could result in a risk of fire or electric shock. Never spill liquid of any kind on the product.
10. To reduce the risk of electric shock, do not disassemble this product, but take it to an authorized service facility. Opening or removing parts of the base or handset other than specified access doors may expose you to dangerous voltages or other risks. Incorrect reassembling can cause electric shock when the product is subsequently used.
11. Do not overload wall outlets and extension cords as this can result in the risk of fire or electric shock.
12. Unplug this product from the wall outlet and refer servicing to an authorized service facility under the following conditions:
  - A. When the power supply cord or plug is damaged or frayed.
  - B. If liquid has been spilled onto the product.
  - C. If the product has been exposed to rain or water.
  - D. If the product does not operate normally by following the operating instructions. Adjust only those controls that are covered by the operating instructions, as improper adjustment of other controls may result in damage and often requires extensive work by an authorized technician to restore the product to normal operation.
  - E. If the product has been dropped and the base and/or handset has been damaged.
  - F. If the product exhibits a distinct change in performance.
13. Avoid using a telephone (other than cordless) during an electrical storm. There is a remote risk of electric shock from lightning.
14. Do not use the telephone to report a gas leak in the vicinity of the leak.
15. Only put the handset of your telephone next to your ear when it is in normal talk.

## FCC, ACTA and IC Regulations

---

### FCC Part 15

This equipment has been tested and found to comply with the requirements for a Class B digital device under Part 15 of the Federal Communications Commission (FCC) rules. These requirements are intended to provide reasonable protection against harmful interference in a residential installation. This equipment generates, uses and can radiate radio frequency energy and, if not installed and used in accordance with the instructions, may cause harmful interference to radio communications. However, there is no guarantee that interference will not occur in a particular installation. If this equipment does cause harmful interference to radio or television reception, which can be determined by turning the equipment off and on, the user is encouraged to try to correct the interference by one or more of the following measures:

- Reorient or relocate the receiving antenna.
- Increase the separation between the equipment and receiver.
- Connect the equipment into an outlet on a circuit different from that to which the receiver is connected.
- Consult the dealer or an experienced radio/TV technician for help.



# FCC, ACTA and IC Regulations

---

Changes or modifications to this equipment not expressly approved by the party responsible for compliance could void the user's authority to operate the equipment.

To ensure safety of users, the FCC has established criteria for the amount of radio frequency energy that can be safely absorbed by a user or bystander according to the intended usage of the product. This product has been tested and found to comply with the FCC criteria. The handset may be safely held against the ear of the user. The base unit shall be installed and used such that parts of the user's body other than the hands are maintained at a distance of approximately 20 cm (8 inches) or more.

## FCC Part 68 and ACTA

This equipment complies with Part 68 of the FCC rules and with technical requirements adopted by the Administrative Council for Terminal Attachments (ACTA). The label on the back or bottom of this equipment contains, among other things, a product identifier in the format US: AAAEQ##TXXXX. This identifier must be provided to your local telephone company upon request.

The plug and jack used to connect this equipment to premises wiring and the telephone network must comply with applicable Part 68 rules and technical requirements adopted by ACTA. A compliant telephone cord and modular plug is provided with this product. It is designed to be connected to a compatible modular jack that is also compliant. An RJ11 jack should normally be used for connecting to a single line and an RJ14 jack for two lines. See Installation Instructions in the user's manual.

The Ringer Equivalence Number (REN) is used to determine how many devices you may connect to your telephone line and still have them ring when you are called. The REN for this product is encoded as the 6th and 7th characters following the US: in the product identifier (e.g., if ## is 03, the REN is 0.3). In most, but not all areas, the sum of all RENs should be five (5.0) or less. For more information, please contact your local telephone company.

This equipment may not be used with Party Lines. If you have specially wired alarm dialing equipment connected to your telephone line, ensure the connection of this equipment does not disable your alarm equipment. If you have questions about what will disable alarm equipment, consult your telephone company or a qualified installer.

If this equipment is malfunctioning, it must be unplugged from the modular jack until the problem has been corrected. Repairs to this telephone equipment can only be made by the manufacturer or its authorized agents. For repair procedures, follow the instructions outlined under the Limited Warranty.

If this equipment is causing harm to the telephone network, the telephone company may temporarily discontinue your telephone service. The telephone company is required to notify you before interrupting service. If advance notice is not practical, you will be notified as soon as possible. You will be given the opportunity to correct the problem and the telephone company is required to inform you of your right to file a complaint with the FCC. Your telephone company may make changes in its facilities, equipment, operation, or procedures that could affect the proper functioning of this product. The telephone company is required to notify you if such changes are planned.

If this product is equipped with a corded or cordless handset, it is hearing aid compatible.

If this product has memory dialing locations, you may choose to store emergency telephone numbers (e.g., police, fire, medical) in these locations. If you do store or test emergency numbers, please:

- Remain on the line and briefly explain the reason for the call before hanging up.
- Perform such activities in off-peak hours, such as early morning or late evening.

## Industry Canada

This equipment complies with regulations RSS210 and CS-03 of Industry Canada. Operation is subject to the following two conditions: (1) this device may not cause interference, and (2) this

# FCC, ACTA and IC Regulations

---

device must accept any interference, including interference that may cause undesired operation of the device.

The term "IC: " before the certification/registration number only signifies that the Industry Canada technical specifications were met.

The Ringer Equivalence Number (REN) for this terminal equipment is 0.1. The REN is an indication of the maximum number of devices allowed to be connected to a telephone interface. The termination on an interface may consist of any combination of devices subject only to the requirement that the sum of the RENs of all the devices does not exceed five.

## The RBRC Seal



The **RBRC** Seal on the nickel-cadmium battery indicates that VTech Communications, Inc. is voluntarily participating in an industry program to collect and recycle these batteries at the end of their useful lives, when taken out of service within the United States and Canada.

The **RBRC** program provides a convenient alternative to placing used nickel-cadmium batteries into the trash or municipal waste, which may be illegal in your area.

VTech's participation in **RBRC** makes it easy for you to drop off the spent battery at local retailers participating in the **RBRC** program or at authorized VTech product service centers. Please call 1-800-8-BATTERY™ for information on Ni-Cd battery recycling and disposal bans/restrictions in your area. VTech's involvement in this program is part of its commitment to protecting our

environment and conserving natural resources.

**RBRC** is a registered trademark of Rechargeable Battery Recycling Corporation.

# Technical Specifications

---

Enhanced 2.4GHz Technology—Your phone operates on a dual band transmission that combines the best of 2.4GHz and 900MHz technologies, providing enhanced performance over standard cordless telephones.

Frequency Control	Crystal controlled PLL synthesizer
Transmit Frequency	Base: 2410.2–2418.9 MHz Handset: 912.75–917.10 MHz
Receive Frequency	Base: 912.75–917.10 MHz Handset: 2410.2–2418.9 MHz
Channels	30
Nominal Effective Range	Maximum power allowed FCC and IC. Actual operating range may vary according to environmental conditions at the time of use.
Size	Handset: 185.5mm X 53.4mm X 41mm Base: 122.5mm X 107.5mm X 88.6mm Charger: 81mm X 76mm X 52mm
Weight	Handset: 117.6 grams Base: 125 grams Charger: 39.2 grams
Power Requirements	Handset: 3.6V 300mAH Ni-Cd Battery Base: AC 9V @ 250mA CHARGER: DC 6V @200mA
Memory	Speed Dial: 9 Memory locations, 24 digits per location Directory: 10Memory locations, 24 digits per location CID: 30 Memory locations

---

## **VTECH TELECOMMUNICATIONS LTD.**

**A member of THE VTECH GROUP OF COMPANIES.**

**Distributed in the U.S.A. by VTech Communications, Inc.  
Beaverton, Oregon.**

**Distributed in Canada by VTech Communications Canada Ltd.,  
Richmond, B.C. V6X 1Z9.**

**Copyright ©2005 for VTECH TELECOMMUNICATIONS LTD.  
Printed in China.**