



at&t



Proud Sponsor

User's manual

**TL32100/TL32200/TL32300
DECT 6.0 cordless telephone/
answering system with
caller ID/call waiting**



Congratulations

on purchasing your new AT&T product. Before using this AT&T product, please read **Important safety information** on page 77 of this user's manual. Please thoroughly read the user's manual for all the feature operations and troubleshooting information you need to install and operate your new AT&T product. You can also visit our website at **www.telephones.att.com** or call **1 (800) 222-3111**. In Canada, dial **1 (866) 288-4268**.

Model #: TL32100 (one-handset system)
 TL32200 (two-handset system)
 TL32300 (three-handset system)

Type: DECT 6.0 cordless telephone with answering system

Serial #: _____

Purchase date: _____

Place of purchase: _____

Both the model and serial number of your AT&T product can be found on the bottom of the telephone base.



Telephones identified with this logo have reduced noise and interference when used with most T-coil equipped hearing aids and cochlear implants. The TIA-1083 Compliant Logo is a trademark of the Telecommunications Industry Association. Used under license.



The ENERGY STAR® program (www.energystar.gov) recognizes and encourages the use of products that save energy and help protect our environment. We are proud to mark this product with the ENERGY STAR® label indicating it meets the latest energy efficiency guidelines.

Audio assist™ is a trademark of Advanced American Telephones.

© 2010 Advanced American Telephones. All Rights Reserved. AT&T and the AT&T logo are trademarks of AT&T Intellectual Property licensed to Advanced American Telephones, San Antonio, TX 78219. Printed in China.

Parts checklist

Your telephone package contains the following items. Save your sales receipt and original packaging in the event warranty service is necessary.



Quick start guide



User's manual



Telephone base



Power adapter for telephone base



Cordless handset
(1 for TL32100)
(2 for TL32200)
(3 for TL32300)



Charger for cordless handset with power adapter installed
(1 for TL32200)
(2 for TL32300)

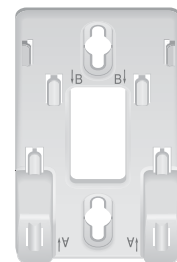

Wall mount bracket



Battery for cordless handset
(1 for TL32100)
(2 for TL32200)
(3 for TL32300)



Battery compartment cover
(1 for TL32100)
(2 for TL32200)
(3 for TL32300)

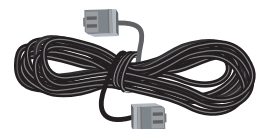

Telephone line cord

User's manual

TL32100/TL32200/TL32300 DECT 6.0 cordless telephone/ answering system with caller ID/call waiting



Table of contents

Getting started

Quick reference guide	2
Telephone base and charger installation.....	5
Battery installation and charging.....	6
Battery installation.....	6
Battery charging.....	7
Wall mount installation.....	8
Tabletop to wall mount installation.....	8
Wall mount to tabletop installation	10

Telephone settings

Menu overview.....	11
Handset settings.....	12
Ringer volume.....	12
Ringer tone.....	12
LCD language.....	12
Voicemail waiting (visual message waiting) indicator	13
Clear voicemail indication	13
Key tone.....	14
Set date/time.....	14
CID time synchronization.....	15
Home area code	15
Dial mode.....	16
Website	16
Answering system settings.....	17
Announcement.....	17
Answering mode.....	18
Call screening setup.....	19
Number of rings.....	20
Remote access code.....	20
Message alert tone.....	21
Recording time	21
Telephone base ringer volume.....	22

Telephone operation

Making, answering and ending a call.....	23
Making a call.....	23
Temporary ringer silencing.....	23
Answering a call.....	24
Speakerphone	24
Ending a call.....	24
Redial.....	25
To review numbers in the redial list.....	25
To call a number from the redial list.....	25
To copy a number from the redial list to the directory	25
To delete a number in the redial list	26
Options while on calls.....	27
Volume control.....	27
Mute.....	27
Flash/call waiting	27
Equalizer	28
Audio assist.....	28
Temporary tone dialing.....	28
Chain dialing.....	29
Join a call in process	30
Handset locator.....	31
Intercom.....	32
To make and answer an intercom call.....	32
To answer an incoming call during an intercom call.....	33
Call transfer using intercom	34
Directory	
Directory overview.....	36
Shared directory	36
Directory memory capacity.....	36
Exiting the directory	36
Speed dial overview.....	36

Create directory entries.....	37	Temporarily turning off the message alert tone.....	52
To create a new directory entry.....	37	Message playback.....	53
To add a predialed telephone number to the directory.....	38	To listen to messages.....	53
Reviewing the directory.....	39	Options during playback.....	54
To review directory entries.....	39	To delete all old messages.....	55
To search by name.....	39	Recording and playing memos.....	56
Dialing, deleting and editing a directory entry.....	41	To record a memo.....	56
To dial a directory number.....	41	To play back memos.....	56
To delete a directory entry.....	41	Message window displays.....	57
To edit a directory entry.....	41	Remote access.....	58
Speed dial locations.....	42	Appendix	
To assign or reassign a directory entry to a speed dial location.....	42	Adding and registering a handset.....	60
To clear a speed dial location.....	42	Deregistering all handsets.....	61
To dial a speed dial number.....	43	Screen icons, indicator lights and alert tones.....	62
Caller ID		Screen icons.....	62
About caller ID.....	44	Handset indicator lights.....	63
Information about caller ID with call waiting.....	44	Telephone base indicator lights.....	63
About home area code.....	44	Handset alert tones.....	64
Caller ID history.....	45	Telephone base alert tones.....	64
How caller ID history (call log) works.....	45	Handset display screen messages.....	65
Memory match.....	45	Troubleshooting.....	67
Caller ID operation.....	46	Maintenance.....	76
Missed (new) calls indicator.....	46	Important safety information.....	77
Reasons for missing caller ID information.....	46	Safety information.....	77
To review the caller ID history.....	47	Especially about cordless telephones.....	77
To view the dialing options.....	47	Precautions for users of implanted cardiac pacemakers.....	78
To dial a caller ID history number.....	48	Pacemaker patients.....	78
To delete caller ID history entries.....	48	Especially about telephone answering systems.....	78
Saving a caller ID history entry in the directory.....	49	FCC Part 68 and ACTA.....	79
Answering system		FCC Part 15.....	80
Answering system and voicemail.....	50	Limited warranty.....	81
About answering system and voicemail....	50	Technical specifications.....	83
Answering system new message indication.....	50	DECT 6.0 digital technology.....	83
Answering system overview.....	51	Telephone operating range.....	83
Voice prompts.....	51	Index.....	84
Message capacity.....	51	Remote access wallet card.....	86
Call screening.....	51		
Call intercept.....	52		

You must install and charge the battery before using the cordless handset.



See pages 6 and 7 for easy instructions.

Install the telephone base close to a telephone wall jack and an electrical outlet not controlled by a wall switch. The telephone base can be placed on a flat surface or vertically mounted on the wall (page 8). For optimum range and better reception, place the telephone base in a central and open location.

If you subscribe to high-speed Internet service (digital subscriber line - DSL) through your telephone line, you must install a DSL filter between the telephone line cord and the telephone wall jack (page 5). The filter prevents noise and caller ID problems caused by DSL interference. Please contact your DSL service provider for more information about DSL filters.

Your product may be shipped with a protective sticker covering the handset or telephone base display - remove it before use.

For customer service or product information, visit our website at **www.telephones.att.com** or call **1 (800) 222-3111**. In Canada, dial **1 (866) 288-4268**.

Avoid placing the telephone base too close to:

- Communication devices such as: television sets, VCRs, or other cordless telephones.
- Excessive heat sources.
- Noise sources such as a window with traffic outside, motors, microwave ovens, refrigerators, or fluorescent lighting.
- Excessive dust sources such as a workshop or garage.
- Excessive moisture.
- Extremely low temperature.
- Mechanical vibration or shock such as on top of the washing machine or work bench.

Quick reference guide

REDIAL/PAUSE

Press repeatedly to view the last 20 numbers dialed (page 25).

While entering numbers, press and hold to insert a dialing pause (pages 23 and 37).

PHONE/FLASH

Press to make or answer a call (pages 23 and 24).

During a call, press to answer an incoming call when you receive a call waiting alert (page 27).

1

While reviewing a caller ID history entry, press repeatedly to add or remove 1 in front of the telephone number before dialing or saving it in the directory (page 47).

0

While entering names in the directory, press to add a space (page 37).

MUTE/REMOVE

During a call, press to mute the microphone (page 27).

While predialing, press to delete digits (page 23).

While reviewing the redial list, directory, speed dial list or caller ID history, press to delete an individual entry (pages 26, 41, 42 and 48).

TOPE*

During a call, press to send touch-tone signals (page 28).

SPEAKER

Press to turn on the handset speakerphone, press again to resume normal handset use (pages 17, 24 and 54).

AUDIO ASSIST™

During a call (normal handset use), press to make some voices to sound louder and clearer (page 28).

▲DIR/VOLUME

Press to scroll up while in menus (page 11).

Press to increase the listening volume (pages 17, 27 and 54).

Press to show directory entries when the handset is not in use (page 39).

While entering names or numbers in the directory, press to move the cursor to the right (page 37).

MENU/SELECT

Press to display the menu (page 11).

Once in the menu, press to select an item or save an entry or setting (page 11).

OFF/CLEAR

During a call, press to hang up (page 24).

While using menus, press to cancel an operation, back up to the previous menu, or exit the menu display (page 11).

Press and hold while the handset is not in use to erase the missed calls indicator (page 46).

▼CID/VOLUME

Press to scroll down while in menus (page 11).

Press to decrease the listening volume (pages 17, 27 and 54).

Press to show the caller ID history when the handset is not in use (page 47).

While entering names or numbers in the directory, press to move the cursor to the left (page 37).

#

When reviewing a caller ID history entry, press repeatedly to view the dialing options (page 47).



Quick reference guide

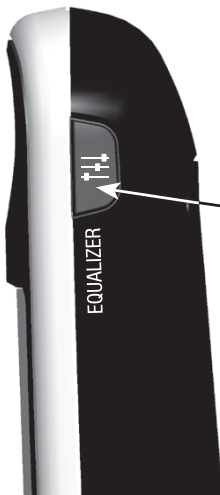

EQUALIZER

During an outside call, intercom call, message or announcement playback, press to change the quality of the audio to best suit your hearing (page 28).

The > symbol indicates the feature to select.

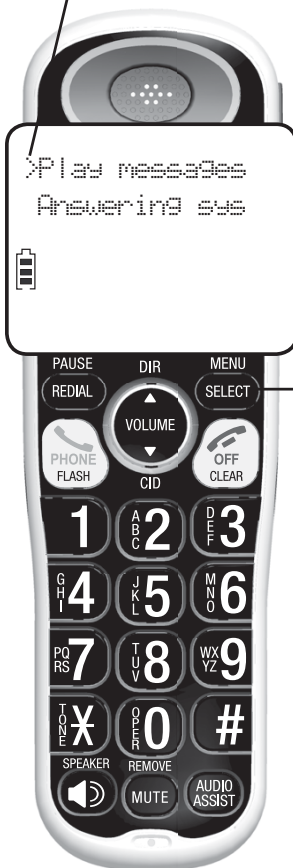

Main menu

- Play messages (page 53)
- Answering sys (page 17)
- Directory (page 39)
- Call log (page 47))
- Intercom (appears if you have more than one handset, page 32)
- Ringers (page 12)
- Settings (pages 12-16)
- Website (page 16)

Using menus

- Press **MENU/SELECT** to enter the main menu.
- Press **▲DIR** or **▼CID** to scroll through menu items.
- Press **MENU/SELECT** to select or modify an item.
- Press **☎OFF/CLEAR** to cancel an operation, back up to the previous menu, or exit the menu display.

Quick reference guide



HANDSET LOCATOR

Press to make handsets beep so you can locate them (page 31).

Message window

Displays the number of messages. During playback, displays the message number currently playing (page 57).

▶/■ PLAY/STOP

Press to start or stop message playback (page 53).

While call screening, press to temporarily turn the call screening on or off (page 51).

◀ REPEAT

After the answering system plays the day and time the current message was received, press to repeat the message currently playing (page 54).

While the answering system is playing the day and time the current message was received, press to listen to the previous message (page 54).

▶▶ SKIP

Press to skip a message (page 54).

⏻ ANS ON

Press to turn the built-in answering system on or off (page 18).

SLOW

Press to slow message playback (page 54).

▲▼ VOLUME

While the telephone is not in use, press to adjust the telephone base ringer volume (page 22).

During call screening or message playback, press to adjust the listening volume (pages 51 and 54).



✕ DELETE

Press to delete the message currently playing (page 54).
Press twice to delete all old messages when the telephone is not in use (page 55).

Telephone base and charger installation

Install the telephone base and charger as shown below. If you subscribe to high-speed Internet service (digital subscriber line - DSL) through your telephone line, you must install a DSL filter between the telephone line cord and the telephone wall jack. The filter prevents noise and caller ID problems caused by DSL interference. Please contact your DSL service provider for more information about DSL filters.

The telephone base comes ready for tabletop use. If you want to mount your telephone on a wall, refer to **Wall mount installation** on page 8 for details.

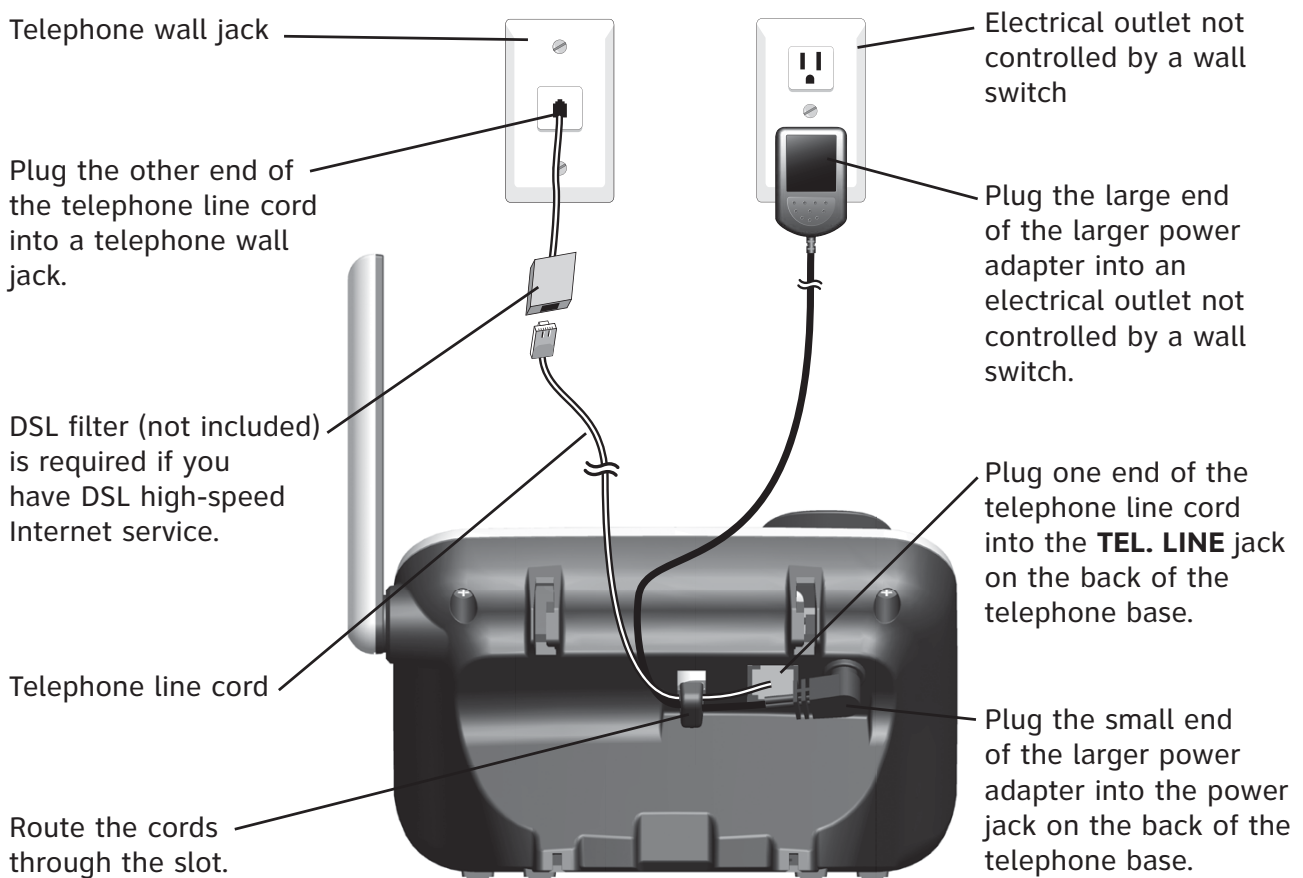

Plug the large end of the smaller power adapter into an electrical outlet not controlled by a wall switch.

Route the cord through the slot.

Ensure the small end of the smaller power adapter is plugged into the power jack on the back of the charger.

Raise the antenna.



IMPORTANT INFORMATION:

Use only the power adapters provided with this product. To obtain a replacement, visit our website at www.telephones.att.com or call **1 (800) 222-3111**. In Canada, dial **1 (866) 288-4268**.

Battery installation and charging

Battery installation

Install the battery as shown below.

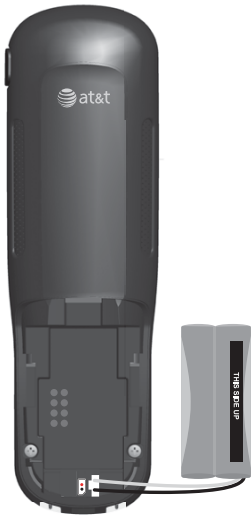

1. Plug the battery connector securely into the socket inside the handset battery compartment, matching the color-coded label.



2. Insert the supplied battery with the label **THIS SIDE UP** facing up as indicated.



3. Align the cover flat against the battery compartment, then slide it upwards until it clicks into place.



4. Charge the handset by placing it face up in the telephone base or charger. The **CHARGE** light is on when charging.



To replace the battery, press the tab and slide the battery compartment cover downwards. Lift out the old battery and disconnect it from the handset. Follow the instructions above to install and charge the new battery.

IMPORTANT INFORMATION:

Use only the supplied rechargeable battery or replacement battery (model BT166342). To order, visit our website at www.telephones.att.com, or call **1 (800) 222-3111**. In Canada, dial **1 (866) 288-4268**.

Battery installation and charging

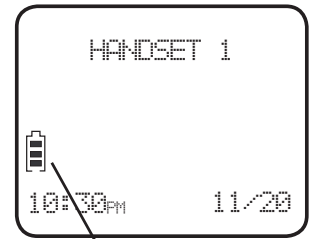

Battery charging

Once you have installed the battery, the screen indicates the battery status (see the table below). If necessary, place the handset in the telephone base or charger to charge the battery. For best performance, keep the handset in the telephone base or charger when not in use. The battery is fully charged after 16 hours of continuous charging. See **Technical specifications** on page 83 for battery operating times.



Battery status icon

If the screen is blank, you need to charge the handset without interruption for at least 30 minutes to give the handset enough charge to use the telephone for a short time. The screen shows **LOW BATTERY** until you have charged the battery without interruption for at least 30 minutes. The following table summarizes the battery charge indicators and actions to take.

Battery indicators	Battery status	Action
The screen is blank or shows PLACE IN CHARGER.	Battery has no or very little charge. The handset cannot be used.	Charge without interruption until the screen shows LOW BATTERY or HANDSET X (at least 30 minutes).
The screen shows LOW BATTERY and  flashes.	Battery has enough charge to be used for a short time.	Charge without interruption until the screen shows HANDSET X (at least 30 minutes).
The screen shows HANDSET X and the battery icon shows  or  .	Battery is charged.	To keep the battery charged, place it in the telephone base or charger when not in use.

NOTES:

- If you are on a call in low battery mode, you hear four short beeps every 50 seconds.
- When you place the handset in the telephone base or charger, if no battery is installed in that handset, the **CHARGE** light is off and the screen shows **No battery**. Follow the instructions in **Battery installation** on page 6 to install the battery.

Wall mount installation

The telephone base comes ready for tabletop use. If you want to mount your telephone on a wall, use the provided wall mount bracket to connect with a standard dual-stud telephone wall mounting plate. If you do not have this mounting plate, you can purchase one from many hardware or consumer electronics retailers. Professional assistance may be required to install the mounting plate.

Tabletop to wall mount installation

To change the telephone base from the tabletop installation to wall mount installation, make sure you first unplug the power adapter from the electrical outlet and unplug the telephone line cord from the telephone wall jack.

1. Plug one end of the telephone line cord into the **TEL. LINE** jack on the back of the telephone base. Plug the small end of the larger power adapter into the power jack on the back of the telephone base.
2. Position the telephone base as shown below. Insert the extended tabs of the wall mount bracket into the slots on the back of the telephone base. Push the telephone base down until it clicks securely in place.
3. Route the telephone line cord through the wall mount bracket hole. Route the power cord out of the back of the telephone.

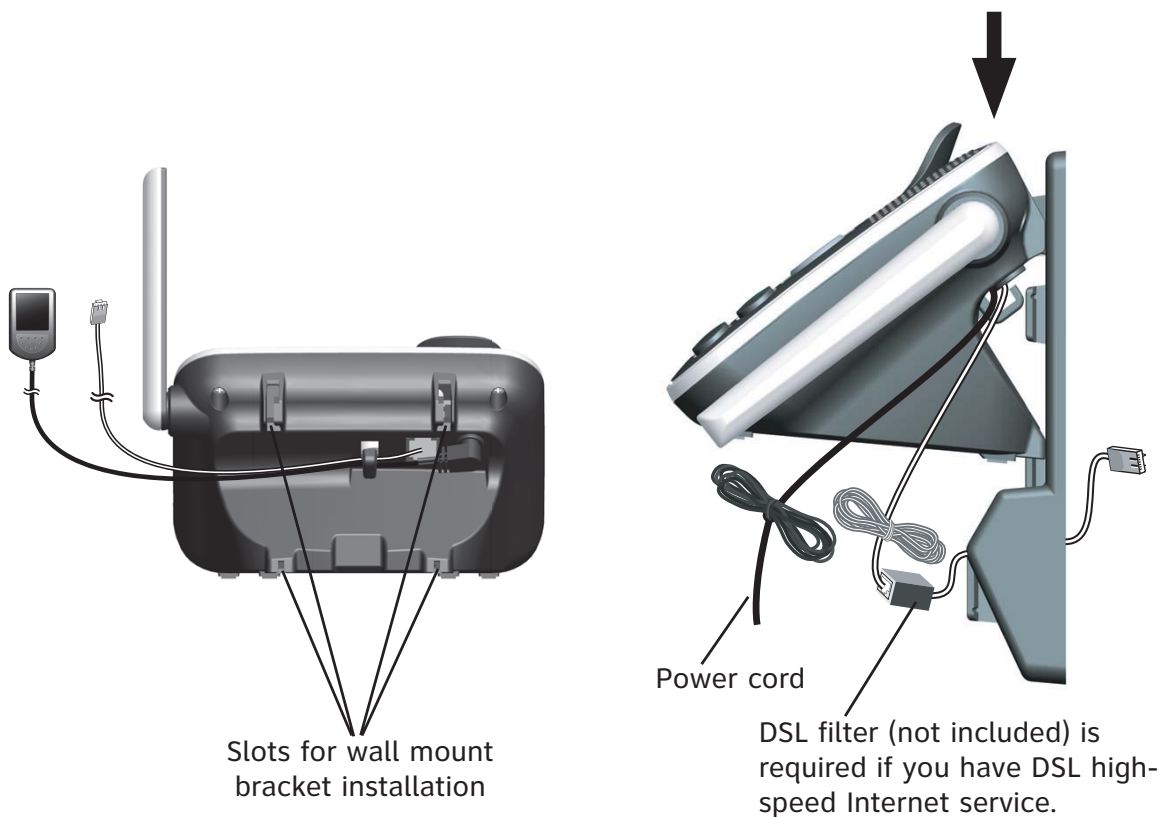

Wall mount installation

4. Plug the other end of the telephone line cord into the telephone wall jack. Plug the large end of the larger power adapter into an electrical outlet not controlled by a wall switch.

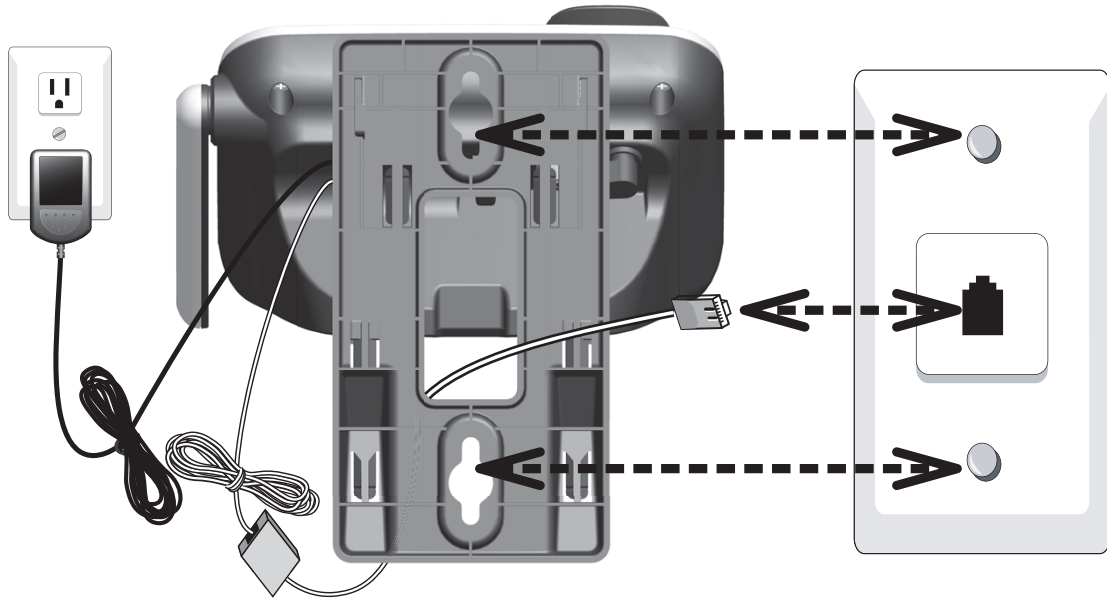

5. Align the holes on the wall mount bracket with the mounting studs of the wall mounting plate and slide the bracket down until it locks securely. Bundle the telephone line cord and power adapter cord neatly with twist ties.

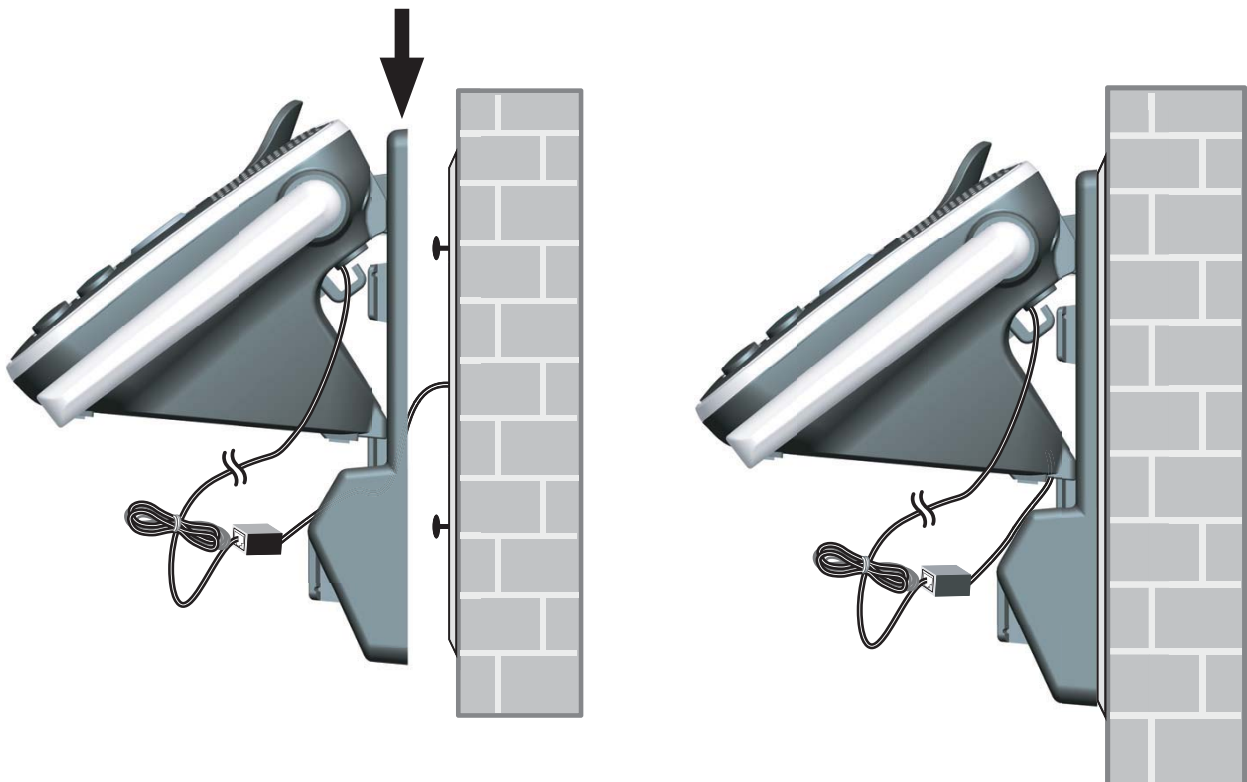

Wall mount installation

Wall mount to tabletop installation

To change the telephone base from the wall mount installation to tabletop installation, follow the steps below.

1. Unplug the large end of the larger power adapter from the electrical outlet.
2. If the telephone line cord and power adapter cord are bundled, untie them first. Slide the wall mount bracket up and remove it from the wall mounting plate. Unplug the end of the telephone line cord from the telephone wall jack.

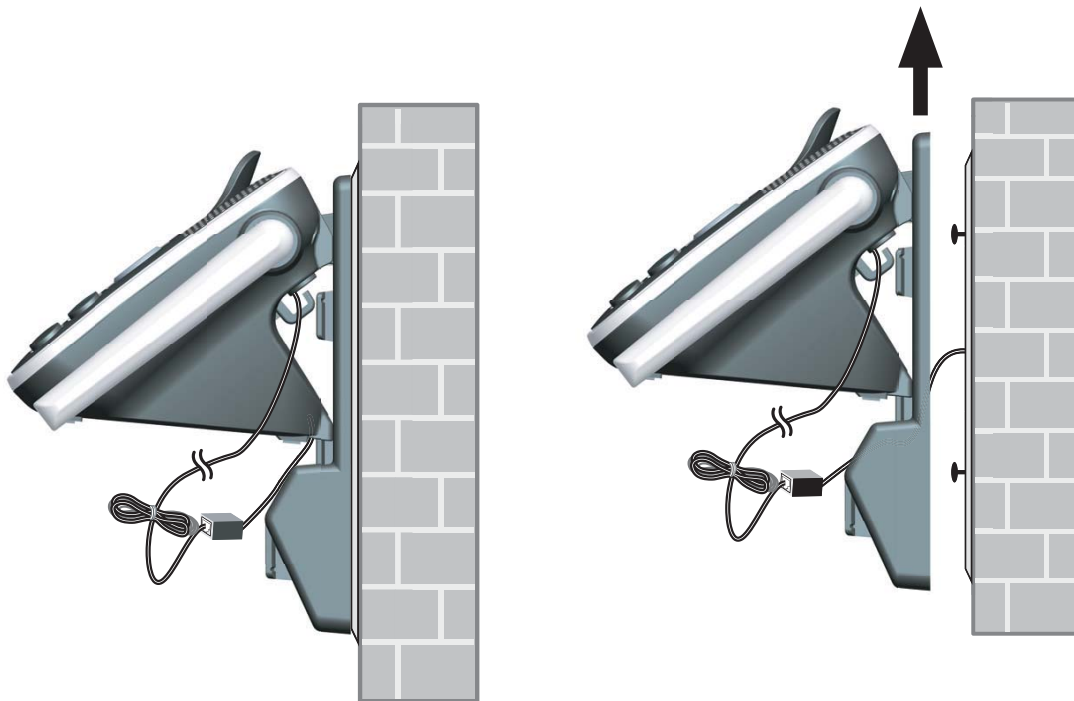

3. Lift the telephone base up to detach it from the wall mount bracket.



4. Refer to **Telephone base and charger installation** on page 5 to install the telephone base.

Menu overview

Use the menu to change the telephone settings.

1. Press **MENU/SELECT** in idle mode (when the handset is not in use) to enter the main menu.
2. Press **▲DIR** or **▼CID** until the **>** is next to the feature you want to select.
3. Press **MENU/SELECT** to select or save the indicated item.

-OR-

Press **OFF/CLEAR** to cancel an operation, back up to the previous menu or exit the menu display.

-OR-

Press and hold **OFF/CLEAR** to cancel an operation and return to idle mode.

-OR-

If no key is pressed within 30 seconds, the handset automatically cancels an operation and returns to idle mode.

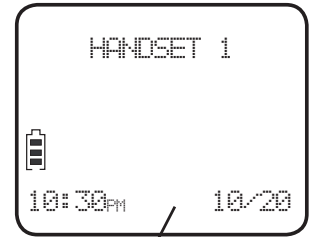

The handset is in idle mode.

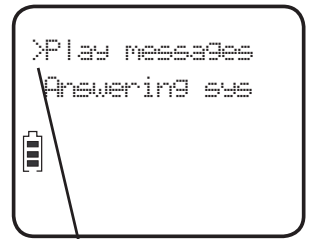

The **>** symbol indicates the feature to select.

iNOTES:

- Only when you have more than one handset, the menu item **Intercom** appears in the main menu. To register a handset, refer to **Adding and registering a handset** on page 60.
- The menu items **Play messages**, **Answering sys**, **Directory**, **Call log**, **Clr voicemail**, **Set date/time**, **Home area code** and **Dial mode** are shared by all handsets. Any changes made to these menu items on any one handset apply to all.

Menu structure

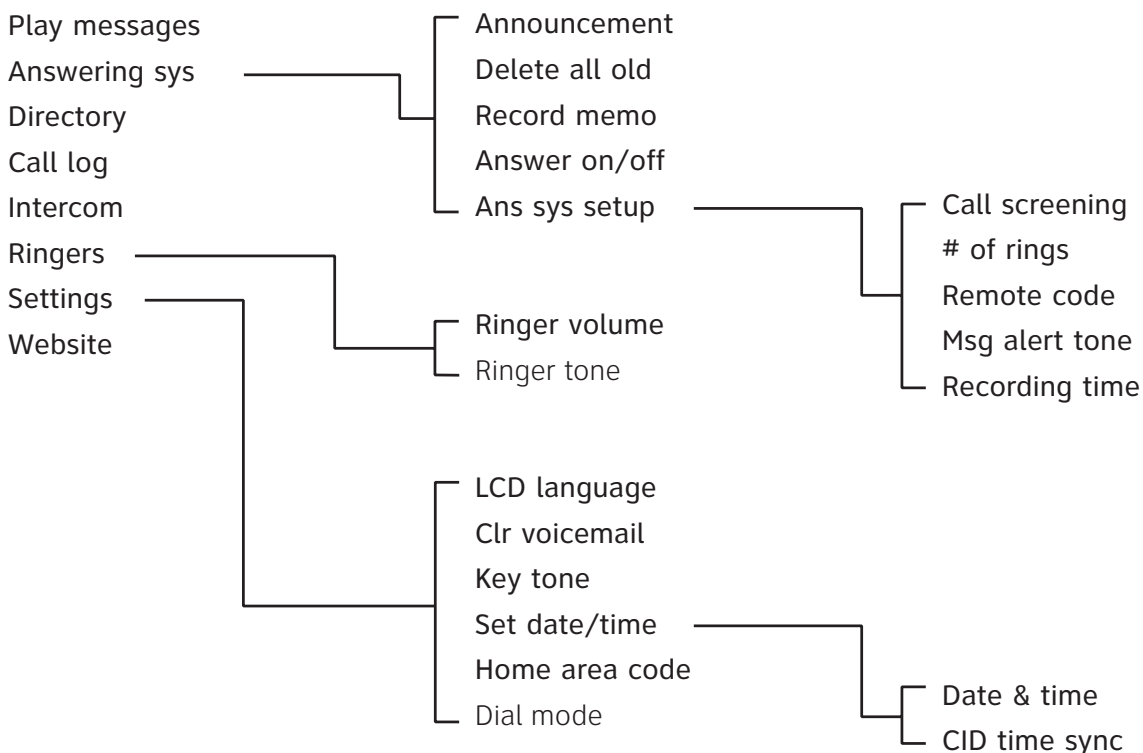

Handset settings

Ringer volume

You can set the handset ringer volume level (1-6), or turn the ringer off. When the ringer is off,  appears on the handset screen.

1. Press **MENU/SELECT** in idle mode.
2. Press **▲DIR** or **▼CID** to scroll to **>Ringers**. Press **MENU/SELECT**.
3. Press **MENU/SELECT** to select **>Ringer volume**.
4. Press **▲DIR** or **▼CID** to sample each volume level.
5. Press **MENU/SELECT** to save your preference.

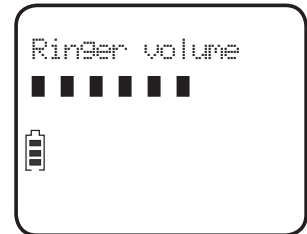

NOTES:

- Changing the handset ringer volume does not affect the base ringer volume. For more information on the base ringer volume, see **Telephone base ringer volume** on page 22.
- The handset ringer volume also determines the ringer volume of intercom calls (see **Intercom** on page 32).
- If the handset ringer volume is set to off, that handset ringer is silenced for all incoming calls; however, that handset still plays the paging tone when initiating the handset locator feature (see **Handset locator** on page 31).
- While the telephone is ringing, press **OFF/CLEAR** or **MUTE/REMOVE** to silence the ringer temporarily on that handset only (see **Temporary ringer silencing** on page 23).

Ringer tone

You can choose one of 10 ringer tones for the handset.

1. Follow steps 1 and 2 in **Ringer volume** on this page.
2. Press **▲DIR** or **▼CID** to scroll to **>Ringer tone**, then press **MENU/SELECT**.
3. Press **▲DIR** or **▼CID** to sample each ringer tone.
4. Press **MENU/SELECT** to save your preference.

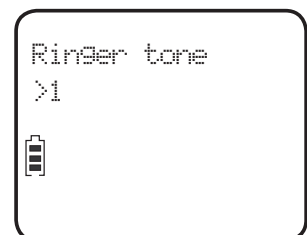

 **NOTE:** If you turn off the handset ringer volume, you will not hear ringer tone samples.

LCD language

You can select the language used for all screen displays.

1. Press **MENU/SELECT** in idle mode.
2. Press **▲DIR** or **▼CID** to scroll to **>Settings**.
3. Press **MENU/SELECT** twice to select **>LCD language**.
4. Press **▲DIR** or **▼CID** to select **English, Français** or **Español**.
5. Press **MENU/SELECT** to save your preference.

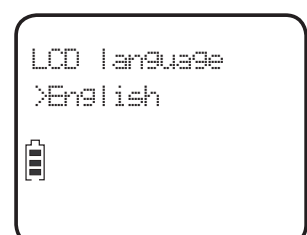

Handset settings

Voicemail waiting (visual message waiting) indicator

If you subscribe to a voicemail service offered by your telephone service provider, this feature provides a visual indication when you have new voicemail messages.

New voicemail and  appear on the handset screen.



NOTES:

- Your telephone service provider might alert you to new voicemail messages with a stutter (broken) dial tone. Contact your telephone service provider for more details.
- This feature does not indicate new messages recorded on your telephone's built-in answering system.
- For more information about the difference between your answering system and voicemail, see **About answering system and voicemail** on page 50.

Clear voicemail indication

Use this feature when the telephone indicates there is new voicemail but there is none. This may occur, for example, when you have accessed your voicemail while away from home. This feature only turns off the displayed **New voicemail** message and  icon; it does not delete your voicemail messages. As long as you have new voicemail messages, your telephone service provider continues to send the signal to turn on the indicator.

To manually turn off the new voicemail indicator:

1. Press **MENU/SELECT** when in idle mode.
 2. Press **▲DIR** or **▼CID** to scroll to **>Settings**, then press **MENU/SELECT**.
 3. Press **▲DIR** or **▼CID** to scroll to **>Clr voicemail**, then press **MENU/SELECT**. The screen shows **TURN OFF INDICATOR?**
 4. Press **MENU/SELECT** to turn the voicemail indication off. A confirmation tone sounds.
- OR-**
Press **☎OFF/CLEAR** to cancel the procedure.



 **NOTE:** For information about using your voicemail service, contact your telephone service provider for assistance.

Handset settings

Key tone

The handset is programmed to beep with each key press. You can turn **Key tone** off, so there are no beeps when you press keys.

1. Press **MENU/SELECT** in idle mode.
2. Press **▲DIR** or **▼CID** to scroll to **>Settings**, then press **MENU/SELECT**.
3. Press **▲DIR** or **▼CID** to scroll to **>Key tone**, then press **MENU/SELECT**.
4. Press **▲DIR** or **▼CID** to select **On** or **Off**.
5. Press **MENU/SELECT** to save your preference.

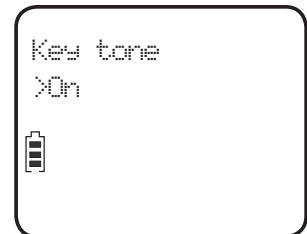

Set date/time

The answering system announces the day of the week and time of each message received prior to playing it. If **CID time sync** is **On** (see **CID time synchronization** on page 15) and you subscribe to caller ID service, the day, month and time are set automatically with each incoming call (see **About caller ID** on page 44). However, the year must be set so that the day of the week can be calculated from the caller ID information.

Follow the steps below to set the month, day, year and time.

1. Follow steps 1 and 2 in **Key tone** on this page.
2. Press **▲DIR** or **▼CID** to scroll to **>Set date/time**, then press **MENU/SELECT**.
3. Press **MENU/SELECT** to choose **>Date & time**.
4. Use the dial pad keys (0-9) to enter the two-digit number (01-12) for the month.
5. Use the dial pad keys (0-9) to enter the two-digit number (01-31) for the day.
6. Use the dial pad keys (0-9) to enter the two-digit number (00-99) for the year. Press **MENU/SELECT**.
7. Use the dial pad keys (0-9) to enter the two-digit number (01-12) for the hour.
8. Use the dial pad keys (0-9) to enter the two-digit number (00-59) for the minute.
9. Press **▲DIR** or **▼CID** to choose **AM** or **PM**. Press **MENU/SELECT** to confirm. A confirmation tone sounds.

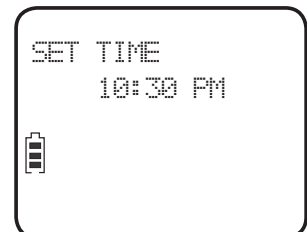
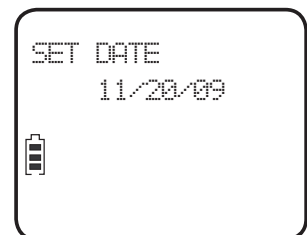

NOTE: If the date and time are not set and the handset is powered up, **SET DATE** appears on the screen to prompt you to set the date and time. You can set the date and time in this time or set them later by pressing **OFF/CLEAR** to show the idle mode.

Handset settings

CID time synchronization

CID time sync is programmed to be on. If you subscribe to caller ID service, the day, month and time are set automatically with each incoming call (see **About caller ID** on page 44). You can turn **CID time sync** off, so the handset will show the date and time as you manually set (see **Set date/time** on page 14).

1. Press **MENU/SELECT** in idle mode.
2. Press **▲DIR** or **▼CID** to scroll to **>Settings**, then press **MENU/SELECT**.
3. Press **▲DIR** or **▼CID** to scroll to **>Set date/time**, then press **MENU/SELECT**.
4. Press **▲DIR** or **▼CID** to scroll to **>CID time sync**, then press **MENU/SELECT**.
5. Press **▲DIR** or **▼CID** to select **On** or **Off**.
6. Press **MENU/SELECT** to save your preference.

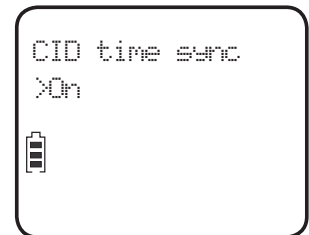

Home area code

If you dial seven digits to make a local call (no area code required), enter your area code into the telephone as the home area code. When you receive a call from within your home area code, the caller ID history only displays the seven digits of the telephone number.

This feature makes it easy for you to place a call from the caller ID history. If you dial 10 digits to make a local telephone call, do not use this home area code feature. If you do, you will not be able to place calls from your caller ID history as they have only seven digits.

1. Follow steps 1 and 2 in **CID time synchronization** on this page.
2. Press **▲DIR** or **▼CID** to scroll to **>Home area code**, then press **MENU/SELECT**.
3. Press the dial pad keys to enter your three-digit area code. Press **MUTE/REMOVE** to delete digits while entering.
4. Press **MENU/SELECT** to save the setting.

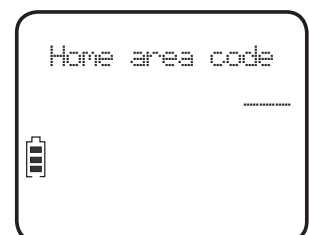

i NOTE: If, in the future, your telephone service provider requires you to dial 10 digits to make a local call (area code + telephone number), you will need to delete your home area code. While the home area code displaying in step 4 above, press and hold **MUTE/REMOVE**. The home area code is now restored to its default setting of _ _ _ (empty).

Handset settings

Dial mode

The dial mode is preset to tone dialing. If you have pulse (rotary) service, you must change the dial mode to pulse dialing before using the telephone.

1. Press **MENU/SELECT** in idle mode.
2. Press **▲DIR** or **▼CID** to scroll to **>Settings**, then press **MENU/SELECT**.
3. Press **▲DIR** or **▼CID** to scroll to **>Dial mode**, then press **MENU/SELECT**.
4. Press **▲DIR** or **▼CID** to select **Tone** or **Pulse**.
5. Press **MENU/SELECT** to save the setting.

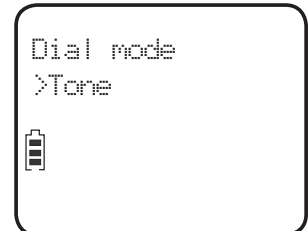

i **NOTE:** If you have dial pulse (rotary) dialing service only, refer to **Temporary tone dialing** on page 28 to temporarily switch from dial pulse to touch-tone dialing during a call.

Website

You can use this feature to view the AT&T website address on the handset.

1. Press **MENU/SELECT** in idle mode.
2. Press **▲DIR** or **▼CID** to scroll to **>Website**, then press **MENU/SELECT**.
3. The screen shows **www.telephones.att.com**.
4. Press **MENU/SELECT** to finish the view.



Answering system settings

Use the answering system menu of a system handset to turn on or off the answering system, record your announcement, activate the call screening, change the number of rings, set the remote access code, activate the message alert tone and select the recording time of incoming messages.

Announcement

The announcement is the greeting callers hear when calls are answered by the answering system.

The telephone has a default announcement, *"Hello. Please leave a message after the tone."* You can use this announcement, or record your own announcement.

You can record an announcement up to 90 seconds. The system does not record any announcement shorter than two seconds.

To play the current announcement:

1. Press **MENU/SELECT** when in idle mode.
2. Press **▲DIR** or **▼CID** to scroll to **>Answering sys**, then press **MENU/SELECT**.
3. Press **MENU/SELECT** to choose **>Announcement**. The system announces, *"To play, press 2. To record, press 7."*
4. Press **2** to play the current announcement from the speakerphone.
 - Press **▲DIR/VOLUME** to increase or press **▼CID/VOLUME** to decrease the message playback volume.
 - Press **🔊SPEAKER** to switch between speakerphone and handset earpiece.
 - Press **⊞ EQUALIZER** to select the equalizer setting to change the quality of the audio of the handset to best suit your hearing (see **Equalizer** on page 28).
 - If use the handset earpiece, press **AUDIO ASSIST** to make some voices to sound louder and clearer (see **Audio assist** on page 28). Press again to stop this feature.

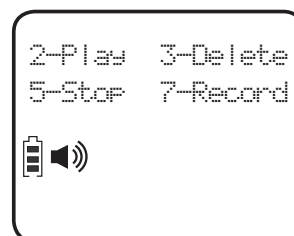

Answering system settings

To record a new announcement:

1. Press **MENU/SELECT** when in idle mode.
2. Press **▲DIR** or **▼CID** to scroll to **>Answering sys**, then press **MENU/SELECT**.
3. Press **MENU/SELECT** to choose **>Announcement**. The system announces, *"To play, press 2. To record, press 7."*
4. Press **7**. The system announces, *"Record after the tone, press 5 when you are done."*
5. Face the handset and speak towards the microphone to record your announcement.
6. Press **5** when you finish the recording. The handset plays back the recorded announcement.



i NOTE: If the answering system memory is full, when you press **7** in step 3, the answering system announces, *"Memory is full."* You must delete some messages before you can record a new announcement. Refer to **Message playback** on page 53.

To delete your announcement:

1. Follow steps 1 through 4 in **To play the current announcement** on page 17 to play the announcement.
2. Press **3** during playback to delete your recorded announcement. The system announces, *"Announcement deleted."*



If your announcement is deleted, calls are answered with the default announcement, *"Hello. Please leave a message after the tone."*

Answering mode

Unless you change it, the answering system is on and ready to record messages. If the answering system is on, the **ANS ON** icon displays on the handset screen and the **ANS ON** light on the telephone base is on. You can turn the answering system off, but if you do so, the answering system does not answer calls and record incoming messages.

Using the handset:

1. Press **MENU/SELECT** when in idle mode.
2. Press **▲DIR** or **▼CID** to scroll to **>Answering sys**, then press **MENU/SELECT**.
3. Press **▲DIR** or **▼CID** to scroll to **>Answer on/off**, then press **MENU/SELECT**.
4. Press **▲DIR** or **▼CID** to select between **On** and **Off**, then press **MENU/SELECT** to confirm the setting. A confirmation tone sounds.

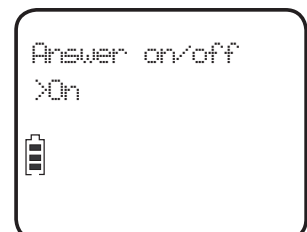

Answering system settings

Using the telephone base:

- Press **ANS ON** to turn the answering system on or off. If the answering system is turned on, it announces, *"Calls will be answered."* If the answering system is turned off, it announces, *"Calls will not be answered."*



iNOTES:

- You can turn the answering system on or off from either the handset or the telephone base, but you must use the handset to change the other answering system settings.
- During an incoming call, if the answering system is off, press **ANS ON** if you wish to immediately send the call to the answering system. If the answering system is on, press **ANS ON** if you wish to stop sending the call to the answering system.
- If the answering system is off and there is an incoming call, the system answers after 10 rings and announces to the caller, *"Please enter your remote access code."* For more information, see **Remote access** on page 58.
- If the answering system has less than three minutes of recording time left, when you turn on the answering system using the handset, it displays **Less than 3 min to record**. The telephone base announces, *"Less than three minutes to record."*
- If the memory of the answering system is full, when you turn on the answering system using the handset, it displays **Memory full**. The telephone base announces, *"Memory is full."*
- You cannot turn the answering system on or off while a handset is on a call or the telephone base is playing messages.

Call screening setup

You can choose whether incoming messages are played through the speaker on the telephone base while they are being recorded.

To change the settings:

1. Press **MENU/SELECT** when in idle mode.
2. Press **▲DIR** or **▼CID** to scroll to **>Answering sys**, then press **MENU/SELECT**.
3. Press **▲DIR** or **▼CID** to scroll to **>Ans sys setup**. Press **MENU/SELECT**.
4. Press **MENU/SELECT** to select **>Call screening**.
5. Press **▲DIR** or **▼CID** to choose between **On** and **Off**.
6. Press **MENU/SELECT** to confirm your setting. A confirmation tone sounds.

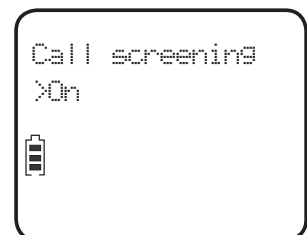

i**NOTE:** For more details about the feature call screening, see **Call screening** on page 51.

Answering system settings

Number of rings

You can set the answering system to answer an incoming call after two, four or six rings. You can also select toll saver, which is explained below. Unless you change it, the answering system answers an incoming call after four rings.

To set the number of rings:

1. Press **MENU/SELECT** when in idle mode.
2. Press **▲DIR** or **▼CID** to scroll to **>Answering sys**, then press **MENU/SELECT**.
3. Press **▲DIR** or **▼CID** to scroll to **>Ans sys setup**. Press **MENU/SELECT**.
4. Press **▲DIR** or **▼CID** to scroll to **># of rings**, then press **MENU/SELECT**.
5. Press **▲DIR** or **▼CID** to scroll and choose among **2, 4, 6** or **Toll saver**.
 - Toll saver - the answering system answers a call after two rings if you have new messages, and after four rings when there are no new messages. This feature allows you to check for new messages and avoid paying long distance charges if you are calling from out of your local area.
5. Press **MENU/SELECT** to confirm your setting. A confirmation tone sounds.

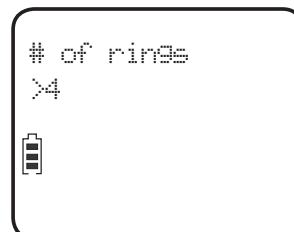

i **NOTE:** If you subscribe to a voicemail service offered through your telephone service provider, see **About answering system and voicemail** on page 50.

Remote access code

To access your answering system remotely from any touch-tone telephone, you need to enter a two-digit number (00-99). Unless you change it, the remote access code is 19.

To change the remote access code:

1. Follow steps 1 through 3 in **Number of rings** on this page.
2. Press **▲DIR** or **▼CID** to scroll to **>Remote code**, then press **MENU/SELECT**.
3. Press **▲DIR** or **▼CID** to select the remote access code, or use the dial pad keys to enter the correct number (00-99).
4. Press **MENU/SELECT** to confirm your setting. A confirmation tone sounds.

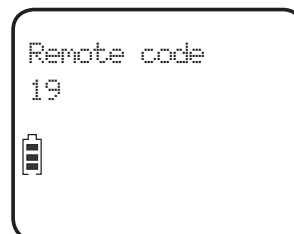

i **NOTE:** For more details about the feature remote access, refer to **Remote access** on page 58.

Answering system settings

Message alert tone

When the message alert tone is set to **On**, and there is at least one new message, the telephone base beeps every 10 seconds. Unless you change it, the message alert tone is set to off.

To change the setting:

1. Press **MENU/SELECT** when in idle mode.
2. Press **▲DIR** or **▼CID** to scroll to **>Answering sys**, then press **MENU/SELECT**.
3. Press **▲DIR** or **▼CID** to scroll to **>Ans sys setup**. Press **MENU/SELECT**.
4. Press **▲DIR** or **▼CID** to scroll to **>Msg alert tone**, then press **MENU/SELECT**.
5. Press **▲DIR** or **▼CID** to choose between **On** and **Off**.
6. Press **MENU/SELECT** to confirm your setting. A confirmation tone sounds.

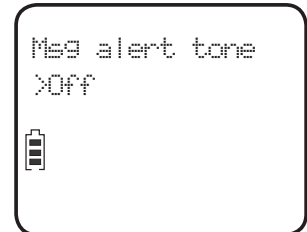

NOTES:

- The message alert tone beeps only if all the conditions below are met:
 - Answering system is on.
 - Message alert tone setting is on.
 - There are new messages.
- To temporarily turn off the message alert tone, see **Temporarily turning off the message alert tone** on page 52.

Recording time

You can select the recording time (up to one, two or three minutes) for each message (incoming message) callers can record in the answering system.

To set the recording time:

1. Follow steps 1 through 3 in **Message alert tone** on this page.
2. Press **▲DIR** or **▼CID** to scroll to **>Recording time**, then press **MENU/SELECT**.
3. Press **▲DIR** or **▼CID** to scroll and choose from **1 minute**, **2 minutes** or **3 minutes**.
4. Press **MENU/SELECT** to confirm your setting.
A confirmation tone sounds.



 **NOTE:** You can only set the recording time for incoming messages. You cannot set the recording time for memos. (Individual memos can be up to three minutes. Refer to **Recording and playing memos** on page 56.)

Telephone settings

Telephone base ringer volume

When the telephone is not in use, press **▲▼VOLUME** on the telephone base to set the ringer volume level (1-6), or turn the ringer off. A sample of the ringer sounds as you adjust the volume. The telephone base announces, *“Base ringer is off”* when you set the volume to 0.



i **NOTE:** If a handset is on an outside call or accessing the answering system, the telephone base volume cannot be changed.

Making, answering and ending a call

Making a call

To make a call:

1. Press **PHONE/FLASH**, then wait for the dial tone.
-OR-
Press **SPEAKER** to use the speakerphone, then wait for the dial tone.
2. Use the dial pad keys to enter the telephone number.

On hook dialing (predialing):

1. Use the dial pad keys to enter the telephone number (up to 30 digits).
 - Press and hold **REDIAL/PAUSE** to insert a three-second dialing pause (a **P** appears).
 - Press **MUTE/REMOVE** or **OFF/CLEAR** to make corrections.
2. Press **PHONE/FLASH** to call.
-OR-
Press **SPEAKER** to call using the speakerphone.
-OR-
Press and hold **OFF/CLEAR** to return to the idle mode.

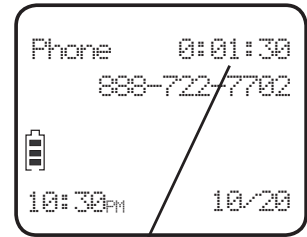

The screen displays the elapsed time as you talk (in hours, minutes and seconds).

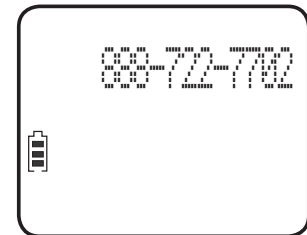

iNOTES:

- Pressing **PHONE/FLASH** to access services from your telephone service provider does not affect the elapsed time.
- When a handset is on a call, if another handset attempts to access the directory, speed dial list, caller ID history or answering system, the screen shows **Not available at this time**.

Temporary ringer silencing

To silence the ringer temporarily on that handset only:

- While the telephone is ringing, press **OFF/CLEAR** or **MUTE/REMOVE**.

To silence the ringer temporarily on the telephone base:

- While the telephone is ringing, press **VOLUME** on the telephone base.



This turns off the ringer without disconnecting the call. The next incoming call rings normally at the preset volume.

i**NOTE:** Unless the ringer volume is turned off on that handset, each handset rings when there is an incoming call.

Making, answering and ending a call

Answering a call

- Press any dial pad key (known as Any Key Answer) or **PHONE/FLASH**.
- OR-
- Press **SPEAKER** to use the speakerphone.

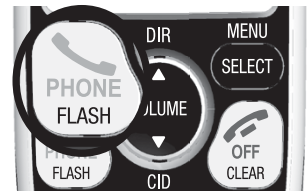

Speakerphone

During a call, press **SPEAKER** to switch between speakerphone and normal handset use.

Press **OFF/CLEAR** to hang up.

i NOTE: After installing the battery in the handset, the screen may show **LOW BATTERY**. If you use the speakerphone at this time, the battery may become depleted. Follow the instructions in **Battery charging** on page 7.

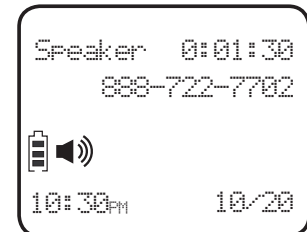

Ending a call

- Press **OFF/CLEAR**.
- OR-
- Put the handset in the telephone base or charger to end the call (known as Auto Off).

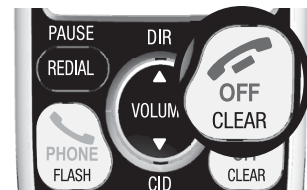

Redial

Each handset stores the 20 numbers most recently called in the redial list.

To review numbers in the redial list

1. Press **REDIAL/PAUSE** in idle mode.
2. Press **▲DIR** or **▼CID**, or press **REDIAL/PAUSE** repeatedly to scroll through the 20 recently called numbers (up to 30 digits each). The handset beeps twice at the beginning or end of the list.
3. Press **PHONE/OFF/CLEAR** to exit the redial list.

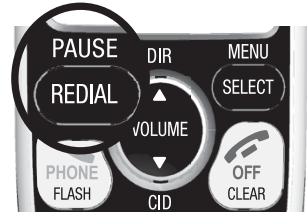

i **NOTE:** If you access an empty redial list, the handset sounds an error tone.

To call a number from the redial list

- With the desired number from redial displaying, press **PHONE/FLASH** or **SPEAKER** to dial (known as Display Dial).

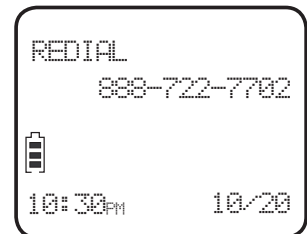

-OR-

1. Press **PHONE/FLASH** or **SPEAKER** and then wait for the dial tone.
2. Press **REDIAL/PAUSE**. The screen shows the number most recently called. If it is not the desired number, press **▲DIR** or **▼CID** to scroll to the desired number.
3. Press **MENU/SELECT**. The handset dials the displayed number.

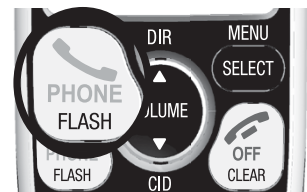

i **NOTE:** If you access an empty redial list, the handset sounds an error tone.

To copy a number from the redial list to the directory

1. While reviewing the desired number in the redial list, press **MENU/SELECT** twice to edit the telephone number. Refer to step 5 in **To create a new directory entry** on page 37.
2. Press **MENU/SELECT** to add the name. Refer to step 7 in **To create a new directory entry** on page 37.
3. Press **MENU/SELECT** to store your new directory entry. The handset shows **Saved** and sounds a confirmation tone.

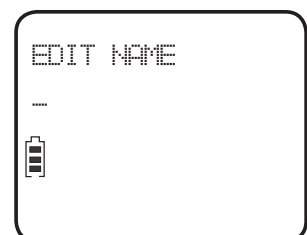
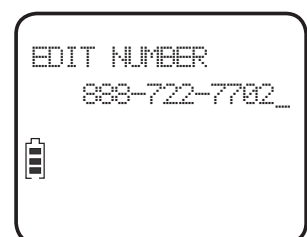

Redial

To delete a number in the redial list

- While reviewing a number in the redial list, press **MUTE/REMOVE** to delete the displayed number from the redial list.



Options while on calls

Volume control

While on a call, press ▲**DIR/VOLUME** to increase or press ▼**CID/VOLUME** to decrease the listening volume.

When the volume reaches the minimum or maximum setting, you hear two beeps.

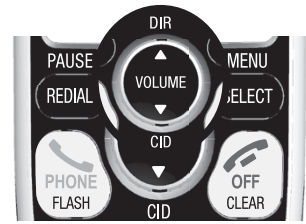

i **NOTE:** The handset earpiece volume setting (1-5) and speakerphone volume setting (1-6) are independent.

Mute

Use the mute function to turn off the microphone while on a call. You can hear the caller, but the caller does not hear you.

To mute the call:

- Press **MUTE/REMOVE**. When mute is on, the handset screen shows **Muted** for a few seconds and the **MUTE** icon appears until you turn off mute.



To end mute:

- Press **MUTE/REMOVE** and then resume speaking. When mute is off, **Microphone on** appears temporarily on the handset screen.

-OR-

Mute is automatically canceled when you end the call.



i **NOTE:** The mute feature is automatically canceled if you press ☎**PHONE/FLASH** (see **Flash/call waiting** on this page).

Flash/call waiting

For more information on caller ID with call waiting, refer to **About caller ID** on page 44. If you subscribe to call waiting service provided by your telephone service provider, you hear a beep if someone calls you while you are already on a call.

- Press ☎**PHONE/FLASH** to put your current call on hold and take the new call.
- Press ☎**PHONE/FLASH** anytime to switch back and forth between calls.

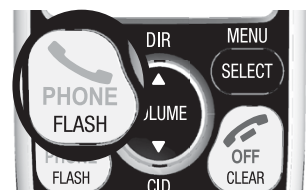

Options while on calls

Equalizer

You can use the equalizer feature to change the quality of the audio of the handset to best suit your hearing.

While on a call, listening to a message or announcement on the handset, press **Ⓜ EQUALIZER** to select the equalizer setting **Treble 1**, **Treble 2**, **Bass** or **Natural** (the default setting). The current setting appears temporarily on the handset screen.



Audio assist

You can use this feature to make some voices to sound louder and clearer while you are on a call, listening to a message or announcement by using the handset earpiece.

To turn on this feature:

- While you are on a call, listening to a message or announcement by using the handset earpiece, press **AUDIO ASSIST**. The handset screen shows **Audio assist on** for a few seconds and the **AUDIO ASSIST** icon appears until you turn off this feature.



To turn off this feature:

- Press **AUDIO ASSIST**. The handset screen shows **Audio assist off** for a few seconds.
-OR-
This feature is automatically canceled when you end the call.



You must press **AUDIO ASSIST** every time you want to activate the feature.

i NOTE: The audio assist™ feature is automatically canceled if you switch from the handset earpiece (normal handset use) to the speakerphone.

Temporary tone dialing

If you have dial pulse (rotary) dialing service only, you can temporarily switch from dial pulse to touch-tone dialing during a call.

1. During a call, press **TONEX**. Buttons pressed after this send touch-tone signals.
2. Use the dial pad keys to enter the number.
3. The telephone automatically returns to pulse dial mode after you end the call.



Options while on calls

Chain dialing

While on a call, you can initiate a dialing sequence from numbers stored in the directory, caller ID history or redial list. Doing this can be useful if you need to access numbers other than telephone numbers (such as bank account numbers or access codes).

- **To access the directory while on a call:**

1. Press **MENU/SELECT**.
2. Press **▲DIR** or **▼CID** to scroll to **>Directory**, then press **MENU/SELECT**.
3. Press **▲DIR** or **▼CID** to scroll or press the dial pad keys (0 through 9) to find the desired entry (see **To search by name** on page 39).
4. Press **MENU/SELECT**. The telephone automatically dials the displayed number.

- **To access the caller ID history while on a call:**

1. Press **MENU/SELECT**.
2. Press **▲DIR** or **▼CID** to scroll to **>Call log**, then press **MENU/SELECT**.
3. Press **▲DIR** or **▼CID** to scroll to the desired entry. (If necessary to view the dialing options, press **#**. See **To view the dialing options** on page 47 for more details.)
4. Press **MENU/SELECT**. The telephone automatically dials the displayed number.

- **To access the redial list while on a call:**

1. Press **REDIAL/PAUSE**. The screen shows the number most recently called. If it is not the desired number, press **▲DIR** or **▼CID** to scroll to the desired number.
2. Press **MENU/SELECT**. The handset dials the displayed number.

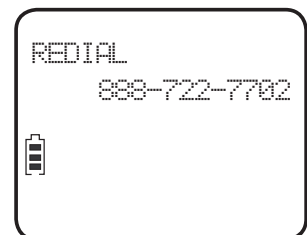
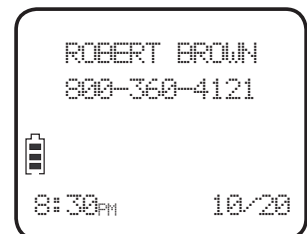
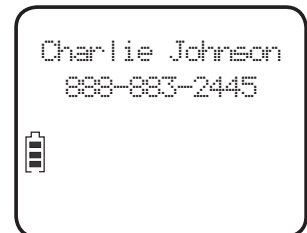
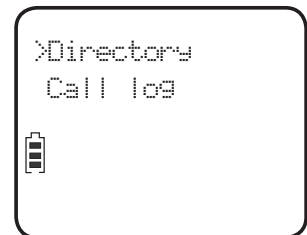
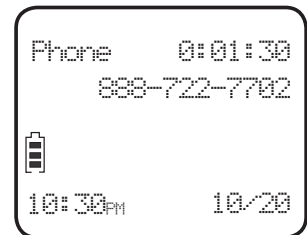

NOTES:

- While on a call, you cannot edit a directory entry or copy a caller ID entry into the directory.
- If someone else is already using the directory, speed dial list, caller ID history or answering system, when you attempt to access one of them, the screen shows **Not available at this time**.
- Press **OFF/CLEAR** to exit directory, caller ID history or redial list and return to the call without dialing the displayed number.

Options while on calls

Join a call in process

If you have more than one handset (see **Adding and registering a handset** on page 60), a handset is already on a call and you would like to join the call:

- Press  **PHONE/FLASH** or  **SPEAKER** on another system handset.

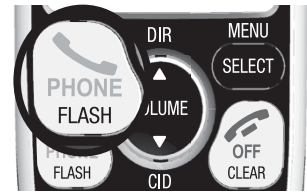

To exit the call:

- Press  **OFF/CLEAR** or place the handset in the telephone base or charger.

The call does not end until all handsets hang up.

 **NOTE:** You can only use up to four system handsets at the same time on an outside call. If you attempt to use another handset to join the call, the handset screen shows **Unable to call Try again.**

Handset locator

You can use the handset locator feature to find misplaced handsets.

To start the paging tone:

- Press **HANDSET LOCATOR** on the telephone base to start the paging tone on all handsets for 60 seconds.



To stop the paging tone:

- Press **PHONE/FLASH**, **SPEAKER**, or any dial pad key (0-9, *, or #) on the handset(s).
- OR-
- Press **HANDSET LOCATOR** on the telephone base.
- OR-
- Put the handset in the telephone base or charger.



iNOTES:

- If you press **OFF/CLEAR** or **MUTE/REMOVE** on a handset, the ringer of that handset is silenced but the paging tone continues on the other handsets.
- If the handset is accessing the answering system, on a call (intercom call or outside call), or out of range, that handset does not beep when paged.
- You cannot use the handset locator feature while the telephone base is playing messages or the answering system is being accessed remotely.

Intercom

To make and answer an intercom call

If you have more than one handset (see **Adding and registering a handset** on page 60), you can use the intercom feature for conversations between handsets.

1. Press **MENU/SELECT** on your handset when not in use.
2. Press **▲DIR** or **▼CID** to scroll to **>Intercom**, then press **MENU/SELECT**.
 - If you have two handsets, your handset screen shows **Calling HANDSET X**.
 - If you have more than two handsets, your screen shows **INTERCOM TO:** Use the dial pad keys to select the other handset. Your handset screen shows **Calling HANDSET X**.
 - The other handset rings and its screen shows **HANDSET X is calling**.
3. To answer the intercom call, press any dial pad key (0-9, *, or #), **PHONE/FLASH** or **▶SPEAKER** on the other handset. Both handsets now show **Intercom**.
4. To end an intercom call, press **OFF/CLEAR** or place the handset back in the telephone base or charger. Both handsets now show **Intercom ended**.



NOTES:

- Before the intercom call is answered, you can cancel the intercom call by pressing **OFF/CLEAR** on your originating handset.
- If the other handset is not answered within 100 seconds, is in use, on a call or is out of range, your originating handset shows **Unable to call Try again**.
- Pressing **OFF/CLEAR** or **MUTE/REMOVE** temporarily silences the intercom ringer.
- If you have four handsets, when two handsets are on an intercom call, the other two system handsets can be used on an outside call (see **Join a call in process** on page 30) or a separate intercom call.
- If you have five handsets and four of them are on intercom calls, you can use the other handset for an outside call.

Intercom

To answer an incoming call during an intercom call

If you receive an incoming outside call during an intercom call, there is an alert tone.

To answer the incoming outside call:

- Press  **PHONE/FLASH**. The intercom call ends automatically.

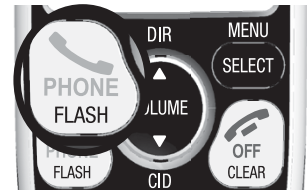

To end the intercom call without answering the incoming outside call:

- Press  **OFF/CLEAR**. The intercom call ends and the handsets ring for the incoming call.

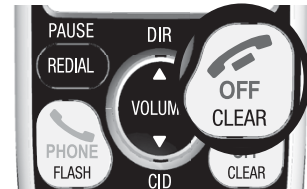

To let the answering system answer the incoming outside call:

- Do nothing. Continue with the intercom call. If the answering system is on, it answers the incoming call after the number of rings you have set.

Call transfer using intercom

If you have more than one handset (see **Adding and registering a handset** on page 60), you can use the intercom feature to transfer an outside call to another system handset.

1. During a call, press **MENU/SELECT** on your handset.
2. Press **▲DIR** or **▼CID** to scroll to **>Intercom**, then press **MENU/SELECT**.
 - If you have two handsets, the outside call is put on hold and your handset screen shows **Calling HANDSET X**. The other handset rings and its screen shows **HANDSET X is Calling**.
 - If you have more than two handsets, your screen shows **INTERCOM TO:** Use the dial pad keys to enter a handset number. The outside call is put on hold and your handset screen shows **Calling HANDSET X**. The other handset rings and its screen shows **HANDSET X is Calling**.
3. To answer the intercom call on the other handset, press any dial pad key (0-9, *, or #), **☎PHONE/FLASH** or **🔊SPEAKER**. The outside call is still on hold and both handsets now show **Intercom**. You can now have a private conversation between the system handsets.

iNOTES:

- To cancel the transfer and return to the external call before the intercom call is answered, press **📞OFF/CLEAR** or **☎PHONE/FLASH** on your handset.
- If the other handset is not answered within 100 seconds, is in use, on a call or is out of range, the calling handset shows **Unable to call Try again** on its screen and automatically returns to the external call.

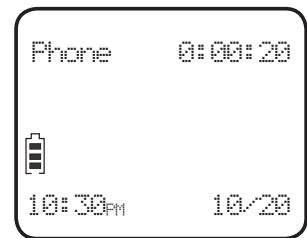

Call transfer using intercom

4. From this intercom call, you have the following options:

- You can let the other handset join you on the outside call in a three-way conversation. Follow the steps below:
 - a. Press **MENU/SELECT** on the calling handset.
 - b. Press **▲DIR** or **▼CID** to scroll to **>Share call**.
 - c. Press **MENU/SELECT**.
- You can transfer the call. Press **☞OFF/CLEAR**, or place your handset back in the telephone base or charger. Your handset screen shows **Call Transferred**. The other handset automatically connects to the outside call.

-OR-

Press **MENU/SELECT** on your handset. Press **MENU/SELECT** twice to select **>Transfer**.

- You can press **☎PHONE/FLASH** on the original system handset to end the intercom call or the other person can end the intercom call by pressing **☞OFF/CLEAR**, or by placing the other handset back in the telephone base or charger. The outside call continues with the original system handset.

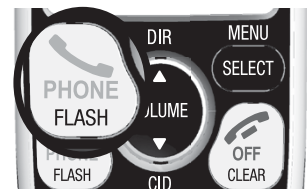
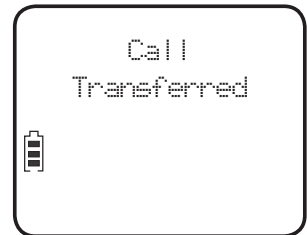
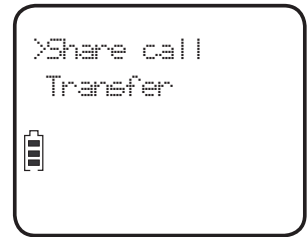

Directory overview

Shared directory

If you have more than one handset (see **Adding and registering a handset** on page 60), the directory is shared by all handsets. Changes made to the directory on any one handset apply to all.

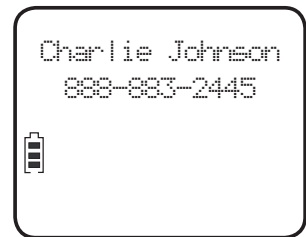

NOTE: Only one handset can review the directory at a time. If another handset attempts to enter the directory, the screen shows **Not available at this time.**

Directory memory capacity

The directory can store up to 100 entries, with a maximum of 15 alphanumeric characters (including spaces) for the names and 30 digits for the telephone numbers. A convenient search feature can help you find and dial numbers quickly (see **To search by name** on page 39).

If there are already 100 entries, the screen shows **Directory full.** You cannot store a new number until you delete one.



If the directory is empty, when you access it, the screen shows **Directory empty.**

Exiting the directory

Press **OFF/CLEAR** to cancel an operation, back up to the previous menu, or exit the menu display. Press and hold **OFF/CLEAR** to return to the idle mode.

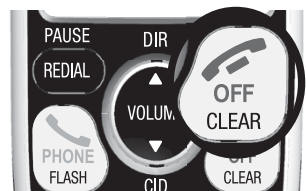

Speed dial overview

This telephone has 10 speed dial locations where you can assign telephone numbers from the directory you wish to dial numbers using only one key press. For more details, refer to **Speed dial locations** on page 42.

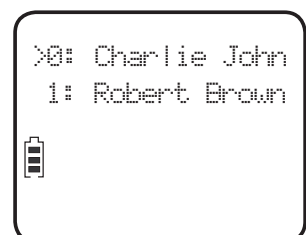

If you have more than one handset (see **Adding and registering a handset** on page 60), the speed dial locations are shared by all handsets. Changes made to the entries in the speed dial locations on any one handset apply to all.

NOTE: Only one handset can access the speed dial locations at a time. If another handset attempts to access the speed dial locations, the screen shows **Not available at this time.**

Create directory entries

To create a new directory entry

1. Press **MENU/SELECT** in idle mode.
2. Press **▲DIR** or **▼CID** to scroll to **>Directory**, then press **MENU/SELECT**.
3. Press **▲DIR** or **▼CID** to scroll to **>Add contact**.
4. Press **MENU/SELECT**.
5. Enter the telephone number when prompted.

- Copy a number from redial:
 - a. Press **REDIAL/PAUSE**.
 - b. Press **▲DIR** or **▼CID** or press **REDIAL/PAUSE** repeatedly to locate the number to copy.
 - c. Press **MENU/SELECT** to copy the number.

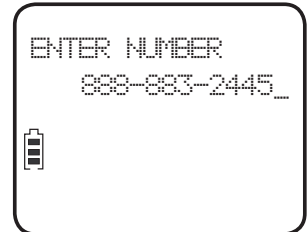

-OR-

- Use the dial pad keys to enter a number (up to 30 digits).
 - Press **▲DIR** or **▼CID** to move the cursor to the right or left.
 - Press and hold **REDIAL/PAUSE** to enter a three-second dialing pause (a **P** appears).
 - Press **MUTE/REMOVE** to erase digits.
 - Press and hold **MUTE/REMOVE** to erase all digits.
6. Press **MENU/SELECT** to save the number in the display.
 7. Enter the name when prompted. Use the dial pad keys and refer to **Character chart** on page 38 to enter a name (up to 15 characters). Each time you press a key, the character on that key appears. Additional key presses produce other characters on that key.
 - Press **▲DIR** or **▼CID** to move the cursor to the right or left.
 - Press **0** to add a space.
 - Press **MUTE/REMOVE** to erase characters.
 - Press and hold **MUTE/REMOVE** to erase all characters.

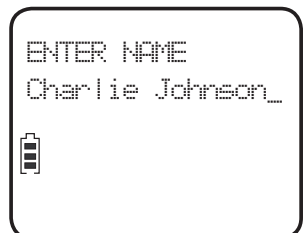

Create directory entries

- The first letter of every word is capitalized. The remaining letters in a word start as lower case letters as shown in the character chart below:

Dial Key	Characters by number of key press										
	1	2	3	4	5	6	7	8	9	10	11
1	1	.	-	'	()	*	#	&	/	,
2	a	b	c	A	B	C	2				
3	d	e	f	D	E	F	3				
4	g	h	i	G	H	I	4				
5	j	k	l	J	K	L	5				
6	m	n	o	M	N	O	6				
7	p	q	r	s	P	Q	R	S	7		
8	t	u	v	T	U	V	8				
9	w	x	y	z	W	X	Y	Z	9		
0	space	0									

- Press **MENU/SELECT** to store your new directory entry. The handset shows **Saved** and a confirmation tone sounds.

NOTES:

- The screen shows **Number already saved** if the number is already in the directory. You cannot save the same number more than once.
- If you pause for too long while creating an entry, the procedure times out and you have to begin again.

To add a predialed telephone number to the directory

- While the handset is in idle mode, use the dial pad keys to enter the telephone number (up to 30 digits).
 - Press and hold **REDIAL/PAUSE** to insert a three-second dialing pause (a **P** appears).
 - Press **MUTE/REMOVE** to make corrections.
- Press **MENU/SELECT** to edit the telephone number. Refer to step 5 in **To create a new directory entry** on page 37.
- Press **MENU/SELECT** to edit the name. Refer to step 7 in **To create a new directory entry** on page 37.
- Press **MENU/SELECT** to store your new directory entry. The handset shows **Saved** and sounds a confirmation tone.

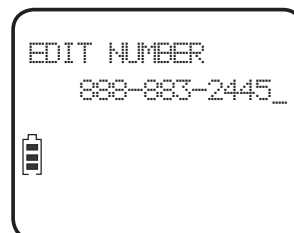
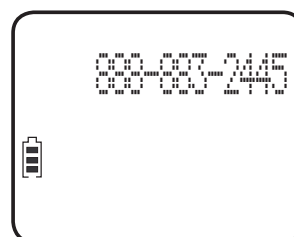

Reviewing the directory

To review directory entries

1. Press **▲DIR** when in idle mode to show the first entry in the directory. **Directory empty** appears if there are no directory entries.

-OR-

You can also show the first entry in the directory by pressing **MENU/SELECT** when in idle mode. Press **▲DIR** or **▼CID** to scroll to **>Directory**, then press **MENU/SELECT** twice to select **>Review**.

2. Press **▲DIR** or **▼CID** to browse through the directory. Entries appear alphabetically by the first letter in the name.



iNOTES:

- If the telephone number in the directory exceeds 15 digits, **<*** appears in front of the telephone number. Press **TONEX** to move towards the end of the telephone number or press **#** to move towards the beginning of the telephone number.
- If you pause for too long while reviewing an entry, the procedure times out and you have to begin again.

To search by name

1. Press **▲DIR** when in idle mode to show the first entry in the directory.
2. When an entry appears, press the dial pad keys (0-9) to start a name search (alphabetical search).

The directory shows the first name beginning with the first letter associated with the dial pad key if there is an entry in the directory that begins with that letter. Press **▲DIR** or **▼CID** to scroll through the entries beginning with that letter.

3. To see other names that start with the letters on the same dial pad key, keep pressing the key until the desired letter is shown. The names appear in alphabetical order.

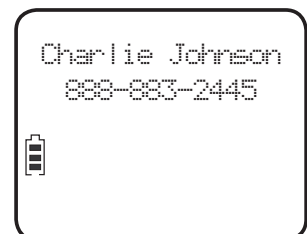

Reviewing the directory

For example, if you have the names Jennifer, Jessie, Kevin and Linda in your directory:

- If you press **5 (JKL)** once, **J** and then **Jennifer** displays.
- If you press **5 (JKL)** once, **J** displays. Press **▼cid**. **Jessie** displays.
- If you press **5 (JKL)** twice, **K** and then **Kevin** displays.
- If you press **5 (JKL)** three times, **L** and then **Linda** displays.
- If you press **5 (JKL)** four times, **5** displays.
- If you press **5 (JKL)** five times, **J** displays and then **Jennifer** displays again.

 **NOTE:** If you press a key (0-9) and no name starts with the letters on that key, the directory shows the entry that matches the next letter in the directory.

Dialing, deleting and editing a directory entry

You can dial, delete or edit the displayed directory entry.

See **To review directory entries** or **To search by name** on page 39 to show an entry from the directory first.

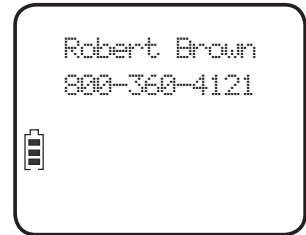

To dial a directory number

- While reviewing a directory entry, press **PHONE/FLASH** or **SPEAKER** to dial the displayed telephone number from the directory (known as Display Dial).

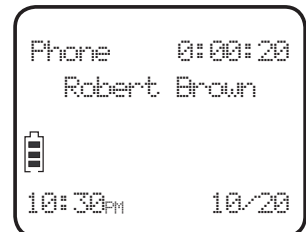

To delete a directory entry

- While reviewing a directory entry, press **MUTE/REMOVE**. The screen shows **Delete contact?**
- Press **MENU/SELECT** to delete the displayed entry from the directory. The handset shows **Deleting...** and then **Contact deleted** with a confirmation tone. Once deleted, you cannot retrieve that entry.
-OR-
Press **OFF/CLEAR** to exit and leave the entry intact.

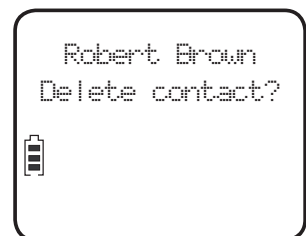

NOTE: If the directory entry you deleted is also in the speed dial location, the telephone will automatically clear the speed dial location that entry occupied.

To edit a directory entry

- While reviewing a directory entry, press **MENU/SELECT**. The screen shows **EDIT NUMBER** with the current number of the entry.
- Follow step 5 in **To create a new directory entry** on page 37.
- Press **MENU/SELECT** to save the number in the display. The screen shows **EDIT NAME** with the current name of the entry.
- Follow step 7 in **To create a new directory entry** on page 37 to edit the characters.
- Press **MENU/SELECT** to confirm. The handset shows **Saved** with a confirmation tone and then shows the updated entry.

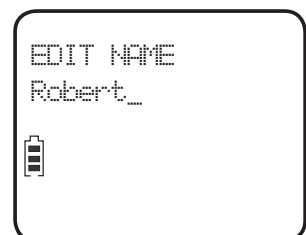
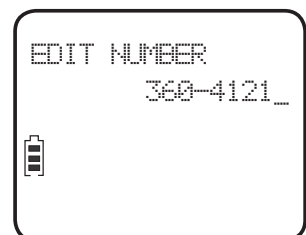

Speed dial locations

To assign or reassign a directory entry to a speed dial location

1. Press **MENU/SELECT** in idle mode.
2. Press **▲DIR** or **▼CID** to scroll to **>Directory**. Press **MENU/SELECT**.
3. Press **▲DIR** or **▼CID** to scroll to **>Speed dial**. Press **MENU/SELECT**.
4. To assign a speed dial location, press **▲DIR** or **▼CID** to scroll to an empty speed dial location.
-OR-
 To reassign a speed dial location, press **▲DIR** or **▼CID** to scroll to the desired speed dial location.
5. Press **MENU/SELECT**. The screen shows **Copy from Directory...** and then the directory.
6. Press **▲DIR** or **▼CID** to browse through the directory and find the desired entry.
-OR-
 Use the alphabetical search to find the desired entry. Refer to steps 2 and 3 in **To search by name** on page 39.
7. Press **MENU/SELECT** to confirm. The name (up to 12 characters) of the desired directory entry appears in the selected speed dial location.

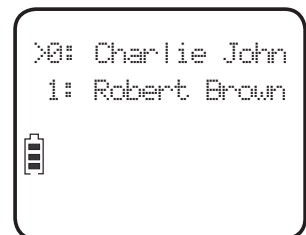
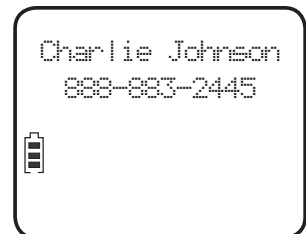
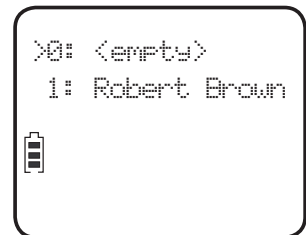
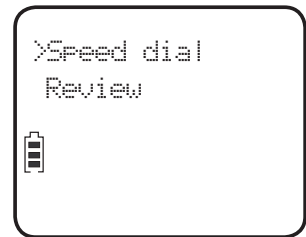

i NOTES:

- If the directory is empty, when you press **MENU/SELECT** in step 5, the screen shows **Directory empty**.
- If the speed dial location you selected is occupied, the new directory entry you selected replaces the old one. Take caution not to replace entries you do not wish to delete from the speed dial locations.

To clear a speed dial location

1. Follow steps 1 through 3 in **To assign or reassign a directory entry to a speed dial location** on this page to enter the speed dial list.
2. Press **▲DIR** or **▼CID** to scroll to a speed dial location.
3. Press **MUTE/REMOVE** to clear the selected speed dial location. **Speed dial empty** appears temporarily and then **<empty>** appears in that speed dial location.

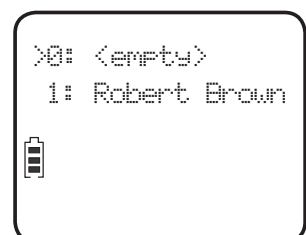
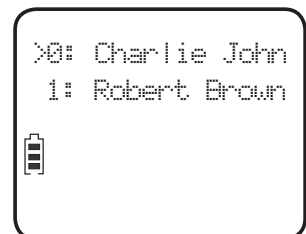

i NOTE: Clearing the speed dial locations does not affect the entries in the directory.

Speed dial locations

To dial a speed dial number

1. When in idle mode, press and hold a dial pad key (0 through 9) to display the desired speed dial entry.
2. The handset automatically dials out the displayed number.

-OR-

Press  **OFF/CLEAR** within one second to stop dialing the displayed number.

 **NOTE:** If the speed dial location you selected is empty, the screen shows the speed dial list.



About caller ID

This product supports caller ID services offered by most telephone service providers. Caller ID allows you to see the name, number, date and time of calls. The available caller ID information will appear after the first or second ring.

Information about caller ID with call waiting

Caller ID with call waiting lets you see the name and telephone number of the caller before answering the call, even while on another call.

It may be necessary to change your telephone service to use this feature. Contact your telephone service provider if:

- You have both caller ID and call waiting, but as separate services (you may need to combine these services).
- You have only caller ID service, or only call waiting service.
- You don't subscribe to caller ID or call waiting services.

There are fees for caller ID services. In addition, services may not be available in all areas.

This product can provide information only if both you and the caller are in areas offering caller ID service and if both telephone service providers use compatible equipment.

The time and date are sent by the telephone service provider along with the call information.

The caller ID information may not be available for every incoming call. The callers may intentionally block their names and/or telephone numbers.

i **NOTE:** You can use this product with regular caller ID service, or you can use this product's other features without subscribing to either caller ID or combined caller ID with call waiting service.

About home area code

See **Home area code** on page 15 to determine if you should enter your area code. Entering the area code changes how numbers are displayed in the caller ID history and how to return a call from the caller ID history (see **To view the dialing options** on page 47).



Caller ID history

How caller ID history (call log) works

The telephone stores caller ID information about the last 50 incoming calls in the telephone base. Each entry may have up to 24 digits for the telephone number and 15 characters for the name. Entries are stored in reverse chronological order. The telephone deletes the oldest entry when the log is full to make room for new calls. If you have more than one handset (see **Adding and registering a handset** on page 60), this information is common to all handsets, so changes made in any handset are reflected in all other handsets. If you answer a call before the information appears on the screen, it does not show in the caller ID history.

i **NOTE:** The caller ID information might not be available for every incoming call. The callers might intentionally block their names and/or telephone numbers (see **Reasons for missing caller ID information** on page 46).

Memory match

If the incoming telephone number matches the last seven digits of a telephone number in your directory, the name that appears on the screen matches the corresponding name in your directory.

For example, if Christine Smith calls, her name appears as **Chris** if this is how you entered into your directory.

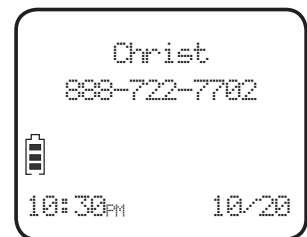

i **NOTE:** The number shown by your caller ID is in the format sent by the telephone service provider. The telephone service provider usually delivers ten-digit telephone numbers (area code plus telephone number). If the telephone number of the caller does not match a number in your directory, the name appears as it is delivered by the telephone service provider. For example, if the telephone service provider includes the area code and the directory number does not, the name appears as delivered by the telephone service provider.

Caller ID operation

Missed (new) calls indicator

When you have calls that have not been reviewed, the handset idle screen shows **XX missed calls**.

All entries that have not been reviewed are counted as missed (new) calls. Each time you review a caller ID history entry marked **NEW**, the number of missed calls decreases by one.

If you do not want to review the missed (new) calls one by one, but you still want to keep them in the caller ID history, you can press and hold **OFF/CLEAR** for four seconds when the handset is idle. All the entries in the caller ID history are considered old (reviewed), and the missed calls message goes away.



Reasons for missing caller ID information

There are occasions when other information or no information shows for various reasons:

Screen message	Reason
PRIVATE NAME	The caller prefers not to show the name.
PRIVATE NUMBER	The caller prefers not to show the telephone number.
PRIVATE CALLER	The caller prefers not to show the name and telephone number.
UNKNOWN NAME	Your telephone service provider cannot determine the caller's name.
UNKNOWN NUMBER	Your telephone service provider cannot determine the caller's telephone number.
UNKNOWN CALLER	Your telephone service provider cannot determine the caller's name and telephone number. Calls from other countries may also generate this message.

Caller ID operation

To review the caller ID history

Review the caller ID history to find out who called, to return the call or to copy the caller's name and number into your directory. **Call log empty** appears if there are no records in the caller ID history.

1. When a handset is in idle mode, press **▼CID** to review the caller ID history in reverse chronological order starting with the most recent call.

-OR-

You can also review the caller ID history by pressing **MENU/SELECT**. Press **▲DIR** or **▼CID** to scroll to **>Call log**, then press **MENU/SELECT** twice to select **>Review**.

2. Press **▲DIR** or **▼CID** to scroll through the list. A double beep sounds when the list reaches the beginning or end of the caller ID history.

3. Press **OFF/CLEAR** to exit the caller ID history.

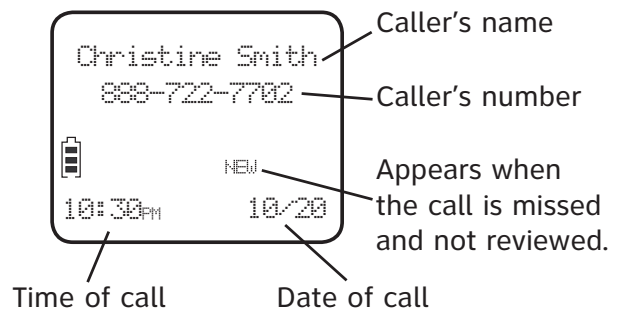

iNOTES:

- If the telephone number has more than 15 digits, only the last 15 digits appear in the caller ID history.
- Only one handset can review the caller ID history at a time. If another handset attempts to enter the caller ID history, it shows **Not available at this time**.

To view the dialing options

Although the caller ID history entries received typically have 10 digits (the area code plus the seven-digit number), in some areas, you might need to dial only the seven digits, or 1 plus the seven digits, or 1 plus the area code plus the seven digits. You can follow the steps below to change the number of digits that you dial from or store in the directory:

1. Follow steps 1 and 2 in **To review the caller ID history** on this page to find the entry.

2. Before dialing or saving the telephone number in the directory, press **#** repeatedly to show different dialing options for local and long distance numbers.

-OR-

Before dialing or saving the telephone number in the directory, press **1** repeatedly if you need to add or remove 1 in front of the telephone number.

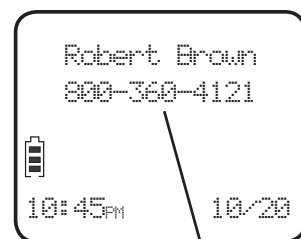

- Press # → 1-800-360-4121
- Press # → 360-4121
- Press # → 1-360-4121
- Press # → 800-360-4121

-OR-

- Press 1 → 1-800-360-4121
- Press 1 → 800-360-4121

iNOTE: If you do not need to dial the area code for local calls, make sure to program your home area code (see **Home area code** on page 15).

Caller ID operation

To dial a caller ID history number

1. While reviewing the caller ID history, press **▲DIR** or **▼CID** to browse through the caller ID history and find the entry.
2. Press **PHONE/FLASH** or **SPEAKER** to dial the displayed telephone number from the caller ID history (known as Display Dial).



iNOTES:

- If the telephone number has more than 15 digits, only the last 15 digits appear in the caller ID history. But, the telephone can still dial out all digits (up to 24 digits) of that telephone number.
- You might need to change how a caller ID number is dialed if the entry does not appear in the correct format. Caller ID numbers might appear with an area code that might not be necessary for local calls, or without a 1 that might be necessary for long distance calls. For details, see **To view the dialing options** on page 47.

To delete caller ID history entries

To delete a caller ID history entry:

1. While reviewing the caller ID history, press **▲DIR** or **▼CID** to browse through the caller ID history and find the entry.
2. Press **MUTE/REMOVE** to delete the displayed entry from the caller ID history. A confirmation tone sounds. Once deleted, you cannot retrieve that entry.



To delete all caller ID history entries:

1. Press **MENU/SELECT** in idle mode.
 2. Press **▲DIR** or **▼CID** to scroll to **>Call log**. Press **MENU/SELECT**.
 3. Press **▲DIR** or **▼CID** to scroll to **>Del all calls**. Press **MENU/SELECT**. The screen shows **Delete all calls?**
 4. Press **MENU/SELECT** to delete all entries from the caller ID history. A confirmation tone sounds. Once deleted, you cannot retrieve an entry.
- OR-**
- Press **OFF/CLEAR** to exit and leave all entries in the caller ID history intact.

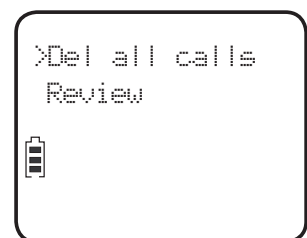

Caller ID operation

Saving a caller ID history entry in the directory

1. While reviewing the caller ID history, press **▲DIR** or **▼CID** to browse through the caller ID history and find the desired entry.
2. Press **MENU/SELECT**. The screen shows **EDIT NUMBER**.
3. Use the dial pad keys to modify the telephone number (up to 24 digits).
 - Press **▲DIR** or **▼CID** to move the cursor to the right or left.
 - Press and hold **REDIAL/PAUSE** to enter a three-second dialing pause (a **P** appears).
 - Press **MUTE/REMOVE** to erase digits.
 - Press and hold **MUTE/REMOVE** to erase all digits.
4. Press **MENU/SELECT** to save the number in the display. The screen shows **EDIT NAME**.
5. Use the dial pad keys and refer to **Character chart** on page 38 to modify the name (up to 15 characters).
 - Press **▲DIR** or **▼CID** to move the cursor to the right or left.
 - Press **0** to add a space.
 - Press **MUTE/REMOVE** to erase characters.
 - Press and hold **MUTE/REMOVE** to erase all characters.
6. Press **MENU/SELECT** to confirm. The screen shows **Saved** with a confirmation tone.

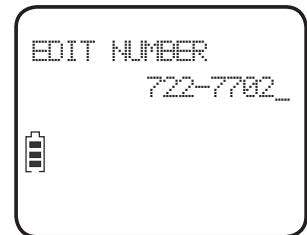

iNOTES:

- The screen shows **Number already saved** if the number is already in the directory. You cannot save the same number more than once.
- If the directory is full, the screen shows **Directory full**.
- If you try to save a caller ID history entry to the directory without a number, **Unable to save** displays.
- If the telephone number has more than 15 digits, only the last 15 digits appear in the caller ID history. But, the telephone can still save all digits (up to 24 digits) of that telephone number from the caller ID history in the directory.
- You might need to change how a caller ID number is saved in the directory if the entry does not appear in the correct format. Caller ID numbers might appear with an area code that might not be necessary for local calls, or without a 1 that might be necessary for long distance calls. For details, see **To view the dialing options** on page 47.

Answering system and voicemail

About answering system and voicemail

Your telephone has separate indicators for two different types of voice messages: those left on its built-in answering system and those left at your service provider's voicemail (fees may apply). Your telephone's built-in answering system messages and voicemail messages are separate. Each alerts you to new messages differently.

If  and **New voicemail** display on the handset, your telephone service provider is indicating that it has new voicemail for you. To listen to your voicemail, you typically dial an access number provided by your telephone service provider, followed by a security code or PIN.

Some service providers bundle or combine multiple services like voicemail and call waiting, so you may not be aware that you have voicemail. To check what services you have and how to access them, contact your telephone service provider.

To use your voicemail service rather than your answering system, turn off your answering system. To use your answering system rather than your voicemail service, contact your telephone service provider to deactivate your voicemail service. You can also use your telephone answering system and voicemail together by setting your built-in answering system to answer before voicemail answers as described below. To learn how to program your voicemail settings, contact your telephone service provider. Then, if you are on a call, or if the answering system is busy recording a message and you receive another call, the second caller can leave a voicemail message.

If you have voicemail provided by your telephone service provider, we recommend setting your answering system to answer calls at least two rings earlier than your voicemail is set to answer. For example, if your voicemail answers after six rings, set your answering system to answer after four rings. Some voicemail providers may program the delay before answering calls in seconds instead of rings. In this case, allow six seconds per ring when determining the appropriate setting.

Answering system new message indication

When there are new messages (including memos) on the answering system, the number of new messages stored flashes in the message window on the telephone base and the  icon and **XX new messages** appear on the screen of each system handset. If the new message alert tone is turned on, the telephone base beeps every 10 seconds when there are new messages.

To listen to messages recorded on your digital answering system, use the **Play messages** menu from a handset or press  **PLAY/STOP** on the telephone base (see **To listen to messages** on page 53).



Answering system overview

Voice prompts

The system provides voice prompts to guide you through recording announcements and remote access.

Message capacity

The answering system can record up to 99 messages, depending on the length of each message. Individual messages can be up to the minutes you set (see **Recording time** on page 21; the individual memos can be up to three minutes), and the approximate recording time is 14 minutes. The actual recording time depends on individual message characteristics. Messages remain available for replay until you delete them.

At the beginning of messages playback, if the answering system has less than three minutes of recording time left, the answering system announces, *"Less than three minutes to record."* If the memory is full, the answering system announces, *"Memory is full."*

If the memory is full, the number of messages and **F** flash alternately in the message window, and **Rec mem full** appears on the handset screen. You must delete some messages before recording new ones.

i **NOTE:** If the message is low or full, the answering system also prompts when you turn on the answering system. For more details, see **Answering mode** on page 18.

Call screening

Call screening on the telephone base:

If the answering system and call screening are on, the announcement and the incoming message broadcast at the telephone base when a call arrives.

You can turn call screening on or off using the handset (see **Call screening setup** on page 19). When call screening is off, you can temporarily turn on the call screening by pressing **▶/■ PLAY/STOP** or **▲VOLUME** on the telephone base. The call screening will be off for the next incoming call.

If call screening is on and you want to adjust the playback volume to a comfortable level (1-8) while it is recording messages, press **▲▼VOLUME** on the telephone base. This volume setting is shared with message playback, so when you play messages at volume 1, they play at a very low volume. If you turn up the volume for playback, the call screening for the next incoming message plays at the same volume level.



If call screening is on and you want to silence the telephone base while it is recording messages, press **▶/■ PLAY/STOP** on the telephone base. The call screening will be on for the next incoming call.

Answering system overview

Call screening on a handset:

1. If the answering system is on, the handset shows **To screen call, press SELECT** when a call arrives.
2. Press **MENU/SELECT** on the handset. The announcement and the incoming message broadcast from the handset speakerphone.

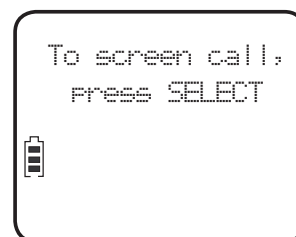

- Press **▲DIR/VOLUME** to increase or press **▼CID/VOLUME** to decrease the message playback volume.
- Press **🔊SPEAKER** to switch between speakerphone and handset earpiece.
- Press **📊EQUALIZER** to select the equalizer setting to change the quality of the audio of the handset to best suit your hearing (see **Equalizer** on page 28).
- If use the handset earpiece, press **AUDIO ASSIST** to make some voices to sound louder and clearer (see **Audio assist** on page 28). Press again to stop this feature.

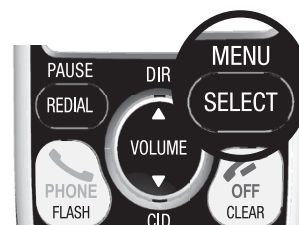

i **NOTE:** If you have more than one handset, you can use the telephone base and only one handset to call screening at the same time.

Call intercept

While call screening, you can press **PHONE/FLASH** or **🔊SPEAKER** on the handset to stop recording and speak to the caller.



Temporarily turning off the message alert tone

Follow the step below to temporarily silence the message alert tone:

- When the telephone base is in idle mode, press any telephone base key (except **HANDSET LOCATOR**).

The message alert tone is activated again with the next incoming message.



i **NOTES:**

- When the telephone base is in idle mode, if you press **X DELETE** to temporarily silence the message alert tone, there is a voice prompt to direct you to press **X DELETE** again to delete all old messages (see **To delete all old messages at the telephone base** on page 55). If you are not going to delete all old messages, wait at least 5 seconds to allow the telephone base to return to idle mode.
- To turn off the message alert tone, see **Message alert tone** on page 21.

Message playback

To listen to messages

You can use either a handset or the telephone base to play messages. If there are new messages, the system plays back only the new messages (oldest first). If there are no new messages, the system plays back all old messages (oldest first).

At the beginning of messages playback, if the answering system has less than three minutes of recording time left, the answering system announces, *"Less than three minutes to record."* If the memory is full, the answering system announces, *"Memory is full."* When playback begins, the total number of messages is announced. Before each message, you hear the day and time it was received. After the last message, you hear *"End of messages."*

NOTES:

- If the date and time is not set when a message is recorded, the system announces, *"Time and date not set"* before the message is played. To set the date and time, see **Set date/time** on page 14.
- Only one handset or the telephone base can access the answering system at a time.
- While a handset is on an outside call, you cannot play messages.

To listen to messages at the telephone base:

1. Press **▶/■ PLAY/STOP** on the telephone base to listen to the messages.
2. The system announces the number of messages, then begins playback. The message sequence is shown on the message window.
3. Press **▶/■ PLAY/STOP** to stop the playback.



 **NOTE:** If there are no messages in the answering system, when in step 1 above, the system announces, *"You have no message."*

To listen to messages at the handset:

1. Press **MENU/SELECT** when in idle mode.
2. Press **MENU/SELECT** to choose **>Play messages**.
3. To play new messages, press **MENU/SELECT** to choose **>Play new msgs.**
-OR-
To play old messages, press **▲DIR** or **▼CID** to scroll to **>Play old msgs.** Press **MENU/SELECT**.
4. The system announces the number of messages, then begins playback. The message sequence is shown on the handset's screen.
5. Press **5** to stop the playback.

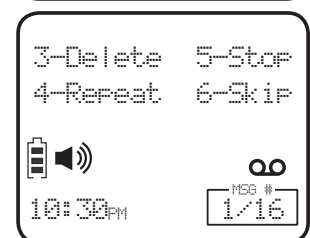
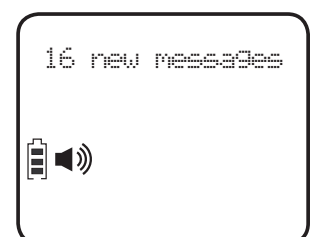

 **NOTE:** If there are no messages in the answering system, the handset shows **No message** and announces, *"You have no message."*

Message playback

Options during playback

When a message is playing, you can adjust the playback volume, skip, repeat, or delete the message.

When messages are playing on the telephone base:

- Press **▲▼VOLUME** to adjust the message playback volume (1-8).
- To repeat the message currently playing, press **◀ REPEAT** after the answering system plays the day and time the current message was received.
- To listen to the previous message, press **◀ REPEAT** while the answering system is playing the day and time the current message was received.
- Press **▶ SKIP** to skip to the next message.
- Press **SLOW** to slow message playback. The message window shows **SL**. Press again to stop slowing playback.
- Press **✕ DELETE** to delete the message. The telephone base announces, "Message deleted."
- Press **▶■ PLAY/STOP** to stop the playback.



When messages are playing on the handset:

- Press **▲DIR/VOLUME** to increase or press **▼CID/VOLUME** to decrease the message playback volume.
- Press **◀▶SPEAKER** to switch between speakerphone and handset earpiece.
- To repeat the message currently playing, press **4** after the answering system plays the day and time the current message was received.
- To listen to the previous message, press **4** while the answering system is playing the day and time the current message was received.
- Press **6** to skip to the next message.
- Press **EQ EQUALIZER** to select the equalizer setting to change the quality of the audio of the handset to best suit your hearing (see **Equalizer** on page 28).
- If use the handset earpiece, press **AUDIO ASSIST** to make some voices to sound louder and clearer (see **Audio assist** on page 28). Press again to stop this feature.
- Press **3** to delete the message. The handset announces, "Message deleted."
- Press **5** to stop the playback.



Message playback

To delete all old messages

Use this feature to delete all old messages. Once deleted, you cannot retrieve the deleted messages. New (unheard) messages cannot be deleted until you have listened to them.

i NOTE: If there are no old messages and you press **X DELETE** again on the telephone base, the system announces, "You have no old message." On the handset, when you select **Delete all old**, the screen shows **No message**.

To delete all old messages at the telephone base:

1. Press **X DELETE** on the telephone base. The system announces, "To delete all old messages, press **DELETE** again."
2. Press **X DELETE** within three seconds. The system announces, "All old messages deleted."



To delete all old messages at the handset:

1. Press **MENU/SELECT** when in idle mode.
2. Press **▲DIR** or **▼CID** to scroll to **>Answering sys**, then press **MENU/SELECT**.
3. Press **▲DIR** or **▼CID** to scroll to **>Delete all old**.
4. Press **MENU/SELECT**. The screen shows **Delete all old messages?**
5. Press **MENU/SELECT** to confirm. The screen shows **Deleting...** and then **All old msgs deleted!** with a confirmation tone sounds.

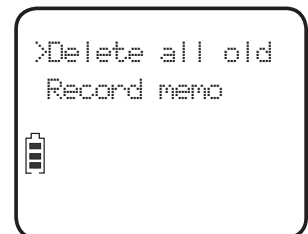

-OR-

Press **OFF/CLEAR** to exit and leave all old messages intact.

Recording and playing memos

Memos are messages you record yourself. They are saved, played back and deleted exactly like incoming messages. You can record a memo as a reminder to yourself, or leave a message for someone else using the same telephone.

To record a memo

1. Press **MENU/SELECT** when in idle mode.
2. Press **▲DIR** or **▼CID** to scroll to **>Answering sys**, then press **MENU/SELECT**.
3. Press **▲DIR** or **▼CID** to scroll to **>Record memo**.
4. Press **MENU/SELECT**. The system announces, *"Record after the tone. Press 5 when you are done."*
5. Speak towards the microphone on the handset after a long beep. You can record a memo up to three minutes. Memos shorter than two seconds are not recorded.
6. Press **5** to stop recording. The system announces, *"Recorded"* to confirm the recording has finished.



i **NOTE:** If the answering system memory is full, when you press **MENU/SELECT** in step 4, the answering system announces, *"Memory is full."*

To play back memos

Memos are stored as messages. See **Message playback** on page 53 for instructions on playback and deletion.

Message window displays

The message window on the telephone base displays the total number of messages. See the table below for other message window displays.

0	There are no messages in the answering system.
0 (flashing)	After a power failure, the number in the message window flashes to indicate the date and time need to be set.
0-6	Telephone base ringer volume while adjusting.
1-8	Speaker volume level of the telephone base while adjusting.
1-99	<ul style="list-style-type: none"> • Total number of messages and memos. • Current message number during old message playback.
1-99 (flashing)	<ul style="list-style-type: none"> • Total number of new messages and memos. The number flashes when there are new messages that have not been reviewed. • Current message number during new message playback. • After a power failure, the number in the message window flashes to indicate the date and time need to be set.
1-99 and F (alternating)	Memory is full. Messages must be deleted before new messages can be recorded.
SL	The message playback is slowing.
--	<ul style="list-style-type: none"> • The answering system is being programmed by a system handset. • The answering system is answering a call or recording a memo or announcement. • The answering system is being accessed remotely.

Remote access

You can access the answering system remotely by dialing your home telephone number from any touch-tone telephone.

To remotely access the answering system:

1. Dial your telephone number from any touch-tone telephone.
2. When the answering system answers, enter the two-digit remote access code (19, unless you have changed it; refer to **Remote access code** on page 20). The answering system automatically announces the number of messages (new or old) if there are any.
3. If there are new messages, the answering system automatically begins to play new messages only.
-OR-
 If there are no new messages, the answering system automatically begins to play all old messages.
4. You can also enter the remote commands:

Play all messages 1	Press to listen to all messages. If there are new messages, the system plays back only the new messages (oldest first). If there are no new messages, the system plays back all old messages (oldest first).
Play new messages 2	Press to listen to new messages only.
Delete a message 3	Press during a message playback to delete the current message.
Delete all old messages 33	Press to delete all old messages.
Replay current or previous message 4	To repeat the message currently playing, press 4 after the answering system plays the day and time the current message was received. To listen to the previous message, press 4 while the answering system is playing the day and time the current message was received.
Stop 5	Press to stop playback and recording.
Play help menu * 5	Press to listen to a list of remote commands.
Skip to next message 6	Press during playback to skip the current message and advance to the next message.
Record a announcement * 7	Press to record a new announcement. Begin speaking after the long beep.
Exit 8 or hang up	Press to end remote access (the call is terminated).
Turn system on or off 0	Press to turn the answering system on or off.

Remote access

5. Hang up to end the call and save all messages.

There is a wallet card listing the remote commands at the back of this user's manual. Cut it out and keep it in your wallet for quick reference.

NOTES:

- If you do not enter a valid remote access code, the system answers the call automatically.
- If the date and time is not set when a message is recorded, the system announces, *"Time and date not set."*
- If there are no messages in the answering system, the system announces, *"You have no message."*
- If there are no new messages in the answering system, when you press **2** to play back new messages, the system announces, *"You have no new message."*
- At the beginning of new messages playback, if the answering system has less than three minutes of recording time left, the answering system announces, *"Less than three minutes to record."* If the memory is full, the answering system announces, *"Memory is full."*
- If you pause for more than four seconds during remote access, you hear a help menu listing all features and commands. If there is no command for another 20 seconds, the call ends automatically.
- If the memory is full, the answering system answers after 10 rings and announces, *"Memory is full. Enter the remote access code."* Enter your remote access code to access the messages and announcements.
- When the answering system is turned off, the telephone answers after 10 rings, and announces, *"Please enter your remote access code."*

Adding and registering a handset

Your telephone can support up to five cordless handsets (AT&T model TL30100, sold separately). The handset needs to register with the telephone base before use. You must register each handset separately.

The handsets provided within your product box are already registered as **HANDSET 1** and so forth. Additional handset are assigned numbers in the order they are registered (**HANDSET 2** to **HANDSET 5**).

When first purchased, all expansion handsets alternately show **1.Press HS LOC on Base 4 sec** and **2.Then press # on Handset** on the screen. The new handset should be charged without interruption for at least 30 minutes before registering to the telephone base.

To register a handset to your telephone base:

1. Make sure the handset is out of the telephone base or charger and alternately shows **1.Press HS LOC on Base 4 sec** and **2.Then press # on Handset** before you begin the registration.
2. Press and hold  **HANDSET LOCATOR** on the telephone base for about four seconds (until the **IN USE** light on the telephone base is on) and then release the button.
3. Press **#** on the handset. The screen shows **Registering...Please wait**. It takes up to 60 seconds to complete the registration. **Handset registered** and then **HANDSET X** appears on the screen, with **X** being the handset number (1-5) and the handset beeps. The handset is now registered with the telephone base.

If the registration is not successful, the handset screen shows **Registration failed**. Please start again from steps 1-3 above.

 **NOTE:** You cannot register a handset if any other system handset is in use.

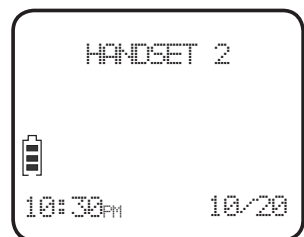
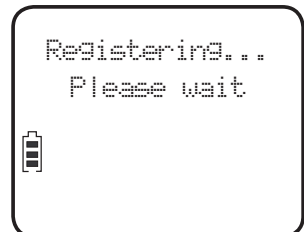
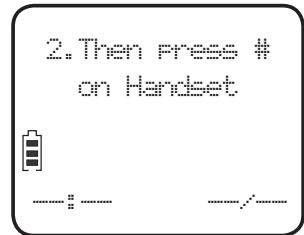
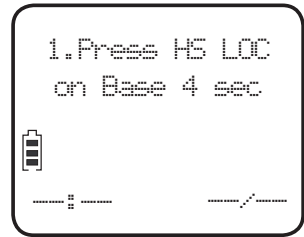

Deregistering all handsets

You can deregister handsets. You may need to deregister your handsets if:

- You have five registered handsets and need to replace a handset.





-OR-

- You wish to change the designated handset number of your registered handsets.

You must first deregister ALL the handsets, and then register each handset you wish to use again, one at a time.

Please read carefully through all the instructions on this page before beginning the deregistration process.

To deregister all handsets:

1. Press and hold  **HANDSET LOCATOR** on the telephone base for about 10 seconds (until the **IN USE** light starts to flash), then release the  **HANDSET LOCATOR** button.
2. Immediately press  **HANDSET LOCATOR** again. You must press  **HANDSET LOCATOR** while the **IN USE** light is still flashing. (The light flashes for about seven seconds. If the light stops flashing, start again with step 1 above.)
3. It takes up to 60 seconds to complete the deregistration process. The handset screen alternately shows **1.Press HS LOC on Base 4 sec** and **2.Then press # on Handset** to wait for re-registration.

To re-register the handset(s) to the telephone base, follow the registration instructions in **Adding and registering a handset** on page 60.

NOTES:



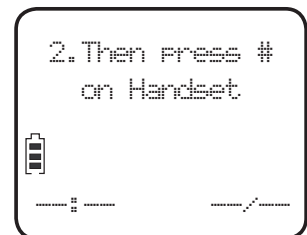
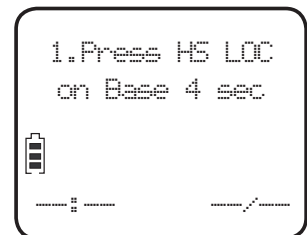
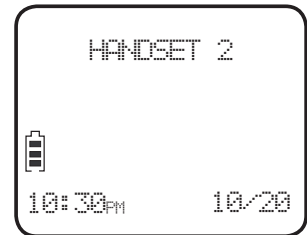





- If the deregistration process is not successful, you might need to reset the system and try again. To reset: You may reset by unplugging the power from the telephone base and plugging it back in.
- You cannot deregister the handset(s) if any other system handset is in use.



Screen icons, indicator lights and alert tones

Screen icons

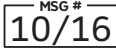

 (flashing)	Low battery; place the handset in the telephone base or charger to recharge.
	Indicates the battery voltage level.
 (animated display) or  (animated display)	Battery is charging.
	The speakerphone is in use.
	The handset ringer is turned off.
	New voicemail received from the telephone service provider.
	New message in the answering system.
	While playing messages, the sequence of the message currently playing. (XX/YY; XX is the sequence of the message currently playing; YY is the total number of all new or old messages.)
ANS ON	Answering system is turned on.
AUDIO ASSIST	The audio assist feature is on.
MUTE	Microphone is muted.
NEW	While reviewing the caller ID history, missed calls that have not been reviewed.

Screen icons, indicator lights and alert tones

Handset indicator lights



Visual ringer light
Flashes when there is an incoming call or the telephone base is paging all handsets.

CHARGE light
On when the handset is charging in the telephone base or charger.

Backlight (lighted display and dial pad)
On when a call is coming in.
On when a key is pressed.

SPEAKER light
On when the speakerphone is in use.

Telephone base indicator lights



Visual ringer light
Flashes when there is an incoming call.

IN USE light
On when the handset is in use, when the answering system is answering an incoming call, when the answering system is being accessed remotely, or when the telephone base is registering a handset.

Flashes slowly when another telephone on the same line is in use or when the telephone is deregistering all handsets.
Flashes quickly when there is an incoming call.

ANS ON/OFF light
On when the built-in answering system is on.

Screen icons, indicator lights and alert tones

Handset alert tones

One short beep (Key tone or playback confirmation tone)	A key is pressed. Plays at the end of each message.
One long beep (Recording or playback confirmation tone)	Start or end recording. Plays at the end of all messages.
Two short beeps (Error tone)	Command has failed. You have reached the beginning or end of the list. You have reached the minimum or maximum listening volume.
Three short beeps (Out-of-range or no-power-at-base warning tone)	The handset is out of range, failed to register to the telephone base or there is no power at the telephone base.
Three short high-pitched beeps (Confirmation tone)	The telephone has completed the command successfully.
Four short beeps (Low-battery warning tone)	Low battery warning.

Telephone base alert tones

One short beep (Playback confirmation tone)	Plays at the end of each message.
Beeps every 10 seconds (Message alert tone)	Message alert.
One long beep (Recording or playback confirmation tone)	The answering system starts recording a message if call screening is on. Plays at the end of all messages.

Handset display screen messages

1.Press HS LOC on Base 4 sec (alternately display) 2.Then press # on Handset	The handset has not been registered to the telephone base.
Audio assist off	The audio assist feature is off.
Audio assist on	The audio assist feature is on.
Call log empty	You are accessing an empty caller ID history.
Call transferred	If you have more than one handset, you have transferred an outside call to another cordless handset.
Calling HANDSET X	<ul style="list-style-type: none"> • If you have more than one handset, the handset is calling another handset (for intercom calls). • If you have more than one handset, the handset is going to transfer an outside call to another handset.
Directory empty	There are no directory entries.
Directory full	The directory is full. You cannot save any new entries unless you delete some current entries.
Ended	You have just ended a call.
HANDSET X is calling	If you have more than one handset, another handset is calling.
Incoming call	There is a call coming in.
Intercom	If you have more than one handset, the handset is on an intercom call.
Intercom ended	If you have more than one handset, the intercom call has just ended.
Intercom to:	<ul style="list-style-type: none"> • If you have more than two handset, you have started the intercom process, and need to enter the number of the handset you wish to call. • If you have more than two handset, you have started transferring a call, and need to enter the desired handset number.
Less than 3 min to record	The system has less than three minutes of recording time left.
Line in use	An extension telephone on the same line or one of the handsets is in use (if you have more than one handset)
LOW BATTERY	The battery needs to be charged.

Handset display screen messages

Microphone on	Mute is off so the other party can hear your voice.
Muted	The microphone is off.
New voicemail	There are new voicemail messages from your telephone service provider.
No battery	You place the handset in the telephone base or charger without installing a battery in that handset.
No line	There is no telephone line connected.
No message	There are no messages in the answering system.
Not available at this time	If you have more than one handset, someone else is already using the directory, speed dial list, caller ID history or answering system.
Number already saved	The telephone number you have entered is already stored in the directory.
Out of range or no pwr at Base	The handset has lost communication with the telephone base.
** Paging **	The telephone base is paging all handsets.
Phone	The handset is on a call.
PLACE IN CHARGER	The battery is very low. The handset should be placed in the telephone base or charger.
Rec mem full	The answering system memory is full.
Registration failed	The registration is not successful.
Ringer muted	The ringer is muted temporarily during an incoming call.
Saved	The entry is now in the directory.
Speaker	The handset speakerphone is in use.
Unable to call. Try again	<ul style="list-style-type: none"> • If you have more than one handset, failed intercom or two handsets are already on a call. • While the handset is on a call, it is out of range or there is no power at the telephone base.
Unable to save	You cannot save a caller ID history entry to the directory without a name and number.
XX missed calls	There are new calls in the caller ID history.
XX new messages	There are new messages in the answering system.

Troubleshooting

If you have difficulty with your telephone, please try the suggestions below. For customer service, or to purchase accessories or replacement parts, visit our website at **www.telephones.att.com**, or call **1 (800) 222-3111**. In Canada, dial **1 (866) 288-4268**. When you call customer service, you will need the serial number or model number found on the bottom of the telephone base.

My telephone doesn't work at all.

- Make sure the power cord is securely plugged in.
- Make sure that the battery connector is securely plugged into the cordless handset.
- Make sure the telephone line cord is securely and firmly plugged into the telephone base and the telephone wall jack.
- Charge the battery in the cordless handset for at least 16 hours. For optimum daily performance, return the cordless handset to the telephone base or charger when not in use.
- If the battery is depleted, it may take approximately 30 minutes to charge the handset before it shows **LOW BATTERY**, refer to **Battery charging** on page 7 for details.
- Reset the telephone base. Unplug the electrical power. Wait for approximately 15 seconds, then plug it back in. Allow up to one minute for the cordless handset and telephone base to reset.
- You may need to purchase a new battery. Please refer to **Battery installation** on page 6.

I cannot get a dial tone.

- First try all the suggestions above.
- Move the cordless handset closer to the telephone base. You might have moved out of range.
- If the previous suggestions don't work, disconnect the telephone base from the telephone wall jack and connect to a different telephone. If there is no dial tone on that telephone either, the problem is in your wiring or telephone service. Contact your telephone service provider (charges may apply).
- Your telephone line cord might be malfunctioning. Try installing a new telephone line cord.

I cannot dial out.

- First try all the suggestions in the item **I cannot get a dial tone** on this page.
- Make sure you have a dial tone before dialing. The cordless handset may take a second or two to find the telephone base and produce a dial tone. This is normal. Wait an extra second before dialing.

Troubleshooting

- Check that all the telephones connected to the same telephone line are hung up.
- Make sure to set the dial mode to the correct setting (pulse dialing or tone dialing) for the service in your area (see **Dial mode** on page 16).
- Eliminate any background noise. Noise from a television, radio or other appliances may cause the telephone to not dial out properly. If you cannot eliminate the background noise, first try muting the cordless handset before dialing, or dialing from another room in your home with less background noise.
- If the other telephones in your home are having the same problem, the problem is in your wiring or telephone service. Contact your telephone service provider (charges may apply).

My cordless handset isn't performing normally.

- Make sure the power cord is securely plugged into the telephone base. Plug the power adapter into a different, working electrical outlet not controlled by a wall switch.
- Move the cordless handset closer to the telephone base. You might have moved out of range.
- Reset the telephone base. Unplug the electrical power. Wait for 15 seconds then plug it back in. Allow up to one minute for the cordless handset and telephone base to reset.
- Other electronic products such as HAM Radios and other DECT Phones can cause interference with your cordless telephone. Try installing your telephone as far away as possible from these types of electronic devices.

Out of range or no pwr at Base appears on my cordless handset.

- Ensure that the telephone base is powered up.
- Place the cordless handset in the telephone base for one minute to allow the cordless handset and base to synchronize.
- Move the cordless handset closer to the telephone base. You might have moved out of range.
- Reset the telephone base. Unplug the electrical power. Wait for 15 seconds then plug it back in. Allow up to one minute for the cordless handset and telephone base to reset.
- Other electronic products such as HAM Radios and other DECT Phones can cause interference with your cordless telephone. Try installing your telephone as far away as possible from these types of electronic devices.

Troubleshooting

The batteries do not hold a charge.

- If the cordless handset is in the telephone base or charger and the charge light does not come on, refer to the item **The charge light is off** on this page.
- Charge the battery in the cordless handset for at least 16 hours. For optimum daily performance, return the cordless handset to the telephone base or charger when not in use.
- If the battery is depleted, it may take approximately 30 minutes to charge the handset before it shows **LOW BATTERY**, refer to **Battery charging** on page 7 for details.
- You may need to purchase a new battery. Please refer to **Battery installation** on page 6.

The charge light is off.

- Make sure the power cord is plugged in correctly and securely.
- Make sure the battery is installed correctly in the handset. Follow the instructions in **Battery installation** on page 6 to install the battery.
- Unplug the electrical power. Wait for 15 seconds, then plug it back in. Allow up to one minute for the cordless handset and telephone base to reset.
- Clean the cordless handset and telephone base charging contacts each month using a pencil eraser or cloth.

I get noise, static, or weak signals even when I'm near the telephone base.

- If you subscribe to high-speed Internet service (digital subscriber line - DSL) through your telephone line, you must install a DSL filter between the telephone line cord and the telephone wall jack (see **Telephone base and charger installation** on page 5). The filter prevents noise and caller ID problems caused by DSL interference. Please contact your DSL service provider for more information about DSL filters.
- Other electronic products such as HAM Radios and other DECT Phones can cause interference with your cordless telephone. You may be able to improve the performance of your telephone by installing your telephone as far away as possible from these types of electronic devices.
- Do not install this telephone near a microwave oven or on the same electrical outlet. You may experience decreased performance while the microwave oven is operating.
- If your telephone is plugged in with a modem or a surge protector, plug the telephone (or modem/surge protector) into a different location. If this doesn't solve the problem, relocate your telephone or modem farther apart from one another, or use a different surge protector.
- Relocate your telephone to a higher location. The telephone will likely have better reception when installed in a high area.

Troubleshooting

- If the other telephones in your home are having the same problem, the problem is in your wiring or telephone service. Contact your telephone service provider (charges may apply).

I experience poor sound quality when using the speakerphone.

- For increased sound quality while using the speakerphone, place the handset on a flat surface with the dial pad facing up.
- When using a speakerphone, controlling background noise in your environment is essential. While you are listening to your party, press **MUTE/REMOVE** to temporarily turn your microphone off. When it is your turn to speak, remember to press **MUTE/REMOVE** again to turn the microphone on.
- Excessive background noise will cause a speakerphone to fade in and out. Try controlling the background noise by turning off any audio devices near the speakerphone. Also, try to avoid interrupting the person at the other end of the conversation while they are speaking. If background noise cannot be controlled, you should terminate speakerphone operation and return to normal handset mode.

I hear other calls while using my telephone.

- Disconnect the telephone base from the telephone wall jack, and plug in a different telephone. If you still hear other calls, the problem is probably in your wiring or telephone service. Call your telephone service provider (charges may apply).

My calls cut in and out while I'm using my cordless handset.

- Other electronic products such as HAM Radios and other DECT Phones can cause interference with your cordless telephone. Try installing your telephone as far away as possible from these types of electronic devices.
- Move the handset closer to the base. The operating range may vary with environmental conditions and time of use. There may be places within your environment that a cordless telephone will not work well. If the problem only occurs in certain areas of your environment, you can conclude that there is nothing wrong with the telephone.
- Do not install this telephone near a microwave oven or on the same electrical outlet. You may experience decreased performance while the microwave oven is operating.
- If your telephone is plugged in with a modem or surge protector, plug the telephone (or modem/surge protector) into a different location. If this doesn't solve the problem, relocate your telephone or modem farther apart from one another, or use a different surge protector.
- Relocate your telephone base to a higher location. The telephone will have better reception when installed in a high area.

Troubleshooting

- If the other telephones in your home are having the same problem, the problem is in your wiring or telephone service. Contact your telephone service provider (charges may apply).
- If you subscribe to high-speed Internet service (digital subscriber line - DSL) through your telephone line, you must install a DSL filter between the telephone line cord and the telephone wall jack (see **Telephone base and charger installation** on page 5). The filter prevents noise and caller ID problems caused by DSL interference. Please contact your DSL service provider for more information about DSL filters.

My cordless handset does not ring when I receive a call.

- Make sure that the ringer is not turned off. Refer to **Ringer volume** on page 12.
- Make sure the telephone line cord is plugged securely into the telephone base and the telephone wall jack. Make sure the power cord is securely plugged in.
- The cordless handset may be too far from the telephone base.
- Charge the battery in the cordless handset for at least 16 hours. For optimum daily performance, return the cordless handset to the telephone base or charger when not in use.
- You may have too many extension telephones on your telephone line to allow all of them to ring simultaneously. Try unplugging one telephone at a time until the telephone start ringing.
- The layout of your home or office might be limiting the operating range. Try moving the telephone base to another location, preferably on an upper floor.
- If the other telephones in your home are having the same problem, the problem is in your wiring or telephone service. Contact your telephone service provider (charges may apply).
- Test a working telephone at the telephone wall jack. If another telephone has the same problem, the problem is the telephone wall jack. Contact your telephone service provider (charges may apply).
- Other electronic products such as HAM Radios and other DECT Phones can cause interference with your cordless telephone. Try installing your telephone as far away as possible from these types of electronic devices.
- Completely remove then replace the battery. Place the cordless handset in the telephone base. Wait for the cordless handset to reestablish its connection with the telephone base. Allow up to one minute for this to take place.
- Your telephone line cord might be malfunctioning. Try installing a new telephone line cord.

Troubleshooting

My caller ID isn't working.

- Caller ID is a subscription service. You must subscribe to this service from your telephone service provider for this feature to work on your telephone.
- Your caller must be calling from an area that supports caller ID.
- Both your and your caller's telephone service providers must use caller ID compatible equipment.
- Make sure the home area code is set correctly in the telephone (see **Home area code** on page 15).
- If you subscribe to high-speed Internet service (digital subscriber line - DSL) through your telephone line, you must install a DSL filter between the telephone line and the telephone wall jack (see **Telephone base and charger installation** on page 5). The filter prevents noise and caller ID problems caused by DSL interference. Please contact your DSL service provider for more information about DSL filters.

My telephone does not receive caller ID when on a call.

- Make sure you subscribe to caller ID with call waiting features provided by your telephone service provider. Caller ID features work only if both you and the caller are in areas offering caller ID service, and if both telephone service providers use compatible equipment.

A icon shows on the display and I don't know why.

- Your telephone has voicemail indication that is separate from the built-in answering system. If  appears on the display, then your telephone has received a signal from your telephone service provider that you have a voicemail message waiting for you to retrieve from your telephone service provider. Contact your telephone service provider for more information on how to access your voicemail.

I cannot retrieve voicemail messages.

- Your telephone has both a built-in answering system and voicemail indication. They are independent features and each alerts you to new messages differently (see **About answering system and voicemail** on page 50). If you subscribe to voicemail service from your telephone service provider (charges may apply), contact your telephone service provider for more information on how to access your voicemail.

Incomplete messages.

- If a caller leaves a very long message, part of it may be lost when the answering system disconnects the call after the recording time you set (see **Recording time** on page 21).

Troubleshooting

- If the caller pauses for longer than seven seconds, the answering system stops recording and disconnects the call.
- If the answering system's memory becomes full during a message, the answering system announces, "Memory is full." The answering system stops recording and disconnects the call.
- If the caller's voice is very soft, the answering system may stop recording and disconnects the call.
- If someone picks up the call at a telephone on the same line during a message, the answering system stops recording and disconnects the call. Part of the message may be lost.

Difficulty hearing messages.

- Press **▲▼VOLUME** to adjust the speaker volume on the telephone base.
- Press **▲DIR/VOLUME** to increase the message playback volume on a handset.

The answering system does not answer after correct number of rings.

- Make sure the answering system is on. When the answering system is on, **ANS ON** should show on the handset and the **⓪ ANS ON** light is lit on the telephone base (see **Answering mode** on page 18).
- If toll saver is selected, the number of rings changes to two when there are new messages (see **Number of rings** on page 20).
- If the memory is full or the answering system is off, the answering system answers after 10 rings.
- In some cases, the answering system is affected by the ringing system used by the telephone service provider.
- If you subscribe to voicemail service, change the number of rings so that your answering system answers before your voicemail answers (see **About answering system and voicemail** on page 50). To determine how many rings activate your voicemail, contact your telephone service provider.
- If there is a fax machine connected to the same telephone line, try disconnecting the fax machine. If that solves the problem, consult your fax machine documentation for information on compatibility with answering systems.

The answering system announces "Time and date not set."

- You need to reset the date and time (see **Set date/time** on page 14).

Troubleshooting

The answering system does not respond to remote commands.

- Make sure to enter your remote access code correctly (see **Remote access** on page 58).
- Make sure you are calling from a touch-tone telephone. When you dial a number, you should hear tones. If you hear clicks, the telephone is not a touch-tone telephone and cannot activate the answering system.
- The answering system may not detect the remote access code while your announcement is playing. Try waiting until the announcement is over before entering the code.
- There may be interference on the telephone line you are using. Press dial pad keys firmly.

The answering system does not record messages.

- Make sure the answering system is on (see **Answering mode** on page 18).
- Make sure the memory of the answering system is not full. When the answering machine memory is full, it does not record new messages until some old messages are deleted.
- If you subscribe to voicemail service, change the number of rings so that your answering system answers before your voicemail answers (see **About answering system and voicemail** on page 50). To determine how many rings activate your voicemail, contact your telephone service provider.
- If there is a fax machine connected to the same telephone line, try disconnecting the fax machine. If that solves the problem, consult your fax machine documentation for information on compatibility with answering systems.

Announcement is not clear.

- When you record your announcement, make sure you speak in a normal tone of voice, towards the microphone on the handset.
- Make sure there is no background noise (TV, music, etc.) while recording.

I subscribe to a nontraditional telephone service that uses my computer to establish connections, and my telephone doesn't work.

- Make sure your computer is powered on.
- Make sure your Internet connection is working properly.
- Make sure that the software is installed and running for your nontraditional telephone service.
- Make sure to plug your USB telephone adapter into a dedicated USB port on your computer. Do not plug into a multiple port USB hub (USB splitter) that is not powered.

Troubleshooting

- In a few rare instances, the USB port on your computer may not have enough power. In these instances, try using a USB hub with its own external power supply.
- If you are using a firewall, it may prevent access to your nontraditional telephone service. Contact your service provider for more information.

Common cure for electronic equipment:

If the telephone is not responding normally, try resetting the telephone. Do the following in the order listed:

1. Disconnect the power to the telephone base.
2. Disconnect the cordless handset battery, and spare battery, if applicable.
3. Wait a few minutes.
4. Connect power to the telephone base.
5. Completely remove then replace the battery. Place the cordless handset into the telephone base.
6. Wait for the cordless handset to reestablish its connection with the telephone base. Allow up to one minute for this to take place.

Maintenance

Taking care of your telephone

- Your cordless telephone contains sophisticated electronic parts, so it must be treated with care.
- Avoid rough treatment.
- Place the handset down gently.
- Save the original packing materials to protect your telephone if you ever need to ship it.

Avoid water

- Your telephone can be damaged if it gets wet. Do not use the handset in the rain, or handle it with wet hands. Do not install the telephone base near a sink, bathtub or shower.

Electrical storms

- Electrical storms can sometimes cause power surges harmful to electronic equipment. For your own safety, take caution when using electric appliances during storms.

Cleaning your telephone

- Your telephone has a durable plastic casing that should retain its luster for many years. Clean it only with a soft cloth slightly dampened with water or mild soap.
- Do not use excess water or cleaning solvents of any kind.

Remember that electrical appliances can cause serious injury if used when you are wet or standing in water. If the telephone base should fall into water, DO NOT RETRIEVE IT UNTIL YOU UNPLUG THE POWER CORD AND TELEPHONE LINE CORDS FROM THE WALL. Then pull the telephone out by the unplugged cords.

Important safety information



This symbol is to alert you to important operating or servicing instructions that may appear in this user's manual. Always follow basic safety precautions when using this product to reduce the risk of injury, fire, or electric shock.

Safety information

- **Read and understand all instructions in the user's manual. Observe all markings on the product.**
- **Avoid using a telephone during a thunderstorm.** There might be a slight chance of electric shock from lightning.
- **Do not use a telephone in the vicinity of a gas leak.** If you suspect a gas leak, report it immediately, but use a telephone away from the area where gas is leaking. If this product is a cordless model, make sure the base is also away from the area.
- **Do not use this product near water, or when you are wet.** For example, do not use it in a wet basement or shower, or next to a swimming pool, bathtub, kitchen sink, or laundry tub. Do not use liquids or aerosol sprays for cleaning. If the product comes in contact with any liquids, unplug any line or power cord immediately. Do not plug the product back in until it has dried thoroughly.
- **Install this product in a protected location** where no one can trip over any line or power cords. Protect cords from damage or abrasion.
- **If this product does not operate normally, read Troubleshooting on page 67 in this user's manual.** If you cannot solve the problem, or if the product is damaged, refer to **Limited warranty** on page 81. Do not open this product except as may be directed in your user's manual. Opening the product or reassembling it incorrectly may expose you to hazardous voltages or other risks.
- **Replace batteries only as described in Battery installation and charging on page 6 in your user's manual.** Do not burn or puncture batteries — they contain caustic chemicals.
- **The power adapters are intended to be correctly oriented in a vertical or floor mount position.** The prongs are not designed to hold the plug in place if they are plugged into a ceiling or an under-the-table/cabinet outlet.



CAUTION: Use only the power adapters provided with this product. To obtain a replacement, visit our website at **www.telephones.att.com**, or call **1 (800) 222-3111**. In Canada, dial **1 (866) 288-4268**.

Especially about cordless telephones

- **Privacy:** The same features that make a cordless telephone convenient create some limitations. Telephone calls are transmitted between the telephone base and the handset by radio waves, so there is a possibility that your cordless telephone conversations could be intercepted by radio receiving equipment within range of the cordless handset. **For this reason, you should not think of cordless telephone conversations as being as private as those on corded telephones.**
- **Electrical power:** The telephone base of this cordless telephone must be connected to a working electrical outlet which is not controlled by a wall switch. **Calls cannot be made from the handset if the telephone base is unplugged, switched off or if the electrical power is interrupted.**

Important safety information

- **Potential TV interference:** Some cordless telephones operate at frequencies that may cause interference to TVs and VCRs. To minimize or prevent such interference, do not place the telephone base of the cordless telephone near or on top of a TV or VCR. If interference is experienced, moving the cordless telephone farther away from the TV or VCR will often reduce or eliminate the interference.
- **Rechargeable batteries:** This product contains nickel-metal hydride rechargeable batteries. Exercise care in handling batteries in order not to create a short circuit with conductive material such as rings, bracelets, and keys. The battery or conductor may overheat and cause harm. Observe proper polarity between the battery and the battery charger.
- **Nickel-metal hydride rechargeable batteries:** Dispose of these batteries in a safe manner. Do not burn or puncture. Like other batteries of this type, if burned or punctured, they could release caustic material which could cause injury.



The RBRC™ Seal means that the manufacturer is voluntarily participating in an industry program to collect and recycle nickel-metal hydride rechargeable batteries when taken out of service within the United States. These batteries may be taken to a participating local retailer of replacement batteries or recycling center. Or you may call 1 (800) 8-BATTERY for locations accepting spent Ni-MH batteries.

Precautions for users of implanted cardiac pacemakers

Cardiac pacemakers (applies only to digital cordless telephones): Wireless Technology Research, LLC (WTR), an independent research entity, led a multidisciplinary evaluation of the interference between portable wireless telephones and implanted cardiac pacemakers. Supported by the U.S. Food and Drug Administration, WTR recommends to physicians that:

Pacemaker patients

- Should keep wireless telephones at least six inches from the pacemaker.
- Should NOT place wireless telephones directly over the pacemaker, such as in a breast pocket, when it is turned ON.
- Should use the wireless telephone at the ear opposite the pacemaker.

WTR's evaluation did not identify any risk to bystanders with pacemakers from other persons using wireless telephones.

Especially about telephone answering systems

Two-way recording: This unit does not sound warning beeps to inform the other party that the call is being recorded. To ensure that you are in compliance with any federal or state regulations regarding recording a telephone call, you should start the recording process and then inform the other party that you are recording the conversation.

SAVE THESE INSTRUCTIONS

FCC Part 68 and ACTA

This equipment complies with Part 68 of the FCC rules and with technical requirements adopted by the Administrative Council for Terminal Attachments (ACTA). The label on the back or bottom of this equipment contains, among other things, a product identifier in the format US:AAAEQ##TXXXX. This identifier must be provided to your telephone service provider upon request.

The plug and jack used to connect this equipment to premises wiring and the telephone network must comply with the applicable Part 68 rules and technical requirements adopted by ACTA. A compliant telephone cord and modular plug is provided with this product. It is designed to be connected to a compatible modular jack that is also compliant. An RJ11 jack should normally be used for connecting to a single line and an RJ14 jack for two lines. See Installation Instructions in the user's manual.

The Ringer Equivalence Number (REN) is used to determine how many devices you may connect to your telephone line and still have them ring when you are called. The REN for this product is encoded as the 6th and 7th characters following the US: in the product identifier (e.g., if ## is 03, the REN is 0.3). In most, but not all areas, the sum of all RENs should be five (5.0) or less. For more information, please contact your telephone service provider.

This equipment may not be used with Party Lines. If you have specially wired alarm dialing equipment connected to your telephone line, ensure the connection of this equipment does not disable your alarm equipment. If you have questions about what will disable the alarm equipment, consult your telephone service provider or a qualified installer.

If this equipment is malfunctioning, it must be unplugged from the modular jack until the problem has been corrected. Repairs to this telephone equipment can only be made by the manufacturer or its authorized agents. For repair procedures, follow the instructions outlined under the Limited Warranty.

If this equipment is causing harm to the telephone network, the telephone service provider may temporarily discontinue your telephone service. The telephone service provider is required to notify you before interrupting service. If advance notice is not practical, you will be notified as soon as possible. You will be given the opportunity to correct the problem and the telephone service provider is required to inform you of your right to file a complaint with the FCC. Your telephone service provider may make changes in its facilities, equipment, operation, or procedures that could affect the proper functioning of this product. The telephone service provider is required to notify you if such changes are planned.

If this product is equipped with a corded or cordless handset, it is hearing aid compatible.

If this product has memory dialing locations, you may choose to store emergency telephone numbers (e.g., police, fire, medical) in these locations. If you do store or test emergency numbers, please:

- Remain on the line and briefly explain the reason for the call before hanging up.
- Perform such activities in off-peak hours, such as early morning or late evening.

Industry Canada

Operation is subject to the following two conditions: (1) this device may not cause harmful interference, and (2) this device must accept any interference, including interference that may cause undesired operation.

The term "IC:" before the certification/registration number only signifies that the Industry Canada technical specifications were met.

The Ringer Equivalence Number (REN) for this terminal equipment is 0.1B. The REN is an indication of the maximum number of devices allowed to be connected to a telephone interface. The termination on an interface may consist of any combination of devices subject only to the requirement that the sum of the RENs of all the devices does not exceed five.

This product meets the applicable Industry Canada technical specifications.

FCC Part 15

This equipment has been tested and found to comply with the requirements for a Class B digital device under Part 15 of the Federal Communications Commission (FCC) rules.

These requirements are intended to provide reasonable protection against harmful interference in a residential installation. This equipment generates, uses and can radiate radio frequency energy and, if not installed and used in accordance with the instructions, may cause harmful interference to radio communications. However, there is no guarantee that interference will not occur in a particular installation.

If this equipment does cause harmful interference to radio or television reception, which can be determined by turning the equipment off and on, the user is encouraged to try to correct the interference by one or more of the following measures:

- Reorient or relocate the receiving antenna.
- Increase the separation between the equipment and receiver.
- Connect the equipment into an outlet on a circuit different from that to which the receiver is connected.
- Consult the dealer or an experienced radio/TV technician for help.

Changes or modifications to this equipment not expressly approved by the party responsible for compliance could void the user's authority to operate the equipment.

This device complies with Part 15 of the FCC rules. Operation is subject to the following two conditions: (1) this device may not cause harmful interference, and (2) this device must accept any interference received, including interference that may cause undesired operation. Privacy of communications may not be ensured when using this telephone.

To ensure safety of users, the FCC has established criteria for the amount of radio frequency energy that can be safely absorbed by a user or bystander according to the intended usage of the product. This product has been tested and found to comply with the FCC criteria. The handset may be safely held against the ear of the user. The telephone base shall be installed and used such that parts of the user's body other than the hands are maintained at a distance of approximately 20cm (8 inches) or more.

This Class B digital apparatus complies with Canadian ICES-003.

Limited warranty

The AT&T brand is used under license - any repair, replacement or warranty service, and all questions about this product should be directed to our website at

www.telephones.att.com or call **1 (800) 222-3111**. In Canada, dial **1 (866) 288-4268**.

1. What does this limited warranty cover?

The manufacturer of this AT&T-branded product warrants to the holder of a valid proof of purchase ("CONSUMER" or "you") that the product and all accessories provided in the sales package ("PRODUCT") are free from defects in material and workmanship, pursuant to the following terms and conditions, when installed and used normally and in accordance with the PRODUCT operating instructions. This limited warranty extends only to the CONSUMER for products purchased and used in the United States of America and Canada.

2. What will be done if the PRODUCT is not free from defects in materials and workmanship during the limited warranty period ("materially defective PRODUCT")?

During the limited warranty period, the manufacturer's authorized service representative repairs or replaces at the manufacturer's option, without charge, a materially defective PRODUCT. If the manufacturer repairs the PRODUCT, they may use new or refurbished replacement parts. If the manufacturer chooses to replace the PRODUCT, they may replace it with a new or refurbished PRODUCT of the same or similar design. The manufacturer retains the defective parts, modules, or equipment. Repair or replacement of the PRODUCT, at the manufacturer's option, is your exclusive remedy. The manufacturer returns the repaired or replacement products to you in working condition. You should expect the repair or replacement to take approximately 30 days.

3. How long is the limited warranty period?

The limited warranty period for the PRODUCT extends for ONE (1) YEAR from the date of purchase. If the manufacturer repairs or replaces a materially defective PRODUCT under the terms of this limited warranty, this limited warranty also applies to repaired or replacement PRODUCT for a period of either (a) 90 days from the date the repaired or replacement PRODUCT is shipped to you or (b) the time remaining on the original one-year limited warranty; whichever is longer.

4. What is not covered by this limited warranty?

This limited warranty does not cover:

- PRODUCT that has been subjected to misuse, accident, shipping or other physical damage, improper installation, abnormal operation or handling, neglect, inundation, fire, water, or other liquid intrusion; or
- PRODUCT that has been damaged due to repair, alteration, or modification by anyone other than an authorized service representative of the manufacturer; or
- PRODUCT to the extent that the problem experienced is caused by signal conditions, network reliability or cable or antenna systems; or
- PRODUCT to the extent that the problem is caused by use with non-AT&T accessories; or
- PRODUCT whose warranty/quality stickers, PRODUCT serial number plates or electronic serial numbers have been removed, altered or rendered illegible; or
- PRODUCT purchased, used, serviced, or shipped for repair from outside the United States of America or Canada, or used for commercial or institutional purposes (including but not limited to products used for rental purposes); or
- PRODUCT returned without a valid proof of purchase (see item 6 below); or
- Charges for installation or setup, adjustment of customer controls, and installation or repair of systems outside the unit.

Limited warranty

5. How do you get warranty service?

To obtain warranty service in the United States of America, visit

www.telephones.att.com or call **1 (800) 222-3111**. In Canada, dial **1 (866) 288-4268**. NOTE: Before calling for service, please review the user's manual. A check of the PRODUCT's controls and features might save you a service call.

Except as provided by applicable law, you assume the risk of loss or damage during transit and transportation and are responsible for delivery or handling charges incurred in the transport of the PRODUCT(s) to the service location. The manufacturer will return repaired or replaced PRODUCT under this limited warranty. Transportation, delivery or handling charges are prepaid. The manufacturer assumes no risk for damage or loss of the PRODUCT in transit. If the PRODUCT failure is not covered by this limited warranty, or proof of purchase does not meet the terms of this limited warranty, the manufacturer notifies you and requests that you authorize the cost of repair prior to any further repair activity. You must pay for the cost of repair and return shipping costs for the repair of products that are not covered by this limited warranty.

6. What must you return with the PRODUCT to get warranty service?

You must:

- a. Return the entire original package and contents including the PRODUCT to the service location along with a description of the malfunction or difficulty; and
- b. Include a "valid proof of purchase" (sales receipt) identifying the PRODUCT purchased (PRODUCT model) and the date of purchase or receipt; and
- c. Provide your name, complete and correct mailing address, and telephone number.

7. Other limitations

This warranty is the complete and exclusive agreement between you and the manufacturer of this AT&T branded PRODUCT. It supersedes all other written or oral communications related to this PRODUCT. The manufacturer provides no other warranties for this PRODUCT. The warranty exclusively describes all of the manufacturer's responsibilities regarding the PRODUCT. There are no other express warranties. No one is authorized to make modifications to this limited warranty and you should not rely on any such modification.

State/Provincial Law Rights: This warranty gives you specific legal rights, and you might also have other rights that vary from state to state or province to province.

Limitations: Implied warranties, including those of fitness for a particular purpose and merchantability (an unwritten warranty that the PRODUCT is fit for ordinary use) are limited to one year from date of purchase. Some states/provinces do not allow limitations on how long an implied warranty lasts, so the above limitation might not apply to you. In no event shall the manufacturer be liable for any indirect, special, incidental, consequential, or similar damages (including, but not limited to lost profits or revenue, inability to use the PRODUCT or other associated equipment, the cost of substitute equipment, and claims by third parties) resulting from the use of this PRODUCT. Some states/provinces do not allow the exclusion or limitation of incidental or consequential damages, so the above limitation or exclusion might not apply to you.

Please retain your original sales receipt as proof of purchase.

Technical specifications

RF frequency band	1921.536MHz — 1928.448MHz
Channels	5
Operating temperature	32°F — 122°F 0°C — 50°C
Telephone base voltage (AC voltage, 60Hz)	96 — 130Vrms
Telephone base voltage (DC adapter output)	DC6V @400mA
Handset voltage	DC2.4
Charger voltage (AC adapter output)	AC6V @300mA
Operating times*	Talk time (handset): up to seven hours Talk time (speakerphone): up to five hours Standby: up to seven days

* Operating time varies depending on your actual use and the age of the battery.

DECT 6.0 digital technology

The AT&T DECT 6.0 products offer superior quality of voice and sound, high protection against wiretapping and better range than 2.4GHz and 5.8GHz phone systems, while not interfering with wireless routers. This is achieved through a unique antenna design and advances in noise filtering technology. An independent laboratory has confirmed that AT&T DECT 6.0 products perform up to 45% better in range competitions. Now calls can be taken in the basement, backyard and garage with exceptional sound quality.

Telephone operating range

This cordless telephone operates within the maximum power allowed by the Federal Communications Commission (FCC). Even so, this handset and telephone base can communicate over only a certain distance — which can vary with the locations of the telephone base and handset, the weather, and the construction of your home or office.

Index

A

Alert tones, 64
Alphabetical search, 39
Announcement, 17
Answer a call, 24
Answer an incoming call during an intercom call, 33
Answering mode, 18
Answering system, 50–59
Answering system and voicemail, 50
Answering system settings, 17–21
Any key answer, 24
Area code, 15, 44, 47
Audio assist, 17, 28, 52, 54
Auto off, 24

B

Base ringer volume (ringer volume control), 22
Base volume control, 51, 54
Battery charging, 7
Battery installation, 6

C

Caller ID, 44
Caller ID history (call log), 45–49
Call intercept, 52
Call screening, 19, 51
Call transfer (intercom transfer), 34
Call waiting, 27, 44
Chain dialing, 29
Character chart, 38
Charger installation, 5
CID time synchronization, 15
Clock, 14

D

Date and time, 14
Delete all entries from caller ID history, 48
Delete messages, 54, 58
Deregistering all handsets, 61
Dial a directory number, 41
Dial a number from caller ID history, 48
Dial a redial list number, 25
Dial a speed dial number, 43
Dialing options, 47
Dial mode, 16
Directory, 36–41
Directory storage, 37
Display dial, 25, 41, 48
Display screen messages, 65
DSL filter, 5, 8

E

Elapsed time, 23
End a call, 24
Equalizer, 17, 28, 52, 54

F

Flash, 27

H

Handset locator, 31
Handset ringer tone (selectable ringer tone), 12
Handset ringer volume (ringer volume control), 12
Handset volume control, 17, 27, 52, 54

Index

I

Important safety information, 77

Indicator lights, 63

Intercom call (intercom between handsets), 32

K

Key tone, 14

L

Language, 12

Limited warranty, 81

M

Maintenance, 76

Make a call, 23

Memo, 56

Memory match, 45

Menu, 11–22

Message alert tone, 21

Message playback, 53

Message window displays, 57

Missed (new) call indicator, 46, 47

Mute, 27

N

Number of rings, 20, 50

O

Operation time, 83

P

Pause, 23, 37

Power adapter, 5

Predialing (on hook dialing), 23

R

Reasons for missing caller ID information, 46

Recording time, 21, 51

Redial, 25

Registering a handset, 60

Remote access, 58

Remote access code, 20

Remote commands, 58

Repeat messages, 54, 58

Ring tone, 12

S

Screen icons, 62

Skip messages, 54, 58

Slow message playback, 54

Speakerphone

switching, 17, 24, 52, 54

Speed dial, 42–43

T

Tabletop installation, 5

Technical specifications, 83

Temporary ringer silencing, 23

Temporary tone dialing, 28

Three-way conversation, 30, 35

Toll saver, 20

Troubleshooting, 67

V

Voicemail, 13, 50

Voice prompts, 51

Volume, 12, 17, 22, 27, 51, 52, 54

W

Wall mount installation, 8

Website, 16

Remote access wallet card

The wallet card below lists the commands needed to control your answering system from any touch-tone telephone.

Cut along dotted line.



Call your telephone number, then enter your two-digit remote access code (preset to **19**).

Action	Remote command
Play all messages	1
Play new messages.....	2
Delete the message	3 (during message playback)
Delete all old messages	33
Repeat or go back	4
Stop.....	5
Help menu	*5
Skip the message	6
Record announcement	*7
End remote access call	8 (or hang up)
Turn system on or off	0

TL32100/TL32200/TL32300 DECT 6.0 cordless telephone/answering system with caller ID/call waiting

Fold here.

© 2010 Advanced American Telephones. All Rights Reserved. AT&T and the AT&T logo are trademarks of AT&T Intellectual Property licensed to Advanced American Telephones, San Antonio, TX 78219. Printed in China.



Proud Sponsor

www.telephones.att.com

Audio assist™ is a trademark of Advanced American Telephones.

© 2010 Advanced American Telephones. All Rights Reserved.
AT&T and the AT&T logo are trademarks of AT&T Intellectual Property licensed to
Advanced American Telephones, San Antonio, TX 78219.
Printed in China. Issue 1 AT&T 02/10.