

# vtech®

Innovation Beyond Technology<sup>sm</sup>

## User's manual

[www.vtechphones.com](http://www.vtechphones.com)



Models:  
CS6114/CS6114-2

**DECT 6.0**

# Congratulations

on purchasing your new VTech product. Before using this telephone, please read the **Important safety instructions** on page 39 of this manual.

This manual has all the feature operations and troubleshooting necessary to install and operate your new VTech telephone. Please review this manual thoroughly to ensure proper installation and operation of this innovative and feature rich VTech product. For support, shopping, and everything new at VTech, visit our website at [www.vtechphones.com](http://www.vtechphones.com). In Canada, please visit [www.vtechcanada.com](http://www.vtechcanada.com).



The ENERGY STAR<sup>®</sup> program ([www.energystar.gov](http://www.energystar.gov)) recognizes and encourages the use of products that save energy and help protect our environment. We are proud to mark this product with the ENERGY STAR<sup>®</sup> label indicating it meets the latest energy efficiency guidelines.



Telephones identified with this logo have reduced noise and interference when used with most T-coil equipped hearing aids and cochlear implants. The TIA-1083 Compliant Logo is a trademark of the Telecommunications Industry Association. Used under license.

# Table of contents

<b>Getting started</b> . . . . .	<b>1</b>	Alphabetical search . . . . .	21
Parts checklist . . . . .	1	Dial a directory entry . . . . .	21
Telephone base installation . . . . .	2	Edit a directory entry . . . . .	22
Wall mounting. . . . .	3	Delete a directory entry . . . . .	22
Battery installation . . . . .	4	Speed dial . . . . .	23
Battery charging. . . . .	5	Add a speed dial entry . . . . .	23
Handset layout . . . . .	6	Dial a speed dial number . . . . .	24
Telephone base layout . . . . .	8	Delete a speed dial entry . . . . .	24
<b>Telephone settings</b> . . . . .	<b>9</b>	About caller ID . . . . .	25
Ringer volume . . . . .	9	Call log . . . . .	26
Ringer tone. . . . .	9	Missed calls indicator . . . . .	26
LCD language . . . . .	10	Memory match . . . . .	27
Clear voicemail. . . . .	10	Review the call log . . . . .	27
Key tone . . . . .	11	View dialing options . . . . .	28
Set date and time . . . . .	11	Dial a call log number. . . . .	28
CID time synchronization . . . . .	12	Save a call log entry to the directory . . . . .	29
Home area code. . . . .	12	Delete from the call log . . . . .	29
Dial mode . . . . .	13	Call log display screen messages	30
Website. . . . .	13	<b>Appendix</b> . . . . .	<b>31</b>
<b>Telephone operation</b> . . . . .	<b>14</b>	Screen display messages . . . . .	31
Make a call . . . . .	14	Handset and telephone base indicators . . . . .	32
Predial a call. . . . .	14	Handset screen icons . . . . .	32
Answer a call . . . . .	14	Battery . . . . .	33
End a call . . . . .	14	Troubleshooting . . . . .	34
Volume . . . . .	14	Important safety instructions . . . . .	39
Share an outside call . . . . .	14	Precautions for users of implanted cardiac pacemakers . . . . .	40
Call waiting. . . . .	14	Operating range . . . . .	40
Temporary ringer silencing. . . . .	15	Maintenance. . . . .	40
Temporary tone dialing. . . . .	15	About cordless telephones. . . . .	41
Find handset. . . . .	15	The RBRC® seal. . . . .	41
Chain dialing. . . . .	16	Warranty. . . . .	42
Redial list . . . . .	17	FCC, ACTA and IC regulations . . . . .	44
Review the redial list . . . . .	17	Technical specifications . . . . .	46
Dial a redial entry . . . . .	17	<b>Index</b> . . . . .	<b>47</b>
Delete a redial entry. . . . .	17		
Directory. . . . .	18		
Add a directory entry . . . . .	19		
Character chart . . . . .	20		
Review the directory. . . . .	21		

# Getting started

## Parts checklist

Your telephone contains the following items. Save your sales receipt and original packaging in the event warranty service is necessary.



Handset

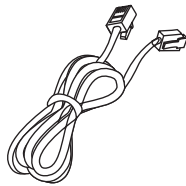

Telephone line cord

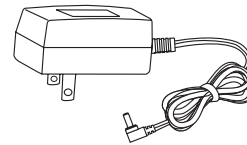

Telephone base power adapter



Battery compartment cover



Battery

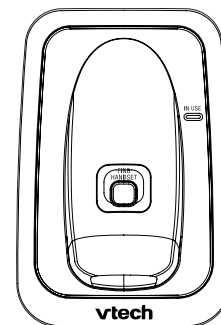

Telephone base



User's manual

**note**

To purchase a replacement battery or power adapter, visit our website at [www.vtechphones.com](http://www.vtechphones.com) or call 1 (800) 595-9511. In Canada, go to [www.vtechcanada.com](http://www.vtechcanada.com) or dial 1 (800) 267-7377.

# Getting started

## Telephone base installation

Install the telephone base as shown below.

Make sure that the electrical outlet is not controlled by a wall switch.

If you subscribe to digital subscriber line (DSL) high-speed Internet service through your telephone line, you must install a DSL filter between the telephone line cord and telephone wall jack. The filter prevents noise and caller ID problems caused by DSL interference. Contact your DSL service provider for more information about DSL filters.

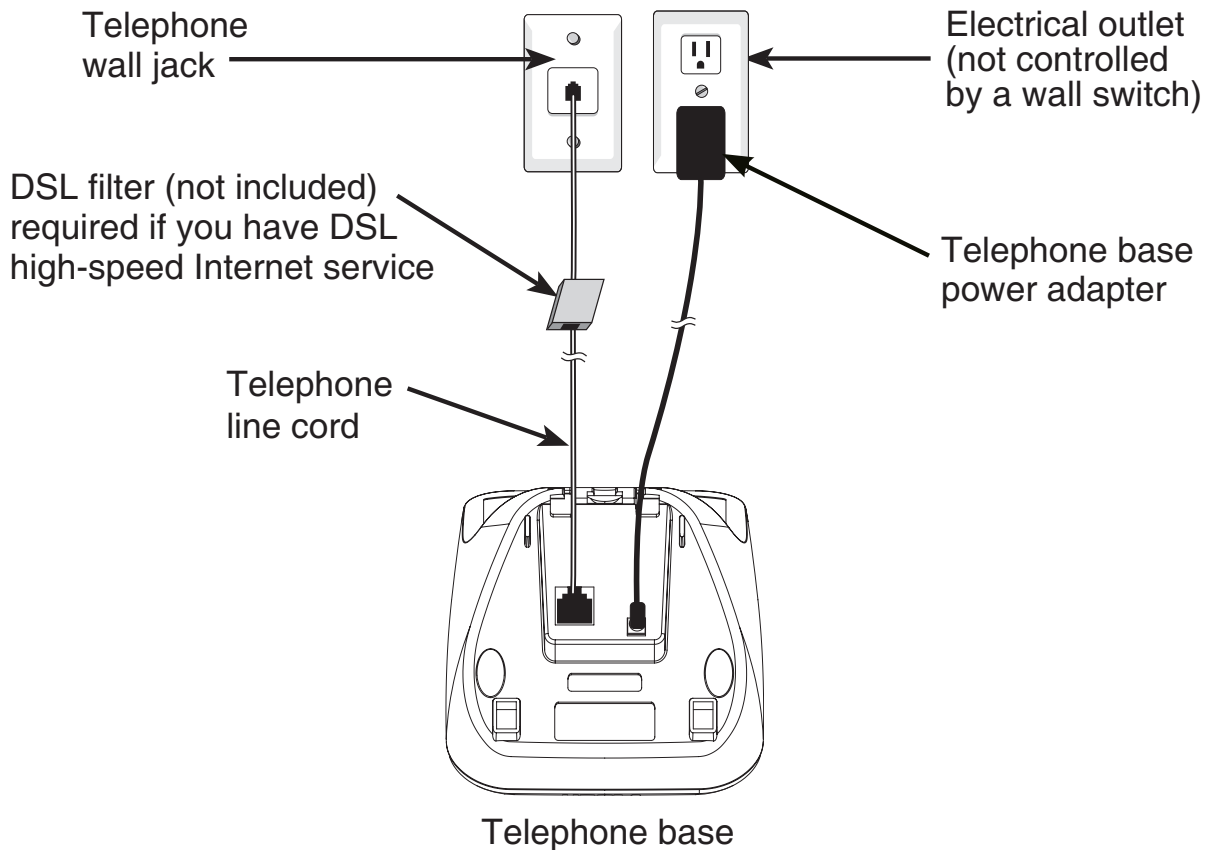

### note

- Use only the power adapter supplied with this product. To order a replacement, visit our website at [www.vtechphones.com](http://www.vtechphones.com) or call 1 (800) 595-9511. In Canada, go to [www.vtechcanada.com](http://www.vtechcanada.com) or dial 1 (800) 267-7377.
- The power adapter is intended to be correctly oriented in a vertical or floor mount position. The prongs are not designed to hold the plug in place if it is plugged into a ceiling, under-the-table or cabinet outlet.

# Getting started

## Wall mounting

Your telephone comes ready for tabletop use. If you prefer to mount your telephone on the wall (optional), it is designed to mount on a standard telephone wall plate.

You can mount the telephone base on the wall by positioning it so the mounting studs fit into the corresponding holes at the back of the telephone base. Slide the telephone base down on the mounting studs until it locks into place.

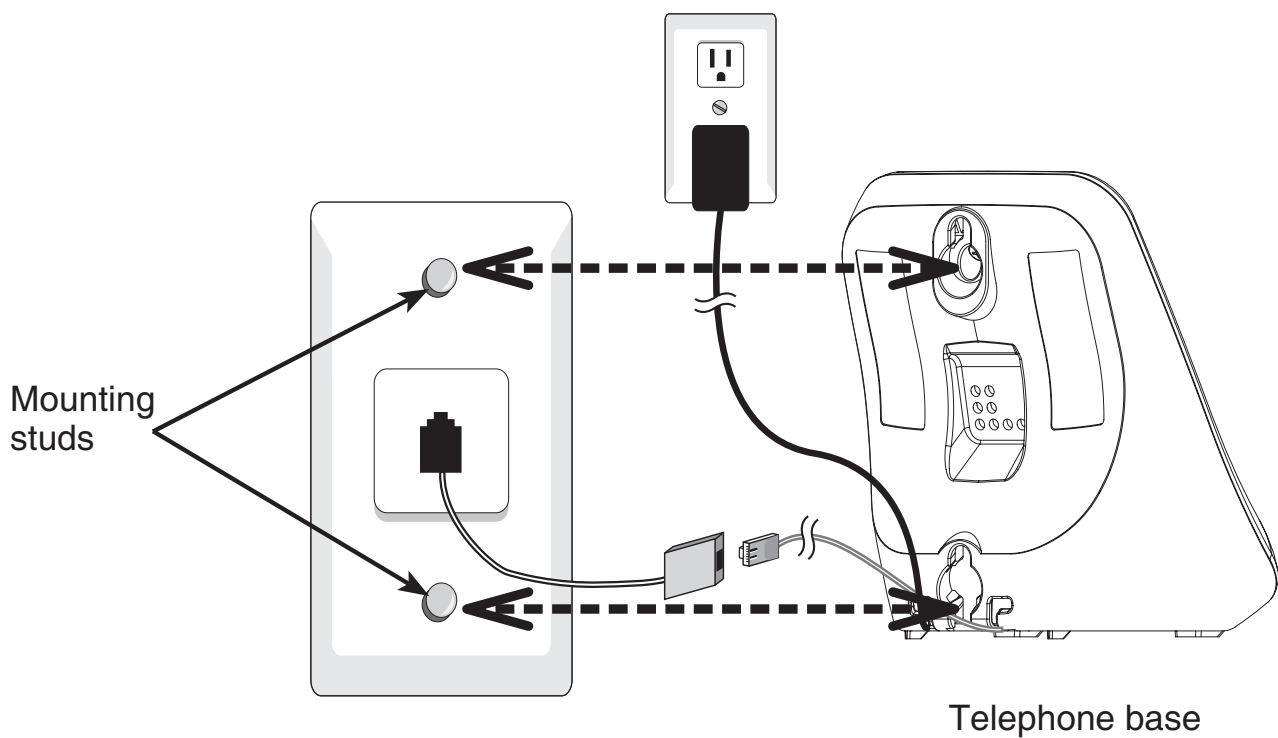

# Getting started

## Battery installation

Install the battery as shown below.

1. If the battery compartment cover is on the handset, press on the indentation and slide the cover down to remove.
2. Plug the battery connector securely into the socket inside the handset battery compartment, matching the color-coded label.
3. Place the battery with the label **THIS SIDE UP** facing up and the wires inside the battery compartment.
4. Align the cover flat against the battery compartment, then slide it towards the center of the handset until it clicks into place.
5. Charge the handset by placing it in the telephone base. The **CHARGE** light remains on whenever the handset is charging in the telephone base.

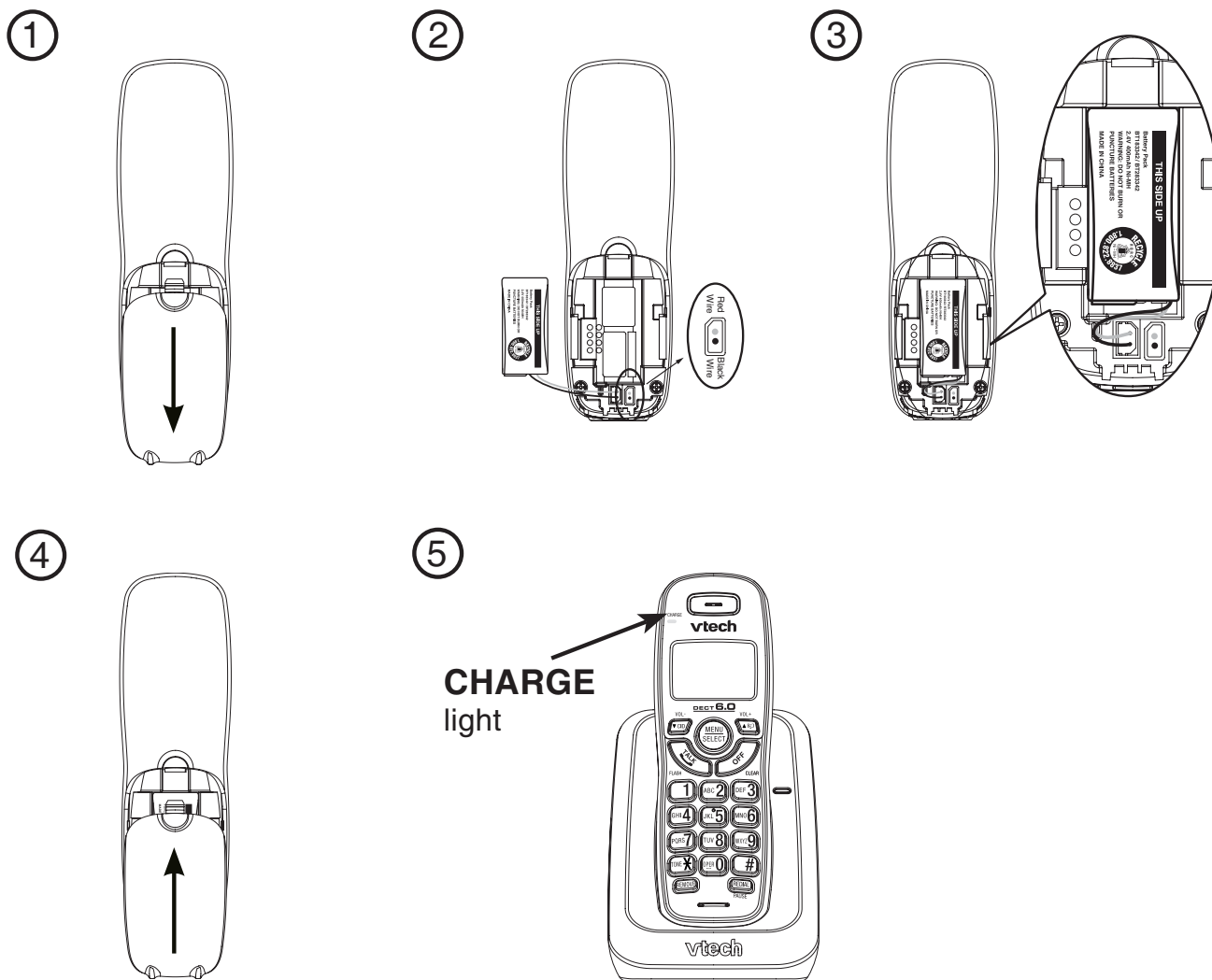

### note

- If the handset will not be used for a long period of time, disconnect and remove the battery to prevent any possible leakage.
- To purchase a replacement battery, visit our website at [www.vtechphones.com](http://www.vtechphones.com) or call 1 (800) 595-9511. In Canada, go to [www.vtechcanada.com](http://www.vtechcanada.com) or dial 1 (800) 267-7377.



# Getting started

## Battery charging

Once you have installed the battery, the screen indicates the battery status (see the table below). If necessary, place the handset in the telephone base to charge the battery. For best performance, keep the handset in the telephone base when not in use. The battery is fully charged after 16 hours of continuous charging. See the table on page 33 for battery operating times.

If the screen is blank, you need to charge the handset without interruption for at least 10 minutes to give the handset enough charge to use the telephone for a short time. When the battery is low, the handset beeps and shows **Low battery** and a flashing  icon. **If you are on a call in low battery mode, the handset beeps every minute.**

The following table summarizes the battery charge indicators and actions to take.

Battery indicators	Battery status	Action
The screen is blank or shows <b>Place in charger</b> and  flashes.	Battery has very little or no charge. The handset cannot be used.	Charge without interruption (at least 30 minutes).
The screen shows <b>Low battery</b> and  flashes.	Battery has enough charge to be used for a short time.	Charge without interruption (about 30 minutes).
The screen shows <b>HANDSET X</b> and --:- - -/--.	Battery is charged.	To keep the battery charged, place it in the telephone base or charger when not in use.

### note

If you do not plug in the battery into the handset and place it in the telephone base or charger, the screen displays **No battery**.



# Getting started

## Handset layout

### **CHARGE** light

On when the handset is charging in the telephone base (page 4).

### **▼CID/VOL-**

Press to review the call log when the telephone is not in use (page 27).

Press and hold to adjust the ringer volume when the telephone is not in use (page 9).

During a call, press to decrease the listening volume. A double beep sounds at the lowest setting (page 14).

Press to scroll down while in programming mode or reviewing the directory, call log or redial list.

### **TALK/FLASH**

Press to make or answer a call (page 14).

During a call, press to answer an incoming call when you receive a call waiting alert (page 14).

### **Dialing keys**

Press to enter numbers to make, redial or answer a call (page 14).

While programming in the directory or call log, press to enter numbers or characters (page 19 or 29).

While programming the home area code, press to enter numbers (page 12).

### **TONEX**

Press to switch to tone dialing temporarily when using the pulse service (page 14).

### **REMOVE**

When using the dialing keys, press to delete digits.

Press and hold to delete all records in the call log when the phone is not in use (page 29).

When reviewing the directory, call log or redial list, press to delete the desired record (page 22, 29 or 17).

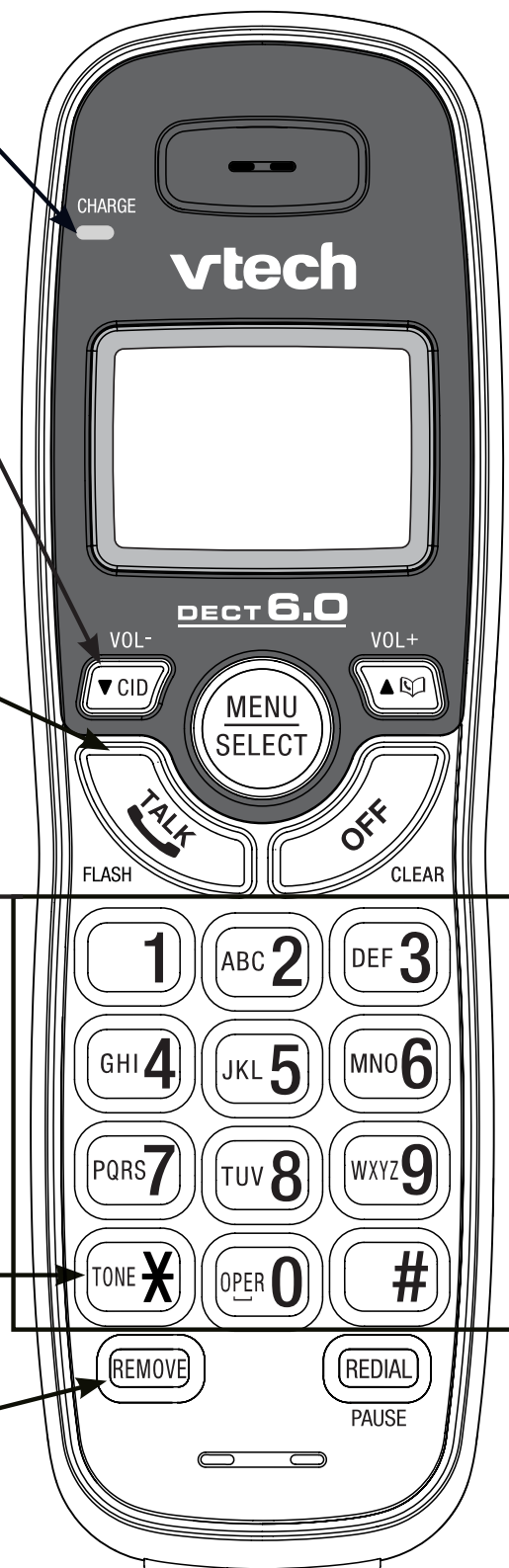

# Getting started

## Handset layout

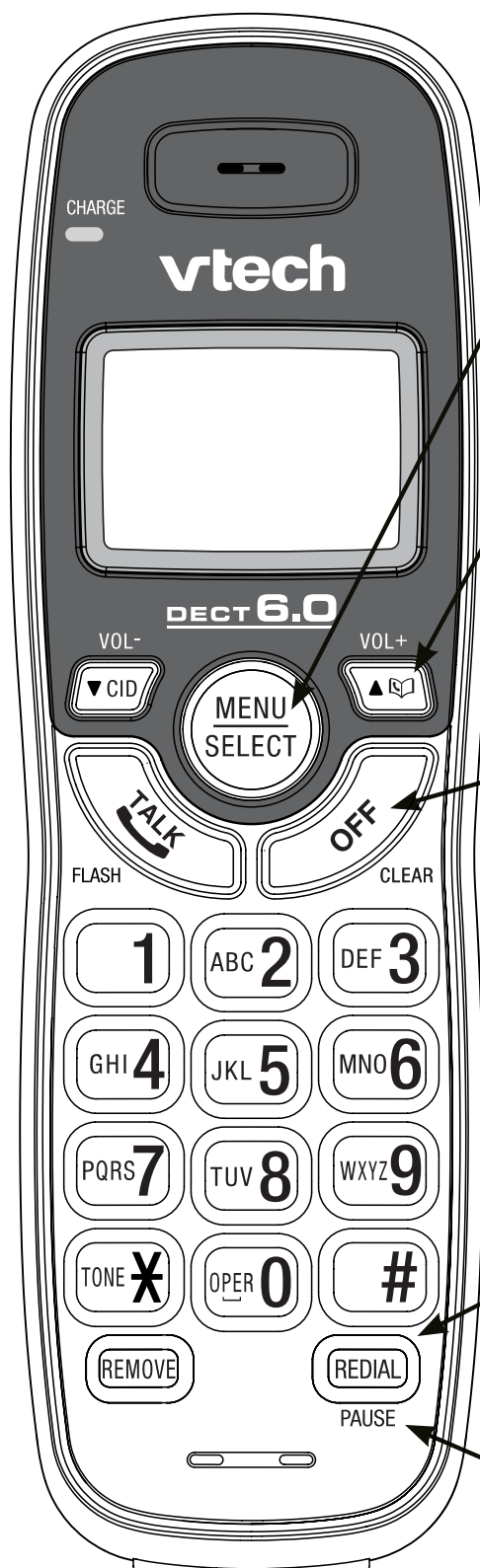

### MENU/SELECT

Press to show the menu.

While in a menu, press to choose an item, or save an entry or setting.

### ▲📖/VOL+

Press to review the directory when the telephone is not in use (page 20).

Press and hold to adjust the ringer volume when the telephone is not in use (page 9).

During a call, press to increase the listening volume. A double beep sounds at the highest setting (page 14).

Press to scroll up while in programming mode or reviewing the directory, call log or redial list.

### OFF/CLEAR

During a call, press to hang up.

While the handset is ringing, press to silence the ringer temporarily (page 14).

While the telephone is not in use, press and hold to erase the missed calls indicator (page 26).

During programming, press to exit without making changes.

While predialing, press to delete digits (page 14).

### #

Press repeatedly to show other dialing options when reviewing a call log entry (page 28).

Press to use the **CLR VOICEMAIL** feature while in the main menu (page 10).

### REDIAL/PAUSE

Press repeatedly to review the redial list (page 17).

While dialing or entering numbers into the directory, press to insert a dialing pause (pages 14 and 19).

# Getting started

## Telephone base layout

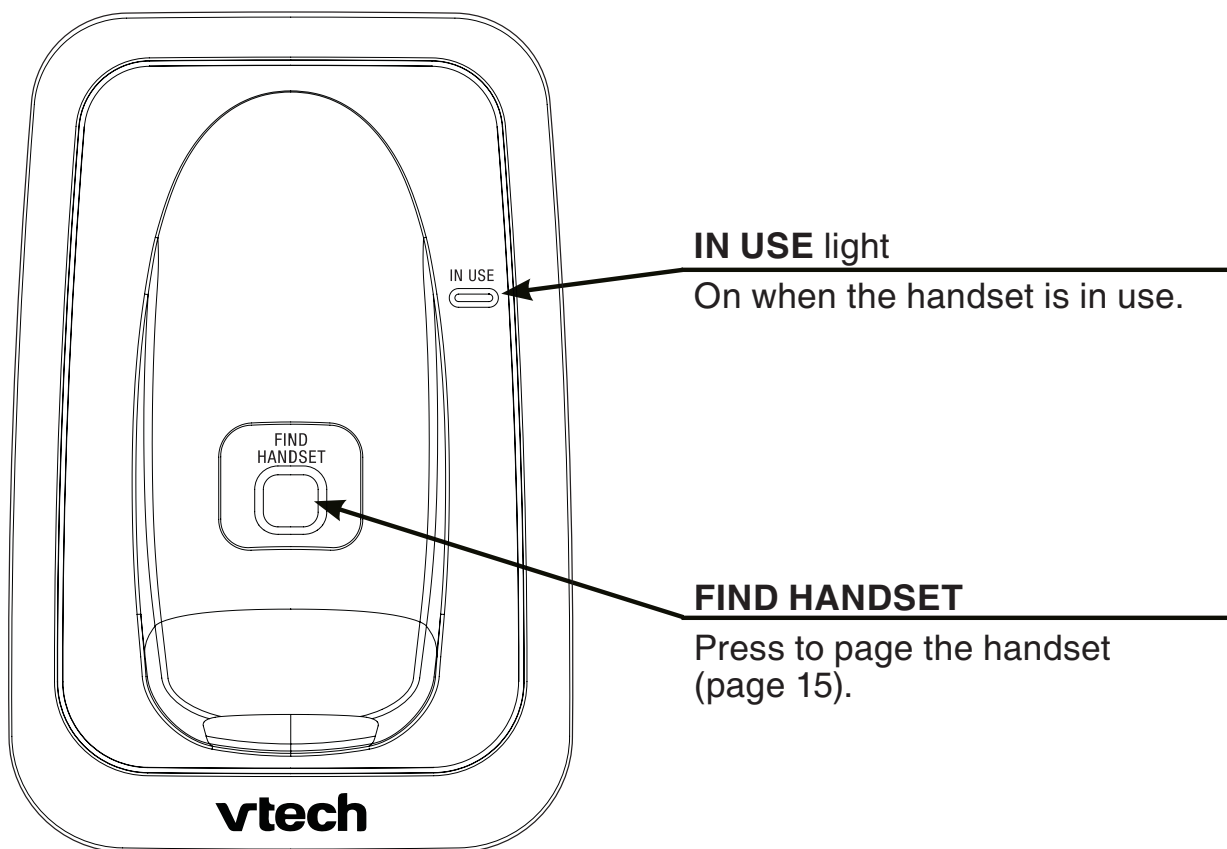

# Telephone settings

## Ringer volume

You can adjust the ringer volume or turn the ringer off.

1. Press **MENU/SELECT** when the handset is not in use.
2. Press **▼CID/VOL-** or **▲📖/VOL+** until the screen displays **◆Ringers**, then press **MENU/SELECT** twice.
3. Press **▼CID/VOL-** or **▲📖/VOL+** to adjust the volume. A sample of each ringer volume plays as you scroll through the choices. The lowest setting is **Ringer OFF**.
4. Press **MENU/SELECT** to save your selection, you will hear a confirmation tone.
5. Press **OFF/CLEAR** to return to idle mode.

### -OR-

1. When the handset is not in use, press and hold **▼CID/VOL-** or **▲📖/VOL+** until the screen displays **◆Ringer volume**, then press **MENU/SELECT** flashes.
2. Press **▼CID/VOL-** or **▲📖/VOL+** to adjust ringer volume. You hear a sample of the selected volume level as you scroll through the choices.
3. Press **MENU/SELECT** to save your selection, you will hear a confirmation tone.

#### note

- If the ringer volume is set to **OFF**, **Ringer off** is displayed on the idle screen.
- The setting also determines the ringer volume of the handset paging tone. However, when the ringer volume is set to **OFF**, the handset still rings when you press **FIND HANDSET**.

## Ringer tone

You can change the handset ringer tone.

1. Press **MENU/SELECT** when the handset is not in use.
2. Press **▼CID/VOL-** or **▲📖/VOL+** until the screen displays **◆Ringers**, then press **MENU/SELECT**.
3. Press **▼CID/VOL-** or **▲📖/VOL+** until the screen displays **◆Ringer tone**, then press **MENU/SELECT**.
4. Press **▼CID/VOL-** or **▲📖/VOL+** to select **Tone: 1, 2, 3, or 4**. The current setting flashes. A sample of each ringer tone plays as you scroll through the choices.
5. Press **MENU/SELECT** to save your selection, you will hear a confirmation tone.
6. Press **OFF/CLEAR** to return to idle mode.

#### note

If you turn off the ringer volume, you will not hear ringer tone samples.

# Telephone settings

## LCD language

The LCD language is preset to English. You can select English, French or Spanish to be used in all screen displays.

### To select a language:

1. Press **MENU/SELECT** when the handset is not in use.
2. Press **▼CID/VOL-** or **▲📖/VOL+** until the screen displays **◆Settings**, then press **MENU/SELECT** twice.
3. Press **▼CID/VOL-** or **▲📖/VOL+** to select **English**, **Français** or **Español**, then press **MENU/SELECT** to save your setting. You will hear a confirmation tone.
4. Press **OFF/CLEAR** to return to idle mode.

## Clear voicemail

If you subscribe to voicemail service offered by your telephone service provider, **New voicemail** and  are displayed on the handset when you have new voicemail messages. Contact your telephone service provider for more information and assistance about using your voicemail service.

After you have listened to all new voicemail messages, the indicators on the handset turn off automatically.

Use the clear voicemail feature when the telephone indicates that there is new voicemail but there are none (for example, when you have accessed your voicemail while away from home). The clear voicemail feature only turns off the indicators; it does not delete your voicemail messages. As long as you have new voicemail messages, your telephone service provider continues to send the signal that turns on the indicators.

### To manually turn off these indicators:

1. Press **MENU/SELECT** when the handset is not in use.
2. Press **▼CID/VOL-** or **▲📖/VOL+** until the screen displays **◆Clr voicemail**, then press **MENU/SELECT**. The screen displays **Clear VM icon?**
3. Press **MENU/SELECT** to confirm your selection, you will hear a confirmation tone.
4. Press **OFF/CLEAR** to return to idle mode.

#### note

Your telephone service provider may only alert you of new messages with a broken (stutter) dial tone. This by itself will not activate the **New voicemail** indication on your cordless handset. The provider must also send a digital signal for Visual Message Waiting Indication to activate the new voicemail alert on the handset display. This may also be called FSK Voice Message Waiting Indication. Contact your telephone service provider for details.

# Telephone settings

## Key tone

You can turn the key tone on or off.

1. Press **MENU/SELECT** when the handset is not in use.
2. Press **▼CID/VOL-** or **▲📖/VOL+** until the screen displays **◆Settings**, then press **MENU/SELECT**.
3. Press **▼CID/VOL-** or **▲📖/VOL+** until the screen displays **◆Key tone**, then press **MENU/SELECT**.
4. Press **▼CID/VOL-** or **▲📖/VOL+** to choose **On** or **Off**, then press **MENU/SELECT** to confirm your selection. You will hear a confirmation tone.
5. Press **OFF/CLEAR** to return to idle mode.

## Set date and time

The answering system announces the date and time of each message prior to playing it. Before using the answering system, set the date and time as follows. If you subscribe to caller ID service, the day, month and time are set automatically with each incoming call. However, the year must be correct so that the day of the week can be calculated from the caller ID information. You can also turn off the date and time settings of the caller ID service and use your own settings for each incoming call (see **CID time synchronization** on page 12).

1. Press **MENU/SELECT** when the handset is not in use.
2. Press **▼CID/VOL-** or **▲📖/VOL+** until the screen displays **◆Settings**, then press **MENU/SELECT**.
3. Press **▼CID/VOL-** or **▲📖/VOL+** until the screen displays **◆Set date/time**, then press **MENU/SELECT** twice.
4. When the month is flashing, press **▼CID/VOL-** or **▲📖/VOL+** until the screen displays the correct month and then press **MENU/SELECT**.
5. When the date is flashing, press **▼CID/VOL-** or **▲📖/VOL+** until the screen displays the correct date and then press **MENU/SELECT**.
6. When the year is flashing, press **▼CID/VOL-** or **▲📖/VOL+** until the screen displays the correct date and then press **MENU/SELECT**.
7. When the hour is flashing, press **▼CID/VOL-** or **▲📖/VOL+** until the screen displays the correct hour and then press **MENU/SELECT**.
8. When the minute is flashing, press **▼CID/VOL-** or **▲📖/VOL+** until the screen displays the correct minute and then press **MENU/SELECT**.
9. When **AM** or **PM** is flashing, press **▼CID/VOL-** or **▲📖/VOL+** to select **AM** or **PM**. Press **MENU/SELECT** to save your settings, you will hear a confirmation tone.
10. Press **OFF/CLEAR** to return to idle mode.



# Telephone settings

## CID time synchronization

This feature allows the time and date to be set by incoming caller ID information. The default setting is **On**.

1. Press **MENU/SELECT** when the handset is not in use.
2. Press **▼CID/VOL-** or **▲📖/VOL+** until the screen displays **◆Settings**, then press **MENU/SELECT**.
3. Press **▼CID/VOL-** or **▲📖/VOL+** until the screen displays **◆Set date/time**, then press **MENU/SELECT**.
4. Press **▼CID/VOL-** or **▲📖/VOL+** until the screen displays **◆CID time sync**, then press **MENU/SELECT**.
5. Press **▼CID/VOL-** or **▲📖/VOL+** to choose **On** or **Off**, then press **MENU/SELECT** to confirm your selection. You will hear a confirmation tone.
6. Press **OFF/CLEAR** to return to idle mode.

## Home area code

If you dial local calls using only seven digits (area code not required), you can program your home area code so that when you receive a call within your local area, the telephone number is automatically stored without the area code in the call log.

### To change the setting:

1. Press **MENU/SELECT** when the handset is not in use.
2. Press **▼CID/VOL-** or **▲📖/VOL+** until the screen displays **◆Settings**, then press **MENU/SELECT**.
3. Press **▼CID/VOL-** or **▲📖/VOL+** until the screen displays **◆Home area code**, then press **MENU/SELECT**. The stored area code is displayed with the first digit flashing.
4. Use the dialing keys (0-9) to enter the desired home area code or press **REMOVE** to delete.
5. Press **MENU/SELECT** to confirm, you will hear a confirmation tone.
6. Press **OFF/CLEAR** to return to idle mode.

#### note

If, in the future, your telephone service provider requires you to dial the area code when making a local call, or, if you move to a location that requires it, delete the home area code you have already programmed following the steps above. After you have deleted the home area code, **\_ \_ \_** appears.

# Telephone settings

## Dial mode

If you have touch-tone service, the telephone is ready to use as soon as the battery is charged. If you have pulse (rotary) service, you need to change the dial mode setting to pulse.

### To change the setting:

1. Press **MENU/SELECT** when the handset is not in use.
2. Press **▼CID/VOL-** or **▲📖/VOL+** until the screen displays **◆Settings**, then press **MENU/SELECT**.
3. Press **▼CID/VOL-** or **▲📖/VOL+** until the screen displays **◆Dial mode**, then press **MENU/SELECT**.
4. Press **▼CID/VOL-** or **▲📖/VOL+** to choose **Tone** or **Pulse**, then press **MENU/SELECT** to confirm your selection. You will hear a confirmation tone.
5. Press **OFF/CLEAR** to return to idle mode.

## Website

Use this feature to view the VTech website address.

1. Press **MENU/SELECT** when the handset is not in use.
2. Press **▼CID/VOL-** or **▲📖/VOL+** until the screen displays **◆Website**, then press **MENU/SELECT**.
3. Press **OFF/CLEAR** to return to idle mode.



# Telephone operation

## Make a call

- Press /FLASH and then use the dialing keys (0-9) to dial the telephone number.

## Predial a call

- Enter the telephone number using the dialing keys (0-9), then press /FLASH to dial.

## Answer a call

- Press /FLASH or any of the dialing keys (0-9, TONE~~X~~ or #).

### note

- The screen shows the elapsed time as you talk (in hours, minutes and seconds).
- When predialing (preview numbers before dialing), press **REMOVE** or **OFF/CLEAR** to backspace and delete; press and hold **REDIAL/PAUSE** to insert a dialing pause (a **P** appears).
- If the handset is moved out of range while on a call, it will beep **three times every five seconds**.

## End a call

- Press **OFF/CLEAR** or put the handset to the telephone base or charger.

## Volume

- During a call, press **▼CID/VOL-** or **▲/VOL+** to adjust the listening volume.

## Share an outside call

You can use up to two system handsets at a time on an outside call.



- When a handset is already on a call and you would like to join the call, press /FLASH on another handset to join the call.
- To end the call, press **OFF/CLEAR** or place the handset in the telephone base or charger. The call will not end until all handsets hang up.

### note

This feature is only applicable to model **CS6114-2**.

## Call waiting

When you subscribe to call waiting service from your telephone service provider, you hear an alert tone if there is an incoming call while you are on another call.

- Press /FLASH to put the current call on hold and take the new call.
- Press /FLASH at any time to switch back and forth between calls.

# Telephone operation

## Temporary ringer silencing

When the telephone is ringing, you can temporarily silence the ringer of the handset or telephone base without disconnecting the call. The next call rings normally at the preset volume.

To silence the handset ringer:

- Press **OFF/CLEAR** and **Ringer muted** displays.

To silence the telephone base ringer:

- Press **▼/VOLUME** to turn off the base ringer.



Ringer muted

10:15 PM 12/25

## Temporary tone dialing

If you have pulse (rotary) service only, you can switch from pulse to tone dialing temporarily during a call. This is useful if you need to send touch-tone signals to access your telephone banking or long distance services.

1. During a call, press **TONE~~X~~**.
2. Use the dialing keys to enter the relevant number. The telephone sends touch-tone signals.
3. The telephone automatically returns to pulse dialing mode after you end the call.

## Find handset

Use this feature to find all system handsets.

### To start paging:

1. Press **FIND HANDSET** on the telephone base when the telephone is not in use.
2. All idle handsets ring and the screens show **\*\* Paging \*\***.

### To end paging:

- Press **FIND HANDSET** again on the telephone base.

**-OR-**

- Press **OFF/CLEAR** on the handset or place the handset back in the telephone base to stop the paging tone.

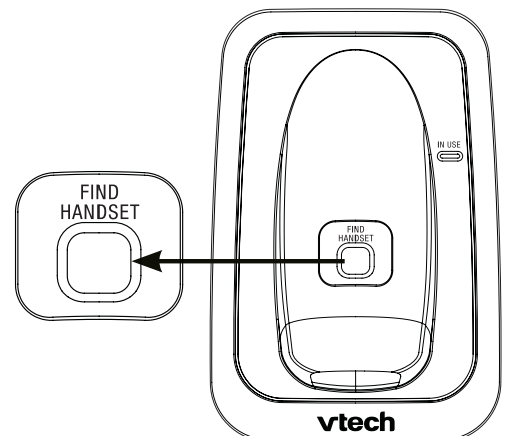

# Telephone operation

## Chain dialing

Use this feature to initiate a dialing sequence from numbers stored in the directory, call log or redial while you are on a call.

Chain dialing can be useful if you wish to access other numbers (such as bank account numbers or access codes) from the directory, call log or **redial list**.

### To access a number in the directory while on a call:

1. Press **MENU/SELECT** twice to select **◆Directory**.
2. Press **MENU/SELECT** and then press **▼CID/VOL-** or **▲📖/VOL+** to scroll to the desired entry.
3. Press **MENU/SELECT** to dial the displayed number.

### To access a number in the call log while on a call:

1. Press **MENU/SELECT** and then press **▼CID/VOL-** or **▲📖/VOL+** to select **◆Call log**.
2. Press **MENU/SELECT** and then press **▼CID/VOL-** or **▲📖/VOL+** to scroll to the desired entry.
3. Press **MENU/SELECT** to dial the displayed number.

### To access a number in the redial list while on a call:

1. Press **REDIAL/PAUSE** and then press **▼CID/VOL-** or **▲📖/VOL+** or **REDIAL/PAUSE** to browse to the desired entry.
2. Press **MENU/SELECT** to dial the displayed number.

#### note

- You cannot edit a directory entry while on a call. For more details about the directory, see page 18.
- You cannot copy a call log entry into the directory while on a call. For more details about call log, see page 26.
- You cannot erase a redial entry while on a call. For more details about the redial memory, see page 17.
- Press **OFF/CLEAR** to exit redial, directory or call log when you are on a call.
- When there is more than one handset on a call, only the first handset that answered the call can access the directory, call log or redial list.

# Telephone operation

## Redial list

The telephone stores the 5 most recently dialed numbers.

- When there are already 5 entries, the oldest entry is deleted to make room for the new entry.
- Entries are shown in reverse chronological order.

## Review the redial list

1. Press **REDIAL/PAUSE** when the handset is not in use.
2. Press **▼CID/VOL-**, **▲📖/VOL+** or **REDIAL/PAUSE** repeatedly to browse the redial list.

## Dial a redial entry

1. Press **TALK/FLASH** when the handset is not in use.
2. Press **REDIAL/PAUSE** to dial the last dialed telephone number.

**-OR-**

1. Press **REDIAL/PAUSE** when the handset is not in use.
2. Press **▼CID/VOL-**, **▲📖/VOL+** or **REDIAL/PAUSE** until the desired entry is displayed.
3. Press **TALK/FLASH** to dial.

## Delete a redial entry

1. Press **REDIAL/PAUSE** when the handset is not in use.
2. Press **▼CID/VOL-**, **▲📖/VOL+** or **REDIAL/PAUSE** repeatedly to browse to the desired entry.
3. Press **REMOVE** to delete the displayed number.

# Telephone operation

## Directory

The directory can store up to **30** entries (including 10 speed dial entries). Each entry may consist of a phone number up to 30 digits and a name up to 15 characters.

- Each handset directory is independent of the other handsets. Directory entries are shared by all system handsets. Any additions, deletions or edits made on one handset will not be reflected in the directory of other handsets.
- When there are no records in the directory, the screen shows **Directory empty**.
- When the directory is full and you try to save an entry, the screen shows **Directory full**.
- If you try to save an entry already stored in the directory, the screen shows **Number repeated**.
- If the telephone number in the directory exceeds 15 digits, - appears after the 14th number and the rest of the numbers will be shown two seconds later on the same row beginning with a -.
- Only one handset can review the directory at a time. If a handset tries to enter the directory while another handset is already in it, **Not available** appears.



Directory empty



Directory full



Number repeated



Not available



Elizabeth Jones  
10001234567890-



Elizabeth Jones  
-1234567890123-



Elizabeth Jones  
-456

# Telephone operation

## Add a directory entry

1. Enter the number when the handset is not in use and press **MENU/SELECT**, then go to step 4.

**-OR-**

Press **MENU/SELECT** when the handset is not in use.

2. Press **▼CID/VOL-** or **▲/VOL+** to select **◆Directory** and then press **MENU/SELECT** twice.

3. The screen shows **ENTER NUMBER**.

4. Use the dialing keys to enter or modify the number.

- Press **REMOVE** to backspace and erase a digit.
- Press and hold REMOVE to erase the entire entry.
- Press **▼CID/VOL-** to move the cursor to the left or **▲/VOL+** to the right.
- Press and hold REDIAL/PAUSE to insert a dialing pause (a **P** appears).

**-OR-**

**Copy a number from the redial list by pressing REDIAL/PAUSE and then press ▼CID/VOL-, ▲/VOL+ or REDIAL/PAUSE repeatedly to select a number. Press MENU/SELECT to copy the number.**

5. Press **MENU/SELECT** to move to the name. The screen shows **ENTER NAME**. Press **MENU/SELECT** again.

6. Use the dialing keys (see page 20) to enter the name.

- Press **REMOVE** to backspace and erase a character.
- Press and hold REMOVE to erase the entire entry.
- Press **▼CID/VOL-** to move the cursor to the left or **▲/VOL+** to the right.

7. Press **MENU/SELECT** to confirm. The screen displays **Saved** and you hear a confirmation tone.

8. Press **OFF/CLEAR** to return to idle mode.

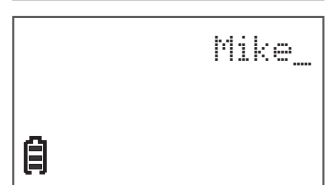
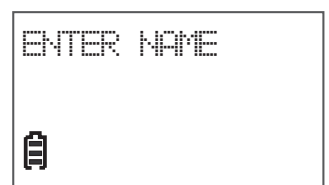
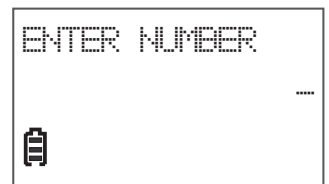
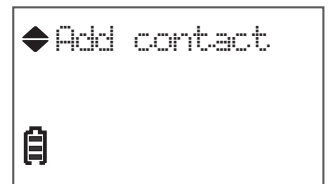
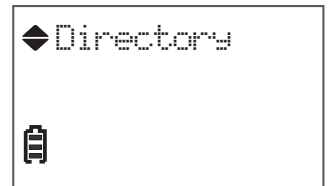

# Telephone operation

## Character chart

Use the dialing keys and the chart below to enter a name (up to 15 characters). **An error tone sounds if you try to enter more than 15 characters.** Each press of a particular key causes the characters to be displayed in the following order:

Number key	Characters by number of key presses										
	1	2	3	4	5	6	7	8	9	10	11
1	1	.	-	'	(	)	*	#	&	/	,
2	A	B	C	a	b	c	2				
3	D	E	F	d	e	f	3				
4	G	H	I	g	h	i	4				
5	J	K	L	j	k	l	5				
6	M	N	O	m	n	o	6				
7	P	Q	R	S	p	q	r	s	7		
8	T	U	V	t	u	v	8				
9	W	X	Y	Z	w	x	y	z	9		
0	space	0									
TONEX											
#											

**note**

When entering a name in the directory, the first letter of each word is automatically capitalized. Press the number key repeatedly until the desired character appears.

# Telephone operation

## Review the directory

Entries are sorted alphabetically. To search the directory:

1. Press ▲/VOL+ when the handset is not in use. The screen displays  
◆Directory.  
-OR-  
Press MENU/SELECT when the handset is not in use.  
Press ▼CID/VOL- or ▲/VOL+ to select ◆Directory.
2. Press MENU/SELECT and then press ▼CID/VOL- or ▲/VOL+ to select ◆Review.
3. Press MENU/SELECT and then press ▼CID/VOL- or ▲/VOL+ to browse.



## Alphabetical search

### To start an alphabetical search:

1. Follow the steps in **Review the directory** above to enter the directory.
2. Use the dialing keys to enter the letters associated with the name. For example, if you have entries for Jenny, Jessie, Kristen and Laura in your directory, press 5 (JKL) once to see Jenny, twice to see Kristen (if you have more than one stored entry beginning with the same letter, in this case Jenny and Jessie, with the first entry displayed [**Jenny**], press ▲/VOL+ to view all other entries beginning with that letter), or three times to see **Laura**. If there is no name entry matching your search, the next closest match in alphabetical order appears. If necessary, press ▼CID/VOL- or ▲/VOL+ on the handset to browse.

## Dial a directory entry

1. Search for the desired entry in the directory (see **Review the directory** or **Alphabetical search** above).
2. When the desired entry appears, press /FLASH to dial.



# Telephone operation

## Edit a directory entry

1. Search for the desired entry in the directory (see **Review the directory** or **Alphabetical search** on page 20).
2. When the desired entry appears, press **MENU/SELECT**.
3. The screen shows **EDIT NUMBER** and the desired entry's number.
4. Use the dialing keys to edit the number.
  - Press **REMOVE** to backspace and erase a digit.
  - Press and hold REMOVE to erase the entire entry.
  - Press **▼CID/VOL-** to move the cursor to the left or **▲📖/VOL+** to the right.
  - Press and hold REDIAL/PAUSE to insert a dialing pause (a **P** appears).
5. Press **MENU/SELECT** to move to the name. The screen shows **EDIT NAME**. Press **MENU/SELECT** again.
6. Use the dialing keys (see page 20) to edit the name.
  - Press **REMOVE** to backspace and erase a character.
  - Press and hold REMOVE to erase the entire entry.
  - Press **▼CID/VOL-** to move the cursor to the left or **▲📖/VOL+** to the right.
7. Press **MENU/SELECT** to confirm. The screen displays **Saved** and you hear a confirmation tone.
8. Press **OFF/CLEAR** to return to idle mode.

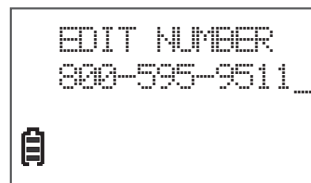

```
EDIT NUMBER
800-595-9511_
📞
```

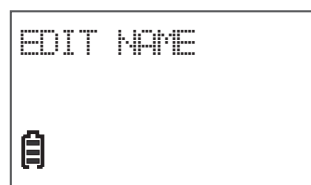

```
EDIT NAME
_
📞
```

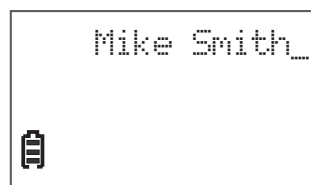

```
Mike Smith_
📞
```

## Delete a directory entry

1. Search for the desired entry in the directory (see **Review the directory** or **Alphabetical search** on page 20).
2. When the desired entry appears, press **REMOVE**. The screen shows **Delete contact?** and the number.
3. Press **MENU/SELECT** to confirm. The screen shows **Deleting ...** and **Contact deleted**. You will hear a confirmation tone.
4. Press **OFF/CLEAR** to return to idle mode.

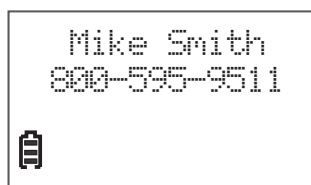

```
Mike Smith
800-595-9511
📞
```

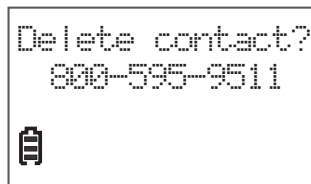

```
Delete contact?
800-595-9511
📞
```

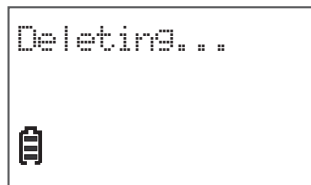

```
Deleting...
📞
```

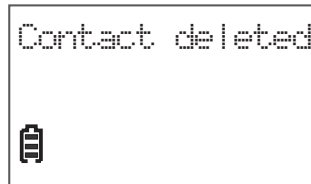

```
Contact deleted
📞
```

# Telephone operation

## Speed dial

You can store up to 10 telephone numbers with names in the speed dial memory locations you assign from the directory you wish to dial using fewer keys than usual. You must create an entry in the directory (see page 19) before you set the speed dial memory location.

The speed dial memory locations are stored in the telephone base and are shared by all handsets. Changes made to speed dial entries on one handset apply to all.

## Add a speed dial entry

1. Press **MENU/SELECT** when the handset is not in use.
2. Press **▼CID/VOL-** or **▲📖/VOL+** to select **◆Directory**, then press **MENU/SELECT**.
3. Press **▼CID/VOL-** or **▲📖/VOL+** to select **◆Speed dial**, then press **MENU/SELECT**.
4. Press **▼CID/VOL-** or **▲📖/VOL+** to choose the desired speed dial location, then press **MENU/SELECT**. The screen shows **Copy from DIR..** while it is loading the directory list. The directory list displays.
5. Press **▼CID/VOL-** or **▲📖/VOL+** to choose the desired directory entry, then press **MENU/SELECT** to confirm. You will hear a confirmation tone.
  - If you choose an existing speed dial entry in step 4, the entry will be replaced by the new directory entry and the old entry is moved to a directory location.

**-OR-**

1. Press and hold the dial pad key (**0-9**) that does not have any speed dial entry.
2. Press **MENU/SELECT** and the screen shows **Copy from DIR..** while it is loading the directory list. The directory list displays.
3. Press **▼CID/VOL-** or **▲📖/VOL+** to choose the desired directory entry, then press **MENU/SELECT** to confirm. You will hear a confirmation tone.

### note

- The entries stored in the speed dial memory are numbered **0** to **9** and share the memory in the directory.
- Press **OFF/CLEAR** at any time to exit speed dial mode.

# Telephone operation



## Dial a speed dial number

1. Press and hold the dial pad key (0-9) to display the speed dial entry.
2. Press /FLASH to dial the displayed number.

### note

If the speed dial location you selected is empty, the screen displays **<empty>**.

## Delete a speed dial entry

1. Press **MENU/SELECT** when the handset is not in use.
2. Press **▼CID/VOL-** or **▲/VOL+** to select **◆Directory**, then press **MENU/SELECT**.
3. Press **▼CID/VOL-** or **▲/VOL+** to select **◆Speed dial**, then press **MENU/SELECT**.
4. Press **▼CID/VOL-** or **▲/VOL+** to choose the desired speed dial entry, then press **REMOVE** to confirm. You will hear a confirmation tone.

### note

The deleted speed dial entry is only removed from speed dial memory, not from the directory.

# Telephone operation

## About caller ID

This product supports caller ID services provided by most telephone service providers. Depending on your service subscription, you may see the caller's number, or the caller's name and number that are sent by your telephone service provider after the first or second ring. Caller ID allows you to see the name, number, date and time of calls.

Caller ID with call waiting lets you see the name and telephone number of the caller before answering the telephone, even while on another call.

It may be necessary to change your telephone service to use this feature. Contact your telephone service provider if:

- You have both caller ID and call waiting, but as separate services (you may need to combine these services).
- You have only caller ID service, or only call waiting service.
- You do not subscribe to caller ID or call waiting services.

There are fees for caller ID services. In addition, services may not be available in all areas.

This product can provide information only if both you and the caller are in areas offering caller ID service and if both telephone service providers use compatible equipment. The time and date are sent by your telephone service provider along with the call information.

You can use this product with regular caller ID service, or you can use this product's other features without subscribing to either caller ID or combined caller ID with call waiting service.

# Telephone operation

## Call log

If you subscribe to caller ID service, information about each caller will appear after the first or second ring. If you answer a call before the caller information appears on the screen, it will not be saved in the call log.

- The call log stores up to 50 entries. Each entry has up to 24 digits for the phone number and 15 characters for the name. If the phone number has more than 15 digits, only the last 15 digits appear. If the name has more than 15 characters, only the first 15 characters are shown and saved in the call log.
- You can review, redial and copy an entry into the directory.
- Entries appear in reverse chronological order.
- When the call log is full, the oldest entry is deleted to make room for new incoming call information.
- **XX missed call(s)** shows when there are new call log entries that have not been reviewed.
- **Call log empty** shows when there are no records in the call log.
- Only one handset can review the call log at a time. If a handset tries to enter the call log while another handset is already in it, **Not available** appears.

### note

- The caller ID information may not be available for every incoming call. The callers may intentionally block their names and/or telephone numbers.
- For call log entries with numbers between 16 and 24 digits, in order to view the entire number, you must save the entry to the directory (see page 29).
- If the phone number has more than 24 digits, it will not be saved or shown in the call log.

## Missed calls indicator

When there are calls that have not been reviewed in the call log, the handset shows **XX missed calls**.

Each time you review a call log entry marked **NEW**, the number of missed calls decreases by one.

When you have reviewed all the missed calls, the missed calls indicator no longer shows.



xx missed calls



10:15 PM 12/5 NEW

If you do not want to review the missed calls one by one, press and hold OFF/CLEAR on the handset to erase the missed calls indicator. All the entries are then considered old and kept in the call log.

# Telephone operation

## Memory match

When the incoming telephone number matches exactly a telephone number in your directory, the name on the screen matches the corresponding name in your directory.

For example, if Linda Jones calls, her name appears as **Linda** if this is how you entered it into your directory.

### note

The number shown in the call log is in the format sent by the telephone service provider. The telephone service provider usually delivers ten-digit phone numbers (area code plus phone number). If the telephone number of the caller does not exactly match a number in your directory, the name appears as it is delivered by the telephone service provider. For example, if the telephone service provider includes the area code but your directory number does not, the name appears as delivered by the telephone service provider.

## Review the call log

1. Press **▼CID/VOL-** when the telephone is not in use.
2. Press **▼CID/VOL-** or **▲📖/VOL+** to browse.

### -OR-

1. Press **MENU/SELECT** when the handset is not in use. Press **▼CID/VOL-** or **▲📖/VOL+** to select **◆Call log**.
2. Press **MENU/SELECT** and then press **▼CID/VOL-** or **▲📖/VOL+** to select **◆Review**.
3. Press **MENU/SELECT** and then press **▼CID/VOL-** or **▲📖/VOL+** to browse.

### note

- The name (if available), telephone number, date and time of all incoming calls are shown on the screen.
- You hear a double beep when it reaches the beginning or end of the call log list.

# Telephone operation

## View dialing options

Although the call log entries received have 10 digits (the area code plus the seven-digit number), in some areas, you may dial only the seven digits, or a 1 plus the seven digits, or a 1 plus the area code plus the seven digits. You can change the number of digits that you dial from or store to the directory.

While reviewing the call log, press **#** repeatedly to show different dialing options for local and long distance numbers before dialing or saving the telephone number in the directory.

Press **1** repeatedly if you need to add or remove 1 in front of the telephone number before dialing or saving it in the directory.

When the number is shown in the correct format for dialing, press  **FLASH** on the handset to call the number.

```
800-595-9511
1-800-595-9511
595-9511
1-595-9511
```

```
800-595-9511
1-800-595-9511
```

```
595-9511
1-595-9511
```

### note

If you have programmed the home area code (see page 12), only the last seven digits of the incoming phone numbers from that area code will be displayed while reviewing the call log. Press **#** repeatedly to display all possible dialing options.

## Dial a call log number

1. When in the call log (see Review the call log on page 27), press **▼CID/VOL-** or **▲/VOL+** to browse to the desired entry.
2. Press  **FLASH** to call.

# Telephone operation

## Save a call log entry to the directory

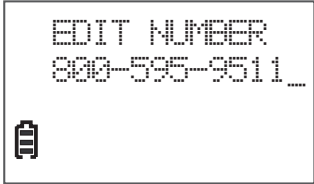
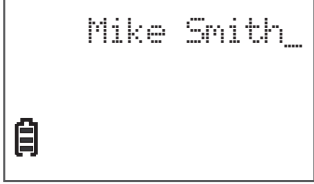
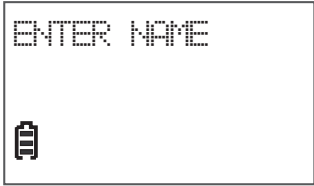
1. When in the call log (see Review the call log on page 27), press **▼CID/VOL-** or **▲📖/VOL+** to browse.
2. When the desired entry appears, press **MENU/SELECT**.
3. The screen shows **EDIT NUMBER** and the desired entry's number.
4. Use the dialing keys to edit the number.
  - Press **REMOVE** to backspace and erase a digit.
  - Press and hold REMOVE to erase the entire entry.
  - Press **▼CID/VOL-** to move the cursor to the left or **▲📖/VOL+** to the right.
  - Press and hold REDIAL/PAUSE to insert a dialing pause (a **P** appears).
5. Press **MENU/SELECT** to move to the name. The screen shows **EDIT NAME**. Press **MENU/SELECT** again.
6. Use the dialing keys (see page 20) to edit the name.
  - Press **REMOVE** to backspace and erase a character.
  - Press and hold REMOVE to erase the entire entry.
  - Press **▼CID/VOL-** to move the cursor to the left or **▲📖/VOL+** to the right.
7. Press **MENU/SELECT** to confirm. The screen displays **Saved** and you hear a confirmation tone.
8. Press **OFF/CLEAR** to return to idle mode.

### note

- If the entry is already saved in the directory, the handset shows **Already saved**.
- If there is no caller ID information, you hear a double beep .

## Delete from the call log

### Delete an entry:

1. When in the call log, press **▼CID/VOL-** or **▲📖/VOL+** to browse.
2. Press **REMOVE** to delete the selected entry.

### Delete all entries:

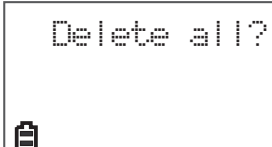
1. Press **MENU/SELECT** when the handset is not in use. Press **▼CID/VOL-** or **▲📖/VOL+** to select **📞Call log**.
2. Press **MENU/SELECT** and then press **▼CID/VOL-** or **▲📖/VOL+** to select **📞Del all calls**.
3. Press **MENU/SELECT** and the screen shows **Delete all?**
  1. Press **MENU/SELECT** to confirm. **The screen shows DELETING... and** you hear a confirmation tone.



# Telephone operation

## Call log display screen messages

Displays	When
PRIVATE NAME	The caller is blocking the name information.
PRIVATE NUMBER	The caller is blocking the telephone number information.
PRIVATE CALLER	The caller is blocking the name and number information.
UNKNOWN NAME	This caller's name is unavailable.
UNKNOWN NUMBER	This caller's number is unavailable.
UNKNOWN CALLER	No call information is available about this caller.
LONG DISTANCE <b>-OR-</b> L (before the caller's number)	It is a long distance call.

# Appendix

## Screen display messages

Call log empty	There are no call log entries.
Copy from DIR..	The telephone is loading entries from Directory for speed dial assignment.
Call log empty	There are no call log entries.
Directory empty	There are no directory entries.
Directory full	The directory is full.
Ended X:XX:XX	You have just ended a call.
Incoming call	There is an incoming call.
Line in use	A system handset or another telephone on the same line is in use.
Low battery	The battery needs to be recharged.
New voicemail	There are new voicemail message(s) from the telephone service provider.
No battery	No battery is installed. Follow the directions for battery installation on page 4 to install the battery before charging.
No line	There is no telephone line connected.
No signal	Communication between handset and telephone base is lost during a call.
Not available	One handset is already viewing the call log or directory and another handset attempts to review it.
Number repeated	The telephone number entered is already stored in the directory.
Out of range OR no fur at base	The handset cannot communicate with the telephone base. Check the telephone base power connection or move closer.
Phone X:XX:XX	The handset is on a call.
Place in charger	The battery is very low. Place the handset in the telephone base or charger for recharging.
Ringer muted	The handset ringer is muted temporarily during an incoming call.
Ringer off	The handset ringer is turned off.
Saved	Your selection has been saved.
XX missed calls	There are calls that have not been reviewed in the call log.
XX new messages	There are new messages in the answering system.
** Paging **	All system handsets are being paged.

# Appendix

## Handset and telephone base indicators





### Handset light

<b>CHARGE</b>	On when the handset is charging in the telephone base or charger.
---------------	---

### Telephone base light

<b>IN USE</b>	On when the telephone line is in use. On when the answering system is answering a call. Flashes quickly when there is an incoming call. Flashes when another telephone sharing the same line is in use.
---------------	--

### Handset screen icons

	Battery status - flashes when the battery is low and needs charging.
	Battery status - animates when the battery is charging.
	Battery status - becomes solid when the battery is fully charged.
	New voicemail received from the telephone service provider.
<b>NEW</b>	New missed call(s) in call log.

# Appendix

## Battery

**It takes up to 16 hours for the battery to be fully charged. When it is fully charged, you can expect the following performance:**

Operation	Operating time
While in use (talking*)	Seven hours
While not in use (standby**)	Seven days

\*Operating times vary depending on your actual use and the age of the battery.

\*\*Handset is not charging or in use.

### **The battery needs charging when:**

- A new battery is installed in the handset.
- The handset beeps every minute while on a call.
- The handset beeps and **Low battery** displays on the handset.
- A battery is properly installed and the screen is blank.

### **CAUTION:**

#### **To reduce the risk of fire or injury, read and follow these instructions:**

- Use only the battery(ies) provided or equivalent. To order a replacement, visit our website at [www.vtechphones.com](http://www.vtechphones.com) or call 1 (800) 595-9511. In Canada, go to [www.vtechcanada.com](http://www.vtechcanada.com) or dial 1 (800) 267-7377.
- Do not dispose of the battery(ies) in a fire. Check with local waste management codes for special disposal instructions.
- Do not open or mutilate the battery(ies). Released electrolyte is corrosive and may cause burns or injury to the eyes or skin. The electrolyte may be toxic if swallowed.
- Exercise care in handling batteries in order not to create a short circuit with conductive materials.
- Charge the battery(ies) provided with or identified for use with this product only in accordance with the instructions and limitations specified in this manual.
- Observe proper polarity orientation between the battery and metallic contacts.
- To prevent fire or shock hazard, do not expose this product to water or any type of moisture.

# Appendix

## Troubleshooting

If you have difficulty with your telephone, please try the suggestions below. For customer service, visit our website at [www.vtechphones.com](http://www.vtechphones.com) or call 1 (800) 595-9511. In Canada, go to [www.vtechcanada.com](http://www.vtechcanada.com) or dial 1 (800) 267-7377.

### **My telephone does not work at all.**

- Make sure the battery is installed and charged correctly (pages 4 and 5). For optimum daily performance, return the handset to the telephone base or charger after use.
- Make sure the power adapter is securely plugged into an outlet not controlled by a wall switch.
- Make sure the telephone line cord is plugged firmly into the telephone base and the wall jack.
- Unplug the electrical power to the telephone base. Wait for approximately 15 seconds, then plug it back in. Allow up to one minute for the cordless handset and telephone base to synchronize.
- Charge the battery in the handset for up to 16 hours.
- If the battery is completely depleted, it can take up to 10 minutes to charge the handset before **Low battery** appears on the screen (page 5).
- Remove and install the battery again. If that still does not work, it may be necessary to purchase a new battery.
- Disconnect the telephone base from the telephone wall jack and plug in a working telephone. If the other telephone does not work, the problem is probably in the wiring or the local telephone service. Contact your telephone service provider.

### **There is no dial tone.**

- First, try all the above suggestions.
- Move the handset closer to the telephone base. It may be out of range.
- The telephone line cord may be malfunctioning. Install a new telephone line cord.
- Disconnect the telephone base from the telephone wall jack and connect a different telephone. If there is no dial tone on this telephone either, the problem is in your wiring or local telephone service. Contact your telephone service provider.

### **I cannot dial out.**

- First, try all the above suggestions.
- Make sure there is a dial tone before dialing. It is normal if the handset takes a second or two to synchronize with the telephone base before producing a dial tone. Wait an extra second before dialing.
- If the other telephones in your home are having the same problem, the problem is in the wiring or local telephone service. Contact your telephone service provider (charges may apply).
- Eliminate any background noise. Mute the cordless handset before dialing, or dial from another room in your home with less background noise.

### **Low battery shows on the handset screen.**

- Place the handset in the telephone base or charger for recharging.

# Appendix

## Troubleshooting

- Remove and install the battery again and use it until fully depleted, then charge the handset in the telephone base for up to 16 hours.
- If the above measures do not correct the problem, replace the battery.

### **The battery does not charge in the handset or the handset battery does not accept charge.**

- Make sure the handset is placed in the telephone base or charger correctly. The **CHARGE** light on the handset should be on.
- Remove and install the battery again, then charge for up to 16 hours.
- If the handset is in the telephone base or charger but the **CHARGE** light on the handset is not on, refer to **The CHARGE light is off** below.
- If the battery is completely depleted, it can take up to 10 minutes to charge the handset before **Low battery** appears on the screen (page 5).
- Purchase a new battery. Refer to the **Battery** section (page 33).

### **The CHARGE light is off.**

- Clean the charging contacts on the handset and telephone base or charger each month with a pencil eraser or a dry non-abrasive fabric.
- Make sure the power adapter and telephone line cord are plugged in correctly and securely.
- Unplug the power adapter. Wait for 15 seconds before plugging it back in. Allow up to one minute for the handset and telephone base or charger to reset.

### **The telephone does not ring when there is an incoming call.**

- Make sure the handset ringer volume is not set to off (page 9).
- Make sure the telephone line cord and power adapter are plugged in properly (page 2).
- The handset may be too far from the telephone base. Move it closer to the telephone base.
- There may be too many extension phones on the telephone line to allow all of them to ring simultaneously. Unplug some of them.
- If the other telephones in your home are having the same problem, the problem is in the wiring or local telephone service. Contact your telephone service provider (charges may apply).
- Other electronic products such as HAM Radios and other DECT Phones can cause interference with your cordless phone. Try installing your phone as far away as possible from these types of electronic devices.
- Test a working telephone at the telephone wall jack. If another telephone has the same problem, the problem is in the telephone wall jack. Contact your telephone service provider (charges may apply).
- The telephone line cord may be malfunctioning. Install a new telephone line cord.
- Remove and install the battery again and place the handset in the telephone base.
- Wait for the handset to synchronize with the telephone base. Allow up to one minute for this to take place.

# Appendix

## Troubleshooting

### **My handset beeps and is not performing normally.**

- Make sure the power cord is securely plugged into the telephone base. Plug the telephone base into a different working electrical outlet not controlled by a wall switch.
- Move the handset closer to the telephone base. It may be out of range.
- Reset the telephone base by unplugging the electrical power to the base. Wait for 15 seconds and plug it back in again. Allow up to one minute for the cordless handset and the telephone base to synchronize.
- Other electronic products such as HAM Radios and other DECT Phones can cause interference with your cordless phone. Try installing your phone as far away as possible from these types of electronic devices.

### **There is interference during a telephone conversation. My calls fade out when I am using the cordless handset.**

- The handset may be out of range. Move it closer to the telephone base.
- If you subscribe to high-speed Internet service (DSL - digital subscriber line) through your telephone line, you must install a DSL filter between the telephone line cord and the telephone wall jack. The filter prevents noise and caller ID problems caused by DSL interference. Contact your DSL service provider for more information about DSL filters.
- Appliances or other cordless telephones plugged into the same circuit as the telephone base can cause interference. Try moving the appliance or telephone base to another outlet.
- Other electronic products such as HAM Radios and other DECT Phones can cause interference with your cordless phone. Try installing your phone as far away as possible from these types of electronic devices.
- If your telephone is plugged in with a modem or a surge protector, plug the telephone (or modem/surge protector) into a different location. If this doesn't solve the problem, relocate your telephone or modem farther apart from each other, or use a different surge protector.
- The location of your telephone base can impact the performance of your cordless phone. For better reception, install the telephone base in a centralized location within your home or office, away from walls or other obstructions. In many environments, elevating the telephone base improves overall performance.
- Disconnect the telephone base from the telephone wall jack and plug in a corded telephone. If calls are still not clear, the problem is probably in the wiring or local telephone service. Contact your telephone service provider (charges may apply).
- If the other telephones in your home are having the same problem, the problem is in the wiring or local telephone service. Contact your telephone service provider (charges may apply).

### **I hear other calls when using the telephone.**

- Disconnect the telephone base from the telephone wall jack. Plug in a different telephone. If you still hear other calls, the problem is probably in the wiring or local telephone service. Contact your telephone service provider.



# Appendix

## Troubleshooting

### **I hear noise on the cordless handset and the keys do not work.**

- Make sure the telephone line cord is plugged in securely.

### **My caller ID features are not working properly.**

- Caller ID is a subscription service. You must subscribe to this service from your telephone service provider for this feature to work on your telephone.
- The caller may not be calling from an area which supports caller ID.
- Both your and the caller's telephone service providers must use equipment compatible with the caller ID service.
- The caller ID information shows after the first or second ring.
- If you subscribe to high-speed Internet service (DSL - digital subscriber line) through your telephone line, you must install a DSL filter between the telephone line cord and the telephone wall jack. The filter prevents noise and caller ID problems caused by DSL interference. Contact your DSL service provider for more information about DSL filters.

### **The telephone does not receive caller ID or the telephone does not show caller ID during call waiting.**

- Make sure you subscribe to caller ID with call waiting features provided by your telephone service provider.
- The caller may not be calling from an area which supports caller ID.
- Both your and the caller's telephone service providers must use equipment compatible with caller ID service.
- If you subscribe to high-speed Internet service (DSL - digital subscriber line) through your telephone line, you must install a DSL filter between the telephone line cord and the telephone wall jack. The filter prevents noise and caller ID problems caused by DSL interference. Contact your DSL service provider for more information about DSL filters.

### **Caller ID entries do not match the numbers I need to dial.**

- Caller ID service delivers 10 digits (the area code plus the seven-digit number). If you need to dial something other than 10 digits, see the view dialing options feature on page 28 for instructions on changing the number.
- If you dial seven digits for local calls, you may want to use the home area code feature (see page 12).

### **Out of range OR no pwr at base shows on the handset screen.**

- The handset may be out of range. Move it closer to the telephone base.
- Make sure the power cord is securely plugged into the telephone base. Use a working electrical outlet not controlled by a wall switch.
- Reset your telephone by unplugging the power adapter from the telephone base. Disconnect the battery from the cordless handset. Wait for 15 seconds, then plug in the power adapter and install the battery again. Place the handset in the telephone base and allow up to one minute for the handset and telephone base to synchronize.



# Appendix

## Troubleshooting

- Other electronic products such as HAM Radios and other DECT Phones can cause interference with your cordless phone. Try installing your phone as far away as possible from these types of electronic devices.

### **New voicemail and show on the handset display and I don't know why.**

- If **New voicemail** and  appear on the handset, your telephone has received a signal from your telephone service provider that you have a voicemail message waiting for you to retrieve from them. Contact your telephone service provider for more information on how to access your voicemail.

### **I cannot retrieve voicemail messages.**

- If you subscribe to voicemail service from your telephone service provider (charges may apply), contact your telephone service provider for more information on how to access your voicemail.

### **I subscribe to a nontraditional telephone service that uses my computer to establish connections, and my telephone doesn't work.**

- Make sure your computer is powered on.
- Make sure your Internet connection is working properly.
- Make sure that the software is installed and running for your nontraditional telephone service.
- Make sure to plug your USB telephone adapter into a dedicated USB port on your computer. Do not plug into a multiple port USB hub (USB splitter) that is not powered.
- In a few rare instances, the USB port on your computer may not have enough power. In these instances, try using a USB hub with its own external power supply.
- If you are using a firewall, it may prevent access to your nontraditional telephone service. Contact your service provider for more information.

### **Common cure for electronic equipment.**

- If the telephone is not responding normally, put the cordless handset in the telephone base. If it does not respond, try the following (in the order listed):
  1. Disconnect the power to the telephone base.
  2. Disconnect the battery on the cordless handset.
  3. Wait a few minutes before connecting power to the telephone base.
  4. Install the battery again and place the cordless handset in the telephone base .
  5. Wait for the cordless handset to synchronize with the telephone base. Allow up to one minute for this to take place.

# Appendix

## Important safety instructions

When using your telephone equipment, basic safety precautions should always be followed to reduce the risk of fire, electric shock and injury, including the following:

1. Read and understand all instructions.
2. Follow all warnings and instructions marked on the product.
3. Unplug this product from the wall outlet before cleaning. Do not use liquid or aerosol cleaners. Use a damp cloth for cleaning.
4. Do not use this product near water.
5. Do not place this product on an unstable table, shelf, stand or other unstable surfaces.
6. Slots and openings in the back or bottom of the telephone base and handset are provided for ventilation. To protect them from overheating, these openings must not be blocked by placing the product on a soft surface such as a bed, sofa or rug. This product should never be placed near or over a radiator or heat register. This product should not be placed in any area where proper ventilation is not provided.
7. This product should be operated only from the type of power source indicated on the marking label. If you are not sure of the type of power supply in your home or office, consult your dealer or local power company.
8. Do not allow anything to rest on the power cord. Do not install this product where the cord may be walked on.
9. Never push objects of any kind into this product through the slots in the telephone base or handset because they may touch dangerous voltage points or create a short circuit. Never spill liquid of any kind on the product.
10. To reduce the risk of electric shock, do not disassemble this product, but take it to an authorized service facility. Opening or removing parts of the telephone base or handset other than specified access doors may expose you to dangerous voltages or other risks. Incorrect reassembling can cause electric shock when the product is subsequently used.
11. Do not overload wall outlets and extension cords.
12. Unplug this product from the wall outlet and refer servicing to an authorized service facility under the following conditions:
  - A. When the power supply cord or plug is damaged or frayed.
  - B. If liquid has been spilled onto the product.
  - C. If the product has been exposed to rain or water.
  - D. If the product does not operate normally by following the operating instructions. Adjust only those controls that are covered by the operation instructions. Improper adjustment of other controls may result in damage and often requires extensive work by an authorized technician to restore the product to normal operation.
  - E. If the product has been dropped and the telephone base and/or handset has been damaged.
  - F. If the product exhibits a distinct change in performance.
13. Avoid using a telephone (other than cordless) during an electrical storm. There is a remote risk of electric shock from lightning.
14. Do not use the telephone to report a gas leak in the vicinity of the leak.
15. Only put the handset of your telephone next to your ear when it is in normal talk mode.
16. The power adapter is intended to be correctly oriented in a vertical or floor mount position. The prongs are not designed to hold the plug in place if it is plugged into a ceiling, under-the-table or cabinet outlet.

**SAVE THESE INSTRUCTIONS**

# Appendix

## Precautions for users of implanted cardiac pacemakers

Cardiac pacemakers (applies only to digital cordless telephones):

Wireless Technology Research, LLC (WTR), an independent research entity, led a multidisciplinary evaluation of the interference between portable wireless telephones and implanted cardiac pacemakers. Supported by the U.S. Food and Drug Administration, WTR recommends to physicians that:

### Pacemaker patients



- Should keep wireless telephones at least six inches from the pacemaker.
- Should NOT place wireless telephones directly over the pacemaker, such as in a breast pocket, when it is turned ON.
- Should use the wireless telephone at the ear opposite the pacemaker.

WTR's evaluation did not identify any risk to bystanders with pacemakers from other persons using wireless telephones.

## Operating range

This cordless telephone operates with the maximum power allowed by the Federal Communications Commission (FCC). Even so, this handset and telephone base can communicate over only a certain distance - which can vary with the locations of the telephone base and handset, the weather, and the layout of your home or office.

When the handset is out of range, the handset displays **Out of range OR no pwr at base**.

If there is a call while the handset is out of range, it may not ring, or if it does ring, the call may not connect well when you press /FLASH. Move closer to the telephone base, then press /FLASH to answer the call.

If the handset moves out of range during a telephone conversation, there may be interference. To improve reception, move closer to the telephone base.

## Maintenance

### Taking care of your telephone

Your cordless telephone contains sophisticated electronic parts, so it must be treated with care.

### Avoid rough treatment

Place the handset down gently. Save the original packing materials to protect your telephone if you ever need to ship it.

### Avoid water

Your telephone can be damaged if it gets wet. Do not use the handset outdoors in the rain, or handle it with wet hands. Do not install the telephone base near a sink, bathtub or shower.

### Electrical storms

Electrical storms can sometimes cause power surges harmful to electronic equipment. For your own safety, take caution when using electrical appliances during storms.

### Cleaning your telephone

Your telephone has a durable plastic casing that should retain its luster for many years. Clean it only with a soft cloth slightly dampened with water or mild soap. Do not use excess water or cleaning solvents of any kind.

Remember that electrical appliances can cause serious injury if used when you are wet or standing in the water. If the telephone base should fall into the water, DO NOT RETRIEVE IT UNTIL YOU UNPLUG THE POWER CORD AND TELEPHONE LINE CORDS FROM THE WALL. Then remove the telephone by the unplugged cords.

# Appendix

## About cordless telephones

- **Privacy:** The same features that make a cordless telephone convenient create some limitations. Telephone calls are transmitted between the telephone base and the cordless handset by radio waves, so there is a possibility that the cordless telephone conversations could be intercepted by radio receiving equipment within range of the cordless handset. For this reason, you should not think of cordless telephone conversations as being as private as those on corded telephones.
- **Electrical power:** The telephone base of this cordless telephone must be connected to a working electrical outlet. The electrical outlet should not be controlled by a wall switch. Calls cannot be made from the cordless handset if the telephone base is unplugged, switched off or if the electrical power is interrupted.
- **Potential TV interference:** Some cordless telephones operate at frequencies that may cause interference to televisions and VCRs. To minimize or prevent such interference, do not place the telephone base of the cordless telephone near or on top of a TV or VCR. If interference is experienced, moving the cordless telephone farther away from the TV or VCR often reduces or eliminates the interference.
- **Rechargeable batteries:** Exercise care in handling batteries in order not to create a short circuit with conducting material such as rings, bracelets, and keys. The battery or conductor may overheat and cause harm. Observe proper polarity between the battery and the battery charger.
- **Nickel-metal hydride rechargeable batteries:** Dispose of these batteries in a safe manner. Do not burn or puncture the battery. Like other batteries of this type, if burned or punctured, they could release caustic material which could cause injury.

## The RBRC® seal

The RBRC® seal on the nickel-metal hydride battery indicates that VTech Communications, Inc. is voluntarily participating in an industry program to collect and recycle these batteries at the end of their useful lives, when taken out of service within the United States and Canada.

The RBRC® program provides a convenient alternative to placing used nickel-metal hydride batteries into the trash or municipal waste, which may be illegal in your area.

VTech's participation in RBRC® makes it easy for you to drop off the spent battery at local retailers participating in the RBRC® program or at authorized VTech product service centers. Please call **1 (800) 8 BATTERY™** for information on Ni-MH battery recycling and disposal bans/restrictions in your area. VTech's involvement in this program is part of its commitment to protecting our environment and conserving natural resources.

**RBRC® is a registered trademark of Rechargeable Battery Recycling Corporation.**



# Appendix

## Warranty

### **What does this limited warranty cover?**

The manufacturer of this VTech Product warrants to the holder of a valid proof of purchase (“Consumer” or “you”) that the Product and all accessories provided in the sales package (“Product”) are free from defects in material and workmanship, pursuant to the following terms and conditions, when installed and used normally and in accordance with the Product operating instructions. This limited warranty extends only to the Consumer for Products purchased and used in the United States of America and Canada.

### **What will VTech do if the Product is not free from defects in materials and workmanship during the limited warranty period (“Materially Defective Product”)?**

During the limited warranty period, VTech’s authorized service representative will repair or replace at VTech’s option, without charge, a Materially Defective Product. If we repair the Product, we may use new or refurbished replacement parts. If we choose to replace the Product, we may replace it with a new or refurbished Product of the same or similar design. We will retain defective parts, modules, or equipment. Repair or replacement of the Product, at VTech’s option, is your exclusive remedy. VTech will return the repaired or replacement Products to you in working condition. You should expect the repair or replacement to take approximately 30 days.

### **How long is the limited warranty period?**

The limited warranty period for the Product extends for ONE (1) YEAR from the date of purchase. If VTech repairs or replaces a Materially Defective Product under the terms of this limited warranty, this limited warranty also applies to the repaired or replacement Product for a period of either (a) 90 days from the date the repaired or replacement Product is shipped to you or (b) the time remaining on the original one-year warranty; whichever is longer.

### **What is not covered by this limited warranty?**

This limited warranty does not cover:

1. Product that has been subjected to misuse, accident, shipping or other physical damage, improper installation, abnormal operation or handling, neglect, inundation, fire, water or other liquid intrusion; or
2. Product that has been damaged due to repair, alteration or modification by anyone other than an authorized service representative of VTech; or
3. Product to the extent that the problem experienced is caused by signal conditions, network reliability, or cable or antenna systems; or
4. Product to the extent that the problem is caused by use with non-VTech accessories; or
5. Product whose warranty/quality stickers, product serial number plates or electronic serial numbers have been removed, altered or rendered illegible; or
6. Product purchased, used, serviced, or shipped for repair from outside the United States of America or Canada, or used for commercial or institutional purposes (including but not limited to Products used for rental purposes); or
7. Product returned without a valid proof of purchase (see item 2 below); or
8. Charges for installation or set up, adjustment of customer controls, and installation or repair of systems outside the unit.

# Appendix

## Warranty (continued)

### How do you get warranty service?

To obtain warranty service in the USA, please visit our website at [www.vtechphones.com](http://www.vtechphones.com) or call 1 (800) 595-9511. In Canada, go to [www.vtechcanada.com](http://www.vtechcanada.com) or dial 1 (800) 267-7377. NOTE: Before calling for service, please review the user's manual - a check of the Product's controls and features may save you a service call.

Except as provided by applicable law, you assume the risk of loss or damage during transit and transportation and are responsible for delivery or handling charges incurred in the transport of the Product(s) to the service location. VTech will return repaired or replaced Product under this limited warranty. Transportation, delivery or handling charges are prepaid. VTech assumes no risk for damage or loss of the Product in transit. If the Product failure is not covered by this limited warranty, or proof of purchase does not meet the terms of this limited warranty, VTech will notify you and will request that you authorize the cost of repair prior to any further repair activity. You must pay for the cost of repair and return shipping costs for the repair of Products that are not covered by this limited warranty.

### What must you return with the Product to get warranty service?

1. Return the entire original package and contents including the Product to the VTech service location along with a description of the malfunction or difficulty; and
2. Include a "valid proof of purchase" (sales receipt) identifying the Product purchased (Product model) and the date of purchase or receipt; and
3. Provide your name, complete and correct mailing address, and telephone number.

### Other limitations

This warranty is the complete and exclusive agreement between you and VTech. It supersedes all other written or oral communications related to this Product. VTech provides no other warranties for this Product. The warranty exclusively describes all of VTech's responsibilities regarding the Product. There are no other express warranties. No one is authorized to make modifications to this limited warranty and you should not rely on any such modification.

**State/Provincial Law Rights:** This warranty gives you specific legal rights, and you may also have other rights, which vary from state to state or province to province.

**Limitations:** Implied warranties, including those of fitness for a particular purpose and merchantability (an unwritten warranty that the Product is fit for ordinary use) are limited to one year from the date of purchase. Some states/provinces do not allow limitations on how long an implied warranty lasts, so the above limitation may not apply to you. In no event shall VTech be liable for any indirect, special, incidental, consequential, or similar damages (including, but not limited to lost profits or revenue, inability to use the Product or other associated equipment, the cost of substitute equipment, and claims by third parties) resulting from the use of this Product. Some states/provinces do not allow the exclusion or limitation of incidental or consequential damages, so the above limitation or exclusion may not apply to you.

**Please retain your original sales receipt as proof of purchase.**



# Appendix

## FCC, ACTA and IC regulations

### FCC Part 15

This equipment has been tested and found to comply with the requirements for a Class B digital device under Part 15 of the Federal Communications Commission (FCC) rules. These requirements are intended to provide reasonable protection against harmful interference in a residential installation. This equipment generates, uses and can radiate radio frequency energy and, if not installed and used in accordance with the instructions, may cause harmful interference to radio communications. However, there is no guarantee that interference will not occur in a particular installation. If this equipment does cause harmful interference to radio or television reception, which can be determined by turning the equipment off and on, the user is encouraged to try to correct the interference by one or more of the following measures:

- Reorient or relocate the receiving antenna.
- Increase the separation between the equipment and receiver.
- Connect the equipment into an outlet on a circuit different from that to which the receiver is connected.
- Consult the dealer or an experienced radio/TV technician for help.

Changes or modifications to this equipment not expressly approved by the party responsible for compliance could void the user's authority to operate the equipment.

This device complies with Part 15 of the FCC rules. Operation is subject to the following two conditions: (1) this device may not cause harmful interference, and (2) this device must accept any interference received, including interference that may cause undesired operation. Privacy of communications may not be ensured when using this telephone.

To ensure safety of users, the FCC has established criteria for the amount of radio frequency energy that can be safely absorbed by a user or bystander according to the intended usage of the product. This product has been tested and found to comply with the FCC criteria. The handset may be safely held against the ear of the user. The telephone base shall be installed and used such that parts of the user's body other than the hands are maintained at a distance of approximately 20 cm (8 inches) or more.

This Class B digital apparatus complies with Canadian ICES-003.

### FCC Part 68 and ACTA

This equipment complies with Part 68 of the FCC rules and with technical requirements adopted by the Administrative Council for Terminal Attachments (ACTA). The label on the back or bottom of this equipment contains, among other things, a product identifier in the format US:AAAEQ##TXXXX. This identifier must be provided to your telephone service provider upon request.

The plug and jack used to connect this equipment to premises wiring and the telephone network must comply with applicable Part 68 rules and technical requirements adopted by ACTA. A compliant telephone cord and modular plug is provided with this product. It is designed to be connected to a compatible modular jack that is also compliant. An RJ11 jack should normally be used for connecting to a single line and an RJ14 jack for two lines. See Installation Instructions in the user's manual.

The Ringer Equivalence Number (REN) is used to determine how many devices you may connect to your telephone line and still have them ring when you are called. The REN for this product is encoded as the 6th and 7th characters following the US: in the product identifier (e.g., if ## is 03, the REN is 0.3). In most, but not all areas, the sum of all RENs should be five (5.0) or less. For more information, please contact your telephone service provider.

This equipment may not be used with Party Lines. If you have specially wired alarm dialing equipment connected to your telephone line, ensure the connection of this equipment does not disable your alarm equipment. If you have questions about what will disable alarm equipment, consult your telephone service provider or a qualified installer.

If this equipment is malfunctioning, it must be unplugged from the modular jack until the problem has been corrected. Repairs to this telephone equipment can only be made by the manufacturer or its authorized agents. For repair procedures, follow the instructions outlined under the Warranty.

# Appendix

## FCC, ACTA and IC regulations (continued)

If this equipment is causing harm to the telephone network, the telephone service provider may temporarily discontinue your telephone service. The telephone service provider is required to notify you before interrupting service. If advance notice is not practical, you will be notified as soon as possible. You will be given the opportunity to correct the problem and the telephone service provider is required to inform you of your right to file a complaint with the FCC. Your telephone service provider may make changes in its facilities, equipment, operation, or procedures that could affect the proper functioning of this product. The telephone service provider is required to notify you if such changes are planned.

If this product is equipped with a corded or cordless handset, it is hearing aid compatible.

If this product has memory dialing locations, you may choose to store emergency telephone numbers (e.g., police, fire, medical) in these locations. If you do store or test emergency numbers, please:

Remain on the line and briefly explain the reason for the call before hanging up.

Perform such activities in off-peak hours, such as early morning or late evening.

### Industry Canada

Operation is subject to the following two conditions: (1) this device may not cause harmful interference, and (2) this device must accept any interference, including interference that may cause undesired operation.

The term "IC:" before the certification/registration number only signifies that the Industry Canada technical specifications were met.

The Ringer Equivalence Number (REN) for this terminal equipment is 0.1. The REN is an indication of the maximum number of devices allowed to be connected to a telephone interface. The termination on an interface may consist of any combination of devices subject only to the requirement that the sum of the RENs of all the devices does not exceed five.

This product meets the applicable Industry Canada technical specifications.



# Appendix

## Technical specifications

---

Frequency control	Crystal controlled PLL synthesizer
Transmit frequency	Handset: 1921.536-1928.448 MHz Telephone base: 1921.536-1928.448MHz
Channels	5
Nominal effective range	Maximum power allowed by FCC and IC. Actual operating range may vary according to environmental conditions at the time of use.
Size	Handset: 6.50 X 2.0 X 1.26 in (165.0 X 51.0 X 32.0 mm) Telephone base: 3.55 X 3.44 X 4.67 in (90.2 X 87.5 X 118.5 mm) Charger: 2.91 X 3.19 X 1.85 in (74.0 X 81.0 X 47.0 mm)
Weight	Handset: 4.59oz (130.0g) (including battery) Telephone base: 4.32oz (122.6g) Charger: 1.76oz (50.0g)
Power requirements	Handset: 2.4V 400mAh Ni-MH battery Telephone base: 6V AC @ 300mA Charger: 6V AC @ 300mA
Memory	Handset directory: 30 memory locations (10 speed dial inclusive); up to 30 digits and 15 characters Handset call log: 30 memory locations; up to 24 digits and 15 characters

---

# Appendix

## Index

### A

About caller ID 25  
About cordless telephones 41  
Alphabetical search 21  
Answer a call 14

### B

Battery 33  
Battery charging 5  
Battery installation 4

### C

Caller ID 25  
Call log 26  
Call log display screen messages 30  
Call waiting 14  
Channel 15  
Character chart 20  
Charging 5  
CID time synchronization 12  
Clear voicemail 10

### D

Delete a directory entry 22  
Delete a redial entry 17  
Delete a speed dial entry 24  
Delete from the call log 29  
Dial a call log number 28  
Dial a number from the directory 21  
Dial a redial entry 17  
Dialing pause 19, 22, 29  
Dial mode 12  
Directory 18  
DSL filter 2

### E

Edit a directory entry 22  
End a call 14

### F

Find handset 15

### H

Handset layout 6, 7  
Handset light 32  
Handset screen icons 32  
Home area code 12

### I

Important safety instructions 39  
Indicators 32  
Installation 2

### K

Key tone 11

### L

Listening volume 14

### M

Maintenance 40  
Make a call 14  
Memory match 27  
Missed calls indicator 26

### O

Operating range 40

### P

Pacemaker patients 40  
Paging handset 15  
Parts checklist 1  
Phonebook 18  
Precautions for users of implanted cardiac  
pacemakers 40  
Redial a call 14

### R

Redial list 17  
Review the call log 27  
Review the directory 20, 21  
Ringer 9  
Ringer volume 9

# Appendix

## Index

### S

- Safety instructions 39
- Save a call log entry to the directory 28
- Screen display messages 31
- Screen icons 32
- Speed dial 23
- Store a directory entry 19
- Store a speed dial entry 23
- Store from redial 19

### T

- Technical specifications 46
- Telephone base installation 2
- Telephone base layout 8
- Telephone base light 32
- Temporary tone dialing 14
- Troubleshooting 34

### V

- View dialing options 28
- Volume 9, 14

### W

- Wall mounting 3
- Warranty 42
- Website 13

VTECH TELECOMMUNICATIONS LTD.  
A member of THE VTECH GROUP OF COMPANIES.  
Distributed in the U.S.A. by VTech Communications, Inc.  
Beaverton, Oregon 97008  
Distributed in Canada by VTech Technologies Canada, Ltd.  
Richmond, B.C. V6W 1L5  
Copyright © 2010 for VTECH TELECOMMUNICATIONS LTD.  
Printed in China.

91-003639-010-100