



at&t

User's manual

**TL92271/TL92371/TL92471
DECT 6.0 cordless telephone/
answering system with
BLUETOOTH® wireless technology**



Congratulations

on purchasing your new AT&T product. Before using this AT&T product, please read the **Important safety information** on pages 111-112 of this user's manual. Please thoroughly read the user's manual for all the feature operations and troubleshooting information you need to install and operate your new AT&T product. You can also visit our website at **www.telephones.att.com** or call **1 (800) 222-3111**. In Canada, dial **1 (866) 288-4268**.

Model number: TL92271 (two handsets)
TL92371 (three handsets)
TL92471 (four handsets)

Type: DECT 6.0 cordless telephone/answering system
with Bluetooth wireless technology

Serial number: _____

Purchase date: _____

Place of purchase: _____

Both the model and serial number of your AT&T product can be found on the bottom of the telephone base.



Telephones identified with this logo have reduced noise and interference when used with most T-coil equipped hearing aids and cochlear implants. The TIA-1083 Compliant Logo is a trademark of the Telecommunications Industry Association. Used under license.



The ENERGY STAR® program (www.energystar.gov) recognizes and encourages the use of products that save energy and help protect our environment. We are proud to mark this product with the ENERGY STAR® label indicating it meets the latest energy efficiency guidelines.

The *Bluetooth*® word mark and logos are owned by Bluetooth SIG, Inc. and any use of such marks by Advanced American Telephones and its parent, VTech Holdings Limited, is under license. VTech Holdings Limited is a member of Bluetooth SIG, Inc. Other trademarks and trade names are those of their respective owners.

© 2009-2010 Advanced American Telephones. All Rights Reserved. AT&T and the AT&T logo are trademarks of AT&T Intellectual Property licensed to Advanced American Telephones, San Antonio, TX 78219. Printed in China.

Parts checklist

Your telephone package contains the following items. Save your sales receipt and original packaging in the event warranty service is necessary.

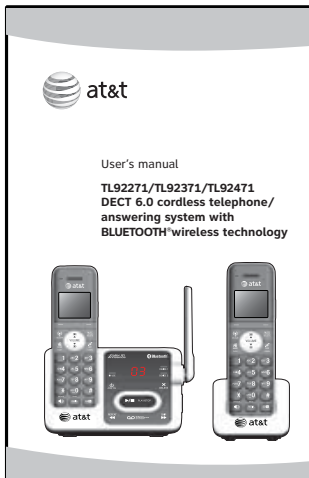

User's manual



Quick start guide



Cordless handsets
(2 for TL92271)
(3 for TL92371)
(4 for TL92471)

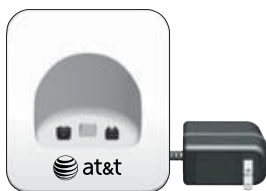

Charger for cordless handset with power adapter installed
(1 for TL92271)
(2 for TL92371)
(3 for TL92471)

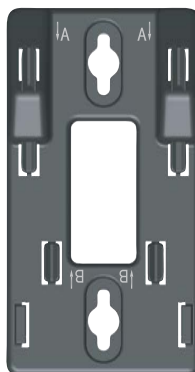

Wall mount bracket



Power adapter for telephone base

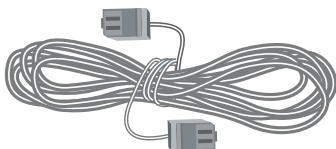

Telephone line cord



Battery compartment covers
(2 for TL92271)
(3 for TL92371)
(4 for TL92471)



Batteries for cordless handsets
(2 for TL92271)
(3 for TL92371)
(4 for TL92471)



Telephone base

User's manual

TL92271/TL92371/TL92471 DECT 6.0 cordless telephone/ answering system with BLUETOOTH® wireless technology



Table of contents

Getting started

Quick reference guide - telephone base.....	1
Quick reference guide - handset.....	3
Installation.....	6
Telephone base installation.....	7
Charger installation.....	8
Battery installation and charging.....	9
Battery charging.....	10
Installation options.....	11
Tabletop to wall mount installation.....	11
Wall mount to tabletop installation.....	12

Bluetooth

Introducing Bluetooth.....	13
Glossary of terms.....	14
Bluetooth setup.....	15
Add a cell phone.....	15
Add a headset.....	17
Auto connection.....	18
Device list and connection.....	19
Review the active device list.....	19
Connect/disconnect an active device.....	19
Remove a device.....	20
Rename a device.....	21
Replace an active device.....	22
Bluetooth connection from idle mode.....	22
Download directory.....	23
Interruption to directory download.....	25

View the directory download information.....	25
Change PIN.....	26

Handset settings

Telephone settings.....	27
Ringers.....	27
Ringer volume.....	27
Ringer tone.....	28
Set date and time.....	29
Settings.....	30
LCD language.....	30
Display alerts.....	31
Missed call indicator.....	31
Voicemail indicator.....	32
No line.....	33
Download fail.....	33
Use caller ID to automatically set date and time.....	34
Rename handset.....	34
Key tone.....	35
Dial mode.....	35
Voice announce caller ID.....	36
Website.....	36
Home area code.....	37
Cell area code.....	38
Telephone base ringer volume....	39
Answering system settings.....	39

Telephone operation

Making, answering and ending a call.....	40
Using a handset for home calls.....	40

Table of contents

Using a Bluetooth headset for home calls.....	40	End a PTT call.....	59
Call waiting on the home line	41	Answer an incoming call during PTT	59
Make, answer or end a cell call	42	Make an outgoing call during PTT	59
Call waiting on the cell line.....	42		
Answer a cell call while on a home call.....	43	Directory	
Cell phone voicemail.....	43	About the directory.....	60
Answer a home call while on a cell call	43	Create and review entries.....	61
Conference calls.....	44	Create a new entry in the home directory	61
Conference home and cell calls	44	To add a predialed telephone number to the directory.....	63
Options while on calls.....	45	Review the directory.....	64
Handset speakerphone.....	45	3-character alphabetical search.....	64
Volume control	45	Dial, edit or delete a directory	65
Silencing the ringer	45	Dial a directory entry.....	65
Mute	45	Edit a directory entry.....	65
Temporary tone dialing	46	Edit the type of a directory entry.....	66
Hold.....	46	Delete a directory entry.....	66
Equalizer.....	46	Remove a downloaded directory.....	66
Chain dialing.....	47	Speed Dial.....	67
Transfer a call.....	48	Assign a speed dial slot.....	67
Redial.....	49	Reassign a speed dial slot.....	67
Review the redial list.....	49	Dial a speed dial entry.....	67
Dial a redial entry.....	49	Delete a speed dial entry.....	68
Save a redial entry to the directory	50		
Delete a redial entry.....	50	Caller ID	
Multiple handset use		About caller ID	69
Handset locator.....	51	Information about caller ID with call waiting	69
Join a call in progress.....	51	Caller ID operation	70
Intercom.....	52	How the caller ID history (caller ID log) works.....	70
Answer an incoming call during an intercom call	53	Memory match.....	70
Call transfer using intercom	54	To review the caller ID log	71
Push-to-talk (PTT)	55	View dialing options.....	72
PTT on/off.....	55	Dial a caller ID log entry	72
PTT to a single handset.....	56	Save a caller ID log entry to the directory	73
PTT to all handsets.....	57	To delete a single entry	74
Answer a PTT call.....	58		
Change a one-to-one PTT to intercom call.....	58		

Table of contents

To delete all entries.....	74	Telephone base indicator lights	91
Reasons for missing caller ID information	74	Screen messages.....	92
Handset settings		Display screen messages.....	92
Answering system settings.....	75	Expand your telephone system.....	95
Answer on/off.....	75	Add and register a handset (optional).....	95
Announcement	76	Deregister handsets.....	96
Play your announcement	76	Troubleshooting	97
Record your own announcement.....	76	Maintenance.....	110
Delete your announcement.....	77	Important safety information	111
Call screening.....	78	Safety information.....	111
Number of rings.....	79	Especially about corded telephones	111
Remote access code.....	80	Precautions for users of implanted cardiac pacemakers.....	112
Message alert tone.....	80	Pacemaker patients.....	112
Recording time.....	81	Especially about telephone answering systems.....	112
Answering system		FCC Part 68 and ACTA.....	113
About the answering system.....	82	FCC Part 15.....	114
Answering system and voicemail.....	82	Limited warranty.....	115
Using the answering system and voicemail together.....	82	Technical specifications	117
Message capacity	83	DECT 6.0 digital technology.....	117
Voice prompts	83	Telephone operating range	117
Call screening.....	83	Extended range and clarity	117
Call intercept	83	Index.....	118
Temporarily turning off the message alert tone.....	84		
Message playback.....	85		
Delete all old messages.....	87		
Record and play memos	87		
Base message counter displays.....	88		
Message window displays	88		
Remote access.....	89		
To remotely access the answering system.....	89		
Remote commands.....	89		
Appendix			
Handset screen icons.....	90		
Alert tones and lights	91		
Handset alert tones.....	91		
Telephone base alert tones.....	91		
Handset indicator lights.....	91		

Quick reference guide - telephone base

⏻/ANS ON

Press to turn the answering system on or off (page 75).

📞/HANDSET LOCATOR

Press to page all system handsets (page 51).

⏮/REPEAT

Press to repeat a message or press twice to play the previous message (page 85).

▶/PLAY/STOP

Press to play messages (page 85).
Press to stop message playback (page 85).

X/DELETE

Press to delete the message currently playing (page 85).
When the phone is not in use, press twice to delete all previously reviewed messages (page 87).

▶▶/SKIP

Press to skip to the next message (page 85).

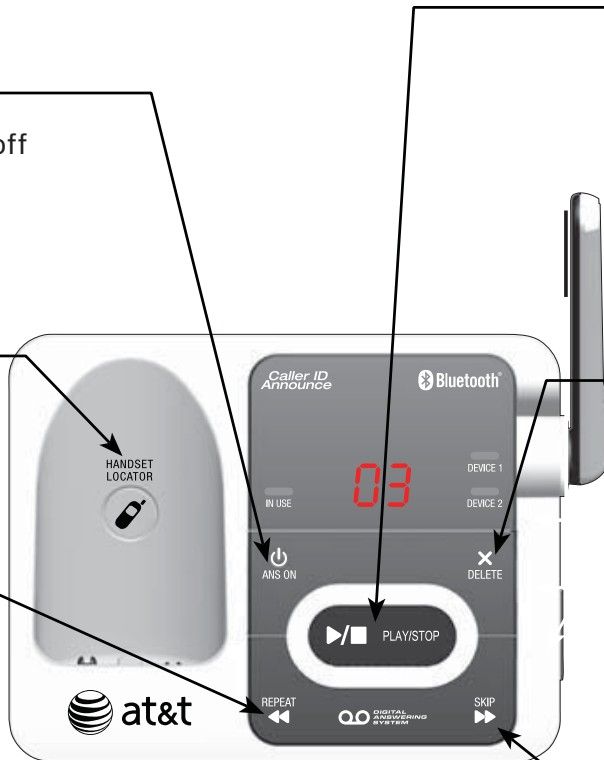

Message counter

Number of messages (or during playback, message number currently playing).

IN USE light

On when the handset is in use, or when the answering system is answering an incoming call, or when you are registering a handset.

Flashes when another telephone is in use on the same line, or when you are deregistering handset(s) from the telephone base.

Flashes when there is an incoming call.



DEVICE1/DEVICE2 lights

On when the telephone base is paired and connected with a Bluetooth device.

Flash alternately while pairing a Bluetooth device.

Flashes quickly when there is an incoming cell call.

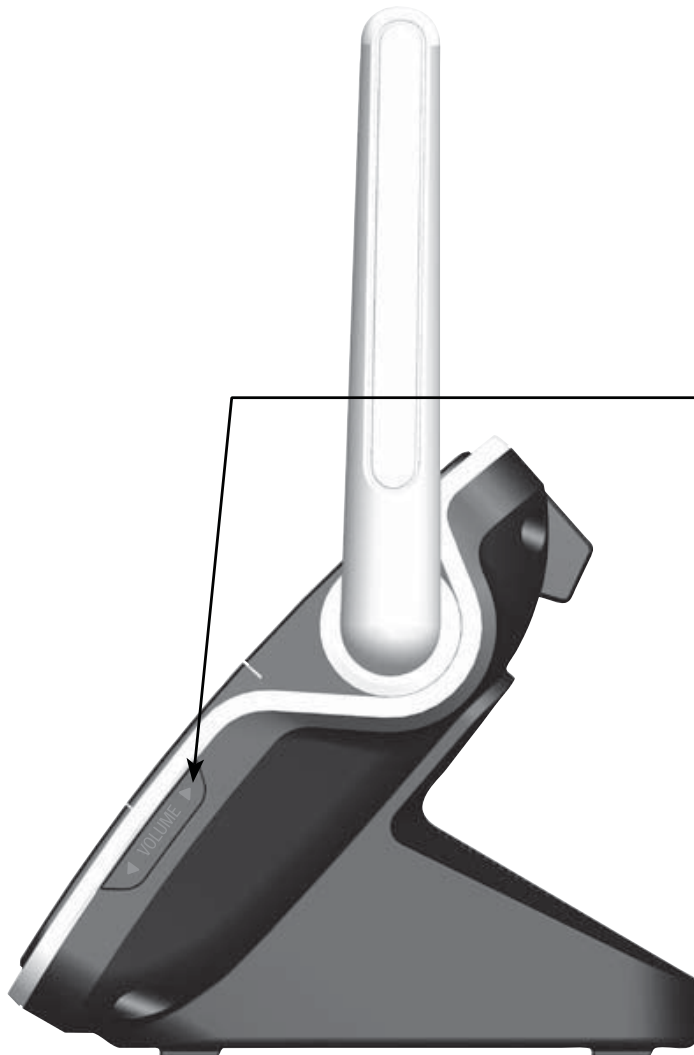

▼ VOLUME ▲

Press to adjust the volume during message playback (page 85).

When the phone is not in use, press to adjust the telephone base ringer volume (page 39).

Quick reference guide - handset

CHARGE light

On when the handset is charging in the telephone base or charger.

Softkeys (2)

Press to select a menu item displayed above the key.

While in a menu, press to select an item, or save an entry or setting.

CELLULAR

Press to make or answer a cell call (page 42).

During a cell call, press to answer an incoming call when you hear a call waiting alert (page 42).

Flashes quickly when there is an incoming cell call.

Flashes slowly when a cell call is on hold.

HOME/FLASH

Press to make or answer a home call (page 40).

During a home call, press to answer an incoming call when you hear a call waiting alert (page 42).

Flashes quickly when there is an incoming home call.

Flashes slowly when a home call is on hold.

1

While reviewing a caller ID history entry, press repeatedly to add or remove **1** in front of the telephone number before dialing or saving it in the directory (page 72).

tone X

Press to switch to tone dialing temporarily during a call if you have pulse service (page 46).

Press to toggle the name order when saving Caller ID entry into directory (page 73).

SPEAKER

Press to make or answer a home call.

Press to turn on the handset speakerphone.

Press again to resume normal handset use (page 45).

REDIAL/PAUSE

Press repeatedly to view the last 10 numbers dialed (page 49).

While entering numbers, press and hold to insert a dialing pause (page 61).

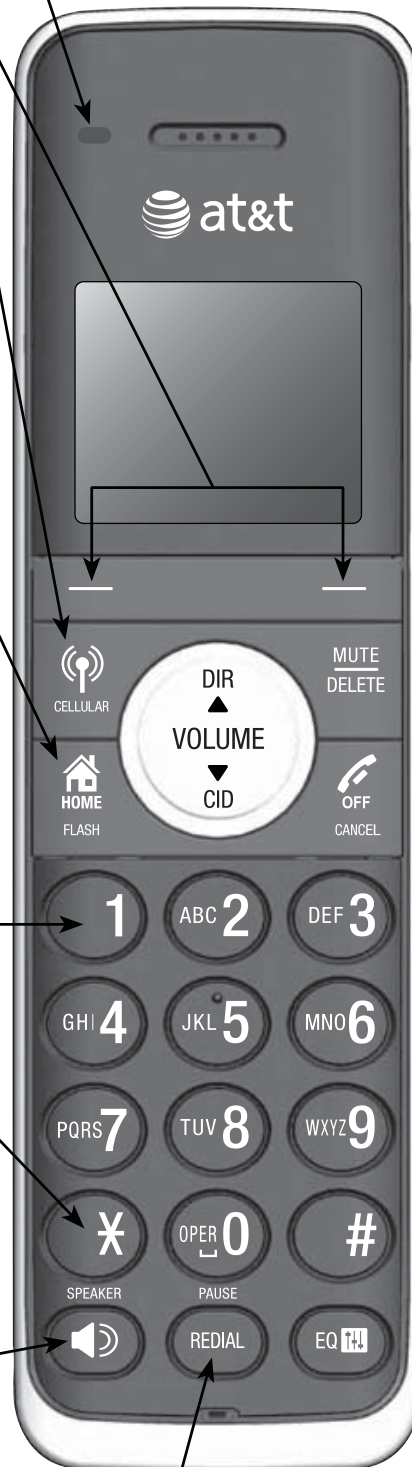

Quick reference guide - handset



DIR/▲/VOLUME

Press to scroll up while in menus.
During a call or message playback, press to increase the listening volume (page 45 or page 86).
Press to show directory entries when the telephone is not in use (page 64).
While entering names or numbers in the directory, press to move the cursor to the left (page 61).

MUTE/DELETE

During a call, press to mute the microphone (page 45).
While predialing, press to delete digits (page 40).
While reviewing the redial list, directory or caller ID history, press to delete an individual entry (pages 50, 66 and 74).
While entering or editing a directory entry, press to erase a digit or character.
While the handset is ringing, press to silence the ringer temporarily.
During message or announcement playback, press to delete a message or announcement.

OFF/CANCEL

While using menus, press to cancel an operation, back up to the previous menu, or exit the menu display (page 5).
Press and hold to return to idle mode.
During a call, press to hang up (page 40).
Press and hold while the telephone is not in use to erase the displayed messages (**XX Missed calls** and **Download fail**).
While the handset is ringing, press to silence the ringer temporarily.

CID/▼/VOLUME

Press to scroll down while in menus.
During a call or message playback, press to decrease the listening volume (page 45 or page 86).
Press to show the caller ID history when the telephone is not in use (page 71).
While entering names or numbers in the directory, press to move the cursor to the right (page 61).

(pound key)

Press repeatedly to display other dialing options when reviewing a caller ID history entry (page 72).

EQ

During an outside call, intercom call, message or announcement playback, press to change the quality of the audio to best suit your hearing (page 46).

Quick reference guide - handset



PUSH TO TALK

Press to begin a one-to-one or one-to-all broadcast.

Press and hold to begin a one-to-all broadcast when the handset is not in use.

Main menu

The selected menu item is highlighted.



Feature menu

- Play messages (page 85)
- Answering sys (page 82)
- Directory (page 60)
- Caller ID log (page 69)
- Intercom (page 52)
- Bluetooth (page 13)
- Ringers (page 27)
- Set date/time (page 29)
- Settings (page 30)
- Website (page 36)

Using menus

1. Press **MENU** in idle mode (when the telephone is not in use) to enter the main menu.
2. Use **CID**▼ or ▲**DIR** to scroll through menu items.
3. Press **SELECT** to select or save the highlighted item.
-OR-
Press **OFF/CANCEL** to cancel an operation, back up to the previous menu or exit the menu display.
-OR-
Press and hold **OFF/CANCEL** to return to idle mode.

i **NOTE:** If no key is pressed, the handset automatically returns to idle mode after 30 seconds.

You must install and charge the handset battery before using the cordless handset.



See pages 9-10 for easy instructions.

Install the telephone base close to a telephone jack and a power outlet not controlled by a wall switch. The telephone base can be placed on a flat surface or vertically mounted on the wall (page 11). For optimum range and better reception, place the telephone base in a central and open location.

You may hear interference if your cellular phone is too close to the telephone base during a **CELLULAR** call. Make sure that your Bluetooth enabled cellular phone is within 15 feet of the telephone base in order to maintain a clear and consistent connection between your Bluetooth cell phone, telephone base and cell tower.

If you subscribe to high-speed Internet service (digital subscriber line - DSL) through your telephone line, you must install a DSL filter between the telephone line cord and the telephone wall jack (page 7). The filter prevents noise and caller ID problems caused by DSL interference. Please contact your DSL service provider for more information about DSL filters.

Your product may be shipped with a protective sticker covering the handset or telephone base display - remove it before use.

For customer service or product information, visit our website at **www.telephones.att.com** or call **1 (800) 222-3111**. In Canada, dial **1 (866) 288-4268**.

Avoid placing the telephone base too close to:

- Communication devices such as: television sets, VCRs, or other cordless telephones.
- Excessive heat sources.
- Noise sources such as a window with traffic outside, motors, microwave ovens, refrigerators, or fluorescent lighting.
- Excessive dust sources such as a workshop or garage.
- Excessive moisture.
- Extremely low temperature.
- Mechanical vibration or shock such as on top of the washing machine or work bench.

Telephone base installation

If you subscribe to high-speed Internet service (digital subscriber line - DSL) through your telephone line, you must install a DSL filter between the telephone line cord and the telephone wall jack. The filter prevents noise and caller ID problems caused by DSL interference. Please contact your DSL service provider for more information about DSL filters.

Follow the steps below to install the telephone.

i NOTE: The telephone base comes ready for tabletop use. If you want to mount your telephone on a wall, refer to **Installation options** on pages 11-12 for details.

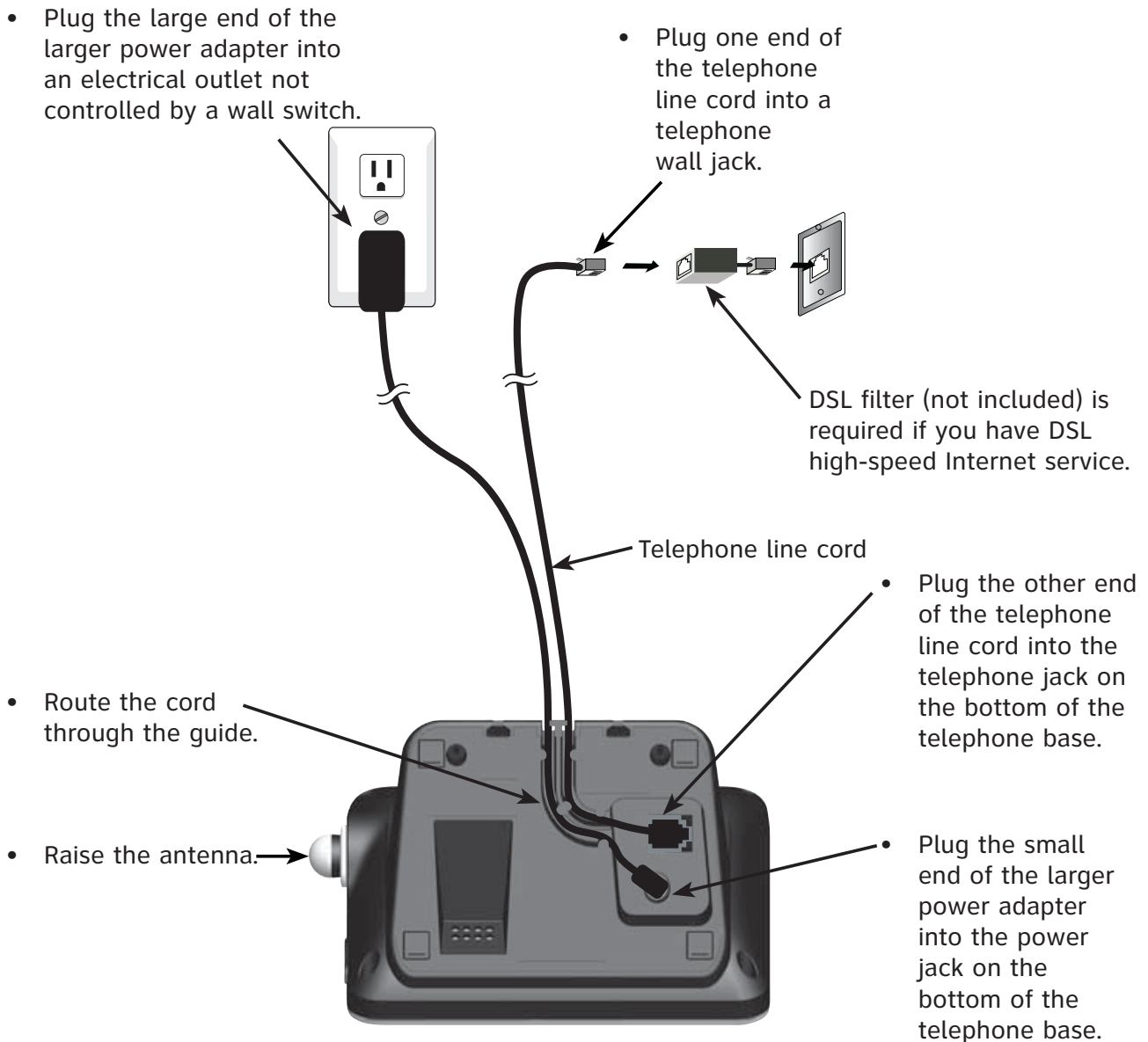

Charger installation

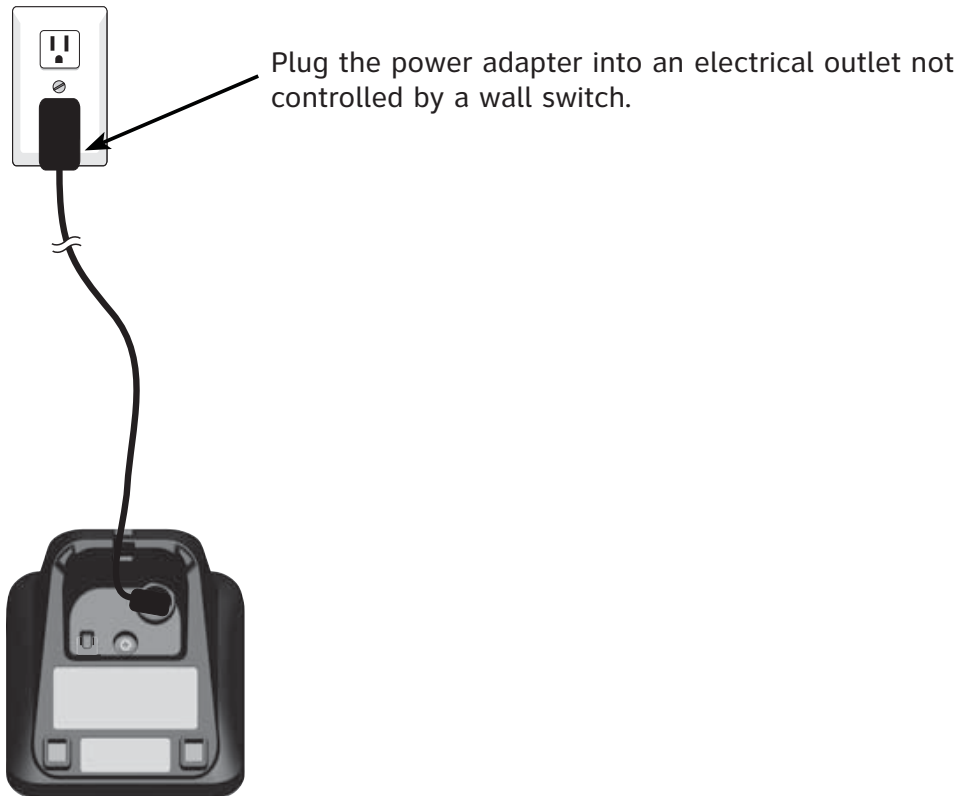

IMPORTANT INFORMATION:

1. Use only the power adapter(s) provided with this product. To obtain a replacement, visit our website at www.telephones.att.com or call **1 (800) 222-3111**. In Canada, dial **1 (866) 288-4268**.
2. The power adapters are intended to be correctly oriented in a vertical or floor mount position. The prongs are not designed to hold the plug in place if it is plugged into a ceiling, under-the-table or cabinet outlet.

Battery installation and charging

Install the battery as shown below.



Step 1

Plug the battery connector securely into the socket inside the handset battery compartment, matching the color-coded label. Insert the supplied battery with the label **THIS SIDE UP** facing up as indicated.



Step 2

Align the cover flat against the battery compartment, then slide it upwards until it clicks into place.



Step 3

Charge the handset by placing it face up in the telephone base or charger. The **CHARGE** light is on when charging.

After you install your telephone or power returns following a power outage, the handset will prompt you to set the date and time. For instructions, see **Set date and time** on page 29. To skip setting the date and time, press **OFF/CANCEL** or **BACK**.



To replace the battery, press the tab and slide the battery compartment cover downwards. Lift out the old battery and disconnect it from the handset. Follow the instructions above to install and charge the new battery.



IMPORTANT INFORMATION:



1. Use only the supplied rechargeable battery or replacement battery (model BT183342). To order, visit our website at **www.telephones.att.com** or call **1 (800) 222-3111**. In Canada, dial **1 (866) 288-4268**.
2. If you do not use the handset for a long time, disconnect and remove the battery to prevent possible leakage.

Battery charging

Once you have installed the battery, the screen indicates the battery status (see table below). If necessary, place the handset in the telephone base or charger to charge the battery. For best performance, keep the handset in the telephone base or charger when not in use. The battery is fully charged after 16 hours of continuous charging. See the table on page 117 for battery operating times.

If the screen is blank, you need to charge the handset without interruption for at least 30 minutes to give the handset enough charge to use the telephone for a short time. When the battery is low, the handset shows **Low battery** and a flashing . If you are on a call in low battery mode, the handset beeps every minute.

The following table summarizes the battery charge indicators and actions to take.

Battery indicators	Battery status	Action
The screen is blank or shows Place in charger and  flashes.	The battery has very little or no charge. The handset cannot be used.	Charge without interruption until the screen shows Low battery or HANDSET X (at least 30 minutes).
The screen shows Low battery and  flashes.	Battery has enough charge to be used for a short time.	Charge without interruption until the screen shows HANDSET X (at least 30 minutes).
The screen shows HANDSET X .	Battery is charged.	To keep the battery charged, place it in the telephone base or charger when not in use.

 **NOTE:** If you are on a phone call in low battery mode, you hear four short beeps every minute.

Installation options

Your telephone base is ready for tabletop use. If you want to mount your telephone on a wall, use the provided wall mount bracket to attach to a standard dual-stud telephone wall mounting plate. If you do not have this mounting plate, you can purchase one from many hardware or consumer electronics retailers. You may need a professional to install the mounting plate.

Tabletop to wall mount installation

1. Plug one end of the telephone line cord into the **TEL LINE** jack on the bottom of the telephone base. Plug the small end of the telephone base power adapter into the **POWER** jack on the bottom of the telephone base.
2. Position the lower portion grooves on the telephone base to the lower portion tabs (marked **B**) on the wall mount bracket. Make sure the upper portion grooves of the telephone base are above the upper portion tabs (marked **A**) on the wall mount bracket. Push the telephone base down until it clicks securely in place.
3. Route the telephone line cord (or DSL filter) through the wall mount bracket hole and plug it into the telephone wall jack. Route the power cord out of the bottom of the telephone and plug it into an electrical outlet not controlled by a wall switch.
4. Align the holes on the bracket with the standard wall plate and slide the bracket down until it locks securely. Bundle the telephone line cord and power adapter cord neatly with twist ties.

1



2



3

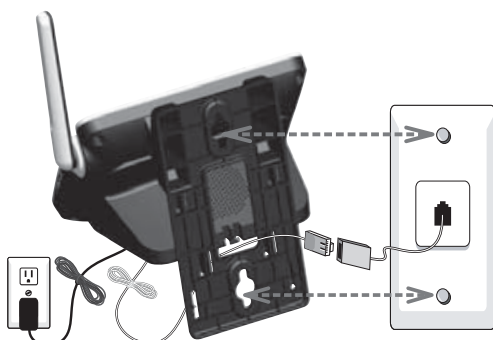

4

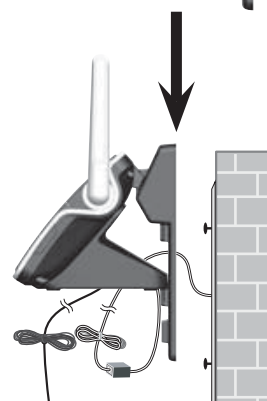

Wall mount to tabletop installation

To change the telephone base from the wall mount position to tabletop position, follow the steps below.

1. If the telephone line cord and power adapter cord are bundled, untie them first. Remove the wall mount bracket from the wall.
2. Unplug the telephone line cord (or DSL filter) from the wall. Unplug the power adapter from the power outlet. Lift the telephone base up to detach it from the plastic wall mount bracket.
3. Push the wall mount bracket up to remove it from the wall.
4. See **Telephone base installation** on page 7.

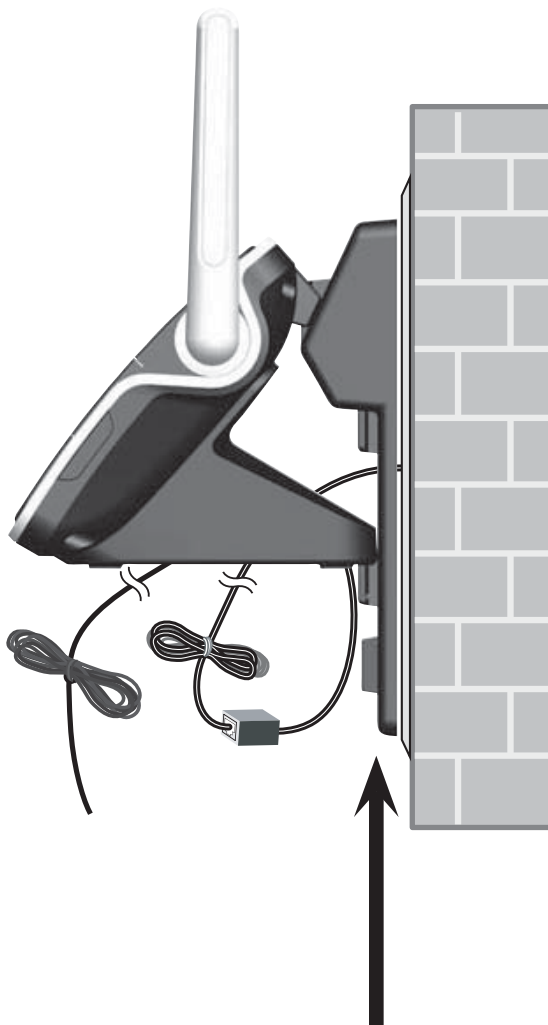

Introducing Bluetooth

Your new AT&T **TL92271/TL92371/TL92471** telephone system with Bluetooth wireless technology has the following features:

- Pair up to four Bluetooth enabled devices (cell phones or headsets) with the telephone base.
- Connect a maximum of two cell phones to make and receive cell calls. Only one cell phone can be active on a call at a time.
- Connect a Bluetooth enabled headset for making and receiving home calls.
- Conference cell and home calls.
- Make and receive calls using your cell phone plan with your cordless system handsets.

IMPORTANT INFORMATION

- After plugging in the telephone base, wait at least 20 seconds before connecting a Bluetooth device. The screen shows **Bluetooth system busy** if you try to connect too soon.
- Refer to the user's manual of your Bluetooth enabled cell phone or headset for more information about how that device uses Bluetooth connectivity.
- Bluetooth wireless technology operates within a short range (up to 30 feet) from the telephone base. Keep connected cell phones and headset within this range.
- If your cell phone has poor reception in your home, the **TL92271/TL92371/TL92471** cannot improve the reception. However, if you have a location in your house with better reception, you can leave your cell phone in that location while you use the **TL92271/TL92371/TL92471** cell line. In order for this to work, the cell phone must be within 15 feet of the telephone base for optimal performance.
- Charge your cell phone while it is connected to the telephone base. Your cell phone's battery discharges faster while it is connected to the telephone base via Bluetooth wireless technology.
- Monitor your cell phone's usage, because minutes may be deducted from your cellular plan for the duration of all cell calls, depending on the terms of your plan.

Refer to the **Bluetooth setup** section (pages 15-26) to learn how to set up your Bluetooth device. Refer to the **Telephone operation** section (page 40) on how to operate your Bluetooth devices with your new **TL92271/TL92371/TL92471** AT&T telephone system with Bluetooth wireless technology. Refer to the **Troubleshooting** section (pages 97-109) if you experience difficulty when using the telephone system.

The *Bluetooth*[®] word mark and logos are owned by Bluetooth SIG, Inc. and any use of such marks by Advanced American Telephones and its parent, VTech Holdings Limited, is under license. VTech Holdings Limited is a member of Bluetooth SIG, Inc. Other trademarks and trade names are those of their respective owners.

Glossary of terms

Below are some terms used in this user's manual to help you become familiar with using your Bluetooth devices and your new AT&T telephone system.

Active device slots - the **Device list** has two active slots for two cell phones, or one cell phone and one headset. When a device in the list is active it will have a **D1:** or **D2:** in front of the device name. In order to use a Bluetooth device on a call, it must be in an active slot and be connected.

Bluetooth cell phone - refers to a mobile Bluetooth enabled cellular telephone.

CELLULAR line - the telephone line associated with your cell phone service. On your **TL92271/TL92371/TL92471** handset, press  **CELLULAR** to use the cell line.

Connected - when you pair a Bluetooth device to the **TL92271/TL92371/TL92471** it is placed in a active slot and automatically connected. When a device is connected a **1** and/ or **2** will display after  on the handset screen and the **DEVICE 1** and/or **DEVICE 2** light on the telephone base will be on. If a device loses its connection to the telephone base, it must be reconnected before you can use the device with the **TL92271/TL92371/TL92471**.

Disconnected - when a device is disconnected, **1** and/or **2** displays after  on the handset screen and the **DEVICE 1** and/or **DEVICE 2** light on the telephone base is off.

Discoverable mode - before a Bluetooth enabled device can be paired, it must be set to this mode. When pairing your cell phone, the telephone base is in this mode. When pairing a headset, the headset must be set to this mode. Depending on the manufacturer, this mode is sometimes referred to as **Find Me** or **Visibility**.

HOME line - your conventional telephone land line. On your **TL92271/TL92371/TL92471** handset, press  **HOME/FLASH** to use the home line.

Paired devices - Bluetooth enabled devices (cell phone or headset) that have shared registration information with the telephone base. A total of four Bluetooth enabled devices can be paired with the telephone base. However, only two paired devices can be connected to the base at a time.

Pairing - sometimes refers to as **bonding**. The process of sharing registration information between two Bluetooth enabled devices. Your Bluetooth enabled cell phone or headset must first be paired to the telephone base in order to use it with this cordless phone system.

PIN - by default, the PIN is **0000** for the telephone base and for most Bluetooth devices. PIN information must be exchanged between Bluetooth devices before they can be used. This is also known as a **Passkey** or **Passcode**.

Bluetooth setup

To use a Bluetooth enabled cellular phone with your telephone, you must first pair and connect your Bluetooth cellular phone with the telephone base. All **TL92271/TL92371/TL92471** handsets can be used to make or answer calls on the cell phone line.

Bluetooth wireless technology operates within a short range (up to 30 feet). When you pair a Bluetooth cell phone or Bluetooth headset to the telephone base, keep the device within 15 feet of the telephone base for optimal performance.

Add a cell phone

Before you begin, make sure that you have cellular coverage and your Bluetooth enabled cell phone is not connected to any other Bluetooth device. Refer to your cell phone user's manual to learn how to search for or add new Bluetooth devices.

To pair and connect a cell phone:

1. Press **MENU** in idle mode to enter the main menu.
2. Press **CID** or **▲DIR** to highlight **Bluetooth**, then press **SELECT**.
3. Press **SELECT** to choose **Add device**.
4. Press **CID** or **▲DIR** to highlight **Add cellular**, then press **SELECT**. The screen displays **Please wait...** followed by
 1. **If cell is connected to BT device, please disconnect it.**
 - If there are already four paired devices on the device list, the 4th device on the device list will be automatically removed, regardless of whether the new device pairing is successful or not (page 22).
 - If there are already two active devices on the device list with prefix **D1:** or **D2:**, the handset shows **Only 2 devices can be ready for connection.** You are prompted to deactivate an active device.
5. Press **NEXT**. The screen displays **2. Place cell phone next to base.**
 - All devices that are connected to the telephone base are disconnected until the pairing process is completed.
6. Press **NEXT** to turn on the telephone base discoverable mode. The screen displays **Set cell to search base: AT&T DECT 6.0 discoverable PIN: 0000.** Promptly turn on the Bluetooth feature of your cell phone and search for or add new devices.

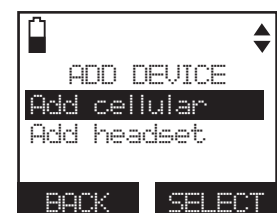

Bluetooth setup

7. Your cell phone may require a passcode. In this case the handset screen displays **Check cellular. ENTER PASS CODE**. Enter the cell phone passcode into the handset and press **SET** to save.

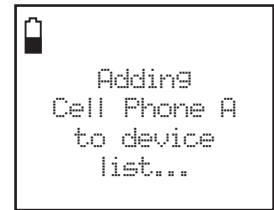

8. Enter the PIN of the telephone base (the default PIN is **0000**) into your cell phone to continue the pairing process. The handset displays **Adding Cell Phone A to device list...**

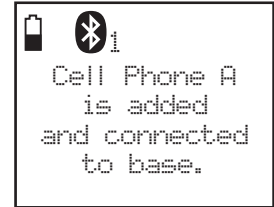

9. When a device is successfully connected, the handset displays **Cell Phone A is added and connected to base**. You hear a confirmation tone. The corresponding status icon (**1** or **2**) displays. The corresponding device light on the telephone base (**DEVICE 1** or **DEVICE 2**) turns on.

NOTES:

1. The pairing process may take up to one minute. If the pairing process fails, try again.
2. If you put the handset back in the telephone base or charger while pairing, the process is cancelled and the handset returns to idle mode.

Bluetooth setup

Add a headset

Before you begin, make sure that your Bluetooth enabled headset is not connected to any other Bluetooth device. Refer to your headset user's manual to learn how to search for or add new Bluetooth devices.

To pair and connect a headset:

1. Press **MENU** on the handset in idle mode to enter the main menu.
2. Press **CID** or **▲DIR** to highlight **Bluetooth**, then press **SELECT**.
3. Press **SELECT** to choose **Add device**.
4. Press **CID** or **▲DIR** to highlight **Add headset**, then press **SELECT**. The screen displays **Please wait...** followed by **If headset is connected to cell, please disconnect it**. Press **NEXT**.
 - If there is another headset already active, the screen will show **Only 1 headset in device list can be ready for connection** and prompt you to replace an existing paired device (page 22).
 - When you already have two active devices, the handset shows **Only 2 devices can be ready for connection**. The telephone base will deactivate another headset from active slot automatically.
5. Press **NEXT**. The screen displays **Pls set headset to discoverable mode**, then press **NEXT**.
 - All devices that are connected to the telephone base are temporarily disconnected.
6. The screen displays **Searching for Bluetooth headsets...** Set your headset to discoverable mode (refer to the user's manual of your headset).
7. When the screen displays the found devices, press **CID** or **▲DIR** to highlight your headset and then press **NEXT**.
8. Enter the PIN of your headset. The PIN for most Bluetooth devices is **0000** (refer to the user's manual of your headset). Then press **NEXT**.

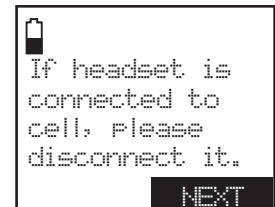
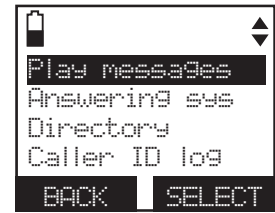

Bluetooth setup

9. The screen will display **Adding Headset A to device list...** when the base is connecting to your headset.
10. When a device is successfully connected, the handset displays **Headset A is added and connected to base** and the corresponding status icon (📶1 or 📶2). You hear a confirmation tone. The corresponding light on the telephone base (**DEVICE 1** or **DEVICE 2**) turns on.

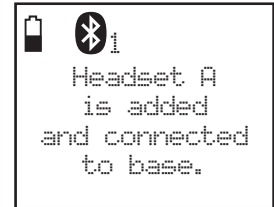

NOTES:

1. The pairing process may take up to one minute. If the pairing process fails, try again.
2. If you put the handset back in the telephone base or charger while pairing, the process discontinues and the handset returns to idle mode.

Auto connection

An active device may be disconnected from the telephone base when:

- The Bluetooth feature of your cell is turned off.
- The power of your device is turned off.
- Your Bluetooth device are not is not within range of the telephone base.

When the Bluetooth or power on the device is turned on or it moves within range of the base, the base will try to reconnect to the Bluetooth device. If you disconnect the device through the device list, the base will not attempt to reconnect unless your device is moved out of range and back in range again.

Bluetooth setup

Device list and connection

Up to four devices can be paired to the telephone base. All paired devices are shown on the device list. To use a paired device, it must be in an active slot (**DEVICE 1** or **DEVICE 2**) on the device list and connected. Only one Bluetooth cell phone or a headset can be on a call at a time.

Once you have paired a device with the telephone base, you do not need to repeat the pairing procedure again unless you delete the device from the device list.

i NOTE: When connecting a Bluetooth device to the device list, all connected devices will be temporarily disconnected until the procedure is complete. It may take up to two minutes to reconnect.

Review the active device list

1. Press **MENU** on the handset when it is not in use.
2. Press **CID▼** or **▲DIR** to highlight **Bluetooth**, then press **SELECT**.
3. Press **CID▼** or **▲DIR** to highlight **Device list**, then press **SELECT**.

Connect/disconnect an active device

While in the active devices menu, you may connect or disconnect your active device.

1. Press **MENU** on the handset when it is not in use.
2. Press **CID▼** or **▲DIR** to highlight **Bluetooth**, then press **SELECT**.
3. Press **CID▼** or **▲DIR** to highlight **Device list**, then press **SELECT**.
4. Press **CID▼** or **▲DIR** to highlight a device when necessary, then press **OPTION**.
5. Press **CID▼** or **▲DIR** to highlight **Connect/Disconnect** (whichever is applicable), then press **SELECT** to confirm. The handset displays **Device connected/Device disconnected**. You hear a confirmation tone.

i NOTE: When your active device is connected, you are prompted to select **Disconnect**. When your active device is disconnected, you are prompted to select **Connect**.

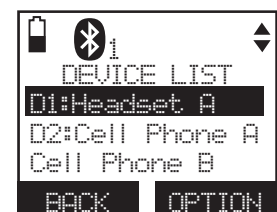

Bluetooth setup

Remove a device

When you already have the maximum of four paired devices on the device list and you want to add another device, you must first delete a device from the device list.

To remove a device:

1. Press **MENU** on the handset in idle mode to enter the main menu.
2. Press **CID** or **▲DIR** to highlight **Bluetooth**, then press **SELECT**.
3. Press **CID** or **▲DIR** to highlight **Device list**, then press **SELECT**.
4. Press **CID** or **▲DIR** to highlight a selected device when necessary, then press **MUTE/DELETE**.

-OR-

- Press **CID** or **▲DIR** to highlight a selected device when necessary, then press **OPTION**.
 - Press **CID** or **▲DIR** to highlight **Remove**, then press **SELECT**.
5. The handset displays **Remove Headset A?** Press **YES** to confirm. The handset displays **Device removed from device list**. You hear a confirmation tone.

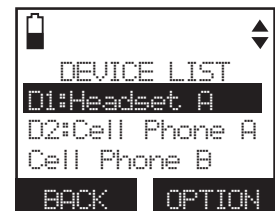
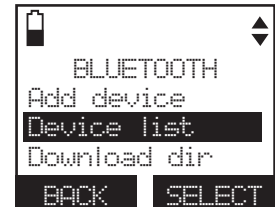

Bluetooth setup

Rename a device

You can change the name of a paired device on the paired devices list.

1. Press **MENU** on the handset when it is not in use.
2. Press **CID▼** or **▲DIR** to highlight **Bluetooth**, then press **SELECT**.
3. Press **CID▼** or **▲DIR** to highlight **Device list**, then press **SELECT**.
4. Press **CID▼** or **▲DIR** to highlight a device when necessary, then press **OPTION**.
5. Press **CID▼** or **▲DIR** to highlight **Rename**, then press **SELECT**. The screen displays **ENTER NEW NAME**.
6. Use the dialing keys to edit the name (page 62).
 - Press **MUTE/DELETE** to erase a character.
 - Press and hold **MUTE/DELETE** to erase all characters.
 - Press **CID▼** to move the cursor to the right or **▲DIR** to the left.
7. Press **SAVE**. The handset displays **Device renamed**. You hear a confirmation tone.

i NOTE: Only the first 15 characters of the device name are shown on the device list.

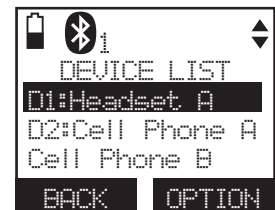

Bluetooth setup

Replace an active device

If you already have two active devices on the device list and you want to activate a different device, you must deactivate one of the two active device.

To replace an active device:

1. Press **MENU** on the handset when it is not in use.
2. Press **CID**▼ or **▲DIR** to highlight **Bluetooth**, then press **SELECT**.
3. Press **CID**▼ or **▲DIR** to highlight **Device list**, then press **SELECT**.
4. Press **CID**▼ or **▲DIR** to highlight the device you want to activate, without a prefix **D1:** or **D2:**, then press **OPTION**.
5. Press **CID**▼ or **▲DIR** to highlight **Connect**, then press **SELECT**. The handset displays **Only 2 devices can be ready for connection** and then a list of devices for deactivation.
6. Press **CID**▼ or **▲DIR** to highlight the device to be deactivated, then press **SELECT**. The handset displays **Cell Phone A is deactivated** you hear a confirmation tone. The screen displays then **Connecting Cell Phone B to the base...**
7. Depending on your cell phone settings, you may need to press a key on your cell phone to confirm the connection. When the new device is successfully activated and connected, the handset displays **Device connected**. You hear a confirmation tone.

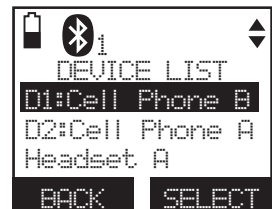
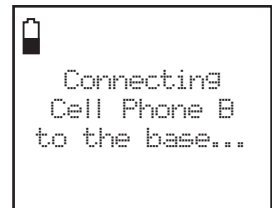
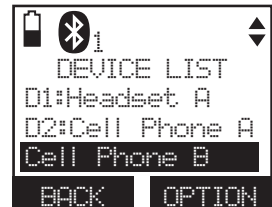

Bluetooth connection from idle mode

When you have active devices that are not connected, **CONNECT** appears on the idle handset. Press **CONNECT** to start connecting an active device. When there are two active devices, the handset will prompt you to choose one before connection.



Bluetooth setup

Download directory

You can download up to four cell phone directories (phonebooks) to your **TL92271/TL92371/TL92471** telephone system via Bluetooth wireless technology. Each downloaded directory can store up to 1,500 entries with up to 30 digits for each phone number and 15 characters for each name.

Before downloading the directory, make sure the cell phone is paired, active and connected to your **TL92271/TL92371/TL92471**. Make sure the handset battery is charged for at least 10 minutes.

Place your cell phone next to the telephone base when you download a cell phone directory to your TL92271/TL92371/TL92471.

To download a cell phone directory:

1. Press **MENU** on the handset when it is not in use.
2. Press **CID**▼ or **▲DIR** to highlight **Bluetooth**, then press **SELECT**.
3. Press **CID**▼ or **▲DIR** to highlight **Download dir**, then press **SELECT**.
 - If there is no cell phone paired to the system, the handset displays **Device list is empty**. Press **OK** to return to Bluetooth menu.
4. Press **CID**▼ or **▲DIR** to select a desired device, then press **SELECT**.
 - If the selected device is active but disconnected, the handset displays **Cellular phone not connected**. Press **CONNECT**.
5. Press **CID**▼ or **▲DIR** to highlight one of the following options:
 - **Phone memory** - download all contacts stored in your phone memory.
 - **SIM card only** - download all contacts stored in your SIM card.
 - **Phone and SIM** - download all contacts stored in both your phone memory and SIM card.

Press **SELECT**. During the download, the handset displays the progress. All other idle system handsets display **Downloading dir**.

- Your cell phone may require a passcode. In this case the screen displays **Check cellular. ENTER PASS CODE**. Enter the cell phone passcode into the handset and press **SET** to save.

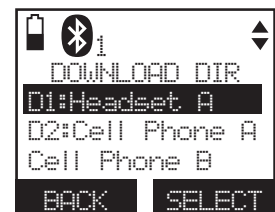

Bluetooth setup

- If the selected device's directory has already been downloaded to **TL92271/TL92371/TL92471** before, the handset displays the last update date of your cell phone. The directory stored on the **TL92271/TL92371/TL92471** for that cell phone will be erased and replaced with the current cell phone directory. If you have edited the downloaded entries (page 65), those changes will be lost. Press **NEXT** to start the download, the screen displays **Erasing directory...**
- If you already have four downloaded directories, the handset displays **Memory is full. Replace existing directory?** Press **YES**. Highlight the cell phone directory to be replaced and press **SELECT**. The screen displays **Replace Cell Phone A directory?** Press **YES** to confirm.

6. When the downloading process is complete, the handset displays **Download ended XXXX entries saved**. You hear a confirmation tone. Press **OK** to return to the download directory menu.

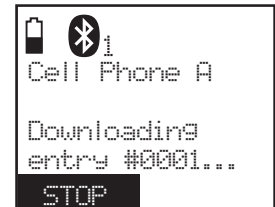

iNOTES:

1. Certain cell phones do not support SIM card download. If this is the case, try transferring the contacts from your SIM card to your cell phone memory first, then download from your cell phone memory. For more information on how to transfer contacts from your SIM card to your cell phone memory, see the user's manual of your cell phone.
2. If **Phone memory** is chosen but with no entries saved, the handset displays **No entries found. Download from SIM only?** Press **YES** to confirm. If **SIM card only** is chosen but with no entries saved, the handset displays **No entries found. Download from Phone only?** Press **YES** to confirm. If **Phone and SIM** are chosen but with no entries saved in either or both directories, the handset display **No entries found. Download from Phone only?** Press **YES** to confirm.
3. When downloading the directory from your Bluetooth enabled cell phone, some data may not transfer. For example, if you have home, mobile and work numbers for a particular contact, the three categories may not transfer to your **TL92271/TL92371/TL92471**.
4. On certain cell phones, you may need to press a key to confirm the directory download.

Bluetooth setup

Interruption to directory download

If you are downloading a directory from a cell phone and the phone receives a call, the download process stops and all handsets display **Download fail**. When you try to view the downloaded directory, the handset displays **Last download failed: MM/DD/YY**. You need to download the directory again (see page 23).

If you are downloading a directory from a cell phone and the telephone base loses power, the download process stops. When the telephone base regains power, the handset only displays the **Home** directory. You need to download the directory again (see page 23).

The download progress screen may be replaced with **Cell line in use**. To go back to the downloading progress screen, do steps one through four on page 23. The download process continues even if any of the following occur:

- You place the handset in the telephone base or charger.
- You access your cell phone menu features.
- The handset battery becomes depleted or the handset loses connection with the telephone base.

i NOTE: During the download process, do not attempt to make changes to your cell phone directory.

View the directory download information

1. Press **MENU** on the handset in idle mode to enter the main menu.
2. Press **CID▼** or **▲DIR** to highlight **Directory**, then press **SELECT**.
3. Press **CID▼** or **▲DIR** to choose the desired downloaded directory, then press **OPTION**.
4. Press **CID▼** or **▲DIR** to highlight **Last update**, then press **SELECT**. Press **OK** to exit.

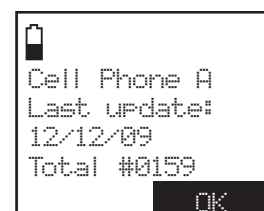

Change PIN

You are required to enter a PIN when establishing a Bluetooth connection. The default PIN of your telephone base is **0000**.

To change the PIN:

1. Press **MENU** on the handset in idle mode to enter the main menu.
2. Press **CID**▼ or **▲DIR** to highlight **Bluetooth**, then press **SELECT**.
3. Press **CID**▼ or **▲DIR** to highlight **Change PIN**, then press **SELECT**. The handset displays **ENTER NEW PIN** and the existing PIN.
4. Use the dialing keys to enter a new four-digit code.
 - Press **MUTE/DELETE** to erase a digit.
 - Press and hold **MUTE/DELETE** to erase all digits.
 - Press **CID**▼ to move the cursor to the right or **▲DIR** to the left.
5. Press **SET** to save. You hear a confirmation tone.



Ringers

In the ringers menu, you can select the ringer tones and adjust the ringer volume for incoming calls to the home and cell lines.

Ringer volume

You can select the ringer volume for the incoming home and cell calls.

To adjust the handset ringer volume:



1. Press **MENU** on the handset in idle mode to enter the main menu.
2. Press **CID**▼ or **▲DIR** to highlight **Ringers**, then press **SELECT**.
3. Press **SELECT** to choose **Ringer volume**.
4. Press **CID**▼ or **▲DIR** to select **All lines**, **Home**, **Cell-D1** or **Cell-D2**, then press **SELECT**.
5. Press **CID**▼ or **▲DIR** to adjust the ringer volume.
6. Press **SET** to save. You hear a confirmation tone.

-OR-

Press **OFF** to turn off the ringer, then press **SET** to save. You hear a confirmation tone.



iNOTES:

1. Changing the handset ringer volume does not affect base ringer volume. For more information on base ringer volume, see page 39.
2. When the ringer volume for all calls (home and cellular) is set to off, a ringer off icon  appears steady. When only one or two of the ringer volume settings are set to off, a ringer off icon  flashes.
3. The ringer volume level also determines the ringer levels of intercom calls (page 52).

Ringer tone

You can select the ringer tones for the incoming home and cell calls.

To select a ringer tone:

1. Press **MENU** on the handset in idle mode to enter the main menu.
2. Press **CID**▼ or **▲DIR** to highlight **Ringers**, then press **SELECT**.
3. Press **CID**▼ or **▲DIR** to highlight **Ringer tone**, then press **SELECT**.
4. Press **CID**▼ or **▲DIR** to highlight **All lines**, **Home**, **Cell-D1** or **Cell-D2**, then press **SELECT**.
5. Press **CID**▼ or **▲DIR** to select a ringer tone.
6. Press **SET** to save. You hear a confirmation tone.

i **NOTE:** When you turn off the ringer volume, you will not hear ringer tone samples.



Telephone settings

Set date and time

The answering system announces the day and time of each message prior to playing it. If you subscribe to caller ID service, the day, month and time are set automatically with each incoming call. If you do not want to set the date and time automatically with caller ID information, turn this feature off (see **Use caller ID to automatically set date and time** on page 34). However, the year must be correct so that the day of the week can be calculated from the caller ID information. Before using the answering system, set the date and time as follows.

After handset registration or a power failure, the handset will prompt you to set the date and time (see page 9).

To set the date and time:

1. Press **MENU** on the handset in idle mode to enter the main menu.
2. Press **CID**▼ or **▲DIR** to highlight **Set date/time**, then press **SELECT**.
3. Use the dialing keys (**0-9**) to enter the month. For example, enter **02** for February.

-OR-

Press **CID**▼ or **▲DIR** to choose the month and then press **SET**.

1. Repeat Step 3 to set the date and year, and then press **SET**.
2. Repeat Step 3 to set the hour and minute, and then press **SET**.
3. Press **CID**▼ or **▲DIR** to choose **AM** or **PM**, or press **2** for **AM** or **7** for **PM**. Then press **SET** to save. You hear a confirmation tone.

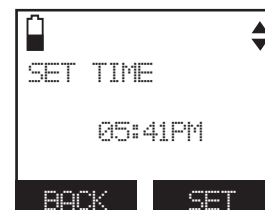

i NOTE: If the date and time is not set when a message is recorded, the system announces, "Time and day not set," before each message plays.

Settings

In the settings menu, you can change and edit the settings for LCD language, display alerts, CID time synchronization, handset name, key tone, dial mode and voice announce caller ID.

LCD language

You can select English, Français or Español to be used in all screen displays.

To select a language:

1. Press **MENU** in idle mode to enter the main menu.
2. Press **CID**▼ or **▲DIR** to highlight **Settings**, then press **SELECT**.
3. Press **SELECT** to choose **LCD language**.
4. Press **CID**▼ or **▲DIR** to choose from **English**, **Français** or **Español**, then press **SET** to save. You hear a confirmation tone.



Display alerts

In the display alerts menu, you can change and edit the settings for display of alerts on the idle screen.

Missed call indicator

When there are missed calls that have not been reviewed in the caller ID log, the handsets show **XX Missed calls**.

Each time you review a caller ID log entry marked **NEW**, the number of missed calls decreases by one. When you have reviewed all the missed calls, the missed calls indicator removes.

If you do not want to review the missed calls one by one, you can reset the missed call indicator. All the entries are then considered old and kept in the caller ID log.

To reset the missed call indicator:

1. Press **MENU** in idle mode to enter the main menu.
2. Press **CID**▼ or **▲DIR** to highlight **Settings**, then press **SELECT**.
3. Press **CID**▼ or **▲DIR** to highlight **Display alerts**, then press **SELECT**.
4. Press **CID**▼ or **▲DIR** to highlight **Home line** or **Cell line**, then press **SELECT**.
5. Press **CID**▼ or **▲DIR** to highlight **Missed calls**, press **SELECT** to confirm. The screen displays **Reset missed call indication?** Press **YES** to confirm. You hear a confirmation tone.

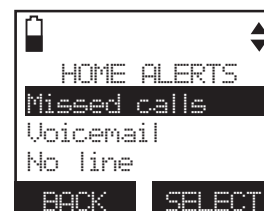

You can also press and hold **OFF/CANCEL** to erase the missed call indicator when the telephone is not in use.

Voicemail indicator

If you subscribe to voicemail service offered by your telephone service provider, **New voicemail** and  appear on the handsets when you have new voicemail messages. Contact your telephone service provider for more information and assistance about using your voicemail service..

After you have listened to all new voicemail messages, the indicators on the handsets turn off automatically.

Reset the voicemail indicators when the telephone indicates that there is new voicemail but there is none (for example, when you have accessed your voicemail while away from home). Clearing the voicemail waiting indicators only turns off the indicators; it does not delete your voicemail messages. As long as you have new voicemail messages, your telephone service provider continues to send the signal to turn on the indicators.

To reset the voicemail indicator:

1. Press **MENU** on the handset when it is not in use.
2. Press **CID**▼ or **▲DIR** to highlight **Settings**, then press **SELECT**.
3. Press **CID**▼ or **▲DIR** to highlight **Display alerts**, then press **SELECT**.
4. Press **CID**▼ or **▲DIR** to highlight **Home line**, then press **SELECT**.
5. Press **CID**▼ or **▲DIR** to highlight **Voicemail**, press **SELECT**.
6. The handset displays **Reset voicemail indication?**
Press **YES** to confirm. You hear a confirmation tone.

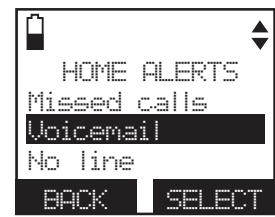

Telephone settings

No line

If there is no telephone line connected to the telephone base, the handsets show **No home line**. If you do not want to display the message on the handset screens (for example, if you use the cell line only), you can turn off the no line alert.

To reset the missed call indicator:

1. Press **MENU** in idle mode to enter the main menu.
2. Press **CID▼** or **▲DIR** to highlight **Settings**, then press **SELECT**.
3. Press **CID▼** or **▲DIR** to highlight **Display alerts**, then press **SELECT**.
4. Press **CID▼** or **▲DIR** to highlight **Home line**, then press **SELECT**.
5. Press **CID▼** or **▲DIR** to highlight **No line**, then press **SELECT**.
6. Press **CID▼** or **▲DIR** to choose **On** or **Off**, then press **SET** to save. When you choose the handset displays **If the line is not connected, an alert will not appear**. You hear a confirmation tone.

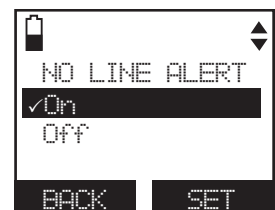
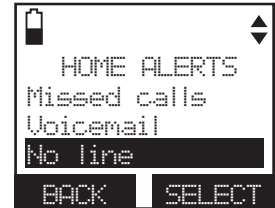
**Download fail**

If the directory download process is interrupted, the handsets display **Download fail**. You can reset the download fail indication on the handset.

To reset the voicemail indicator:

1. Press **MENU** on the handset when it is not in use.
2. Press **CID▼** or **▲DIR** to highlight **Settings**, then press **SELECT**.
3. Press **CID▼** or **▲DIR** to highlight **Display alerts**, then press **SELECT**.
4. Press **CID▼** or **▲DIR** to highlight **Cell line**, then press **SELECT**.
5. Press **CID▼** or **▲DIR** to highlight **Download fail**, then press **SELECT**.
6. The handset displays **Reset download failure indication?** Press **YES** to confirm. You hear a confirmation tone.

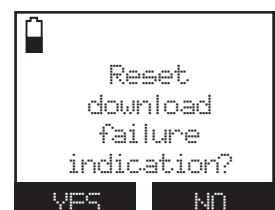
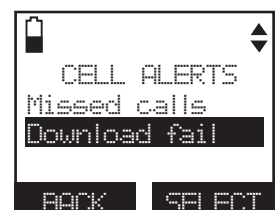

You can also press and hold **OFF/CANCEL** to erase the download fail indicator when the telephone is not in use.

Telephone settings

Use caller ID to automatically set date and time

If you subscribe to caller ID service, the date and time will be set automatically by the caller ID information. You can turn off this feature if you want to set the date and time manually.

1. Press **MENU** on the handset in idle mode to enter the main menu.
2. Press **CID** or **DIR** to highlight **Settings**, then press **SELECT**.
3. Press **CID** or **DIR** to select **CID time sync**, then press **SELECT**.
4. Press **CID** or **DIR** to select **On** or **Off**, then press **SET** to save. You hear a confirmation tone.

**Rename handset**

You can change the name of each handset, the new name of each handset cannot exceed 11 characters.

To rename a handset:

1. Press **MENU** on the handset when it is not use.
2. Press **CID** or **DIR** to highlight **Settings**, then press **SELECT**.
3. Press **CID** or **DIR** to highlight **Rename handset**, then press **SELECT**. The screen displays **RENAME HANDSET**.
4. Use the dialing keys to edit the name. Press **MUTE/DELETE** to erase a character.
 - Press and hold **MUTE/DELETE** to erase all characters.
 - Press **CID** to move the cursor to the right or **DIR** to the left.
5. Press **SAVE**. You hear a confirmation tone.



Telephone settings

Key tone

The handset is set to beep with each key press. If you turn off the **key tone**, there are no beeps when you press keys.

To change the setting:

1. Press **MENU** on the handset in idle mode to enter the main menu.
2. Use **CID**▼ or **▲DIR** to scroll to **Settings**, then press **SELECT**.
3. Press **CID**▼ or **▲DIR** to scroll to **Key tone**, then press **SELECT**.
4. Press **CID**▼ or **▲DIR** to adjust the key tone volume, then press **SET** to save.

-OR-

Press **OFF** to turn off, then press **SET** to save. You hear a confirmation tone.



Dial mode

The dial mode is preset to tone dialing. If you have pulse (rotary) service, you must change the dial mode to pulse dialing before using the telephone.

To change the setting:

1. Press **MENU** on the handset in idle mode to enter the main menu.
2. Press **CID**▼ or **▲DIR** to highlight **Settings**, then press **SELECT**.
3. Press **CID**▼ or **▲DIR** to highlight **Dial mode**, then press **SELECT**.
4. Press **▼CID** or **▲DIR** to choose **Tone** or **Pulse**, then press **SET** to save. You hear a confirmation tone.



Telephone settings

Voice announce caller ID

You can set your handset and/or telephone base to announce the caller ID information for incoming calls. The voice announce caller ID setting is independent for each handset and telephone base.

To change the setting:

1. Press **MENU** on the handset in idle mode to enter the main menu.
2. Press **CID**▼ or **▲DIR** to highlight **Settings**, then press **SELECT**.
3. Press **CID**▼ or **▲DIR** to highlight **Caller ID Annc**, then press **SELECT**.
4. Press **CID**▼ or **▲DIR** to highlight **Handset** or **Base**, then press **SELECT**.
5. Press **▼CID** or **▲DIR** to choose **On** or **Off**, then press **SET** to save. You hear a confirmation tone.



iNOTE:

1. Only the first four registered handsets will be able to use this feature.
2. If the phone number of the incoming call match the last 7 digits of a directory entry, the name will be announced as it appears in the entry.
3. The phone number will be announced when the name is unknown, private or not provided. Only the last 11 numbers of a phone number is announced.
4. No information will be announced if both the name and number are private, unknown or not provided.
5. This feature is not supported with headsets.
6. This feature does not announce information for call waiting calls.
7. If both home and cell lines are ringing, only the caller ID information of the first ringing line will be announced.
8. The voice announce caller ID feature is available in English only.
9. If you set the number of rings as 3 rings (page 79), the answering system may not have enough time to announce the caller's full information.

Website

You can use this feature to view the AT&T website address.

1. Press **MENU** on the handset in idle mode to enter the main menu.
2. Use **CID**▼ or **▲DIR** to scroll to **Website**, then press **SELECT**. The handset screen shows the AT&T website address.
3. Press **OK** to exit.



Home area code

If you dial seven digits to make a local call (area code not required), enter your area code into the telephone as the home area code. When you receive a call from within your home area code, the caller ID history only displays the seven digits of the telephone number.

This feature makes it easy for you to place a call from the caller ID log. If you dial 10 digits to make a local phone call, do not use this home area code feature. If you do, you cannot place local calls from your caller ID log, as they will have only seven digits.

To set the home area code:

1. Press **MENU** on the handset in idle mode to enter the main menu.
2. Press **CID▼** or **▲DIR** to highlight **Directory**, then press **SELECT**.
3. Press **OPTION** to choose **Home**.
4. Press **CID▼** or **▲DIR** to highlight **Home area code**, then press **SELECT**.
The screen displays **Only for 7 digits dialing from Caller ID log**.
5. Use the dialing keys to enter the desired home area code.
 - Press **MUTE/DELETE** to erase a digit.
 - Press and hold **MUTE/DELETE** to erase all digits.
 - Press **CID▼** to move the cursor to the right or **▲DIR** to the left.
6. Press **SET** to save. The handset displays **Area code will not show in Caller ID log**. You hear a confirmation tone.

i **NOTE:** If, in the future, your telephone service provider requires you to dial 10 digits to make a local call (area code + telephone number), you will need to delete your home area code. With the home area code displayed, press and hold **MUTE/DELETE**, and then press **SET**. The home area code is now restored to its default setting of **__ _** (empty).

Cell area code

Most cell phone entries are stored in a 10-digit format. If all of your cell phone entries are stored this way, you do not need to program your cell area code.

If your cell phone stores entries in a 7-digit format, we recommend that you program your cell area code so that your 7-digit directory entries can be dialed correctly using your home line.

To set the cell area code:

1. Press **MENU** on the handset in idle mode to enter the main menu.
2. Press **CID▼** or **▲DIR** to highlight **Directory**, then press **SELECT**.
3. Press **CID▼** or **▲DIR** to highlight a desired downloaded directory, then press **OPTION**.
4. Press **SELECT** to choose **Cell area code**. The handset displays **Only for 7 digits dialing from Caller ID log**.
5. Use the dialing keys to enter the desired cell area code.
 - Press **MUTE/DELETE** to erase a digit.
 - Press and hold **MUTE/DELETE** to erase all digits.
 - Press **CID▼** to move the cursor to the right or **▲DIR** to the left.
6. Press **SELECT** to confirm. The handset screen displays **Area code will not show in Caller ID log**. You hear a confirmation tone.

Telephone settings

Telephone base ringer volume

Press **▼VOLUME▲** on the telephone base to adjust the ringer volume when the telephone is not in use. When you set the ringer volume to zero, the base ringer is off and the system announces, *"Base ringer is off."*

Press **▼/VOLUME** during an incoming call to mute the ringer temporarily.

Answering system settings

Go to **Answering system settings** starting on page 75 for instructions on how to use a system handset to modify the answering system settings shown below.

Setting	Page
Answer on/off	75
Announcement (play, record and delete)	76-77
Call screening	78
Number of rings	79
Remote access code	80
Message alert tone	80
Recording time	81

Making, answering and ending a call

Using a handset for home calls

To make a home call:

- Press **HOME/FLASH** or **SPEAKER**, then enter the telephone number.

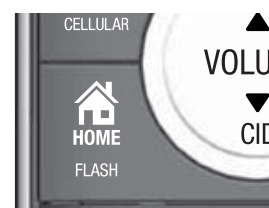

To predial a home call:

- Enter the telephone number, then press **HOME/FLASH** or **SPEAKER**.



To answer a home call:

- Press **HOME/FLASH** or **SPEAKER**.

To end a home call:

- Press **OFF/CANCEL** or put the handset in the telephone base or charger.

NOTES:

1. The screen shows the elapsed time as you talk (in hours, minutes and seconds).
2. When predialing (preview numbers before dialing), press **MUTE/DELETE** to backspace and delete; press and hold **REDIAL/PAUSE** to insert a dialing pause (a **p** appears).
3. You cannot answer a home call using your connected cell phone.

Using a Bluetooth headset for home calls

You can use a Bluetooth headset on home calls. However, you need to keep the device within 15 feet of the telephone base for optimal performance. Please see the user's manual of your Bluetooth headset for more information.

To answer a home call using a Bluetooth headset:

- Press the call key on your headset.

To end a home call you answered from a Bluetooth headset:

- Press the call key on your headset.

If you make or answer a home call on a handset, you can transfer the call to your headset. The handset remains active, but the handset earpiece and microphone are muted. If you hang up the handset, the call ends.

Making, answering and ending a call

To transfer a call from a handset to a Bluetooth headset:

- Press **OPTION**.
- Press **CID▼** or **▲DIR** to choose **Use BT headset**, then press **SELECT** twice. The screen displays **Transferring audio to Headset A**, the message disappears if the call is successfully transferred to the Bluetooth headset.

NOTES:

1. If you answer a call from the headset, that call cannot be transferred to a handset.
2. You will not see **Use BT headset** when the Bluetooth headset is already in use, or there are no active Bluetooth headsets in the device list.
3. While using the cell line, you cannot choose **Use BT headset**.

To transfer a call from the Bluetooth headset back to the handset:

- Press **OPTION**, then press **CID▼** or **▲DIR** to highlight **Use handset** and press **SELECT**.

To end a call that started at the handset:

- Press **OFF/CANCEL** or put the handset in the telephone base or charger.

NOTES:

1. If you answer a call using a headset, and you lose the Bluetooth connection or the battery is depleted, the call is lost.
2. If you are using a headset for a call which is transferred from a **TL92271/TL92371/TL92471** handset, and you lose the Bluetooth connection or the battery of the headset is depleted, the call is transferred back to the originating handset.

Call waiting on the home line

If you subscribe to call waiting service with your telephone service provider, you hear a beep if someone calls while you are already on a call.

- Press **HOME/FLASH** on the handset to put your current call on hold and take the new call.
- Press **HOME/FLASH** on the handset at any time to switch back and forth between calls.

Making, answering and ending a call

Make, answer or end a cell call

You can connect a maximum of two Bluetooth enabled cell phones to the telephone base, but only one cell phone can be used on a cell call at a time. All **TL92271/TL92371/TL92471** handsets can be used to make or answer calls on the cell phone line.

To make a cell call:

- Enter the telephone number, then press  **CELLULAR**.

-OR-

- Press  **CELLULAR**.
- Enter the telephone number, then press **DIAL**.

If you have only one cell phone connected to the telephone base, it is automatically selected to make cell calls. If you have two cell phones connected to the telephone base, the telephone system prompts you to select a cell phone before you make a cell call.

To answer a cell call:

- Press  **CELLULAR**.



 **NOTE:** You can also use your cell phone to answer the call. If you answer with your cell phone, it disconnects from the telephone base.

To end a cell call:

- Press  **OFF/CANCEL** or put the handset in the telephone base or charger.

Call waiting on the cell line

If you subscribe to call waiting service with your cell phone service provider, you hear a beep if someone calls while you are already on a call.



- Press  **CELLULAR** on the handset to put your current call on hold and take the new call.
- Press  **CELLULAR** on the handset at any time to switch back and forth between calls.

-OR-

- Press **SWAP** to switch. To switch back, press **OPTION**. Press **CID**▼ or ▲**DIR** to choose **Swap**, press **SELECT**.

Making, answering and ending a call

Answer a cell call while on a home call

If you are on a home call and you receive an incoming cell call, you hear a beep and  1 or  2 displays on the handset you are using. The telephone base and all other handsets ring.

To answer the incoming cell call:

- Press  **CELLULAR** on the handset. The home call is automatically placed on hold and all other handsets display **Home call on hold** and **Cell line in use** alternately.

To end the cell call:

- Press  **OFF/CANCEL** on the handset. The home line is still on hold. All handsets display **Home call on hold**.

To resume the home call on hold:

- Press  **HOME/FLASH** on the handset.

Cell phone voicemail

If you have voicemail service active on your cell phone, and you do not answer the incoming cell call, the call is answered by your cell phone's voicemail. Contact your cell phone service provider for more information about voicemail service.

Answer a home call while on a cell call

If you are on a cell call and you receive an incoming home call, you hear a beep and  displays on the handset you are using. The telephone base and all other handsets will ring.

To answer the incoming home call:

- Press  **HOME/FLASH** on the handset. The cell call is automatically placed on hold and all other handsets display **Cell call on hold** and **Home line in use** alternately.

To end the home call:

- Press  **OFF/CANCEL** on the handset. The cell line is still on hold. All handsets display **Cell call on hold**.

To resume the cell call on hold:

- Press  **CELLULAR** on the handset.

 **NOTE:** If you have turned on your answering system and you do not answer the incoming home call, the call is answered by your answering system.

Conference calls

Conference home and cell calls

When you have calls established on the home and cell lines, you can create a 3-way conference.

To conference both home and cell calls:

1. Press **OPTION**.
2. Press **CID▼** or **▲DIR** to highlight **Conference**.
3. Press **SELECT**. The screen displays **Lines now in conference**.

To select an option while on a conference call:

1. Press **OPTION**.
2. Press **CID▼** or **▲DIR** to select one of the following options:
 - **End Home line**
 - **End Cell line**
 - **End Conference**
 - **Directory**
3. Press **SELECT**.

To end a conference call:

- Press **OFF/CANCEL** or put the handset back in the telephone base or charger.

-OR-

- Press **OPTION**, then press **CID▼** or **▲DIR** to highlight **End Conference**. Press **SELECT** to end the conference.

Using the home and cell lines together:

- You can be on two different calls using the cell line and home line at the same time using two handsets.
- You cannot be on a call using the cell line and a Bluetooth headset via the home line at the same time. These are both Bluetooth devices and only one can be used at a time.
- If you are on a call using the cell line, you cannot join the call using your paired cell phone. However, you can join the call using another **TL92271/TL92371/TL92471** handset. Your cell phone is being used for the phone call so only features that are normally available during a call can be used.

Options while on calls

Handset speakerphone

During a call or message playback, press **◀)/SPEAKER** to switch between speakerphone and normal handset use.

Volume control

During on a call, press **▲/VOLUME** to increase or press **▼/VOLUME** to decrease the listening volume. You hear an in-ear beep while adjusting. If you turn off the key tone, the in-ear beep will not be heard.

If this is a cell call and the volume is too loud or quiet, try changing the volume on your cell phone. On some cell phones, changing the volume on the cell phone effects your cell call volume on the **TL92271/TL92371/TL92471** handset.

Silencing the ringer

When the telephone is ringing, you can temporarily silence the ringer of the handset or telephone base without disconnecting the call. The next call rings normally at the preset volume.

To silence the ringer:

- Press **SILENCE**, **OFF/CANCEL** or **MUTE/DELETE** on the handset and **Ringer muted** appears.

Mute

Use the mute function to turn off the microphone. You can hear the caller, but the caller does not hear you.

To mute the call:

- Press **MUTE/DELETE**. When mute is on, the handset screen shows **Microphone off** for a few seconds and the **MUTE** icon appears until the mute function is turned off.

To take a call off mute:

- Press **MUTE/DELETE** and resume speaking. When mute is off, **Microphone on** appears temporarily on the handset screen.

Mute is automatically canceled when you end the call.

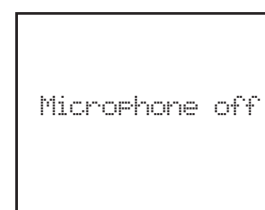

Options while on calls

Temporary tone dialing

If you have pulse (rotary) service only, you can switch from pulse to touch-tone dialing temporarily during a call. This is useful if you need to send touch-tone signals to access your telephone banking or long distance services.

During a call:

1. Press **TONE** .
2. Use the dialing keys to enter the relevant number. The telephone sends touch-tone signals.
3. The telephone automatically returns to pulse dialing mode after you end the call.

Hold

You can place a home or cell call on hold. You hear an alert tone if you have not taken the call off of hold after 14 minutes. You hear another alert tone 30 seconds later. At 15 minutes on hold, the call on hold automatically disconnects.

To place a home call on hold:

- Press **HOLD**. **Home call on hold** appears and  **HOME/FLASH** flashes.

To resume a home call on hold:

- Press  **HOME/FLASH**.

To place a cell call on hold:

- Press **HOLD**. **Cell call on hold** appears and  **CELLULAR** flashes.

To resume a cell call on hold:

- Press  **CELLULAR**.

Equalizer

The equalizer feature on the handset enables you to change the quality of the handset audio to best suit your hearing.

While on a call, or listening to a message or announcement, press **EQ**  to select the equalizer setting **Treble 1**, **Treble 2**, **Bass** or **Natural** (the default setting) for the handset. The current setting is shown on the handset for two seconds.

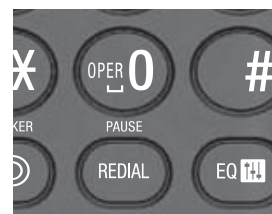

NOTES:

1. The equalizer feature does not apply to the speakerphone on the telephone base or the connected Bluetooth headset.
2. If you switch the call between the handset and speakerphone by pressing  **/SPEAKER**, the audio setting remains unchanged.
3. The current equalizer setting remains unchanged until a new setting is selected.

Options while on calls

Chain dialing

Use this feature to initiate a dialing sequence from numbers stored in the directory, call log or redial list while you are on a call.

Chain dialing can be useful if you wish to access other numbers (such as bank account numbers or access codes) from the directory, call log or redial list.

To access a number in the directory while on a call:

1. Press **OPTION**.
2. Press **CID▼** or **▲DIR** to highlight **Directory**, then press **SELECT**.
3. Press **CID▼** or **▲DIR** to highlight the desired directory, then press **REVIEW**.
4. Press **CID▼** or **▲DIR** to scroll to the desired entry or perform an alphabetical search (page 64).
5. Press **DIAL** to dial the displayed number.

To access a number in the call log while on a call:

1. Press **OPTION**.
2. Press **CID▼** or **▲DIR** to highlight **Caller ID log**, then press **SELECT**.
3. Press **CID▼** or **▲DIR** to highlight the desired directory, then press **REVIEW**.
4. Press **CID▼** or **▲DIR** to scroll to the desired entry.
5. Press **DIAL** to dial the displayed number.

To access the redial list while on a call:

1. Press **REDIAL/PAUSE**.
2. Press **CID▼**, **▲DIR**, or **REDIAL/PAUSE** until the desired number displays, then press **DIAL** to dial the displayed number.

NOTES:

1. You cannot edit a directory entry while on a call. For more details about the directory, see page 60.
2. You cannot copy a caller ID log entry into the directory while on a call. For more details about caller ID log, see page 70.
3. You can only view the numbers in the directory, call log or redial list while on a call and cannot edit, delete or save entries.
4. Press **OFF/CANCEL** to exit redial list, directory or caller ID log while on a call.

Options while on calls

Transfer a call

While on an outside call, you can transfer the call from one handset to another.

1. Press **OPTION**, then press **SELECT** to highlight **Transfer**.
 - If you have two handsets, your handset displays **Transferring call to HANDSET X**. The destination handset rings and displays **Home Transfer from other handset**.
 - If you have three or more handsets, your handset displays **TRANSFER TO:** and a list of registered handsets. Press **CID▼** or **▲DIR** to highlight destination handset and then press **SELECT**. Your handset displays **Transferring call to HANDSET X**, or **Transferring call to all...** when you choose **All handsets**. The destination rings and displays **Home Transfer from HANDSET X**.
2. Your handset displays **Call transferred** when the other handset picks up the call. You hear a confirmation tone.

i **NOTES:** If the destination handset does not answer within 30 seconds, the caller handset displays **No response to transfer** and hear an alert tone. If the caller handset does not answer the call on hold within 30 seconds, the call will end automatically.

Redial

Each handset stores the last 10 dialed numbers (up to 30 digits each) in the redial list. The redial entries are not shared by all the system handsets.

Review the redial list

1. Press **REDIAL/PAUSE** in idle mode.
2. Press **CID**▼, **▲DIR** or **REDIAL/PAUSE** to browse the list.
The handset beeps twice at the end of the list.

Press **OFF/CANCEL** to exit.



Dial a redial entry

1. Press **REDIAL/PAUSE** in idle mode.
2. Press **CID**▼, **▲DIR** or **REDIAL/PAUSE** to browse until the desired number displays. The handset beeps twice at the end of the list.
3. Press **HOME/FLASH** or **SPEAKER** to use the home line.

-OR-

Press **CELLULAR** to use the cell line.



Redial

Save a redial entry to the directory

1. Press **REDIAL/PAUSE** in idle mode.
2. Press **CID▼**, **▲DIR** or **REDIAL/PAUSE** to browse until the desired number displays.
3. Press **SAVE**.
4. The handset displays **EDIT NUMBER**. Use the dialing keys to edit the number, if necessary.
 - Press **MUTE/DELETE** to erase a digit.
 - Press and hold **MUTE/DELETE** to erase all digits.
 - Press **CID▼** to move the cursor to the right or **▲DIR** to the left.
 - Press and hold **REDIAL/PAUSE** to insert a dialing pause (a **p** appears).
5. Press **NEXT**.
6. Press **CID▼** or **▲DIR** to select one of the following types:
 - Home
 - Cell
 - Work
 - Other
7. Press **NEXT**. The handset displays **ENTER NAME**. Use the dialing keys (page 62) to enter a name.
 - Press **MUTE/DELETE** to erase a character.
 - Press and hold **MUTE/DELETE** to erase all characters.
 - Press **CID▼** to move the cursor to the right or **▲DIR** to the left.
8. Press **SAVE** and then **Saved** displays. You hear a confirmation tone.

Delete a redial entry

1. Press **REDIAL/PAUSE** when the handset is not in use.
2. Press **CID▼**, **▲DIR** or **REDIAL/PAUSE** to browse until the desired number displays.
3. Press **MUTE/DELETE** to delete the displayed number. You hear a confirmation tone.

Multiple handset use

Handset locator

This feature helps you find a misplaced handset.

To start paging:

Press **🔍/HANDSET LOCATOR** on the telephone base when it is not in use. All idle handsets ring and display **** Paging ****.

To end paging:

Press **🔍/HANDSET LOCATOR** on the telephone base.

-OR-

Press **🏠HOME/FLASH, 📣)/SPEAKER, (📶)CELLULAR, PUSH TO TALK, REDIAL/PAUSE, EQ📶** or any dialing keys (**0-9, #, TONE ✕**) on the handset.

iNOTES:

1. If the handset ringer volume is set to off, the handset still rings when paged.
2. If there is no response after 60 seconds, paging ends.

Join a call in progress

Another handset can join you on an outside call. That call continues until all people hang up. You can share an outside call with up to four system handsets.

- Press **🏠HOME/FLASH** or **📣)/SPEAKER** on another handset to join the call.

-OR-

- Press **OPTION** during an intercom, then press **⏴** or **⏵** to highlight **Share call**. Press **SELECT**.



Intercom

Use the intercom feature for conversations between two system handsets.

You can buy additional expansion handsets (**TL90071**) for this telephone system. You can register up to 12 handsets to the telephone base.

To initiate an intercom call:

1. Press **MENU** on the handset in idle mode.
2. Press **CID** or **DIR** to highlight **Intercom**, then press **SELECT**.
 - If you have two handsets, your handset displays **Calling other handset**. The destination handset rings and displays **Other handset is calling**.
 - If you have three or more handsets, your handset displays **INTERCOM** and a list of registered handsets.
 - Press **CID** or **DIR** to select a destination handset and then press **SELECT**. Your handset displays **Calling HANDSET X**. The other handset rings and displays **HANDSET X is calling**.

You may also press **1-9** for **HANDSET 1-9**, **TONE X** and **0** for **HANDSET 10**, **TONE X** and **1** for **HANDSET 11** or **TONE X** and **2** for **HANDSET 12**. Your handset displays **Calling HANDSET X**. The other handset rings and displays **HANDSET X is calling**.
 - Press **TONE X** and then **#** (pound key) to call all handsets.



To answer an intercom at the destination handset:

- Press **HOME/FLASH** or **SPEAKER**. Both handsets show **Intercom**.

Intercom

To silence an intercom call:

- Press  **OFF/CANCEL**, **MUTE/DELETE** or **SILENCE** on the destination handset. Its screen displays **Ringer muted** for a few seconds.

To end an intercom call:



- Press  **OFF/CANCEL**, **END** or place either handset back in the telephone base or charger. Both handsets display **Intercom ended**.

NOTES:



1. You can cancel the intercom call before it is answered by pressing  **OFF/CANCEL** or **END** on your originating handset.
2. If you are calling all devices, the quickest device will answer the intercom call.
3. If the destination handset does not answer the intercom call within 100 seconds, is in the directory or call log, or is out of range, the originating handset displays **No answer. Try again.** and returns to idle mode.

Answer an incoming call during an intercom call

When you receive an incoming home call during an intercom call, there is an alert tone, **Home Incoming call** and then the caller ID display on screens. The telephone base and all other handsets ring.

- Press  **HOME/FLASH** to answer the home call and the intercom call ends automatically.
- Press  **OFF/CANCEL** to end the intercom call without answering the incoming call. The telephone continues to ring.

When you receive an incoming cell call during an intercom call, there is an alert tone, **Cell Incoming call** and then the caller ID display on screens. The telephone base and all other handsets ring.

- Press  **CELLULAR** to answer the cell call and the intercom call ends automatically.
- Press  **OFF/CANCEL** to end the intercom call without answering the incoming call. The telephone continues to ring.

Call transfer using intercom

Use the intercom feature to transfer an outside call to another system handset.

1. When on an outside call, press **OPTION**.

2. Press **CID** or **DIR** to highlight **Intercom**, then press **SELECT**. The call is automatically put on hold.

- If you have two handsets system, the outside call is put on hold and your handset displays **Calling other handset**. The other handset rings and displays **Other handset is calling**.

- If you have more than two handsets, your handset displays **INTERCOM TO:**. Press **CID** or **DIR** to select a destination handset and then press **MENU/SELECT**.

Your handset displays **Calling HANDSET X**. The other handset rings and displays **HANDSET X is calling**. You may also press **1-9** for **HANDSET 1-9**, **TONE X** and **0** for **HANDSET 10**, **TONE X** and **1** for **HANDSET 11** or **TONE X** and **2** for **HANDSET 12**.

- Press **TONE X** and then **#** (pound key) to call all handsets.

3. To answer the call on the other handset, press **HOME/FLASH** or **SPEAKER**. The outside call is still on hold and both handsets now show **Intercom**.

4. From this intercom call, you have the following options:

- You can transfer the call. Press **OPTION** and then press **SELECT** to choose **Transfer** on the calling handset. Your screen shows **Call transferred**. The other handset automatically connects to the outside call.
- You can let the other handset join you on the outside call in a three-way conversation. Press **OPTION**, select **Share call**, and press **SELECT**.
- Either person can press the appropriate line key (**HOME/FLASH** or **CELLULAR**) on the handset to take the held outside call, or press **OFF/CANCEL** or **END** to end the intercom call (the outside call will automatically go off hold on the handset that did not hang up).



iNOTES:

1. If you want to cancel an intercom call and reconnect to the outside call before the destination handset answers, press **OFF/CANCEL** or **END** on the originating handset.
2. If the other handset does not answer the intercom call within 100 seconds, or if the other handset is in the directory or call log mode, or is out of range, the calling handset shows **No answer**. **Try again**. and returns to the outside call.



Push-to-talk (PTT)

You can directly broadcast messages from one handset to the speakerphone of one or all other handsets. Any handset called can respond by pressing **PUSH TO TALK** to begin a two-way communication. If only one handset is available or registered, the handset screen shows **PTT requires two handsets** when you press **PUSH TO TALK**.



- Only one handset can talk at a time. To do so, press and hold the **PUSH TO TALK** button.
- You must release **PUSH TO TALK**, so the other person can respond.
- Only one PTT can be active at a time.
- While PTT is in use between handsets, other handsets cannot use the intercom feature but can access the answering system.
- When you attempt to place a PTT call to another handset which is accessing the answering system, your handset displays **Not available at this time**.

PTT on/off

You can turn PTT on or off on each handset.

- When on, the handset can begin and receive PTT calls.
- When off, the handset can begin PTT calls but will not receive PTT calls from other handset(s). The idle handset displays **No Incoming PTT**.
- When you attempt to place a PTT call to another handset that has the PTT feature turned off, your handset displays **Not available at this time**.

To turn PTT on or off:

1. Press **PUSH TO TALK** when the handset is not in use. The **PUSH TO TALK** menu displays.
2. Press **CID**▼ or **▲DIR** to highlight **PTT On/Off**, then press **SELECT**.
3. Press **CID**▼ or **▲DIR** to choose **On** or **Off**, then press **SELECT** to save. You hear a confirmation tone.



i **NOTES:** When PTT is turned off, the handset shows **No Incoming PTT** while the phone is not in use.

Push-to-talk (PTT)

PTT to a single handset

1. You have two ways to begin a PTT call:

- If you have two handsets, press and hold **PUSH TO TALK** when handset is not in use.
- If you have three or more handsets, press **PUSH TO TALK** when the handset is not in use. Then use the dialing keys to enter a handset number (**1-9** for handsets 1-9, and **0** for handset 10, and **1** for handset 11 or and **2** for handset 12), or press **CID**▼ or **▲DIR** to scroll to the desired handset then press **SELECT**. Press **SELECT** or **PUSH TO TALK** to create the push-to-talk session.

-OR-

Use the dialing keys to enter the destination handset number.

If you have two handsets, press and hold **PUSH TO TALK** when handset is not in use to call the other handset.

3. Your handset displays **Connecting to HANDSET X...** for a few seconds. When the connection is made, both your and the destination handsets display **Press and hold [PTT] to talk** and beep once.
4. Press and hold **PUSH TO TALK** on your handset. A chirp indicates your microphone is on. Speak towards the handset. Your voice is broadcast to the destination handset. While you are speaking, the handset displays **PTT To HANDSET X** (X represents the destination handset number).
5. Release **PUSH TO TALK** after speaking. All handsets beep once again. After the handsets beep, you can press and hold **PUSH TO TALK** to continue speaking or the destination handsets can respond (see **Answer a PTT call** on)
6. To end the PTT call, press **OFF/CANCEL** or **END**. The handset displays Push to talk Ended for a few seconds.

-OR-

Place the handset in the telephone base or charger to end the PTT call.

i **NOTES:** After **PUSH TO TALK** is released, the PTT call remains open for a short time. If no one presses **PUSH TO TALK** within 10 seconds, the PTT call ends automatically.

Push-to-talk (PTT)

PTT to all handsets

When you have two to four registered handsets, PTT supports one-to-all calls (one-to-four maximum). However, when you have six or more registered handsets, PTT supports a maximum of one-to-three calls. The first four registered handsets will be able to use this feature. Other handsets can only use PTT for one-to-one calls.

1. To begin a PTT-to-all call:

- Press and hold **PUSH TO TALK** when the handset is not in use.
- If you have three or more handsets, press **PUSH TO TALK** when the handset is not in use. Press **-tone X** and **#**, or press **CID** or **▲DIR** to highlight **Group** then press **SELECT** or **PUSH TO TALK**.

Your handset displays **Connecting to group...** for a few seconds. When the connection is made, both your and the destination handsets display **Press and hold [PTT]** to talk and beep once.

2. Press and hold **PUSH TO TALK** on your handset. A chirp indicates your microphone is on. Speak towards the handset. Your voice is broadcast to the destination handset. While you are speaking, the handset displays **PTT To handset X** (X represents the destination handset).
3. Release **PUSH TO TALK** after speaking. All handsets beep once again. After the handsets beep, you can press and hold **PUSH TO TALK** to continue speaking or the destination handsets can respond (see **Answer a PTT call** on page 58)
4. Press **OFF/CANCEL** or **END** to end the PTT call. The handset displays **Push to talk Ended** for a few seconds.

-OR-

Place the handset in the telephone base or charger to end the PTT call.

i **NOTES:** After **PUSH TO TALK** is released, the PTT call remains open for a short time. If no one presses **PUSH TO TALK** within 10 seconds, the PTT call ends automatically.

Push-to-talk (PTT)

Answer a PTT call

You can respond to a PTT call whenever the speakerphone light is off, as described below.

1. When your handset receives a PTT call, the handset beeps and displays **Press and hold [PTT] to talk**.
2. When someone else is speaking, your speakerphone light is on, and your handset displays **PTT From HANDSET X To HANDSET: Y** (the first **X** represents the initiating handset number and **Y** represents your handset number; a maximum of four handset numbers appear).
3. When your speakerphone light is off (the handset displays **Press and hold [PTT] to talk**), you hear a beep. Press and hold **PUSH TO TALK** on your handset. When you hear a chirp, speak towards the handset.
 - While you are speaking, your handset displays **PTT To HANDSET X** (**X** represents the handset numbers of one or more destination handsets; a maximum of four handset numbers appear).
 - Your voice is broadcast to all destination handsets.

Release **PUSH TO TALK** when you finish your speaking. Your handset will beep. After the beep, if your speakerphone light is off, you can press and hold **PUSH TO TALK** to continue speaking or the destination handsets can respond.

Change a one-to-one PTT to intercom call

You can convert a one-to-one PTT conversation to an intercom call.

1. When your handset displays **Press and hold [PTT] to talk**, press **INTCOM**. Your handset displays **Switch to Intercom?** Press **SELECT** to confirm.
 - If you have two handsets, your handset displays **Calling other handset**. The destination handset temporarily displays **Push to talk Ended** and then **Other handset is calling**.
 - If you have three or more handsets, your handset displays **Calling HANDSET Y** (**Y** represents the destination handset). The destination handset temporarily displays **Push to talk Ended** and then **Handset X is calling** (**X** represents the originating handset).
2. On the destination handset, press **HOME/FLASH** or **SPEAKER** to answer the intercom call. Both handsets now display **Intercom**.
3. To end an intercom call, press **OFF/CANCEL** or place the handset in the telephone base or charger. Both handsets display **Intercom ended**.

Push-to-talk (PTT)

Answer a PTT call

You can respond to a PTT call whenever the speakerphone light is off, as described below.

1. When your handset receives a PTT call, the handset beeps and displays **Press and hold [PTT] to talk**.
2. When someone else is speaking, your speakerphone light is on, and your handset displays **PTT From HANDSET X To HANDSET: Y** (the first **X** represents the initiating handset number and **Y** represents your handset number; a maximum of four handset numbers appear).
3. When your speakerphone light is off (the handset displays **Press and hold [PTT] to talk**), you hear a beep. Press and hold **PUSH TO TALK** on your handset. When you hear a chirp, speak towards the handset.
 - While you are speaking, your handset displays **PTT To HANDSET X** (**X** represents the handset numbers of one or more destination handsets; a maximum of four handset numbers appear).
 - Your voice is broadcast to all destination handsets.

Release **PUSH TO TALK** when you finish your speaking. Your handset will beep. After the beep, if your speakerphone light is off, you can press and hold **PUSH TO TALK** to continue speaking or the destination handsets can respond.

Change a one-to-one PTT to intercom call

You can convert a one-to-one PTT conversation to an intercom call.

1. When your handset displays **Press and hold [PTT] to talk**, press **INTCOM**. Your handset displays **Switch to Intercom?** Press **SELECT** to confirm.
 - If you have two handsets, your handset displays **Calling other handset**. The destination handset temporarily displays **Push to talk Ended** and then **Other handset is calling**.
 - If you have three or more handsets, your handset displays **Calling HANDSET Y** (**Y** represents the destination handset). The destination handset temporarily displays **Push to talk Ended** and then **Handset X is calling** (**X** represents the originating handset).
2. On the destination handset, press **HOME/FLASH** or **SPEAKER** to answer the intercom call. Both handsets now display **Intercom**.
3. To end an intercom call, press **OFF/CANCEL** or place the handset in the telephone base or charger. Both handsets display **Intercom ended**.

Push-to-talk (PTT)

End a PTT call

- For a one-to-one PTT call, both the originating and destination handsets can end the PTT call.
- For one-to-all PTT, the initiating handset can end the PTT call for all handsets on the PTT call. If any one of the destination handsets leaves the PTT call, the call continues until all participants or the initiator hangs up.







To end or leave PTT:

Press  **OFF/CANCEL** or place the handset in the telephone base or charger. The handset displays **Push to talk Ended**.







 **NOTES:** After **PUSH TO TALK** is released, the PTT call remains open for a short time. If no one presses **PUSH TO TALK** within 10 seconds, the PTT call ends automatically.

Answer an incoming call during PTT

When you receive an incoming outside call during PTT, there is a call waiting tone. The caller ID is displayed with PTT screen alternately.

- During a one-to-one PTT, press  **HOME/FLASH** or  **CELLULAR** on the originating or destination handset. The PTT call ends automatically and the outside call is answered.
- During a one-to-all PTT, press  **HOME/FLASH** or  **CELLULAR** on the originating handset. The PTT call ends automatically and the outside call is answered.
- During a one-to-all PTT, press  **HOME/FLASH** or  **CELLULAR** on any one of the destination handsets and that handset answers the outside call. The PTT call continues for the rest of the PTT participants.
- To leave the PTT call without answering the incoming call, press  **OFF/CANCEL**. The telephone continues to ring.

Make an outgoing call during PTT

- During a one-to-one PTT call, press  **HOME/FLASH** or  **CELLULAR** to get a dial tone. The PTT call ends automatically.
- During a one-to-all PTT call, press  **HOME/FLASH** or  **CELLULAR** on the originating handset. The PTT call ends automatically and you get a dial tone.
- During a one-to-all PTT call, press  **HOME/FLASH** or  **CELLULAR** on any one of the destination handsets and that handset gets a dial tone. The PTT call continues for the rest of the PTT participants.

About the directory

The home directory stores up to 200 entries with up to 30 digits for each phone number and 15 characters for each name. Each of the downloaded directories stores up to 1,500 entries with up to 30 digits for each phone number and 15 characters for each name.

- Directory entries are stored at the telephone base and shared by all system handsets. Any changes made on one handset apply to all.
- Only one handset can review the directory at a time. If another handset tries to enter the directory, its screen shows **Not available at this time.**
- When there are no records in the directory, the screen shows **Directory empty.**
- When the directory is full and you try to save an entry, the screen shows **Directory full.**
- When you try to save a number already stored in the directory, the screen shows **Already saved.**

All of the instructions on pages 61-67 for the directories apply to the home directory and all downloaded directories. Creating a new entry on page 61 only applies to the home directory.

You cannot create new entries in your downloaded directories from the **TL92271/TL92371/TL92471** handset. Entries must be downloaded from your cell phone (see **Download directory** on pages 23-24).

Create and review entries

Create a new entry in the home directory

1. Press **MENU** on the handset in idle mode to enter the main menu.
2. Press **CID▼** or **▲DIR** to highlight **Directory**, then press **SELECT**.
3. Press **OPTION** to select **Home**.
4. Press **CID▼** or **▲DIR** to highlight **Add contact**, then press **SELECT**. The screen displays **ENTER NUMBER**.
5. Use the dialing keys to enter a telephone number.
 - Press **MUTE/DELETE** to erase a digit.
 - Press and hold **MUTE/DELETE** to erase all digits.
 - Press **CID▼** to move the cursor to the right or **▲DIR** to the left.
 - Press and hold **REDIAL/PAUSE** to insert a dialing pause (a **p** appears).

-OR-

Copy a number from the redial list.

1. Press **REDIAL/PAUSE** and then **CID▼**, **▲DIR** or **REDIAL/PAUSE** repeatedly to browse to select a number.
 2. Press **INSERT** to copy the displayed number.
6. Press **NEXT**.
 7. Press **CID▼** or **▲DIR** to select one of the following types:
 - Home
 - Cell
 - Work
 - Other
 8. Press **NEXT**. The screen displays **ENTER NAME**.
 9. Use the dialing keys (see page 62) to enter the name.
 - Press **MUTE/DELETE** to erase a character.
 - Press and hold **MUTE/DELETE** to erase all characters.
 - Press **CID▼** to move the cursor to the right or **▲DIR** to the left.
 10. Press **SAVE** to confirm and the screen shows **Saved**. You hear a confirmation tone.

i **NOTE:** You cannot create new entries in your downloaded directories from your **TL92271/TL92371/TL92471** handsets. Entries must be downloaded from your cell phone (see **Download directory** on pages 23-24).

Create and review entries

Number key	Characters by number of key presses										
	1	2	3	4	5	6	7	8	9	10	11
1	1	.	-	'	()	*	#	&	/	,
2	A	B	C	a	b	c	2				
3	D	E	F	d	e	f	3				
4	G	H	I	g	h	i	4				
5	J	K	L	j	k	l	5				
6	M	N	O	m	n	o	6				
7	P	Q	R	S	p	q	r	s	7		
8	T	U	V	t	u	v	8				
9	W	X	Y	Z	w	x	y	z	9		
0	Space	0									
*											
#											

 **NOTE:** When entering a name in the directory, the first letter of each word is automatically capitalized.

Create and review entries

To add a predialed telephone number to the directory

You can save a predialed telephone number to the directory.

1. Enter the telephone number in idle mode (see step 5 in **Create a new entry in the home directory** on page 61).
2. Press **SAVE** to edit the number (see step 3 in **Edit a directory entry** on page 65) and then press **NEXT**.
3. Press **CID**▼ or **▲DIR** to select one of the following types:
 - Home
 - Cell
 - Work
 - Other
4. Press **NEXT**. The screen displays **ENTER NAME**.
5. Use the dialing keys (see page 62) to enter the name.
 - Press **MUTE/DELETE** to erase a character.
 - Press and hold **MUTE/DELETE** to erase all characters.
 - Press **CID**▼ to move the cursor to the right or **▲DIR** to the left.
6. Press **SAVE** and the screen shows **Saved**. You hear a confirmation tone.

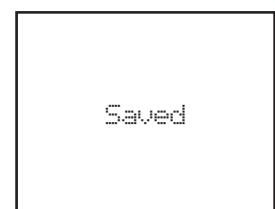

Create and review entries

Review the directory

Entries are sorted alphabetically.

1. Press **▲DIR** in idle mode.
2. Press **CID▼** or **▲DIR** to choose a directory, then press **REVIEW**.
3. Press **CID▼** or **▲DIR** to browse.

-OR-

1. Press **MENU** on the handset in idle mode to enter the main menu.
2. Press **CID▼** or **▲DIR** to highlight **Directory**, then press **SELECT**.
3. Press **CID▼** or **▲DIR** to choose a directory, then press **REVIEW**.
4. Press **CID▼** or **▲DIR** to browse.

-OR-

1. Press **OPTION** while on call.
2. Press **CID▼** or **▲DIR** to highlight **Directory**, then press **SELECT**.
3. Press **CID▼** or **▲DIR** to choose a directory, then press **REVIEW**.
4. Press **CID▼** or **▲DIR** to browse.

i NOTE: When the desired entry displays, press **#** repeatedly to show different dialing options.

3-character alphabetical search

You can use the enhanced 3-character search to find your contacts quickly and efficiently.

To start the search:

1. Follow the steps in **Review the directory** above to enter the directory.
2. When an entry appears, use the dialing keys to enter the letters associated with the name (see page 62). You can enter up to three letters for the search. The letters will show in the top left hand corner of the screen. If there is no name matching the letters entered, the next closest match in alphabetical order appears. If necessary, use **CID▼** or **▲DIR** to browse.

i NOTE: The cursor automatically moves to the next position two seconds after you enter a letter. If you do not enter another letter in the coming two seconds, the handset starts searching in the directory.

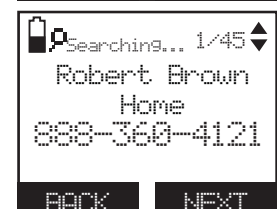

Dial, edit or delete a directory

Dial a directory entry

You can dial a directory entry on either a home or cell line.

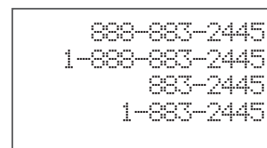
**To dial a directory entry:**

1. Search for the desired entry in the directory (see **Review the directory** or **3-character alphabetical search** on page 64).
2. When the desired entry appears, press **#** (pound key) repeatedly to show different dialing options.
3. When the displayed number is in the correct format, press **HOME/FLASH** or **SPEAKER** to use the home line, or **CELLULAR** to use the cell line.

Edit a directory entry

You may edit any directory entry. However, be aware that if you download from a cell phone again, the directory is erased and replaced with the current cell phone directory. If you have edited the downloaded entries on the **TL92271/TL92371/TL92471**, those changes are lost. To avoid losing changes made to the downloaded directory, we suggest you edit the number in your cell phone, then download the directory.

1. Search for the desired entry in the directory (see **Review the directory** or **3-character alphabetical search** on page 64).
2. When the desired entry appears, press **REVIEW**, then press **EDIT**. The handset shows **EDIT NUMBER**.
3. Use the dialing keys to edit the number.
 - Press **MUTE/DELETE** to erase a digit.
 - Press and hold **MUTE/DELETE** to erase all digits.
 - Press **CID▼** to move the cursor to the right or **▲DIR** to the left.
 - Press and hold **REDIAL/PAUSE** to insert a dialing pause (a **p** appears).
4. Press **NEXT**.
5. Press **CID▼** or **▲DIR** to select one of the following types:
 - Home
 - Cell
 - Work
 - Other
6. Press **NEXT**. The screen displays **EDIT NAME**.
7. Use the dialing keys (see page 64) to enter the name.
 - Press **MUTE/DELETE** to erase a character.
 - Press and hold **MUTE/DELETE** to erase all characters.
 - Press **CID▼** to move the cursor to the right or **▲DIR** to the left.
8. Press **SAVE** to confirm and the handset shows **Saved**.

Dial, edit or delete a directory

Edit the type of a directory entry

If you only want to edit the type of a directory entry:

1. Search for the desired entry in the directory (see **Review the directory or 3-character alphabetical search** on page 64).
2. When the desired entry appears, press **LABEL**. Enter the corresponding shortcut keys shown in the below table.

Type:	Press:
Home	1
Cell	2
Work	3
Other	4

-OR-

Press **CLEAR** to erase the assigned label.

Delete a directory entry

To delete an entry:

1. Search for the desired entry in the directory (see **Review the directory or 3-character alphabetical search** on page 64).
2. When the desired entry appears, press the **MUTE/DELETE**. The screen displays **Delete contact?** and the name of the entry. Press **YES** to confirm.
3. The screen displays **Contact deleted** and then the next alphabetical entry in the directory. You hear a confirmation tone.

 **NOTE:** Once a directory entry is deleted, it cannot be retrieved.

Remove a downloaded directory

1. Search for the desired entry in the directory (see **Review the directory or 3-character alphabetical search** on page 64).
2. When the desired downloaded directory is chosen, press **OPTION**, then press **CID▼** or **▲DIR** to highlight **Remove dir**.
3. Press **SELECT**. The screen displays **Directory Cell Phone A will be erased**. Press **YES** to confirm.
4. The handset displays **Erasing directory...** and then **Directory removed**. You hear a confirmation tone.

Directory Speed Dial

You can assign 10 of your director entries to a speed dial location (**0-9**). The speed dial entries are shared by all handsets.

Assign a speed dial slot

Up to 10 speed dial entries can be stored. The speed dial number must be created from an existing entry in the Home or Bluetooth directory.

1. Press **MENU** on handset when it is not in use..
2. Press **CID▼** or **▲DIR** to highlight **Directory**, then press **SELECT**.
3. Press **CID▼** or **▲DIR** to highlight **Speed dial**, then press **REVIEW**.
4. Press **CID▼** or **▲DIR** to highlight an empty slot, then press **ASSIGN**.
5. Press **CID▼** or **▲DIR** to highlight the desired directory, then press **REVIEW**.
6. Search for the desired entry in the directory (see **Review the directory** or **3-character alphabetical search** on page 64). When the desired entry appears, press **ASSIGN**. You hear a confirmation tone.

Reassign a speed dial slot

1. Press **MENU** in idle mode.
2. Press **CID▼** or **▲DIR** to highlight **Directory** and then press **SELECT**.
3. Press **CID▼** or **▲DIR** to highlight **Speed dial**, then press **REVIEW**.
4. Press **CID▼** or **▲DIR** to highlight the desired slot.
5. Press **ASSIGN**. The handset displays the directory at the current assigned entry.
6. Search for the desired entry in the directory (see **Review the directory** or **3-character alphabetical search** on page 64). When the desired entry appears, press **ASSIGN**.
7. The handset displays **Entry B replaces Entry A Accept?** Press **YES** to confirm. You hear a confirmation tone.

Dial a speed dial entry

1. Press and hold a desired speed dial slot (**0-9**).
2. Press **HOME/FLASH** or **◀)/SPEAKER** to use the home line, or **📶)CELLULAR** to use the cell line.

Delete a speed dial entry

1. Press **MENU** in idle mode.
2. Press **CID▼** or **▲DIR** to highlight **Directory** and then press **SELECT**.
3. Press **CID▼** or **▲DIR** to highlight **Speed dial**, then press **REVIEW**.
4. Press **CID▼** or **▲DIR** to highlight assigned slot, then press **DELETE**.
5. The handset displays **Delete Entry A Speed dial assignment?** Press **YES** to confirm. You hear a confirmation tone.

 **NOTE:** Deleting speed dial entries does not affect the directory entries.

About caller ID

This product supports caller ID services provided by most telephone service providers. Caller ID allows you to see the name, number, date and time of calls. The available caller ID information will appear after the first or second ring. Caller ID from the home line allows you to see the name, number, date and time of the incoming calls. The caller ID may appear differently if the caller is matched to a directory entry (see **Memory match** on page 70).

Information about caller ID with call waiting

Caller ID with call waiting lets you see the name and telephone number of the caller before answering the telephone, even while on another call.

It may be necessary to change your telephone service to use this feature. Contact your telephone service provider if:

- You have both caller ID and call waiting, but as separate services (you may need to combine these services).
- You have only caller ID service, or only call waiting service.
- You don't subscribe to caller ID or call waiting services.

There are fees for caller ID services. In addition, services may not be available in all areas.

Caller ID information is available only if both you and the caller are in areas offering caller ID service, and if both telephone service providers use compatible equipment.

The caller ID information may not be available for every incoming call. The callers may intentionally block their names and/or telephone numbers. A call log entry can show a maximum number of 24 digits.

i NOTE: You can use this product with regular caller ID service, or you can use this product's other features without subscribing to caller ID or combined caller ID with call waiting service.



Caller ID operation

How the caller ID history (caller ID log) works

The telephone stores caller ID information about the last 50 incoming calls in the telephone base. Entries are stored in reverse chronological order. The phone deletes the oldest entry when the log is full to make room for new calls. This information is common to all handsets, so changes made using any handset are reflected in all other handsets. If you answer a call before the information appears on the screen, it does not show in the caller ID history.

i NOTE: If the phone number has more than 24 digits, it will not be saved or shown in the call log.



Memory match

If the incoming telephone number matches the last seven digits of a telephone number in your directory, the name that appears on the screen matches the corresponding name in your directory.

For example, if Christine Smith calls, her name appears as **Chris** if this is how you enter it into your directory.

i NOTE: The number you see on your caller ID is in the format from the telephone service provider. It usually delivers 10-digit telephone numbers (area code plus telephone number). If the last seven digits of the incoming telephone number do not match a number in your directory, the name appears as it is delivered by the telephone service provider.



Caller ID operation

To review the caller ID log

Review the caller ID history to find out who called, to easily return a call, or to copy the caller's name and number into your directory. **Caller ID log empty** appears if there are no records in the caller ID log.

1. When a handset is in idle mode, press **CID** to review the caller ID history in reverse chronological order starting with the most recent call.

-OR-

You can also review the caller ID history by pressing **MENU**, then press **CID** or **DIR** to scroll to **Caller ID log**, then press **SELECT**.

2. Press **CID** or **DIR** to highlight the desired line (home or cell), then press **REVIEW**.
3. Press **CID** or **DIR** to browse.

NOTE: Only one handset can review the caller ID history at time. If another handset tries to enter the directory or caller ID history. It shows **Not available at this time**.



Caller ID operation

View dialing options

Although the call log entries may contain 10 digits (the area code plus the seven-digit number), in some areas, you may need to dial only the seven digits, or **1** plus the seven digits, or **1** plus the area code plus the seven digits. You can change the number of digits that you dial from the call log or store to the directory.

While reviewing the call log, press **#** repeatedly to show different dialing options for local and long distance numbers before dialing or saving the telephone number in the directory.



Press **1** repeatedly if you need to add or remove **1** in front of the telephone number before dialing or saving it in the directory.

When the number shows in the correct format for dialing, press **HOME/FLASH** or **SPEAKER** to call the number using the home line.

-OR-

Press **CELLULAR** to call the number using the cell line.

Dial a caller ID log entry

1. Search for the desired entry in the caller ID log (see **To review the caller ID log** on page 71).
2. When the desired entry is displayed and is in the correct format for dialing, press **HOME/FLASH** or **SPEAKER** to use the home line, or **CELLULAR** to use the cell line.

Save a caller ID log entry to the directory

Call log entries can only be saved to the **Home** directory.

1. Select a desired entry in the caller ID log (see **To review the caller ID log** on page 71).
2. When the desired entry appears, press **#** repeatedly to show different dialing options.
3. When the number is in the correct format, press **SAVE**. The handset shows **EDIT NUMBER**.
4. Use the dialing keys to edit the number.
 - Press **MUTE/DELETE** to erase a digit.
 - Press and hold **MUTE/DELETE** to erase all digits.
 - Press **CID▼** to move the cursor to the right or **▲DIR** to the left.
 - Press and hold **REDIAL/PAUSE** to insert a dialing pause (a **p** appears).
5. Press **NEXT**.
6. Press **CID▼** or **▲DIR** to select one of the following types:
 - Home
 - Cell
 - Work
 - Other
7. Press **NEXT**. The screen displays **EDIT NAME**.
8. Use the dialing keys (see page 62) to edit the name.
 - Press **MUTE/DELETE** to erase a character.
 - Press and hold **MUTE/DELETE** to erase all characters.
 - Press **CID▼** to move the cursor to the right or **▲DIR** to the left.
 - Press **-tone X** to toggle the name order. For example, Robert Brown becomes Brown Robert when you press **tone X**.
9. Press **SAVE** to confirm and the screen shows **Saved**. You hear a confirmation tone.

NOTES:

1. If the name received from the telephone service provider is all in capital letters, the first letter of every word remains a capital letter. However, the next letter after the prefix "Mac", "Mc", or "O", is kept as a capital letter. For example, the "D" in "MacDonald" is kept as a capital letter.
2. When you try to save a caller ID entry without any caller ID information, the handset displays **Unable to save**.

Caller ID operation

To delete a single entry

1. Select a desired entry in the caller ID log (see **To review the caller ID log** on page 71).
2. When the desired entry is displayed, press **MUTE/DELETE**. The handset shows the previous call log entry. You hear a confirmation tone.

To delete all entries

1. Press **CID** on the handset in idle mode.
2. Press **ERASE**. If you choose the home caller ID log, the handset displays **Delete all Home Calls?**. If you choose a cell phone caller ID log, the handset displays **Delete all Cell phone A calls?**. Press **YES** to confirm. You hear a confirmation tone.



-OR-

1. Press **MENU** on the handset in idle mode to enter the main menu.
2. Press **CID** or **DIR** to highlight **Caller ID log**, then press **SELECT**.
3. Press **ERASE**. If you choose the home caller ID log, the handset displays **Delete all Home Calls?**. If you choose a cell phone caller ID log, the handset displays **Delete all Cell phone A calls?**. Press **YES** to confirm. You hear a confirmation tone.

Reasons for missing caller ID information

There are occasions when other information or no information shows for various reasons:

On-screen message	Reason
L	It is a long distance call.
Private name	The caller prefers not to show the name.
Private number	The caller prefers not to show the phone number.
Private caller	The caller prefers not to show the phone number and name.
Unknown name	Your telephone service provider cannot determine the caller's name.
Unknown number	Your telephone service provider cannot determine the caller's number.
Unknown caller	No information is available about this caller.

Answering system settings

Answer on/off

If you turn the answering system on, it answers calls and records messages only on the home line. If your paired cell phone has voicemail, callers can leave messages with that voicemail service.

If your answering system is turned off and you change any of its settings, the answering system automatically turns on again and the handset displays **Calls will be answered.**

When the answering system is turned on, the **ANS ON** light on the telephone base is on and the handsets display **ANS ON.**

To turn the answering system on or off:

Using the telephone base:

Press **ANS ON** to turn the answering system on or off. When the answering system is turned on, it announces, **"Calls will be answered."** When the answering system is turned off, it announces, **"Calls will not be answered."**

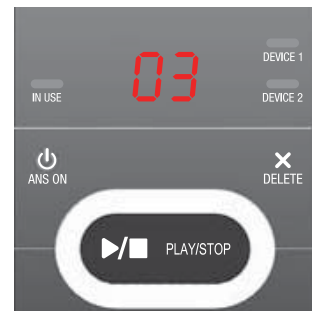

NOTES:

1. If there is no remaining recording time, the answering system announces **"Calls will not be answered."** and cannot be turned on.
2. If the total recording time is less than three minutes, the answering system announces **"Less than three minutes to record."** and your handsets display **Rec mem low.**
3. If the answering system is off, you may press **ANS ON** on the telephone base to turn on the answering system during an incoming call. The answering system answers the call immediately if there is remaining time..

Using a handset:

1. Press **MENU** on the handset in idle mode to enter the main menu.
2. Press **CID** or **DIR** to highlight **Answering sys**, then press **SELECT**.
3. Press **CID** or **DIR** to highlight **Answer ON/OFF**, then press **SELECT**.
4. Press **CID** or **DIR** to choose **On** or **Off**, then press **SET** to save. You hear a confirmation tone.

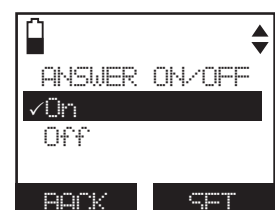

Answering system settings

Announcement

An announcement is the greeting callers hear when calls are answered by the answering system.

The telephone is preset with a greeting that answers calls with *“Hello, please leave a message after the tone.”* You can use this preset announcement, or replace it with your own.

Play your announcement

1. Press **MENU** on the handset in idle mode to enter the main menu.
2. Press **CID**▼ or **▲DIR** to highlight **Answering sys**, then press **SELECT**.
3. Press **SELECT** again to select **Announcement**.
4. The handset displays **ANNOUNCEMENT**. Press **PLAY**.

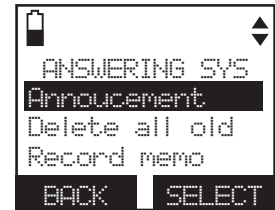

Record your own announcement

1. Press **MENU** on the handset in idle mode to enter the main menu.
2. Press **CID**▼ or **▲DIR** to scroll to **Answering sys**, then press **SELECT**.
3. Press **SELECT** again to select **Announcement**.
4. The handset displays **ANNOUNCEMENT**, press **RECORD**.
5. The handset announces, *“Record after the tone. Press **STOP** when you are done.”* After the tone, speak towards the microphone of the handset.
6. Press **STOP** when you finish recording.
7. The handset automatically plays back the newly recorded announcement. Press **STOP** to stop the playback at any time. After the announcement playback, press **PLAY** to replay the recorded announcement, or **RECORD** to record again if desired.

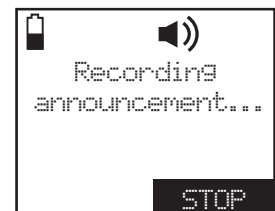

iNOTES:

1. Your announcement can be up to 90 seconds in length.
2. Announcements shorter than two seconds are not recorded.

Answering system settings

Delete your announcement

1. Press **MENU** on the handset in idle mode to enter the main menu.
2. Press **CID** or **DIR** to scroll to **Answering sys**, then press **SELECT**.
3. Press **SELECT** again to select **Announcement**.
4. The handset displays **ANNOUNCEMENT**, press **PLAY** to play the announcement.
5. While the announcement is playing, press **DELETE** to delete your own recorded announcement. The handset displays **Reset announcement to default?** Press **YES** to confirm. You hear a confirmation tone.

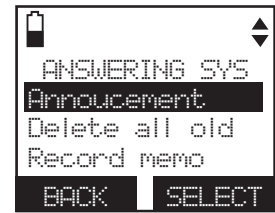

i **NOTE:** When your announcement is deleted, calls are answered with the default announcement.

Answering system settings

In the answering system setup menu, you can change the settings for call screening, number of rings, remote access code and message alert tone and recording time.

Call screening

The call screening feature lets you listen at the telephone base to a caller leaving a message. If you turn call screening on, you can press **SCREEN** on a handset to hear the incoming message. While monitoring an incoming message, you can answer the call by pressing **HOME/FLASH** or **)/SPEAKER** on the handset.

To change the settings:

1. Press **MENU** on the handset in idle mode to enter the main menu.
2. Use **CID** or **DIR** to scroll to **Answering sys**, then press **SELECT**.
3. Use **CID** or **DIR** to scroll to **Ans sys setup**, then press **SELECT** twice to select **Call screening**.
4. Press **CID** or **DIR** to choose between **On** and **Off.**, then press **SET** to save. You hear a confirmation tone.

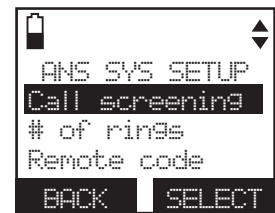

i **NOTE:** For more information on call screening, see page 83.

Answering system settings

Number of rings

When the answering system is turned on, it answers all incoming home calls after the number of rings set. You can choose from two, three, four, five, or six rings; or toll saver. With toll saver selected, the answering system answers after two rings when you have new messages, and after four rings when you have no new messages.

This enables you to check for new messages and avoid paying unnecessary long distance charges if you are calling from out of your local area. The default number of rings is four.

To set the number of rings:

1. Press **MENU** on the handset in idle mode to enter the main menu.
2. Press **CID▼** or **▲DIR** to highlight **Answering sys**, then press **SELECT**.
3. Press **CID▼** or **▲DIR** to highlight **Ans sys setup**, then press **SELECT**.
4. Press **CID▼** or **▲DIR** to highlight **# of rings**, then press **SELECT**.
5. Press **CID▼** or **▲DIR** to choose from **6, 5, 4, 3, 2** or **Toll saver**, then press **SET** to save. You hear a confirmation tone.

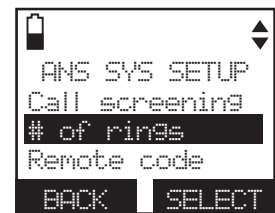

Answering system settings

Remote access code

A two-digit security code is required to access the answering system remotely from any touch-tone telephone. The preset code is **19**. You can change the code to any number from **00** to **99**.

To change the remote code:

1. Press **MENU** on the handset in idle mode to enter the main menu.
2. Use **CID** or **DIR** to scroll to **Answering sys**, then press **SELECT**.
3. Use **CID** or **DIR** to scroll to **Ans sys setup**, then press **SELECT**.
4. Press **CID** or **DIR** to scroll to **Remote code**, then press **SELECT**.
5. Use the dialing keys (**0-9**) to enter a two-digit number from **00-99**, then press **SET** to save. You hear a confirmation tone.
 - Press **MUTE/DELETE** to erase a digit.
 - Press and hold **MUTE/DELETE** to erase all digits.
 - Press **CID** to move the cursor to the right or **DIR** to the left.

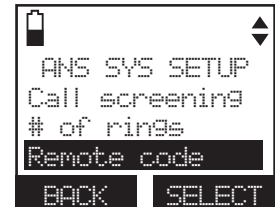

Message alert tone

When the message alert tone is set to **On**, the telephone base beeps every 10 seconds to alert you of new messages. The tone stops when all new messages have been reviewed. The default message alert setting is off.

To change the setting:

1. Press **MENU** on the handset in idle mode to enter the main menu.
2. Use **CID** or **DIR** to scroll to **Answering sys**, then press **SELECT**.
3. Use **CID** or **DIR** to scroll to **Ans sys setup**, then press **SELECT**.
4. Press **CID** or **DIR** to scroll to **Msg alert tone**, then press **SELECT**.
5. Press **CID** or **DIR** to choose between **On** and **Off**, then press **SET** to save your setting. You hear a confirmation tone.



i NOTE: You cannot set the message alert tone when another handset or the telephone base is accessing the answering system.

Answering system settings

Recording time

You can set the recording time limit for each incoming message. The default setting is three minutes.

To change the setting:

1. Press **MENU** on the handset when it is not in use.
2. Press **CID▼** or **▲DIR** to highlight **Answering sys**, then press **SELECT**.
3. Press **CID▼** or **▲DIR** to highlight **Ans sys setup**, then press **SELECT**.
4. Press **CID▼** or **▲DIR** to highlight **Recording time**, then press **SELECT**.
5. Press **CID▼** or **▲DIR** to choose from **3 minutes**, **2 minutes**, or **1 minute**, then press **SET** to save. You hear a confirmation tone.



About the answering system

Answering system and voicemail

Your telephone has separate indicators for two different types of voice messages: those recorded on its built-in answering system and those recorded in your service provider's voicemail (fees may apply). Your telephone's built-in answering system messages and voicemail messages are separate. Each alerts you to new messages differently.

If **OO** and **XX New messages** display on the handsets and the message window on the telephone base flashes, there are new messages in the built-in answering system, press **▶/■/PLAY/STOP** on the telephone base. To listen to messages with a handset, see **To listen to messages with a handset** on page 86.

If **✉** and **New voicemail** display on the handsets, your telephone service provider is indicating that it has new voicemail for you. To listen to your voicemail, you typically dial an access number provided by your telephone service provider, followed by a security code or PIN.

Some service providers bundle or combine multiple services like voicemail and call waiting, so you may not be aware that you have voicemail. To check what services you have and how to access them, contact your telephone service provider.

To use your voicemail service rather than your answering system, turn off your answering system. To use your answering system rather than your voicemail service, contact your telephone service provider to deactivate your voicemail service.

Using the answering system and voicemail together

You can also use your telephone answering system and voicemail together by setting your built-in answering system to answer before voicemail answers as described below. To learn how to program your voicemail settings, contact your telephone service provider. Then, if you are on a call, or if the answering system is busy recording a message and you receive another call, the second caller can leave a voicemail message.

Set your answering system to answer calls at least two rings earlier than your voicemail is set to answer. For example, if your voicemail answers after six rings, set your answering system to answer after four rings. Some voicemail providers may program the delay before answering calls in seconds instead of rings. In this case, allow six seconds per ring when determining the appropriate setting.

About the answering system

Message capacity

The answering system can record and store up to 99 messages. Each message can be up to three minutes in length depending on the message length set (see **Recording time** on page 81). The total storage capacity for the announcement, messages and memos is approximately 14 minutes. The actual recording time depends on individual message characteristics. Messages remain available for replay until you delete them.

Voice prompts

The system provides voice prompts to guide you through the setup procedures at the telephone base, message playback, remote access and recording outgoing announcements.

Call screening

Call screening at the telephone base

If the answering system and call screening are on (see **Call screening** on page 78), the announcement and the incoming message broadcast at the telephone base when a call arrives.

During message recording, press ►/■/**PLAY/STOP** repeatedly to turn call screening on and off for this call. Press ▼**VOLUME**▲ on the telephone base to adjust the message volume. To change the call screening setting for all calls see page 78.



During call screening, press ►/■/**PLAY/STOP** on the telephone base to turn off the call screening. If the call screening is off and the answering system has answered a call, press ►/■/**PLAY/STOP** or **VOLUME**▲ to turn on the call screening.

Call screening at the handset:

If the answering system is on and your answering system is recording a message, press **SCREEN** to screen the call on your handset and the screen displays the caller ID information. If you do not subscribe to caller ID service, the handset shows **Incoming call**.

 **NOTE:** The call screening setting does not affect the call screening on the handset.

Call intercept

When a caller is leaving a message on your answering system, you can stop recording and talk to the caller by pressing **HOME/FLASH** or **/SPEAKER** on the handset.

About the answering system

Temporarily turning off the message alert tone

Pressing any telephone base key (except **📞/HANDSET LOCATOR**) temporarily silences the message alert tone.

The message alert tone plays with the next incoming message.

If you press **X/DELETE** when in idle mode to temporarily turn off the message alert tone, there is a voice prompt directing you to press **X/DELETE** again to delete all old messages. The message alert tone is temporarily off. Only press **X/DELETE** a second time if you wish to erase all old messages in your answering system.

The message alert tone resumes when you receive a new message.

Message playback

On the telephone base, if you have new messages, the telephone plays only the new messages (oldest first). If there are no new messages, the telephone plays back all messages (oldest first).

On the handset, if you have both new and old messages, you can play either new or old messages. The caller ID information displays on the handset screen when you play messages and you can call back the caller.

When playback begins, the handset screen displays the message status, caller ID information, and time and date of the message recorded. You hear the total number of messages followed by the day and time of the message. After the last message, the telephone announces, *"End of messages."* and the screen displays **End of messages**.

To listen to messages with the telephone base:

1. Press ►/■/**PLAY/STOP** to listen to messages.

Options during playback:

- Press ▼**VOLUME**▲ to adjust the speaker volume.
- Press ►/**SKIP** to skip to the next message.
- Press ◀/**REPEAT** to repeat the message currently playing. Press ◀/**REPEAT** twice to listen to the previous message.
- Press **X/DELETE** to delete the current message. The system advances to the next message.
- Press ►/■/**PLAY/STOP** to stop.

Message playback

To listen to messages with a handset:

1. Press **MENU** in idle mode.
2. Press **SELECT** to select **Play messages**. If you have either new or old messages, the messages play automatically. If you have both new and old messages:
 - To play new messages, press **SELECT** to select **Play new msgs**.
 - To play old messages, press **CID**▼ or **▲DIR** to highlight **Play old msgs**, then press **SELECT**.

When the handset is playing a message, its screen shows the caller's name or number. If the caller's information is unavailable, the handset shows **No caller info**.

Options during playback:

- Press **EQ**  button to adjust the message playback audio quality.
- Press **◀)/SPEAKER** to play the messages through the handset earpiece.
- Press **▼VOLUME▲** to adjust the speakerphone volume.
- Press **SKIP** to skip to the next message.
- Press **REPEAT** to repeat the message currently playing. Press **REPEAT** twice to listen to the previous message.
- Press **MUTE/DELETE** to delete the current message. The handset displays **Message deleted** briefly and the system advances to the next message.
- Press **2** to pause the playback and show the caller ID information. Press **⬆️HOME/FLASH**, **DIAL** or **◀)/SPEAKER** to use the home line, or press **📶CELLULAR** to use the cell line to call back the caller. Press **OFF/CANCEL** or **BACK** to resume the playback. If you do not call back within 10 seconds, message playback resumes.
- Press **⬆️HOME/FLASH** or **📶CELLULAR** to pause the message playback. The handset displays **Call back?** with the caller ID information. Press **YES** to call back the caller, or **NO** to resume the message playback.
- Press **OFF/CANCEL** to stop.

NOTES:

1. When the answering system has less than three minutes of recording time left, it announces, *"Less than three minutes to record."* and the handset displays **Rec mem low**.
2. When the telephone is not in use, if **F** and the number of messages are flashing alternately in the message window, or the handset displays **Rec mem full**, the memory is full. Delete some messages to make room for more.

Message playback

Delete all old messages

Using the telephone base:

Press **X/DELETE** when the phone is not in use. The telephone announces, *"To delete all old messages, press **DELETE** again."* Press **X/DELETE** again. All previously heard messages are erased and the telephone announces, *"All old messages deleted."*

Using a handset:

1. Press **MENU** on the handset in idle mode to enter the main menu.
2. Press **CID**▼ or **▲DIR** to highlight **Answering sys**, then press **SELECT**.
3. Press **CID**▼ or **▲DIR** to highlight **Delete all old**, then press **SELECT**.
4. The handset displays **Delete all old messages?** Then press **YES** to confirm.
5. The handset displays **Deleting...** and then **All old messages deleted!** You hear a confirmation tone.

i **NOTE:** You can only delete old messages, which are messages you have played.

Record and play memos

Memos are messages you record as reminders for yourself or others using the same answering system. You can record your own memos using a system handset. Play and delete them the same way as incoming messages.

To record a memo:

1. Press **MENU** on the handset in idle mode to enter the main menu.
2. Press **CID**▼ or **▲DIR** to highlight **Answering sys**, then press **SELECT**.
3. Press **CID**▼ or **▲DIR** to highlight **Record memo**, then press **SELECT**.
4. The system announces, *"Record after the tone. Press **STOP** when you are done."* After the tone, speak towards the microphone.
5. Press **STOP** when you finish recording. The handset announces, *"Recorded"* and then returns to the previous menu.

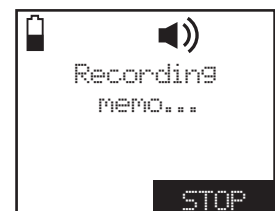
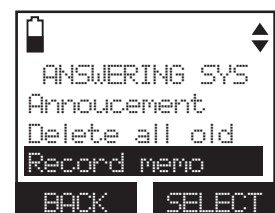

i **NOTES:**

1. The system announces *"Memory is full,"* if you attempt to record a memo when the memory is full.
2. Each memo can be up to four minutes in length.
3. Memos shorter than two second are not recorded.

Base message counter displays

Message window displays

0	No messages.
0 (flashing)	The time and date need to be set.
0-6	The telephone base ringer level while adjusting.
1-8	The telephone base speaker volume level while adjusting.
1-99	Total number of old messages and memos recorded. The message number currently playing.
0-99 (flashing)	Total number of messages and memos. The number flashes when there are new or missed messages. After a power failure, the number in the message counter flashes to indicate that you need to set the clock.
1-99 & F (alternating)	The answering system memory is full with total number of messages recorded.
---- ----	The system is answering a call, or recording a memo or announcement. The telephone is being accessed remotely. The answering system is being programmed.

















Remote access

You can access the answering system remotely by dialing your home telephone number from any touch-tone telephone.

To remotely access the answering system

1. Dial your telephone number from any touch-tone telephone.
2. When the system plays your announcement, enter the two-digit remote access code (**19** is the preset code, see page 80 to change it).
3. You can also enter the remote commands (see **Remote commands** below).
4. Hang up or press **8** to end the call and save all undeleted messages.

Remote commands











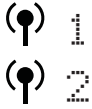

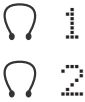
	Press to listen to all messages.
	Press to listen to new messages only.
	Press to delete the current message (during playback).
 	Press twice to delete all old messages.
	Press to repeat the current message (during playback).
 	Press twice to listen to the previous message.
	Press to stop.
 	Press to listen to a list of remote commands.
	Press to skip to the next message (during playback).
 	Press to record a new announcement.
	Press to hang up the call.
	Press to turn the answering system on or off.

NOTES:

1. If you do not press any keys after you enter the remote access code, all new messages play. If there are no new messages, all old messages play.
2. Once the new messages have played, the telephone announces the help menu options. If you do not press any key within 20 seconds, the remote access call automatically disconnects.
3. When the answering system is turned off, the telephone answers after 10 rings, and announces, *"Please enter your remote access code."*
4. When the memory is full, the answering system answers incoming calls after 10 rings and announces, *"Memory is full. Enter the remote access code."*

Appendix
Handset screen icons



	<p>HOME line - On steadily when the home line is in use or there is an incoming home call.</p>
	<p>CELL line- On steadily when the cell line is in use or there is an incoming cell call.</p>
	<p>Bluetooth connected devices - There are Bluetooth connected devices on the active devices list.</p>
	<p>Bluetooth disconnected devices - There are Bluetooth disconnected devices on the active devices list.</p>
	<p>Wireless Bluetooth headset - On steadily when a wireless Bluetooth headset is in use on the home line.</p>
	<p>Battery status - Battery is low; place handset in telephone base or charger to recharge.</p>
	<p>Battery status - Battery is charging.</p>
	<p>Speakerphone - The speakerphone is in use.</p>
	<p>Ringer off - On steadily if the home and cell ringers are turned off. Flashes if only one ringer is turned off.</p>
	<p>New voicemail - New voicemail received from your telephone service provider.</p>
	<p>Answering system on - The answering system is turned on.</p>
	<p>New answering system message - New message in the answering system.</p>
	<p>New caller ID log - Missed and new calls.</p>
	<p>Mute - Microphone is muted.</p>

Alert tones and lights

Handset alert tones

Two short beeps	You are pressing CID or DIR when the volume is already at its highest or lowest setting. -OR- You have reached the end of the caller ID history.
Three short beeps	Out of range while the handset is on a call.
Three short high-pitched beeps	The telephone has completed the command successfully.
Four short beeps	Low battery warning.

Telephone base alert tones

Beeps once every 10 seconds	Message alert.
-----------------------------	----------------

Handset indicator lights



CHARGE light

On when the handset is charging in the telephone base or charger.

Backlight (lighted display and dial pad)

On when the handset is lifted from the telephone base or charger.

On when a key is pressed.

)/SPEAKER light

On when the speakerphone is in use.

Telephone base indicator lights

IN USE light

On when the handset is in use, or when the answering system is answering an incoming call, or when you are registering a handset.

Flashes when another telephone is in use on the same line, or when you are deregistering handset(s) from the telephone base.

Flashes when there is an incoming call.

ANSWER ON light

On when the answering system is on.



DEVICE1/DEVICE2 lights

On when the telephone base is paired and connected with a Bluetooth device.

Flash alternately while pairing a Bluetooth device.

Flashes quickly when there is an incoming cell call.

Screen messages

Display screen messages

Already saved	The telephone number you have entered is already stored in the directory.
Bluetooth system busy	You are trying to make a cell call or access the Bluetooth menu when the Bluetooth link is already being used.
Caller ID log empty	There are no entries in the caller ID history.
Call transferred	An outside call from one handset is transferred to another handset.
Calling HANDSET X (For models with more than two handsets)	The handset is calling another handset (for intercom calls).
Calling other handset (For models with two handsets only)	The handset is calling the other handset (for intercom calls). The handset is going to transfer an outside call to the other handset.
Cell	The cell line is on a call.
Cell call on hold	A call on the cell line has been put on hold.
Cell line in use	Another system handset is using the cell line.
Connecting...	The handset has lost communication with the telephone base.
Connection failed	A Bluetooth device in the paired or active devices list fails to establish connection with your telephone system.
Directory empty	There are no directory entries.
Directory full	The directory is full. You cannot save any new entries unless you delete some current entries.
Downloading dir	The system is downloading a directory from a cell phone.
Ended	You have just ended a call.
HANDSET X is calling (For models with more than two handsets)	Another system handset is calling.
Home	The home line is on a call.
Home call on hold	A call on the home line has been put on hold.
Home & cell calls on hold	Calls on the home and cell lines have been put on hold.
Home & cell lines in use	Calls on the home and cell lines are being used.

Screen messages

None line in use	A system handset or another telephone on the same home line is in use.
Incoming call	There is a call coming in.
Intercom	The handset is on an intercom call.
Intercom ended	The intercom call has just ended.
Low battery	The battery needs to be charged.
Microphone off	The handset microphone is off. The other party cannot hear you but you can hear the other party.
Microphone on	The handset microphone is on.
New voicemail	There are new voicemail messages from your telephone service provider.
No answer. Try again.	You tried to make an intercom call, but the handset you are calling is busy or out of range.
No battery	The battery is not properly installed and the handset is in the telephone base or charger.
No entries found. Download from SIM only?	There are no entries found when you download a cell phone directory from the cell memory.
No entries found. Download from Phone only?	There are no entries found when you download a cell phone directory from your SIM card. There are no entries found in either the cell or SIM card when you download a cell phone directory from both memories.
No connected cellular phones	There is no cellular phone connected to the base.
No home line	There is no telephone line connected.
No Incoming PTT	The incoming PTT function is disabled. The handset will not receive PTT calls.
No message	There is no message recorded on the answering system.
No signal, call ended	The phone lost the connection with the telephone base or does not have a strong enough signal and the phone call ended.
Not available at this time	Someone else is already using the directory or caller ID history.
Other handset is calling (For models with two handsets only)	The other handset is calling.

Screen messages

Out of range OR No power at base	The handset has lost communication with the telephone base. There is no power connected to the telephone base.
** Paging **	The telephone base is paging all handsets.
Place in charger	The battery is very low. The handset should be placed in the telephone base or charger.
PTT From HANDSET X To HANDSET Y	One handset has started a PTT session to another handset.
PTT To HANDSET X	You have started the PTT process.
Push to talk Ended	The PTT session is ended.
Put handset on BASE to register	Your handset is not registered to the telephone base.
Rec mem full	The answering system has no recording time left.
Ringer muted	The ringer is muted temporarily during an incoming call.
Rec mem low	The answering system has less than three minutes to record.
Saved	The entry is now in the directory.
Unable to save	You are trying to save an entry with no name and number from the caller ID history.
XX Missed call(s)	There are new calls in the caller ID history.
XX New message(s)	There are new messages recorded in the answering system.

Expand your telephone system

The handsets provided with your telephone system are already registered. Additional handsets registered to the telephone system are assigned in sequential order. For instance, if you already have **HANDSET 1** and **HANDSET 2**, the new registered handset is assigned **HANDSET 3**. This telephone system accommodates up to 12 handsets.

Add and register a handset (optional)

You can add new handsets (**TL90071**, purchased separately) to your telephone system, but each handset must be registered with the telephone base before use. When first purchased, each expansion handset shows **Put handset on BASE to register** after a battery is installed. Each handset should be charged without interruption for at least 30 minutes before registering to the telephone base. For more details on battery charging, see the table on page 10.

To register a handset:

1. Make sure the handset shows **Put handset on BASE to register**. Place the handset you wish to register in the telephone base.
2. The handset displays **Registering handset...** on the handset and the red **IN USE** light on the telephone base turns on. It takes about 90 seconds to complete the registration process. The handset displays **HANDSET X Registered** (**X** represents the registered handset number). The **IN USE** light turns off and the handset beeps when registration completes.

If registration fails, it will automatically restart. If it fails after three trials, the handset displays **Registration failed** for a few seconds, then **Put handset on BASE to register**. To reset the handset, remove it from the telephone base. When the handset displays **Put handset on BASE to register**, try the registration process again.

i **NOTE:** You cannot register a handset if any other system handset is in use.







Deregister handsets

If you want to replace a handset or reassign the designated handset number of a registered handset, you must deregister all the handsets and then individually register each handset.

To make deregistration easier, read all of the instructions on this page before you begin.

To deregister all handsets:

1. Press and hold /**HANDSET LOCATOR** on the telephone base for about 10 seconds until the **IN USE** light flashes, then release /**HANDSET LOCATOR**.
2. Quickly press /**HANDSET LOCATOR** again. You must press /**HANDSET LOCATOR** while the **IN USE** light is still flashing. The **IN USE** light flashes for about seven seconds. If the light stops flashing, start again with Step 1 above.
3. All system handsets show **Put handset on BASE to register** and you hear a confirmation tone when the deregistration completes. The deregistration process takes about 10 seconds to complete.



If deregistration fails, you may need to reset the telephone and try again.

To reset:

- Press and hold  **OFF/CANCEL** or place the handset back in the telephone base.
- OR-
- Unplug the power from the telephone base, then plug it back in.

After deregistering, register each handset individually. See **Add and register a handset** on page 95.

NOTES:

1. You cannot deregister the handsets if any other system handset is in use.
2. Even if the battery is depleted, you can still deregister the handsets by following the steps above.

Troubleshooting

If you have difficulty with your telephone, please try the suggestions below. For Customer Service, or to purchase accessories or replacement parts, visit our website at **www.telephones.att.com**, or call **1 (800) 222-3111**. In Canada, dial **1 (866) 288-4268**. Have the serial number, found on the underside of your telephone, available when contacting customer service.

I cannot add my cell phone to the telephone base.

- Make sure you have cellular coverage.
- Make sure the Bluetooth function of your cell phone is turned on. See the user's manual of your cell phone for more information.
- Make sure that you set your cell phone to search for devices.
- If the **TL92271/TL92371/TL92471** is in your cell phone device history list, delete it and try pairing again.
- Carefully follow the pairing instructions on page 15 and make sure that your cell phone is not connected to any other Bluetooth device.
- Turn off your cell phone, then turn it on again.
- Reset the telephone base. Unplug the unit's electrical power. Wait for approximately 15 seconds, then plug it back in. Repeat the above suggestions.

I cannot add my headset to the telephone base.

- Make sure that your Bluetooth headset is in discoverable mode when pairing with the telephone base. See the user's manual of your headset for more information on how to set your headset to discoverable mode.
- Carefully follow the pairing instructions on page 17 and make sure that your headset is not connected to any other Bluetooth device.
- Reset the telephone base. Unplug the unit's electrical power. Wait for approximately 15 seconds, then plug it back in. Repeat the above suggestions.

I cannot connect my cell phone with the telephone base.

- Make sure that the Bluetooth function of your cell phone is turned on. See the user's manual of your cell phone for more information.
- Make sure that your Bluetooth cell phone is not connected to any other Bluetooth device.
- Turn off your cell phone, then turn it on again.
- Make sure that your cell phone is on the paired devices list.
- For some cell phones, you must authorize **TL92271/TL92371/TL92471** device in your cell phone's Bluetooth feature. See the user's manual of your cell phone for more information.
- Manually connect your cell phone to the **TL92271/TL92371/TL92471**. Refer to the user's manual of your cell phone for more information.

Troubleshooting

I cannot connect my headset with the telephone base.

- Make sure that your Bluetooth headset is not connected to any other Bluetooth device.
- Make sure that your headset is on the paired devices list.

I cannot put my headset in discoverable mode.

- Refer to the user's manual of your headset for information on how to set your headset to discoverable mode.
- Make sure that the headset is not connected to any other Bluetooth device in order to successfully pair and connect to the telephone base.
- Carefully follow the pairing process on page 17
- Reset the telephone base. Unplug the unit's electrical power. Wait for approximately 15 seconds, then plug it back in. Repeat the above suggestions.

I don't know how to search for or add new devices on my cell phone.

- Most cell phones have the Bluetooth feature in the connection or setup menus. Please refer to the user's manual of your cell phone.
- In general, press the menu key on your cell phone, then look for the Bluetooth menu in the settings or connection menu. In the Bluetooth menu, select the option to search for or add new devices.

My cell phone disconnects with the telephone base.

- Turn off your cell phone, then turn it on again.
- Make sure that you are not using your cell phone when on a cell call.

My cell phone is connected to the telephone base, but I cannot make a cell call.

- Make sure that your cell phone is not in use when you are trying to make a cell call.
- For some smartphones, make sure that the cellular function is turned on.

Bluetooth system busy appears on the display.

- Make sure that your cell phone is not in use when connected and on the active devices list.
- Make sure that your cell phone or headset is not connected to any other Bluetooth device.
- **TL92271/TL92371/TL92471** can only use one Bluetooth device at a time.

Troubleshooting

The PIN on the telephone base does not work.

- The default PIN is **0000**.
- If you have changed the PIN, it will appear on the handset in the pairing process.

I cannot hear any audio on my telephone system when on a cell call.

- Reset the telephone base. Unplug the unit's electrical power. Wait for approximately 15 seconds, then plug it back in.
- Turn off your cell phone, then turn it on again.

I cannot download contacts from my cell phone to my TL92271/TL92371/TL92471.

- Make sure that your cell phone is paired and connected to the base.
- Make sure you place your cell phone next to the base while downloading.

I see duplicate entries in my downloaded directory

- If you see duplicate directory entries, you can delete them manually. Another option is to download again from either your SIM card or phone memory, but not both.

Some of my cell phone contacts were not imported to my TL92271/TL92371/TL92471.

- Make sure to try copying the contacts from your SIM card to your cell phone memory first, then download from your phone memory. If that doesn't work, try copying the contacts from your cell phone memory to your SIM card, then download from your SIM card. For more information on how to transfer contacts between your SIM card and your phone memory, refer to the user's manual of your cell phone.

Can the TL92271/TL92371/TL92471 help the poor cell phone reception in my house?

- If your cell phone has poor reception in your home, the **TL92271/TL92371/TL92471** cannot improve the reception. However, if you have a location in your house with better reception, you can leave your cell phone in that location while you use **TL92271/TL92371/TL92471** cell line. In order for this to work, the cell phone must be within 30 feet of the telephone base for optimal performance.

Troubleshooting

The listening volume of my cell call is too loud or quiet.

- During a cell call, if the listening volume is too loud or quiet, try changing the volume on your cell phone. On some cell phones, changing the volume on the cell phone affects your cell call volume on the **TL92271/TL92371/TL92471** handset.

My phone doesn't work at all.

- Make sure the power cord is securely plugged in.
- Make sure that the battery connector is securely plugged into the cordless handset.
- Make sure the telephone line cord is securely and firmly plugged into the telephone base and the telephone wall jack.
- Charge the battery in the cordless handset for at least 16 hours. For optimum daily performance, return the cordless handset to the telephone base or charger when not in use.
- If the battery is depleted, it may take approximately ten minutes to charge the handset before it shows **Low battery**, refer to page 10 for details.
- Reset the telephone base. Unplug the electrical power. Wait for approximately 15 seconds, then plug it back in. Allow up to one minute for the cordless handset and telephone base to reset.
- You may need to purchase a new battery. Please refer to **Battery installation and charging** (pages 9-10) in this user's manual.

I cannot get a dial tone.

- Try all the suggestions above.
- Move the cordless handset closer to the telephone base. You might have moved out of range.
- Disconnect the telephone base from the telephone jack and connect to a different phone. If there is no dial tone on that phone either, the problem is in your wiring or telephone service. Contact your telephone service provider (charges may apply).
- Your line cord may be defective. Install a new telephone line cord.

Troubleshooting

I cannot dial out.

- Try all the suggestions in **I cannot get a dial tone** on the previous page.
- Make sure you have a dial tone before dialing. The cordless handset may take a second or two to find the telephone base and produce a dial tone. This is normal. Wait an extra second before dialing.
- Eliminate any background noise. Noise from a television, radio or other appliances may cause the phone to not dial out properly. If you cannot eliminate the background noise, first try muting the cordless handset before dialing, or dialing from another room in your home with less background noise.
- Disconnect the telephone base from the telephone wall jack and plug in a working telephone. If the other phones in your home are having the same problem, the problem is in your wiring or telephone service. Contact your telephone service provider (charges may apply).

My cordless handset isn't performing normally.

- Make sure the power cord is securely plugged into the telephone base. Plug the power adapter into a different, working electrical outlet not controlled by a wall switch.
- Move the cordless handset closer to the telephone base. You might have moved out of range.
- Reset the telephone base. Unplug the electrical power. Wait for 15 seconds then plug it back in. Allow up to one minute for the cordless handset and telephone base to reset.
- Other electronic products can cause interference to your cordless phone. Try installing your phone as far away from these types of electronic devices as possible: television sets, VCRs, or other cordless telephones.

The handset registration is unsuccessful.

Follow the steps below to re-register the handset.

1. Make sure the handset is out of the telephone base or charger and shows **Put handset on BASE to register** before you begin registration.
2. Press and hold **📞/HANDSET LOCATOR** on the telephone base for about four seconds until the red **IN USE** light turns on.
3. Press **#** (pound key) on the handset. Its screen shows **Registering handset...** and it takes up to 60 seconds to complete the registration. The handset shows **HANDSET X Registered** (**X** represents the handset number assigned) and you hear a beep when the registration is completed.

Refer to the **Add and register a handset** section on page 95 for details.

Troubleshooting

Out of range OR No power at base appears on my cordless handset.

- Ensure that the telephone base is powered up.
- Place the cordless handset in the telephone base for one minute to allow the cordless handset and base to synchronize.
- Move the cordless handset closer to the telephone base. You might have moved out of range.
- Reset the telephone base. Unplug the electrical power. Wait for 15 seconds then plug it back in. Allow up to one minute for the cordless handset and telephone base to reset.
- Other electronic products can cause interference with your cordless phone. Try installing your phone as far away from these types of electronic devices as possible: television sets, VCRs, or other cordless telephones.

The batteries do not hold a charge.

- If the cordless handset is in the telephone base or charger and the charge light does not come on, refer to **The charge light is off** (page 105) in this **Troubleshooting** guide.
- Charge the battery in the cordless handset for at least 16 hours. For optimum daily performance, return the cordless handset to the telephone base or charger when not in use.
- If the battery is depleted, it may take approximately ten minutes to charge the handset before it shows **Low battery**, refer to page 10 for details.
- You may need to purchase a new battery. Please refer to **Battery installation and charging** (pages 9-10) in this user's manual.

I get noise, static, or a weak signal even when I'm near the telephone base.

- If you subscribe to high-speed Internet service (digital subscriber line - DSL) through your telephone lines, you must install a DSL filter between the telephone line cord and the telephone wall jack (see page 7). The filter prevents noise and caller ID problems caused by DSL interference. Please contact your DSL service provider for more information about DSL filters.
- You may be able to improve the performance of your cordless phone by installing your new telephone base as far as possible from any other existing cordless telephone system that may already be installed.
- Other electronic products can cause interference to your cordless phone. Try installing your phone as far away from the following electronic devices as possible: television sets, VCRs, or other cordless telephones.
- Do not install this phone near a microwave oven or on the same electrical outlet. You may experience decreased performance while the microwave oven is operating.

Troubleshooting

- If your phone is plugged in with a modem or a surge protector, plug the phone (or modem/surge protector) into a different location. If this doesn't solve the problem, relocate your phone or modem farther apart from one another, or use a different surge protector.
- Relocate your phone to a higher location. The phone may have better reception when installed in a high area.
- Disconnect the telephone base from the telephone wall jack and plug in a working telephone. If the other phones in your home are having the same problem, the problem is in your wiring or telephone service. Contact your telephone service provider (charges may apply).

I experience poor sound quality when using the speakerphone.

- For increased sound quality while using the speakerphone, place the handset on a flat surface with the dial pad facing up.
- When using a speakerphone, controlling background noise in your environment is essential. While you are listening to your party, press **DELETE/MUTE** to temporarily turn your microphone off. When it is your turn to speak, remember to press **DELETE/MUTE** again to turn the microphone on.
- Excessive background noise will cause a speakerphone to fade in and out. Try controlling the background noise by turning off any audio devices near the speakerphone. Also, try to avoid interrupting the person at the other end of the conversation while they are speaking. If background noise cannot be controlled, you should terminate speakerphone operation and return to normal handset mode.

I hear other calls while using my phone.

- Disconnect the telephone base from the telephone wall jack and plug in a working telephone. If the other phones in your home are having the same problem, the problem is in your wiring or telephone service. Call your telephone service provider (charges may apply).

While on a call or playing messages, there is too much noise, or the voice sounds tinny, shrill or flat.

- While on a call or playing messages, press the **EQ**  button on the side of the handset until you find the setting that sounds best (page 46).

Troubleshooting

My cordless handset does not ring when I receive a call.

- Make sure that the ringer is not turned off. Refer to **Ringer volume** on page 27 in this user's manual.
- Make sure the telephone line cord is plugged securely into the telephone base and the telephone jack. Make sure the power cord is securely plugged in.
- The cordless handset may be too far from the telephone base.
- Charge the battery in the cordless handset for at least 16 hours. For optimum daily performance, return the cordless handset to the telephone base or charger when not in use.
- You may have too many extension phones on your telephone line to allow all of them to ring simultaneously. Try unplugging some of the other phones.
- The layout of your home or office might be limiting the operating range. Try moving the telephone base to another location, preferably to a higher location.
- Disconnect the telephone base from the telephone wall jack and plug in a working telephone. If the other phones in your home are having the same problem, the problem is in your wiring or telephone service. Contact your telephone service provider (charges may apply).
- Test a working phone at the phone jack. If another phone has the same problem, the problem is the phone jack. Contact your telephone service provider (charges may apply).
- Other electronic products can cause interference with your cordless phone. Try installing your phone as far away as possible from electronic devices such as wireless routers, or other cordless telephones.
- Completely remove the battery. Replace the battery and place the cordless handset in the telephone base. Wait for the cordless handset to reestablish its connection with the telephone base. Allow up to one minute for this to take place.
- Your line cord might be malfunctioning. Try installing a new line cord.

Troubleshooting

My calls cut in and out while I'm using my cordless handset.

- Other electronic products can cause interference with your cordless phone. Try installing your phone as far away as possible from electronic devices such as wireless routers, or other cordless telephones.
- Do not install this phone near a microwave oven or on the same electrical outlet. You may experience decreased performance while the microwave oven is operating.
- If you plug your phone in with a modem or surge protector, plug the phone (or modem/surge protector) into a different location. If this doesn't solve the problem, relocate your phone or modem farther apart from one another, or use a different surge protector.
- Relocate your telephone base to a higher location. The phone may have better reception when installed in a high area.
- Disconnect the telephone base from the telephone wall jack and plug in a working telephone. If the other phones in your home are having the same problem, the problem is in your wiring or telephone service. Contact your telephone service provider (charges may apply).
- Excessive background noise will cause a speakerphone to fade in and out. Try controlling the background noise by turning off any audio devices near the speakerphone. Also, try to avoid interrupting the person at the other end of the conversation while they are speaking. If background noise cannot be controlled, you should stop speakerphone operation and return to normal handset mode.
- When using a speakerphone, controlling background noise in your environment is essential. While you are listening to your party press **DELETE/MUTE** to temporarily turn your microphone off. When it is your turn to speak, remember to press **DELETE/MUTE** to turn the microphone on.

The charge light is off.

- Make sure the power and line cords are plugged in correctly and securely.
- Unplug the electrical power. Wait for 15 seconds, then plug it back in. Allow up to one minute for the cordless handset and telephone base to reset.
- Clean the cordless handset and telephone base charging contacts each month using a pencil eraser or cloth.

Troubleshooting

My caller ID isn't working.

- Caller ID is a subscription service. You must subscribe to this service from your telephone service provider for this feature to work on your phone.
- The caller must be calling from an area that supports caller ID.
- Both your and your caller's telephone service providers must use caller ID compatible equipment.
- If you subscribe to high-speed Internet service (digital subscriber line - DSL) through your telephone lines, you must install a DSL filter between the telephone line cord and the telephone wall jack (see page 7). The filter prevents noise and caller ID problems caused by DSL interference. Please contact your DSL service provider for more information about DSL filters.

System does not receive caller ID when on a call.

- Make sure you subscribe to caller ID with call waiting features provided by your telephone service provider. Caller ID features work only if both you and the caller are in areas offering caller ID service, and if both telephone companies use compatible equipment.

An icon and New voicemail show on the display and I don't know why.

- Your telephone has voicemail indication that is separate from the built-in answering system. If  appears on the display, then your telephone has received a signal from your telephone service provider that you have a voicemail message waiting for you to retrieve from your telephone service provider. Contact your telephone service provider for more information on how to access your voicemail.

I cannot retrieve voicemail messages.

- Your telephone has both a built-in answering system and voicemail indication. They are independent features and each alerts you to new messages differently (page 82). If you subscribe to voicemail service from your telephone service provider (charges may apply), contact your telephone service provider for more information on how to access your voicemail.

I am receiving incomplete messages.

- If a caller leaves a very long message, part of it may be lost when the system disconnects the call after four minutes.
- If the caller pauses for longer than seven seconds, the system stops recording and disconnects the call.
- If the system's memory becomes full during a message, the system stops recording and disconnects the call.
- If the caller's voice is very soft, the system may stop recording and disconnect the call.

Troubleshooting

I am having difficulty hearing messages.

- Press **VOLUME▲** to increase speaker volume on the telephone base.
- Press **VOLUME▲** to increase the listening volume on a handset.

System does not answer after correct number of rings.

- Make sure the answering system is on. When the answering system is on, **ANS ON** should show on the handset and the **ANS ON** light is lit on the telephone base (page 75).
- If toll saver is selected, the number of rings changes to two when there are new messages waiting (page 79).
- If the memory is full or the system is off, the system answers after 10 rings.
- In some cases, the answering system is affected by the ringing system used by the telephone service provider.
- If you subscribe to voicemail service, change the number of rings so that your answering system answers before your voicemail answers (page 82). To determine how many rings activate your voicemail, please contact your telephone service provider.
- If there is a fax machine connected to the same telephone line, try disconnecting the fax machine. If that solves the problem, consult your fax machine documentation for information on compatibility with answering systems.

The answering system announces “Time and day not set.”

- You need to set the date and time (page 29).

System does not respond to remote commands.

- Make sure to enter your remote access code correctly (page 89).
- Make sure you are calling from a touch-tone phone. When you dial a number, you should hear tones. If you hear clicks, the phone is not a touch-tone telephone and cannot activate the answering system.
- The answering system may not detect the remote access code while your announcement is playing. Try waiting until the announcement is over before entering the code.
- There may be interference on the phone line you are using. Press the dial pad keys firmly.

Troubleshooting

The answering system does not record messages.

- Make sure the answering system is on (page 75).
- Make sure the memory of the answering system is not full. When the answering machine memory is full, it does not record new messages until some old messages are deleted.
- If you subscribe to voicemail service, change the number of rings so that your answering system answers before your voicemail answers (page 82). To determine how many rings activate your voicemail, please contact your telephone service provider.
- If there is a fax machine connected to the same telephone line, try disconnecting the fax machine. If that solves the problem, consult your fax machine documentation for information on compatibility with answering systems.

The outgoing announcement is not clear.

- When you record your announcement, make sure you speak in a normal tone of voice towards the microphone of the handset.
- Make sure there is no background noise (TV, music, etc.) while recording.

I subscribe to a nontraditional telephone service that uses my computer to establish connections, and my telephone doesn't work.

- Make sure your computer is powered on.
- Make sure your Internet connection is working properly.
- Make sure that the software is installed and running for your nontraditional telephone service.
- Make sure to plug your USB telephone adapter into a dedicated USB port on your computer. Do not plug into a multiple port USB hub (USB splitter) that is not powered.
- In a few rare instances, the USB port on your computer may not have enough power. In these instances, try using a USB hub with its own external power supply.
- If you are using a firewall, it may prevent access to your nontraditional telephone service provider. Contact your service provider for more information.

Troubleshooting

Common cure for electronic equipment:

If the telephone is not responding normally, try resetting the telephone. Do the following in the order listed:

1. Disconnect the power to the telephone base.
2. Disconnect the cordless handset battery, and spare battery, if applicable.
3. Wait a few minutes.
4. Connect power to the telephone base.
5. Completely remove the battery. Replace the battery and place the cordless handset into the telephone base.
6. Wait for the cordless handset to reestablish its connection with the telephone base. Allow up to one minute for this to take place.

Maintenance

Taking care of your telephone

- Your cordless telephone contains sophisticated electronic parts, so it must be treated with care.
- Avoid rough treatment.
- Place the handset down gently.
- Save the original packing materials to protect your telephone if you ever need to ship it.

Avoid water

- Your telephone can be damaged if it gets wet. Do not use the handset in the rain, or handle it with wet hands. Do not install the telephone base near a sink, bathtub or shower.

Electrical storms

- Electrical storms can sometimes cause power surges harmful to electronic equipment. For your own safety, take caution when using electric appliances during storms.

Cleaning your telephone

- Your telephone has a durable plastic casing that should retain its luster for many years. Clean it only with a soft cloth slightly dampened with water or a mild soap.
- Do not use excess water or cleaning solvents of any kind.

Remember that electrical appliances can cause serious injury if used when you are wet or standing in water. If the telephone base should fall into water, DO NOT RETRIEVE IT UNTIL YOU UNPLUG THE POWER CORD AND TELEPHONE LINE CORDS FROM THE WALL. Then pull the telephone out by the unplugged cords.

Important safety information



This symbol is to alert you to important operating or servicing instructions that may appear in this user's manual. Always follow basic safety precautions when using this product to reduce the risk of injury, fire, or electric shock.

Safety information

- Read and understand all instructions in the user's manual. Observe all markings on the product.
- Avoid using a telephone during a thunderstorm. There might be a slight chance of electric shock from lightning.
- Do not use a telephone in the vicinity of a gas leak. If you suspect a gas leak, report it immediately, but use a telephone away from the area where gas is leaking. If this product is a cordless model, make sure the base is also away from the area.
- Do not use this product near water, or when you are wet. For example, do not use it in a wet basement or shower, or next to a swimming pool, bathtub, kitchen sink, or laundry tub. Do not use liquids or aerosol sprays for cleaning. If the product comes in contact with any liquids, unplug any line or power cord immediately. Do not plug the product back in until it has dried thoroughly.
- Install this product in a protected location where no one can trip over any line or power cords. Protect cords from damage or abrasion.
- If this product does not operate normally, read the **Troubleshooting** section on pages 97-109 of this user's manual. If you cannot solve the problem, or if the product is damaged, refer to the **Limited warranty** section on pages 115-116. Do not open this product except as may be directed in your user's manual. Opening the product or reassembling it incorrectly may expose you to hazardous voltages or other risks.
- Replace batteries only as described in your user's manual (pages 9-10). Do not burn or puncture batteries — they contain caustic chemicals.
- This power adapter is intended to be correctly oriented in a vertical or floor mount position. The prongs are not designed to hold the plug in place if it is plugged into a ceiling or an under-the-table/cabinet outlet.



CAUTION: Use only the power adapter provided with this product. To obtain a replacement, visit our website at www.telephones.att.com, or call **1 (800) 222-3111**. In Canada, dial **1 (866) 288-4268**.

Especially about corded telephones

- **Privacy:** The same features that make a cordless telephone convenient create some limitations. Telephone calls are transmitted between the telephone base and the handset by radio waves, so there is a possibility that your cordless telephone conversations could be intercepted by radio receiving equipment within range of the cordless handset. For this reason, you should not think of cordless telephone conversations as being as private as those on corded telephones.
- **Electrical power:** The telephone base of this cordless telephone must be connected to a working electrical outlet which is not controlled by a wall switch. Calls cannot be made from the handset if the telephone base is unplugged, switched off or if the electrical power is interrupted.
- **Potential TV interference:** Some cordless telephones operate at frequencies that may cause interference to TVs and VCRs. To minimize or prevent such interference, do not place the telephone base of the cordless telephone near or on top of a TV or VCR. If interference is experienced, moving the cordless telephone farther away from the TV or VCR will often reduce or eliminate the interference.

Important safety information

- Rechargeable batteries: This product contains nickel-metal hydride rechargeable batteries. Exercise care in handling batteries in order not to create a short circuit with conductive material such as rings, bracelets, and keys. The battery or conductor may overheat and cause harm. Observe proper polarity between the battery and the battery charger.
- Nickel-metal hydride rechargeable batteries: Dispose of these batteries in a safe manner. Do not burn or puncture. Like other batteries of this type, if burned or punctured, they could release caustic material which could cause injury.



The RBRC™ Seal means that the manufacturer is voluntarily participating in an industry program to collect and recycle nickel-metal hydride rechargeable batteries when taken out of service within the United States. These batteries may be taken to a participating local retailer of replacement batteries or recycling center. Or you may call 1 (800) 8-BATTERY for locations accepting spent Ni-MH batteries.

Precautions for users of implanted cardiac pacemakers

Cardiac pacemakers (applies only to digital cordless telephones): Wireless Technology Research, LLC (WTR), an independent research entity, led a multidisciplinary evaluation of the interference between portable wireless telephones and implanted cardiac pacemakers. Supported by the U.S. Food and Drug Administration, WTR recommends to physicians that:

Pacemaker patients

- Should keep wireless telephones at least six inches from the pacemaker.
- Should NOT place wireless telephones directly over the pacemaker, such as in a breast pocket, when it is turned ON.
- Should use the wireless telephone at the ear opposite the pacemaker.

WTR's evaluation did not identify any risk to bystanders with pacemakers from other persons using wireless telephones.

Especially about telephone answering systems

Two-way recording: This unit does not sound warning beeps to inform the other party that the call is being recorded. To ensure that you are in compliance with any federal or state regulations regarding recording a telephone call, you should start the recording process and then inform the other party that you are recording the conversation.

SAVE THESE INSTRUCTIONS

FCC Part 68 and ACTA

This equipment complies with Part 68 of the FCC rules and with technical requirements adopted by the Administrative Council for Terminal Attachments (ACTA). The label on the back or bottom of this equipment contains, among other things, a product identifier in the format US: AAAEQ##TXXXX. This identifier must be provided to your telephone service provider upon request.

The plug and jack used to connect this equipment to premises wiring and the telephone network must comply with the applicable Part 68 rules and technical requirements adopted by ACTA. A compliant telephone cord and modular plug is provided with this product. It is designed to be connected to a compatible modular jack that is also compliant. An RJ11 jack should normally be used for connecting to a single line and an RJ14 jack for two lines. See Installation Instructions in the user's manual.

The Ringer Equivalence Number (REN) is used to determine how many devices you may connect to your telephone line and still have them ring when you are called. The REN for this product is encoded as the 6th and 7th characters following the US: in the product identifier (e.g., if ## is 03, the REN is 0.3). In most, but not all areas, the sum of all RENs should be five (5.0) or less. For more information, please contact your telephone service provider.

This equipment may not be used with Party Lines. If you have specially wired alarm dialing equipment connected to your telephone line, ensure the connection of this equipment does not disable your alarm equipment. If you have questions about what will disable the alarm equipment, consult your telephone service provider or a qualified installer.

If this equipment is malfunctioning, it must be unplugged from the modular jack until the problem has been corrected. Repairs to this telephone equipment can only be made by the manufacturer or its authorized agents. For repair procedures, follow the instructions outlined under the Limited Warranty.

If this equipment is causing harm to the telephone network, the telephone service provider may temporarily discontinue your telephone service. The telephone service provider is required to notify you before interrupting service. If advance notice is not practical, you will be notified as soon as possible. You will be given the opportunity to correct the problem and the telephone service provider is required to inform you of your right to file a complaint with the FCC. Your telephone service provider may make changes in its facilities, equipment, operation, or procedures that could affect the proper functioning of this product. The telephone service provider is required to notify you if such changes are planned.

If this product is equipped with a corded or cordless handset, it is hearing aid compatible.

If this product has memory dialing locations, you may choose to store emergency telephone numbers (e.g., police, fire, medical) in these locations. If you do store or test emergency numbers, please:

- Remain on the line and briefly explain the reason for the call before hanging up.
- Perform such activities in off-peak hours, such as early morning or late evening.

Industry Canada

Operation is subject to the following two conditions: (1) this device may not cause harmful interference, and (2) this device must accept any interference, including interference that may cause undesired operation.

The term "IC:" before the certification/registration number only signifies that the Industry Canada technical specifications were met.

The Ringer Equivalence Number (REN) for this terminal equipment is 0.1. The REN is an indication of the maximum number of devices allowed to be connected to a telephone interface. The termination on an interface may consist of any combination of devices subject only to the requirement that the sum of the RENs of all the devices does not exceed five.

This product meets the applicable Industry Canada technical specifications.

Appendix FCC Part 15

This equipment has been tested and found to comply with the requirements for a Class B digital device under Part 15 of the Federal Communications Commission (FCC) rules.

These requirements are intended to provide reasonable protection against harmful interference in a residential installation. This equipment generates, uses and can radiate radio frequency energy and, if not installed and used in accordance with the instructions, may cause harmful interference to radio communications. However, there is no guarantee that interference will not occur in a particular installation.

If this equipment does cause harmful interference to radio or television reception, which can be determined by turning the equipment off and on, the user is encouraged to try to correct the interference by one or more of the following measures:

- Reorient or relocate the receiving antenna.
- Increase the separation between the equipment and receiver.
- Connect the equipment into an outlet on a circuit different from that to which the receiver is connected.
- Consult the dealer or an experienced radio/TV technician for help.

Changes or modifications to this equipment not expressly approved by the party responsible for compliance could void the user's authority to operate the equipment.

This device complies with Part 15 of the FCC rules. Operation is subject to the following two conditions: (1) this device may not cause harmful interference, and (2) this device must accept any interference received, including interference that may cause undesired operation. Privacy of communications may not be ensured when using this telephone.

To ensure safety of users, the FCC has established criteria for the amount of radio frequency energy that can be safely absorbed by a user or bystander according to the intended usage of the product. This product has been tested and found to comply with the FCC criteria. The handset may be safely held against the ear of the user. The telephone base shall be installed and used such that parts of the user's body other than the hands are maintained at a distance of approximately 20cm (8 inches) or more.

This Class B digital apparatus complies with Canadian ICES-003.

Limited warranty

The AT&T brand is used under license - any repair, replacement or warranty service, and all questions about this product should be directed to: In the United States of America, call

1 (800) 222-3111 or visit **www.telephones.att.com**; in Canada, call **1 (866) 288-4268**.

1. What does this limited warranty cover?

The manufacturer of this AT&T-branded product warrants to the holder of a valid proof of purchase ("CONSUMER" or "you") that the product and all accessories provided in the sales package ("PRODUCT") are free from defects in material and workmanship, pursuant to the following terms and conditions, when installed and used normally and in accordance with the PRODUCT operating instructions. This limited warranty extends only to the CONSUMER for products purchased and used in the United States of America and Canada.

2. What will be done if the PRODUCT is not free from defects in materials and workmanship during the limited warranty period ("materially defective PRODUCT")?

During the limited warranty period, the manufacturer's authorized service representative repairs or replaces at the manufacturer's option, without charge, a materially defective PRODUCT. If the manufacturer repairs the PRODUCT, they may use new or refurbished replacement parts. If the manufacturer chooses to replace the PRODUCT, they may replace it with a new or refurbished PRODUCT of the same or similar design. The manufacturer retains the defective parts, modules, or equipment. Repair or replacement of the PRODUCT, at the manufacturer's option, is your exclusive remedy. The manufacturer returns the repaired or replacement products to you in working condition. You should expect the repair or replacement to take approximately 30 days.

3. How long is the limited warranty period?

The limited warranty period for the PRODUCT extends for ONE (1) YEAR from the date of purchase. If the manufacturer repairs or replaces a materially defective PRODUCT under the terms of this limited warranty, this limited warranty also applies to repaired or replacement PRODUCT for a period of either (a) 90 days from the date the repaired or replacement PRODUCT is shipped to you or (b) the time remaining on the original one-year limited warranty; whichever is longer.

4. What is not covered by this limited warranty?

This limited warranty does not cover:

- PRODUCT that has been subjected to misuse, accident, shipping or other physical damage, improper installation, abnormal operation or handling, neglect, inundation, fire, water, or other liquid intrusion; or
- PRODUCT that has been damaged due to repair, alteration, or modification by anyone other than an authorized service representative of the manufacturer; or
- PRODUCT to the extent that the problem experienced is caused by signal conditions, network reliability or cable or antenna systems; or
- PRODUCT to the extent that the problem is caused by use with non-AT&T accessories; or
- PRODUCT whose warranty/quality stickers, PRODUCT serial number plates or electronic serial numbers have been removed, altered or rendered illegible; or
- PRODUCT purchased, used, serviced, or shipped for repair from outside the United States of America or Canada, or used for commercial or institutional purposes (including but not limited to products used for rental purposes); or
- PRODUCT returned without a valid proof of purchase (see item 6 below); or
- Charges for installation or setup, adjustment of customer controls, and installation or repair of systems outside the unit.

Limited warranty

5. How do you get warranty service?

To obtain warranty service in the United States of America, visit

www.telephones.att.com or call **1 (800) 222-3111**; in Canada, please

dial **1 (866) 288-4268**. NOTE: Before calling for service, please review the user's manual. A check of the PRODUCT's controls and features might save you a service call.

Except as provided by applicable law, you assume the risk of loss or damage during transit and transportation and are responsible for delivery or handling charges incurred in the transport of the PRODUCT(s) to the service location. The manufacturer will return repaired or replaced PRODUCT under this limited warranty. Transportation, delivery or handling charges are prepaid. The manufacturer assumes no risk for damage or loss of the PRODUCT in transit. If the PRODUCT failure is not covered by this limited warranty, or proof of purchase does not meet the terms of this limited warranty, the manufacturer notifies you and requests that you authorize the cost of repair prior to any further repair activity. You must pay for the cost of repair and return shipping costs for the repair of products that are not covered by this limited warranty.

6. What must you return with the PRODUCT to get warranty service?

You must:

- a. Return the entire original package and contents including the PRODUCT to the service location along with a description of the malfunction or difficulty; and
- b. Include "valid proof of purchase" (sales receipt) identifying the PRODUCT purchased (PRODUCT model) and the date of purchase or receipt; and
- c. Provide your name, complete and correct mailing address, and telephone number.

7. Other limitations

This warranty is the complete and exclusive agreement between you and the manufacturer of this AT&T branded PRODUCT. It supersedes all other written or oral communications related to this PRODUCT. The manufacturer provides no other warranties for this PRODUCT. The warranty exclusively describes all of the manufacturer's responsibilities regarding the PRODUCT. There are no other express warranties. No one is authorized to make modifications to this limited warranty and you should not rely on any such modification.

State/Provincial Law Rights: This warranty gives you specific legal rights, and you might also have other rights that vary from state to state or province to province.

Limitations: Implied warranties, including those of fitness for a particular purpose and merchantability (an unwritten warranty that the PRODUCT is fit for ordinary use) are limited to one year from date of purchase. Some states/provinces do not allow limitations on how long an implied warranty lasts, so the above limitation might not apply to you. In no event shall the manufacturer be liable for any indirect, special, incidental, consequential, or similar damages (including, but not limited to lost profits or revenue, inability to use the PRODUCT or other associated equipment, the cost of substitute equipment, and claims by third parties) resulting from the use of this PRODUCT. Some states/provinces do not allow the exclusion or limitation of incidental or consequential damages, so the above limitation or exclusion might not apply to you.

Please retain your original sales receipt as proof of purchase.

Technical specifications

RF frequency band	1921.536MHz — 1928.448MHz
Channels	5
Operating temperature	32°F — 122°F 0°C — 50°C
Telephone base voltage (AC voltage, 60Hz)	96 — 129 Vrms
Telephone base voltage (AC adapter output)	6VDC @400mA
Handset voltage	2.4 — 3.2 VDC
Charger voltage (AC adapter output)	6VAC @300mA
Replacement battery	2.4V 400mAH
Operating time*	Talk time (handset): up to seven hours Talk time (speakerphone): up to five hours Standby: up to seven days

* Operating times vary depending on your actual use and the age of the battery.

DECT 6.0 digital technology

The AT&T DECT 6.0 products offer unsurpassed range performance and sound clarity. This is achieved through a unique antenna design and advances in noise-filtering technology. An independent laboratory has confirmed that AT&T DECT 6.0 products perform up to 45% better in range competitions. Now calls can be taken in the basement, backyard and garage with exceptional sound quality.

Telephone operating range

This cordless telephone operates within the maximum power allowed by the Federal Communications Commission (FCC). Even so, this handset and telephone base can communicate over only a certain distance — which can vary with the locations of the telephone base and handset, the weather, and the construction of your home or office.

Extended range and clarity

This telephone base comes with an antenna which gives much better clarity and covers a longer range than before.

Index

A

Add a cell phone, 15
Add a handset, 95, 101
Add a headset, 17
Alert tones, 91
Alphabetical search, 64
Announcement, 76
Answer a cell call, 42
Answer a cell call while on a home call, 42
Answer a home call, 40
Answering system and voicemail, 82
Answering system settings, 75
Answer on/off, 75
Appendix, 90

B

Battery charging, 9
Battery installation, 9
Bluetooth, 13
Bluetooth connection from idle mode, 22
Bluetooth glossary, 14
Bluetooth setup, 15

C

Caller ID, 69
Caller ID history, 70
Caller ID log, 70
Caller log display screen messages, 74
Call intercept, 83
Call screening, 83
Call waiting on the cell line, 42
Call waiting on the home line, 41
Cell area code, 38
Cell call, 42
Cell phone - download directory, 23
Cell phone voicemail, 43
Chain dialing, 47, 48
Change a one-to-one PTT to intercom call, 58
Charger installation, 8
Charging, 10
Clock, 9, 29

Conference home and cell calls, 44
Connect an active device, 19
Create a new directory entry, 61

D

Date, 9, 29
Delete a directory entry, 66, 67
Delete all old messages, 87
Delete a message, 85
Delete a redial entry, 50
Delete from the caller ID log, 74
Delete the announcement, 77
Deregister handsets, 96
Dial a caller ID log entry, 72
Dial a directory entry, 65
Dialing options, 72
Dial mode, 35
Directory, 23, 60
Disconnect an active device, 19
Display alerts, 31
Display screen messages, 92
Download directory, 23
Download fail, 33
DSL filter, 7

E

Edit a directory entry, 65
Edit the type of a directory entry, 66
End a cell call, 42
End a home call, 40
End a PTT call, 59
End mute, 45
Equalizer, 46
Expand your telephone system, 95

F

Find handset, 51
Flash (switch hook flash), 41

G

Glossary, 14

Index

H

Handset icons, 90
Handset lights, 91
Handset locator, 51
Handset ringer volume, 27
Handset settings, 27
Hold, 46
Hold a call and intercom, 54
Home area code, 37
Home directory, 60

I

Icons, 90
Important safety information, 111
Indicators, 91
Installation, 6
Intercom, 52
Interruption to directory download,
25

K

Key tone, 34

L

Last number redial, 49
LCD Language, 30
Lights, 91
Limited warranty, 115
Listening volume, 45

M

Maintenance, 110
Make a call using speed dial, 67
Make a cell call, 42
Make a home call, 40
Memory match, 70
Memos, 87
Message alert tone, 80
Message capacity, 83
Message playback, 85, 86
Message window displays, 88
Missed calls, 31
Mute, 45

N

No home line, 33
Number of rings, 79

O

Operating range, 117

P

Paging, 51
Phonebook (directory), 60
Play memos, 87
Play the announcement, 76
Predialing, 40
PTT, 55
PTT to all handsets, 57
PTT to a single handset, 56
Pulse dialing, 35, 46
Push-to-talk, 55

Q

Quick reference guide, 1

R

Reassign a speed dial slot, 67
Record announcement, 76
Recording time setting, 81
Record memos, 87
Redial list, 49
Register a handset, 95, 101
Remote access code, 89
Remove a device, 20
Remove a downloaded directory, 66
Rename a device, 21
Repeat messages, 85, 86
Replace a handset, 96
Replace an active device, 22
Review the active devices list, 19
Review the caller ID log, 71
Review the directory, 64
Review the redial list, 49
Ringer mute, 45
Ringer tone, 28
Ringer volume, 27

Index

S

Safety information, 111
Save a caller ID log entry to the directory, 73
Save a redial entry to the directory, 50
Search for a contact, 64
Set date/time, 9, 29
Share an outside call, 51
Silence the ringer, 45
Skip messages, 85, 86
Speakerphone, 45
Speed Dial, 67
Stop messages, 85, 86

T

Technical specifications, 117
Telephone base installation, 7
Telephone base lights, 91
Telephone operating range, 117
Telephone operation, 40
Telephone settings, 27
Temporary tone dialing, 46
Time, 9, 29
Transfer a call, 48, 54
Transfer a call from a handset to a headset, 41
Troubleshooting, 97
Turn on or off the answering system, 75

U

Use a Bluetooth headset, 40
Using the home and cell lines together, 44

V

View the directory download information, 25
Voice announce caller ID, 36
Voicemail, 32, 43, 82
Volume, 27, 35, 39, 45, 85, 86

W

Wall mounting, 11
Warranty, 115
Website, 36

Remote access wallet card

The wallet card below lists the commands needed to control your answering system from any touch-tone telephone.

Cut along dotted line.



Call your telephone number, then enter your two-digit remote access code (preset to **19**).

Action	Remote command
Play all messages	1
Play new messages.....	2
Delete the message.....	3 (during message playback)
Delete all old messages	33
Repeat or go back.....	4
Stop.....	5
Help menu	*5
Skip the message	6
Record announcement	*7
Turn system on or off	0
End remote access call.....	8 (or hang up)

Fold here.

TL92271/TL92371/TL92471

DECT 6.0 cordless telephone/answering system with BLUETOOTH® wireless technology

© 2009-2010 Advanced American Telephones. All Rights Reserved.
AT&T and the AT&T logo are trademarks of AT&T Intellectual Property licensed to Advanced American Telephones, San Antonio, TX 78219.
Printed in China.



www.telephones.att.com

The *Bluetooth*® word mark and logos are owned by Bluetooth SIG, Inc. and any use of such marks by Advanced American Telephones and its parent, VTech Holdings Limited, is under license. VTech Holdings Limited is a member of Bluetooth SIG, Inc. Other trademarks and trade names are those of their respective owners.

© 2009-2010 Advanced American Telephones. All Rights Reserved.
AT&T and the AT&T logo are trademarks of AT&T Intellectual Property licensed to
Advanced American Telephones, San Antonio, TX 78219.
Printed in China. Issue 4 AT&T 03/10.