

Congratulations

on purchasing your new AT&T product. Before using this AT&T product, please read **Important safety information** on pages 68-69 of this user's manual. Please thoroughly read the user's manual for all the feature operations and troubleshooting information you need to install and operate your new AT&T product. You can also visit our website at www.telephones.att.com or call **1 (800) 222-3111**. In Canada, dial **1 (866) 288-4268**.



User's manual

**EL52201/EL52251/
EL52301/EL52351/
EL52401/EL52501
DECT 6.0 cordless telephone/
answering system with
caller ID/call waiting**

Model number: EL52201/EL52251 (two-handset system)
EL52301/EL52351 (three-handset system)
EL52401 (four-handset system)
EL52501 (five-handset system)

Type: DECT 6.0 cordless telephone with answering system

Serial number: _____

Purchase date: _____

Place of purchase: _____

Both the model and serial numbers of your AT&T product can be found on the bottom of the telephone base.



Telephones identified with this logo have reduced noise and interference when used with most T-coil equipped hearing aids and cochlear implants. The TIA-1083 Compliant Logo is a trademark of the Telecommunications Industry Association. Used under license.



The ENERGY STAR® program (www.energystar.gov) recognizes and encourages the use of products that save energy and help protect our environment. We are proud to mark this product with the ENERGY STAR® label indicating it meets the latest energy efficiency guidelines.

Parts checklist

Your telephone package contains the following items. Save your sales receipt and original packaging in the event warranty service is necessary.

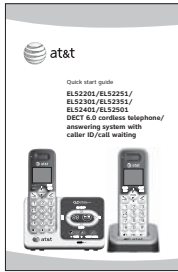

Quick start guide



Telephone base



Power adapter for telephone base



Cordless handset
(2 for EL52201/EL52251)
(3 for EL52301/EL52351)
(4 for EL52401)
(5 for EL52501)

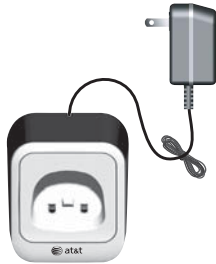

Charger for cordless handset with power adapter installed
(1 for EL52201/EL52251)
(2 for EL52301/EL52351)
(3 for EL52401)
(4 for EL52501)



Wall mount bracket



Battery for cordless handset
(2 for EL52201/EL52251)
(3 for EL52301/EL52351)
(4 for EL52401)
(5 for EL52501)



Battery compartment cover
(2 for EL52201/EL52251)
(3 for EL52301/EL52351)
(4 for EL52401)
(5 for EL52501)



Telephone line cord

User's manual

**EL52201/EL52251/
EL52301/EL52351/
EL52401/EL52501**

**DECT 6.0 cordless telephone/
answering system with
caller ID/call waiting**



Table of contents

Getting started

Quick reference guide	2
Telephone base and charger installation.....	4
Battery installation and charging.....	5
Battery installation.....	5
Battery charging.....	6
Wall mount installation.....	7
Tabletop to wall mount installation.....	7
Wall mount to tabletop installation	9

Telephone settings

Menu overview.....	10
Handset settings.....	11
Ringer volume.....	11
Ringer tone.....	11
LCD language.....	11
Voicemail waiting (visual message waiting) indicator	12
Clear voicemail indication	12
Key tone.....	13
Set date/time.....	13
Home area code.....	14
Dial mode.....	14
Telephone base ringer volume.....	15
Answering system settings.....	15

Telephone operation

Making, answering and ending calls.....	16
Making a call.....	16
Temporary ringer silencing.....	16
Answering a call.....	17
Speakerphone.....	17
Ending a call.....	17

Redial.....	18
View numbers in the redial list	18
Call a number from the redial list.....	18
Copy a number from the redial list to the directory.....	19
Delete a number in the redial list	19
Options while on calls.....	20
Volume control.....	20
Mute.....	20
Flash/call waiting	20
Temporary tone dialing.....	21
Chain dialing.....	21
Join a call in progress	22
Handset locator.....	23
Intercom.....	24
Make and answer an intercom call.....	24
Answer an incoming call during an intercom call.....	24
Call transfer using intercom	25

Directory

Directory overview.....	26
Shared directory	26
Directory memory capacity.....	26
Exiting the directory	26
Speed dial overview.....	26
Create directory entries.....	27
Add a new contact.....	27
Add a predialed telephone number to the directory.....	28
Review the directory.....	29
Review directory entries.....	29
Search by name.....	29

Dial, delete and edit a directory entry.....	30	Call screening.....	45
Dial a directory number.....	30	Call intercept.....	46
Delete a directory entry.....	30	Temporarily turn off the message alert tone.....	46
Edit a directory entry.....	30	Message playback.....	47
Speed dial locations.....	31	Listen to messages.....	47
Assign or reassign a directory entry to a speed dial location.....	31	Options during playback.....	48
Clear a speed dial location.....	31	Delete all old messages.....	49
Dial a speed dial number.....	32	Recording and playing memos.....	50
Caller ID		Record a memo.....	50
About caller ID.....	33	Play back memos.....	50
Information about caller ID with call waiting.....	33	Message window displays.....	51
About home area code.....	33	Remote access.....	52
Caller ID history.....	34	Remotely access the answering system.....	52
How caller ID history (call log) works.....	34	Appendix	
Memory match.....	34	Screen icons, indicator lights and alert tones.....	54
Caller ID operation.....	35	Screen icons.....	54
Missed (new) calls indicator.....	35	Handset indicator lights.....	54
Reasons for missing caller ID information.....	35	Telephone base indicator lights.....	55
View the caller ID history.....	36	Handset alert tones.....	55
View the dialing options.....	36	Telephone base alert tones.....	55
Dial a caller ID history number.....	37	Handset display screen messages.....	56
Delete caller ID history entries.....	37	Troubleshooting.....	58
Save a caller ID history entry in the directory.....	38	Maintenance.....	67
Answering system		Important safety information.....	68
Answering system settings.....	39	Safety information.....	68
Announcement.....	39	Precautions for users of implanted cardiac pacemakers.....	69
Answer on/off.....	40	Pacemaker patients.....	69
Call screening.....	41	Especially about telephone answering systems.....	69
Number of rings.....	41	FCC Part 68 and ACTA.....	70
Remote access code.....	42	FCC Part 15.....	71
Message alert tone.....	42	Limited warranty.....	72
Recording time.....	43	Technical specifications.....	74
Answering system overview.....	44	DECT 6.0 digital technology.....	74
Answering system and voicemail indicators.....	44	Telephone operating range.....	74
Using the answering system and voicemail together.....	44	Index	
Voice prompts.....	45	Index.....	75
Message capacity.....	45		
Answering system new message indication.....	45		



Install the telephone base close to a telephone wall jack and an electrical outlet not controlled by a wall switch. The telephone base can be placed on a flat surface or vertically mounted on the wall (page 7). For optimum range and better reception, place the telephone base in a central and open location.

If you subscribe to high-speed Internet service (DSL- digital subscriber line) through your telephone line, you must install a DSL filter between the telephone line cord and the telephone wall jack (page 4). The filter prevents noise and caller ID problems caused by DSL interference. Please contact your DSL service provider for more information about DSL filters.

Your product may be shipped with a protective sticker covering the handset or telephone base display - remove it before use.

For customer service or product information, visit our website at **www.telephones.att.com** or call **1 (800) 222-3111**. In Canada, dial **1 (866) 288-4268**.

- Avoid placing the telephone base too close to:**
- Communication devices such as television sets, VCRs, or other cordless telephones.
 - Excessive heat sources.
 - Noise sources such as a window with traffic outside, motors, microwave ovens, refrigerators, or fluorescent lighting.
 - Excessive dust sources such as a workshop or garage.
 - Excessive moisture.
 - Extremely low temperature.
 - Mechanical vibration or shock such as on top of the washing machine or work bench.

Quick reference guide

MUTE/DELETE

During a call, press to mute the microphone (page 20).
While predialing, press to erase digits (page 16).
While reviewing the redial list, directory, speed dial list or caller ID history, press to delete an individual entry (pages 19, 30, 31, and 37).

PHONE/FLASH

Press to make or answer a call (page 16).
During a call, press to answer an incoming call when you receive a call waiting alert (page 20).

1

While reviewing a caller ID history entry, press repeatedly to add or remove 1 in front of the telephone number before dialing or saving it in the directory (page 36).

0

While entering names in the directory, press to add a space (page 27).

TONE ✕

During a call, press to send touch-tone signals (page 21).

REDIAL/PAUSE

Press repeatedly to review the last 10 numbers dialed (page 18).
While entering numbers, press and hold to insert a dialing pause (pages 16 and 27).

🔊/SPEAKER

Press to turn on the handset speakerphone, press again to resume normal handset use (pages 17, 39, and 48).



INT

Press to initiate an intercom conversation or transfer a call (pages 24 and 25).

▲DIR/VOLUME

Press to scroll up while in menus (page 10).
Press to increase the listening volume (pages 20 and 48) during a call.
Press to show directory entries when the handset is not in use (page 29).
While entering names or numbers in the directory, press to move the cursor to the right (page 27).

▼CID/VOLUME

Press to scroll down while in menus (page 10).
Press to decrease the listening volume (pages 20 and 48) during a call.
Press to show the caller ID history when the handset is not in use (page 36).
While entering names or numbers in the directory, press to move the cursor to the left (page 27).

MENU/SELECT

Press to display the menu (page 10).
Once in the menu, press to select an item or save an entry or setting (page 10).

OFF/CANCEL

During a call, press to hang up (page 17).
While using menus, press to cancel an operation, back up to the previous menu, or exit the menu display (page 10).
Press and hold while the handset is not in use to erase the missed call indicator (page 35).

(pound key)

When reviewing a caller ID entry, press repeatedly to view the dialing options (page 36).

Quick reference guide

The > symbol indicates the feature to select.

Main menu

PLAY MESSAGES (page 47)
ANSWERING SYS (page 39)
DIRECTORY (page 26)
CALL LOG (page 33)
RINGERS (page 11)
SETTINGS (pages 11-14)

Using menus

Press **MENU/SELECT** to enter the main menu.
Press **▼CID** or **▲DIR** to scroll through menu items.
Press **MENU/SELECT** to select or modify an item.
Press **OFF/CANCEL** to cancel an operation, back up to the previous menu, or exit the menu display.



◀/REPEAT

After the answering system plays the day and time the current message was received, press to repeat the message currently playing (page 48).
While the answering system is playing the day and time the current message was received, press to listen to the previous message (page 48).

🔌/ANS. ON/OFF

Press to turn the built-in answering system on or off (page 40).

▶/SKIP

Press to skip a message (page 48).

▶/PLAY/STOP

Press to start or stop message playback (page 47).
While call screening, press to temporarily turn the call screening on or off (page 45).

Message window

Displays the number of messages. During playback, displays the messages number currently playing (page 51).

X/DELETE

Press to delete the message currently playing (page 48).
Press twice to delete all old messages when the telephone is not in use (page 49).

📞/HANDSET LOCATOR

Press to make all handsets beep so you can locate them (page 23).



▼/▲/-VOLUME+

When the telephone is not in use, press to adjust the telephone base ringer volume (page 15).

During call screening or message playback, press to adjust the listening volume (pages 46 and 48).

Telephone base and charger installation

Install the telephone base and charger as shown below. If you subscribe to high-speed Internet service (DSL - digital subscriber line) through your telephone line, you must install a DSL filter between the telephone line cord and the telephone wall jack. The filter prevents noise and caller ID problems caused by DSL interference. Please contact your DSL service provider for more information about DSL filters.

The telephone base comes ready for tabletop use. If you want to mount your telephone on a wall, refer to **Wall mount installation** on pages 7-9 for details.

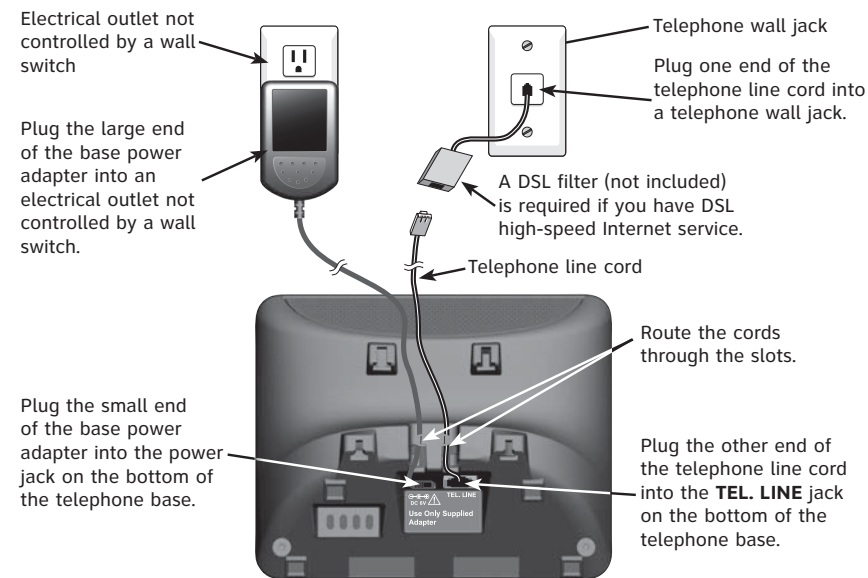

Plug the large end of the charger's power adapter into an electrical outlet not controlled by a wall switch.

Ensure the small end of the charger's power adapter is plugged into the power jack on the bottom of the charger.

IMPORTANT INFORMATION:
Use only the power adapters provided with this product. To obtain a replacement, visit our website at www.telephones.att.com or call **1 (800) 222-3111**. In Canada, dial **1 (866) 288-4268**.

Battery installation and charging

Battery installation

Install the battery as shown below.



1. Plug the battery connector securely into the socket inside the handset battery compartment, matching the color-coded label.
2. Insert the supplied battery with the label **THIS SIDE UP** facing up as indicated.
3. Align the cover flat against the battery compartment, then slide it upwards until it clicks into place.



4. Charge the handset by placing it face up in the telephone base or charger. The **CHARGE** light is on when charging.



To replace the battery, press the tab and slide the battery compartment cover downwards. Lift out the old battery and disconnect it from the handset. Follow the instructions above to install and charge the new battery.

IMPORTANT INFORMATION:
Use only the supplied rechargeable battery or replacement battery (model BT166342). To order, visit our website at www.telephones.att.com or call **1 (800) 222-3111**. In Canada, dial **1 (866) 288-4268**.

Battery installation and charging

Battery charging

Once you have installed the battery, the screen indicates the battery status (see the table below). If necessary, place the handset in the telephone base or charger to charge the battery. For best performance, keep the handset in the telephone base or charger when not in use. The battery is fully charged after 10 hours of continuous charging. See **Technical specifications** on page 74 for battery operating times.



Battery status icon

If the screen is blank, you need to charge the handset without interruption for at least 30 minutes to give the handset enough charge to use the telephone for a short time. The screen shows **LOW BATTERY** until you have charged the battery without interruption for at least 30 minutes. The following table summarizes the battery charge indicators and actions to take.

Battery indicators	Battery status	Action
The screen is blank or shows PLACE IN CHARGER.	Battery has no or very little charge. The handset cannot be used.	Charge without interruption (at least 30 minutes).
The screen shows LOW BATTERY and flashes.	Battery has enough charge to be used for a short time.	Charge without interruption (at least 30 minutes).
The screen shows HANDSET X and the battery icon shows or .	Battery is charged.	To keep the battery charged, place it in the telephone base or charger when not in use.

NOTES:

- If you are on a call in low battery mode, you hear 4 short beeps every 50 seconds.
- If no battery is installed in the handset when you place it in the telephone base or charger, the **CHARGE** light does not turn on and the screen shows **NO BATTERY**. Follow the instructions in **Battery installation** on page 5 to install the battery.

After you install your telephone or power returns following a power outage, the handset will prompt you to set the date and time (see page 13). To skip setting the date and time, press **OFF/CANCEL**.



Wall mount installation

The telephone base comes ready for tabletop use. If you want to mount your telephone on a wall, use the provided wall mount bracket to connect with a standard dual-stud telephone wall mounting plate. If you do not have this mounting plate, you can purchase one from many hardware or consumer electronics retailers. Professional assistance may be required to install the mounting plate.

Tabletop to wall mount installation

To change the telephone base from tabletop installation to wall mount installation, make sure you first unplug the power adapter from the electrical outlet and unplug the telephone line cord from the telephone wall jack.

1. Plug one end of the telephone line cord into the **TEL. LINE** jack on the bottom of the telephone base. Plug the small end of the base power adapter into the power jack on the bottom of the telephone wall jack.
2. Position the telephone base as shown below. Insert the extended tabs of the wall mount bracket (marked B) into the slots on the back of the telephone base. Push the telephone base down until it clicks securely in place.
3. Route the telephone line cord through the wall mount bracket hole. Route the power cord out of the bottom of the telephone.

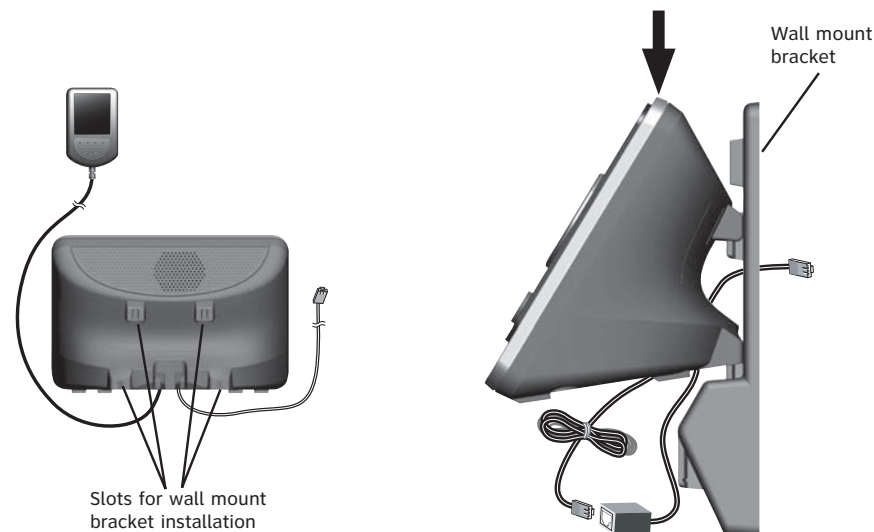

A DSL filter (not included) is required if you have DSL high-speed Internet service.

Wall mount installation

4. Plug the other end of the telephone line cord into the telephone wall jack. Plug the large end of the base power adapter into an electrical outlet not controlled by a wall switch.

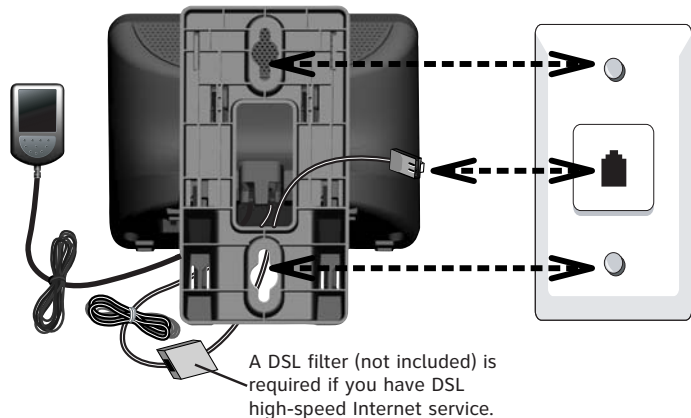

5. Align the holes on the wall mount bracket with the mounting studs of the wall mounting plate and slide the bracket down until it locks securely into place. If necessary, bundle the telephone line cord and power adapter cord neatly with twist ties.

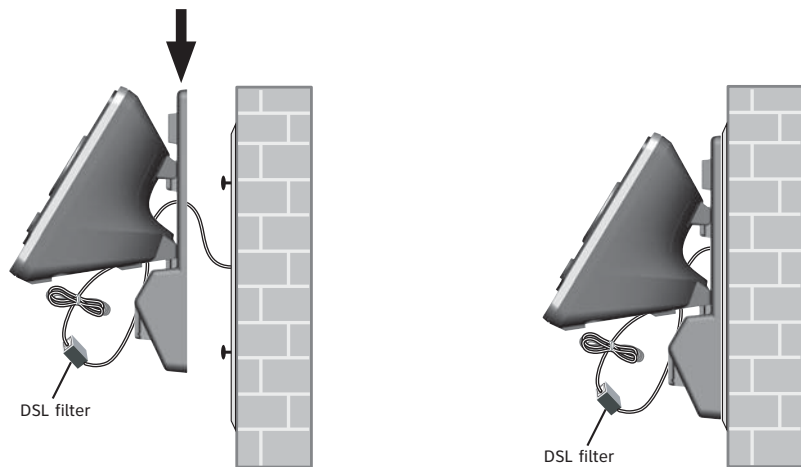

Wall mount installation

Wall mount to tabletop installation

To change the telephone base from wall mount installation to tabletop installation, follow the steps below.

1. Unplug the large end of the base power adapter from the electrical outlet.
2. If the telephone line cord and power adapter cord are bundled, untie them first. Slide the wall mount bracket up and remove it from the wall mounting plate. Unplug the end of the telephone line cord from the telephone wall jack.

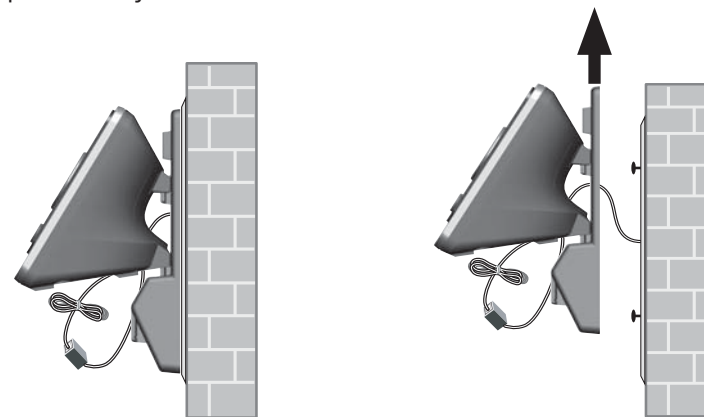

3. Lift the telephone base up to detach it from the wall mount bracket.

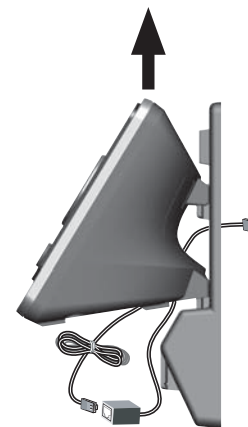

4. Refer to **Telephone base and charger installation** on page 4 to install the telephone base.

Menu overview

Use the menu to change the telephone settings.

1. Press **MENU/SELECT** in idle mode (when handset is not in use) to enter the main menu.
2. Press **▼CID** or **▲DIR** until **>** is next to the feature you want to select.
3. Press **MENU/SELECT** to select or save the indicated item.

-OR-

Press **OFF/CANCEL** to cancel an operation, back up to the previous menu or exit the menu display.

-OR-

Press and hold **OFF/CANCEL** to cancel an operation and return to idle mode.

-OR-

If no key is pressed within 30 seconds, the handset automatically cancels an operation and returns to idle mode.



The handset is in idle mode



The > symbol indicates the feature to select.

NOTE: The menu items **PLAY MESSAGE, ANSWERING SYS, DIRECTORY, CALL LOG, CLR VOICEMAIL, SET DATE/TIME, HOME AREA CODE** and **DIAL MODE** are shared by all handsets. Any changes made to these menu items on any one handset apply to all handsets.

Menu structure

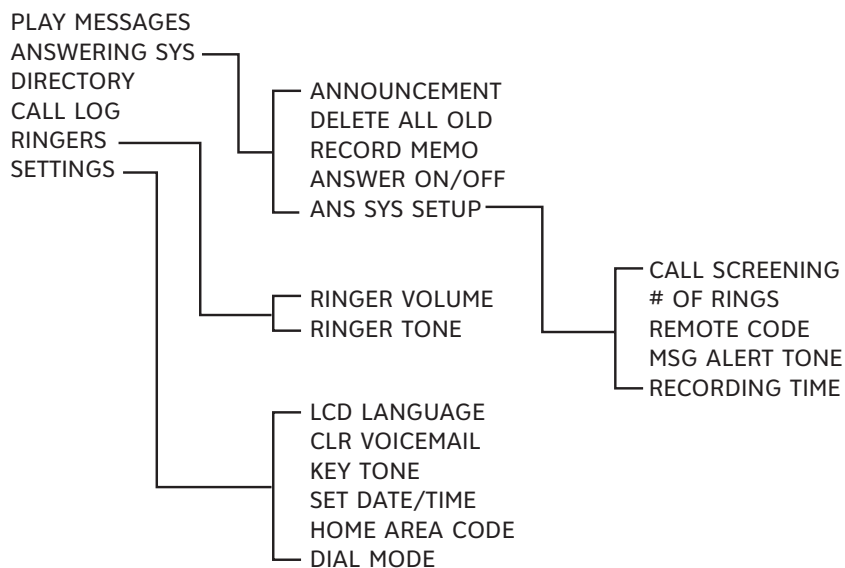

Handset settings

Ringer volume

You can set the handset ringer volume level (1-6), or turn the ringer off. When the ringer is off, appears on the handset screen.

1. Press **MENU/SELECT** in idle mode to enter the main menu.
2. Press **▼CID** or **▲DIR** to scroll to **>RINGERS**. Press **MENU/SELECT**.
3. Press **MENU/SELECT** to select **>RINGER VOLUME**.
4. Press **▼CID** or **▲DIR** to sample each volume level.
5. Press **MENU/SELECT** to save your preference.



NOTES:

- Changing the handset ringer volume does not affect the base ringer volume. For more information on the base ringer volume, see **Telephone base ringer volume** on page 15.
- The handset ringer volume also determines the ringer volume of intercom calls and paging tones.
- If the handset ringer volume is off, that handset ringer is silenced for all incoming calls. However, that handset still plays the paging tone when responding to the handset locator feature (see **Handset locator** on page 23).
- While the telephone is ringing, press **OFF/CANCEL** or **MUTE/DELETE** to silence the ringer temporarily on that handset only (see **Temporary ringer silencing** on page 16).

Ringer tone

You can choose one of 10 ringer tones for the handset.

1. Follow Steps 1 and 2 in **Ringer volume** above.
2. Press **▼CID** or **▲DIR** to scroll to **>RINGER TONE**, then press **MENU/SELECT**.
3. Press **▼CID** or **▲DIR** to sample each tone.
4. Press **MENU/SELECT** to save your preference.

NOTE: If you turn off the handset ringer volume, you will not hear ringer tone samples.



LCD language

You can select the language used for all screen displays.

1. Press **MENU/SELECT** in the idle mode to enter the main menu.
2. Press **▼CID** or **▲DIR** to scroll to **>SETTINGS**. Press **MENU/SELECT**.
3. Press **MENU/SELECT** to select **>LCD LANGUAGE**.
4. Press **▼CID** or **▲DIR** to select **ENGLISH, FRANÇAIS** or **ESPAÑOL**.
5. Press **MENU/SELECT** to save your preference.



Handset settings

Voicemail waiting (visual message waiting) indicator

If you subscribe to a voicemail service offered by your telephone service provider, this feature provides a visual indication when you have new voicemail messages.

NEW VOICEMAIL and  appear on the handset screen.



i NOTES:

- Your telephone service provider might alert you to new voicemail messages with a stutter (broken) dial tone. Contact your telephone service provider for more details.
- This feature does not indicate new messages recorded on your telephone's built-in answering system.
- For more information about the differences between your answering system and voicemail, see **Answering system and voicemail indicators** on page 44.

Clear voicemail indication

Use this feature when the telephone indicates there is a new voicemail message but there is none. This may occur, for example, when you have accessed your voicemail while away from home. This feature only turns off the displayed **NEW VOICEMAIL** message and  icon; it does not delete your voicemail messages. As long as you have new voicemail messages, your telephone service provider continues to send the signal to turn on the indicators.

To manually turn off the new voicemail indicators:

- Press **MENU/SELECT** when in idle mode to enter the main menu.
- Press **▼CID** or **▲DIR** to scroll to **>SETTINGS**, then press **MENU/SELECT**.
- Press **▼CID** or **▲DIR** to scroll to **>CLR VOICEMAIL**, then press **MENU/SELECT**. The screen shows **TURN OFF INDICATOR?**
- Press **MENU/SELECT** to turn the voicemail indication off. A confirmation tone sounds.
-OR-
Press  **OFF/CANCEL** to cancel the procedure.



i NOTE: For more information about using your voicemail service, contact your telephone service provider for assistance.

Handset settings

Key tone

The handset is programmed to beep with each key press. You can turn the key tone off, so there are no beeps when you press keys.

- Press **MENU/SELECT** in idle mode to enter the main menu.
- Press **▼CID** or **▲DIR** to scroll to **>SETTINGS**, then press **MENU/SELECT**.
- Press **▼CID** or **▲DIR** to scroll to **>KEY TONE**, then press **MENU/SELECT**.
- Press **▼CID** or **▲DIR** to select **>ON** or **>OFF**.
- Press **MENU/SELECT** to save your preference.



Set date/time

The answering system announces the day of the week and time of each message received prior to playing it. If you subscribe to caller ID service, the day, month and time are set automatically with each incoming call (see **About caller ID** on page 33). However, the year must be set so that the day of the week can be calculated from the caller ID information.

Follow the steps below to set the month, date, year and time.

- Press **MENU/SELECT** in idle mode to enter the main menu.
- Press **▼CID** or **▲DIR** to scroll to **>SETTINGS**, then press **MENU/SELECT**.
- Press **▼CID** or **▲DIR** to scroll to **>SET DATE/TIME**, and then press **MENU/SELECT**.
- Press **▼CID** or **▲DIR** to select the month, then press **MENU/SELECT**, or enter the 2-digit number (**01-12**) using the dialing keys (**0-9**).
- Press **▼CID** or **▲DIR** to select the day, then press **MENU/SELECT**, or enter the 2-digit number (**01-31**) using the dialing keys (**0-9**).
- Press **▼CID** or **▲DIR** to select the year, or enter the 2-digit number (**00-99**) using the dialing keys (**0-9**), then press **MENU/SELECT**.
- Press **▼CID** or **▲DIR** to select the hour, then press **MENU/SELECT**, or enter the 2-digit number (**01-12**) using the dialing keys (**0-9**).
- Press **▼CID** or **▲DIR** to select the minute, or enter the 2-digit number (**00-59**) using the dialing keys (**0-9**), then press **MENU/SELECT**.
- Press **▲DIR** or **2** to choose **AM**, or press **▼CID** or **7** to choose **PM**. Press **MENU/SELECT** to save. A confirmation tone sounds.



i NOTE: If the date and time is not set when the message is recorded, the system announces "Time and date not set" before it plays the message.

Handset settings

Home area code

If you dial 7 digits to make a local call (no area code required), enter your area code into the telephone as home area code. When you receive a call from within your home area code, the caller ID history only displays the 7 digits of the telephone number.

This feature makes it easy for you to make a call from the caller ID history. If you dial 10 digits to make a local call, do not use this home area code feature. If you do, you will not be able to place calls from your caller ID history because they have only 7 digits.

1. Press **MENU/SELECT** in idle mode to enter the main menu.
2. Press **▼CID** or **▲DIR** to scroll to **>SETTINGS**, then press **MENU/SELECT**.
3. Press **▼CID** or **▲DIR** to scroll to **>HOME AREA CODE**, then press **MENU/SELECT**.
4. Use the dialing keys to enter your 3-digit area code. Press **MUTE/DELETE** to erase digits while entering.
5. Press **MENU/SELECT** to save the setting.

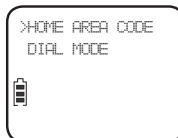

NOTE: If, in the future, your telephone service provider requires you to dial 10 digits to make a local call (area code + telephone number), you need to delete your home area code. While the home area code is displaying in Step 4 above, press and hold **MUTE/DELETE**. The home area code is now restored to its default setting of **_ _ _**(empty).

Dial mode

The dial mode is preset to tone dialing. If you have pulse (rotary) service, you must change the dial mode to pulse dialing before using the telephone.

1. Press **MENU/SELECT** in the idle mode to enter the main menu.
2. Press **▼CID** or **▲DIR** to scroll to **>SETTINGS**, then press **MENU/SELECT**.
3. Press **▼CID** or **▲DIR** to scroll to **>DIAL MODE**, then press **MENU/SELECT**.
4. Press **▼CID** or **▲DIR** to choose between **>TONE** and **>PULSE**.
5. Press **MENU/SELECT** to save the setting.

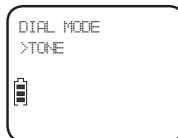
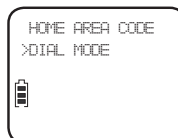

NOTE: If you have dial pulse (rotary) dialing service only, refer to **Temporary tone dialing** on page 21 to temporarily switch from dial pulse to touch-tone dialing during a call.

Telephone base ringer volume

When the telephone base is not in use, press **▼/▲/-VOLUME+** on the telephone base to set the ringer volume level (1-6), or turn the ringer off. A sample of the ringer sounds as you adjust the volume. The telephone base announces, "Base ringer is off" when you set the volume to 0.



NOTE: If a handset is on an outside call, the telephone base volume cannot be changed.

Answering system settings

Go to Answering system settings starting on page 39 for instructions on how to use a handset to modify the answering system settings shown below.

Setting	Page(s)
Announcement (record, play and delete)	39-40
Answer on/off	40
Call screening	41
Number of rings	41
Remote access code	42
Message alert tone	42
Recording time	43

Making, answering and ending calls

Making a call

To make a call:

1. Press **PHONE/FLASH**, then wait for a dial tone.
-OR-
Press **SPEAKER** to use the speakerphone, then wait for a dial tone.



2. Use the dialing keys to enter the telephone number.

On-hook dialing (predialing):

1. Use the dialing keys to enter the telephone number (up to 30 digits).

- Press and hold **REDIAL/PAUSE** to insert a 3-second dialing pause (a **P** appears).
- Press **MUTE/DELETE** or **OFF/CANCEL** to erase digits.

The screen displays the elapsed time as you talk (in hours, minutes and seconds).

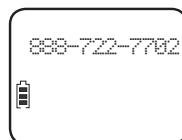

2. Press **PHONE/FLASH** to call.

-OR-

Press **SPEAKER** to call using the speakerphone.

-OR-

Press and hold **OFF/CANCEL** to return to idle mode.

NOTES:

- Pressing **PHONE/FLASH** to access services from your telephone service provider does not affect the elapsed time.
- When a handset is on a call, if another handset attempts to access the directory, speed dial list or caller ID history, the screen shows **NOT AVAILABLE AT THIS TIME**.

Temporary ringer silencing

To silence the ringer temporarily on that handset only:

- While the telephone is ringing, press **OFF/CANCEL** or **MUTE/DELETE**.



To silence the ringer temporarily on the telephone base:

- While the telephone is ringing, press **VOLUME** on the telephone base.

This turns off the ringer without disconnecting the call. The next incoming call rings normally at the preset volume.

NOTE: Unless the ringer volume is turned off on that handset, each handset rings when there is an incoming call.

Making, answering and ending calls

Answering a call

Press any dialing key (**0-9**, ***** or **#**) or **PHONE/FLASH**.

-OR-

Press **SPEAKER** to use the speakerphone.



Speakerphone

During a call, press **SPEAKER** to switch between speakerphone and normal handset use.

Press **OFF/CANCEL** to hang up.

NOTE: After installing the battery in the handset, the screen may show **LOW BATTERY**. If you use the speakerphone at this time, the battery may become depleted. Follow the instructions in **Battery charging** on page 6.



Ending a call

Press **OFF/CANCEL**.

-OR-

Put the handset in the telephone base or charger to end the call.



Redial

Each handset stores the 10 most recently called numbers in the redial list.

View numbers in the redial list

1. Press **REDIAL/PAUSE** in idle mode.
2. Press **REDIAL/PAUSE**. Press **▲DIR**, **▼CID** or **REDIAL/PAUSE** repeatedly to scroll through the 10 most recently called numbers (up to 30 digits each). The handset beeps twice at the beginning or end of the list.
3. Press **OFF/CANCEL** to exit the redial list.



NOTE: If you access an empty redial list, the handset sounds an error tone.

Call a number from the redial list

- Follow Steps 1 and 2 above and when the number you want to call is displayed, press **PHONE/FLASH** or **SPEAKER** to dial.



-OR-

1. Press **PHONE/FLASH** or **SPEAKER** and then wait for a dial tone.
2. Press **REDIAL/PAUSE**. Press **▲DIR**, **▼CID** or **REDIAL/PAUSE** repeatedly until the number you want to call is displayed.
3. Press **MENU/SELECT**. The handset dials the desired number.



NOTE: If you press **REDIAL/PAUSE** when the redial list is empty, the handset sounds an error tone.

Redial

Copy a number from the redial list to the directory

1. Press **REDIAL/PAUSE**.
2. Press **▼CID** or **▲DIR** to scroll to the number you want to save into the directory. Press **MENU/SELECT** twice. The screen shows **EDIT NUMBER**.
 - Press **▼CID** or **▲DIR** to move the cursor to the left or right.
 - Press and hold **REDIAL/PAUSE** to enter a 3-second dialing pause (a **P** appears).
 - Press **MUTE/DELETE** to erase a digit.
 - Press and hold **MUTE/DELETE** to erase all digits.
3. Press **MENU/SELECT** again to save the number and edit the name. The screen shows **EDIT NAME**.
 - Use the dialing keys (**0-9**) to edit the name.
 - Press **MUTE/DELETE** to erase a character.
 - Press and hold **MUTE/DELETE** to erase all characters.
4. Press **MENU/SELECT** to store your new directory entry. The handset shows **SAVED** and sounds a confirmation tone.



Delete a number in the redial list

While reviewing a number in the redial list, press **MUTE/DELETE** to delete the displayed number from the redial list.



Options while on calls

Volume control

While on a call, press **▲DIR/VOLUME** to increase or **▼CID/VOLUME** to decrease the listening volume.

When the volume reaches the minimum or maximum setting, you hear 2 beeps.

i NOTE: The handset volume setting (1-5) and speakerphone volume setting (1-6) are independent.



Mute

Use the mute function to turn off the microphone while on a call. You can hear the caller, but the caller cannot hear you.

To turn mute on:

- Press **MUTE/DELETE**. When mute is on, the handset screen shows **MUTED** for a few seconds and the **MUTE** icon appears until you turn off mute.



To turn mute off:

- Press **MUTE/DELETE** and then resume speaking. When mute is off, **MICROPHONE ON** appears temporarily on the handset screen.
- OR-**
Mute is automatically canceled when you end the call.



Flash/call waiting

If you subscribe to call waiting service provided by your telephone service provider, you hear a beep if someone calls you while you are already on a call.

- Press **PHONE/FLASH** to put your current call on hold and take the new call.
- Press **PHONE/FLASH** anytime to switch back and forth between calls.

i NOTE: For more information on caller ID with call waiting, refer to **About caller ID** on page 33.



Options while on calls

Temporary tone dialing

If you have dial-pulse (rotary) dialing service only, you can temporarily switch from pulse-tone dialing to touch-tone dialing during a call.

- During a call, press **TONE***. Touch-tones are sent when you press dialing keys.
- Use the dialing keys to enter the number.
- The telephone automatically returns to pulse dial mode after you end the call.



Chain dialing

While on a call, you can initiate a dialing sequence from numbers stored in the directory, caller ID history or redial list. Doing this can be useful if you need to access numbers other than telephone numbers (such as account numbers or access codes).

To access the directory while on a call:

- Press **MENU/SELECT**.
- Press **▼CID** or **▲DIR** to scroll to **>DIRECTORY**, then press **MENU/SELECT**.
- Press **▼CID** or **▲DIR** to scroll or use the dialing keys (**0-9**) to find the desired entry (see **Search by name** on page 29).
- Press **MENU/SELECT**. The telephone automatically dials the displayed number.

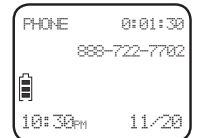

To access the caller ID history while on a call:

- Press **MENU/SELECT**.
- Press **▼CID** or **▲DIR** to scroll to **>CALL LOG**, then press **MENU/SELECT**.
- Press **▼CID** or **▲DIR** to scroll to the desired entry. If necessary to view the dialing options, press **#** (pound key). See **View the dialing options** on page 36 for more details.
- Press **MENU/SELECT**. The telephone automatically dials the displayed number.

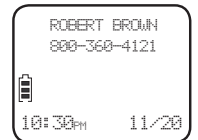

Options while on calls

To access the redial list while on a call:

1. Press **REDIAL/PAUSE**. The screen shows the number most recently called. If it is not the desired number, press **REDIAL/PAUSE**. Press **▲DIR**, **▼CID** or **REDIAL/PAUSE** repeatedly to scroll to the desired number.
2. Press **MENU/SELECT**. The handset dials the displayed number.



NOTES:

- While on a call, you cannot edit a directory entry or redial entry, or copy a caller ID entry into the directory.
- If someone else is already using the directory, speed dial list, caller ID history or answering system, when you attempt to access one of them, the screen shows **NOT AVAILABLE AT THIS TIME**.
- Press **OFF/CANCEL** to exit directory, caller ID history or redial list and return to the call without dialing the displayed number.

Join a call in progress

If a handset is already on a call and you would like to join the call:

- Press **PHONE/FLASH** or **SPEAKER** on another system handset.

To exit the call:

- Press **OFF/CANCEL** or place the handset in the telephone base or charger.



The call does not end until all handsets hang up.

NOTE: For models with 2 to 4 handsets, all handsets can be used at the same time on an outside call. For models with five handsets, you can use a maximum of 4 handsets. If the fifth handset attempts to join the call, the handset screen shows **UNABLE TO CALL. TRY AGAIN**.

Handset locator

You can use the handset locator feature to find misplaced handsets.

To start the paging tone:

- Press **HANDSET LOCATOR** on the telephone base to start the paging tone on all handsets for 60 seconds.

To stop the paging tone:

- Press **PHONE/FLASH**, **SPEAKER**, or any dialing key (**0-9**, ***** or **#**) on the handset(s).
-OR-
- Press **HANDSET LOCATOR** on the telephone base.
-OR-
- Put the handset in the telephone base or charger.

NOTES:

- If you press **OFF/CANCEL** or **MUTE/DELETE** on a handset, the ringer of that handset is silenced but the paging tone continues on the other handsets.
- If a handset is accessing the answering system, on a call (intercom call or outside call), or out of range, that handset does not beep when paged.
- You cannot use the handset locator feature while the telephone base is playing messages or the answering system is being accessed remotely.



Intercom

Make and answer an intercom call

Use the intercom feature for conversations between handsets.

1. Press **INT** on your handset when not in use.

- If you have 2 handsets, your originating handset screen shows **CALLING OTHER HANDSET**. The other handset rings and its screen shows **OTHER HANDSET IS CALLING**.
- If you have more than 2 handsets, your originating handset screen shows **INTERCOM TO:** Use the dialing key to select the destination handset. The originating handset screen shows **CALLING HANDSET X** (X represents the handset number). The destination handset rings and its screen shows **HANDSET X IS CALLING**.



2. To answer the intercom call, press any dialing key (0-9, *, or #), **PHONE/FLASH**, **SPEAKER** or **INT** on the other handset. Both handset screens now show **INTERCOM**.

3. To end an intercom call, press **OFF/CANCEL** or place the handset back in the telephone base or charger. Both handset screens now show **INTERCOM ENDED**.

NOTES:

- Before the intercom call is answered, you can cancel it by pressing **OFF/CANCEL** or **INT** on your originating handset.
- If the other handset is not answered within 100 seconds, is in use, on a call or is out of range, your originating handset shows **UNABLE TO CALL. TRY AGAIN**.
- Pressing **OFF/CANCEL** or **MUTE/DELETE** temporarily silences the intercom ringer.
- If you have 4 handsets, of which 2 handsets are on an intercom call, the other 2 handsets can be used on an outside call (see **Join a call in progress** on page 22) or a separate intercom call.

Answer an incoming call during an intercom call

If you receive an incoming outside call during an intercom call, there is an alert tone.

To answer the incoming outside call:

- Press **PHONE/FLASH**. The intercom call ends automatically.

To end the intercom call without answering the incoming outside call:

- Press **OFF/CANCEL**. The intercom call ends and the handsets ring for the incoming call.

To let the answering system answer the incoming outside call:

- Do nothing. Continue with the intercom call. If the answering system is on, it answers the incoming call after the number of rings you have set.

Call transfer using intercom

Use the intercom feature to transfer an outside call to another system handset.

1. During a call, press **INT**.

- If you have 2 handsets, the outside call is put on hold and your originating handset screen shows **CALLING OTHER HANDSET**. The other handset rings and its screen shows **OTHER HANDSET IS CALLING**.
- If you have more than 2 handsets, your originating handset screen shows **INTERCOM TO:** Use the dialing key to enter a handset number. The outside call is put on hold and your originating handset screen shows **CALLING HANDSET X**. The destination handset rings and its screen shows **HANDSET X IS CALLING**.

2. To answer the intercom call on the other handset, press any dialing key (0-9, *, or #), **PHONE/FLASH**, **SPEAKER** or **INT**. The outside call is still on hold and both handset screens now show **INTERCOM**. You can now have a private conversation between system handsets.

NOTES:

- To cancel the intercom call and return to the external call before the intercom call is answered, press **OFF/CANCEL**, **PHONE/FLASH** or **INT** on your originating handset.
- If the other handset does not answer within 100 seconds, is in use, on a call or is out of range, the calling handset shows **UNABLE TO CALL. TRY AGAIN** on its screen and automatically returns to the outside call.

3. From the intercom call, you have the following options:

- You can let the other handset join you on the outside call in a 3-way conversation. Press and hold INT on the originating handset.

- You can transfer the call. Press **OFF/CANCEL**, or place your handset back in the telephone base or charger. Your handset screen shows **CALL TRANSFERRED**. The other handset automatically connects to the outside call.

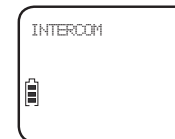

- You can switch between the outside call (**OUTSIDE CALL** appears on the screen) and the intercom call (**INTERCOM** appears on the screen). Press **INT** on the originating handset to switch.
- The other person can end the intercom call by **OFF/CANCEL**, or by placing the other handset back in the telephone base or charger. The outside call continues with the original system handset.

Directory overview

Shared directory

The directory is stored in the telephone base, and is shared by all handsets. Changes made to the directory on any one handset apply to all.

NOTE: Only one handset can review the directory at one time. If another handset attempts to enter the directory, the screen shows **NOT AVAILABLE AT THIS TIME**.



Directory memory capacity

The directory can store up to 50 entries, with a maximum of 15 alphanumeric characters (including spaces) for the names and 30 digits for the telephone numbers.

If there are already 50 entries, the screen shows **DIRECTORY FULL**. You cannot store a new number until you delete one.

If the directory is empty, when you access it, the screen shows **DIRECTORY EMPTY**.



Exiting the directory

Press **OFF/CANCEL** to cancel an operation, back up to the previous menu, or exit the menu display. Press and hold **OFF/CANCEL** to return to idle mode.



Speed dial overview

This telephone has 10 speed dial locations where you can assign telephone numbers from your directory to be dialed by using only one key press. For more details, refer to **Speed dial locations** on page 31.

The speed dial locations are shared by all handsets. Changes made to the entries in the speed dial locations on any one handset apply to all handsets.

NOTE: Only one handset can access the speed dial locations at a time. If another handset attempts to access the speed dial locations, the screen shows **NOT AVAILABLE AT THIS TIME**.

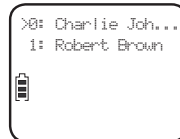

Create directory entries

Add a new contact

1. Press **MENU/SELECT** in idle mode.
2. Press **▼CID** or **▲DIR** to scroll to **>DIRECTORY**, then press **MENU/SELECT**.
3. Press **▼CID** or **▲DIR** to scroll to **>ADD CONTACT**, then press **MENU/SELECT**.
4. Enter the telephone number when prompted.

- Copy a number from redial:
 - a. Press **REDIAL/PAUSE**.
 - b. Press **▼CID** or **▲DIR**, or press **REDIAL/PAUSE** repeatedly to locate the number to copy.
 - c. Press **MENU/SELECT** to copy the number.



-OR-

- Use the dialing keys to enter a number (up to 30 digits).
 - Press **▼CID** or **▲DIR** to move the cursor to the left or right.
 - Press and hold **REDIAL/PAUSE** to enter a 3-second dialing pause (a **P** appears).
 - Press **MUTE/DELETE** to erase a digit.
 - Press and hold **MUTE/DELETE** to erase all digits.
5. Press **MENU/SELECT** to save the number in the display.
 6. Enter the name when prompted. Use the dialing keys and refer to **Character chart** on page 28 to enter a name (up to 15 characters). Each time you press a key, the character on that key appears. Additional key presses produce other characters on that key.
 - Press **0** to add a space.
 - Press **▼CID** or **▲DIR** to move the cursor to the left or right.
 - Press **MUTE/DELETE** to erase a character.
 - Press and hold **MUTE/DELETE** to erase all characters.
 - The first letter or every word is capitalized. The remaining letters in a word start as lower case letters as shown in the character chart on the next page.

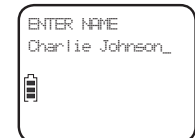

Create directory entries

Character chart:

Dialing key	Characters by number of key press										
	1	2	3	4	5	6	7	8	9	10	11
1	1	.	-	'	()	*	#	&	/	,
2	a	b	c	A	B	C	2				
3	d	e	f	D	E	F	3				
4	g	h	i	G	H	I	4				
5	j	k	l	J	K	L	5				
6	m	n	o	M	N	O	6				
7	p	q	r	s	P	Q	R	S	7		
8	t	u	v	T	U	V	8				
9	w	x	y	z	W	X	Y	Z	9		
0	space	0									

7. Press **MENU/SELECT** to store your new directory entry. The handset shows **SAVED** and a confirmation tone sounds.

NOTES:

- The screen shows **NUMBER ALREADY SAVED** if the number is already in the directory. You cannot save the same number more than once.
- If you pause for too long while creating an entry, the operation times out and you have to begin again.

Add a predialed telephone number to the directory

1. While the handset is in idle mode, use the dialing keys to enter the telephone number (up to 30 digits).
 - Press and hold **REDIAL/PAUSE** to insert a 3-second dialing pause (a **P** appears).
 - Press **MUTE/DELETE** to erase a digit.
 - Press and hold **MUTE/DELETE** to erase all digits.
2. Press **MENU/SELECT** to edit the telephone number. Refer to Step 4 in **Add a new contact** on page 27.
3. Press **MENU/SELECT** to edit the name. Refer to Step 6 in **Add a new contact** on page 27.
4. Press **MENU/SELECT** to store your new directory entry. The handset shows **SAVED** and sounds a confirmation tone.

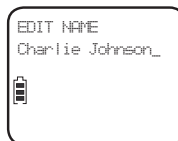
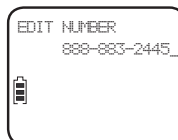

Review the directory

Review directory entries

1. Press **▲DIR** when in idle mode to show the first entry in the directory. **DIRECTORY EMPTY** appears if there are no directory entries.

-OR-

You can also show the first entry in the directory by pressing **MENU/SELECT** when in idle mode. Press **▼CID** or **▲DIR** to scroll to **>DIRECTORY**, then press **MENU/SELECT** twice to select **>REVIEW**.

2. Press **▼CID** or **▲DIR** to browse through the directory. Entries appear alphabetically by the first letter in the name.

NOTES:

- If the telephone number in the directory exceeds 15 digits, **<*** appears in front of the telephone number. Press **TONE*** to move towards the end of the telephone number or press **#** (pound key) to move towards the beginning of the telephone number.
- If you pause for too long while reviewing an entry, the operation times out and you have to begin again.



Search by name

1. Press **▲DIR** when in idle mode to show the first entry in the directory.

2. When an entry appears, use the dialing keys (**0-9**) to start a name search (alphabetical search).

The directory shows the first name beginning with the first letter associated with the dialing key if there is an entry in the directory that begins with that letter. Press **▼CID** or **▲DIR** to scroll through the entries beginning with that letter.

3. To see other names that start with the letters on the same dialing key, keep pressing the key until the desired letter is shown. The names appear in alphabetical order.

For example, if you have the names Jennifer, Jessie, Kevin and Linda in your directory:

- If you press **5 (JKL)** once, **J** and then **Jennifer** displays.
- If you press **5 (JKL)** once, **J** displays. Press **▼CID**. **Jessie** displays.
- If you press **5 (JKL)** twice, **K** and then **Kevin** displays.
- If you press **5 (JKL)** three times, **L** and then **Linda** displays.
- If you press **5 (JKL)** four times, **5** displays.
- If you press **5 (JKL)** five times, **J** displays and then **Jennifer** displays again.

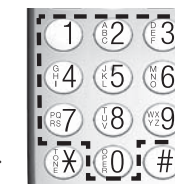

 NOTE: If you press a dialing key (**0-9**) and no name starts with any letter on that key, the directory shows the entry that matches the next letter in the directory.

Dial, delete and edit a directory entry

You can dial, delete or edit the displayed directory entry. See **Review directory entries** on page 29 or **Search by name** on page 29 to show an entry from the directory first.

Dial a directory number

While reviewing a directory entry, press **PHONE/FLASH** or **SPEAKER** to dial the displayed telephone number from the directory.

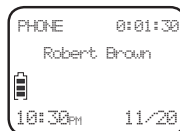
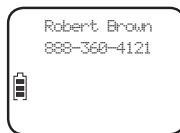

Delete a directory entry

1. While reviewing a directory entry, press **MUTE/DELETE**. The screen shows **DELETE CONTACT?**
2. Press **MENU/SELECT** to delete the displayed entry from the directory. The handset shows **DELETING...** and then **CONTACT DELETED** with a confirmation tone. Once deleted, you cannot retrieve that entry.
-OR-
Press **OFF/CANCEL** to exit and leave the entry intact.

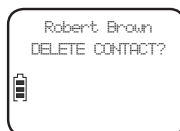

NOTE: If the directory entry you deleted is also in the speed dial location, the telephone will automatically clear the speed dial location which that directory entry occupies.

Edit a directory entry

1. While reviewing a directory entry, press **MENU/SELECT**. The screen shows **EDIT NUMBER** with the current number of the entry.
2. Follow Step 4 in **Add a new contact** on page 27 to edit the digits.
3. Press **MENU/SELECT** to save the number in the display. The screen shows **EDIT NAME** with the current name of the entry.
4. Follow Step 6 in **Add a new contact** on page 27 to edit the characters.
5. Press **MENU/SELECT** to save. The handset shows **SAVED** with a confirmation tone and then shows the updated entry.

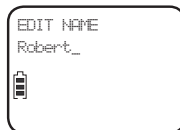
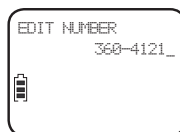

Speed dial locations

The telephone base has 10 speed dial locations (**0-9**). Speed dial assignments can only be selected from existing directory entries.

Assign or reassign a directory entry to a speed dial location

1. Press **MENU/SELECT** in idle mode.
2. Press **▼CID** or **▲DIR** to scroll to **>DIRECTORY**. Press **MENU/SELECT**.
3. Press **▼CID** or **▲DIR** to scroll to **>SPEED DIAL**. Press **MENU/SELECT**.
4. To assign a speed dial location, press **▼CID** or **▲DIR** to scroll to an empty speed dial location.
-OR-
To reassign a speed dial location, press **▼CID** or **▲DIR** to scroll to the desired speed dial location.
5. Press **MENU/SELECT** to show the directory.
6. Press **▼CID** or **▲DIR** to browse through the directory and find the desired entry.
-OR-
Use the alphabetical search to find the desired entry. Refer to Steps 2 and 3 in **Search by name** on page 29.
7. Press **MENU/SELECT** to save. The name (up to 12 characters) of the desired directory entry appears in the selected speed dial location.

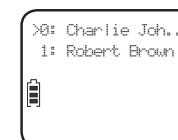

NOTES:

- If the directory is empty, when you press **MENU/SELECT** in Step 5, the screen shows **DIRECTORY EMPTY**.
- If the speed dial location you select is occupied, the new directory entry you selected replaces the old one. Take caution not to replace entries you do not wish to delete from the speed dial locations.

Clear a speed dial location

1. Follow Steps 1-3 in **Assign or reassign a directory entry to a speed dial location** above to enter the speed dial list.
2. Press **▼CID** or **▲DIR** to scroll to a speed dial location.
3. Press **MUTE/DELETE** to clear the selected speed dial location. **<EMPTY>** appears in that speed dial location.

NOTE: Clearing the speed dial locations does not affect the entries in the directory.

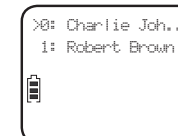

Speed dial locations

Dial a speed dial number

1. When in idle mode, **press and hold** a dialing key (0-9) to display the desired speed dial entry.
2. Press **PHONE/FLASH** or **SPEAKER** to dial the displayed telephone number.

NOTE: If the speed dial location you select is empty, the screen shows the speed dial list.



About caller ID

This product supports caller ID services offered by most telephone service providers. Caller ID allows you to see the name, number, date and time of calls. The available caller ID information will appear after the first or second ring.

Information about caller ID with call waiting

Caller ID with call waiting lets you see the name and telephone number of the caller before answering the call, even while on another call.

It may be necessary to change your telephone service to use this feature. Contact your telephone service provider if:

- You have both caller ID and call waiting, but as separate services (you may need to combine these services).
- You have only caller ID, or only call waiting service.
- You don't subscribe to caller ID or call waiting services.

There may be fees for caller ID services. In addition, services may not be available in all areas.

This product can provide information only if both you and the caller are in areas offering caller ID services and if both telephone service providers use compatible equipment. The time and date are sent by the telephone service provider along with the call information.

The caller ID information may not be available for every incoming call. The callers may intentionally block their names and/or telephone numbers.

NOTE: You can use this product with regular caller ID service, or you can use this product's other features without subscribing to either caller ID or combined caller ID with call waiting service.

About home area code

See **Home area code** on page 14 to determine if you should enter your area code. Entering the area code changes how numbers are displayed in the caller ID history and how to return a call from the caller ID history (see **View the dialing options** on page 36).



Caller ID history

How caller ID history (call log) works

The telephone stores caller ID information about the last 50 incoming calls in the telephone base. Each entry may have up to 24 digits for the telephone number and 15 characters for the name. Entries are stored in reverse chronological order. The telephone deletes the oldest entry when the log is full to make room for new calls. This information is common to all handsets, so changes made to any handset are reflected in all other handsets. If you answer a call before the information appears on the screen, it does not show in the caller ID history.

NOTE: The caller ID information might not be available for every incoming call. The callers might intentionally block their names and/or telephone numbers (see **Reasons for missing caller ID information** on page 35).

Memory match

If the incoming telephone number matches the last 7 digits of a telephone number in your directory, the name that appears on the screen matches the corresponding name in your directory.

For example, if Christine Smith calls, her name appears as **Chris** if this is what you entered into your directory.



NOTE: The number shown by your caller ID is in the format sent by the telephone service provider. The telephone service provider usually delivers 10-digit telephone numbers (area code plus telephone number). If the telephone number of the caller does not match a number in your directory, the name appears as it is delivered by the telephone service provider. For example, if the telephone service provider includes the area code but the number in your directory does not, the name appears as delivered by the telephone service provider.

Caller ID operation

Missed (new) calls indicator

When you have calls that have not been reviewed, all handset idle screens show **X(X) MISSED CALL(S)**.

All entries that have not been reviewed are counted as missed (new) calls. Each time you review a caller ID history entry marked as **NEW**, the number of missed calls decreases one by one.

If you do not want to review the missed (new) calls one by one, but you still want to keep them in the caller ID history, you can **press and hold OFF/CANCEL** for 4 seconds when the handset is idle. All the entries in the caller ID history will be considered old (reviewed), and the missed call(s) message goes away.



Reasons for missing caller ID information

These messages may be displayed instead of caller ID information:

Screen message	Reason
PRIVATE NAME	The caller prefers not to show the name.
PRIVATE NUMBER	The caller prefers not to show the telephone number.
PRIVATE CALLER	The caller prefers not to show the name and telephone number.
UNKNOWN NAME	Your telephone service provider cannot determine the caller's name.
UNKNOWN NUMBER	Your telephone service provider cannot determine the caller's telephone number.
UNKNOWN CALLER	Your telephone service provider cannot determine the caller's name and telephone number. Calls from other countries may also generate this message.

Caller ID operation

View the caller ID history

Review the caller ID history to find out who called, to return the call or to copy the caller's name and number into your directory. **CALL LOG EMPTY** appears if there are no records in the caller ID history.

1. When a handset is in idle mode, press **▼CID** to view the caller ID history in reverse chronological order starting with the most recent call.

-OR-

You can also review the caller ID history by pressing **MENU/SELECT**. Press **▼CID** or **▲DIR** to scroll to **>CALL LOG**, then press **MENU/SELECT** twice to select **>REVIEW**.

2. Press **▼CID** or **▲DIR** to scroll through the list. A double beep sounds when you reach the beginning or end of the caller ID history.

3. Press **OFF/CANCEL** to exit the caller ID history.

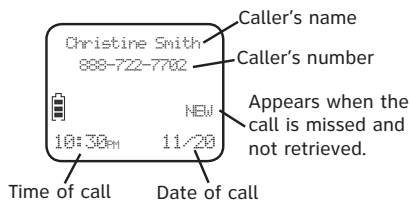

NOTES:

- If the telephone number has more than 15 digits, only the last 15 digits appear in the caller ID history.
- Only one handset can review the caller ID history at a time. If another handset attempts to enter the caller ID history, it shows **NOT AVAILABLE AT THIS TIME**.

View the dialing options

Although the caller ID history entries received typically have 10 digits (the area code plus the 7-digit number), in some areas, you may need to dial only the seven digits, or 1 plus the seven digits, or 1 plus area code plus the seven digits. You can follow the steps below to change the number of digits that you dial from or store in the directory:

1. Follow Steps 1 and 2 in **View the caller ID history** above to find the entry.

2. Before dialing or saving the telephone number in the directory, press **#** (pound key) repeatedly to show different dialing options for local and long distance numbers.

-OR-

Before dialing or saving the telephone number in the directory, press **1** repeatedly if you need to add or remove **1** in front of the telephone number.

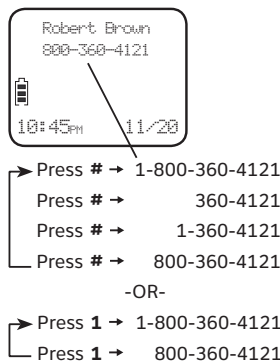

NOTE: If you do not need to dial the area code for local calls, make sure to program your home area code (see **Home area code** on page 14).

Caller ID operation

Dial a caller ID history number

1. While reviewing the caller ID history, press **▼CID** or **▲DIR** to browse through the caller ID history and find the entry.
2. Press **PHONE/FLASH** or **SPEAKER** to dial the displayed telephone number from the caller ID history.



NOTES:

- If the telephone number has more than 15 digits, only the last 15 digits appear in the caller ID history. But, the telephone can still dial out all digits (up to 24 digits) of that telephone number.
- You might need to change how a caller ID number is dialed if the entry does not appear in the correct format. Caller ID numbers might appear with an area code that might not be necessary for local calls, or without a **1** that might be necessary for long distance calls. For details, see **View the dialing options** on page 36.



Delete caller ID history entries

To delete a caller ID history entry:

1. While reviewing the caller ID history, press **▼CID** or **▲DIR** to browse through the caller ID history and find the entry.
2. Press **MUTE/DELETE** to delete the displayed entry from the caller ID history. The screen shows **DELETING...** with a confirmation tone. Once deleted, you cannot retrieve that entry.



To delete all caller ID history entries:

1. Press **MENU/SELECT** in idle mode.
2. Press **▼CID** or **▲DIR** to scroll to **>CALL LOG**. Press **MENU/SELECT**.
3. Press **▼CID** or **▲DIR** to scroll to **>DEL ALL CALLS**. Press **MENU/SELECT**. The screen shows **DELETE ALL CALLS?**
4. Press **MENU/SELECT** to delete all entries from the caller ID history. The screen shows **DELETING...** with a confirmation tone. Once deleted, you cannot retrieve that entry.



-OR-

Press **OFF/CANCEL** to exit and leave all entries in the caller ID history intact.



Caller ID operation

Save a caller ID history entry in the directory

- While reviewing the caller ID history, press **▼CID** or **▲DIR** to browse through the caller ID history and find the desired entry.
- Press **MENU/SELECT**. The screen shows **EDIT NUMBER**.
- Use the dialing keys to modify the telephone number (up to 30 digits).
 - Press **▼CID** or **▲DIR** to move the cursor to the left or right.
 - Press and hold **REDIAL/PAUSE** to enter a 3-second dialing pause (a **P** appears).
 - Press **MUTE/DELETE** to erase a digit.
 - Press and hold **MUTE/DELETE** to erase all digits.
- Press **MENU/SELECT** to save the number in the display. The screen shows **EDIT NAME**.
- Use the dialing keys and refer to **Character chart** on page 28 to modify the name (up to 15 characters).
 - Press **0** to add a space.
 - Press **▼CID** or **▲DIR** to move the cursor to the left or right.
 - Press **MUTE/DELETE** to erase a character.
 - Press and hold **MUTE/DELETE** to erase all characters.
- Press **MENU/SELECT** to save. The screen shows **SAVED** with a confirmation tone.

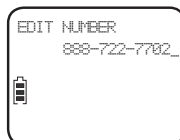

i NOTES:

- The screen shows **NUMBER ALREADY SAVED** if the number is already in the directory. You cannot save the same number more than once.
- If the directory is full, the screen shows **DIRECTORY FULL**.
- If you try to save a caller ID history entry to the directory without a number, **UNABLE TO SAVE** displays.
- If the telephone number has more than 15 digits, only the last 15 digits appear in the caller ID history. But, the telephone can still save all digits (up to 24 digits) of that telephone number from the caller ID history in the directory.
- You might need to change how a caller ID number is saved in the directory if the entry does not appear in the correct format. Caller ID numbers might appear with an area code that might not be necessary for local calls, or without a **1** that might be necessary for long distance calls. For details, see **View the dialing options** on page 36.

Answering system settings

Use the answering system menu in the handset to turn the answering system on or off or change the settings for the outgoing announcement, call screening, number of rings, remote access code and the message alert tone.

Announcement

The announcement is the greeting callers hear when calls are answered by the answering system.

The telephone has a default announcement, "Hello. Please leave a message after the tone." You can use this announcement, or record your own announcement.

You can record an announcement up to 90 seconds. The system does not record any announcement shorter than 2 seconds.

To play the current announcement:

- Press **MENU/SELECT** in idle mode.
- Press **▼CID** or **▲DIR** to scroll to **>ANSWERING SYS**, then press **MENU/SELECT**.
- Press **MENU/SELECT** to select **>ANNOUNCEMENT**. The system announces, "To play, press 2. To record, press 7."
- Press **2** to play the current announcement from the speakerphone.
 - Press **▲DIR/VOLUME** to increase or press **▼CID/VOLUME** to decrease the message playback volume.
 - Press **🔊/SPEAKER** to switch between speakerphone and handset.



To record a new announcement:

- Follow Steps 1 and 2 in **To play the current announcement** above.
- Press **MENU/SELECT** to select **>ANNOUNCEMENT**. The system announces, "To play, press 2. To record, press 7."
- Press **7**. The system announces "Record after the tone. Press 5 when you are done."
- Face the handset and speak towards the microphone to record your announcement.
- Press **5** when you finish the recording. The handset plays back the recorded announcement.



i NOTE: If the answering system memory is full, when you press **7** in Step 3, the answering system announces, "Memory is full." You must delete some messages before you can record a new announcement. Refer to **Message playback** on pages 48-49.

Answering system settings

To delete your announcement:

1. Follow Steps 1-4 in **To play the current announcement** on page 39 to play the announcement.
2. Press **3** during playback to delete your recorded announcement. The system announces, "Announcement deleted."



If your announcement is deleted, calls are answered with the default announcement, "Hello. Please leave a message after the tone."

Answer on/off

Unless you change it, the answering system is on and ready to record messages. If the answering system is on, the **ANS ON** icon displays on the handset screen and the **ANS. ON/OFF** light on the telephone base is on. You can turn the answering system off, but if you do so, the answering system does not answer calls and record incoming messages.

Using the handset:

1. Press **MENU/SELECT** in idle mode to enter the main menu.
2. Press **▼CID** or **▲DIR** to scroll to **>ANSWERING SYS**, then press **MENU/SELECT**.
3. Press **▼CID** or **▲DIR** to scroll to **>ANSWER ON/OFF**, then press **MENU/SELECT**.
4. Press **▼CID** or **▲DIR** to select between **>ON** and **>OFF**, then press **MENU/SELECT** to save the setting. A confirmation tone sounds.



Using the telephone base:

- Press **ANS. ON/OFF** to turn the answering system on or off. If the answering system is turned on, it announces, "Calls will be answered." If the answering system is turned off, it announces, "Calls will not be answered."



NOTES:

- If the answering system is off and there is an incoming call, the system answers after 10 rings and announces to the caller, "Please enter your remote access code." For more information about remote access, see **Remote access code** on page 42.
- You can turn the answering system on or off from either the handset or the telephone base, but you can only use the handset to change the other answering system settings.
- You cannot turn the answering system on or off while a handset is on a call or the telephone base is playing messages.
- During an incoming call, press **ANS. ON/OFF** to turn the answering system on or off.

Answering system settings

Call screening

You can choose whether or not incoming messages are played through the speaker on the telephone base while they are being recorded. However, whether the call screening is on or off, the incoming messages can always be played through the handset.

To change the settings:

1. Press **MENU/SELECT** when in idle mode to enter the main menu.
2. Press **▼CID** or **▲DIR** to scroll to **>ANSWERING SYS**, then press **MENU/SELECT**.
3. Press **▼CID** or **▲DIR** to scroll to **>ANS SYS SETUP**, then press **MENU/SELECT**.
4. Press **MENU/SELECT** to select **>CALL SCREENING**.
5. Press **▼CID** or **▲DIR** to choose between **>ON** and **>OFF**.
6. Press **MENU/SELECT** to save your setting. A confirmation tone sounds.



NOTE: For more details about the features of call screening, see **Call screening** on page 45.

Number of rings

You can set the answering system to answer an incoming call after 6, 5, 4, 3, or 2 rings. You can also select toll saver, which is explained below. Unless you change it, the answering system answers an incoming call after 3 rings.

To set the number of rings:

1. Press **MENU/SELECT** in idle mode to enter the main menu.
2. Press **▼CID** or **▲DIR** to scroll to **>ANSWERING SYS**. Press **MENU/SELECT**.
3. Press **▼CID** or **▲DIR** to scroll to **>ANS SYS SETUP**. Press **MENU/SELECT**.
4. Press **▼CID** or **▲DIR** to scroll to **># OF RINGS**, then press **MENU/SELECT**.
5. Press **▼CID** or **▲DIR** to scroll and choose among **6, 5, 4, 3, 2** or **TOLL SAVER**.
 - Toll saver- the answering system answers a call after 2 rings if you have new messages, and after 4 rings when there are no new messages. This feature allows you to check for new messages and avoid paying long distance charges if you are calling from out of your local area.
6. Press **MENU/SELECT** to save your setting. A confirmation tone sounds.



NOTE: If you subscribe to a voicemail service offered through your telephone service provider, see **Answering system and voicemail indicators** on page 44.

Answering system settings

Remote access code

To access your answering system remotely from any touch-tone telephone, you need to enter a 2-digit number (**00-99**). Unless you change it, the remote access code is **19**.

To change the remote access code:

1. Press **MENU/SELECT** in idle mode to enter the main menu.
2. Press **▼CID** or **▲DIR** to scroll to **>ANSWERING SYS**, then press **MENU/SELECT**.
3. Press **▼CID** or **▲DIR** to scroll to **>ANS SYS SETUP**, then press **MENU/SELECT**.
4. Press **▼CID** or **▲DIR** to scroll to **>REMOTE CODE**, then press **MENU/SELECT**.
5. Press **▼CID** or **▲DIR** to select the remote access code, or use the dialing keys to enter the correct number (**00-99**).
6. Press **MENU/SELECT** to save your setting. A confirmation tone sounds.

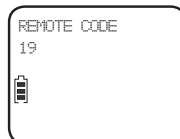
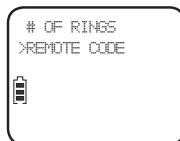

NOTE: For more details about the remote access feature, refer to **Remote access** on page 52.

Message alert tone

When the message alert tone is on, and there is at least one new message, the telephone base beeps every 10 seconds. By default, the message alert tone is set to **OFF**.

To change the setting:

1. Follow Steps 1-3 in **Remote access code** above.
2. Press **▼CID** or **▲DIR** to scroll to **>MSG ALERT TONE**, then press **MENU/SELECT**.
3. Press **▼CID** or **▲DIR** to choose between **>ON** and **>OFF**.
4. Press **MENU/SELECT** to save your setting. A confirmation tone sounds.

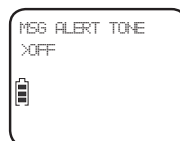

NOTES:

- The message alert tone beeps only if all the conditions below are met:
 - The answering system is on.
 - The message alert tone is on.
 - There are new messages.
- To temporarily turn off the message alert tone, see **Temporarily turn off the message alert tone** on page 46.

Answering system settings

Recording time

You can set the time limit for each message recorded to 3 minutes, 2 minutes, or 1 minute. The default setting is 3 minutes.

To change the setting:

1. Press **MENU/SELECT** in idle mode to enter the main menu.
2. Press **▼CID** or **▲DIR** to scroll to **>ANSWERING SYS**, then press **MENU/SELECT**.
3. Press **▼CID** or **▲DIR** to scroll to **>ANS SYS SETUP**, then press **MENU/SELECT**.
4. Press **▼CID** or **▲DIR** to scroll to **>RECORDING TIME**, then press **MENU/SELECT**.
5. Press **▼CID** or **▲DIR** to scroll and choose **>3 MINUTES**, **>2 MINUTES**, or **>1 MINUTE**.
6. Press **MENU/SELECT** to save your setting. A confirmation tone sounds.



Answering system overview

Answering system and voicemail indicators

Your telephone has separate indicators for two different types of voice messages: those left on its built-in answering system and those left on your service provider's voicemail (fees may apply). Your telephone's built-in answering system messages and voicemail messages are separate. Each alerts you to new messages differently.

- If **OO** icon and **XX NEW MESSAGES** display on the handset and the message window on the telephone base flashes, there are new messages recorded on the built-in answering system. Press **MENU/SELECT** twice on the handset (page 47) or press **▶/PLAY/STOP** on the telephone base (page 47).
- If **✉** and **NEW VOICEMAIL** display on the handset, your telephone service provider is indicating that it has new voicemail for you. To listen to your voicemail, you typically dial an access number provided by your telephone service provider, followed by a security code or **PIN**.

Some service providers bundle or combine multiple services like voicemail and call waiting, so you may not be aware that you have voicemail. To check what services you have and how to access them, contact your telephone service provider.

To use your voicemail service rather than your answering system, turn off your answering system. To use your answering system rather than your voicemail service, contact your telephone service provider to deactivate your voicemail service.

Using the answering system and voicemail together

You can also use your telephone answering system and voicemail together by setting your built-in answering system to answer before voicemail answers as described below. To learn how to program your voicemail settings, contact your telephone service provider. Then, if you are on a call, or if the answering system is busy recording a message and you receive another call, the second caller can leave a voicemail message.

If you have voicemail provided by your telephone service provider, we recommend setting your answering system to answer calls at least 2 rings earlier than your voicemail is set to answer. For example, if your voicemail answers after 6 rings, set your answering system to answer after 4 rings. Some voicemail providers may program the delay before answering calls in seconds instead of rings. In this case, allow 6 seconds per ring when determining the appropriate setting.

Answering system overview

Voice prompts

The system provides voice prompts to guide you to operate the answering system.

Message capacity

The answering system can record up to 99 messages, depending on the length of each message. The maximum recording time (including message, announcement and memo) is 14 minutes and the recording time for individual messages can be set to 3 minutes, 2 minutes or 1 minute (page 43). The actual recording time depends on individual message characteristics. Messages remain available for replay until you delete them.

If the answering system has less than 3 minutes of recording time left, *"Less than 3 minutes to record"* is announced before the message playback and **REC MEM LOW** appears on the handset screen.

If the memory is full, the answering system announces, *"Memory is full."* The number of messages and **F** flash alternatively in the message window, and **REC MEM FULL** appears on the handset screen. You must delete some messages before recording new ones.

Answering system new message indication

When there are new messages (including memos) on the answering system, the number of new messages stored flashes in the message window on the telephone base and the **OO** icon and **XX NEW MESSAGES** appear on the screen of each system handset. If the message alert tone is turned on, the telephone base beeps every 10 seconds when there are new messages.



To listen to messages recorded on your digital answering system, use the menu from a handset or press **▶/PLAY/STOP** on the telephone base (see **Message playback** on page 47).

Call screening

If the answering system and call screening are on, the announcement and the incoming message can be broadcast at the telephone base or the handset when a call arrives.

Call screening at the base:

You can turn call screening on or off using the handset (see **Call screening** on page 41). When call screening is off, you can temporarily turn on the call screening by pressing **▶/PLAY/STOP** or **▲/VOLUME+** on the telephone base. The call screening will automatically be off for the next incoming call.



Answering system overview

If call screening is on and you want to adjust the playback volume to a comfortable level (1-8) while it is recording messages, press ▼/▲/-VOLUME+ on the telephone base. This volume setting is shared with message playback, so when you play messages at volume 1, they play at a very low volume. If you turn up the volume for playback, the call screening for the next incoming message plays at the same volume level.

If call screening is on and you want to silence the telephone base while it is recording messages, press ►/■/PLAY/STOP on the telephone base. The call screening will be on for the next incoming call.

Call screening at the handset:

If the answering system is turned on, when there is an incoming call and it is answered by the answering system, the handset screen shows "TO SCREEN CALL, PRESS [SELECT]." By pressing MENU/SELECT, you can screen the call at the handset.

Call intercept

While call screening, you can stop it manually and speak to the caller.

- If the call is screened at the base, press **PHONE/FLASH** or **SPEAKER** on the handset to stop recording and speak to the caller.
- If the call is screened at the handset, press **PHONE/FLASH** on the handset to stop recording and speak to the caller. Then you can press **SPEAKER** to switch between the speakerphone and the handset.



Temporarily turn off the message alert tone

To temporarily silence the message alert tone:

- When the telephone base is in idle mode, press any telephone base key (except **HANDSET LOCATOR**).

The message alert tone is activated again with the next incoming message.



NOTES:

- When the telephone base is in idle mode, if you press **X/DELETE** to temporarily silence the message alert tone, there is a voice prompt directing you to press **X/DELETE** again to delete all old messages (see **Delete all old messages** on page 49). If you are not going to delete all old messages, wait at least 5 seconds to allow the telephone base to return to idle mode.
- To turn off the message alert tone, see **Message alert tone** on page 42.

Message playback

Listen to messages

You can use either a handset or the telephone base to play messages. If there are new messages, the system plays back only the new messages (in chronological order). If there are no new messages, the system plays back all old messages (in chronological order).

When playback begins, the total number of messages is announced. Before each message, you hear the date and time it was received. After the last message, you hear "End of messages." If the system has less than 3 minutes of recording time left, you hear "Less than 3 minutes to record." If the answering system memory is full, you hear "Memory is full."

NOTES:

- If the date and time is not set when a message is recorded, the system announces, "Time and date not set" before the message is played. To set the date and time, see **Set date/time** on page 13.
- Only one handset or the telephone base can access the answering system at a time.
- While a handset is on a call, you cannot play messages.

To listen to messages at the telephone base:

1. Press ►/■/PLAY/STOP on the telephone base to listen to the messages.
2. The system announces the number of messages, then begins playback. The message sequence is shown on the message window.
3. Press ►/■/PLAY/STOP to stop the playback.



NOTE: If there are no messages in the answering system, when in Step 1 above, the system announces, "You have no message."

To listen to messages at the handset:

1. Press **MENU/SELECT** when in idle mode to enter the main menu.
2. Press **MENU/SELECT** to select **>PLAY MESSAGES**.
3. The system announces the number of messages, then begins playback. The message sequence is shown on the handset's screen.
4. Press **5** to stop the playback.

NOTE: If there are no messages in the answering system, the handset shows **NO MESSAGE** and announces, "You have no message."



Message playback

Options during playback

When a message is playing, you can adjust the playback volume, skip, repeat, or delete the message.

When messages are playing on the telephone base:

- Press **▼/▲/-VOLUME+** to adjust the message playback volume (1-8).
- To repeat the message currently playing, press **◀/REPEAT** after the answering system plays the date and time the current message was received.
- To listen to the previous messages, press **◀/REPEAT** while the answering system is playing the date and time the current message was received.
- Press **▶/SKIP** to skip to the next message.
- Press **X/DELETE** to delete the message. The telephone base announces, "Message deleted."
- Press **▶/■/PLAY/STOP** to stop the playback.



When messages are playing on the handset:

- Press **▲DIR/VOLUME** to increase or press **▼CID/VOLUME** to decrease the message playback volume.
- Press **📢/SPEAKER** to switch between speakerphone and handset.
- To repeat the message currently playing, press **4** after the answering system plays the date and time the current message was received.
- To listen to the previous messages, press **4** while the answering system is playing the date and time the current message was received.
- Press **6** to skip to the next message.
- Press **3** to delete the message. The handset announces, "Message deleted."
- Press **5** to stop playback.



Message playback

Delete all old messages

Use this feature to delete all old messages. Once deleted, you cannot retrieve the deleted messages. New (unheard) messages cannot be deleted until you have listened to them.

NOTE: If there are no old messages and you press **X/DELETE** twice on the telephone base, the system announces, "You have no old message." When you select **DELETE ALL OLD** on the handset, the screen shows **NO MESSAGE**.

To delete all old messages at the telephone base:

1. Press **X/DELETE** on the telephone base when the answering system is not in use. The system announces, "To delete all old messages, press **DELETE** again."
2. Press **X/DELETE** within 3 seconds. The system announces, "All old messages deleted."



To delete all old messages at the telephone handset:

1. Press **MENU/SELECT** when in idle mode to enter the main menu.
2. Press **▼CID** or **▲DIR** to scroll to **>ANSWERING SYS**, then press **MENU/SELECT**.
3. Press **▼CID** or **▲DIR** to scroll to **>DELETE ALL OLD**. Press **MENU/SELECT**. The screen shows **DELETE ALL OLD MESSAGES?**
4. Press **MENU/SELECT** to confirm. The screen shows **DELETING...** and then **ALL OLD MSGS DELETED!** with a confirmation tone.
-OR-
Press **OFF/CANCEL** to exit and leave all old messages intact.



Recording and playing memos

Memos are messages you record yourself. They are saved, played and deleted exactly like incoming messages. You can record a memo as a reminder to yourself, or leave a message for someone else using the same telephone. The maximum length of a memo is 3 minutes.

Record a memo

1. Press **MENU/SELECT** when in idle mode to enter the main menu.
2. Press **▼CID** or **▲DIR** to scroll to **>ANSWERING SYS**, then press **MENU/SELECT**.
3. Press **▼CID** or **▲DIR** to scroll to **>RECORD MEMO**.
4. Press **MENU/SELECT**. The system announces, "Record after the tone. Press 5 when you are done."
5. Speak towards the microphone on the handset after a long beep. You can record a memo up to 3 minutes. Memos shorter than 2 seconds are not recorded.
6. Press **5** to stop recording. The system announces "Recorded" to confirm the recording has finished.



NOTES:

- If the answering system memory is full, and you press **MENU/SELECT** while in Step 4, the answering system announces, "Memory is full." You need to delete some messages before you can record a memo.
- Memo also cannot be recorded when there is a handset or the base accessing the answering system.

Play back memos

Memos are stored as messages. See **Message playback** on page 47 for instructions on playback and deletion.

Message window displays

The message window on the telephone base displays the total number of messages. See the table below for other message window displays.

0	There are no messages in the answering system.
0 (flashing)	After a power failure, the number in the message window flashes to indicate that the date and time need to be set.
1-99	<ul style="list-style-type: none"> • Total number of messages and memos. • Current message number during old message playback.
1-99 (flashing)	<ul style="list-style-type: none"> • Total number of new messages and memos. The number flashes when there are new messages that have not been reviewed. • Current message number during new message playback. • After a power failure, the number in the message window flashes to indicate that the date and time need to be set.
1-99 and F (alternating)	Memory is full. Messages must be deleted before new messages can be recorded.
--	<ul style="list-style-type: none"> • The answering system is being programmed by a system handset. • The answering system is answering a call or recording a memo or announcement. • The answering system is being accessed remotely. • The directory or caller ID is being accessed by a system handset.
0-6	Telephone base ringer volume while adjusting.
1-8	Speaker volume level of the telephone base while adjusting.

Remote access

You can access the answering system remotely by dialing your home telephone number from any touch-tone telephone.

Remotely access the answering system

1. Dial your telephone number from any touch-tone telephone.
2. When the answering system answers, enter the 2-digit remote access code (**19**, by default; refer to **Remote access code** on page 42). The answering system automatically announces the number of messages (new or old) if there are any.
3. If there are new messages, the answering system automatically begins to play all new messages only.
-OR-
 If there are no new messages, the answering system automatically begins to play all old messages.
4. You can also enter the remote commands:

Play all messages 1	Press to listen to all messages. If there are new messages, the system plays only the new messages (in chronological order). If there are no new messages, the system plays all old messages (in chronological order).
Play new messages 2	Press to listen to new messages only.
Delete a message 3	Press during message playback to delete the current message.
Delete all old messages 33	Press to delete all old messages.
Replay the current or previous message 4	To repeat the message currently playing, press 4 after the answering system plays the day and time the current message was received. To listen to the previous message, press 4 while the answering system is playing the day and time the current message was received.
Stop 5	Press to stop playback and recording.
Play help menu TONEX5	Press to listen to a list of remote commands.
Skip to next message 6	Press during playback to skip the current message and advance to the next message.
Record an announcement TONEX7	Press to record a new announcement. Begin speaking after the long beep.
Turn system on or off 0	Press to turn the answering system on or off.
Exit 8 or hang up	Press to end remote access (the call ends).

Remote access

5. Hang up to end the call and save all messages.
- There is a wallet card listing the remote commands at the back of this user's manuals. Cut it out and keep it in your wallet for quick reference.









NOTES:

- If you do not enter a valid remote access code, there is no response until the correct code is entered.
- If the date and time are not set when a message is recorded, the system announces, "Time and date not set" before the answering system announces the number of messages.
- If there are no messages in the answering system, the system announces, "You have no message."
- If there are no new messages in the answering system and you press **2** to play new messages, the system announces, "You have no new message."
- Once the messages have played, the telephone announces the help menu options. If you do not press any key with 20 seconds, the remote access call ends automatically.
- If the memory is full, the answering system answers after 10 rings and announces, "Memory is full. Enter the remote access code." Enter your remote access code to access the messages and announcements.
- When the answering system is turned off, the telephone answers after 10 rings, and announces, "Please enter your remote access code."

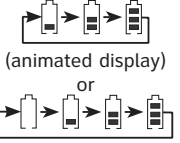
Screen icons, indicator lights and alert tones



Screen icons



 (flashing)	Low battery; place the handset in the telephone base or charger to charge.
	Indicates the battery charge level.
 (animated display) or (animated display)	Battery is charging.
	The speakerphone is in use.
	The handset ringer is turned off.
	New voicemail received from the telephone service provider.
ANS ON	The answering system is turned on.
	New message in the answering system.
NEW	While reviewing the caller ID history, calls that have not been reviewed.
MUTE	The microphone is muted.
	While playing messages, the sequence of the message currently playing. (XX/YY; XX is the number of the message currently playing; YY is the total number of all new or old messages.)

Handset indicator lights





	CHARGE light On when the handset is charging in the telephone base or charger.
	Backlight (lighted display and dial pad) On when a call is coming in. On when a key is pressed.
	SPEAKER light On when the speakerphone is in use.

Screen icons, indicator lights and alert tones

Telephone base indicator lights



	ANS. ON/OFF light On when the built-in answering system is on.
	IN USE light On when the handset is in use, when the answering system is answering an incoming call or when the answering system is being accessed remotely. Flashes slowly when another telephone on the same line is in use. Flashes quickly when there is an incoming call.

Handset alert tones

1 short beep (Key tone or playback confirmation tone)	A key is pressed. Plays at the end of each message.
1 long beep (Recording or playback confirmation tone)	Beginning or end of recording. Plays at the end of all messages.
2 short beeps (Error tone)	The command has failed. You have reached the beginning or end of the list. You have reached the minimum or maximum listening volume.
3 short beeps (Out-of-range or no-power-at-base warning tone)	The handset is out of range or there is no power at the telephone base.
3 short high-pitched beeps (Confirmation tone)	The telephone has completed the command successfully.
4 short beeps (Low-battery warning tone)	Low battery warning.

Telephone base alert tones

One short beep (Playback confirmation tone)	Plays at the end of each message.
Beeps every 10 seconds (Message alert tone)	Message alert tone is on and there are new messages.
One long beep (Recording or playback confirmation tone)	Call screening is on and the answering system is about to record a message. Plays at the end of all messages.

Handset display screen messages

CALL LOG EMPTY	You are accessing an empty caller ID history.
CALL TRANSFERRED	You have transferred an outside call to another cordless handset.
CALLING HANDSET X (For EL52301/EL52351/ EL52401/EL52501) CALLING OTHER HANDSET (For EL52201/EL52251)	The handset is calling another handset (for intercom calls).
COPY FROM DIRECTORY	The handset is loading the directory entries for the speed dial assignments.
DIRECTORY EMPTY	There are no directory entries.
DIRECTORY FULL	The directory is full. You cannot save any new entries unless you delete some current entries.
ENDED	You have just ended a call.
HANDSET X IS CALLING	Another handset is calling.
INCOMING CALL	There is a call coming in.
INTERCOM	The handset is on an intercom call.
INTERCOM ENDED	The intercom call is just ended.
INTERCOM TO: (For EL52301/EL52351/ EL52401/EL52501)	You have started the intercom process, and need to enter the number of the handset you wish to call.
LINE IN USE	An extension telephone on the same line or one of the handsets is in use.
LOW BATTERY	The battery needs to be charged.
MICROPHONE ON	Mute is off so the other party can hear your voice.
MUTED	The microphone is off.
NEW VOICEMAIL	There are new voicemail messages from your telephone service provider.
NO BATTERY	The handset in the telephone base or charger does not have a battery properly installed.
NO LINE	There is no telephone line connected.
NO MESSAGE	There are no messages in the answering system.

Handset display screen messages

NOT AVAILABLE AT THIS TIME	Someone else is already using the directory, speed dial list, caller ID history or answering system.
NUMBER ALREADY SAVED	The telephone number you have entered is already stored in the directory.
OTHER HANDSET IS CALLING (For EL52201/EL52251)	The other handset is calling.
OUT OF RANGE OR NO PWR AT BASE	The handset has lost communication with the telephone base.
OUTSIDE CALL	You switch to an external call during an intercom call.
PAGING	The telephone base is paging all handsets.
PHONE	The handset is on a call.
PLACE IN CHARGER	The battery is very low. The handset should be placed in the telephone base or charger.
REC MEM LOW	The answering system has less than 3 minutes to record.
REC MEM FULL	The answering system memory is full.
RINGER MUTED	The ringer is muted temporarily during an incoming call.
SAVED	An entry has been successfully saved in the directory.
SPEAKER	The handset speakerphone is in use.
UNABLE TO CALL. LINE IN USE	You cannot dial out a number when the line is in use.
UNABLE TO CALL. TRY AGAIN	<ul style="list-style-type: none"> • Intercom failed. • 4 handsets are already on a call. • The handset loses its connection to the telephone base but its battery status is in low battery mode or greater.
UNABLE TO SAVE	You cannot save a caller ID history entry to the directory without a number.
XX MISSED CALLS	There are XX new calls in the caller ID history.
XX NEW MESSAGES	There are XX new messages in the answering system.

Troubleshooting

If you have difficulty with your telephone, please try the suggestions below. For customer service, or to purchase accessories or replacement parts, visit our website at www.telephones.att.com, or call **1 (800) 222-3111**. In Canada, dial **1 (866) 288-4268**. When you call customer service, you will need the serial number or model number found on the bottom of the telephone base.

My telephone doesn't work at all.

- Make sure the power cord is securely plugged in.
- Make sure that the battery connector is securely plugged into the cordless handset.
- Make sure the telephone line cord is securely and firmly plugged into the telephone base and the telephone wall jack.
- Charge the battery in the cordless handset for at least 10 hours. For optimum daily performance, return the cordless handset to the telephone base or charger when not in use.
- If the battery is depleted, charge the handset for at least 30 minutes before you use it. Refer to **Battery charging** on page 6 for details.
- Reset the telephone base. Unplug the electrical power. Wait for approximately 15 seconds, then plug it back in. Allow up to one minute for the cordless handset and telephone base to reset.
- You may need to purchase a new battery. Please refer to **Battery installation** on page 5.

I cannot get a dial tone.

- First try all of the suggestions above.
- Move the cordless handset closer to the telephone base. You might have moved out of range.
- If the previous suggestions don't work, disconnect the telephone base from the telephone wall jack and connect to a different telephone. If there is no dial tone on that handset either, the problem is in your wiring or telephone service. Contact your telephone service provider (charges may apply).
- Your telephone line cord might be defective. Try installing a new telephone line cord.

I cannot dial out.

- First try all the suggestions in the item **I cannot get a dial tone** above.

Troubleshooting

- Make sure you have a dial tone before dialing. The cordless handset may take a second or two to find the telephone base and produce a dial tone. This is normal. Wait an extra second before dialing.
- Check that all the telephones connected to the same telephone line are hung up.
- Make sure to set the dial mode to the correct setting (pulse dialing or tone dialing) for the service in your area (see **Battery installation and charging** on pages 5-6).
- Eliminate any background noise. Noise from a television, radio or other appliances may cause the telephone not to dial out properly. If you cannot eliminate the background noise, first try muting the cordless handset before dialing, or dialing from another room with less background noise.
- If other telephones in your home are having the same problem, the problem is in your wiring or telephone service. Contact your telephone service provider (charges may apply).

My cordless handset isn't performing normally.

- Make sure the power cord is securely plugged into the telephone base. Plug the power adapter into a different, working electrical outlet not controlled by a wall switch.
- Move the cordless handset closer to the telephone base. You might have moved out of range.
- Reset the telephone base. Unplug the electrical power. Wait for 15 seconds then plug it back in. Allow up to one minute for the cordless handset and telephone base to reset.
- Other electronic products such as HAM radios and other DECT phones can cause interference to your cordless telephone. Try installing your telephone as far away as possible from these types of electronic devices.

OUT OF RANGE OR NO PWR AT BASE appears on my cordless handset.

- Ensure that the telephone base is powered on.
- Place the cordless handset in the telephone base for one minute to allow the cordless handset and base to synchronize.
- Move the cordless handset closer to the telephone base. You might have moved out of range.
- Reset the telephone base. Unplug the electrical power. Wait for 15 seconds then plug it back in. Allow up to one minute for the cordless handset and telephone base to reset.

Troubleshooting

- Other electronic products such as HAM radios and other DECT phones can cause interference to your cordless telephone. Try installing your telephone as far away as possible from these types of electronic devices.

The batteries do not hold a charge.

- If the cordless handset is in the telephone base or charger and the charge light does not come on, refer to the item **The charge light is off** on this page.
- Charge the battery in the cordless handset for at least 10 hours. For optimum daily performance, return the cordless handset to the telephone base or charger when not in use.
- If the battery is depleted, it may take approximately 30 minutes to charge the handset before it shows **LOW BATTERY**. Refer to **Battery charging** on page 6 for details.
- You may need to purchase a new battery. Please refer to **Battery installation** on page 5.

The charge light is off.

- Make sure the power cord is plugged in correctly and securely.
- Make sure the battery is installed correctly in the handset. Follow the instruction in **Battery installation** on page 5 to install the battery.
- Unplug the electrical power. Wait for 15 seconds then plug it back in. Allow up to one minute for the cordless handset and telephone base to reset.
- Clean the cordless handset and telephone base charging contacts each month using a pencil eraser or cloth.

I get noise, static, or weak signals even when I'm near the telephone base.

- If you subscribe to high-speed Internet service (DSL - digital subscriber line) through your telephone line, you must install a DSL filter between the telephone line cord and the telephone wall jack (see **Telephone base and charger installation** on page 4). The filter prevents noise and caller ID problems caused by DSL interference. Please contact your DSL service provider for more information about DSL filters.
- Other electronic products such as HAM radios and other DECT phones can cause interference to your cordless telephone. Try installing your telephone as far away as possible from these types of electronic devices.
- Do not install this telephone near a microwave oven or on the same electrical outlet. You may experience decreased performance while the microwave oven is operating.

Troubleshooting

- If your telephone is plugged in with a modem or a surge protector, plug the telephone (or modem/surge protector) into a different location. If this doesn't solve the problem, relocate your telephone or modem farther apart from one another, or use a different surge protector.
- Relocate your telephone to a higher location. The telephone will likely have better reception when installed in a high area.
- If the other telephones in your home are having the same problem, the problem is in your wiring or telephone service. Contact your telephone service provider (charges may apply).

I experience poor sound quality when using the speakerphone.

- For increased sound quality while using the speakerphone, place the handset on a flat surface with the dial pad facing up.
- When using a speakerphone, controlling background noise in your environment is essential. While you are listening to your party, press **MUTE/DELETE** to temporarily turn your microphone off. When it is your turn to speak, remember to press **MUTE/DELETE** again to turn the microphone on.
- Excessive background noise will cause a speakerphone to fade in and out. Try controlling the background noise by turning off any audio devices near the speakerphone. Also, try to avoid interrupting the person at the other end of the conversation while they are speaking. If background noise cannot be controlled, you should terminate speakerphone operation and return to normal handset mode.

I hear other calls while using my telephone.

- Disconnect the telephone base from the telephone wall jack, and plug in a different telephone. If you still hear other calls, the problem is probably in your wiring or telephone service. Call your telephone service provider (charges may apply).

My calls cut in and out while I'm using my cordless handset.

- Other electronic products such as HAM radios and other DECT phones can cause interference to your cordless telephone. Try installing your telephone as far away as possible from these types of electronic devices.
- Move the handset closer to the base. The operating range may vary with environmental conditions and time of use. There may be places within your environment that a cordless telephone will not work well. If the problem only occurs in certain areas of your environment, you can conclude that there is nothing wrong with the telephone.

Troubleshooting

- Do not install this telephone near a microwave oven or on the same electrical outlet. You may experience decreased performance while the microwave oven is operating.
- If your telephone is plugged in with a modem or surge protector, plug the telephone (or modem/surge protector) into a different location. If this doesn't solve the problem, relocate your telephone or modem farther apart from one another, or use a different surge protector.
- Relocate your telephone base to a higher location. The telephone will have better reception when installed in a high area.
- If the other telephones in your home are having the same problem, the problem is in your wiring or telephone service. Contact your telephone service provider (charges may apply).
- If you subscribe to high-speed Internet service (DSL - digital subscriber line) through your telephone line, you must install a DSL filter between the telephone line cord and the telephone wall jack (see **Telephone base and charger installation** on page 4). The filter prevents noise and caller ID problems caused by DSL interference. Please contact your DSL service provider for more information about DSL filters.

My cordless handset does not ring when I receive a call.

- Make sure that the ringer is not turned off. Refer to **Ringer volume** on page 11.
- Make sure the telephone line cord is plugged securely into the telephone base and the telephone wall jack. Make sure the power cord is securely plugged in.
- The cordless handset may be too far from the telephone base.
- Charge the battery in the cordless handset for at least 10 hours. For optimum daily performance, return the cordless handset to the telephone base or charger when not in use.
- You may have too many extension telephones on your telephone line to allow all of them to ring simultaneously. Try unplugging one telephone at a time until the telephone start ringing.
- The layout of your home or office might be limiting the operating range. Try moving the telephone base to another location, preferably on an upper floor.
- If the other telephones in your home are having the same problem, the problem is in your wiring or telephone service. Contact your telephone service provider (charges may apply).

Troubleshooting

- Test a working telephone at the telephone wall jack. If another telephone has the same problem, the problem is the telephone wall jack. Contact your telephone service provider (charges may apply).
- Other electronic products such as HAM radios and other DECT phones can cause interference to your cordless telephone. Try installing your telephone as far away as possible from these types of electronic devices.
- Completely remove then replace the battery. Place the cordless handset in the telephone base. Wait for the cordless handset to reestablish its connection with the telephone base. Allow up to one minute for this to take place.
- Your telephone line cord might be defective. Try installing a new telephone line cord.

My caller ID isn't working.

- Caller ID is a subscription service. You must subscribe to this service from your telephone service provider for this feature to work on your telephone.
- Your caller must be calling from an area that supports caller ID.
- Both your and your caller's telephone service providers must use caller ID compatible equipment.
- Make sure the home area code is set correctly in the telephone (see **Home area code** on page 14).
- If you subscribe to high-speed Internet service (DSL - digital subscriber line) through your telephone line, you must install a DSL filter between the telephone line and the telephone wall jack (see **Telephone base and charger installation** on page 4). The filter prevents noise and caller ID problems caused by DSL interference. Please contact your DSL service provider for more information about DSL filters.

My telephone does not receive caller ID when on a call.

- Make sure you subscribe to caller ID with call waiting features provided by your telephone service provider. Caller ID features work only if both you and the caller are in areas offering caller ID service, and if both telephone service providers use compatible equipment.

Troubleshooting

A icon shows on the display and I don't know why.

- Your telephone has voicemail indication that is separate from the built-in answering system. If  appears on the display, then your telephone has received a signal from your telephone service provider that you have a voicemail message waiting for you to retrieve from your telephone service provider. Contact your telephone service provider for more information on how to access your voicemail.

I cannot retrieve voicemail messages.

- Your telephone has both a built-in answering system and voicemail indication. They are independent features and each alerts you to new messages differently (see **Answering system and voicemail indicators** on page 44). If you subscribe to voicemail service from your telephone service provider (charges may apply), contact your telephone service provider for more information on how to access your voicemail.

Incomplete messages.

- If a caller leaves a very long message, part of it may be lost when the system disconnects the call after the maximum recording time you have set (see **Recording time** on page 43).
- If the caller pauses for longer than 7 seconds, the answering system stops recording and disconnects the call.
- If the answering system's memory becomes full during a message, the answering system stops recording and disconnects the call.
- If the caller's voice is very soft, the answering system may stop recording and disconnects the call.
- If someone picks up the call at a telephone on the same line during a message, the answering system stops recording and disconnects the call. Part of the message may be lost.

Difficulty hearing messages.

- Press **▼/▲/-VOLUME+** to adjust the speaker volume on the telephone base.
- Press **▲DIR/VOLUME** to increase the message playback volume on a handset.

The answering system does not answer after correct number of rings.

- Make sure the answering system is on. When the answering system is on, **ANS ON** should show on the handset and the /ANS. ON/OFF light is lit on the telephone base (see **Answer on/off** on page 40).
- If toll saver is selected, the number of rings changes to 2 when there are new messages (see **Number of rings** on page 41).

Troubleshooting

- If the memory is full or the answering system is off, the answering system answers after 10 rings.
- In some cases, the answering system is affected by the ringing system used by the telephone service provider.
- If you subscribe to voicemail service, change the number of rings so that your answering system answers before your voicemail answers (see **Answering system and voicemail indicators** on page 44). To determine how many rings activate your voicemail, contact your telephone service provider.
- If there is a fax machine connected to the same telephone line, try disconnecting the fax machine. If that solves the problem, consult your fax machine documentation for information on compatibility with answering systems.

The answering system announces "Time and date not set."

- You need to reset the date and time (see **Set date/time** on page 13).

The answering system does not respond to the remote commands.

- Make sure to enter your remote access code correctly (see **Remote access code** on page 42).
- Make sure you are calling from a touch-tone telephone. When you dial a number, you should hear tones. If you hear clicks, the telephone is not a touch-tone telephone and cannot activate the answering system.
- The answering system may not detect the remote access code while your announcement is playing. Try waiting until the announcement is over before entering the code.
- There may be interference on the telephone line you are using. Press dialing keys firmly.

The answering system does not record messages.

- Make sure the answering system is on (see **Answer on/off** on page 40).
- Make sure the memory of the answering system is not full. When the answering machine memory is full, it does not record new messages until some old messages are deleted.
- If you subscribe to voicemail service, change the number of rings so that your answering system answers before your voicemail answers (see **Answering system and voicemail indicators** on page 44). To determine how many rings activate your voicemail, contact your telephone service provider.

Troubleshooting

- If there is a fax machine connected to the same telephone line, try disconnecting the fax machine. If that solves the problem, consult your fax machine documentation for information on compatibility with answering systems.

Announcement is not clear.

- When you record your announcement, make sure you speak in a normal tone of voice, toward the microphone on the handset.
- Make sure there is no background noise (TV, music, etc.) while recording.

I subscribe to a nontraditional telephone service that uses my computer to establish connections, and my telephone doesn't work.

- Make sure your computer is powered on.
- Make sure your Internet connection is working properly.
- Make sure that the software is installed and running for your nontraditional telephone service.
- Make sure to plug your USB port adapter into a dedicated USB port on your computer. Do not plug into a multiple port USB hub (USB splitter) that is not powered.
- In a few rare instances, the USB port on your computer may not have enough power. In these instances, try using a USB hub with its own external power supply.
- If you are using a firewall, it may prevent access to your nontraditional telephone service. Contact your service provider for more information.

Common cure for electronic equipment:

If the telephone is not responding normally, try resetting the telephone. Do the following in the order listed.

1. Disconnect the power to the telephone base.
2. Disconnect the cordless handset battery, and spare battery, if applicable.
3. Wait a few minutes.
4. Connect power to the telephone base.
5. Completely remove then replace the battery. Place the cordless handset into the telephone base.
6. Wait for the cordless handset to reestablish its connection with the telephone base. Allow up to one minute for this to take place.

Maintenance

Taking care of your telephone

- Your cordless telephone contains sophisticated electronic parts, so it must be treated with care.
- Avoid rough treatment.
- Place the handset down gently.
- Save the original packing materials to protect your telephone if you ever need to ship it.

Avoid water

- Your telephone can be damaged if it gets wet. Do not use the handset in the rain, or handle it with wet hands. Do not install the telephone base near a sink, bathtub or shower.

Electrical storms

- Electrical storms can sometimes cause power surges harmful to electronic equipment. For your own safety, take caution when using electric appliances during storms.

Cleaning your telephone

- Your telephone has durable plastic casing that should retain its luster for many years. Clean it only with a soft cloth slightly dampened with water or mild soap.
- Do not use excess water or cleaning solvents of any kind.

Remember that electrical appliances can cause serious injury if used when you are wet or standing in water. If the telephone base should fall into water, DO NOT RETRIEVE IT UNTIL YOU UNPLUG THE POWER CORD AND TELEPHONE LINE CORDS FROM THE WALL. Then pull the telephone out by the unplugged cords.

Important safety information



This symbol is to alert you to important operating or servicing instructions that may appear in this user's manual. Always follow basic safety precautions when using this product to reduce the risk of injury, fire, or electric shock.

Safety information

- **Read and understand all instructions in the user's manual. Observe all markings on the product.**
- **Avoid using a telephone during a thunderstorm.** There might be a slight chance of electric shock from lightning.
- **Do not use a telephone in the vicinity of a gas leak.** Under certain circumstances, a spark may be created when the adapter is plugged into the power outlet, or when the handset is replaced in its cradle. This is a common event associated with the closing of any electrical circuit. The user should not plug the phone into a power outlet, and should not put a charged handset into the cradle, if the phone is located in an environment containing concentrations of flammable or flame-supporting gases, unless there is adequate ventilation. A spark in such an environment could create a fire or explosion. Such environments might include: medical use of oxygen without adequate ventilation; industrial gases (cleaning solvents; gasoline vapors; etc.); a leak of natural gas; etc.
- **Do not use this product near water, or when you are wet.** For example, do not use it in a wet basement or shower, or next to a swimming pool, bathtub, kitchen sink, or laundry tub. Do not use liquids or aerosol sprays for cleaning. If the product comes in contact with any liquids, unplug any line or power cord immediately. Do not plug the product back in until it has dried thoroughly.
- **Install this product in a protected location** where no one can trip over any line or power cords. Protect cords from damage or abrasion.
- **If this product does not operate normally, read Troubleshooting on pages 58-66 in this user's manual.** If you cannot solve the problem, or if the product is damaged, refer to **Limited warranty** on pages 72-73. Do not open this product except as may be directed in your user's manual. Opening the product or reassembling it incorrectly may expose you to hazardous voltages or other risks.
- **Replace batteries only as described in Battery installation and charging on pages 5-6 in your user's manual.** Do not burn or puncture batteries — they contain caustic chemicals.
- **The power adapters are intended to be correctly oriented in a vertical or floor mount position.** The prongs are not designed to hold the plug in place if they are plugged into a ceiling or an under-the-table or cabinet outlet.



CAUTION: Use only the power adapters provided with this product. To obtain a replacement, visit our website at www.telephones.att.com, or call

1 (800) 222-3111. In Canada, dial **1 (866) 288-4268.**

Especially about cordless telephones

- **Privacy:** The same features that make a cordless telephone convenient create some limitations. Telephone calls are transmitted between the telephone base and the handset by radio waves, so there is a possibility that your cordless telephone conversations could be intercepted by radio receiving equipment within range of the cordless handset. **For this reason, you should not think of cordless telephone conversations as being as private as those on corded telephones.**

Important safety information

- **Electrical power:** The telephone base of this cordless telephone must be connected to a working electrical outlet which is not controlled by a wall switch. **Calls cannot be made from the handset if the telephone base is unplugged, switched off or if the electrical power is interrupted.**
- **Potential TV interference:** Some cordless telephones operate at frequencies that may cause interference to TVs and VCRs. To minimize or prevent such interference, do not place the telephone base of the cordless telephone near or on top of a TV or VCR. If interference is experienced, moving the cordless telephone farther away from the TV or VCR will often reduce or eliminate the interference.
- **Rechargeable batteries:** This product contains nickel-metal hydride rechargeable batteries. Exercise care in handling batteries in order not to create a short circuit with conductive material such as rings, bracelets, and keys. The battery or conductor may overheat and cause harm. Observe proper polarity between the battery and the battery charger.
- **Nickel-metal hydride rechargeable batteries:** Dispose of these batteries in a safe manner. Do not burn or puncture. Like other batteries of this type, if burned or punctured, they could release caustic material which could cause injury.



The RBRC™ Seal means that the manufacturer is voluntarily participating in an industry program to collect and recycle nickel-metal hydride rechargeable batteries when taken out of service within the United States. These batteries may be taken to a participating local retailer of replacement batteries or recycling center. Or you may call 1 (800) 8-BATTERY for locations accepting spent Ni-MH batteries.

Precautions for users of implanted cardiac pacemakers

Cardiac pacemakers (applies only to digital cordless telephones): Wireless Technology Research, LLC (WTR), an independent research entity, led a multidisciplinary evaluation of the interference between portable wireless telephones and implanted cardiac pacemakers. Supported by the U.S. Food and Drug Administration, WTR recommends to physicians that:

Pacemaker patients

- Should keep wireless telephones at least six inches from the pacemaker.
 - Should NOT place wireless telephones directly over the pacemaker, such as in a breast pocket, when it is turned ON.
 - Should use the wireless telephone at the ear opposite the pacemaker.
- WTR's evaluation did not identify any risk to bystanders with pacemakers from other persons using wireless telephones.

Especially about telephone answering systems

Two-way recording: This unit does not sound warning beeps to inform the other party that the call is being recorded. To ensure that you are in compliance with any federal or state regulations regarding recording a telephone call, you should start the recording process and then inform the other party that you are recording the conversation.

SAVE THESE INSTRUCTIONS

FCC Part 68 and ACTA

This equipment complies with Part 68 of the FCC rules and with technical requirements adopted by the Administrative Council for Terminal Attachments (ACTA). The label on the back or bottom of this equipment contains, among other things, a product identifier in the format US: AAAEQ##TXXXX. This identifier must be provided to your telephone service provider upon request.

The plug and jack used to connect this equipment to premises wiring and the telephone network must comply with the applicable Part 68 rules and technical requirements adopted by ACTA. A compliant telephone cord and modular plug is provided with this product. It is designed to be connected to a compatible modular jack that is also compliant. An RJ11 jack should normally be used for connecting to a single line and an RJ14 jack for two lines. See Installation Instructions in the user's manual.

The Ringer Equivalence Number (REN) is used to determine how many devices you may connect to your telephone line and still have them ring when you are called. The REN for this product is encoded as the 6th and 7th characters following the US: in the product identifier (e.g., if ## is 03, the REN is 0.3). In most, but not all areas, the sum of all RENs should be five (5.0) or less. For more information, please contact your telephone service provider.

This equipment may not be used with Party Lines. If you have specially wired alarm dialing equipment connected to your telephone line, ensure the connection of this equipment does not disable your alarm equipment. If you have questions about what will disable the alarm equipment, consult your telephone service provider or a qualified installer.

If this equipment is malfunctioning, it must be unplugged from the modular jack until the problem has been corrected. Repairs to this telephone equipment can only be made by the manufacturer or its authorized agents. For repair procedures, follow the instructions outlined under the Limited Warranty.

If this equipment is causing harm to the telephone network, the telephone service provider may temporarily discontinue your telephone service. The telephone service provider is required to notify you before interrupting service. If advance notice is not practical, you will be notified as soon as possible. You will be given the opportunity to correct the problem and the telephone service provider is required to inform you of your right to file a complaint with the FCC. Your telephone service provider may make changes in its facilities, equipment, operation, or procedures that could affect the proper functioning of this product. The telephone service provider is required to notify you if such changes are planned.

If this product is equipped with a corded or cordless handset, it is hearing aid compatible.

If this product has memory dialing locations, you may choose to store emergency telephone numbers (e.g., police, fire, medical) in these locations. If you do store or test emergency numbers, please:

- Remain on the line and briefly explain the reason for the call before hanging up.
- Perform such activities in off-peak hours, such as early morning or late evening.

Industry Canada

Operation is subject to the following two conditions: (1) this device may not cause harmful interference, and (2) this device must accept any interference, including interference that may cause undesired operation.

The term "IC:" before the certification/registration number only signifies that the Industry Canada technical specifications were met.

The Ringer Equivalence Number (REN) for this terminal equipment is 0.1B. The REN is an indication of the maximum number of devices allowed to be connected to a telephone interface. The termination on an interface may consist of any combination of devices subject only to the requirement that the sum of the RENs of all the devices does not exceed five.

This product meets the applicable Industry Canada technical specifications.

FCC Part 15

This equipment has been tested and found to comply with the requirements for a Class B digital device under Part 15 of the Federal Communications Commission (FCC) rules.

These requirements are intended to provide reasonable protection against harmful interference in a residential installation. This equipment generates, uses and can radiate radio frequency energy and, if not installed and used in accordance with the instructions, may cause harmful interference to radio communications. However, there is no guarantee that interference will not occur in a particular installation.

If this equipment does cause harmful interference to radio or television reception, which can be determined by turning the equipment off and on, the user is encouraged to try to correct the interference by one or more of the following measures:

- Reorient or relocate the receiving antenna.
- Increase the separation between the equipment and receiver.
- Connect the equipment into an outlet on a circuit different from that to which the receiver is connected.
- Consult the dealer or an experienced radio/TV technician for help.

Changes or modifications to this equipment not expressly approved by the party responsible for compliance could void the user's authority to operate the equipment.

This device complies with Part 15 of the FCC rules. Operation is subject to the following two conditions: (1) this device may not cause harmful interference, and (2) this device must accept any interference received, including interference that may cause undesired operation. Privacy of communications may not be ensured when using this telephone.

To ensure safety of users, the FCC has established criteria for the amount of radio frequency energy that can be safely absorbed by a user or bystander according to the intended usage of the product. This product has been tested and found to comply with the FCC criteria. The handset may be safely held against the ear of the user. The telephone base shall be installed and used such that parts of the user's body other than the hands are maintained at a distance of approximately 20cm (8 inches) or more.

This Class B digital apparatus complies with Canadian ICES-003.

Limited warranty

The AT&T brand is used under license - any repair, replacement or warranty service, and all questions about this product should be directed to our website at

www.telephones.att.com or call **1 (800) 222-3111**. In Canada, dial **1 (866) 288-4268**.

1. What does this limited warranty cover?

The manufacturer of this AT&T branded product warrants to the holder of a valid proof of purchase ("CONSUMER" or "you") that the product and all accessories provided in the sales package ("PRODUCT") are free from defects in material and workmanship, pursuant to the following terms and conditions, when installed and used normally and in accordance with the PRODUCT operating instructions. This limited warranty extends only to the CONSUMER for products purchased and used in the United States of America and Canada.

2. What will be done if the PRODUCT is not free from defects in materials and workmanship during the limited warranty period ("materially defective PRODUCT")?

During the limited warranty period, the manufacturer's authorized service representative repairs or replaces at the manufacturer's option, without charge, a materially defective PRODUCT. If the manufacturer repairs the PRODUCT, they may use new or refurbished replacement parts. If the manufacturer chooses to replace the PRODUCT, they may replace it with a new or refurbished PRODUCT of the same or similar design. The manufacturer retains the defective parts, modules, or equipment. Repair or replacement of the PRODUCT, at the manufacturer's option, is your exclusive remedy. The manufacturer returns the repaired or replacement products to you in working condition. You should expect the repair or replacement to take approximately 30 days.

3. How long is the limited warranty period?

The limited warranty period for the PRODUCT extends for ONE (1) YEAR from the date of purchase. If the manufacturer repairs or replaces a materially defective PRODUCT under the terms of this limited warranty, this limited warranty also applies to repaired or replacement PRODUCT for a period of either (a) 90 days from the date the repaired or replacement PRODUCT is shipped to you or (b) the time remaining on the original one-year limited warranty; whichever is longer.

4. What is not covered by this limited warranty?

This limited warranty does not cover:

- PRODUCT that has been subjected to misuse, accident, shipping or other physical damage, improper installation, abnormal operation or handling, neglect, inundation, fire, water, or other liquid intrusion; or
- PRODUCT that has been damaged due to repair, alteration, or modification by anyone other than an authorized service representative of the manufacturer; or
- PRODUCT to the extent that the problem experienced is caused by signal conditions, network reliability or cable or antenna systems; or
- PRODUCT to the extent that the problem is caused by use with non-AT&T accessories; or
- PRODUCT whose warranty/quality stickers, PRODUCT serial number plates or electronic serial numbers have been removed, altered or rendered illegible; or
- PRODUCT purchased, used, serviced, or shipped for repair from outside the United States of America or Canada, or used for commercial or institutional purposes (including but not limited to products used for rental purposes); or
- PRODUCT returned without a valid proof of purchase (see item 6 below); or
- Charges for installation or setup, adjustment of customer controls, and installation or repair of systems outside the unit.

Limited warranty

5. How do you get warranty service?

To obtain warranty service in the United States of America, visit

www.telephones.att.com or call **1 (800) 222-3111**. In Canada, dial **1 (866) 288-4268**. NOTE: Before calling for service, please review the user's manual. A check of the PRODUCT's controls and features might save you a service call.

Except as provided by applicable law, you assume the risk of loss or damage during transit and transportation and are responsible for delivery or handling charges incurred in the transport of the PRODUCT(s) to the service location. The manufacturer will return repaired or replaced PRODUCT under this limited warranty. Transportation, delivery or handling charges are prepaid. The manufacturer assumes no risk for damage or loss of the PRODUCT in transit. If the PRODUCT failure is not covered by this limited warranty, or proof of purchase does not meet the terms of this limited warranty, the manufacturer notifies you and requests that you authorize the cost of repair prior to any further repair activity. You must pay for the cost of repair and return shipping costs for the repair of products that are not covered by this limited warranty.

6. What must you return with the PRODUCT to get warranty service?

You must:

- a. Return the entire original package and contents including the PRODUCT to the service location along with a description of the malfunction or difficulty; and
- b. Include a "valid proof of purchase" (sales receipt) identifying the PRODUCT purchased (PRODUCT model) and the date of purchase or receipt; and
- c. Provide your name, complete and correct mailing address, and telephone number.

7. Other limitations

This warranty is the complete and exclusive agreement between you and the manufacturer of this AT&T branded PRODUCT. It supersedes all other written or oral communications related to this PRODUCT. The manufacturer provides no other warranties for this PRODUCT. The warranty exclusively describes all of the manufacturer's responsibilities regarding the PRODUCT. There are no other express warranties. No one is authorized to make modifications to this limited warranty and you should not rely on any such modification.

State/Provincial Law Rights: This warranty gives you specific legal rights, and you might also have other rights that vary from state to state or province to province.

Limitations: Implied warranties, including those of fitness for a particular purpose and merchantability (an unwritten warranty that the PRODUCT is fit for ordinary use) are limited to one year from date of purchase. Some states/provinces do not allow limitations on how long an implied warranty lasts, so the above limitation might not apply to you. In no event shall the manufacturer be liable for any indirect, special, incidental, consequential, or similar damages (including, but not limited to lost profits or revenue, inability to use the PRODUCT or other associated equipment, the cost of substitute equipment, and claims by third parties) resulting from the use of this PRODUCT. Some states/provinces do not allow the exclusion or limitation of incidental or consequential damages, so the above limitation or exclusion might not apply to you.

Please retain your original sales receipt as proof of purchase.

Technical specifications

RF frequency band	1921.536MHz — 1928.448MHz
Channels	5
Operating temperature	32°F — 122°F 0°C — 50°C
Telephone base voltage (AC voltage, 60Hz)	96 — 130Vrms
Telephone base voltage (DC adapter output)	DC6V @ 400mA
Handset voltage	2.4 — 3.2VDC
Charger voltage (AC adapter output)	AC6V @ 300mA
Operating times*	Talk time (handset): up to 7 hours Talk time (speakerphone): up to 4 hours Standby: up to 5 days

*Operating time varies depending on your actual use and the age of battery.

DECT 6.0 digital technology

Telecommunications (DECT) 6.0 is a new frequency band that transmits your voice across multiple channels. This technology provides superior quality of voice and sound, high protection against wiretapping and better range than 2.4 GHz and 5.8 GHz phone systems, while not interfering with wireless routers.

Telephone operating range

This cordless telephone operates within the maximum power allowed by the Federal Communications Commission (FCC). Even so, this handset and telephone base can communicate over only a certain distance — which can vary with the locations of the telephone base and handset, the weather, and the construction of your home or office.

Index

A

Alert tones, 54
Alphabetical search, 29
Announcement, 39
Answer a call, 17
Answer an incoming call during an intercom call, 24
Answering mode, 40
Answering system, 39–42
Area code, 14, 33

B

Base ringer volume (ringer volume control), 15
Base volume control, 15, 46
Battery charging, 6
Battery installation, 5

C

Caller ID, 33
Caller ID history (call log), 34–38
Call intercept, 46
Call screening, 41, 45
Call transfer (intercom transfer), 25
Call waiting, 33
Chain dialing, 21
Character chart, 28
Charger installation, 4
Clock, 13

D

Date and time, 13
Delete all caller ID history, 37
Delete messages, 49
Dial a number from caller ID history, 37

Dial a speed dial number, 32
Dialing options, 36
Dial mode, 14
Directory, 26–30
Directory storage, 26
DSL filter, 1

E

Elapsed time, 16
End a call, 17

F

Flash, 20

H

Handset locator, 23
Handset ringer tone (selectable ringer tone), 11
Handset ringer volume (ringer volume control), 11

I

Important safety information, 68
Intercom call (intercom between handsets), 24

K

Key tone, 13

L

LCD language, 11
Limited warranty, 72

M

Maintenance, 67
Making a call, 16
Memo, 50
Memory match, 34

Index

Menu, 10
Message playback, 47–49
Message window displays, 51
Missed (new) calls indicator, 35
Mute, 20

N

Number of rings, 41

P

Pause, 16
Predialing (on-hook dialing), 16

R

Reasons for missing caller ID information, 35
Recording time, 45
Redial, 18–19
Remote access, 52
Remote access code, 42
Remote commands, 52
Repeat messages, 48, 52
Ringer tone, 11

S

Screen icons, 54
Skip messages, 48, 52
Speakerphone switching, 17, 39
Speed dial, 26, 31–32

T

Tabletop installation, 9
Technical specifications, 74
Temporary ringer silencing, 16
Temporary tone dialing, 21
Troubleshooting, 58

V

Voicemail, 12
Voice prompts, 45
Volume, 11, 15, 20

W

Wall mount installation, 7

Remote access wallet card

The wallet card below lists the commands needed to control your answering system from any touch-tone telephone.

Cut along dotted line.



Call your telephone number, then enter your 2-digit remote access code (preset to **19**).

Action	Remote command
Play all messages	1
Play new messages.....	2
Delete the message.....	3 (during message playback)
Delete all messages.....	33
Repeat or go back.....	4
Stop.....	5
Help menu	TONEX5
Skip the message.....	6
Record announcement	TONEX7
Turn system on or off	0
End remote access call.....	8 (or hang up)

EL52201/EL52251/EL52301/EL52351/EL52401/EL52501 DECT 6.0 cordless telephone/answering system with caller ID/call waiting

© 2010-2011 Advanced American Telephones. All Rights Reserved. AT&T and the AT&T logo are trademarks of AT&T Intellectual Property licensed to Advanced American Telephones, San Antonio, TX 78219. Printed in China.

Fold here.



www.telephones.att.com