

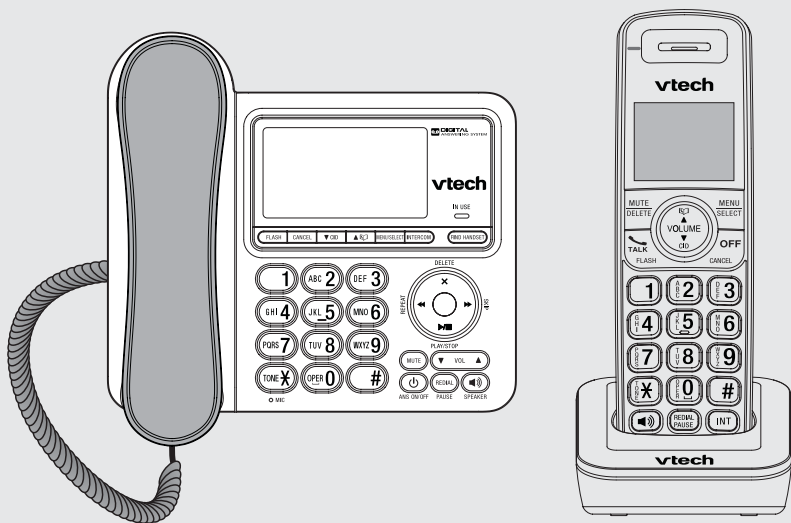

User's manual  
[www.vtechcanada.com](http://www.vtechcanada.com)



Model: CS6449

**DECT 6.0**

## Congratulations

on purchasing your new VTech product. Before using this telephone, please read **Important safety instructions** on page 68 of this manual.

This manual has all the feature operations and troubleshooting necessary to install and operate your new VTech telephone. Please review this manual thoroughly to ensure proper installation and operation of this innovative and feature rich VTech product. For support, shopping, and everything new at VTech, visit our website at [www.vtechphones.com](http://www.vtechphones.com). In Canada, please visit [www.vtechcanada.com](http://www.vtechcanada.com).



The ENERGY STAR® program ([www.energystar.gov](http://www.energystar.gov)) recognizes and encourages the use of products that save energy and help protect our environment. We are proud to mark this product with the ENERGY STAR® label indicating it meets the latest energy efficiency guidelines.



Telephones identified with this logo have reduced noise and interference when used with most T-coil equipped hearing aids and cochlear implants. The TIA-1083 Compliant Logo is a trademark of the Telecommunications Industry Association. Used under license.

## Getting started

### Parts checklist

Your telephone package contains the following items. Save your sales receipt and original packaging in case it is necessary to ship your telephone for warranty service.

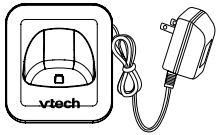

Handset charger and charger adapter



Telephone base



corded handset



Handset

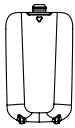

Battery compartment cover



Battery



Telephone line cord

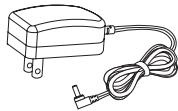

Telephone base adapter



User's manual

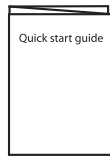

Quick start guide

## Getting started

### Telephone installation

Install the telephone base and charger(s) as shown below.

The telephone base is already for tabletop use. If you want to change to wall mounting, see for details.

Make sure that the electrical outlet is not controlled by a wall switch.

If you subscribe to digital subscriber line (DSL) high-speed Internet service through your telephone line, you must install a DSL filter between the telephone line cord and the telephone wall jack. The filter prevents noise and caller ID problems caused by DSL interference. Contact your DSL service provider for more information about DSL filters.

If you have DSL high speed Internet service, a DSL filter (not included) is required.

Electrical outlet not controlled by a wall switch

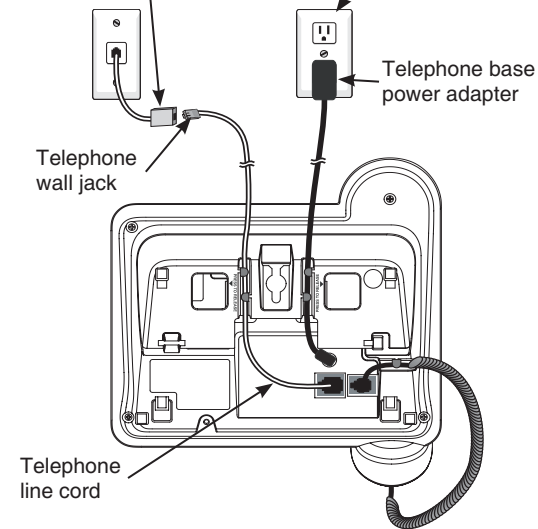

Telephone base

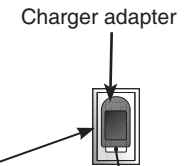

Electrical outlet not controlled by a wall switch

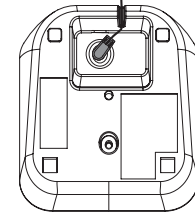

Charger

**note** To purchase replacement batteries or power adapters, visit our website at [www.vtechcanada.com](http://www.vtechcanada.com) or call 1 (800) 267-7377.

## Getting started

### Battery installation

Install the battery as shown below.

1. Plug the battery connector securely into the socket inside the handset battery compartment, matching the color-coded label.
2. Place the battery with the label **THIS SIDE UP** facing up and the wires inside the battery compartment.
3. Align the cover flat against the battery compartment, then slide it towards the center of the handset until it clicks into place.
4. Charge the handset by placing it in the charger. The **CHARGE** light is on when the handset is charging.

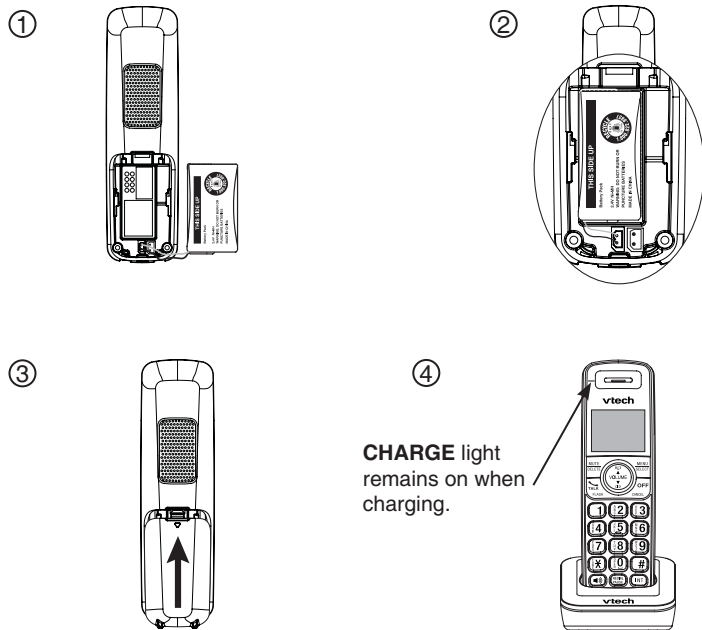

#### note

- If the handset will not be used for a long time, disconnect and remove the battery to prevent possible leakage.
- To purchase replacement batteries, visit our website at [www.vtechcanada.com](http://www.vtechcanada.com) or call 1 (800) 267-7377.

## Getting started

### Battery charging

Once you have installed the battery, the screen indicates the battery status (see the table below). If necessary, place the handset in the charger to charge the battery. For best performance, keep the handset in the telephone base or charger when not in use. The battery is fully charged after 16 hours of continuous charging. See the table on page 58 for battery operating times.

If the screen is blank or displays **Place in charger**, you need to charge the handset without interruption for at least 30 minutes to give the handset enough charge to use the telephone for a short time. When the battery is low, the handset displays **Low battery** along with a flashing icon. If you are on a call in low battery mode, the handset plays short beeps to alert you.

The following table summarizes the battery charge indicators and actions to take.

Battery indicators	Battery status	Action
The screen is blank, or displays <b>Place in charger</b> and  flashes.	Battery has no or very little charge. The handset cannot be used.	Charge without interruption (about 30 minutes).
The screen displays <b>Low battery</b> and  flashes.	Battery has enough charge to be used for a short time.	Charge without interruption (about 30 minutes).
The screen displays <b>HANDSET</b> .	Battery is charged.	To keep the battery charged, place it in the charger when not in use.

#### note

If you place the handset in the telephone base or charger without installing a battery, the screen displays **No battery**.

After you install your telephone or power returns following a power outage, the handset will prompt you to set the date and time (see page 13). To skip setting the date and time, press **OFF/CANCEL**.



## Getting started

### Installation options

Your telephone base is ready for tabletop use. If you want to mount your telephone on a wall, swivel the wall mount bracket down to connect with a standard dual-stud telephone wall mounting plate. If you do not have this mounting plate, you can purchase one from many hardware or consumer electronics retailers. You may need a professional to install the mounting plate.

### Tabletop to wall mount installation

1. Plug one end of the telephone line cord into the telephone line jack on the bottom of the telephone base. Plug the small end of the power adapter into the jack on the bottom of the telephone base.

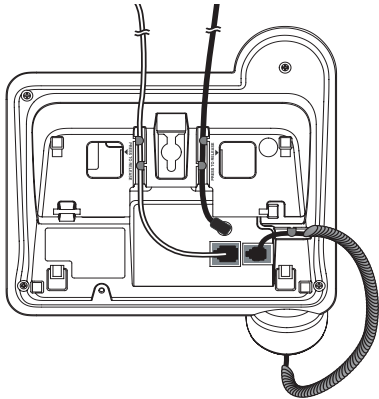

2. Press in as the arrow indicate. The bracket will detach from the telephone base. Swivel it down into wall mount position, making sure it clicks into place.

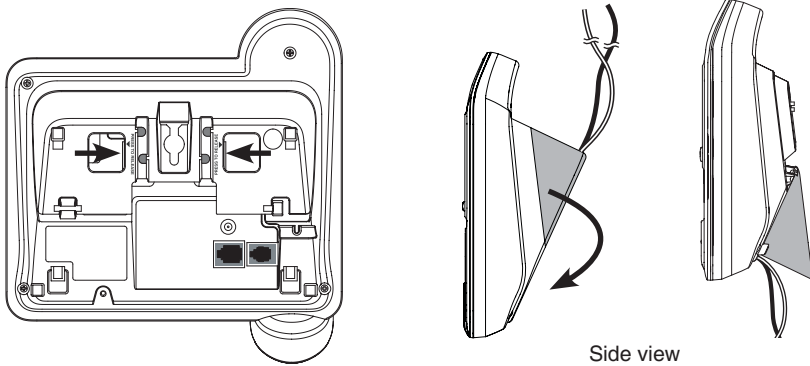

5

Side view

## Getting started

3. Press the hook and remove the handset tab from the telephone base. Rotate and replace it to hold the corded handset securely in place when the telephone base is mounted on the wall.

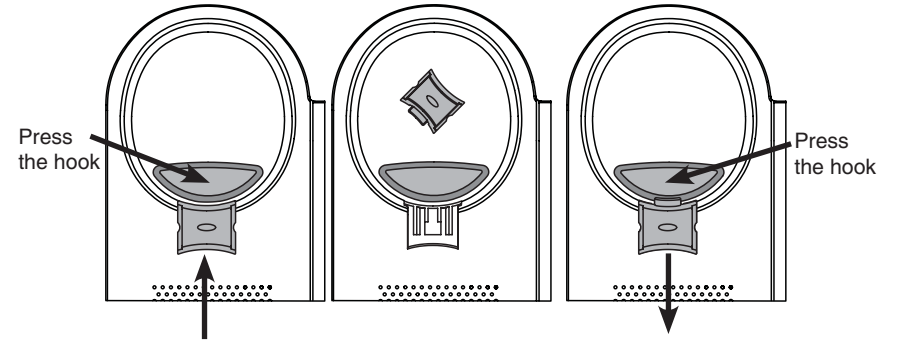

4. Plug the power adapter and telephone line into the wall outlets.

5. Align the mounting studs on the telephone outlet plate with the mounting holes on the bracket.

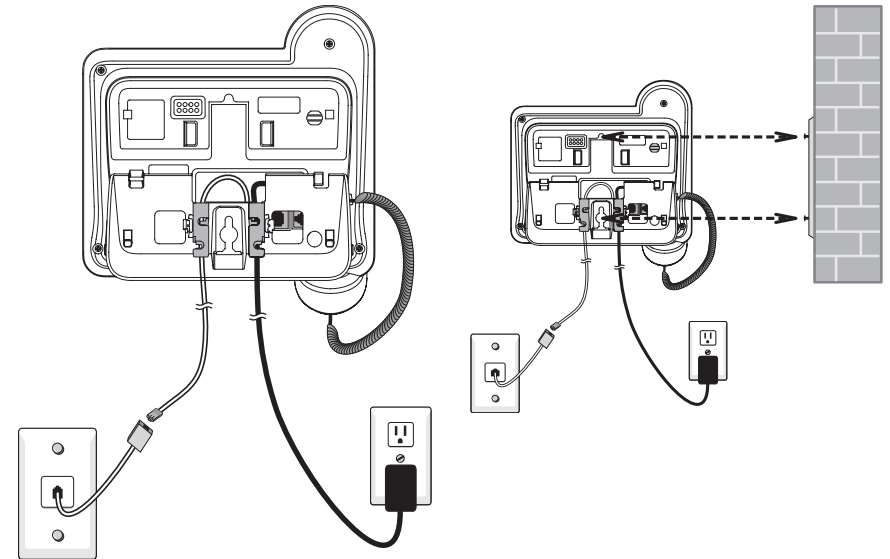

6

## Getting started

### Wall mount to tabletop installation

To change the telephone base from the wall mount position to tabletop position:

1. Remove the telephone base from the wall.
2. If necessary, untie the bundled telephone cord and power adapter cord.
3. Push as indicated by arrows in the illustration until the bracket is released, and then swivel it upward until it clicks into the tabletop position.

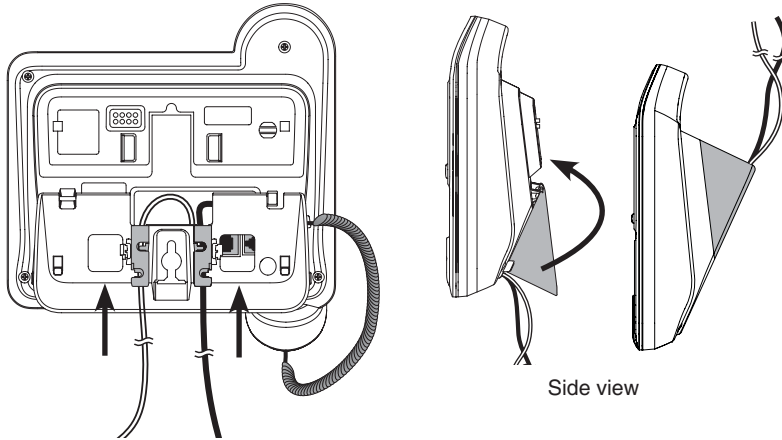

4. Press the hook and remove the handset tab from the telephone base. Rotate and replace for desktop use.

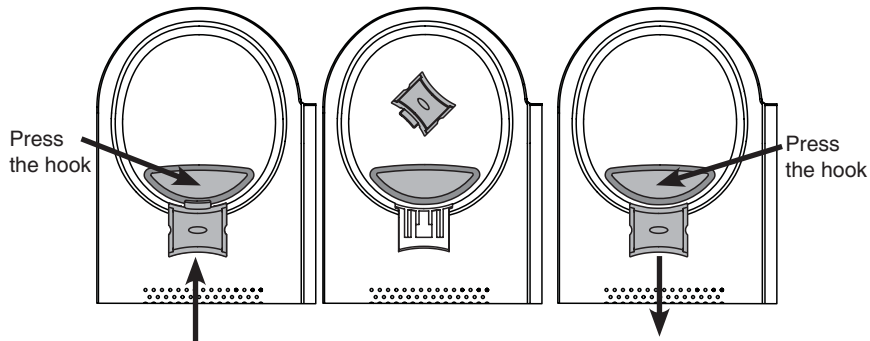

## Getting started

### Telephone base layout



Press when the phone is idle to display the directory (page 48).

Press to scroll up while in menus and lists.

While entering or modifying names, press to move the cursor to the right.



Press when the phone is idle to display the call history (page 54).

Press to scroll down while in menus and lists.

While entering numbers or letters, press to move the cursor to the left.

### FLASH

During a call, press to answer an incoming call when you receive a call waiting alert (page 35).

### CANCEL

While using menus, press to cancel an operation, back up to the previous menu or exit the menu display.

### TONE X

If you have pulse dialing, press during a call to switch to tone dialing temporarily (page 37).

### MENU/SELECT

Press to show the menu. While in the menu, press to confirm or save an entry or setting.

### IN USE indicator

On when the telephone is in use, or when the answering system is answering an incoming call.

On when a handset is being registered.

Flashes when there is an incoming call or when a handset is being deregistered.

Flashes when another telephone is in use on the same line.

### INTERCOM

While the phone is idle, press to initiate an intercom call (page 39).

### REDIAL/PAUSE

Press to access the last 20 numbers dialed (page 33).

While predialing or entering numbers into your directory, press and hold to insert a dialing pause (page 45).

### ANS ON/OFF

Press to turn the built-in answering system on or off (page 60).

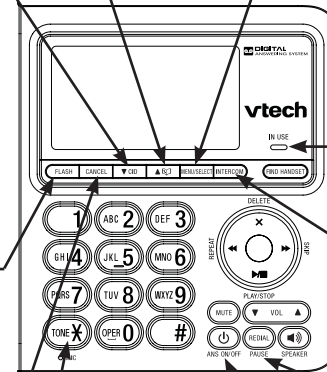

## Getting started

### Telephone base layout

#### X/DELETE

Press to delete the message currently playing. When in idle mode, press twice to delete all old messages (page 63).

#### ◀◀/REPEAT

Press to repeat the message; press twice to play the previous message (page 63).

#### MUTE

Press to turn off the microphone; press again to resume your conversation (page 35).

#### MIC

Microphone

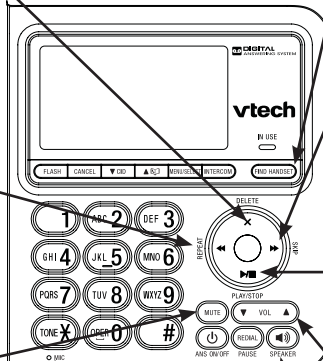

#### FIND HANDSET

While the phone is idle, press to page all handsets (page 38).

#### ▶▶/SKIP

Press to skip the message (page 62).

#### ▶/■/PLAY/STOP

Press to start or stop message playback (page 62).

Flashes when there are new messages or memos in the answering system.

#### ▼/VOL/▲

During message playback, press to adjust the listening volume (page 62).

While in idle mode, press to adjust the base ringer volume (page 61).

#### SPEAKER

Press to switch between speakerphone and corded handset (page 30).

## Getting started

### Handset layout

#### CHARGE light

On when the handset is charging.

#### /▲/VOLUME (directory/volume)

Press ▲/📖 to show directory entries (page 48).

Press to scroll up while in menus.

While entering names or numbers, press to move the cursor to the right.

Press to increase the listening volume when on a call.

#### MUTE/DELETE

During a call, press to mute the microphone (page 35).

While reviewing the caller ID history, the directory or the redial memory, press to delete an individual entry (page 56, page 50 and page 32 respectively).

While predialing, press to delete digits (page 30).

#### /FLASH

Press to make or answer a call.

During a call, press to answer an incoming call when you receive a call waiting alert (page 35).

#### 1

While reviewing a call log entry, press repeatedly to add or remove 1 in front of the telephone number before dialing or saving it in the directory (page 55).

#### TO NE

If you have pulse dialing, press during a call to switch to tone dialing temporarily (page 37).

#### 

Press to switch between speakerphone and handset (page 31).

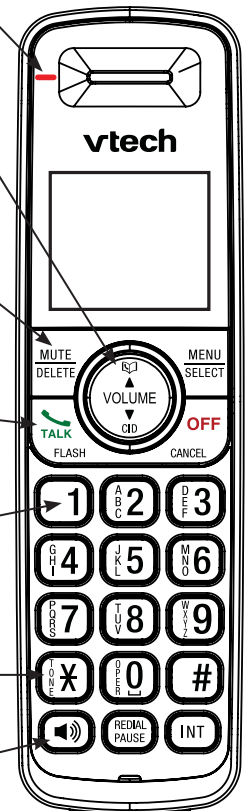

## Getting started

### Handset layout

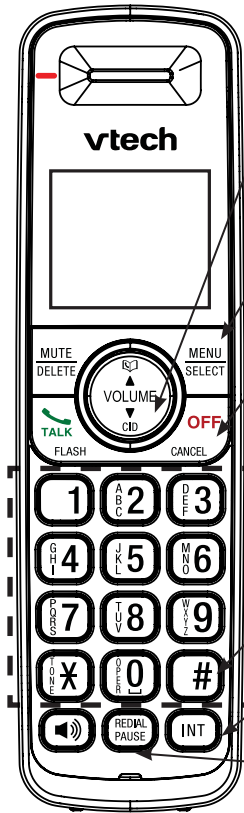

#### ▼/CID/VOLUME (caller ID/volume)

Press ▼/CID to show the caller ID history (page 54).  
 Press to scroll down while in menus.  
 While entering names or numbers, press to move the cursor to the left.  
 Press to decrease the listening volume when on a call.

#### MENU/SELECT

Press to show the menu.  
 While in the menu, press to select an item or save an entry or setting.

#### OFF/CANCEL

During a call, press to hang up.  
 While in a menu, press to cancel an operation, back up to the previous menu, or exit the menu display.  
 Press and hold while the telephone is not in use to erase the missed calls indicator.

#### Dialing keys

Press to enter numbers or characters.

#### # (pound key)

Press repeatedly to display other dialing options when reviewing a call log entry (page 55).

#### INT

Press to begin an intercom conversation (page 39) or to transfer a call (page 41).

#### REDIAL/PAUSE

Press repeatedly to view the last 20 numbers dialed (page 32).  
 While entering numbers, press and hold to insert a dialing pause (page 44).

## Handset settings

### Using the menu

#### To enter the handset menu:

1. Press **MENU/SELECT** when the handset is not in use.
2. Press ▼ or ▲ until the screen displays the desired feature menu.
3. Press **MENU/SELECT** to enter that menu.
  - To return to the previous menu, press **OFF/CANCEL**.
  - To return to idle mode, press and hold **OFF/CANCEL**.

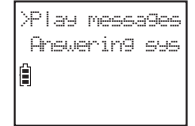

Go to **Answering system settings** starting on page 43 for instructions on how to use a system handset to modify the answering system settings shown below.

Setting	Page
Announcement (record, play and delete)	43-44
Answer on/off	45
Call screening	45
Number of rings	46
Remote access code	46
Message alert tone	47
Voice language	
Message recording time	47

## Handset settings

### Ringer volume (handset)

You can set the ringer volume to one of six levels or turn the ringer off. When the ringer is off,  appears on the screen.

1. Press **MENU/SELECT** when the handset is not in use.
2. Press **▼** or **▲** to highlight **>Ringers**, then press **MENU/SELECT**.
3. Press **MENU/SELECT** to select **>Ringer volume**.
4. Press **▼** or **▲** to sample each volume level.
5. Press **MENU/SELECT** to save your selection and return to the previous menu. You hear a confirmation tone.

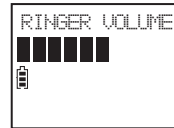
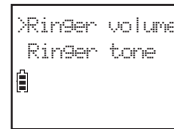
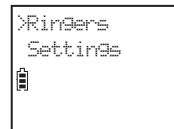

- note**
- The ringer volume also determines the ringer volume of intercom calls.
  - If the ringer volume is set to off, the handset displays **Caller ID won't be announced** when you save the setting. The caller ID will not be announced when you have an incoming call (page 14).

### Ringer tone

You can choose from different ringer tones for each handset.

1. Press **MENU/SELECT** when the handset is not in use.
2. Press **▼** or **▲** to highlight **>Ringers**, then press **MENU/SELECT**.
3. Press **▼** or **▲** to highlight **>Ringer tone**, then press **MENU/SELECT**.
4. Press **▼** or **▲** to sample each ringer tone.
5. Press **MENU/SELECT** to save your selection and return to the previous menu. You hear a confirmation tone.

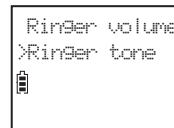

- note**
- If you turn off the ringer volume, you will not hear ringer tone samples.

## Handset settings

### LCD language

You can select a language (English, French or Spanish) to be used in all screen displays.

1. Press **MENU/SELECT** when the handset is not in use.
2. Press **▼** or **▲** to highlight **>Settings**, then press **MENU/SELECT**.
3. Press **MENU/SELECT** to select **>LCD language**.
4. Press **▼** or **▲** to highlight **English, Français** or **Español**.
5. Press **MENU/SELECT** to save your selection and return to the previous menu. You hear a confirmation tone.

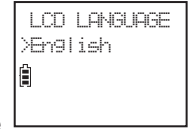
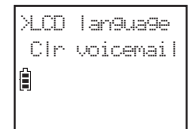

### Clear voicemail indicators

If you subscribe to voicemail service offered by your telephone service provider, **New voicemail** and  appear on the handset when you have new voicemail messages. Contact your telephone service provider for more information and assistance about using your voicemail service.



After you have listened to all new voicemail messages, the indicators on the handset turn off automatically.

Use the clear voicemail feature when the telephone indicates that there is new voicemail but there are none (for example, when you have accessed your voicemail while away from home). Clearing the voicemail waiting indicator only turns off the indicators; it does not delete your voicemail messages. As long as you have new voicemail messages, your telephone service provider continues to send the signal to turn on the indicators.

### To manually turn off the new voicemail indicators:

1. Press **MENU/SELECT** when the handset is not in use.
2. Press **▼** or **▲** to highlight **>Settings**, then press **MENU/SELECT**.
3. Press **▼** or **▲** to highlight **>Clr voicemail**, then press **MENU/SELECT**. The screen displays **Turn off indicator?**
4. Press **MENU/SELECT** to confirm and return to the previous menu. You hear a confirmation tone.



- note**
- Your telephone service provider may alert you of new messages with a stutter (broken) dial tone. Contact your telephone service provider for details.



## Handset settings

### Key tone

You can adjust the key tone volume or turn it off for each handset. If you turn the key tone off, there are no beeps when you press the handset keys.

1. Press **MENU/SELECT** when the handset is not in use.
2. Press ▼ or ▲ to highlight **>Settings**, then press **MENU/SELECT**.
3. Press ▼ or ▲ to highlight **>Key tone**, then press **MENU/SELECT**.
4. Press ▼ or ▲ to select the desired volume or **Off**.
5. Press **MENU/SELECT** to save your selection and return to the previous menu. You hear a confirmation tone.

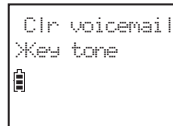

## Handset settings

### Set date and time

The answering system announces the date and time of each message prior to playing it. Before using the answering system, set the date and time as follows. If you subscribe to caller ID service, the day, month and time are set automatically with each incoming call. However, the year must be correct so that the day of the week can be calculated from the caller ID information. You can also turn off the date and time settings of the caller ID service (see **CID time synchronization** on page 17) and set the date and time manually.

1. Press **MENU/SELECT** when the handset is not in use.
2. Press ▼ or ▲ to highlight **>Settings**, then press **MENU/SELECT**.
3. Press ▼ or ▲ to highlight **>Set date/time**, then press **MENU/SELECT**.
4. Press ▼ or ▲ to highlight **>Date & time**, then press **MENU/SELECT**.
5. When the month is flashing, press ▼ or ▲ until the screen displays the correct month. Press **MENU/SELECT** to confirm.  
**-OR-**  
Use the dialing keys (0-9) to enter the current month (for example, if the month is March, you must enter **03**).
4. Repeat Step 3 to set the correct date and year and then press **MENU/SELECT** to advance to set the time.
5. Repeat Step 3 until the time is set. Press ▼ or ▲ to select **AM** or **PM**, or press **2** for **AM** or **7** for **PM**.
6. Press **MENU/SELECT** to save the settings and return to the previous menu. You hear a confirmation tone.

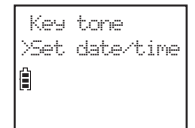

**note** If the date and time are not set when a message is recorded, the system announces, "Time and date not set," before each message plays.

## Handset settings

### CID time synchronization

This feature allows the time and date to be set by incoming caller ID information. The default setting is **On**.

1. Press **MENU/SELECT** when the handset is not in use.
2. Press **▼** or **▲** to highlight **>Settings**, then press **MENU/SELECT**.
3. Press **▼** or **▲** to highlight **>CID time sync**, then press **MENU/SELECT**.
4. Press **▼** or **▲** to choose **>On** or **>Off**.
5. Press **MENU/SELECT** to save your selection and return to the previous menu. You hear a confirmation tone.

```
Key tone
>Set date/time
☎
```

```
Date & time
>CID time sync
☎
```

```
CID TIME SYNC
>On
☎
```

### Home area code

If you dial your local calls using only seven digits (area code not required), you can program your home area code so that when you receive a call within your local area, the telephone number is automatically stored without the area code in the caller ID log.

1. Press **MENU/SELECT** when the handset is not in use.
2. Press **▼** or **▲** to highlight **>Settings**, then press **MENU/SELECT**.
3. Press **▼** or **▲** to highlight **>Home area code**, then press **MENU/SELECT**.
4. Use the dialing keys to enter a three-digit home area code.
  - Press **MUTE/DELETE** to delete a digit.
  - Press and hold **MUTE/DELETE** to delete all digits.
  - Press **▼** or **▲** to move the cursor to the left or right.
5. Press **MENU/SELECT** to save. You hear a confirmation tone, then the screen automatically turns to the previous menu.

```
Set date/time
>Home area code
☎
```

```
HOME AREA CODE
☎
```

#### note

If, in the future, your telephone service provider requires you to dial the area code when making a local call, or, if you move to a location that requires it, delete the home area code you have already programmed, following the steps above. After you have deleted the home area code, `___` will appear on the display.

## Handset settings

### Dial mode

The dial mode is preset to tone dialing. If you have pulse (rotary) service, you must change the dial mode to pulse dialing before using the telephone making a call.

1. Press **MENU/SELECT** when the handset is not in use.
2. Press **▼** or **▲** to highlight **>Settings**, then press **MENU/SELECT**.
3. Press **▼** or **▲** to highlight **>Dial mode**, then press **MENU/SELECT**.
4. Press **▼** or **▲** to choose **>Tone** or **>Pulse**.
5. Press **MENU/SELECT** to save your selection and return to the previous menu. You hear a confirmation tone.

```
Home area code
>Dial mode
☎
```

```
DIAL MODE
>Tone
☎
```

### Website

Use this feature to view the VTech website address.

1. Press **MENU/SELECT** when the handset is not in use.
2. Press **▼** or **▲** to highlight **>Website**, then press **MENU/SELECT**. The screen displays the website address.

```
Settings
>Website
☎
```

```
www.vtechcanada
.com
☎
```

## Answering system settings (handset only)

Use the answering system menu of any system handset to set or change the outgoing announcement, call screening, number of rings, remote access and message alert tone settings.

1. When the handset is in idle mode, press **MENU/SELECT** to enter the main menu.
2. Press **▼** or **▲** to scroll to **>Answering sys**, then press **MENU/SELECT**.

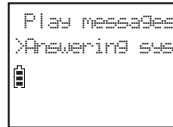

### Announcement

Your outgoing announcement plays when calls are answered by the answering system.

The telephone has a default outgoing announcement, “*Hello. Please leave a message after the tone.*” You can use this announcement, or record your own announcement.

You can record an announcement up to 90 seconds. The system does not record any announcement shorter than two seconds.

#### To play your current outgoing announcement:

1. When the handset is in idle mode, press **MENU/SELECT** to enter the main menu.
2. Press **▼** or **▲** to scroll to **>Answering sys**, then press **MENU/SELECT**.
3. Press **MENU/SELECT** again to select **>Announcement**. The system announces, “*To play, press 2. To record, press 7.*”
4. Press **2** to play the current announcement.

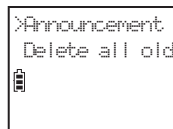
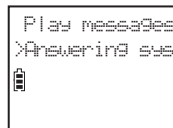

#### To record a new outgoing announcement:

1. When the handset is in idle mode, press **MENU/SELECT** to enter the main menu.
2. Press **▼** or **▲** to scroll to **>Answering sys**, then press **MENU/SELECT**.
3. Press **MENU/SELECT** again to select **>Announcement**. The system announces, “*To play, press 2. To record, press 7.*”
4. Press **7** to record an announcement. The system announces, “*Record after the tone. Press 5 when you are done.*”
5. Facing the handset, record your announcement and press **5** to end recording. Your recorded announcement plays.



To listen to the recorded announcement again, press **2** after playback is completed.

## Answering system settings (handset only)

#### To delete your outgoing announcement:

1. When the handset is in idle mode, press **MENU/SELECT** to enter the main menu.
2. Press **▼** or **▲** to scroll to **>Answering sys**, then press **MENU/SELECT**.
3. Press **MENU/SELECT** again to select **>Announcement**. The system announces, “*To play, press 2. To record, press 7.*”
4. Press **3** to delete your recorded announcement.



When your announcement is deleted, the system answers calls with the default announcement described on the previous page.

### Answer on/off

Unless you change it, the answering system is on and ready to record messages. You can turn the answering system off, but if you do so, the answering system does not answer calls and record incoming messages.

#### To turn the answering system on or off from a cordless handset:

1. When the handset is in idle mode, press **MENU/SELECT** to enter the main menu.
2. Press **▼** or **▲** to scroll to **>Answering sys**, then press **MENU/SELECT**.
3. Press **▼** or **▲** to scroll to **>Answer ON/OFF**, then press **MENU/SELECT**.
4. Press **▼** or **▲** to highlight **On** or **Off**, then press **MENU/SELECT** to confirm. You hear a confirmation tone. Press **OFF/CANCEL** to cancel.

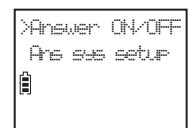
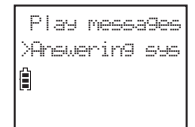

If the answering system is on, the handset screen shows **ANS ON**.

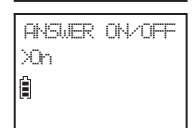



#### note







1. If the answering system is off and there is an incoming call, the system answers after 10 rings and announces, “*Please enter your remote access code.*” For more information about remote access codes, see page 66.
2. If you change any answering system settings, the system automatically turns on and will answer incoming calls.

## Answering system settings (handset only)

### Call screening

Use this feature to choose whether incoming messages can be heard over the telephone base speaker when they are being recorded. If you turn call screening on, you hear the incoming message. While monitoring an incoming message, you can answer the call by pressing /FLASH or  on the handset.

#### To change the setting:

1. When the handset is in idle mode, press **MENU/SELECT** to enter the main menu.
2. Press  or  to scroll to **>Answering sys**, then press **MENU/SELECT**.
3. Press  or  to scroll to **>Ans sys setup**.
4. Press **MENU/SELECT** twice to select **>Call screening**.
5. Press  or  to choose **On** or **Off**.
6. Press **MENU/SELECT** to confirm your setting and you hear a confirmation tone. Press **OFF/CANCEL** to cancel.

**note** For more information on call screening, see page 61

```
Play messages
>Answering sys
```

```
Answer ON/OFF
>Ans sys setup
```







```
>Call screening
# of rings
```

```
CALL SCREENING
>On
```

### Number of rings



You can set the answering system to answer an incoming call after two, four, or six rings. You can also select toll saver, which is explained below. Unless you change it, the answering system answers an incoming call after four rings.

#### To set the number of rings:

1. When the handset is in idle mode, press **MENU/SELECT** to enter the main menu.
2. Press  or  to scroll to **>Answering sys**, then press **MENU/SELECT**.
3. Press  or  to scroll to **>Ans sys setup**, then press **MENU/SELECT**.
4. Press  or  to scroll to **># of rings**, then press **MENU/SELECT**.

```
Call screening
># of rings
```

## Answering system settings (handset only)

5. Press  or  to scroll and choose among **>2**, **>4**, **>6** or **>Toll saver**.
  - Toll saver - the answering system answers a call after two rings if you have new messages, and after four rings when there are no new messages. This feature allows you to check for new messages and avoid paying long distance charges when calling from out of your local area.
6. Press **MENU/SELECT** to confirm your setting and you hear a confirmation tone. Press **OFF/CANCEL** to cancel.







```
# OF RINGS
>2
```

**note** If you subscribe to voicemail service through your telephone service provider, see **Answering system and voicemail** on page 59.

### Remote access code

To access your answering system remotely from any touch-tone phone, you need to enter a two-digit number (00-99). Unless you change it, the remote access code is 19.

#### To change the remote access code:

1. When the handset is in idle mode, press **MENU/SELECT** to enter the main menu.
2. Press  or  to scroll to **>Answering sys**, then press **MENU/SELECT**.
3. Press  or  to scroll to **>Ans sys setup**, then press **MENU/SELECT**.
4. Press  or  to scroll to **>Remote code**, then press **MENU/SELECT**.
5. Use the dial pad to enter a two-digit number. Use **MUTE/DELETE** to backspace and delete a digit.
6. Press **MENU/SELECT** to confirm your setting and you hear a confirmation tone. Press **OFF/CANCEL** to cancel.

```
Play messages
>Answering sys
```

```
Answer ON/OFF
>Ans sys setup
```

```
>Remote code
Msg alert tone
```

```
REMOTE CODE
19
```

## Answering system settings (handset only)

### Message alert tone

When the message alert tone is set to **ON**, and there is at least one new message, the telephone base beeps every 10 seconds. Unless you change it, the message alert tone is set to off.

There is no audible alert at the handset.

#### To change the setting:

1. When the handset is in idle mode, press **MENU/SELECT** to enter the main menu.
2. Press **▼** or **▲** to scroll to **>Answering sys**, then press **MENU/SELECT**.
3. Press **▼** or **▲** to scroll to **>Ans sys setup**, then press **MENU/SELECT**.
4. Press **▼** or **▲** to scroll to **>Msg alert tone**, then press **MENU/SELECT**.
5. Press **▼** or **▲** to choose **On** or **Off**.
6. Press **MENU/SELECT** to confirm your setting and you hear a confirmation tone. Press **OFF/CANCEL** to cancel.

```
Play messages
>Answering sys
```

```
Answer ON/OFF
>Ans sys setup
```

```
Remote code
>Msg alert tone
```

```
MSG ALERT TONE
>On
```

#### note

1. The message alert tone beeps only if all the conditions below are met:
  - Answering system is on.
  - Message alert tone setting is on.
  - There are new messages.
2. To temporarily turn off the message alert tone, see page 61.

## Telephone base settings

### Using the menu

#### To enter the handset menu:

1. Press **MENU/SELECT** when the telephone base is not in use.
2. Press **▼/CID** or **▲/R/S** until the screen displays the desired feature menu.
3. Press **MENU/SELECT** to enter that menu.
  - To return to the previous menu, press **OFF/CANCEL**.
  - To return to idle mode, press and hold **OFF/CANCEL**.

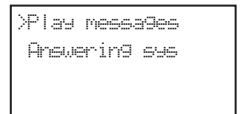
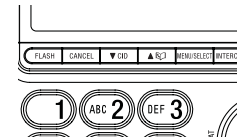

Go to **Answering system settings** starting on page 43 for instructions on how to use a telephone base to modify the answering system settings shown below.

Setting	Page
Announcement (record, play and delete)	43-44
Answer on/off	45
Call screening	45
Number of rings	46
Remote access code	46
Message alert tone	47
Voice language	
Message recording time	47

## Telephone base settings

### Ringer volume

You can set the ringer volume or turn the ringer off. When the ringer is off,  appears on the screen.

- Press **▼/VOL/▲** on the telephone base to adjust the ringer volume when the telephone is not in use.

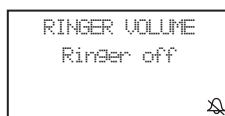

**-OR-**

- Press **MENU/SELECT** when telephone base is not in use.
- Press **▼/CID** or **▲/☞** to highlight **>Ringers**, then press **MENU/SELECT**.
- Press **MENU/SELECT** to select **>Ringer volume**.
- Press **▼/CID** or **▲/☞** to sample each volume level.
- Press **MENU/SELECT** to save your selection and return to the previous menu. You hear a confirmation tone.

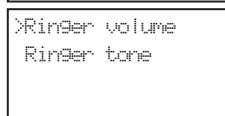
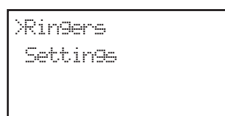

**note** The ringer volume also determines the ringer volume for intercom calls (page ). If the ringer volume is set to off, the base ringer is silenced for all incoming and intercom calls.

### Ringer tone

You can choose from different ringer tones for the telephone base.

- Press **MENU/SELECT** when the telephone base is not in use.
- Press **▼/CID** or **▲/☞** to highlight **>Ringers**, then press **MENU/SELECT**.
- Press **▼/CID** or **▲/☞** to highlight **>Ringer tone**, then press **MENU/SELECT**.
- Press **▼/CID** or **▲/☞** to sample each ringer tone.
- Press **MENU/SELECT** to save your selection and return to the previous menu. You hear a confirmation tone.

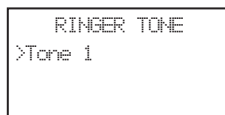
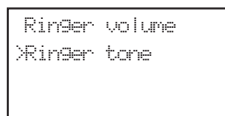

**note** If you turn off the ringer volume, you will not hear ringer tone samples.

## Telephone base settings

### LCD language

You can select a language (English, French or Spanish) to be used in all screen displays.

- Press **MENU/SELECT** when the telephone base is not in use.
- Press **▼/CID** or **▲/☞** to highlight **>Settings**, then press **MENU/SELECT**.
- Press **MENU/SELECT** to select **>LCD language**.
- Press **▼/CID** or **▲/☞** to highlight **English, Français** or **Español**.
- Press **MENU/SELECT** to save your selection and return to the previous menu. You hear a confirmation tone.

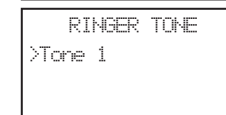
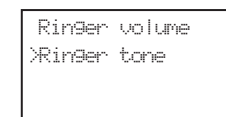
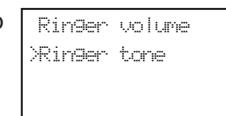

### Clear voicemail indicators

If you subscribe to voicemail service offered by your telephone service provider, **New voicemail** and  appear on the telephone base when you have new voicemail messages. Contact your telephone service provider for more information and assistance about using your voicemail service.



After you have listened to all new voicemail messages, the indicators on the telephone base turn off automatically.

Use the clear voicemail feature when the telephone indicates that there is new voicemail but there are none (for example, when you have accessed your voicemail while away from home). Clearing the voicemail waiting indicator only turns off the indicators; it does not delete your voicemail messages. As long as you have new voicemail messages, your telephone service provider continues to send the signal to turn on the indicators.

- Press **MENU/SELECT** when the telephone base is not in use.
- Press **▼/CID** or **▲/☞** to highlight **>Settings**, then press **MENU/SELECT**.
- Press **▼/CID** or **▲/☞** to highlight **>Clr voicemail**, then press **MENU/SELECT**. The screen displays **Turn off indicator?**
- Press **MENU/SELECT** to confirm and return to the previous menu. You hear a confirmation tone.

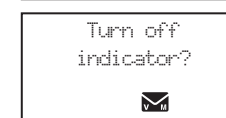
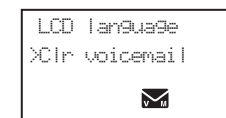

## Telephone base settings

### note

- Your telephone service provider may alert you of new messages with a stutter (broken) dial tone. Contact your telephone service provider for details.
- Voicemail is different from answering system messages recorded in your cordless phone's answering system. For more information about the difference, see page 48.

### Key tone

You can adjust the key tone volume or turn it off for the telephone base. If you turn the key tone off, there are no beeps when you press the telephone base keys.

- Press **MENU/SELECT** when the telephone base is not in use.
- Press **▼/CID** or **▲/☞** to highlight **>Settings**, then press **MENU/SELECT**.
- Press **▼/CID** or **▲/☞** to highlight **>Key tone**, then press **MENU/SELECT**.
- Press **▼/CID** or **▲/☞** to select the desired volume or **Off**.
- Press **MENU/SELECT** to save your selection and return to the previous menu. You hear a confirmation tone.

```
>Key tone
  Set date/time
```

```
KEY TONE
>Off
```

### Set date and time

The answering system announces the date and time of each message prior to playing it. Before using the answering system, set the date and time as follows. If you subscribe to caller ID service, the day, month and time are set automatically with each incoming call. However, the year must be correct so that the day of the week can be calculated from the caller ID information. You can also turn off the date and time settings of the caller ID service (see **CID time synchronization** on page 17) and set the date and time manually.

- Press **MENU/SELECT** when the telephone base is not in use.
- Press **▼/CID** or **▲/☞** to highlight **>Set date/time**, then press **MENU/SELECT**.
- When the month is flashing, press **▼/CID** or **▲/☞** until the screen displays the correct month. Press **MENU/SELECT** to confirm.

**-OR-**

Use the dialing keys (**0-9**) to enter the current month (for example, if the month is March, you must enter **03**).

```
Key tone
>Set date/time
```

```
>Date & time
  CID time sync
```

## Telephone base settings

- Repeat Step 3 to set the correct date and year and then press **MENU/SELECT** to advance to set the time.
- Repeat Step 3 until the time is set. Press **▼/CID** or **▲/☞** to select **AM** or **PM**, or press **2** for **AM** or **7** for **PM**.
- Press **MENU/SELECT** to save the settings and return to the previous menu. You hear a confirmation tone.

```
SET DATE
--/--/--
```

```
SET TIME
--:-- --
```

### note

- If the date and time are not set when a message is recorded, the system announces, "Time and date not set," before each message plays.
- The telephone plays two beeps if you enter an invalid number.

### CID time synchronization

This feature allows the time and date to be set by incoming caller ID information. The default setting is **On**.

- Press **MENU/SELECT** when the telephone base is not in use.
- Press **▼/CID** or **▲/☞** to highlight **>Settings**, then press **MENU/SELECT**.
- Press **▼/CID** or **▲/☞** to highlight **>CID time sync**, then press **MENU/SELECT**.
- Press **▼/CID** or **▲/☞** to choose **>On** or **>Off**.
- Press **MENU/SELECT** to save your selection and return to the previous menu. You hear a confirmation tone.

```
Key tone
>Set date/time
```

```
Date & time
>CID time sync
```

```
CID TIME SYNC
>On
```

## Telephone base settings

### Home area code

If you dial your local calls using only seven digits (area code not required), you can program your home area code so that when you receive a call within your local area, the telephone number is automatically stored without the area code in the caller ID log.

1. Press **MENU/SELECT** when the telephone base is not in use.
2. Press **▼/CID** or **▲/☞** to highlight **>Settings**, then press **MENU/SELECT**.
3. Press **▼/CID** or **▲/☞** to highlight **>Home area code**, then press **MENU/SELECT**.
4. Use the dialing keys to enter a three-digit home area code.
  - Press **MUTE/DELETE** to delete a digit.
  - Press and hold **MUTE/DELETE** to delete all digits.
  - Press **▼/CID** or **▲/☞** to move the cursor to the left or right.
5. Press **MENU/SELECT** to save. You hear a confirmation tone, then automatically turns to the previous menu.

```
Set date/time
>Home area code
```

```
HOME AREA CODE  ____
```

#### note

If, in the future, your telephone service provider requires you to dial the area code when making a local call, or, if you move to a location that requires it, delete the home area code you have already programmed, following the steps above. After you have deleted the home area code, `___` will appear on the display.

## Telephone base settings

### Dial mode

The dial mode is preset to tone dialing. If you have pulse (rotary) service, you must change the dial mode to pulse dialing before using the telephone making a call.

1. Press **MENU/SELECT** when the telephone base is not in use.
2. Press **▼/CID** or **▲/☞** to highlight **>Settings**, then press **MENU/SELECT**.
3. Press **▼/CID** or **▲/☞** to highlight **>Dial mode**, then press **MENU/SELECT**.
4. Press **▼/CID** or **▲/☞** to choose **>Tone** or **>Pulse**.
5. Press **MENU/SELECT** to save your selection and return to the previous menu. You hear a confirmation tone.

```
Home area code
>Dial mode
```

```
DIAL MODE
>Tone
```

### Website

Use this feature to view the VTech website address.

1. Press **MENU/SELECT** when the telephone base is not in use.
2. Press **▼/CID** or **▲/☞** to highlight **>Website**, then press **MENU/SELECT**. The screen displays the website address.

```
>Website
-End of list-
```

```
www.vtechcanada
.com
```



## Telephone operation

### Making a call

#### Using a cordless handset:

1. Press **TALK/FLASH** or **[MUTE]** on the handset.
2. When you hear a dial tone, dial the number.

#### Using the telephone base:

1. Lift the corded handset or press **[MUTE]** on the telephone base.
2. When you hear a dial tone, dial the number.

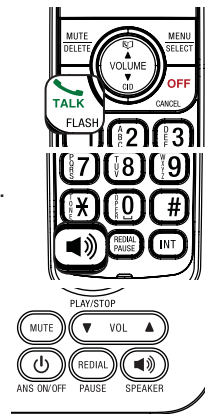

### On hook dialing (predialing)

#### Using a cordless handset:

1. Enter the telephone number. Press **MUTE/DELETE** or **OFF/CANCEL** to make corrections when entering the phone number.
2. Press **TALK/FLASH** or **[MUTE]** to dial.

#### Using the telephone base:

1. Use the dialing keys on the telephone base to enter the telephone number. Press **CANCEL** or **X/DELETE** to make corrections as you enter the phone number.
2. Press **SPEAKER** **[MUTE]** to dial.

**-OR-**

Lift the corded handset to dial.

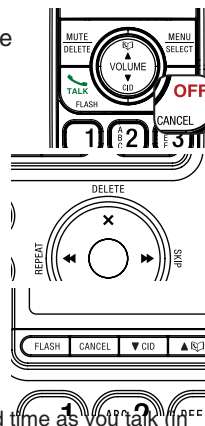

#### note

- The handset or and the telephone base show the elapsed time as you talk (in hours, minutes and seconds).
- When predialing (preview numbers before dialing), press **MUTE/DELETE** on the cordless handset or **X/DELETE** on the telephone base to backspace and delete a digit; press and hold **REDIAL/PAUSE** on the cordless handset or telephone base to insert a dialing pause (a **p** appears).
- The cordless handset or the telephone base displays **Unable to call. Line in use** if you predial a number while your telephone line is in use.

## Telephone operation

### Answering a call

#### Using a cordless handset:

Press **TALK/FLASH**, **[MUTE]** or any dialing key (**0-9**, **#** or **TOUR X**) on the handset to answer a call.

#### Using the telephone base:

Lift the corded handset, or press **[MUTE]** or any dialing key (**0-9**, **#** or **TOUR X**) on the telephone base to answer a call.

### Temporary ringer silencing

#### Using a cordless handset:

When the telephone is ringing, press **OFF/CANCEL** or **MUTE/DELETE** to temporarily silence the ringer on that handset only. The handset displays **Ringer muted** and **[MUTE]**. This turns off the ringer without disconnecting the call. The next call rings normally at the preset volume.

#### Using the telephone base:

When the telephone is ringing, press **MUTE** to temporarily silence the ringer on the telephone base only. The telephone base displays **Ringer muted** and **[MUTE]**. This turns off the ringer without disconnecting the call. The next call rings normally at the preset volume.

#### note

Each handset or telephone base rings when there is an incoming call unless the ringer volume is turned off on that device.

### Ending a call

#### Using a cordless handset:

Press **OFF/CANCEL** on the handset or place the handset in the telephone base or charger.

#### Using the telephone base:

When the corded handset is on a call, place the corded handset on the telephone base.

When the speakerphone is on, press **[MUTE]** on the telephone base.

## Telephone operation

### Auto off

A call ends automatically when you put the handset in the telephone base or charger. (If the telephone base speakerphone is active, placing the corded handset in the telephone base does not end the call.)

### Speakerphone

#### Using a cordless handset:

When the cordless handset is on a call, press **⏸** to switch between the speakerphone and the handset. When the speakerphone is active, the handset displays **Speaker** and **⏸**.

#### Using the telephone base:

When the corded handset is on a call, press **⏸** to switch between the telephone base and the corded handset. When the speakerphone is active, the telephone base displays **Speaker**.

### Last number redial

The last 20 telephone numbers dialed (up to 30 digits) are stored in the system memory.

#### Using a cordless handset:

To view the 20 most recently dialed numbers:

- To display the most recently dialed number, press **REDIAL/PAUSE**.
- To view up to 20 recently dialed numbers, press **REDIAL/PAUSE** then **▼** or **▲**, or press **REDIAL/PAUSE** repeatedly.

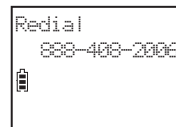

The handset beeps twice at the end of the list.

Press **OFF/CANCEL** to exit.

To redial a number:

- To dial the displayed number, press **TALK/FLASH** or **⏸**.
- OR-
- Press **TALK/FLASH** or **⏸**, then press **REDIAL/PAUSE** repeatedly to view the redial memory. Press **MENU/SELECT** to dial the displayed number.

## Telephone operation

To edit a number:

- While the desired number displays, press **MENU/SELECT** (see step 5 in the **To create a new directory entry** section on page 44 for details).

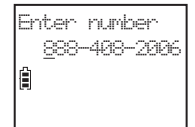

To delete a number:

- While the screen displays the desired number, press **MUTE/DELETE** to delete the number from the redial memory.

#### Using the telephone base:

To view the 20 most recently dialed numbers:

- To display the most recently dialed number (up to 30 digits), press **REDIAL/PAUSE**.
- To view up to 20 recently dialed numbers, press **REDIAL/PAUSE** then **▼/CID** or **▲/□**, or press **REDIAL/PAUSE** repeatedly.

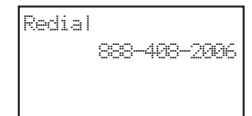

The telephone base beeps twice at the end of the list.

Press **CANCEL** to exit.

To redial a number:

- To dial a displayed number, press **⏸** or lift the corded handset.
- OR-
- Press **⏸** or lift the corded handset then press **REDIAL/PAUSE** repeatedly to view the redial memory. Press **MENU/SELECT** to dial the displayed number.

To edit a number:

- While the desired number displays, press **MENU/SELECT** (see step 5 in the **To create a new directory entry** section on page 45 for details).

To delete a number:

- While the screen displays the desired number, press **X/DELETE** to delete the number from the redial memory.

## Telephone operation

### Exiting the menu

On the handset, press **OFF/CANCEL** to cancel an operation, back up to the previous menu, or exit the menu display. Press and hold **OFF/CANCEL** to return to idle mode.

**-OR-**

On the telephone base, press **CANCEL** to cancel an operation, back up to the previous menu, or exit the menu display. Press and hold **CANCEL** to return to idle mode.

If you pause for too long while creating or reviewing an entry, the procedure times out and you have to begin again.

### Volume control

#### Using a cordless handset:

During a call, press **▼/VOLUME** or **▲/VOLUME** on the handset to adjust the listening volume.

#### Using the telephone base:

During a call, press **▼/VOL** or **▲/VOL** on the telephone base to adjust the listening volume.

- note**
- Handset and speakerphone volume settings are independent.
  - When the volume reaches the minimum or maximum setting, you hear two beeps.

### Call waiting

If you subscribe to call waiting service from your telephone service provider, you hear an alert tone when there is an incoming call while you are on another call.

- Press **TALK/FLASH** on the cordless handset or **FLASH** on the telephone base to put your current call on hold and take the new call.
- Press **TALK/FLASH** on the cordless handset or **FLASH** on the telephone base to switch back and forth between the calls.

## Telephone operation

### Chain dialing

Use this feature to initiate a dialing sequence from numbers stored in the directory, caller ID log or redial list while you are on a call.

Chain dialing can be useful if you wish to access other numbers (such as bank account numbers or access codes) from the directory, caller ID log or redial list.

#### To access a number from the directory while on a call:

##### Using a cordless handset:

1. Press **MENU/SELECT**.
2. Press **▼** or **▲** to highlight **>Directory**, then press **MENU/SELECT**.
3. Press **▼** or **▲** to scroll to the desired entry.
4. Press **MENU/SELECT** to dial the displayed number.

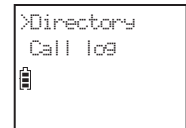

##### Using the telephone base:

1. Press **MENU/SELECT**.
2. Press **▼/CID** or **▲/☞** to highlight **>Directory**, then press **MENU/SELECT**.
3. Press **▼/CID** or **▲/☞** to scroll to the desired entry.
4. Press **MENU/SELECT** to dial the displayed number.

#### To access a number from the call log while on a call:

##### Using a cordless handset:

1. Press **MENU/SELECT**.
2. Press **▼** or **▲** to highlight **>Call log**, then press **MENU/SELECT**.
3. Press **▼** or **▲** to scroll to the desired entry.
4. Press **MENU/SELECT** to dial the displayed number.

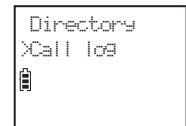

##### Using the telephone base:

1. Press **MENU/SELECT**.
2. Press **▼/CID** or **▲/☞** to highlight **>Call log**, then press **MENU/SELECT**.
3. Press **▼/CID** or **▲/☞** to scroll to the desired entry.
4. Press **MENU/SELECT** to dial the displayed number.

## Multiple handset use

To access a number from the redial list while on a call:

Using a cordless handset:

1. Press **REDIAL/PAUSE** to enter the redial list.
2. Press **▼** or **▲**, or press **REDIAL/PAUSE** repeatedly to browse to the desired entry.
3. Press **MENU/SELECT** to dial the displayed number.

Using the telephone base:

1. Press **REDIAL/PAUSE** to enter the redial list.
2. Press **▼/CID** or **▲/☞**, or press **REDIAL/PAUSE** repeatedly to browse to the desired entry.
3. Press **MENU/SELECT** to dial the displayed number.

## Mute

The mute function allows you to hear the other party but the other party cannot hear you.

To mute a call on a cordless handset:

- During a call, press **MUTE/DELETE**. The handset displays **Muted** for a few seconds and **MUTE** displays until the mute function is turned off.



To end mute a call on a cordless handset:

- Press **MUTE/DELETE** again to resume the conversation. The handset screen temporarily displays **Microphone ON**.

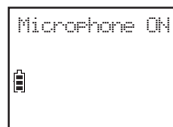

To mute a call on a telephone base:

- During a call, press **MUTE**. The telephone base displays **Muted** for a few seconds and the **MUTE** button turns red until the mute function is turned off.



To end mute a call on a telephone base:

- Press **MUTE** again to resume the conversation. The telephone base screen temporarily displays **Microphone ON**.



## Multiple handset use

### Temporary tone dialing

If you have pulse (rotary) service only, you can switch from pulse to tone dialing temporarily during a call. This is useful if you need to send touch-tone signals to access your telephone banking or long distance services.

1. During a call, press **tone X**.
2. Use the dialing keys to enter the number you wish to dial. The telephone sends touch-tone signals. The telephone automatically returns to pulse dialing mode after you end the call.

### Handset locator

The handset locator feature is useful if you misplace any handsets.

To start the paging tone:

- Press **FIND HANDSET** at the telephone base. **Paging all handsets** appears on the screen and the paging tone sounds on all handsets for 60 seconds.

**note** If you press **OFF/CANCEL** or **MUTE/DELETE** on a handset, the ringer of that handset stops, but the paging to the rest of the handsets continues.

To stop the paging tone:

- Press **OFF/CANCEL**, **📞**, or any dial pad keys (**0-9**, **tone X**, or **#**) on the handset(s).

**-OR-**

Press **FIND HANDSET** on the telephone base.

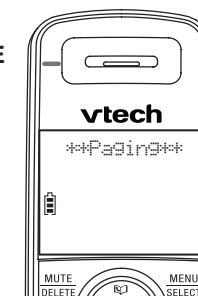
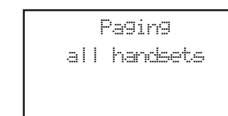
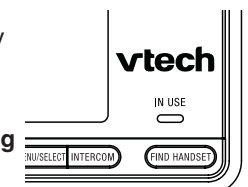

## Multiple handset use

### Join a call in progress

If a handset or telephone base is already on a call, you can join the call.

### Using a cordless handset:

Press **TALK/FLASH** or **⏪** on another cordless handset.

Press **OFF/CANCEL** or place the handset in the handset charger to end the call. The call does not end until all handsets and the telephone base hang up.

### Using the telephone base:

Lift the corded handset or press **⏪** on the telephone base.

Return the corded handset to the telephone base or press **⏪** to hang up. The call does not end until all handsets and the telephone base hang up.

**note** You can use up to four system handsets and the telephone base at the same time on an outside call.

## Intercom

Use the intercom feature for conversations between handsets. You can buy additional expansion handsets (model Vtech CS6400) for this telephone base. You can register up to 12 handsets to the telephone base.

The first nine handset that you register are named **HANDSET 1-9**. Use the handset number to initiate intercom and transfer calls.

Although the names for handsets 10-12 appear in their displays as 10-12, when you intercom or transfer to one of them, you must use **\*0** for **HANDSET 10**, **\*1** for **HANDSET 11**, and **\*2** for **HANDSET 12**.

### Using a cordless handset:

1. Press **INT** on your handset when not in use.

- If you have a single handset system, your handset screen shows **Calling base**. The telephone base rings and its screen shows **HANDSET is calling**.
- If you have more than one handset, your screen shows **INTERCOM TO:** Use the dial pad keys to enter a handset number. Your handset screen shows **Calling HANDSET X**. The called handset rings and its screen shows **HANDSET X is calling**.



CALLING  
base

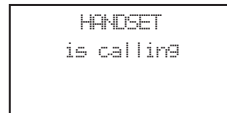

HANDSET  
is calling

**-OR-**

Enter **0** to intercom with the telephone base. The screen shows **CALLING BASE**. The telephone base rings and its screen shows **HANDSET X is calling**.

## Multiple handset use

2. To answer the intercom call, press **TALK/FLASH, INT, ⏪** or any dial pad keys (**0-9, TONE X, #**) on the called handset. Both handsets now show **Intercom**.



Intercom

**-OR-**

Press **SPEAKER ⏪, INTERCOM** or any dial pad keys (**0-9, TONE X, #**) on the telephone base, or lift the corded handset to answer the intercom call.

3. To end the intercom call, one party presses **OFF/CANCEL** or **INT** on either handset, or places the handset back in the charger. The other party hears four beeps. Both handsets display **Intercom ended**.



Calling  
base

**-OR-**

Press **INTERCOM** or **CANCEL** on the telephone base if you are using speakerphone mode, or return the corded handset to the telephone base. The other party hears four beeps. **Intercom ended** appears on both handset screen and telephone base screen.

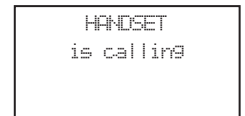

HANDSET  
is calling

- note**
- You can cancel the intercom call before it is answered by pressing **OFF/CANCEL**.
  - If the other handset does not answer the intercom call within 100 seconds, or if it is accessing the answering system, is out of range, or has no power, your handset displays **No answer. Try again** and returns to idle mode.
  - Pressing **OFF/CANCEL** or **MUTE/DELETE** on the cordless handset temporarily silences the intercom ringer.
  - Only one intercom call can be established with two handsets at a time.

### Using the telephone base:

1. Press **INTERCOM** on the telephone base, **INTERCOM TO:** appears on the screen.



Calling  
HANDSET

2. Enter a handset number. The screen shows **Calling HANDSET X**. If you have a single handset system, the base displays **Calling HANDSET**. The called handset rings and its screen shows **Base is calling**.

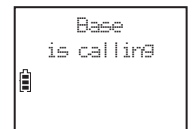

Base  
is calling

3. On the ringing handset, press **TALK/FLASH, INT, ⏪** or any dial pad keys (**0-9, TONE X, #**) to answer the intercom call.

## Multiple handset use

### note

- If you press **INTERCOM** when there is no cordless handset registered to the telephone base, **Int requires two handsets** displays on the base screen.
  - Before the intercom call is answered, you can cancel it by pressing **CANCEL** or **INTERCOM** on the telephone base.
  - If the called handset is not answered within 100 seconds, or if it is in the directory or call log mode, or is on a call, or is out of range, the base shows **Unable to call. Try again.**
  - Pressing **CANCEL** or **MUTE** on the telephone base temporarily silences the intercom ringer.
4. To end the intercom call, press **INTERCOM** or **CANCEL** on the telephone base if you are using speakerphone mode, or return the corded handset to the telephone base. The other party hears four beeps. **Intercom ended** appears on both handset screen and telephone base screen.

### Answer an incoming call during an intercom call

If you receive an incoming outside call during an intercom call, there is a two-beep call waiting tone.

#### Using a cordless handset:

- To answer the call, press **TALK/FLASH**. The intercom call ends automatically. Other system handsets can also answer the incoming call by pressing **TALK/FLASH**.
- To end the intercom call without answering or canceling the incoming call, press **OFF/CANCEL**.

#### Using the telephone base:

Press **SPEAKER** or lift the corded handset to answer the incoming call. The intercom call ends automatically.

## Multiple handset use

### Call transfer using intercom

Use the intercom feature to transfer an outside call to the telephone base or a cordless system handset.

#### Using a cordless handset:

1. During a call, press **INT**.

- If you have a single handset system, the outside call is put on hold and your handset screen shows **Calling base**. The telephone base rings and its screen shows **HANDSET is calling**.

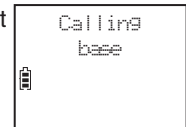

- If you have more than one handset, your screen shows **INTERCOM TO:**. Use the dial pad keys to enter a handset number. The outside call is put on hold and your handset screen shows



**Calling HANDSET X**. The other handset rings and its screen shows **HANDSET X is calling**.

**-OR-**

Enter **0** to transfer to the telephone base. The screen shows **Calling base**. The telephone base rings and its screen shows **HANDSET X is calling**.

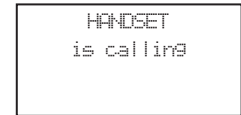

2. To answer the call on the other handset, press **TALK/FLASH**, **INT**, or any dial pad keys (**0-9**, **TONE X** or #). The outside call is still on hold and both handsets now show **Intercom**. You can now talk without the outside caller hearing the conversation.

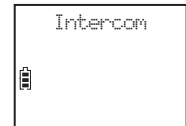

**-OR-**

Press **INTERCOM** or **SPEAKER** on the telephone base or any dial pad keys (**0-9**, **TONE X** or #), or lift the corded handset to answer the intercom call. You can now talk without the outside caller hearing the conversation.

### note

1. To cancel the transfer and return to the external call before the intercom call is answered, press **OFF/Cancel**, **TALK/FLASH** or **INT** on your handset.
2. If the other handset does not answer the intercom call within 100 seconds, or if the other handset is in the directory or call log mode, or is out of range, the calling handset shows **Unable to call. Try again** and automatically returns to the external call.

## Multiple handset use

3. From this intercom call, you have the following options:

- You can transfer the call. Press **MENU/SELECT** twice to highlight **Transfer** on the calling handset. Your screen shows **Call transferred**. The other handset automatically connects to the outside call.
- You can let the other handset join you on the outside call in a three-way conversation. Press **MENU/SELECT**. Press **▼** or **▲** to highlight **Share call** on the calling handset, then press **MENU/SELECT**.
- You can press **INT** on your handset to alternate between the outside call (**Outside call** appears on the screen) and the intercom call (**Intercom** appears on the screen).
- You can end the intercom call and continue the outside call with your originating handset. Press **TALK/FLASH** on your handset (the ended intercom call party hears four beeps), or the other person can press **OFF/CANCEL** on the other system handset.

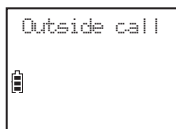
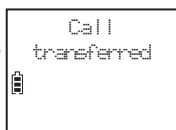
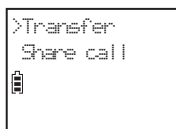

### Using the telephone base:

1. During a call, press **INTERCOM**.

- If you have a single handset system, the telephone base screen shows **Calling HANDSET**. The handset screen shows **Base is calling**.
- If you have more than one handset, the telephone base screen shows **INTERCOM TO:**. Use the dial pad keys to enter a handset number. The telephone base screen then shows **Calling HANDSET X**. The handset screen shows **Base is calling**.

2. To answer the call on the handset, press **TALK/FLASH**, **INT**, **☎**, or any dial pad keys (**0-9**, **TONE X** or **#**). The outside call is still on hold and both base and handset now show **Intercom**. You can now talk without the outside caller hearing the conversation.

3. From this intercom call, you have the following options:

- You can transfer the call. Press **MENU/SELECT** twice to highlight **Transfer** on the telephone base. Your screen shows **Call transferred**. The handset automatically connects to the outside call.
- You can let the handset join you on the outside call in a three-way

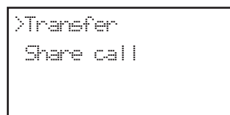

## Multiple handset use

conversation. Press **MENU/SELECT**. Press **▼/CID** or **▲/☎** to highlight **Share call**, then press **MENU/SELECT**.

- You can press **INTERCOM** on the telephone base to alternate between the outside call (**Outside call** appears on the screen) and the intercom call (**Intercom** appears on the screen). Press to alternate.

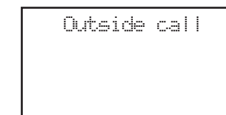
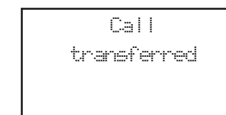

You can end the intercom call and continue the outside call on the telephone base. Press **CANCEL** on the telephone base (the ended intercom call party hears four beeps), or the person at the handset can press **OFF/CANCEL**.

## Directory

### Creating a new directory entry

#### Using a cordless handset:

1. Press **MENU/SELECT** in idle mode to enter the main menu.
2. Press **▼** or **▲** to scroll to **>Directory**, then press **MENU/SELECT**.
3. Press **▼** or **▲** to select **>Add contact**.
4. Press **MENU/SELECT**.
5. Enter the telephone number when prompted.
  - Use the dial pad keys to enter up to 30 digits.
    - Press **▼** or **▲** to move the cursor to the left or right.
    - Press **MUTE/DELETE** to erase a digit.
    - **Press and hold MUTE/DELETE** to erase all digits.
    - **Press and hold REDIAL/PAUSE** to enter a three-second dialing pause (a **p** appears).
    - Copy a number from the redial list by pressing **REDIAL/PAUSE** then **▼** or **▲**, or pressing **REDIAL/PAUSE** repeatedly to locate the number to copy. Press **MENU/SELECT** to copy the number.

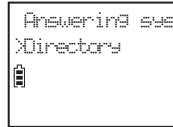

```
Answering sys
>Directory
```



```
Review
>Add Contact
```

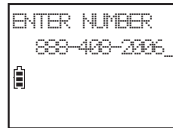

```
ENTER NUMBER
888-400-2006_
```

6. Press **MENU/SELECT** to save the number in the display.

The display shows **Already saved** if the number is already in the directory. You cannot save the same number twice.

7. Enter the name when prompted.
  - Use the dial pad keys to enter a name (up to 15 characters). Each time you press a key, the character on that key appears. Additional key presses produce other characters on that key. See the chart on the next page.

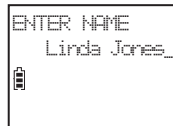

```
ENTER NAME
Linda Jones_
```

- Press **▼** or **▲** to move the cursor to the left or right.
- Press **0** to add a space.
- Press **MUTE/DELETE** to erase a letter.
- **Press and hold MUTE/DELETE** to erase all letters.

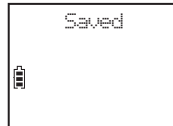

```
Saved
```

#### note

1. The first letter of every word is a capital letter. The remaining letters in a word start as lowercase letters.
2. You cannot store a new number to a full directory until you delete one. The screen shows **Directory full**.

## Directory

8. Press **MENU/SELECT** to store your new directory entry. There is a confirmation tone. The name and the telephone number appear. To change them later, see page 50.

#### Using the telephone base:

1. Press **MENU/SELECT** in idle mode to enter the main menu.
2. Press **▼/CID** or **▲/☞** to scroll to **>Directory**, then press **MENU/SELECT**.
3. Press **▼/CID** or **▲/☞** to highlight **Add contact**.
4. Press **MENU/SELECT**.
5. Enter the telephone number when prompted.
  - Use the dial pad to enter up to 30 digits.
    - Press **▼/CID** or **▲/☞** to move the cursor to the left or right.
    - Press **X/DELETE** to erase a digit.
    - **Press and hold X/DELETE** to erase all digits.
    - **Press and hold REDIAL/PAUSE** to enter a three-second dialing pause (a **p** appears).
    - Copy a number from the redial list by pressing **REDIAL/PAUSE** then **▼/CID** or **▲/☞**, or pressing **REDIAL/PAUSE** repeatedly to locate the number to copy. Press **MENU/SELECT** to copy the number.

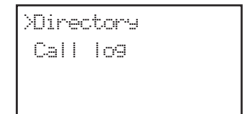

```
>Directory
Call log
```

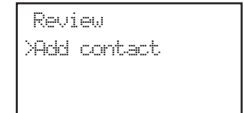

```
Review
>Add contact
```

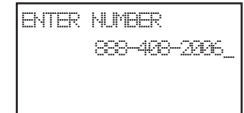

```
ENTER NUMBER
888-400-2006_
```

6. Press **MENU/SELECT** to save the number in the display.

The display shows **Already saved** if the number is already in the directory. You cannot save the same number twice.

7. Enter the name when prompted.
  - Use the dial pad to enter a name (up to 15 characters). Each time you press a key, the character on that key appears. Additional key presses produce other characters on that key. See the chart below.
  - Press **▼/CID** or **▲/☞** to move the cursor to the left or right.
  - Press **X/DELETE** to erase a letter.
  - **Press and hold X/DELETE** to erase all letters.

8. Press **MENU/SELECT** to store your new directory entry. There is a confirmation tone. The name and the telephone number appear. To change them later, see page.

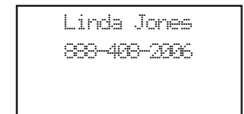

```
Linda Jones
888-400-2006
```



## Directory

### Adding a predialed telephone number to the directory

You can save a predialed telephone number to the directory.

#### Using a cordless handset:

1. Enter the telephone number in idle mode.
  - Use the dial pad keys to enter up to 30 digits.
2. Press **MENU/SELECT** to edit the number.
  - Press **▼** or **▲** to move the cursor to the left or right.
  - Press **MUTE/DELETE** to erase a digit.
  - Press and hold **MUTE/DELETE** to erase all digits.
  - Press and hold **REDIAL/PAUSE** to enter a three-second dialing pause (a **p** appears).
  - Copy a number from the redial list by pressing **REDIAL/PAUSE** then **▼** or **▲**, or pressing **REDIAL/PAUSE** repeatedly to locate the number to copy. Press **MENU/SELECT** to copy the number.
3. Press **MENU/SELECT** again to edit the name (see **To edit an entry** on pages).
4. Press **MENU/SELECT** to save the number to the directory. There is a confirmation tone.

#### Using the telephone base:

1. Enter the telephone number in idle mode.
  - Use the dial pad keys to enter up to 30 digits.
2. Press **MENU/SELECT** to edit the number.
  - Press **▼/CID** or **▲/□** to move the cursor to the left or right.
  - Press **X/DELETE** to erase a digit.
  - Press and hold **X/DELETE** to erase all digits.
  - Press and hold **REDIAL/PAUSE** to enter a three-second dialing pause (a **p** appears).
  - Copy a number from the redial list by pressing **REDIAL/PAUSE** then **▼/CID** or **▲/□**, or pressing **REDIAL/PAUSE** repeatedly to locate the number to copy. Press **MENU/SELECT** to copy the number.
3. Press **MENU/SELECT** again to edit the name (see **To edit an entry** on pages).
4. Press **MENU/SELECT** to save the number to the directory. There is a confirmation tone.

## Directory

### Reviewing directory entries

Using a cordless handset or telephone base:

1. Press **▲/□** on a cordless handset or press **▲/□** on the telephone base when in idle mode to show the first entry in the directory. **Directory empty** appears if there are no directory entries.

**-OR-**

Press **MENU/SELECT** when in idle mode, then press **▼** or **▲** on a cordless handset, or press **▼/CID** or **▲/□** on the telephone base to scroll to **>Directory**. Press **MENU/SELECT** twice.

2. Press **▼** or **▲** on a cordless handset, or press **▼/CID** or **▲/□** on the telephone base to browse through the directory. Entries appear alphabetically by the first letter in the name.

#### **note**

If the telephone number in the directory exceeds 15 digits, **<\*** appears in front of the telephone number. Press **TONE X** to move towards the end of the telephone number or press **#** (pound key) to move towards the beginning of the telephone number.

## Directory

### Searching by name

Follow the steps below to search for directory entries on a cordless handset or the telephone base.

1. Press **▲/☞** on a cordless handset or press **▲/☞** on the telephone base when in idle mode to show the first listing in the directory. **Directory empty** appears if there are no directory entries.
2. When an entry appears, press the dial pad keys (**2-9**) to start a name search. The directory shows the first name beginning with the first letter associated with the dial pad key if there is an entry in the directory beginning with that letter. Press **▼** or **▲** on a cordless handset, or press **▼/CID** or **▲/☞** on the telephone base to scroll through the directory.
3. To see other names starting with the letters on the same dial pad key, keep pressing the key. The names appear in alphabetical order.

For example, if you have the names **Jennifer**, **Jessie**, **Kevin** and **Linda** in your directory:

- If you press **5 (JKL)** once, you see **Jennifer**. If you press **▼/CID** on a cordless handset or press **▼/CID** on the telephone base and you see **Jessie**.
- If you press **5 (JKL)** twice, you see **Kevin**.
- If you press **5 (JKL)** three times, you see **Linda**.
- If you press **5 (JKL)** four times, you see **5** and then the first directory entry under **6 (MNO)**.
- If you press **5 (JKL)** five times, you see **Jennifer** again.

#### note

1. If there is no name matching the first letter of the key you press, the directory shows a name matching the following letters of the key.
2. If you press a key (**2-9**) and no name starts with the letters on that key, the directory shows the entry matching the next letter in the directory.

## Directory

### To dial, delete or edit entries

To dial, delete or edit a directory entry (name and number), the entry must be displayed on the cordless handset or the telephone base screen. Use the directory review or search to show an entry.

#### Display dial

##### To dial a displayed number from the directory:

- Press **TALK/FLASH** or **☎** on a cordless handset.
- OR-
- Press **SPEAKER** **☎** on the telephone base, or lift the corded handset.

#### To delete an entry

To delete a displayed directory entry on a cordless handset, press **MUTE/DELETE** then press **MENU/SELECT**. To delete a displayed directory entry at the telephone base, press **X/DELETE** then press **MENU/SELECT**. You cannot retrieve a deleted entry.

#### To edit an entry

When a directory entry is displayed:

##### Using a cordless handset:

1. To edit an entry, press **MENU/SELECT**, then **▼** or **▲** to highlight **Number**, then press **MENU/SELECT** again.
  - Press the dial pad keys to add digits.
  - Press **▼** or **▲** to move the cursor to the left or right.
  - Press **MUTE/DELETE** to erase a digit.
  - Press and hold **MUTE/DELETE** to erase all digits.
  - Press and hold **REDIAL/PAUSE** to add a three-second pause, if desired.
2. Press **MENU/SELECT** to save the setting. There is a confirmation tone. The updated directory entry appears.
3. To edit the name, press **▼** or **▲** to highlight **Name** and press **MENU/SELECT**.
  - Press the dial pad keys to add characters (page 45).
  - Press **▼** or **▲** to move the cursor to the left or right.

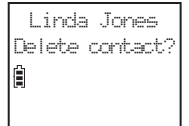

Linda Jones  
Delete contact?  
☎

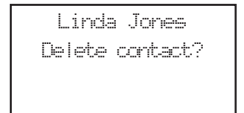

Linda Jones  
Delete contact?  
☎



Mike Smith  
800-490-2005  
☎

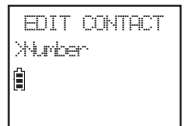

EDIT CONTACT  
>Number  
☎



EDIT NUMBER  
800-490-2005\_  
☎

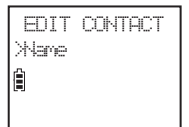

EDIT CONTACT  
>Name  
☎

## Directory

- Press **MUTE/DELETE** to erase a letter.
  - Press and hold **MUTE/DELETE** to erase all letters.
4. Press **MENU/SELECT** to confirm. There is a confirmation tone.

```
EDIT NAME
Mike Smith_
☎
```

### Using the telephone base:

1. To edit an entry, press **MENU/SELECT**, then **▼/CID** or **▲/☎** to highlight **Number**, then press **MENU/SELECT** again.
  - Press the dial pad keys to add digits.
  - Press **▼/CID** or **▲/☎** to move the cursor to the left or right.
  - Press **X/DELETE** to erase a digit.
  - Press and hold **X/DELETE** to erase all digits.
  - Press and hold **REDIAL/PAUSE** to add a three-second pause, if desired.
2. Press **MENU/SELECT** to save the setting. There is a confirmation tone. The updated directory entry appears.
3. To edit the name, press **▼/CID** or **▲/☎** to highlight **Name** and press **MENU/SELECT**.
  - Press the dial pad keys to add characters (page 46).
  - Press **▼/CID** or **▲/☎** to move the cursor to the left or right.
  - Press **X/DELETE** to erase a letter.
  - Press and hold **X/DELETE** to erase all letters.
4. Press **MENU/SELECT** to confirm. There is a confirmation tone.

```
Mike Smith
800-499-2005
```

```
EDIT NUMBER
800-499-2005_
```

```
EDIT NAME
Mike Smith_
```

## Caller ID

### About caller ID

This product supports caller ID services offered by most telephone service providers. Caller ID allows you to see the name, number, date and time of calls. The available caller ID information will appear after the first or second ring.

### Information about caller ID with call waiting

Caller ID with call waiting lets you see the name and telephone number of the caller before answering the call, even while on another call.

It might be necessary to change your telephone service to use this feature. Contact your telephone service provider if:

- You have both caller ID and call waiting, but as separate services (you might need to combine these services).
- You have only caller ID service, or only call waiting service.
- You don't subscribe to caller ID or call waiting services.

There are fees for caller ID services. In addition, services may not be available in all areas.

This product can provide information only if both you and the caller are in areas offering caller ID service and if both telephone service providers use compatible equipment. The time and date, along with the call information, are from the telephone service provider.

Caller ID information might not be available for every incoming call. Callers may intentionally block their names and/or telephone numbers. To view call log entries with numbers between 16 and 24 digits, you must save the entry to the directory (see page 56)

**note** You can use this product with regular caller ID service, or you can use this product's other features without subscribing to caller ID or combined caller ID with call waiting service.

## Caller ID

### How the caller ID history (call log) works

The telephone stores caller ID information about the last 50 incoming calls in the telephone base. Entries are stored in reverse chronological order. The phone deletes the oldest entry when the log is full to make room for new calls. This information is common to all handsets and the base, so changes made using any handset or the telephone base are reflected in all. If you answer a call before the information appears on the screen, it does not show in the caller ID history.

**note** Each entry may have up to 24 digits for the phone number and 15 characters for the name.

### Missed (new) calls indicator

When a cordless handset or the telephone base is in idle mode and has new or missed calls, the screen shows **XX Missed call(s)**.

All new or missed entries are counted as missed calls. Each time you review a call log entry on a cordless handset with the icon **NEW**, or review a call log entry on the telephone base with the icon **NEW**, the number of missed calls decreases by one.

If you do not want to review the missed calls one by one, but you still want to keep them in the caller ID history, when the cordless handset or the telephone base is idle, you can press and hold **OFF/CANCEL** for four seconds on a cordless handset, or press and hold **CANCEL** for four seconds on the telephone base. All the entries in the caller ID history become old (have been reviewed), and the missed calls message goes away.



## Caller ID

### Memory match

If the incoming telephone number matches the last seven digits of a telephone number in your directory, the name that appears on the screen matches the corresponding name in your directory.

For example, if Mike Smith calls, her name appears as **Mike** if this is how you entered it into your directory.

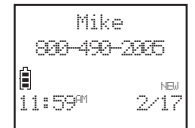

**note** The number shown in the call log will be in the format sent by the telephone service provider. The telephone service provider usually delivers 10-digit phone numbers (area code plus telephone number). If the telephone number of the caller does not match a number in your directory, the name will appear as it is delivered by the telephone service provider.



### To review the caller ID history

Review the caller ID history to find out who called, to return the call, or to copy the caller's name and number into your directory. **Call log empty** appears if there are no records in the call log.

#### Using a cordless handset:

1. When a handset is in idle mode, press **▼/CID** to review the caller ID history in reverse chronological order starting with the most recent call.

**-OR-**

Review the caller ID history by pressing **MENU/SELECT**, then press **▼** or **▲** to scroll to **>Call log**. Press **MENU/SELECT** twice to select **>Review**.

2. Press **▼** or **▲** to scroll through the list.

3. Press **OFF/CANCEL** to exit the caller ID history.

You hear a double beep when the list reaches the beginning or end of the call log.

#### Using the telephone base:

1. When the telephone base is in idle mode, press **▼/CID** to review the caller ID history starting with the most recent call.

**-OR-**

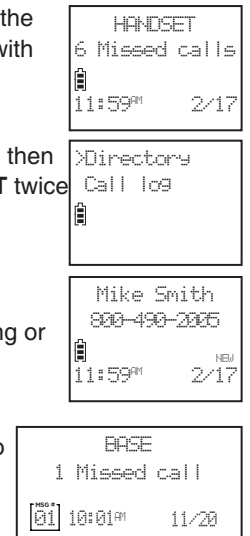

## Caller ID

Review the caller ID history by pressing **MENU/SELECT**, then press **▼/CID** or **▲/☞** to scroll to **>Call log**, then press **MENU/SELECT** twice to select **>Review**.

2. Press **▼/CID** or **▲/☞** to scroll through the list.
3. Press **CANCEL** to exit the caller ID history.

You hear a double beep when the list reaches the beginning or end of the call log. Dial a caller ID log entry

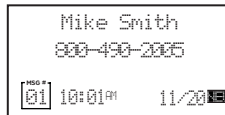
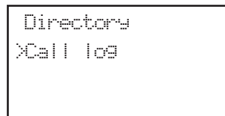

**note** Only one handset or the base can review the caller ID history at a time. If another handset tries to enter the directory or caller ID history, it shows **Not available at this time**.

## View dialing options

Although the incoming call log entries have 10 digits (the area code plus the seven-digit number), in some areas, you might need to dial only the seven digits, 1 plus the seven digits, or 1 plus the area code plus the seven digits. You can change and store the number of digits that you dial in the call log.

While reviewing the call log, press **#** (pound key) repeatedly to show different dialing options for local and long distance numbers before dialing or saving the telephone number in the directory.

Press **1** repeatedly if you need to add or remove 1 in front of the telephone number before dialing or saving it in the directory.

When the number is in the correct format for dialing, press **TALK/FLASH** or **☞** on a cordless handset or press **SPEAKER/☞** or lift the corded handset on the telephone base to call the number.

To save the number to the directory, see **Save a call log entry to the directory** on the next page.

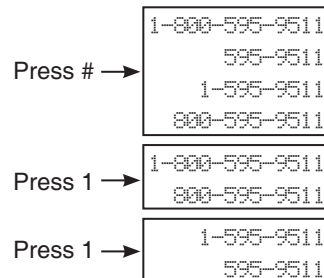

## Caller ID

### Dial a call log entry

To dial a call log entry when in the call log:

#### Using a cordless handset:

1. Press **▼** or **▲** to browse.
2. Press **TALK/FLASH** or **☞** to dial the entry.

#### Using the telephone base:

1. Press **▼/CID** or **▲/☞** to browse.
2. Press **SPEAKER/☞** or lift the corded handset to dial the entry.

## Delete entries

Using a cordless handset or the telephone base:

- Press **MUTE/DELETE** on the cordless handset or **X/DELETE** on the telephone base to delete the displayed entry from the caller ID history.
- Follow the steps below to delete all call log entries.
  1. Press **MENU/SELECT** when in idle mode.
  2. Press **▼** or **▲** on a cordless handset, or press **▼/CID** or **▲/☞** on the telephone base to scroll to **>Call log**, then press **MENU/SELECT**.
  3. Press **▼** or **▲** on a cordless handset, or press **▼/CID** or **▲/☞** on the telephone base to scroll to **>Del all calls**, then press **MENU/SELECT**.
  4. When the screen shows **Delete all calls?** press **MENU/SELECT** to clear the caller ID history of all entries. There is a confirmation tone. Press **OFF/CANCEL** on the cordless handset or **CANCEL** on the telephone base to exit without deleting any entries.

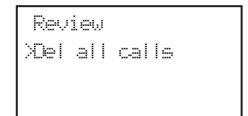
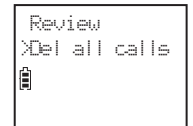

## Save a call log entry to the directory

Using a cordless handset or the telephone base:

1. When in the call log, Press **▼** or **▲** on a cordless handset, or press **▼/CID** or **▲/☞** on the telephone base to browse.
2. Press **MENU/SELECT** to choose an entry. The screen displays **EDIT NUMBER**.
3. Use the dial pad keys to edit the number.
  - Press **▼** or **▲** on a cordless handset, or press **▼/CID** or **▲/☞** on the telephone base to move the cursor to the left or right.

## Answering system settings

- Press **MUTE/DELETE** on the cordless handset or **X/DELETE** on the telephone base to backspace and erase a digit.
  - Press and hold **MUTE/DELETE** on the cordless handset or **X/DELETE** on the telephone base to erase the entire entry.
  - Press and hold **REDIAL/PAUSE** to insert a three-second dialing pause (a **p** appears).
4. Press **MENU/SELECT** to move to the name. The screen displays **EDIT NAME**.
- Use the dial pad keys (see page 45) to add characters.
  - Press **▼** or **▲** on a cordless handset, or press **▼/CID** or **▲/□** on the telephone base to move the cursor to the left and right.
  - Press **MUTE/DELETE** on the cordless handset or **X/DELETE** on the telephone base to erase a letter.
  - Press and hold **MUTE/DELETE** on the cordless handset or **X/DELETE** on the telephone base to erase all letters.
5. Press **MENU/SELECT** when done and the screen shows **Saved**.
- If the entry is already saved in the directory, **Already saved** displays.

### note

You might need to change how a caller ID number is dialed if the entry does not appear in the correct format. Caller ID numbers might appear with an area code that might not be necessary for local calls, or without a 1 that might be necessary for long distance calls (see **View dialing options** on page 55).

## Caller ID log display screen messages

Displays:	When:
PRIVATE NAME	The caller is blocking the name.
PRIVATE NUMBER	The caller is blocking the telephone number.
PRIVATE CALLER	The caller is blocking the name and number.
UNKNOWN NAME	This caller's name is unavailable.
UNKNOWN NUMBER	This caller's number is unavailable.
UNKNOWN CALLER	No information is available about this caller.

## Answering system settings

### Answering system and voicemail

Your telephone has separate indicators for two different types of voice messages: those left on its built-in digital answering system and those left with your telephone service provider's voicemail (fees may apply). Your telephone's built-in digital answering system messages and voicemail messages are separate. Each alerts you to new messages differently.

If  and **New voicemail** display on the handset and the telephone base, your telephone service provider is indicating that it has new voicemail for you. To listen to your voicemail, you typically dial an access number provided by your telephone service provider, followed by a security code or PIN.

Some telephone service providers bundle or combine multiple services like voicemail and call waiting, so you may not be aware that you have voicemail. To check what services you have and how to access them, contact your telephone service provider.

To use your voicemail service rather than your answering system, turn off your answering system. To use your answering system rather than your voicemail service, contact your telephone service provider to deactivate your voicemail service. You can also use your telephone answering system and voicemail together by setting your built-in answering system to answer before voicemail answers as described below. To learn how to program your voicemail settings, contact your telephone service provider. Then, if you are on a call, or if the answering system is busy recording a message and you receive another call, the second caller can leave a voicemail message.

Set your answering system to answer calls at least two rings earlier than your voicemail is set to answer. For example, if your voicemail answers after six rings, set your answering system to answer after four rings. Some voicemail providers may program the delay before answering calls in seconds instead of rings. In this case, allow six seconds per ring when determining the appropriate setting.

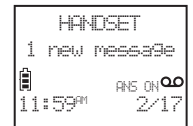

## Answering system settings

### Answering system new message indication

The handset screen shows **QO**, **XX New message(s)** and the **▶/■/PLAY/STOP** indicator on the telephone base flashes when there are new answering system messages.

To listen to the messages, press **MENU/SELECT** twice on the handset or press **▶/■/PLAY/STOP** on the telephone base (page 62).

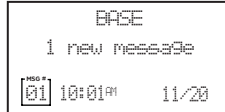

**note** After reviewing new message(s), the number of old message(s) appears on the message window.

### Turn the answering system on or off at the telephone base

Unless you change it, the answering system is on and ready to record messages. You can turn the answering system off, but if you do so, the answering system does not answer calls and record incoming messages.

Press **⏻/ANS ON/OFF** to turn the answering system on or off. If the answering system is turned on, **Calls will be answered** displays and the system announces “Calls will be answered.” If the answering system is turned off, **Calls will not be answered** displays and the system announces “Calls will not be answered.”

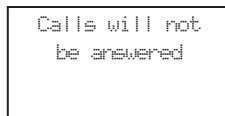
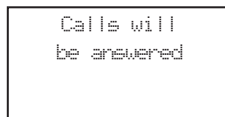
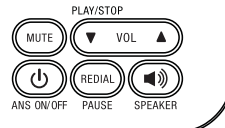

### Message capacity

The answering system can record up to 99 messages, depending on the length of each message. Individual messages can be up to four minutes, and the maximum recording time is approximately 11 minutes. The actual recording time depends on individual message characteristics. Messages remain available for replay until you delete them.

If the answering system has three minutes of recording time left, it announces, “Less than three minutes to record,” before message playback. If the answering system has no time left, it announces, “Memory is full,” before message playback.

If you attempt to turn on the answering system but the memory is low, **Less than 3 min to record** displays on the cordless handset and telephone base screens.

## Answering system settings

If you attempt to turn on the answering system but the memory is full, **Memory full** displays on the cordless handset and telephone base screens. The base also announces, “Memory is full,” then “Calls will not be answered.” The message counter displays the number of messages.

### Voice prompts

The system provides voice prompts for message playback, recording outgoing announcements and during remote access.

**note** When your announcement is deleted, calls are answered with the preset announcement.

### Call screening at the telephone base

If the answering system and call screening are on, the announcement and the incoming message are audible at the telephone base when a call arrives.

You can turn call screening on or off using a cordless handset (see page 21) or using the telephone base. When call screening is off, you can temporarily turn on call screening by pressing **▶/■/PLAY/STOP** on the telephone base. Call screening will be off for the next incoming call.

If call screening is on and you want to silence the telephone base while it is recording messages, press **▶/■/PLAY/STOP** on the telephone base. Call screening will be on for the next call.

### Call intercept

While screening a call, you can stop recording and speak to the caller by pressing **FLASH** or **⏻** on a cordless handset, or pressing **SPEAKER** or lifting the corded handset on the telephone base.

### Base ringer

Press **▼/VOL/▲** on the telephone base to adjust the ringer volume when the telephone is not in use.

You hear a sample of the ringer while adjusting the volume. The telephone base screen shows **Ringer off** and **🔇** when the ringer is off.

## Answering system settings

### Temporarily turn off the message alert tone

If the new message alert tone is turned on (see page 23), the telephone base beeps every 10 seconds when there are new or missed messages. Pressing any telephone base key temporarily silences the message alert tone.

If you press **X/DELETE** when in idle mode to temporarily turn off the message alert tone, there is a voice prompt directing you to press **X/DELETE** again to delete all old messages. The message alert tone is temporarily turned off. Only press **X/DELETE** a second time if you wish to erase all old messages in the answering system.

The message alert tone resumes when you receive another message.

### Message playback

If you have new messages, **▶/■/PLAY/STOP** on the telephone base flashes and only the new messages are played (oldest first). If there are no new messages, the system plays back all the messages (oldest first).

When playback begins, the total number of messages is announced. Before each message, you hear the day and time of the recording. If the date and time are not set, you hear, "Time and date not set," before playback. After the last message, you hear, "End of messages." If the recording time is less than three minutes, you hear, "Less than three minutes to record" (see **Message capacity** on page 60).

#### To listen to messages at the telephone base:

When the telephone base is in idle mode, press **▶/■/PLAY/STOP**.

**-OR-**

Press **MENU/SELECT** twice. If there are only new or old messages, the messages will play automatically. If there are new and old messages, press **▼/CID** or **▲/□** to highlight **Play new msgs** or **Play old msgs** and press **MENU/SELECT**.

#### To listen to messages on a cordless handset:

1. When the handset is in idle mode, press **MENU/SELECT** to enter the main menu.
2. Press **MENU/SELECT** again to select **>Play messages**.
3. If there are only new or old messages, they will play automatically. If there are new and old messages, press **▼** or **▲** to select **>Play new msgs** or **>Play old msgs**, then press **MENU/SELECT**. If there are only new messages, they will play automatically.

The system announces the number of messages, then begins playback. The message sequence is shown on the cordless handset screen or the telephone base screen. If there are no recorded messages, the cordless handset or

## Answering system settings

the telephone base screen shows **No message** and you hear, "You have no messages."

### Options during playback

When a message is playing, you can adjust the playback volume, skip, repeat or delete the message.

#### When messages are playing on the telephone base:

- Press **▼/VOL/▲** to adjust the message playback volume.
- Press **▶/SKIP** to skip to the next message.
- Press **◀/REPEAT** to repeat the message. Press twice to hear the previous message. Press **X/DELETE** to delete the message.
- Press **▶/■/PLAY/STOP** to stop the playback.

#### When messages are playing on the cordless handset:

- Press **▼/VOLUME** or **▲/VOLUME** to adjust the message playback volume.
- Press **6** to skip to the next message.
- Press **4** to repeat the message. Press twice to hear the previous message.
- Press **3** to delete the message.
- Press **5** to stop the playback.
- Press **◀▶** to switch between speakerphone mode and handset mode.

### To delete all old messages

You can only delete old (reviewed) messages. You cannot delete new messages until you review them. You cannot retrieve deleted messages.

#### To delete all old messages on the telephone base:

1. When the telephone is idle, press **X/DELETE**. The system announces, "To delete all old messages, press **DELETE** again." The screen displays **Delete all old messages?**
2. Press **X/DELETE** again. The system announces, "All old messages deleted."

#### To delete all old messages on a cordless handset:

1. Press **MENU/SELECT** when in idle mode to enter the main menu.
2. Press **▼** or **▲** to scroll to **>Answering sys**. Press **MENU/SELECT**.
3. Press **▼** or **▲** to highlight **Delete all old**, then press **MENU/SELECT**. The screen shows **Delete all old messages?**



## Answering system operation

4. Press **MENU/SELECT** again to confirm. The screen displays **Deleting...** then **All old msgs deleted!** There is a confirmation tone. Recording and playing memos

Memos are messages you record at a cordless handset or the telephone base. You can record, playback, and delete them like incoming messages. You can record a memo as a reminder to yourself, or leave a message for others who use the answering system.

### To record a memo

#### Using a cordless handset:

1. When the handset is in idle mode, press **MENU/SELECT** to enter the main menu.
2. Press **▼** or **▲** to scroll to **>Answering sys.** Press **MENU/SELECT**.
3. Press **▼** or **▲** to highlight **Record memo**, then press **MENU/SELECT**. The system announces, *"Record after the tone. Press 5 when you are done."* You can record a memo for up to four minutes.
4. Speak facing the handset to record a memo.
5. Press **5** to stop recording. The system announces, *"Recorded."* The system does not save memos shorter than two seconds.

#### Using the telephone base:

1. When the telephone is in idle mode, press **MENU/SELECT** to enter the main menu.
2. Press **▼/CID** or **▲/☞** to scroll to **>Answering sys.** Press **MENU/SELECT**.
3. Press **▼/CID** or **▲/☞** to highlight **Record memo**, press **MENU/SELECT**. The system announces, *"Record after the tone. Press 5 when you are done."* You can record a memo for up to four minutes.
4. Speak facing the telephone base speakerphone to record a memo.
5. Press **5** to stop recording. The system announces, *"Recorded."* The system does not save memos shorter than two seconds.

### To play back a memo

Play memos the same way as messages. See **Message playback** on page 62.

## Answering system operation

### Message window displays

Window display	Description
0	No message.
1-99	The total number of old messages recorded. The message number currently playing. If <b>XX New message(s)</b> displays on the screen at the same time, there are new messages or memos. If <b>Rec mem full</b> displays on the screen at the same time, the memory is full. You must delete some messages before recording new messages.
-----	The system is answering a call, or recording a memo or announcement. The telephone is answering a call or being accessed remotely. The answering system is being programmed.

## Answering system operation

### Remote access

A two-digit security code is required to access the answering system remotely from any touch-tone telephone. The preset code is **19**; see **Remote access code** on page 46 to change it.

1. Dial your telephone number from any touch-tone telephone.
2. When the system plays your announcement, enter the two-digit security code.
3. Then you can enter one of the following remote commands.

Command	Function
<b>1</b>	Play all messages.
<b>2</b>	Play new messages.
<b>3</b>	Delete the current message (during playback).
<b>33</b>	Delete all old messages.
<b>4</b>	Repeat the current message (during playback).
<b>44</b>	Listen to the previous message (during playback).
<b>5</b>	Stop.
<b>*5</b>	Hear a list of remote commands.
<b>6</b>	Skip to the next message (during playback).
<b>*7</b>	Record a new announcement.
<b>8</b>	End the call.
<b>0</b>	Turn the answering system on or off.

4. Hang up or press **8** to end the call.

#### note

- If you do not press any keys after you enter the remote access code, all new messages play. If there are no new messages, all old messages play.
- Once the new messages have played, the telephone announces the help menu options. If you do not press any key within 20 seconds, the remote access call automatically disconnects.
- When the answering system memory is full, the telephone announces, "Memory is full. Enter the remote access code."

## Appendix

### Handset display screen messages

Already saved	The telephone number you have entered is already in the directory.
BASE Check AC power	The telephone base is on a call while in line power mode.
Call log empty	There are no entries in caller ID history.
Call transferred	You have transferred an outside call to another cordless handset.
Calling base	The handset is calling the base (for intercom calls). The handset is transferring an outside call to the base.
Calling HANDSET (For systems with one handset)	The telephone base is calling the handset (for intercom calls). The telephone base is transferring an outside call to the handset.
Calling HANDSET X (For systems with two or more handsets)	The handset is calling another handset (for intercom calls). The handset is transferring an outside call to another handset.
Call answered	The answering system is answering a call.
Calls will be answered	The answering system is turned on and can answer calls.
Calls will not be answered	The answering system is turned off and cannot answer calls.
Contact deleted	A directory entry is deleted.
Directory empty	There are no directory entries.
Directory full	The directory is full. You cannot save any new entries unless you delete some current entries.
Ended	You have just ended a call.
HANDSET is calling (For systems with one handset)	The handset is calling the telephone base.

## Appendix

HANDSET X is calling (For systems with two or more handsets)	Another system handset is calling.
Incoming call	There is a call coming in.
Int requires two handsets	There are no registered handsets for the telephone base to intercom.
Intercom	The handset is on an intercom call.
Intercom ended	The intercom call has just ended.
INTERCOM TO: (For systems with two or more handsets)	You have started the intercom process, and need to enter the number of the handset you wish to call.
Line in use	An extension phone, or one of the handsets is in use.
Low battery	You should charge the battery.
Microphone ON	Mute is off so the other party can hear your voice.
Muted	The microphone is off. The other party cannot hear you.
New voicemail	There are new voicemail messages from your telephone service provider.
No battery	The handset in the charger has no battery installed.
No line	There is no telephone line connection.
No signal, call ended	The handset is out of range while on a call.
Not available at this time	Someone else is using the directory or caller ID history.
Other handset is calling (For systems with two handsets)	The other handset is calling.
Out of range OR No pur at base	The telephone base has lost power, or the handset is out of range.
Outside call	You are on the external call during call transfer.
**Paging**	The cordless handset is paged by the telephone base.

## Appendix

Paging all handsets	The telephone base is paging the handset(s).
Phone	The handset is on a call.
Place in charger	The battery is very low. The handset should be charged.
1.Press FIND HS on base 4sec	Screen display before handset registration.
Rec mem full	The system recording time is full.
Rec mem low	The system recording time is low.
Recording message	The answering system is recording a message.
Registering... Please wait	The handset screen display when it is registering to the telephone base.
Registration failed	The handset registration is not successful.
Registration slots are full	The system does not allow a 13 <sup>th</sup> handset to be registered to the telephone base.
Ringer off	The ringer is off temporarily during an incoming call.
Saved	The entry in the caller ID history is saved in the directory.
Share call	You can share an outside call with another cordless handset.
Speaker	The handset speakerphone is in use.
Transfer to: (For systems with two or more handsets)	You have started transferring a call, and need to enter the desired handset number.
2.Then press # on handset	Screen display before handset registration.
Unable to call. Line in use	Failed phone call (the telephone line is in use).
Unable to call. Try again	Failed intercom or conference call (there are already two handsets being used).
** Missed calls	There are new calls in the caller ID history.

## Appendix

### Handset and telephone base indicators

#### Handset lights







	On when the handset speakerphone is in use.
<b>CHARGE</b>	On when the handset is charging in the telephone base or charger.

#### Telephone base lights



<b>IN USE</b>	On when the telephone line is in use. On when the answering system is answering a call. On when you are registering a handset. Flashes quickly when there is an incoming call. Flashes when another telephone sharing the same line is in use. Flashes when you are deregistering all handsets.
<b>📞/ANS ON/OFF</b>	On when the answering system is turned on.
<b>SPEAKER </b>	On when the speakerphone is on.
<b>▶/■/PLAY/STOP</b>	Flashes when there are new memos or messages in the answering system.
<b>MUTE</b>	On when mute function is on.

## Appendix

### Handset icons

	The battery icon flashes when the battery is low and needs charging.
	The battery icon animates when the battery is charging.
	The battery icon becomes solid when the battery is fully charged.
	The speakerphone is in use.
	The handset ringer is off.
	There are new voicemail received from your telephone service provider.
<b>ANS ON</b>	The answering system is turned on.
<b>OO</b>	There are new answering system messages.
<b>NEW</b>	There are new caller ID log entries.
<b>MUTE</b>	The microphone is muted.
	The message number currently playing and total number of messages recorded.

#### Telephone base icons

	The telephone base ringer is off.
	There are new voicemail received from your telephone service provider.
<b>NEW</b>	There are new caller ID log entries.
	The message number currently playing and total number of messages recorded.

## Appendix

### Battery

It takes up to 10 hours for the battery to be fully charged. When it is fully charged, you can expect the following performance:

Operation	Operating time
While in handset use (talking*)	Up to seven hours
While in speakerphone mode (talking*)	Up to five hours
While not in use (standby**)	Up to seven days

\*Operating times vary depending on your actual use and the age of the battery.

\*\*Handset is not charging or in use.

The battery needs charging when:

- A new battery is installed in the handset.
- The handset beeps.
- A battery is properly installed and the screen is blank.
- **Low battery** or **Place in charger** displays on the handset screen.

#### CAUTION:

To reduce the risk of fire or injury, read and follow these instructions:

- Use only the battery(ies) provided or equivalent. To order a replacement, go to [www.vtechcanada.com](http://www.vtechcanada.com) or call 1 (800) 267-7377.
- Do not dispose of the battery(ies) in a fire. Check with local waste management codes for special disposal instructions.
- Do not open or mutilate the battery(ies). Released electrolyte is corrosive and may cause burns or injury to the eyes or skin. The electrolyte may be toxic if swallowed.
- Exercise care in handling batteries in order not to create a short circuit with conductive materials.
- Charge the battery(ies) provided with or identified for use with this product only in accordance with the instructions and limitations specified in this manual.
- Observe proper polarity orientation between the battery and metallic contacts.
- To prevent fire or shock hazard, do not expose this product to water or any type of moisture.

## Appendix

### Expand your telephone system

The handset provided with your telephone system is already registered and named **HANDSET**. You can add new handsets (Vtech CS6400, available separately) to your telephone system, but must register each device with the telephone base before use (see page 69). You can register up to 11 additional handsets to the telephone base, and they are assigned numbers in sequential order (**HANDSET 2**, **HANDSET 3**, **HANDSET 4** and so on).

#### Add and register a handset

When first purchased, all expansion handsets alternately show **1.Press FIND HS on base 4sec** and **2.Then press # on handset** on the screen. The new handset should be charged without interruption for at least 30 minutes before registering it to the telephone base.

#### To register a handset:

1. Make sure the handset is out of the charger and alternately shows **1.Press FIND HS on base 4sec** and **2.Then press # on handset** before you begin registration.
2. **Press and hold FIND HANDSET** on the telephone base for about four seconds until the base screen shows **Registering... Please wait**, then release the button.
3. Press # (pound key) on the handset. The screen shows **Registering... Please wait**. It takes up to 60 seconds to complete registration. Then **HANDSET X Registered** appears on the screen, with **X** being the handset number (**1-12**), and the handset beeps. The handset is now registered with the telephone base.

If registration is not successful, the handset screen displays **Registration failed**. Please start again from step one above.

#### note

1. You cannot register a handset if any other system handset is in use.
2. You cannot register more than 12 handsets to the telephone base. **Registration slots are full** shows on the base screen while you are doing step two above.

1.Press FIND HS on base 4sec

2.Then press # on handset

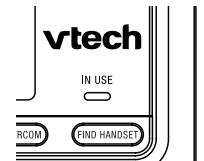

Registering... Please wait

Registering... Please wait

HANDSET X Registered

HANDSET X Registered

## Appendix

### Deregister handsets

If you want to replace a handset, or reassign the designated handset number of a registered handset, you must deregister all handsets that are registered to the telephone base. Then register each handset individually.

To make deregistration easier, read all of the instructions on this page before you begin.

#### To deregister all handsets:

1. Press and hold **FIND HANDSET** on the telephone base for about 10 seconds until the base screen shows **Registering handset...** followed by **Deregister all handsets?**, then release the **FIND HANDSET** button. The base screen shows the deregistration screen.
2. Immediately press **MENU/SELECT**.
3. The deregistration process takes about 60 seconds to complete. All handsets alternately show **1.Press FIND HS on base 4sec** and **2.Then press # on handset**.
4. To register the handset(s) to the telephone base again, follow the registration instructions on the previous page.
5. After you deregister the handset(s), the telephone base is in idle mode but the system date and time information needs to be reset. For instructions, see **Set date/time** on page 27.

#### note

- You cannot deregister all handsets if any other system handset is in use.
- If the deregistration process is not successful, you might need to reset the system and try again. To reset, unplug the power from the telephone base and plug it back in.
- Even if the battery is depleted, you can still deregister the handset by following the steps above. After the handset is charged for at least 10 minutes, the screen shows **1.Press HS LOC on base 4sec** and **2.Then press # on handset**.

## Appendix

### Troubleshooting

If you have difficulty with your telephone, please try the suggestions below. For customer service, visit our website at [www.vtechcanada.com](http://www.vtechcanada.com) or call 1 (800) 267-7377.

#### My telephone doesn't work at all.

- Make sure the power cord is securely plugged in.
- Make sure you plug the battery connector securely into the cordless handset.
- Make sure you plug the telephone line cord securely and firmly into the telephone base and the telephone wall jack.
- Charge the battery in the cordless handset for at least 16 hours. For optimum daily performance, return the cordless handset to the handset charger when not in use.
- If the battery is depleted, it might take approximately 30 minutes to charge the handset before it shows **Low battery**, see page 7 for details.
- Reset the telephone base. Unplug the electrical power. Wait for approximately 15 seconds, then plug it back in. Allow up to one minute for the cordless handset and telephone base to reset.
- You may need to purchase a new battery. Please refer to **Battery installation and charging** in this user's manual on pages 7-8.

#### I cannot get a dial tone.

- First try all the suggestions above.
- Move the cordless handset closer to the telephone base. You might have moved out of range.
- If the previous suggestions do not work, disconnect the telephone base from the telephone jack and connect to a different phone. If there is no dial tone on that phone either, the problem is in your wiring or telephone service. Contact your telephone service provider.
- Your line cord might be malfunctioning. Try installing a new line cord.

#### I cannot dial out.

- First try all the suggestions above.
- Make sure you have a dial tone before dialing. The cordless handset might take a second or two to find the telephone base and produce a dial tone. This is normal. Wait an extra second before dialing.
- Eliminate any background noise. Noise from a television, radio or other appliances might cause the phone to not dial out properly. If you cannot eliminate the background noise, first try muting the cordless handset before dialing, or dialing from another room with less background noise.
- If the other phones in your home are having the same problem, contact your telephone service provider (charges may apply).

## Appendix

### Troubleshooting

#### My cordless handset isn't performing normally.

- Make sure you plug the power cord securely into the telephone base. Plug the power adapter into a different, working electrical outlet without a wall switch.
- Move the cordless handset closer to the telephone base. You might have moved out of range.
- Reset the telephone base. Unplug the electrical power. Wait for 15 seconds then plug it back in. Allow up to one minute for the cordless handset and telephone base to reset.
- Other electronic products such as HAM Radios and other DECT phones can cause interference with your cordless phone. Try installing your phone as far away as possible from these types of electronic devices.

#### Out of range OR No pwr at base appears on my cordless handset.

- Ensure you plug the telephone base in properly and the power is on.
- Place the cordless handset closer to the telephone base for synchronization.
- Move the cordless handset closer to the telephone base. You might have moved out of range.
- Reset the telephone base. Unplug the electrical power. Wait for 15 seconds then plug it back in. Allow up to one minute for the cordless handset and telephone base to reset.
- Other electronic products such as HAM Radios and other DECT phones can cause interference with your cordless phone. Try installing your phone as far away as possible from these types of electronic devices.

#### The batteries do not hold a charge.

- If the cordless handset is in the handset charger and the charge light is not on, refer to **The charge light is off or blinking** (page 79).
- Charge the battery in the cordless handset for at least 16 hours. For optimum daily performance, return the cordless handset to the charger when not in use.
- If the battery is depleted, it might take approximately 30 minutes to charge the handset before it shows **Low battery**, refer to the table on page 7 for details.
- You might need to purchase a new battery. Please refer to **Battery installation and charging** in this user's manual on pages 7-8.

## Appendix

### Troubleshooting

#### I get noise, static, or weak signals even when I'm near the telephone base.

- If you subscribe to high-speed Internet service (DSL - digital subscriber line) through your telephone line, you must install a DSL filter between the telephone line cord and the telephone wall jack (see page 5). The filter prevents noise and caller ID problems as a result of DSL interference. Please contact your DSL service provider for more information about DSL filters.
- You may be able to improve the performance of your cordless phone by installing your new telephone base as far as possible from any other existing cordless telephone system that may already be installed.
- Other electronic products such as HAM Radios and other DECT phones can cause interference with your cordless phone. Try installing your phone as far away as possible from these types of electronic devices.
- Do not install this phone near a microwave oven or on the same electrical outlet. You might experience decreased performance while the microwave oven is operating.
- If you plug your phone in with a modem or a surge protector, plug the phone (or modem/surge protector) into a different location. If this does not solve the problem, relocate your phone or modem farther apart from one another, or use a different surge protector.
- Relocate your phone to a higher location. The phone might have better reception in a high area.
- If the other phones in your home are having the same problem, contact your telephone service provider (charges may apply).

#### I experience poor sound quality when using the speakerphone.

- For increased sound quality while using the speakerphone, place the handset on a flat surface with the dial pad facing up.

#### I hear other calls while using my phone.

- Disconnect the telephone base from the telephone jack, and plug in a different telephone. If you still hear other calls, call your telephone service provider.

#### The telephone does not ring when there is an incoming call.

- Make sure that the ringer is not off. Refer to **Ringer volume** on page 24 in this user's manual.
- Make sure you plug in the telephone line cord securely into the telephone base and the telephone jack. Make sure you plug in the power cord securely.
- The cordless handset may be too far from the telephone base.
- Charge the battery in the cordless handset for at least 16 hours. For optimum daily performance, return the cordless handset to the handset charger when not in use.
- You may have too many extension phones on your telephone line to allow all of them to ring simultaneously. Try unplugging some of the other phones.

## Appendix

### Troubleshooting

- The layout of your home or office might be limiting the operating range. Try moving the telephone base to another location, preferably to a higher location.
- If the other phones in your home are having the same problem, contact your telephone service provider (charges may apply).
- Test a working phone at the phone jack. If another phone has the same problem, contact your telephone service provider (charges may apply).
- Other electronic products such as HAM Radios and other DECT phones can cause interference with your cordless phone. Try installing your phone as far away as possible from these types of electronic devices.
- Remove and install the battery again. Place the cordless handset in the telephone base. Wait for the cordless handset to reestablish its connection with the telephone base. Allow up to one minute for this to take place.
- Your line cord might be malfunctioning. Try installing a new line cord.

#### My calls cut in and out while I'm using my cordless handset.

- Other electronic products such as HAM Radios and other DECT phones can cause interference with your cordless phone. Try installing your phone as far away as possible from these types of electronic devices.
- Do not install this phone near a microwave oven or on the same electrical outlet. You might experience decreased performance while the microwave oven is operating.
- If you plug your phone in with a modem or surge protector, plug the phone (or modem/surge protector) into a different location. If this does not solve the problem, relocate your phone or modem farther apart from one another, or use a different surge protector.
- Relocate your telephone base to a higher location. The phone might have better reception when installed in a high area.
- If the other phones in your home are having the same problem, contact your telephone service provider (charges may apply).

#### The charge light is off or blinking.

- Make sure you plug the power and line cords in correctly and securely.
- Unplug the electrical power. Wait for 15 seconds, then plug it back in. Allow up to one minute for the cordless handset and telephone base to reset.
- Clean the cordless handset and telephone base charging contacts each month with a pencil eraser or cloth.
- A blinking **CHARGE** light is an indication that the battery is not connected to the handset or missing completely. Ensure that the battery is installed properly.

#### My caller ID isn't working.

- Caller ID is a subscription service. You must subscribe to this service from your telephone service provider for this feature to work on your phone.

## Appendix

### Troubleshooting

- The caller must be calling from an area that supports caller ID.
- Both you and your caller's telephone service providers must use caller ID compatible equipment.
- If you subscribe to high-speed Internet service (DSL - digital subscriber line) through your telephone line, you must install a DSL filter between the telephone line cord and the telephone wall jack (page 5). The filter prevents noise and caller ID problems resulting from DSL interference. Please contact your DSL service provider for more information about DSL filters.

#### System does not receive caller ID when on a call.

- Make sure you subscribe to caller ID with call waiting features from your telephone service provider. Caller ID feature works only if both you and the caller are in areas offering caller ID service, and if both telephone service providers use compatible equipment.

#### Incomplete messages.

- If a caller leaves a very long message, part of it may be lost when the system disconnects the call after four minutes.
- If the caller pauses for longer than seven seconds, the system stops recording and disconnects the call.
- If the system's memory becomes full during a message, the system stops recording and disconnects the call.
- If the caller's voice is very soft, the system may stop recording and disconnect the call.

#### Difficulty hearing messages.

- Press **▲/VOL** to increase the telephone base speaker volume.
- Press **▲/VOLUME** on a cordless handset to adjust the message playback volume.

#### System does not answer after the correct number of rings.

- Make sure that the answering system is on. **ANS ON** should show on the handset and **⓪/ANS ON/OFF** light on the telephone base should be on.
- If toll saver is activated, the number of rings changes to two when you have new messages stored (page 21).
- If the memory is full or the system is off, the system will answer after 10 rings.
- In some cases, the answering system is affected by the ringing system used by your telephone service provider.
- If you subscribe to voicemail service, change the number of rings so that your answering system answers before your voicemail answers (page 59). To determine how many rings activate your voicemail, contact your telephone service provider.



## Appendix

### Troubleshooting

- If there is a fax machine connected to the same telephone line, try disconnecting the fax machine. If that solves the problem, consult your fax machine documentation for information on compatibility with answering systems.

#### System does not respond to remote commands.

- Make sure to enter your remote access code correctly (page 22).
- Make sure you are calling from a touch-tone phone. When you dial a number, you should hear tones. If you hear clicks, the phone is not a touch-tone telephone and cannot activate the answering system.
- The answering system may not detect the remote access code while your announcement is playing. Try waiting until the announcement is over before entering the code.
- There may be interference on the phone line you are using. Press dial pad keys firmly.

#### System does not record messages.

- Make sure the answering system is on. **ANS ON** should show on the handset and **📞/ANS ON/OFF** light on the telephone base should be on.
- Make sure the memory of the answering system is not full.
- If you subscribe to voicemail service, change the number of rings so that your answering system answers before your voicemail answers (page 59). To determine how many rings activate your voicemail, contact your telephone service provider.
- If there is a fax machine connected to the same telephone line, try disconnecting the fax machine. If that solves the problem, consult your fax machine documentation for information on compatibility with answering systems.

#### System announces “*Time and day not set.*”

- You need to reset the system clock (page 15).

#### Outgoing announcement is not clear.

- When you record your announcement, make sure you speak in a normal tone of voice, about nine inches from the handset.
- Make sure there is no background noise (TV, music, etc.) while recording.

## Appendix

### Troubleshooting

#### New voicemail and **📞** show on the handset display and I don't know why.

- Your telephone has both a built-in answering system and voicemail indication. If **New voicemail** and **📞** appear on the handset display, then your telephone has received a signal from your telephone service provider that you have a voicemail message waiting for you to retrieve from them. Contact your telephone service provider for more information on how to access your voicemail.

#### I cannot retrieve voicemail messages.

- Your telephone has both a built-in answering system and voicemail indication. They are independent features and each alerts you to new messages differently (page 59). If you subscribe to voicemail service from your telephone service provider, contact your telephone service provider for more information on how to access your voicemail.

#### I subscribe to a nontraditional telephone service that uses my computer to establish connections, and my telephone doesn't work.

- Make sure your computer is powered on.
- Make sure your Internet connection is working properly.
- Make sure that the software is installed and running for your nontraditional telephone service.
- Make sure to plug your USB telephone adapter into a dedicated USB port on your computer. Do not plug into a multiple port USB hub (USB splitter) that is not powered.
- In a few rare instances, the USB port on your computer may not have enough power. In these instances, try using a USB hub with its own external power supply.
- If you are using a firewall, it may prevent access to your nontraditional telephone service provider. Contact your service provider for more information.

#### Common cure for electronic equipment.

If the telephone does not seem to be responding normally, try putting the cordless handset in the handset charger. If it does not seem to respond, do the following (in the order listed):

- Disconnect the power to the telephone base.
- Disconnect the cordless handset battery.
- Wait a few minutes.
- Connect power to the telephone base.
- Install the battery again, and place the cordless handset into the handset charger.
- Wait for the cordless handset to reestablish its connection with the telephone base. Allow up to one minute for this to take place.

## Appendix

### Important safety instructions

When using your telephone equipment, basic safety precautions should always be followed to reduce the risk of fire, electric shock and injury, including the following:

1. Read and understand all instructions.
2. Follow all warnings and instructions marked on the product.
3. Unplug this product from the wall outlet before cleaning. Do not use liquid or aerosol cleaners. Use a damp cloth for cleaning.
4. Do not use this product near water such as near a bath tub, wash bowl, kitchen sink, laundry tub or swimming pool, or in a wet basement or shower.
5. Do not place this product on an unstable table, shelf, stand or other unstable surfaces.
6. Slots and openings in the back or bottom of the telephone base and handset are provided for ventilation. To protect them from overheating, these openings must not be blocked by placing the product on a soft surface such as a bed, sofa or rug. This product should never be placed near or over a radiator or heat register. This product should not be placed in any area where proper ventilation is not provided.
7. This product should be operated only from the type of power source indicated on the marking label. If you are not sure of the type of power supply in your home or office, consult your dealer or local power company.
8. Do not allow anything to rest on the power cord. Do not install this product where the cord may be walked on.
9. Never push objects of any kind into this product through the slots in the telephone base or handset because they may touch dangerous voltage points or create a short circuit. Never spill liquid of any kind on the product.
10. To reduce the risk of electric shock, do not disassemble this product, but take it to an authorized service facility. Opening or removing parts of the telephone base or handset other than specified access doors may expose you to dangerous voltages or other risks. Incorrect reassembling can cause electric shock when the product is subsequently used.
11. Do not overload wall outlets and extension cords.
12. Unplug this product from the wall outlet and refer servicing to an authorized service facility under the following conditions:
  - When the power supply cord or plug is damaged or frayed.
  - If liquid has been spilled onto the product.
  - If the product has been exposed to rain or water.
  - If the product does not operate normally by following the operating instructions. Adjust only those controls that are covered by the operation instructions. Improper adjustment of other controls may result in damage and often requires extensive work by an authorized technician to restore the product to normal operation.
  - If the product has been dropped and the telephone base and/or handset has been damaged.
  - If the product exhibits a distinct change in performance.
13. Avoid using a telephone (other than cordless) during an electrical storm. There is a remote risk of electric shock from lightning.
14. Do not use the telephone to report a gas leak in the vicinity of the leak. Under certain circumstances, a spark may be created when the adapter is plugged into the power outlet, or when the handset is replaced in its cradle. This is a common event associated with the closing of any electrical circuit. The user should not plug the phone into a power outlet, and should not put a charged handset into the cradle, if the phone is located in an environment containing concentrations of flammable or flame-supporting gases, unless there is adequate ventilation. A spark in such an environment could create a fire or explosion. Such environments might include: medical use of oxygen without adequate ventilation; industrial gases (cleaning solvents; gasoline vapors; etc.); a leak of natural gas; etc.
15. Only put the handset of your telephone next to your ear when it is in normal talk mode.
16. The power adapters are intended to be correctly oriented in a vertical or floor mount position. The prongs are not designed to hold the plug in place if it is plugged into a ceiling, under-the-table or cabinet outlet.

**SAVE THESE INSTRUCTIONS**

## Appendix

### Precautions for users of implanted cardiac pacemakers

Cardiac pacemakers (applies only to digital cordless telephones):

Wireless Technology Research, LLC (WTR), an independent research entity, led a multidisciplinary evaluation of the interference between portable wireless telephones and implanted cardiac pacemakers. Supported by the U.S. Food and Drug Administration, WTR recommends to physicians that:

#### Pacemaker patients



- Should keep wireless telephones at least six inches from the pacemaker.
- Should NOT place wireless telephones directly over the pacemaker, such as in a breast pocket, when it is turned ON.
- Should use the wireless telephone at the ear opposite the pacemaker.

WTR's evaluation did not identify any risk to bystanders with pacemakers from other persons using wireless telephones.

### Operating range

This cordless telephone operates with the maximum power allowed by the Federal Communications Commission (FCC). Even so, this handset and telephone base can communicate over only a certain distance - which can vary with the locations of the telephone base and handset, the weather, and the layout of your home or office.

When the handset is out of range, the handset displays **Out of range OR No pwr at base**.

If there is a call while the handset is out of range, it may not ring, or if it does ring, the call may not connect well when you press /FLASH. Move closer to the telephone base, then press /FLASH to answer the call.

If the handset moves out of range during a telephone conversation, there may be interference. To improve reception, move closer to the telephone base.

### Maintenance

#### Taking care of your telephone

Your cordless telephone contains sophisticated electronic parts, so it must be treated with care.

#### Avoid rough treatment

Place the handset down gently. Save the original packing materials to protect your telephone if you ever need to ship it.

#### Avoid water

Your telephone can be damaged if it gets wet. Do not use the handset outdoors in the rain, or handle it with wet hands. Do not install the telephone base near a sink, bathtub or shower.

#### Electrical storms

Electrical storms can sometimes cause power surges harmful to electronic equipment. For your own safety, take caution when using electrical appliances during storms.

#### Cleaning your telephone

Your telephone has a durable plastic casing that should retain its luster for many years. Clean it only with a soft cloth slightly dampened with water or mild soap. Do not use excess water or cleaning solvents of any kind.

Remember that electrical appliances can cause serious injury if used when you are wet or standing in the water. If the telephone base should fall into the water, DO NOT RETRIEVE IT UNTIL YOU UNPLUG THE POWER CORD AND TELEPHONE LINE CORD FROM THE WALL. Then remove the telephone by the unplugged cords.

## Appendix

### About cordless telephones

- **Privacy:** The same features that make a cordless telephone convenient create some limitations. Telephone calls are transmitted between the telephone base and the cordless handset by radio waves, so there is a possibility that the cordless telephone conversations could be intercepted by radio receiving equipment within range of the cordless handset. For this reason, you should not think of cordless telephone conversations as being as private as those on corded telephones.
- **Electrical power:** The telephone base of this cordless telephone must be connected to a working electrical outlet. The electrical outlet should not be controlled by a wall switch. Calls cannot be made from the cordless handset if the telephone base is unplugged, switched off or if the electrical power is interrupted.
- **Potential TV interference:** Some cordless telephones operate at frequencies that may cause interference to televisions and VCRs. To minimize or prevent such interference, do not place the telephone base of the cordless telephone near or on top of a TV or VCR. If interference is experienced, moving the cordless telephone farther away from the TV or VCR often reduces or eliminates the interference.
- **Rechargeable batteries:** Exercise care in handling batteries in order not to create a short circuit with conducting material such as rings, bracelets and keys. The battery or conductor may overheat and cause harm. Observe proper polarity between the battery and the battery charger.
- **Nickel-metal hydride rechargeable batteries:** Dispose of these batteries in a safe manner. Do not burn or puncture the battery. Like other batteries of this type, if burned or punctured, they could release caustic material which could cause injury.

### The RBRC® seal

The RBRC® seal on the nickel-metal hydride battery indicates that VTech Communications, Inc. is voluntarily participating in an industry program to collect and recycle these batteries at the end of their useful lives, when taken out of service within the United States and Canada.

The RBRC® program provides a convenient alternative to placing used nickel-metal hydride batteries into the trash or municipal waste, which may be illegal in your area.

VTech's participation in RBRC® makes it easy for you to drop off the spent battery at local retailers participating in the RBRC® program or at authorized VTech product service centers. Please call **1 (800) 8 BATTERY™** for information on Ni-MH battery recycling and disposal bans/restrictions in your area. VTech's involvement in this program is part of its commitment to protecting our environment and conserving natural resources.

**RBRC® is a registered trademark of Rechargeable Battery Recycling Corporation.**



## Appendix

### FCC, ACTA and IC regulations

#### FCC Part 15

This equipment has been tested and found to comply with the requirements for a Class B digital device under Part 15 of the Federal Communications Commission (FCC) rules. These requirements are intended to provide reasonable protection against harmful interference in a residential installation. This equipment generates, uses and can radiate radio frequency energy and, if not installed and used in accordance with the instructions, may cause harmful interference to radio communications. However, there is no guarantee that interference will not occur in a particular installation. If this equipment does cause harmful interference to radio or television reception, which can be determined by turning the equipment off and on, the user is encouraged to try to correct the interference by one or more of the following measures:

- Reorient or relocate the receiving antenna.
- Increase the separation between the equipment and receiver.
- Connect the equipment into an outlet on a circuit different from that to which the receiver is connected.
- Consult the dealer or an experienced radio/TV technician for help.

Changes or modifications to this equipment not expressly approved by the party responsible for compliance could void the user's authority to operate the equipment.

This device complies with Part 15 of the FCC rules. Operation is subject to the following two conditions: (1) this device may not cause harmful interference, and (2) this device must accept any interference received, including interference that may cause undesired operation. Privacy of communications may not be ensured when using this telephone.

To ensure safety of users, the FCC has established criteria for the amount of radio frequency energy that can be safely absorbed by a user or bystander according to the intended usage of the product. This product has been tested and found to comply with the FCC criteria. The handset may be safely held against the ear of the user. The telephone base shall be installed and used such that parts of the user's body other than the hands are maintained at a distance of approximately 20 cm (8 inches) or more.

This Class B digital apparatus complies with Canadian ICES-003.

#### FCC Part 68 and ACTA

This equipment complies with Part 68 of the FCC rules and with technical requirements adopted by the Administrative Council for Terminal Attachments (ACTA). The label on the back or bottom of this equipment contains, among other things, a product identifier in the format US:AAAEQ#TXXXX. This identifier must be provided to your telephone service provider upon request.

The plug and jack used to connect this equipment to premises wiring and the telephone network must comply with applicable Part 68 rules and technical requirements adopted by ACTA. A compliant telephone cord and modular plug is provided with this product. It is designed to be connected to a compatible modular jack that is also compliant. An RJ11 jack should normally be used for connecting to a single line and an RJ14 jack for two lines. See the installation instructions in the user's manual.

The Ringer Equivalence Number (REN) is used to determine how many devices you may connect to your telephone line and still have them ring when you are called. The REN for this product is encoded as the 6th and 7th characters following the US: in the product identifier (e.g., if ## is 03, the REN is 0.3). In most, but not all areas, the sum of all RENs should be five (5.0) or less. For more information, contact your telephone service provider.

This equipment may not be used with Party Lines. If you have specially wired alarm dialing equipment connected to your telephone line, ensure the connection of this equipment does not disable your alarm equipment. If you have questions about what will disable alarm equipment, consult your telephone service provider or a qualified installer.

## Appendix

### FCC, ACTA and IC regulations

If this equipment is malfunctioning, it must be unplugged from the modular jack until the problem has been corrected. Repairs to this telephone equipment can only be made by the manufacturer or its authorized agents. For repair procedures, follow the instructions outlined under the Limited warranty.

If this equipment is causing harm to the telephone network, the telephone service provider may temporarily discontinue your telephone service. The telephone service provider is required to notify you before interrupting service. If advance notice is not practical, you will be notified as soon as possible. You will be given the opportunity to correct the problem and the telephone service provider is required to inform you of your right to file a complaint with the FCC. Your telephone service provider may make changes in its facilities, equipment, operation, or procedures that could affect the proper functioning of this product. The telephone service provider is required to notify you if such changes are planned.

If this product is equipped with a corded or cordless handset, it is hearing aid compatible.

If this product has memory dialing locations, you may choose to store emergency telephone numbers (e.g., police, fire, medical) in these locations. If you do store or test emergency numbers, please:

Remain on the line and briefly explain the reason for the call before hanging up.

Perform such activities in off-peak hours, such as early morning or late evening.

### Industry Canada

Operation is subject to the following two conditions: (1) this device may not cause harmful interference, and (2) this device must accept any interference, including interference that may cause undesired operation.

The term "IC:" before the certification/registration number only signifies that the Industry Canada technical specifications were met.

The Ringer Equivalence Number (REN) for this terminal equipment is 0.8. The REN is an indication of the maximum number of devices allowed to be connected to a telephone interface. The termination on an interface may consist of any combination of devices subject only to the requirement that the sum of the RENs of all the devices does not exceed five.

This product meets the applicable Industry Canada technical specifications.

## Appendix

### Limited warranty

#### What does this limited warranty cover?

The manufacturer of this VTech Product warrants to the holder of a valid proof of purchase ("Consumer" or "you") that the Product and all accessories provided in the sales package ("Product") are free from defects in material and workmanship, pursuant to the following terms and conditions, when installed and used normally and in accordance with the Product operating instructions. This limited warranty extends only to the Consumer for Products purchased and used in the United States of America and Canada.

#### What will VTech do if the Product is not free from defects in materials and workmanship during the limited warranty period ("Materially Defective Product")?

During the limited warranty period, VTech's authorized service representative will repair or replace at VTech's option, without charge, a Materially Defective Product. If we repair the Product, we may use new or refurbished replacement parts. If we choose to replace the Product, we may replace it with a new or refurbished Product of the same or similar design. We will retain defective parts, modules, or equipment. Repair or replacement of the Product, at VTech's option, is your exclusive remedy. VTech will return the repaired or replacement Products to you in working condition. You should expect the repair or replacement to take approximately 30 days.

#### How long is the limited warranty period?

The limited warranty period for the Product extends for ONE (1) YEAR from the date of purchase. If VTech repairs or replaces a Materially Defective Product under the terms of this limited warranty, this limited warranty also applies to repaired or replacement Product for a period of either (a) 90 days from the date the repaired or replacement Product is shipped to you or (b) the time remaining on the original one-year warranty; whichever is longer.

#### What is not covered by this limited warranty?

This limited warranty does not cover:

1. Product that has been subjected to misuse, accident, shipping or other physical damage, improper installation, abnormal operation or handling, neglect, inundation, fire, water or other liquid intrusion; or
2. Product that has been damaged due to repair, alteration or modification by anyone other than an authorized service representative of VTech; or
3. Product to the extent that the problem experienced is caused by signal conditions, network reliability, or cable or antenna systems; or
4. Product to the extent that the problem is caused by use with non-VTech accessories; or
5. Product whose warranty/quality stickers, product serial number plates or electronic serial numbers have been removed, altered or rendered illegible; or
6. Product purchased, used, serviced, or shipped for repair from outside the United States of America or Canada, or used for commercial or institutional purposes (including but not limited to Products used for rental purposes); or
7. Product returned without a valid proof of purchase (see item 2 below); or
8. Charges for installation or set up, adjustment of customer controls, and installation or repair of systems outside the unit.

## Appendix

### Limited warranty

#### How do you get warranty service?

To obtain warranty service, please visit our website at [www.vtechphones.com](http://www.vtechphones.com), or call 1 (800) 595-9511. In Canada, go to [www.vtechcanada.com](http://www.vtechcanada.com), or call 1 (800) 267-7377.

**NOTE:** Before calling for service, please review the user's manual - a check of the Product's controls and features may save you a service call.

Except as provided by applicable law, you assume the risk of loss or damage during transit and transportation and are responsible for delivery or handling charges incurred in the transport of the Product(s) to the service location. VTech will return repaired or replaced Product under this limited warranty. Transportation, delivery or handling charges are prepaid. VTech assumes no risk for damage or loss of the Product in transit. If the Product failure is not covered by this limited warranty, or proof of purchase does not meet the terms of this limited warranty, VTech will notify you and will request that you authorize the cost of repair prior to any further repair activity. You must pay for the cost of repair and return shipping costs for the repair of Products that are not covered by this limited warranty.

#### What must you return with the Product to get warranty service?

1. Return the entire original package and contents including the Product to the VTech service location along with a description of the malfunction or difficulty; and
2. Include a "valid proof of purchase" (sales receipt) identifying the Product purchased (Product model) and the date of purchase or receipt; and
3. Provide your name, complete and correct mailing address, and telephone number.

#### Other limitations

This warranty is the complete and exclusive agreement between you and VTech. It supersedes all other written or oral communications related to this Product. VTech provides no other warranties for this Product. The warranty exclusively describes all of VTech's responsibilities regarding the Product. There are no other express warranties. No one is authorized to make modifications to this limited warranty and you should not rely on any such modification.

State/Provincial Law Rights: This warranty gives you specific legal rights, and you may also have other rights, which vary from state to state or province to province.

Limitations: Implied warranties, including those of fitness for a particular purpose and merchantability (an unwritten warranty that the Product is fit for ordinary use) are limited to one year from the date of purchase. Some states/provinces do not allow limitations on how long an implied warranty lasts, so the above limitation may not apply to you. In no event shall VTech be liable for any indirect, special, incidental, consequential, or similar damages (including, but not limited to lost profits or revenue, inability to use the Product or other associated equipment, the cost of substitute equipment, and claims by third parties) resulting from the use of this Product. Some states/provinces do not allow the exclusion or limitation of incidental or consequential damages, so the above limitation or exclusion may not apply to you.

**Please retain your original sales receipt as proof of purchase.**

## Appendix

### Technical specifications

Frequency Control	Crystal controlled PLL synthesizer
Transmit frequency	Handset: 1921.536-1928.448 MHz Telephone base: 1921.536-1928.448 MHz
Channels	5
Nominal effective range	Maximum power allowed by FCC and IC. Actual operating range may vary according to environmental conditions at the time of use.
Power requirements	Handset: 2.4V Ni-MH battery Telephone base: 6V DC @ 400mA Charger: 6V AC @ 300mA
Memory	Handset directory: 50 memory locations; up to 30 digits and 15 characters Handset caller ID log: 50 memory locations; up to 24 digits and 15 characters

VTECH TELECOMMUNICATIONS LTD.

A member of THE VTECH GROUP OF COMPANIES.

Distributed in the U.S.A. by VTech Communications, Inc., Beaverton, Oregon 97008.

Distributed in Canada by VTech Technologies Canada Ltd., Richmond, B.C. V6W 1L5.

Copyright © 2011 for VTECH TELECOMMUNICATIONS LTD.

Printed in China.

91-004310-010-100

**vtech**<sup>®</sup>  
Innovation Beyond Technology™