

# vtech®

## User's manual VM311/VM311-2

### Safe & Sound™ Full Color Video and Audio Monitor



#### Congratulations

on purchasing your new VTech product. Before using this product, please read **Important safety instructions**.

For support, shopping, and everything new at VTech, visit our website at [www.vtechphones.com](http://www.vtechphones.com).

**Register online to get an additional 3-month warranty!**

Visit [www.vtechphones.com](http://www.vtechphones.com).

**Registration**  
Register your product online for enhanced warranty support.

**Product news**  
Learn about the latest VTech products.

### Important safety instructions

When using your equipment, basic safety precautions should always be followed to reduce the risk of fire, electric shock and injury, including the following:

- Follow all warnings and instructions marked on the product.
- Adult setup is required.
- This product is intended as an aid. It is not a substitute for responsible and proper adult supervision and should not be used as such.
- This product is not intended for use as a medical monitor.
- Do not use this product near water. For example, do not use it next to a bath tub, wash bowl, kitchen sink, laundry tub or swimming pool, or in a wet basement or shower.
- CAUTION:** Use only the batteries indicated in this manual. There may be a risk of explosion if a wrong type of battery is used for the parent unit. Use only the supplied rechargeable battery or replacement battery pack (BT185645/BT285645) for the parent unit. Do not dispose of batteries in a fire. They may explode. Dispose of used battery according to the information in **The RBRC® seal**.
- Use only the adapters included with this product. Incorrect adapter polarity or voltage can seriously damage the product. Baby unit power adapter: Input 100-240V AC 150mA 50/60Hz; Output: 6V DC 600mA Parent unit power adapter: Input 100-240V AC 150mA 50/60Hz; Output: 6V DC 600mA.
- The power adapters are intended to be correctly oriented in a vertical or floor mount position. The prongs are not designed to hold the plug in place if it is plugged into a ceiling, under-the-table or cabinet outlet.
- Unplug this product from the wall outlet before cleaning. Do not use liquid or aerosol cleaners. Use a damp cloth for cleaning.
- Unplug the power cords before replacing batteries.
- Do not cut off the power adapters to replace them with other plugs, as this causes a hazardous situation.
- Do not allow anything to rest on the power cords. Do not install this product where the cords may be walked on or crimped.

- This product should be operated only from the type of power source indicated on the marking label. If you are not sure of the type of power supply in your home, consult your dealer or local power company.
- Do not overload wall outlets or use an extension cord.
- Do not place this product on an unstable table, shelf, stand or other unstable surfaces.
- This product should not be placed in any area where proper ventilation is not provided. Slots and openings in the back or bottom of this product are provided for ventilation. To protect them from overheating, these openings must not be blocked by placing the product on a soft surface such as a bed, sofa or rug. This product should never be placed near or over a radiator or heat register.
- Never push objects of any kind into this product through the slots because they may touch dangerous voltage points or create a short circuit. Never spill liquid of any kind on the product.
- To reduce the risk of electric shock, do not disassemble this product, but take it to an authorized service facility. Opening or removing parts of the product other than specified access doors may expose you to dangerous voltages or other risks. Incorrect reassembling can cause electric shock when the product is subsequently used.
- You should test the sound reception every time you turn on the units or move one of the components.
- Periodically examine all components for damage.
- Be aware of possible loss of privacy while using public airwaves. Conversations may be picked up by other nursery monitors, cordless phones, scanners, etc.
- Children should be supervised to ensure that they do not play with the product.
- The product is not intended for use by persons (including children) with reduced physical, sensory or mental capabilities, or lack of experience and knowledge, unless they have been given supervision or instruction concerning use of the appliance by a person responsible for their safety.

#### SAVE THESE INSTRUCTIONS

#### Cautions

- Use and store the product at a temperature between 32°F and 104°F.
- Do not expose the product to extreme cold, heat or direct sunlight. Do not put the product close to a heating source.
- Batteries should not be exposed to excessive heat such as bright sunshine or fire.
- Make sure the baby unit(s) and the adapter cord(s) are always out of reach of the baby, at least 3 feet away from the baby or crib, to avoid a possible strangulation hazard.
- Never place the baby unit(s) inside the baby's crib or playpen. Never cover the baby unit(s) or parent unit with anything such as a towel or a blanket.
- Other electronic products may cause interference with your baby monitor. Try installing your baby monitor as far away from these electronic devices as possible: wireless routers, radios, cellular telephones, intercoms, room monitors, televisions, personal computers, kitchen appliances and cordless telephones.

#### Precautions for users of implanted cardiac pacemakers

Cardiac pacemakers (applies only to digital cordless devices):  
Wireless Technology Research, LLC (WTR), an independent research entity, led a multidisciplinary evaluation of the interference between portable wireless devices and implanted cardiac pacemakers. Supported by the U.S. Food and Drug Administration, WTR recommends to physicians that:

#### Pacemaker patients

- Should keep wireless devices at least six inches from the pacemaker.
- Should NOT place wireless devices directly over the pacemaker, such as in a breast pocket, when it is turned ON.

WTR's evaluation did not identify any risk to bystanders with pacemakers from other persons using wireless devices.

#### Electromagnetic fields (EMF)

This VTech product complies with all standards regarding electromagnetic fields (EMF). If handled properly and according to the instructions in this user's manual, the product is safe to be used based on scientific evidence available today.

### Part checklist

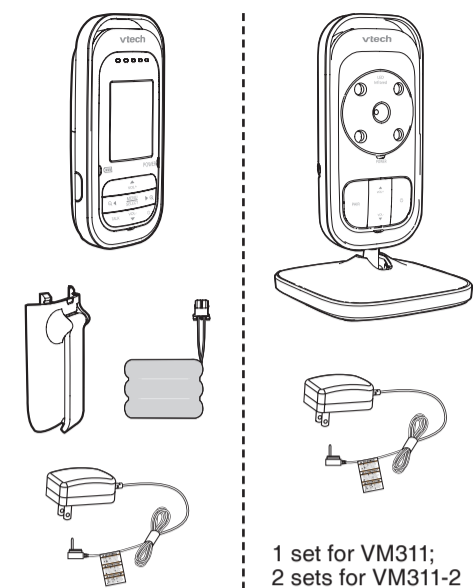

1 set for VM311;  
2 sets for VM311-2

**note** Make sure the supplied rechargeable battery with the label **THIS SIDE UP** facing up.

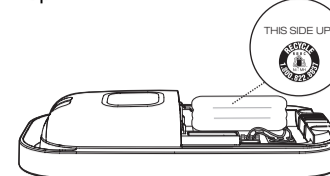

- Align the battery compartment cover flat against the battery compartment, then place down and slide it towards the center of the parent unit until it clicks into place.

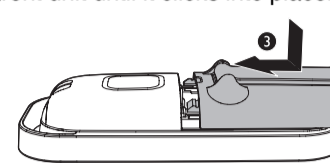

#### Replace the battery

To replace the battery, pull the battery out of the battery compartment and unplug the battery connector from the socket, then follow the steps above to install the battery.

- note**
- The operating time for using the rechargeable battery is short. If you want to monitor your baby for a long time, we recommend you connect the parent unit to AC power.
  - If the parent unit will not be used for a long time, disconnect and remove the battery to prevent possible leakage.

### Install the battery

You can power up the parent unit by connecting it to AC power or to the rechargeable battery provided. Even if the parent unit is connected to AC power, we recommend you also install the battery. This guarantees continual operation in case of a power outage.

#### Install the battery as shown below.

- Slide and lift to open the battery compartment cover.

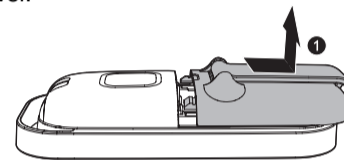

- Plug the battery connector securely into the socket.

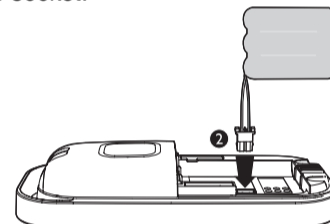

#### Connect the baby unit

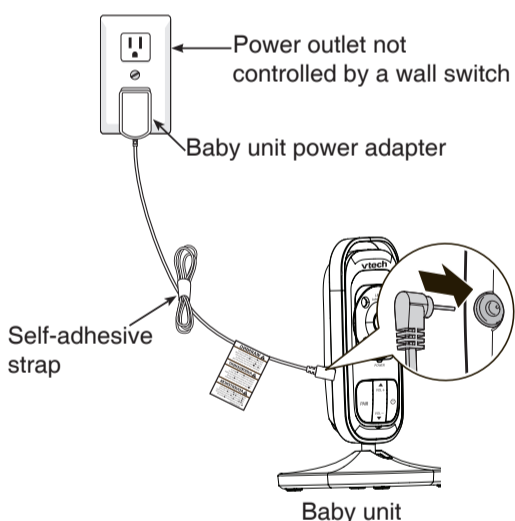

#### Connect the parent unit

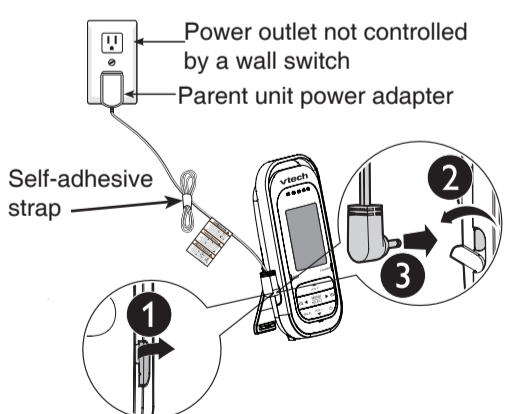

#### Charge the parent unit battery

Once you have installed the parent unit and its battery, **press and hold** **⏻** to turn it on. The battery icon indicates the battery status (see the table below). The parent unit battery is fully charged after 12 hours of continuous charging. The standby time varies depending on the sensitivity level you set, your actual use and the age of the battery.

When the parent unit is operating in battery mode and the battery is low, you need to charge the parent unit without interruption for at least 30 minutes to give the parent unit enough charge to use for a short time. When operating in low battery condition, the parent unit displays **⏻**. The **⏻** light on the parent unit flashes and the parent unit plays short beeps to alert you.

The following table summarizes the battery charge indicators and actions to take.

Battery indicators	Battery status	Action
The battery icon is off and <b>⏻</b> displays.	No battery is installed but operates using AC power, or the battery has been installed incorrectly.	Install the parent unit battery. Charge without interruption (at least 30 minutes).
The screen displays <b>⏻</b> . The <b>⏻</b> light flashes.	The battery has very little charge and may be used for only a short time.	Charge without interruption (about 30 minutes).
The battery icon becomes solid <b>⏻</b> .	The battery is fully charged.	To keep the battery charged, connect it to AC power when not in use.

**note** When you charge the battery initially or it is not used for a long period of time, charge it for 12 hours continuously. It takes longer to charge the battery when the parent unit is turned on. To shorten the charging time, turn the parent unit off while charging.

#### Before use

You may test the baby monitor before initial use, and at regular times thereafter.

#### To test your video and audio monitor:

- Place the parent unit and the baby units in the same room to test the product. Make sure the baby units are at least 3 feet away from the parent unit.
- Press and hold** **⏻** on the baby units until the **POWER** light turns on.
- Press and hold** **⏻** on the parent unit until the **POWER** light turns on.

**note** If both units are not connected, the parent unit displays **⏻** while searching for a baby unit. If no baby unit is found after a while, it displays **⏻**.

#### Positioning the baby monitor

Place the parent unit within the operating range of the baby unit. We recommend the parent unit is at least 3 feet away from the baby unit to avoid audio feedback. If you still experience audio feedback, move the parent unit and the baby unit farther apart.

**note** For better image quality, do not place the baby unit too far away from your baby.

For desktop usage and/or wall mounting the baby unit, you can refer to **Installation guide**.

#### Operating range

The operating range of the baby monitor is up to 1,000 feet outdoors or 150 feet indoors. The actual operating range may vary depending on the environmental conditions and other interferences such as walls, doors and other obstructions.

#### Overview

##### Baby unit overview

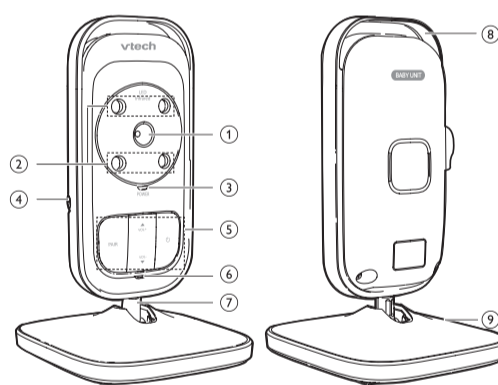

1	<b>Camera</b>
2	<b>Infrared LEDs</b> Backup light for night vision.
3	<b>POWER on/off indicator</b> <ul style="list-style-type: none"> <li>On when the baby unit is powered on and currently linked to parent unit.</li> <li>Flashes when the baby unit is not linked to a parent unit; or the pairing process is in progress; or the parent unit is not viewing this baby unit.</li> </ul>
4	<b>Power jack</b>
5	<b>Control key panel</b> <ul style="list-style-type: none"> <li><b>▲/VOL+</b> Press to increase the listening volume.</li> <li><b>▼/VOL-</b> Press to decrease the listening volume.</li> <li><b>PAIR</b> <b>Press and hold</b> to pair to the parent unit.</li> <li><b>⏻ (On/Off)</b> <b>Press and hold</b> to turn on or off.</li> </ul>
6	<b>Microphone</b>
7	<b>Stand</b> Tilt to adjust the camera angle.
8	<b>Rim</b>
9	<b>Base</b>

#### Parent unit overview

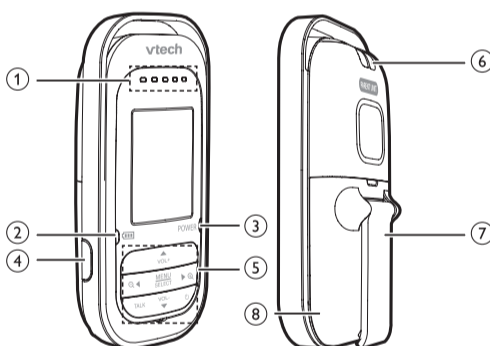

1	<b>Visual sound indicator</b> ○○○○○ Visual sound indicator shows the sound level detected from baby unit. It also shows the volume level during speaker volume setting. Sound level detected from the baby unit is independent from the volume level set at the parent unit. <ul style="list-style-type: none"> <li>○○○○○ Green lights indicate a moderate sound level detected from the baby unit; or <b>Level 1 to Level 3</b> of the speaker volume setting.</li> <li>●●●●● Red lights indicate a higher sound level detected from the baby unit; or <b>Level 4 to Level 5</b> of the speaker volume setting.</li> </ul>
2	<b>⏻ Battery level indicator</b> <ul style="list-style-type: none"> <li>Light On when the parent unit battery is being charged.</li> <li>Light Flashes when the parent unit battery is low and needs charging.</li> <li>Light Off when the parent unit battery is fully charged, or when no battery is installed.</li> </ul>
3	<b>POWER on/off indicator</b> <ul style="list-style-type: none"> <li>On when the parent unit is turned on.</li> <li>Flashes when in pairing process, or when connecting to baby unit while the baby unit is not available.</li> </ul>
4	<b>Power jack</b>

#### Control key panel

- ▲/VOL+**
- Press to increase the speaker volume.
  - While in the menu, press to scroll up.
  - While viewing a zoomed image, **press and hold** to move the image upward.

#### MENU/SELECT

- Press to enter the menu.
- While in a menu, press to choose an item, or save a setting.

#### ▼/VOL-

- Press to decrease the speaker volume.
- While in the menu, press to scroll down.
- While viewing a zoomed image, **press and hold** to move the image downward.



- While in a menu, press to choose the option on the left side.
- While viewing a zoomed image, press to zoom out; or **press and hold** to move the image leftward.



- While in a menu, press to choose the option on the right side.
- While viewing image, press to zoom in.
- While viewing a zoomed image, **press and hold** to move the image rightward.

#### TALK

While viewing image, **press and hold** to talk to the selected baby unit.

#### ⏻(On/off)







- Press and hold** to turn on or off.
- Press to turn on or off the screen.

#### 6 Slot for portable use



#### 7 Stand



#### 8 Battery compartment cover

## Parent unit display icons

	<b>Connection status</b> <ul style="list-style-type: none"><li>Full displays when strong signal strength is detected between the baby unit and the parent unit.</li><li>Three-quarters, Half or One-quarter displays when moderate signal strength is detected between the baby unit and the parent unit.</li><li>Two crossed arrows displays when the link between the baby unit and the parent unit is lost.</li><li>Searching displays when the parent unit is searching for a baby unit.</li></ul>
 (x:1-4)	<b>Current view status</b> <ul style="list-style-type: none"><li>Display the number of the baby unit that is being viewed.</li></ul>
	<b>Zoom</b> <ul style="list-style-type: none"><li>Display when the camera at the baby unit has zoomed in.</li></ul>
	<b>Volume off</b> <ul style="list-style-type: none"><li>Display when the volume is turned off.</li></ul>
	<b>Sound activation</b> <ul style="list-style-type: none"><li>Display when the sound activation is on. The baby unit detects the sound in the baby room, and it automatically goes on to show the baby on the video display.</li></ul>
	<b>Battery status</b> <ul style="list-style-type: none"><li>Progress bar animates when the battery is charging.</li><li>Full battery displays solid when the battery is fully charged.</li><li>Low battery displays when the battery is low and needs charging.</li><li>AC power displays when no battery is installed but operates using AC power, or the battery has been installed incorrectly.</li></ul>



## Parent unit main menu icons

	<b>Camera selection</b> <ul style="list-style-type: none"><li>You can select the screen to view images from a particular baby unit, or view all baby units in Patrol Mode.</li></ul>
	<b>Brightness</b> <ul style="list-style-type: none"><li>You can change the brightness of the screen.</li></ul>
	<b>Sensitivity</b> <ul style="list-style-type: none"><li>You can change the sound sensitivity level of the baby unit. It monitors the baby unit on picking up any sound activities in your baby’s room.</li></ul>



	<b>Sound activation</b> <ul style="list-style-type: none"><li>You can turn on or off the sound activation feature to check on your baby whenever there is sound in the baby room.</li></ul>
	<b>Pairing</b> <ul style="list-style-type: none"><li>The baby units and parent unit provided are already paired. You can add or replace baby units (VM310 purchased separately) to your baby monitor system.</li></ul>

## Using the baby monitor

### Power on or off the baby unit

- Press and hold  to turn on the baby unit. The **POWER** light turns on.
- Press and hold  again to turn off the baby unit. The **POWER** light turns off.

### Power on or off the parent unit

- Press and hold  to turn on the parent unit. The screen turns on.
- Press and hold  again to turn off the parent unit. The screen turns off.

### Turn on or off the parent unit screen

You can turn on or off the parent unit screen without power off the parent unit. You can still hear sound from the baby unit.

- Press  on the parent unit at any time.

### Adjust the speaker volume for baby unit

You can adjust the speaker volume.

- Press /VOL+ or /VOL– on the baby unit at any time.

### Adjust the speaker volume for parent unit





You can adjust the speaker volume from **Volume 1** to **Volume 5**, or turn it off.

- Press /VOL+ or /VOL– on the parent unit when it is not in use.

When the speaker volume is set to off, the screen displays .





### Adjust the LCD brightness of the parent unit

You can adjust the brightness of the parent unit screen from **Level 1** to **Level 5**. The LCD brightness is preset to **Level 3**.

- Press **MENU/SELECT** when the parent unit is not in use.
- Press  or  to scroll to .
- press  or  to adjust the brightness.
- Press **MENU/SELECT** to confirm your selection.







### Adjust the sound sensitivity of the baby unit

You can use the parent unit to change the sound sensitivity level of the baby units from **Level 1** to **Level 5**. The higher the sound sensitive is set, the more sensitive the baby unit is in detecting sounds for transmitting to the parent unit.

- Press **MENU/SELECT** when the parent unit is not in use.
- Press  or  to scroll to .
- Press  or  to adjust the sensitivity level.
- Press **MENU/SELECT** to confirm your selection.

### Turn on or off the sound activation



When the parent unit screen is turned off manually, you can set the screen to be turned on automatically whenever there are sounds detected from the baby units. The parent unit screen will turn off automatically when no sounds are detected from the baby units within 20 seconds.







- Press **MENU/SELECT** when the parent unit is not in use.
- Press  or  to scroll to .
- Press  or  to select  to turn on, or  to turn off sound activation.
- Press **MENU/SELECT** to confirm your selection.

**note** You hear a beep when the screen turns on or off due to sound activation.

### Select the camera







You can select the screen to view images from a particular baby unit, or view all baby units in Patrol Mode.

If you select Patrol Mode to view the images, the screen switches to view another baby unit automatically after some time. The switching is in chronological order:  to .

- Press **MENU/SELECT** when the parent unit is not in use.
- Press  or  to scroll to .
- Press  or  to select the desired baby unit (1, 2, 3 or 4) or Patrol Mode .
- Press **MENU/SELECT** to confirm your selection.

### Zoom

You can zoom in or out while viewing image from baby unit.

- Press  to zoom in.
- Press and hold , ,  or  to move the zoomed image upward, downward, leftward or rightward correspondingly.
- Press  to zoom out.

### Talk function

You can use the **TALK** function of the parent unit to talk and comfort your baby.

- Press and hold **TALK** when the parent unit is viewing particular baby unit. Speak towards the **MIC** (microphone) on the parent unit. Your voice is broadcast to the baby unit.

### Night vision

The baby unit has infrared LEDs that allow you to see your baby clearly at night or in a dark room. When the baby unit detects low light levels, the infrared LEDs are switched on automatically.







**note** When the infrared LEDs are on, the image is in black and white. This is normal due to external light sources.

### Pair and replace extra new baby unit (VM310)

The baby units and parent unit provided are already paired. You can add or replace any baby units (VM310 purchased separately) to your video and audio monitor system.

**note** You can pair a maximum of four baby units to your parent unit. Each new baby unit must be paired to the parent unit before use.

### To pair and replace a baby unit:

- Press **MENU/SELECT** when the parent unit is not in use.
- Press  or  to choose .
- Press  or  to choose a desired baby unit slot, then press **MENU/SELECT**. The screen displays .

**note** If you choose an occupied baby unit slot, the new baby unit will replace the existing baby unit.

- Turn on the new baby unit, and then immediately press and hold **PAIR** until the **POWER** light turns on.

When pairing is successful, the screen displays , and then the image from the newly paired baby unit.

**note**

- If pairing fails, the screen displays . Try the pairing process again.
- Only one baby unit can be paired at a time.

## Portable use of parent unit (optional)

**note** Sling is not included. You may need to buy a sling for portable usage.

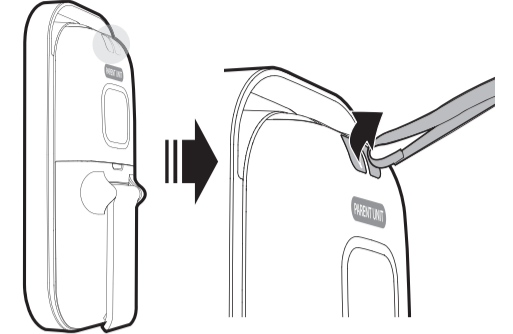

- Make sure battery is installed and charged. Unplug the power adaptor.
- Pinch the end of the sling and insert it into the slot on the top of the parent unit.
- Insert the one end of the sling into the other end of the sling, and fasten it.

## Energy-saving charging mode





Follow the instructions to install and charge the battery. The energy-saving charging mode is activated while charging.

Even if the parent unit is paired to baby units, the energy-saving charging mode is activated while it is powered off and charging.

## General product care

To keep this product working well and looking good, follow these guidelines:

- Avoid putting it near heating appliances and devices that generate electrical noise (for example, motors or fluorescent lamps).
- DO NOT expose it to direct sunlight or moisture.
- Avoid dropping the product or treating it roughly.
- Clean with a soft cloth.
- DO NOT immerse the parent unit and the baby unit in water and do not clean them under the tap.

Why don't the power-on light of the baby unit and parent unit go on when I switch on the units?	Perhaps the baby unit is not connected to the mains. Connect the baby unit to the mains. Then set <b>ON/OFF</b> switch to <b>ON</b> to switch on the baby unit and to establish connection with the parent unit.
Why is my screen in black and white?	The screen is in black and white when the infrared LEDs are on during nighttime or in a dark room. This is normal due to external light sources.
Why does the baby monitor produce a high-pitched noise?	The units may be too close to each other. Make sure the parent unit and the baby unit at least 1 metre/3 feet away from each other.
Why does the parent unit react too quickly to other sounds?	The baby unit also picks up other sounds than those of your baby. Adjust the sensitivity level to a lower level or adjust the speaker volume on the parent unit.
Why don't I hear a sound/Why can't I hear my baby cry?	<div><div><div><span></span><b>RBRC® is a registered trademark of Rechargeable Battery Recycling Corporation.</b></div></div></div> <div>The volume of the parent unit may have set too low. Press /VOL+ to increase the volume level.</div> <div>You may have set a low sound sensitivity level. See <b>Adjust the sound sensitivity of the baby unit</b> to change the setting.</div>
Why does the parent unit beep?	<div><div><div><span></span><b>RBRC® is a registered trademark of Rechargeable Battery Recycling Corporation.</b></div></div></div> <div>The baby units may be out of range. Move the parent unit closer to the baby units (but not less than 3 feet).</div> <div>If the parent unit is powered by the provided battery, it may not have enough charge for the parent unit to perform normally. Charge the battery in the parent unit for up to 12 hours.</div>
Why can't I establish a connection? Why is the connection lost every now and then? Why are there sound interruptions?	<div><div><div><span></span><b>RBRC® is a registered trademark of Rechargeable Battery Recycling Corporation.</b></div></div></div> <div>The baby units may be out of range. Move the parent unit closer to the baby units (but not less than 3 feet).</div> <div>Other electronic products may cause interference with your baby monitor. Try installing your baby monitor as far away from these electronic devices as possible.</div>

## The RBRC® seal

The RBRC® seal on the nickel-metal battery indicates that VTech Communications, Inc. is voluntarily participating in an industry program to collect and recycle these batteries at the end of their useful lives, when taken out of service within the United States and Canada.

The RBRC® program provides a convenient alternative to placing used nickel-metal batteries into the trash or municipal waste, which may be illegal in your area.

VTech’s participation in RBRC® makes it easy for you to drop off the spent battery at local retailers participating in the RBRC® program or at authorized VTech product service centers. Please call **1 (800) 8 BATTERY™** for information on Ni-MH battery recycling and disposal bans/restrictions in your area. VTech’s involvement in this program is part of its commitment to protecting our environment and conserving natural resources.



**RBRC® is a registered trademark of Rechargeable Battery Recycling Corporation.**

## FCC and IC regulations

### FCC Part 15

This equipment has been tested and found to comply with the requirements for a Class B digital device under Part 15 of the Federal Communications Commission (FCC) rules. These requirements are intended to provide reasonable protection against harmful interference in a residential installation. This equipment generates, uses and can radiate radio frequency energy and, if not installed and used in accordance with the instructions, may cause harmful interference to radio communications. However, there is no guarantee that interference will not occur in a particular installation. If this equipment does cause harmful interference to radio or television reception, which can be determined by turning the equipment off and on, the user is encouraged to try to correct the interference by one or more of the following measures:

- Reorient or relocate the receiving antenna.
- Increase the separation between the equipment and receiver.
- Connect the equipment into an outlet on a circuit different from that to which the receiver is connected.
- Consult the dealer or an experienced radio/TV technician for help.

Changes or modifications to this equipment not expressly approved by the party responsible for compliance could void the user’s authority to operate the equipment.

This device complies with Part 15 of the FCC rules. Operation is subject to the following two conditions: (1) this device may not cause harmful interference, and (2) this device must accept any interference received, including interference that may cause undesired operation.

To ensure safety of users, the FCC has established criteria for the amount of radio frequency energy that can be safely absorbed by a user or bystander according to the intended usage of the product. This product has been tested and found to comply with the FCC criteria. The baby unit shall be installed and used such that parts of all persons’ body are maintained at a distance of approximately 80 in (20 cm) or more.

This Class B digital apparatus complies with Canadian requirement: CAN ICES-3 (B)/NMB-3(B)

### Industry Canada

Operation is subject to the following two conditions: (1) this device may not cause harmful interference, and (2) this device must accept any interference, including interference that may cause undesired operation.

The term “IC:” before the certification/registration number only signifies that the Industry Canada technical specifications were met.

This product meets the applicable Industry Canada technical specifications.

This device complies with Industry Canada Licence-exempt RSS standard(s)

### RF radiation exposure statement

The baby unit complies with FCC RF radiation exposure limits set forth for an uncontrolled environment. The baby unit should be installed and operated with a minimum distance of 8 in (20 cm) between the baby unit and all persons’ body. Use of other accessories may not ensure compliance with FCC RF exposure guidelines. This transmitter must not be co-located or operating in conjunction with any other antenna or transmitter. This equipment complies also with Industry Canada RSS-102 with respect to Canada’s Health Code 6 for Exposure of Humans to RF Fields.

## Limited warranty

### What does this limited warranty cover?

The manufacturer of this VTech Product warrants to the holder of a valid proof of purchase (“Consumer” or “you”) that the Product and all accessories provided in the sales package (“Product”) are

free from defects in material and workmanship, pursuant to the following terms and conditions, when installed and used normally and in accordance with the Product operating instructions. This limited warranty extends only to the Consumer for Products purchased and used in the United States of America and Canada.

### What will VTech do if the Product is not free from defects in materials and workmanship during the limited warranty period (“Materially Defective Product”)?

During the limited warranty period, VTech’s authorized service representative will repair or replace at VTech’s option, without charge, a Materially Defective Product. If we repair the Product, we may use new or refurbished replacement parts. If we choose to replace the Product, we may replace it with a new or refurbished Product of the same or similar design. We will retain defective parts, modules, or equipment. Repair or replacement of the Product, at VTech’s option, is your exclusive remedy. VTech will return the repaired or replacement Products to you in working condition. You should expect the repair or replacement to take approximately 30 days.

### How long is the limited warranty period?

The limited warranty period for the Product extends for ONE (1) YEAR from the date of purchase. If VTech repairs or replaces a Materially Defective Product under the terms of this limited warranty, this limited warranty also applies to the repaired or replacement Product for a period of either (a) 90 days from the date the repaired or replacement Product is shipped to you or (b) the time remaining on the original one-year warranty; whichever is longer.

### What is not covered by this limited warranty?

This limited warranty does not cover:

- Product that has been subjected to misuse, accident, shipping or other physical damage, improper installation, abnormal operation or handling, neglect, inundation, fire, water or other liquid intrusion; or
- Product that has been damaged due to repair, alteration or modification by anyone other than an authorized service representative of VTech; or
- Product to the extent that the problem experienced is caused by signal conditions, network reliability, or cable or antenna systems; or
- Product to the extent that the problem is caused by use with non-VTech accessories; or
- Product whose warranty/quality stickers, product serial number plates or electronic serial numbers have been removed, altered or rendered illegible; or
- Product purchased, used, serviced, or shipped for repair from outside the United States of America

or Canada, or used for commercial or institutional purposes (including but not limited to Products used for rental purposes); or

- Product returned without a valid proof of purchase (see item 2 on the next page); or
- Charges for installation or set up, adjustment of customer controls, and installation or repair of systems outside the unit.

### How do you get warranty service?

**NOTE:** Before calling for service, please review the user’s manual - a check of the Product’s controls and features may save you a service call.

Except as provided by applicable law, you assume the risk of loss or damage during transit and transportation and are responsible for delivery or handling charges incurred in the transport of the Product(s) to the service location. VTech will return repaired or replaced Product under this limited warranty. Transportation, delivery or handling charges are prepaid. VTech assumes no risk for damage or loss of the Product in transit. If the Product failure is not covered by this limited warranty, or proof of purchase does not meet the terms of this limited warranty, VTech will notify you and will request that you authorize the cost of repair prior to any further repair activity. You must pay for the cost of repair and return shipping costs for the repair of Products that are not covered by this limited warranty.

### What must you return with the Product to get warranty service?

- Return the entire original package and contents including the Product to the VTech service location along with a description of the malfunction or difficulty; and
- Include a “valid proof of purchase” (sales receipt) identifying the Product purchased (Product model) and the date of purchase or receipt; and
- Provide your name, complete and correct mailing address, and telephone number.

### Other limitations

This warranty is the complete and exclusive agreement between you and VTech. It supersedes all other written or oral communications related to this Product. VTech provides no other warranties for this Product. The warranty exclusively describes all of VTech’s responsibilities regarding the Product. There are no other express warranties. No one is authorized to make modifications to this limited warranty and you should not rely on any such modification.

State/Provincial Law Rights: This warranty gives you specific legal rights, and you may also have other rights, which vary from state to state or province to province.

Limitations: Implied warranties, including those of

- DO NOT use cleaning spray or liquid cleaners.
- Make sure the baby unit and parent unit are dry before you connect them to the mains again.

## Storage

When you are not going to use the baby monitor for some time, remove the rechargeable battery from the parent unit. Store the parent unit, the baby unit and the adapters in a cool and dry place.

## Frequently asked questions

Below are the questions most frequently asked about the baby monitor. If you cannot find the answer to your question, contact customer service by visiting our website at [www.vtechphones.com](http://www.vtechphones.com) or calling **1 (800) 595-9511**.

Why does the baby monitor not respond normally?	Try the following (in the order listed) for common sure: <ol style="list-style-type: none"><li>Disconnect the power to the baby units and the parent unit.</li><li>Remove the batteries in the parent unit. Then install the batteries again.</li><li>Wait a few minutes before connecting power back to the baby units, and the parent unit.</li><li>Turn on the baby units and the parent unit.</li><li>Wait for the parent unit to synchronize with the baby units. Allow up to one minute for this to take place.</li></ol>
Why don't the power-on light of the baby unit and parent unit go on when I switch on the units?	Perhaps the rechargeable battery of the parent unit is empty and the parent unit is not connected to the mains. Insert the appliance plug into the parent unit and put the adapter in a wall socket. Then press  to switch on the parent unit and to establish connection with the baby unit.