



## Abridged user's manual

TR1-2013/TR16-2013/TR17-2013/TR2-2013/  
TR26-2013/TR27-2013

DECT 6.0 cordless telephone



This Abridged user's manual provides you with basic installation and use instructions.

After reading this manual, you will learn how to:

- ✓ **Install the telephone**
  - 1 Install telephone base & charger
  - 2 Install handset battery
- ✓ **Program common settings**
  - 3 Use built-in answering system or voicemail?
  - 4 Set date and time
  - 5 Set handset ringer volume
  - 6 Set quiet mode
- ✓ **Use common operations**
  - 7 Directory
  - 8 Speed dial
  - 9 Caller ID
  - 10 Answering system

We recommend you refer to the full set of installation and operation instructions at [www.vtechphones.com](http://www.vtechphones.com). For customer service, visit [www.vtechphones.com](http://www.vtechphones.com) or call **1 (800) 595-9511**.

Before using this VTech product, please read **Important safety instructions** on page 10 of this user's manual.



## Register online to get an additional 3-month warranty!

Go to [www.vtechphones.com](http://www.vtechphones.com) to register your product for enhanced warranty support and latest VTech product news.

You can expand your telephone system by adding expansion handsets (TR02-2013/TR05-2013/TR06-2013/TR07-2013/TR08-2013, purchased separately). This telephone base supports up to five handsets.



Telephones identified with this logo have reduced noise and interference when used with most T-coil equipped hearing aids and cochlear implants. The TIA-1083 Compliant Logo is a trademark of the Telecommunications Industry Association. Used under license.



The ENERGY STAR<sup>®</sup> program ([www.energystar.gov](http://www.energystar.gov)) recognizes and encourages the use of products that save energy and help protect our environment. We are proud to mark this product with the ENERGY STAR<sup>®</sup> label indicating it meets the latest energy efficiency guidelines.

## Parts checklist

### Your package contains:

- Handset  
(1 for TR1-2013/TR16-2013/TR17-2013)  
(2 for TR2-2013/TR26-2013/TR27-2013)
- Charger with power adapter  
(1 for TR2-2013/TR26-2013/TR27-2013)
- Telephone base
- Telephone line cord
- Telephone base power adapter
- Battery compartment cover  
(1 for TR1-2013/TR16-2013/TR17-2013)  
(2 for TR2-2013/TR26-2013/TR27-2013)
- Battery  
(1 for TR1-2013/TR16-2013/TR17-2013)  
(2 for TR2-2013/TR26-2013/TR27-2013)
- Wall mount bracket
- Abridged user's manual

**1**

### Install telephone base & charger

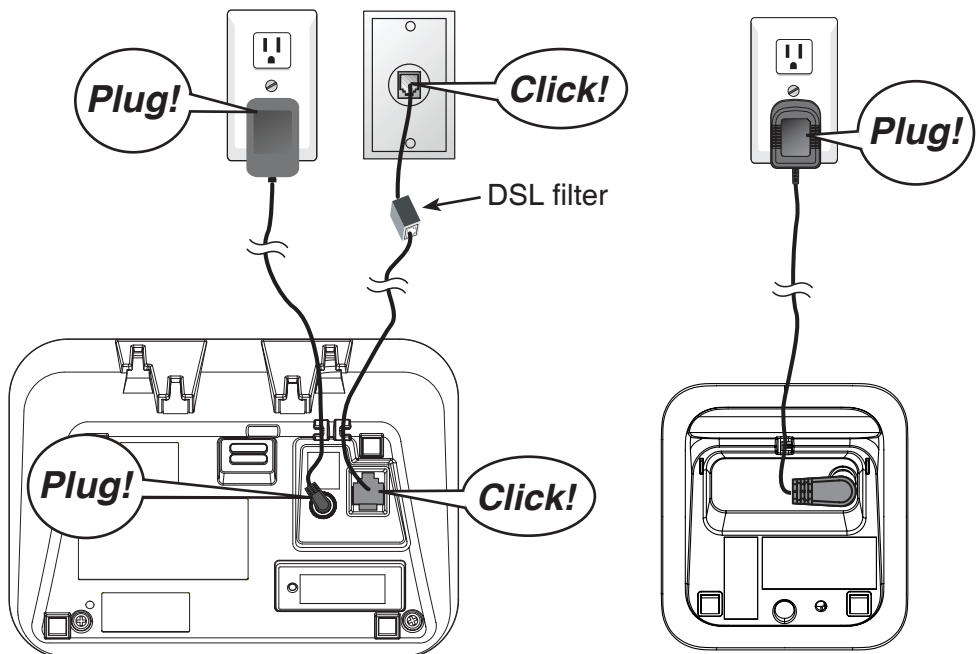

The telephone base is ready for tabletop use. If you want to change to wall mounting, see page 9 for details.

## 2

## Install handset battery

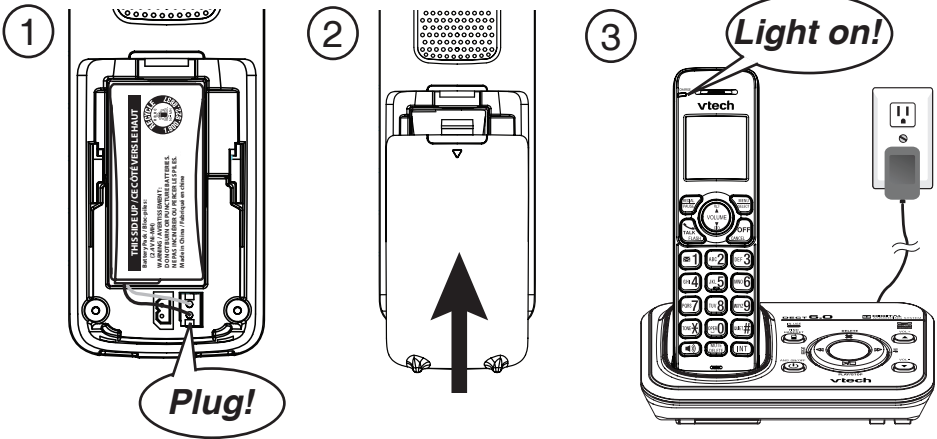

Charge for at least 30 minutes before initial settings.

Charge for 11 hours before initial use.

## ECO mode

This power conserving technology reduces power consumption for optimal battery performance.

The ECO mode activates automatically whenever the handset is synchronized with the telephone base.

The handset shows **ECO** when the ECO mode activates.

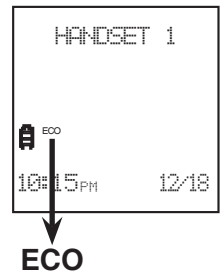

## 3

## Use built-in answering system or voicemail?

Your telephone has a built-in answering system which can be used without any service subscription.

The telephone also supports voicemail feature which requires subscription from your telephone service provider. Contact your telephone service provider for details.



## To configure the built-in answering system

### Record own announcement

You can use the preset announcement to answer calls, or replace it with your own recorded announcement.

1. Press **MENU** >> Press **▼/▲** to **Answering Sys** >> Press **SELECT** twice.
2. Press **7** to start recording.
3. After the tone, speak towards the handset microphone.
4. Press **5** when done.

## Set number of rings

You can set the answering system to answer an incoming call after 2, 3, 4, 5 or 6 rings; or toll saver.

1. Press **MENU** >> Press **▼/▲** to **Answering sys** >> Press **SELECT**.
2. Press **▼/▲** to **Ans sys setup** >> Press **SELECT**.
3. Press **▼/▲** to **# of rings** >> Press **SELECT**.
4. Press **▼/▲** to choose **6, 5, 4, 3, 2** or **Toll saver** >> Press **SELECT**.



## To use voicemail (requires service subscription)

You can save the voicemail number to  **1** on each handset for easy access. Contact your telephone service provider for more information and assistance about using your voicemail service.

### To set voicemail number:

1. Press **MENU** >> Press **▼/▲** to **Settings** >> Press **SELECT**.
2. Press **▼/▲** to **Voicemail #** >> Press **SELECT**.
3. Enter the voicemail number >> Press **SELECT**.

While entering numbers, you can:

- Press **DELETE** to erase a digit.
- Press **▼/▲** to move the cursor to the left or right.
- Press and hold **PAUSE** to insert a dialing pause (a **P** appears).
- Press **TONEX** to add **X** († appears) or **QUIET#** to add **#** (Ⓜ appears).

### To retrieve voicemail messages:

Press and hold  **1**.

## 4

## Set date and time

If you subscribe to caller ID service, the date and time are set automatically with each incoming call. You can also set the date and time manually.

1. Press **MENU** >> Press **▼/▲** to **Set date/time** >> Press **SELECT**.
2. Enter month (**MM**), date (**DD**) and year (**YY**) >> Press **SELECT**.
3. Enter hour (**HH**) and minute (**MM**) >> Press **▼/▲** for **AM/PM** >> Press **SELECT**.

## 5

## Set handset ringer volume

You can adjust the ringer volume level, or turn the ringer off.

1. Press **MENU** >> Press **▼/▲** to **Ringers** >> Press **SELECT** twice.
2. Press **▼/▲** to sample each volume level >> Press **SELECT**.

## 6

## Set quiet mode

You can turn on the quiet mode for a period of time. During this period, all tones (except paging tone) are muted.

### To set and turn on:

1. Press and hold QUIET#.
2. Enter the duration (1-12 hours) >> Press **SELECT**.

### To turn off:

Press and hold QUIET#.

## 7

## Directory

The directory stores up to 50 entries which are shared by all system handsets.



### To add a directory entry:

1. Enter the phone number >> Press **MENU/SELECT** twice.
2. Enter the name >> Press **SELECT**.

While entering names and numbers, you can:

- Press **DELETE** to backspace and erase a digit or character.
- Press **▼/▲** to move the cursor to the left or right.
- Press **0** to add a space (for entering names only).
- Press and hold PAUSE to insert a dialing pause (a **P** appears).
- Press **TONEX** to add **X** (⌘ appears) or **QUIET#** to add **#** (🔇 appears).

### To review and dial a directory entry:

1. Press .
2. Press **▼/▲** to browse to the desired directory; or use the dialing keys to start a name search.
3. Press  to dial.

### To edit a directory entry:

1. When the desired entry displays >> Press **SELECT**.
2. Edit the number >> **SELECT**.
3. Edit the name >> **SELECT**.

### To delete a directory entry:

1. When the desired entry displays >> Press **DELETE**.
2. The screen displays **Delete contact?** >> Press **SELECT**.

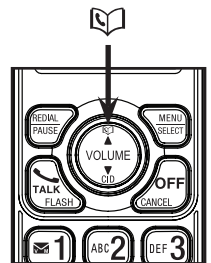

## 8

## Speed dial

You can copy up to 9 directory entries into the speed dial locations (0 and 2-9) so that you can dial them more quickly.

### To assign a speed dial entry:

1. Press **MENU** >> Press **▼/▲** to **Directory** >> Press **SELECT**.
2. Press **▼/▲** to **Speed dial** >> Press **SELECT**.
3. Press **▼/▲** to a desired location >> Press **SELECT**.
4. Press **▼/▲** to a desired directory entry >> Press **SELECT**.

### To dial a speed dial entry:

Press and hold a dialing key (0 or 2-9) to dial the number stored in the corresponding location.

### To delete a speed dial entry:

1. Press **MENU** >> Press **▼/▲** to **Directory** >> Press **SELECT**.
2. Press **▼/▲** to **Speed dial** >> Press **SELECT**.
3. Press **▼/▲** to a desired location >> Press **DELETE** >> Press **SELECT**.

## 9

## Caller ID

This product supports caller ID services provided by most telephone service providers. The caller ID log stores up to 50 entries.

The handset displays **XX missed calls** when you have incoming calls that have not been answered.

### To review and dial a caller ID entry:

1. Press **CID** >> Press **▼/▲** to the desired caller ID entry.
  - When the desired entry appears, press **QUIET#** repeatedly to show different dialing options.
2. Press **TALK**  to dial.

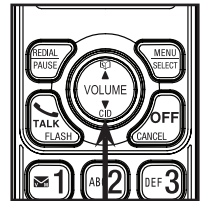

CID

### To erase the missed call indicator:

When you have reviewed all the missed calls, the missed call indicator is erased.

If you want to erase the missed call indicator without reviewing the caller ID log, press and hold **CANCEL** on the idle handset.

## 10

## Answering system

The built-in answering system must be turned on to answer and record messages.

### To turn the answering system on or off:

- Press **☺/ANS ON/OFF** on the telephone base to turn the answering system on or off.

### Message playback:

On the telephone base: Press **▶/■/PLAY** when the telephone is idle.

On the handset: Press **MENU** >> Press **SELECT**.

Refer to page 8 for advanced answering system operations.

# Handset operation

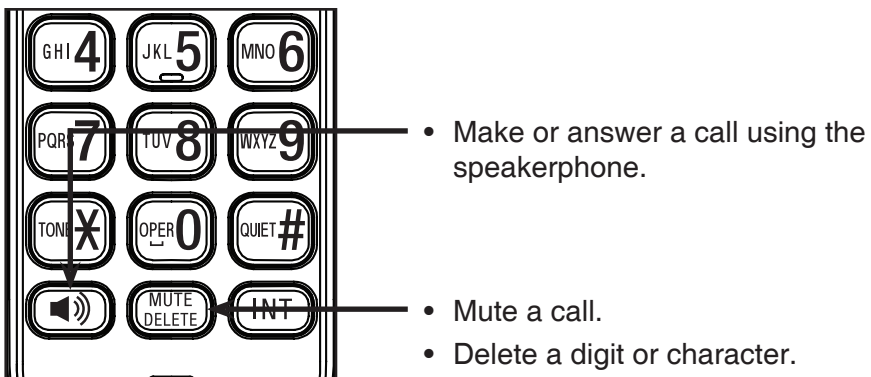
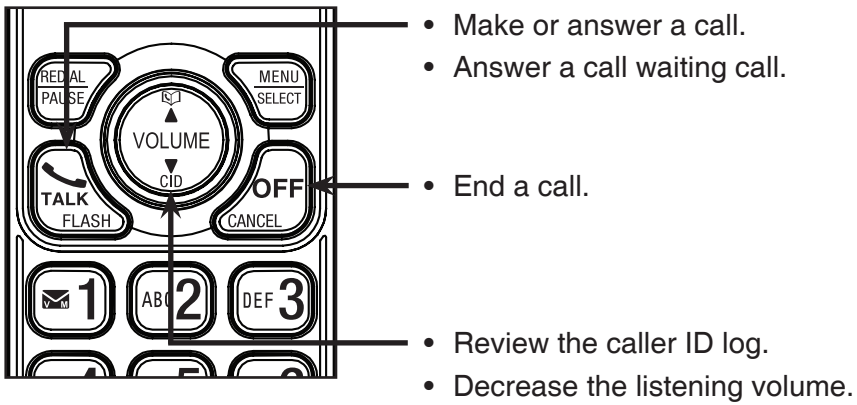
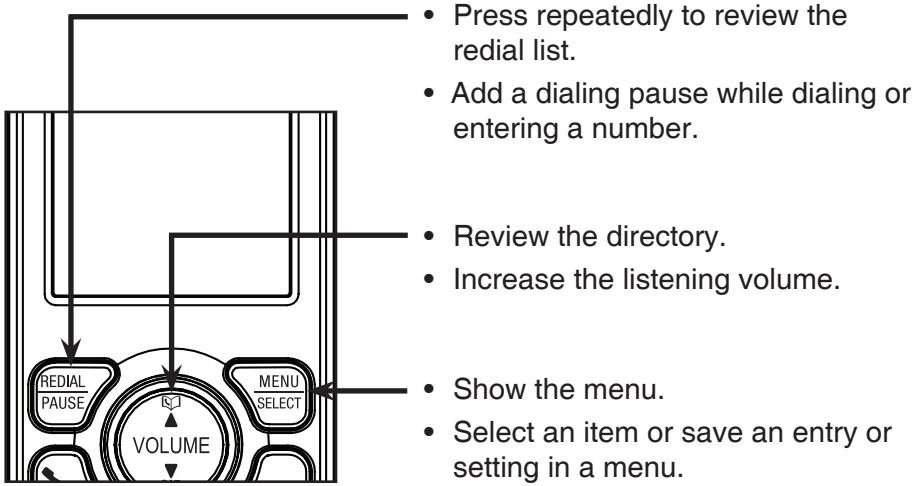

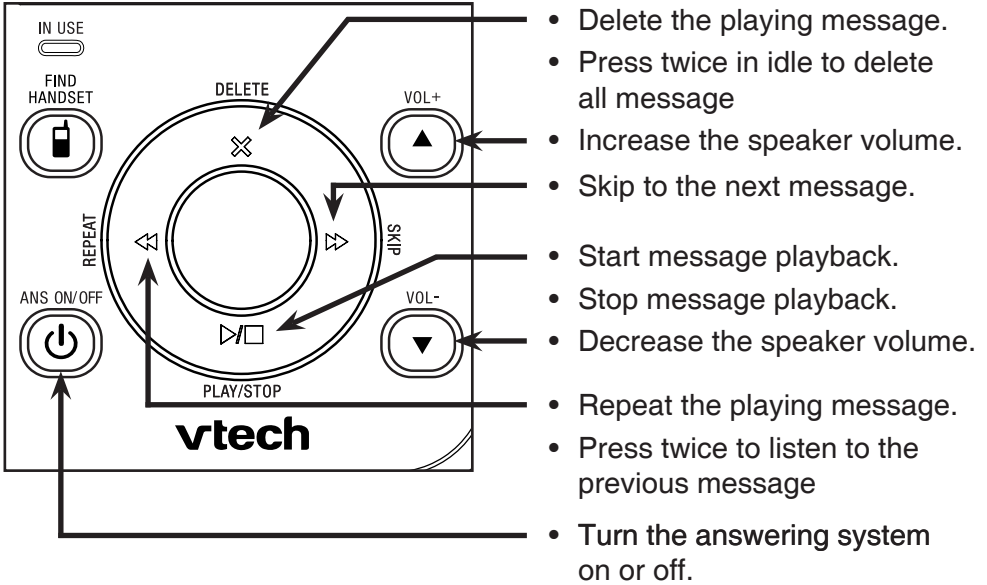

# Answering system operation

The built-in answering system must be turned on to answer and record messages.



## Call intercept:

If you want to talk to the person whose message is being recorded, press  or  on the handset.

## Remote access

You can access the answering system remotely from any touch-tone telephone. The preset remote access code is **19**.

1. Dial your telephone number from any touch-tone telephone.
2. When the answering system answers, enter the two-digit remote access code.
3. Press **\*5** to hear a list of remote commands.
4. Enter the desired remote command code.
5. Hang up or press **8** to end the call.

 Go to pages 3-4 to learn some common settings for your answering system.



# Install wall mount bracket (optional)

①

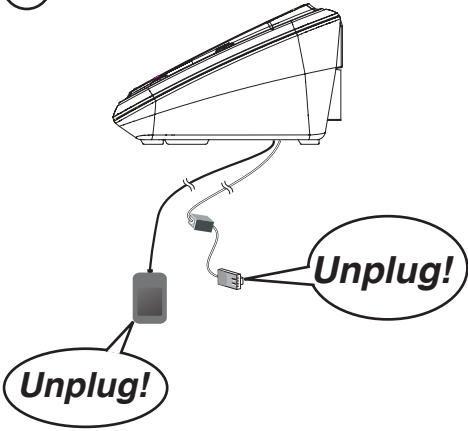

②

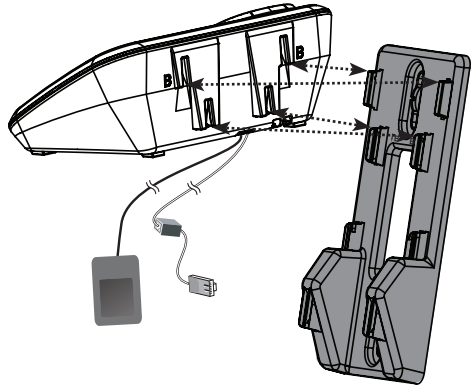

③

Slide the base down!

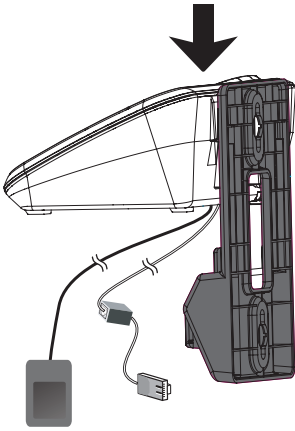

④

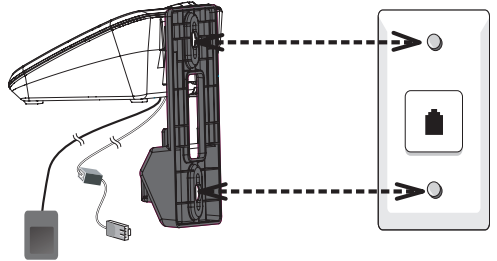

⑤

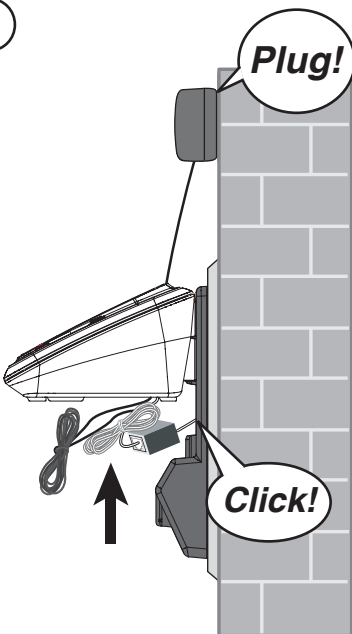

## Important safety instructions

When using your telephone equipment, basic safety precautions should always be followed to reduce the risk of fire, electric shock and injury, including the following:

1. Read and understand all instructions.
2. Follow all warnings and instructions marked on the product.
3. Unplug this product from the wall outlet before cleaning. Do not use liquid or aerosol cleaners. Use a damp cloth for cleaning.
4. Do not use this product near water such as near a bath tub, wash bowl, kitchen sink, laundry tub or a swimming pool, or in a wet basement or shower.
5. Do not place this product on an unstable table, shelf, stand or other unstable surfaces.
6. Slots and openings in the back or bottom of the telephone base and handset are provided for ventilation. To protect them from overheating, these openings must not be blocked by placing the product on a soft surface such as a bed, sofa or rug. This product should never be placed near or over a radiator or heat register. This product should not be placed in any area where proper ventilation is not provided.
7. This product should be operated only from the type of power source indicated on the marking label. If you are not sure of the type of power supply in your home or office, consult your dealer or local power company.
8. Do not allow anything to rest on the power cord. Do not install this product where the cord may be walked on.
9. Never push objects of any kind into this product through the slots in the telephone base or handset because they may touch dangerous voltage points or create a short circuit. Never spill liquid of any kind on the product.
10. To reduce the risk of electric shock, do not disassemble this product, but take it to an authorized service facility. Opening or removing parts of the telephone base or handset other than specified access doors may expose you to dangerous voltages or other risks. Incorrect reassembling can cause electric shock when the product is subsequently used.
11. Do not overload wall outlets and extension cords.
12. Unplug this product from the wall outlet and refer servicing to an authorized service facility under the following conditions:
  - When the power supply cord or plug is damaged or frayed.
  - If liquid has been spilled onto the product.
  - If the product has been exposed to rain or water.
  - If the product does not operate normally by following the operating instructions. Adjust only those controls that are covered by the operation instructions. Improper adjustment of other controls may result in damage and often requires extensive work by an authorized technician to restore the product to normal operation.
  - If the product has been dropped and the telephone base and/or handset has been damaged.
  - If the product exhibits a distinct change in performance.
13. Avoid using a telephone (other than cordless) during an electrical storm. There is a remote risk of electric shock from lightning.
14. Do not use the telephone to report a gas leak in the vicinity of the leak. Under certain circumstances, a spark may be created when the adapter is plugged into the power outlet, or when the handset is replaced in its cradle. This is a common event associated with the closing of any electrical circuit. The user should not plug the phone into a power outlet, and should not put a charged handset into the cradle, if the phone is located in an environment containing concentrations of flammable or flame-supporting gases, unless there is adequate ventilation. A spark in such an environment could create a fire or explosion. Such environments might include: medical use of oxygen without adequate ventilation; industrial gases (cleaning solvents; gasoline vapors; etc.); a leak of natural gas; etc.
15. Only put the handset of your telephone next to your ear when it is in normal talk mode.
16. The power adapters are intended to be correctly oriented in a vertical or floor mount position. The prongs are not designed to hold the plug in place if it is plugged into a ceiling, under-the-table or cabinet outlet.

## SAVE THESE INSTRUCTIONS

## Precautions for users of implanted cardiac pacemakers

Cardiac pacemakers (applies only to digital cordless telephones):

Wireless Technology Research, LLC (WTR), an independent research entity, led a multidisciplinary evaluation of the interference between portable wireless telephones and implanted cardiac pacemakers. Supported by the U.S. Food and Drug Administration, WTR recommends to physicians that:

### Pacemaker patients



- Should keep wireless telephones at least six inches from the pacemaker.
- Should NOT place wireless telephones directly over the pacemaker, such as in a breast pocket, when it is turned ON.
- Should use the wireless telephone at the ear opposite the pacemaker.

WTR's evaluation did not identify any risk to bystanders with pacemakers from other persons using wireless telephones.

## Operating range

This cordless telephone operates with the maximum power allowed by the Federal Communications Commission (FCC). Even so, this handset and telephone base can communicate over only a certain distance - which can vary with the locations of the telephone base and handset, the weather, and the layout of your home or office.

When the handset is out of range, the handset displays **Out of range or no pwr at base**.

If there is a call while the handset is out of range, it may not ring, or if it does ring, the call may not connect well when you press . Move closer to the telephone base, then press  to answer the call.

If the handset moves out of range during a telephone conversation, there may be interference. To improve reception, move closer to the telephone base.

## The RBRC® seal



The RBRC® seal on the nickel-metal hydride battery indicates that VTech Communications, Inc. is voluntarily participating in an industry program to collect and recycle these batteries at the end of their useful lives, when taken out of service within the United States and Canada.

The RBRC® program provides a convenient alternative to placing used nickel-metal hydride batteries into the trash or municipal waste, which may be illegal in your area.



VTech's participation in RBRC® makes it easy for you to drop off the spent battery at local retailers participating in the RBRC® program or at authorized VTech product service centers. Please call **1 (800) 8 BATTERY™** for information on Ni-MH battery recycling and disposal bans/restrictions in your area. VTech's involvement in this program is part of its commitment to protecting our environment and conserving natural resources.

**RBRC® is a registered trademark of Rechargeable Battery Recycling Corporation.**

## Energy-saving charging mode

When this mode is activated, all telephone functions, except handset battery charging, will be disabled.

### To activate the energy-saving charging mode:

1. Unplug the telephone base power adapter from the power outlet. Make sure all handsets are plugged with charged batteries before proceeding.
2. While you **press and hold** /FIND HANDSET, plug the telephone base power adapter back to the power outlet.
3. After about 20 seconds, when the **IN USE** light starts flashing, release /FIND HANDSET and then press it again within 2 seconds.



When the phone successfully enters the energy-saving charging mode, the **IN USE** light turns off and all handsets display **To register...** and **...see manual** alternately.

When the phone fails to enter this mode, repeat Step 1 through Step 3 above.

**Note:** The telephone base will be powered up as normal if you fail to press /FIND HANDSET within 2 seconds in Step 3.

### To deactivate the energy-saving charging mode:

1. Unplug the telephone base power adapter from the power outlet, then plug it back in. Then the telephone base is powered up as normal.
2. Register your handsets back to the telephone base. See the online **Complete user's manual** at [www.vtechphones.com](http://www.vtechphones.com) for handset registration instructions.

# Maintenance

## Taking care of your telephone

Your cordless telephone contains sophisticated electronic parts, so it must be treated with care.

## Avoid rough treatment

Place the handset down gently. Save the original packing materials to protect your telephone if you ever need to ship it.

## Avoid water

Your telephone can be damaged if it gets wet. Do not use the handset outdoors in the rain, or handle it with wet hands. Do not install the telephone base near a sink, bathtub or shower.

## Electrical storms

Electrical storms can sometimes cause power surges harmful to electronic equipment. For your own safety, take caution when using electrical appliances during storms.

## Cleaning your telephone

Your telephone has a durable plastic casing that should retain its luster for many years. Clean it only with a soft cloth slightly dampened with water or mild soap. Do not use excess water or cleaning solvents for any kind.

Remember that electrical appliances can cause serious injury if used when you are wet or standing in water. If the telephone base should fall into water, DO NOT RETRIEVE IT UNTIL YOU UNPLUG THE POWER CORD AND TELEPHONE LINE CORD FROM THE WALL. Then remove the telephone by the unplugged cords.

# About cordless telephones

- **Privacy:** The same features that make a cordless telephone convenient create some limitations. Telephone calls are transmitted between the telephone base and the cordless handset by radio waves, so there is a possibility that the cordless telephone conversations could be intercepted by radio receiving equipment within range of the cordless handset. For this reason, you should not think of cordless telephone conversations as being as private as those on corded telephones.
- **Electrical power:** The telephone base of this cordless telephone must be connected to a working electrical outlet. The electrical outlet should not be controlled by a wall switch. Calls cannot be made from the cordless handset if the telephone base is unplugged, switched off or if the electrical power is interrupted.
- **Potential TV interference:** Some cordless telephones operate at frequencies that may cause interference to televisions and VCRs. To minimize or prevent such interference, do not place the telephone base of the cordless telephone near or on top of a TV or VCR. If interference is experienced, moving the cordless telephone farther away from the TV or VCR often reduces or eliminates the interference.
- **Rechargeable batteries:** Exercise care in handling batteries in order not to create a short circuit with conducting material such as rings, bracelets and keys. The battery or conductor may overheat and cause harm. Observe proper polarity between the battery and the battery charger.
- **Nickel-metal hydride rechargeable batteries:** Dispose of these batteries in a safe manner. Do not burn or puncture the battery. Like other batteries of this type, if burned or punctured, they could release caustic material which could cause injury.

# Limited warranty

## What does this limited warranty cover?

The manufacturer of this VTech Product warrants to the holder of a valid proof of purchase ("Consumer" or "you") that the Product and all accessories provided in the sales package ("Product") are free from defects in material and workmanship, pursuant to the following terms and conditions, when installed and used normally and in accordance with the Product operating instructions. This limited warranty extends only to the Consumer for Products purchased and used in the United States of America and Canada.

## What will VTech do if the Product is not free from defects in materials and workmanship during the limited warranty period ("Materially Defective Product")?

During the limited warranty period, VTech's authorized service representative will repair or replace at VTech's option, without charge, a Materially Defective Product. If we repair the Product, we may use new or refurbished replacement parts. If we choose to replace the Product, we may replace it with a new or refurbished Product of the same or similar design. We will retain defective parts, modules, or equipment. Repair or replacement of the Product, at VTech's option, is your exclusive remedy. VTech will return the repaired or replacement Products to you in working condition. You should expect the repair or replacement to take approximately 30 days.

## How long is the limited warranty period?

The limited warranty period for the Product extends for ONE (1) YEAR from the date of purchase. If VTech repairs or replaces a Materially Defective Product under the terms of this limited warranty, this limited warranty also applies to the repaired or replacement Product for a period of either (a) 90 days from the date the repaired or replacement Product is shipped to you or (b) the time remaining on the original one-year warranty; whichever is longer.

## What is not covered by this limited warranty?

This limited warranty does not cover:

1. Product that has been subjected to misuse, accident, shipping or other physical damage, improper installation, abnormal operation or handling, neglect, inundation, fire, water or other liquid intrusion; or
2. Product that has been damaged due to repair, alteration or modification by anyone other than an authorized service representative of VTech; or
3. Product to the extent that the problem experienced is caused by signal conditions, network reliability, or cable or antenna systems; or
4. Product to the extent that the problem is caused by use with non-VTech accessories; or
5. Product whose warranty/quality stickers, product serial number plates or electronic serial numbers have been removed, altered or rendered illegible; or
6. Product purchased, used, serviced, or shipped for repair from outside the United States of America or Canada, or used for commercial or institutional purposes (including but not limited to Products used for rental purposes); or
7. Product returned without a valid proof of purchase (see item 2 below); or
8. Charges for installation or set up, adjustment of customer controls, and installation or repair of systems outside the unit.

## How do you get warranty service?

To obtain warranty service in the USA, please visit our website at [www.vtechphones.com](http://www.vtechphones.com) or call 1 (800) 595-9511.

In Canada, go to [www.vtechcanada.com](http://www.vtechcanada.com) or call 1 (800) 267-7377.

**NOTE:** Before calling for service, please review the user's manual - a check of the Product's controls and features may save you a service call.

Except as provided by applicable law, you assume the risk of loss or damage during transit and transportation and are responsible for delivery or handling charges incurred in the transport of the Product(s) to the service location. VTech will return repaired or replaced Product under this limited warranty. Transportation, delivery or handling charges are prepaid. VTech assumes no risk for damage or loss of the Product in transit. If the Product failure is not covered by this limited warranty, or proof of purchase does not meet the terms of this limited warranty, VTech will notify you and will request that you authorize the cost of repair prior to any further repair activity. You must pay for the cost of repair and return shipping costs for the repair of Products that are not covered by this limited warranty.

## What must you return with the Product to get warranty service?

1. Return the entire original package and contents including the Product to the VTech service location along with a description of the malfunction or difficulty; and
2. Include a "valid proof of purchase" (sales receipt) identifying the Product purchased (Product model) and the date of purchase or receipt; and
3. Provide your name, complete and correct mailing address, and telephone number.

## Other limitations

This warranty is the complete and exclusive agreement between you and VTech. It supersedes all other written or oral communications related to this Product. VTech provides no other warranties for this Product. The warranty exclusively describes all of VTech's responsibilities regarding the Product. There are no other express warranties. No one is authorized to make modifications to this limited warranty and you should not rely on any such modification.

**State/Provincial Law Rights:** This warranty gives you specific legal rights, and you may also have other rights, which vary from state to state or province to province.

Limitations: Implied warranties, including those of fitness for a particular purpose and merchantability (an unwritten warranty that the Product is fit for ordinary use) are limited to one year from the date of purchase. Some states/provinces do not allow limitations on how long an implied warranty lasts, so the above limitation may not apply to you. In no event shall VTECH be liable for any indirect, special, incidental, consequential, or similar damages (including, but not limited to lost profits or revenue, inability to use the Product or other associated equipment, the cost of substitute equipment, and claims by third parties) resulting from the use of this Product. Some states/provinces do not allow the exclusion or limitation of incidental or consequential damages, so the above limitation or exclusion may not apply to you.

**Please retain your original sales receipt as proof of purchase.**

## FCC, ACTA and IC regulations

### FCC Part 15

This equipment has been tested and found to comply with the requirements for a Class B digital device under Part 15 of the Federal Communications Commission (FCC) rules. These requirements are intended to provide reasonable protection against harmful interference in a residential installation. This equipment generates, uses and can radiate radio frequency energy and, if not installed and used in accordance with the instructions, may cause harmful interference to radio communications. However, there is no guarantee that interference will not occur in a particular installation. If this equipment does cause harmful interference to radio or television reception, which can be determined by turning the equipment off and on, the user is encouraged to try to correct the interference by one or more of the following measures:

- Reorient or relocate the receiving antenna.
- Increase the separation between the equipment and receiver.
- Connect the equipment into an outlet on a circuit different from that to which the receiver is connected.
- Consult the dealer or an experienced radio/TV technician for help.

Changes or modifications to this equipment not expressly approved by the party responsible for compliance could void the user's authority to operate the equipment.

This device complies with Part 15 of the FCC rules. Operation is subject to the following two conditions: (1) this device may not cause harmful interference, and (2) this device must accept any interference received, including interference that may cause undesired operation. Privacy of communications may not be ensured when using this telephone.

To ensure safety of users, the FCC has established criteria for the amount of radio frequency energy that can be safely absorbed by a user or bystander according to the intended usage of the product. This product has been tested and found to comply with the FCC criteria. The handset may be safely held against the ear of the user. The telephone base shall be installed and used such that parts of the user's body other than the hands are maintained at a distance of approximately 20 cm (8 inches) or more.

This Class B digital apparatus complies with Canadian requirement:  
CAN ICES-3 (B)/NMB-3(B)

### FCC Part 68 and ACTA

This equipment complies with Part 68 of the FCC rules and with technical requirements adopted by the Administrative Council for Terminal Attachments (ACTA). The label on the back or bottom of this equipment contains, among other things, a product identifier in the format US:AAEQ##TXXXX. This identifier must be provided to your telephone service provider upon request.

The plug and jack used to connect this equipment to premises wiring and the telephone network must comply with applicable Part 68 rules and technical requirements adopted by ACTA. A compliant telephone cord and modular plug is provided with this product. It is designed to be connected to a compatible modular jack that is also compliant. An RJ11 jack should normally be used for connecting to a single line and an RJ14 jack for two lines. See the installation instructions in the user's manual.

The Ringer Equivalence Number (REN) is used to determine how many devices you may connect to your telephone line and still have them ring when you are called. The REN for this product is encoded as the 6th and 7th characters following the US: in the product identifier (e.g., if ## is 03, the REN is 0.3). In most, but not all areas, the sum of all RENs should be five (5.0) or less. For more information, please contact your telephone service provider.

This equipment may not be used with Party Lines. If you have specially wired alarm dialing equipment connected to your telephone line, ensure the connection of this equipment does not disable your alarm equipment. If you have questions about what will disable alarm equipment, contact your telephone service provider or a qualified installer.

If this equipment is malfunctioning, it must be unplugged from the modular jack until the problem has been corrected. Repairs to this telephone equipment can only be made by the manufacturer or its authorized agents. For repair procedures, follow the instructions outlined under the **Limited warranty**.

If this equipment is causing harm to the telephone network, the telephone service provider may temporarily discontinue your telephone service. The telephone service provider is required to notify you before interrupting service. If advance notice is not practical, you will be notified as soon as possible. You will be given the opportunity to correct the problem and the telephone service provider is required to inform you of your right to file a complaint with the FCC. Your telephone service provider may make changes in its facilities, equipment, operation, or procedures that could affect the proper functioning of this product. The telephone service provider is required to notify you if such changes are planned.

If this product is equipped with a corded or cordless handset, it is hearing aid compatible.

If this product has memory dialing locations, you may choose to store emergency telephone numbers (e.g., police, fire, medical) in these locations. If you do store or test emergency numbers, please:

Remain on the line and briefly explain the reason for the call before hanging up.

Perform such activities in off-peak hours, such as early morning or late evening.

### Industry Canada

Operation is subject to the following two conditions: (1) this device may not cause harmful interference, and (2) this device must accept any interference, including interference that may cause undesired operation.

The term "IC:" before the certification/registration number only signifies that the Industry Canada technical specifications were met.

The Ringer Equivalence Number (REN) for this terminal equipment is 1.0. The REN is an indication of the maximum number of devices allowed to be connected to a telephone interface. The termination on an interface may consist of any combination of devices subject only to the requirement that the sum of the RENs of all the devices does not exceed five.

This product meets the applicable Industry Canada technical specifications.

## Technical specifications

Frequency control	Crystal controlled PLL synthesizer
Transmit frequency	Handset: 1921.536-1928.448 MHz Telephone base: 1921.536-1928.448 MHz
Channels	5
Nominal effective range	Maximum power allowed by FCC and IC. Actual operating range may vary according to environmental conditions at the time of use.
Power requirements	Handset: 2.4V Ni-MH battery Telephone base: 6V DC @ 400mA Charger: 6V AC @ 300mA
Memory	Directory: 50 memory locations; up to 30 digits and 15 characters Caller ID log: 50 memory locations; up to 24 digits and 15 characters

VTECH TELECOMMUNICATIONS LTD.

A member of THE VTECH GROUP OF COMPANIES.

Distributed in the U.S.A. by VTECH Communications, Inc., Beaverton, Oregon 97008.

Distributed in Canada by VTECH Technologies Canada Ltd., Richmond, B.C. V6W 1L5.

VTECH is the registered trademark of VTECH Holdings Limited.

Copyright © 2013 for VTECH TELECOMMUNICATIONS LTD.

All rights reserved. Printed in China.