

Go to www.vtechphones.com for support and the latest VTech product news.

VM981

Wi-Fi HD Video Monitor



vtech[®]

Installation guide

Congratulations

on purchasing your new VTech product. Before using this HD video monitor, please read **Important safety instructions**.

For support, shopping, and everything new at VTech, visit our website at www.vtechphones.com.

What's in the box

Your HD video monitor package contains the following items. Save your sales receipt and original packaging in the event warranty service is necessary.

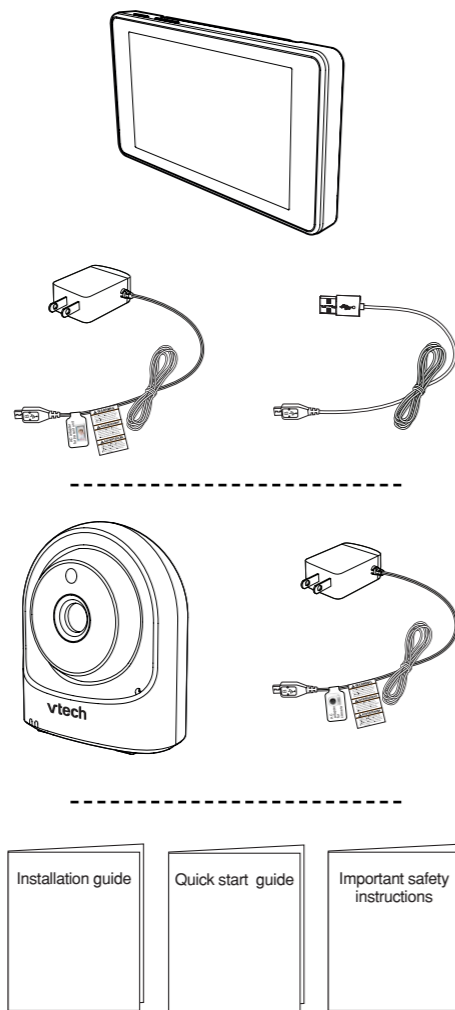

Requirements

Make sure your system includes the following components, and they meet the minimum requirement.

Network	Wi-Fi
Wi-Fi router	2.4GHz IEEE 802.11 b/g/n
Internet connection	At least 1.0 Mbps upload bandwidth per camera

Overview

Camera unit overview

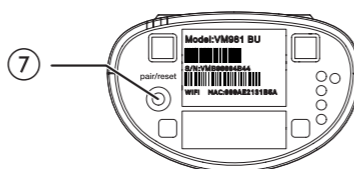
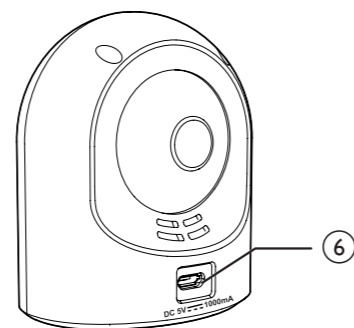
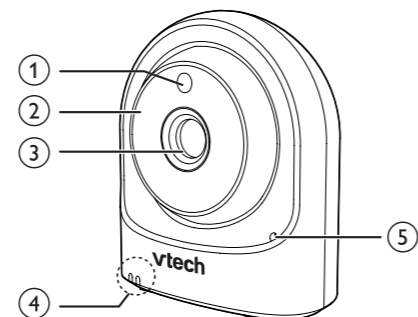

Parent unit overview

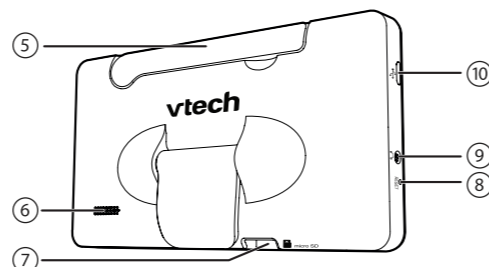
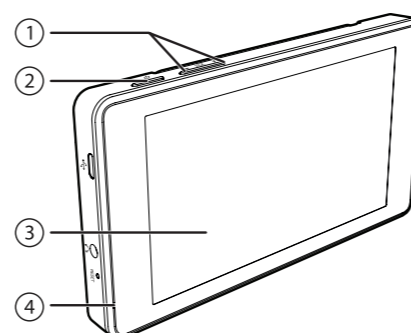

1	Light sensor
2	Infrared LEDs <ul style="list-style-type: none"> Allow you to see clearly in a dark surrounding.
3	Camera lens
4	LED indicators <ul style="list-style-type: none"> Flash orange and blue alternately when the camera unit is in pairing mode. Orange is steady on when the camera unit is connecting to the Internet. Orange and blue are steady on when the camera unit is idle. Flash orange and blue slowly during video streaming. Flash orange and blue quickly and alternately when the camera unit is updating its firmware.
5	Microphone
6	Power jack
7	Pair/reset button <ul style="list-style-type: none"> Press and hold for three seconds to enter pairing mode.

1	+ / VOL / - <ul style="list-style-type: none"> Press to increase or decrease the speaker volume.
2	Power <ul style="list-style-type: none"> Press and hold to power on or off, or to reboot the parent unit. Press to turn on or off the screen display without powering off the parent unit. You can still hear sound from the camera unit if the camera is streaming and the speaker volume of the parent unit is turned on.
3	5-inch touch screen monitor <ul style="list-style-type: none"> When the screen is turned on and locked, swipe to unlock the screen.
4	Microphone
5	Antenna
6	Speaker
7	micro SD card slot
8	RESET <ul style="list-style-type: none"> Force reboot the parent unit.
9	3.5mm audio jack <ul style="list-style-type: none"> Connect to stereo earphone.
10	Micro USB 2.0 port <ul style="list-style-type: none"> Connect to a power supply for charging. Connect to a personal computer as an external storage for transferring manually captured snapshots and recorded videos stored in the parent unit.

How the system works

The Wi-Fi router (not included) provides Internet connectivity to your HD video monitor system. It serves as a communicating channel between your camera unit and parent unit, allowing you to monitor and/or control your camera unit wherever you are.

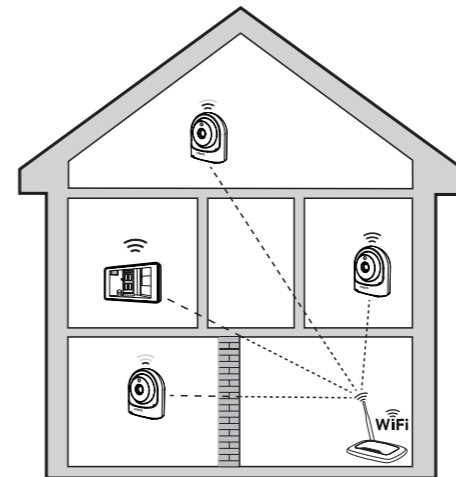

Protect your privacy and online security

VTech cares about your privacy and peace of mind. That's why we've put together a list of industry-recommended best practices to help keep your wireless connection private and your devices protected when online. We recommend you carefully review and consider complying with the following tips.

Ensure your wireless connection is secure.

- Before installing a device, ensure your router's wireless signal is encrypted by selecting the "WPA2-PSK with AES" setting in your router's wireless security menu.

Change default settings.

- Change your wireless router's default wireless network name (SSID) to something unique.
- Change default passwords to unique, strong passwords. A strong password:
 - Is at least 10 characters long.
 - Is complex.
 - Does not contain dictionary words or personal information.

- Contains a mix of uppercase letters, lowercase letters, special characters and numbers.

Keep your devices up to date.

- Download security patches from manufacturers as soon as they become available. This will ensure you always have the latest security updates.
- If the feature is available, enable automatic updates for future releases.

Disable Universal Plug and Play (UPnP) on your router.

- UPnP enabled on a router can limit the effectiveness of your firewall by allowing other network devices to open inbound ports without any intervention or approval from you. A virus or other malware program could use this function to compromise security for the entire network.

For more information on wireless connections and protecting your data, please review the following resources from industry experts:

- Federal Communications Commission: Wireless Connections and Bluetooth Security Tips – www.fcc.gov/consumers/guides/how-protect-yourself-online.
- U.S. Department of Homeland Security: Before You Connect a New Computer to the Internet – www.us-cert.gov/ncas/tips/ST15-003.
- Federal Trade Commission: Using IP Cameras Safely – <https://www.consumer.ftc.gov/articles/0382-using-ip-cameras-safely>.
- Wi-Fi Alliance: Discover Wi-Fi Security – <http://www.wi-fi.org/discover-wi-fi/security>.

Connect

NOTES

- Use only the power adapters supplied with this product.
- Make sure the electrical outlets are not controlled by wall switches.
- The power adapters are intended to be correctly oriented in a vertical or floor mount position. The prongs are not designed to hold the plug in place if it is plugged into a ceiling, under-the-table, or cabinet outlet.
- Make sure the parent unit, the camera unit and the power adapter cords are out of reach of children.

Connect the camera unit

Wi-Fi connection

NOTES

- Before you connect the camera unit, make sure you have Internet access and a Wi-Fi router (IEEE 802.11 b/g/n). Charges apply and service plan may vary for Internet access. Router is not included.
- To maintain compliance with the FCC's RF exposure guidelines, place the camera unit at least 20cm from nearby persons.

- Connect the power adapter to the camera unit and a power supply.

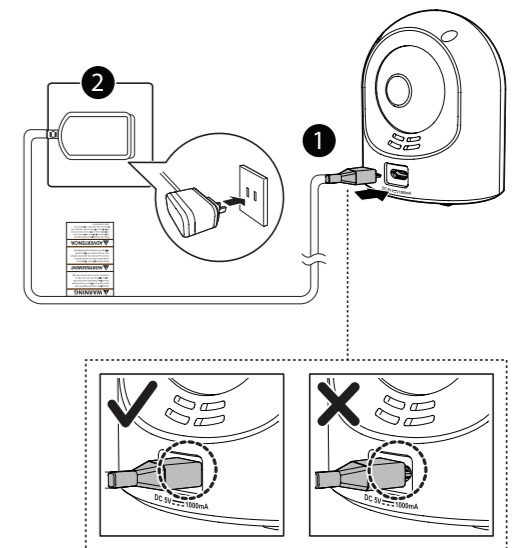

- Place the camera unit at a desired place.

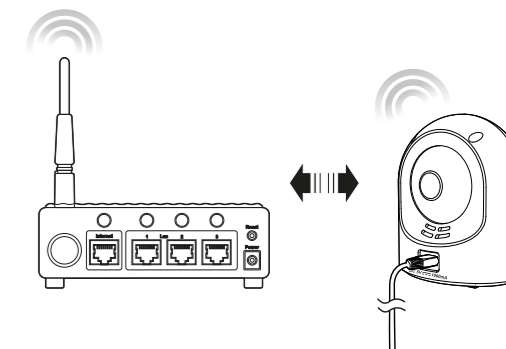

NOTE

- To turn off the camera unit, unplug the camera unit from the power supply.

Connect and charge the parent unit

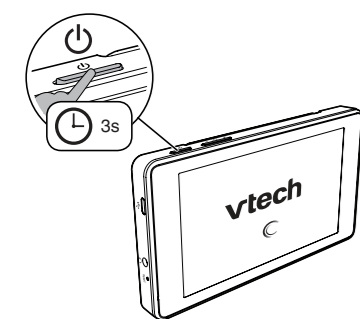
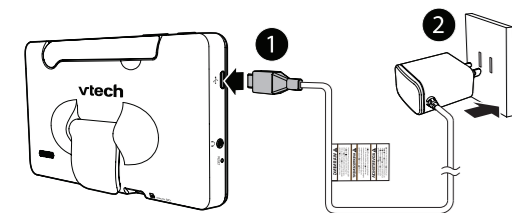

When you have connected the parent unit, **press and hold**  to power on.



The battery icon indicates the battery status (see the following table).

NOTES

- The parent unit is fully charged after 3 hours of continuous charging.
- It takes longer to charge when the parent unit is turned on. To shorten the charging time, turn the parent unit off while charging.
- The standby time varies depending on your actual use.

Battery indicators	Battery status	Action
The screen displays 	The battery has very little charge and may be used for only a short time.	Charge without interruption (about 30 minutes).
The battery icon becomes solid 	The battery is fully charged.	To keep the battery charged, connect it to AC power when not in use.

Insert micro SD card (optional)

Insert micro SD card into the parent unit (optional)

Your parent unit comes with 4GB internal flash memory that allows you to store snapshots captured and videos recorded manually with your camera. You can also insert a micro SD card into the parent unit for more storage capacity.

NOTE

- Some of the internal flash memory will be occupied by the parent unit's operating system and data storage. The actual memory available will be less than 4GB.

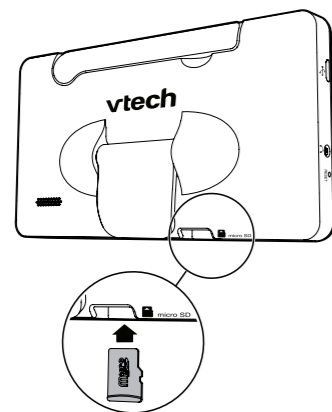

Test the location for the camera unit

Before you install your camera unit, you need to test which of your selected monitoring areas within the house have good Wi-Fi signal strength. You can use your parent unit's Wi-Fi signal strength indicator to assist in checking. Once you have identified the suitable location, you can install your camera unit. Adjust the distance between your camera unit and the Wi-Fi router if needed.

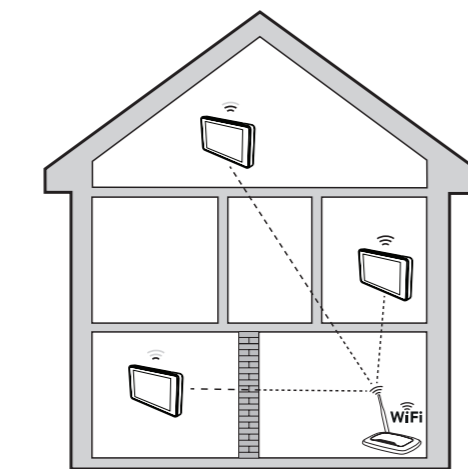

TIP

- Depending on surroundings and obstructing factors, such as the effect distance and internal walls have on signal strength, you may experience reduced Wi-Fi signal. To improve the Wi-Fi signal strength, adjust the distance or direction of your parent unit. Check with your parent unit again.

Set up the HD video monitor

After you have connected the parent unit and the camera unit, refer to the Quick start guide included in your package to set up your HD video monitor system.

HD video monitor setup:

- Set up Wi-Fi connection
- Add camera

Before use

NOTE

- This HD video monitor is intended as an aid. It is not a substitute for proper adult supervision, and should not be used as such.

Testing the sound level of the HD video monitor

CAUTION

- For hearing protection, make sure the parent unit is more than 1 meter (3 feet) away from the camera unit. If you hear any high-pitched noise from the parent unit when the Play sound function of the camera unit is enabled, move the parent unit further until the noise stops. You can also press **-VOL** on the parent unit to lower or mute the noise.

TIP

- Increase the parent unit speaker volume if you cannot hear the sounds transmitted from the camera unit when the Play sound function is enabled.

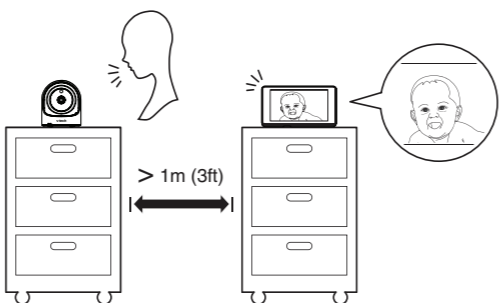

Positioning the HD video monitor

CAUTION

- Keep the camera unit out of the reach of your baby. Never place or mount the camera unit inside the baby's crib or playpen.

- Place the camera unit more than 1 meter (3 feet) away from your baby.

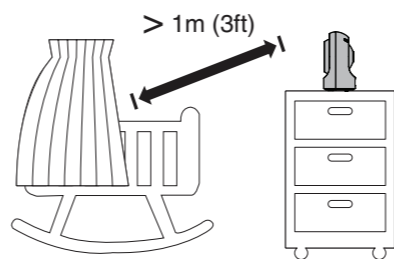

- Adjust the angle of the camera manually to aim at your baby.

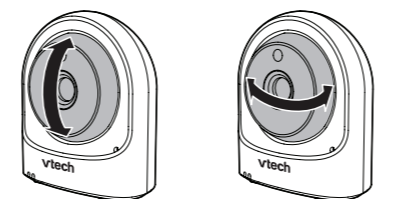

- To avoid causing high-pitched screeching noise from your HD video monitor when the Play sound function of the camera unit is enabled:
 - Make sure your camera unit and parent unit are more than 1 meter (3 feet) apart; OR
 - Turn down the volume of your parent unit.

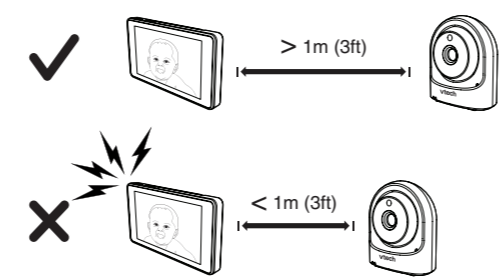

Pair new camera unit

You can add or replace any camera units to your HD video monitor system.

The HD video monitoring family includes **VM981** and **VM991**. Their respective camera units are **VM980** and **VM990**, which can be purchased separately. They can be cross-paired within the family, for example, you can have a combination of **VM981** and **VM990**. You can pair a maximum of 10 camera units to your parent unit.

For more details, refer to the installation guide of your new camera unit (**VM980** or **VM990**). You can also refer to the online installation guides and app manuals of your HD video monitor system (**VM981** or **VM991**) in the Help page of your parent unit.

General product care

To keep this product working well and looking good, follow these guidelines:

- Avoid putting it near heating appliances and devices that generate electrical noise (for example, motors or fluorescent lamps).
- DO NOT expose it to direct sunlight or moisture.
- Avoid dropping the product or treating it roughly.
- Clean with a soft cloth.
- DO NOT immerse the camera unit in water and do not clean it under the tap.
- DO NOT use cleaning spray or liquid cleaners.
- Make sure the camera unit is dry before you connect it to the mains again.

Storage

When you are not going to use the camera for some time, store the camera unit and the adapter in a cool and dry place.

Frequently asked questions

Below are the questions most frequently asked about the HD video monitor. If you cannot find the answer to your question, visit our website at (US) www.vtechphones.com or (Canada) www.vtechcanada.com; or call 1-844-848-8324 (1-844-84-VTECH).

Why does the camera not respond normally?	Try the following (in the order listed) for common cure: 1. Disconnect the power to the camera unit. 2. Wait a few minutes before connecting power back to the camera unit. 3. Run the app again.
Why is my screen in black and white?	The screen is in black and white during nighttime or in a dark room. This is normal due to external light sources.
Why does my camera show offline? Why is the connection lost every now and then?	The camera unit may lose the Internet connection. Check your network and the router setting. Other electronic products may cause interference with your camera. Try installing your camera as far away from these electronic devices as possible.

Limited warranty

What does this limited warranty cover?

The manufacturer of this VTech Product warrants to the holder of a valid proof of purchase ("Consumer" or "you") that the Product and all accessories provided in the sales package ("Product") are free from defects in material and workmanship, pursuant to the following terms and conditions, when installed and used normally and in accordance with the Product operating instructions. This limited warranty extends only to the Consumer for Products purchased and used in the United States of America and Canada.

What will VTech do if the Product is not free from defects in materials and workmanship during the limited warranty period ("Materially Defective Product")?

During the limited warranty period, VTech's authorized service representative will repair or replace at VTech's option, without charge, a Materially Defective Product. If we repair the Product, we may use new or refurbished replacement parts. If we choose to replace the Product, we may replace it with a new or refurbished Product of the same or similar design. We will retain defective

parts, modules, or equipment. Repair or replacement of the Product, at VTech's option, is your exclusive remedy. VTech will return the repaired or replacement Products to you in working condition. You should expect the repair or replacement to take approximately 30 days.

How long is the limited warranty period?

The limited warranty period for the Product extends for ONE (1) YEAR from the date of purchase. If VTech repairs or replaces a Materially Defective Product under the terms of this limited warranty, this limited warranty also applies to the repaired or replacement Product for a period of either (a) 90 days from the date the repaired or replacement Product is shipped to you or (b) the time remaining on the original one-year warranty; whichever is longer.

What is not covered by this limited warranty?

This limited warranty does not cover:

- Product that has been subjected to misuse, accident, shipping or other physical damage, improper installation, abnormal operation or handling, neglect, inundation, fire, water or other liquid intrusion; or
- Product that has been damaged due to repair, alteration or modification by anyone other than an authorized service representative of VTech; or
- Product to the extent that the problem experienced is caused by signal conditions, network reliability, or cable or antenna systems; or
- Product to the extent that the problem is caused by use with non-VTech accessories; or
- Product whose warranty/quality stickers, product serial number plates or electronic serial numbers have been removed, altered or rendered illegible; or
- Product purchased, used, serviced, or shipped for repair from outside the United States of America or Canada, or used for commercial or institutional purposes (including but not limited to Products used for rental purposes); or
- Product returned without a valid proof of purchase (see item 2 on the next page); or
- Charges for installation or set up, adjustment of customer controls, and installation or repair of systems outside the unit.

How do you get warranty service?

To obtain warranty service in the USA and Canada, please visit our website at (US) www.vtechphones.com or (Canada) www.vtechcanada.com; or call 1-844-848-8324 (1-844-84-VTECH).

NOTE: Before calling for service, please review the user's manual - a check of the Product's controls and features may save you a service call.

Except as provided by applicable law, you assume the risk of loss or damage during transit and transportation and are responsible for delivery or handling charges incurred in the transport of the Product(s) to the service location. VTech will return repaired or replaced Product

under this limited warranty. Transportation, delivery or handling charges are prepaid. VTech assumes no risk for damage or loss of the Product in transit. If the Product failure is not covered by this limited warranty, or proof of purchase does not meet the terms of this limited warranty, VTech will notify you and will request that you authorize the cost of repair prior to any further repair activity. You must pay for the cost of repair and return shipping costs for the repair of Products that are not covered by this limited warranty.

What must you return with the Product to get warranty service?

- Return the entire original package and contents including the Product to the VTech service location along with a description of the malfunction or difficulty; and
- Include a "valid proof of purchase" (sales receipt) identifying the Product purchased (Product model) and the date of purchase or receipt; and
- Provide your name, complete and correct mailing address, and telephone number.

Other limitations

This warranty is the complete and exclusive agreement between you and VTech. It supersedes all other written or oral communications related to this Product. VTech provides no other warranties for this Product. The warranty exclusively describes all of VTech's responsibilities regarding the Product. There are no other express warranties. No one is authorized to make modifications to this limited warranty and you should not rely on any such modification.

State/Provincial Law Rights: This warranty gives you specific legal rights, and you may also have other rights, which vary from state to state or province to province.

Limitations: Implied warranties, including those of fitness for a particular purpose and merchantability (an unwritten warranty that the Product is fit for ordinary use) are limited to one year from the date of purchase. Some states/provinces do not allow limitations on how long an implied warranty lasts, so the above limitation may not apply to you. In no event shall VTech be liable for any indirect, special, incidental, consequential, or similar damages (including, but not limited to lost profits or revenue, inability to use the Product or other associated equipment, the cost of substitute equipment, and claims by third parties) resulting from the use of this Product. Some states/provinces do not allow the exclusion or limitation of incidental or consequential damages, so the above limitation or exclusion may not apply to you.

Please retain your original sales receipt as proof of purchase.

Technical specifications

Frequency	Camera unit: 2412 - 2462 MHz
Channels	11
LCD	5" Color LCD (IPS 480x854 pixel)
Nominal effective range	Maximum power allowed by FCC and IC. Actual operating range may vary according to environmental conditions at the time of use.
Power requirement	1. Parent unit power adapter: Input: 100-240V AC 50/60Hz Output: 5V DC 1.5A 2. Parent unit USB charger: 5V DC 3. Parent unit: 3.7V Li-polymer battery is built-in. Camera unit power adapter: Input: 100-240V AC 50/60Hz Output: 5V DC 1000mA