



## **Analog Contemporary Series Master User Guide**

### Models:

- Analog corded lobby hotel telephone - A2100,
- Analog corded 1-line hotel telephone - A2210,
- Analog corded 2-line hotel telephone - A2220,
- Analog corded trimstyle hotel telephone - A2310,
- Analog cordless 1-line hotel telephone - A2410/CTM-A2411,
- Analog cordless 2-line hotel telephone - A2420/CTM-A2421,
- Analog corded/cordless 1-line hotel telephone - CTM-A2510
- Analog cordless charging base - C4000/C4001
- Analog cordless charging stand - C4010/C4011
- Analog cordless 1-line accessory handset - C4100/CTM-C4101, and
- Analog cordless 2-line accessory handset - C4200/CTM-C4201

## **IMPORTANTES MESURES DE SÉCURITÉ**

Certaines mesures de sécurité doivent être prises pendant l'utilisation de matériel téléphonique afin de réduire les risques d'incendie, de choc électrique et de blessures. En voici quelquesunes:

1. Ne pas utiliser l'appareil près de l'eau, p.ex., près d'une baignoire, d'un lavabo, d'un évier de cuisine, d'un bac à laver, dans un sous-sol humide ou près d'une piscine.
2. Éviter d'utiliser le téléphone (sauf s'il s'agit d'un appareil sans fil) pendant un orage électrique. Ceci peut présenter un risque de choc électrique causé par la foudre.
3. Ne pas utiliser l'appareil téléphonique pour signaler une fuite de gaz s'il est situé près de la fuite.
4. Utiliser seulement le cordon d'alimentation et le type de piles indiqués dans ce manuel. Ne pas jeter les piles dans le feu: elles peuvent exploser. Se conformer aux règlements pertinents quant à l'élimination des piles.
5. La socklet-sortie sera installée près de l'équipement et sera facilement accessible.
6. **ATTENTION-** Il y a danger d'explosion s'il y a remplacement incorrect de la batterie. Remplacer uniquement avec une batterie du même type ou d'un type équivalent recommandé par le constructeur. Mettre au rebut les batteries usagées conformément aux instructions du fabricant.

### **CONSERVER CES INSTRUCTIONS**

## Important safety instructions

When using your telephone equipment, basic safety precautions should always be followed to reduce the risk of fire, electric shock and injury, including the following:

1. This product should be installed by a qualified technician.
2. This product should only be connected to the host equipment and never directly to the network such as Public Switch Telephone Network (PSTN) or Plain Old Telephone Services (POTS).
3. Read and understand all instructions.
4. Follow all warnings and instructions marked on the product.
5. Unplug this product from the wall outlet before cleaning. Do not use liquid or aerosol cleaners. Use a damp cloth for cleaning.
6. Do not use this product near water such as near a bath tub, wash bowl, kitchen sink, laundry tub or swimming pool, or in a wet basement or shower.
7. Do not place this product on an unstable table, shelf, stand or other unstable surfaces.
8. Slots and openings in the back or bottom of the telephone base and handset are provided for ventilation. To protect them from overheating, these openings must not be blocked by placing the product on a soft surface such as a bed, sofa or rug. This product should never be placed near or over a radiator or heat register. This product should not be placed in any area where proper ventilation is not provided.
9. This product should be operated only from the type of power source indicated on the marking label. If you are not sure of the type of power supply on the premises, consult your dealer or local power company.
10. Do not allow anything to rest on the power cord. Do not install this product where the cord may be walked on.
11. Never push objects of any kind into this product through the slots in the telephone base or handset because they may touch dangerous voltage points or create a short circuit. Never spill liquid of any kind on the product.
12. To reduce the risk of electric shock, do not disassemble this product, but take it to an authorized service facility. Opening or removing parts of the telephone base or handset other than specified access doors may expose you to dangerous voltages or other risks. Incorrect reassembling can cause electric shock when the product is subsequently used.
13. Do not overload wall outlets and extension cords.
14. Unplug this product from the wall outlet and refer servicing to an authorized service facility under the following conditions:
  - A. When the power supply cord or plug is damaged or frayed.
  - B. If liquid has been spilled onto the product.
  - C. If the product has been exposed to rain or water.
  - D. If the product does not operate normally by following the operating instructions. Adjust only those controls that are covered by the operation instructions. Improper adjustment of other controls may result in damage and often requires extensive work by an authorized technician to restore the product to normal operation.
  - E. If the product has been dropped and the telephone base and/or handset has been damaged.
  - F. If the product exhibits a distinct change in performance.
15. Avoid using a telephone (other than cordless) during an electrical storm. There is a remote risk of electric shock from lightning.
16. Do not use the telephone to report a gas leak in the vicinity of the leak. Under certain circumstances, a spark may be created when the adapter is plugged into the power outlet, or when the handset is replaced in its cradle. This is a common event associated with the closing of any electrical circuit. The user should not plug the phone into a power outlet, and should not put a charged handset into the cradle, if the phone is located in an environment containing concentrations of flammable or flame-supporting gases, unless there is adequate ventilation. A spark in such an environment could create a fire or explosion. Such environments might include: medical use of oxygen without adequate ventilation; industrial gases (cleaning solvents; gasoline vapors; etc.); a leak of natural gas; etc.
17. Only put the handset of your telephone next to your ear when it is in normal talk mode.
18. The power adapters are intended to be correctly oriented in a vertical or floor mount position. The prongs are not designed to hold the plug in place if it is plugged into a ceiling, under-the-table or cabinet outlet.
19. Use only the power cord and batteries indicated in this manual. Do not dispose of batteries in a fire. They may explode. Check with local codes for possible special disposal instructions.
20. In wall mounting position, make sure to mount the telephone base on the wall by aligning the eyelets with the mounting studs of the wall plate. Then slide the telephone base down on both mounting studs until it locks into place. Refer to the full instructions in **Installation** in the user's manual.
21. **CAUTION:** Keep small metallic objects such as pins and staples away from the handset receiver.
22. **CAUTION:** There may be a risk of explosion if a wrong type of handset battery is used (A2410, A2420, C4100, C4200, CTM-A2411, CTM-A2421, CTM-A2510, CTM-C4101 and CTM-C4201). Use only the supplied rechargeable battery (BT264392/ BT266342) or replacement battery (BT266342). Dispose of used batteries according to the information in **The RBRC® seal** in the user's manual.





















































**SAVE THESE INSTRUCTIONS**

# Table of contents

<b>IMPORTANTES MESURES DE SÉCURITÉ .....</b>	<b>i</b>
<b>Parts checklist .....</b>	<b>1</b>
<b>Telephone layout .....</b>	<b>3</b>
Analog corded lobby - A2100 .....	3
Analog corded 1-line - A2210 .....	4
Analog corded 2-line - A2220 .....	5
Analog corded trimstyle - A2310 .....	6
Analog cordless 1-line - A2410 .....	7
Analog cordless 1-line - CTM-A2411 .....	8
Analog cordless 2-line - A2420 .....	9
Analog cordless 2-line - CTM-A2421 .....	10
Analog corded/cordless 1-line - CTM-A2510 .....	11
Analog cordless charging base - C4000/C4001 .....	12
Analog cordless charging stand - C4010/C4011 .....	13
Analog cordless 1-line accessory handset - C4100 .....	14
Analog cordless 1-line accessory handset - CTM-C4101 .....	15
Analog cordless 2-line accessory handset - C4200 .....	16
Analog cordless 2-line accessory handset - CTM-C4201 .....	17
<b>Installation .....</b>	<b>18</b>
Analog corded lobby/1-line/2-line - A2100/A2210/A2220 .....	18
Analog corded trimstyle - A2310 .....	20
Analog cordless 1-line/2-line - A2410/CTM-A2411/A2420/CTM-A2421 .....	22
Analog corded/cordless 1-line - CTM-A2510 .....	25
Analog corded/cordless 1-line - CTM-A2510 .....	26
Analog corded/cordless 1-line - CTM-A2510 .....	27
Analog corded/cordless 1-line - CTM-A2510 .....	28
Analog cordless charging base - C4000 .....	29
Analog cordless charging base - C4001 .....	30
Analog cordless charging stand - C4010 .....	31
Analog cordless charging stand - C4011 .....	32
Analog cordless 1-line/2-line accessory handset - C4100/CTM-C4101/C4200/CTM-C4201 .....	33
<b>Telephone settings .....</b>	<b>34</b>
Analog corded lobby/1-line/2-line/trimstyle - A2100/A2210/A2220/A2310 .....	34
Analog cordless 1-line/2-line - A2410/CTM-A2411/A2420/CTM-A2421 .....	36
Analog corded/cordless 1-line - CTM-A2510 .....	36
Analog cordless 1-line/2-line accessory handset - CTM-C4101/CTM-C4201 .....	36
<b>Telephone operation .....</b>	<b>39</b>
Analog corded lobby - A2100 .....	39
Analog corded 1-line - A2210 .....	40
Analog corded 2-line - A2220 .....	42
Analog corded trimstyle - A2310 .....	44
Analog cordless 1-line - A2410/CTM-A2411 .....	45
Analog cordless 2-line - A2420/CTM-A2421 .....	48
Analog corded/cordless 1-line - CTM-A2510 .....	51
<b>Appendix .....</b>	<b>53</b>
Handset battery .....	53
Troubleshooting .....	54
Precautions for users of implanted cardiac pacemakers .....	57
Operating range .....	57
About cordless telephones .....	57
The RBRC® seal .....	57
VTech Hospitality limited warranty program .....	58
FCC, ACTA and IC regulations .....	59
Maintenance .....	60
Technical specifications .....	61
<b>Index .....</b>	<b>63</b>























# Parts checklist

Items contained in the respective telephone package:

Model Name	Model number	Parts included
Analog corded lobby	A2100	 Telephone base with faceplate and overlay  Corded handset  Mounting bracket  Telephone line cord
Analog corded 1-line	A2210	 Telephone base with faceplate and overlay  Corded handset  Mounting bracket  Telephone line cord
Analog corded 2-line	A2220	 Telephone base with faceplate and overlay  Corded handset  Mounting bracket  Telephone line cord
Analog corded trimstyle	A2310	 Telephone base with faceplate and overlay  Corded handset  Mounting bracket  Telephone line cords (2)
Analog cordless 1-line	A2410	 Telephone base with faceplate and overlay  Cordless handset  Mounting bracket  Battery  Screw  Power adapter with RJ-45 cord  Telephone line cord
Analog cordless 1-line	CTM-A2411	 Telephone base with faceplate and overlay  Cordless handset  Mounting bracket  Battery  Screw  Power adapter with RJ-45 cord  Telephone line cord
Analog cordless 2-line	A2420	 Telephone base with faceplate and overlay  Cordless handset  Mounting bracket  Battery  Screw  Power adapter with RJ-45 cord  Telephone line cord
Analog cordless 2-line	CTM-A2421	 Telephone base with faceplate and overlay  Cordless handset  Mounting bracket  Battery  Screw  Power adapter with RJ-45 cord  Telephone line cord
Analog corded/cordless 1-line	CTM-A2510	 Telephone base with faceplate and overlay  Cordless handset  Mounting bracket  Battery  Screw  Telephone line cord
		 Charging stand  Telephone base power adapter  Power adapter with RJ-45 cord

# Parts checklist

Items contained in the respective telephone package:

Model Name	Model number	Parts included
Analog cordless charging base	C4000	   Charging base    Mounting bracket with a screw    Power adapter with RJ-45 cord
Analog cordless charging base	C4001	   Charging base    Mounting bracket with a screw    Charger power adapter
Analog cordless charging stand	C4010	  Charging stand    Power adapter with RJ-45 cord
Analog cordless charging stand	C4011	  Charging stand    Charger power adapter
Analog cordless 1-line accessory handset	C4100	   Cordless handset    Battery    Screw
Analog cordless 1-line accessory handset	CTM-C4101	   Cordless handset    Battery    Screw
Analog cordless 2-line accessory handset	C4200	   Cordless handset    Battery    Screw
Analog cordless 2-line accessory handset	CTM-C4201	   Cordless handset    Battery    Screw

# Telephone layout

## Analog corded lobby - A2100

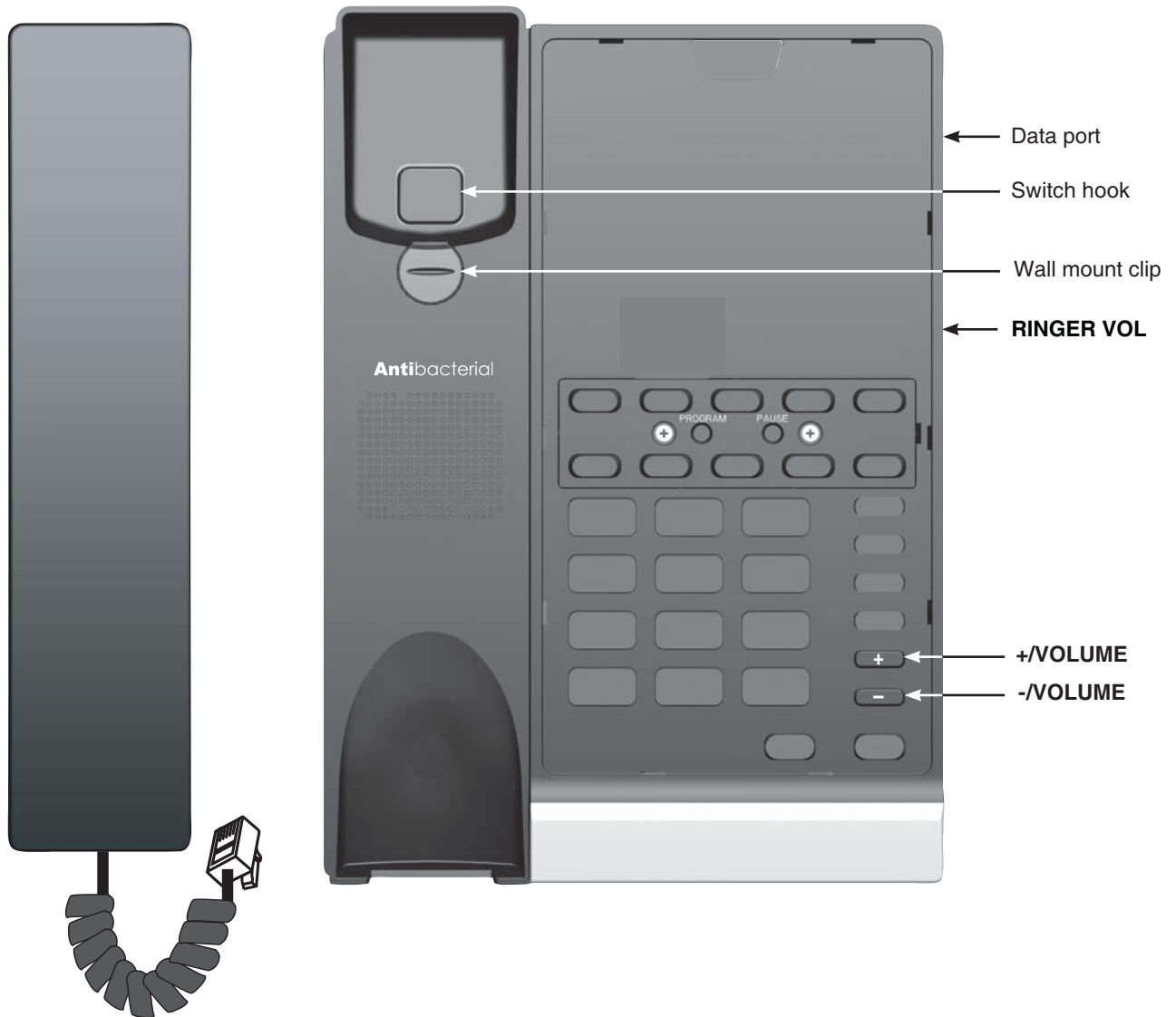

# Telephone layout

## Analog corded 1-line - A2210





# Telephone layout

## Analog corded 2-line - A2220

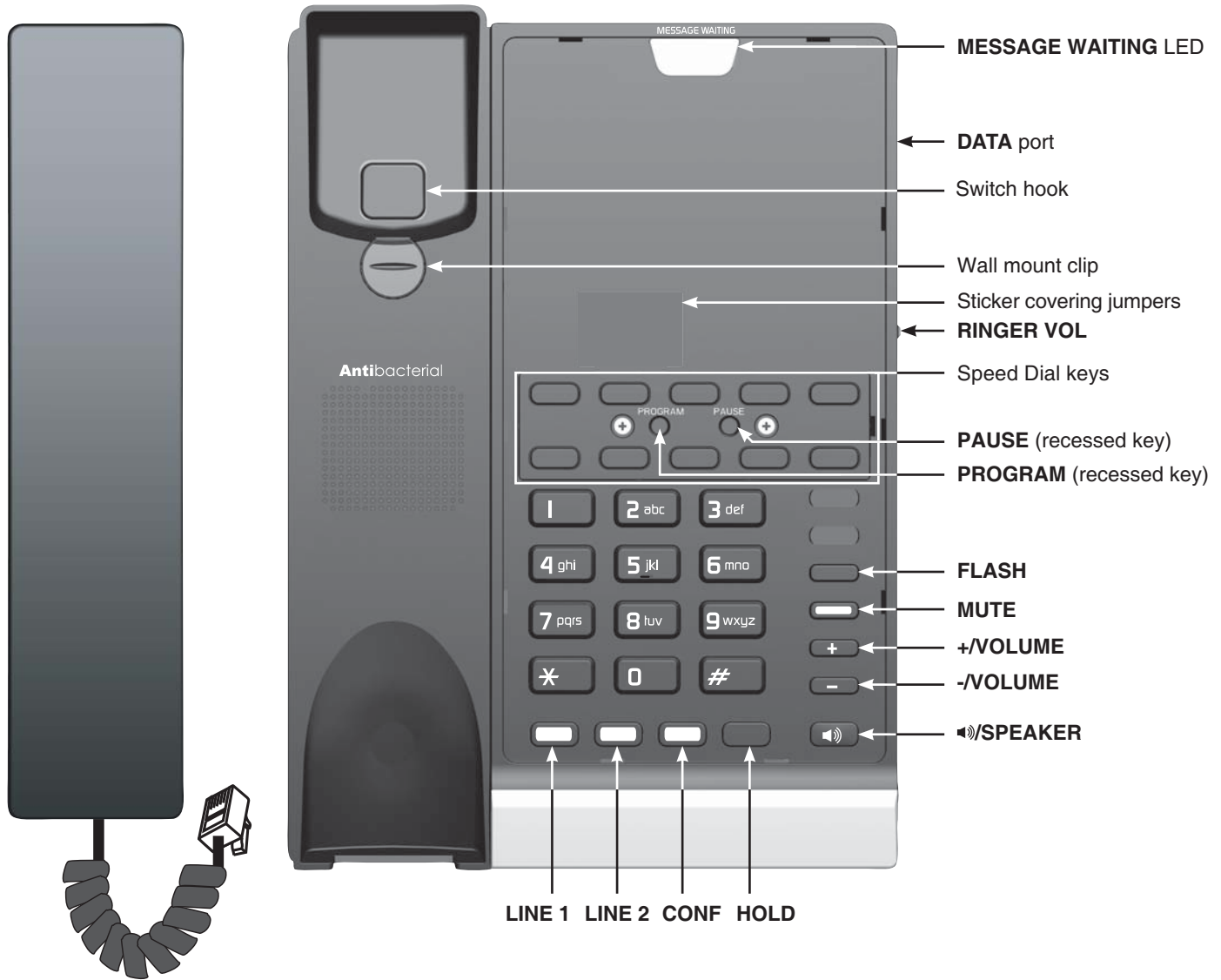

Telephone layout

# Telephone layout

## Analog corded trimstyle - A2310



# Telephone layout

## Analog cordless 1-line - A2410

Telephone layout

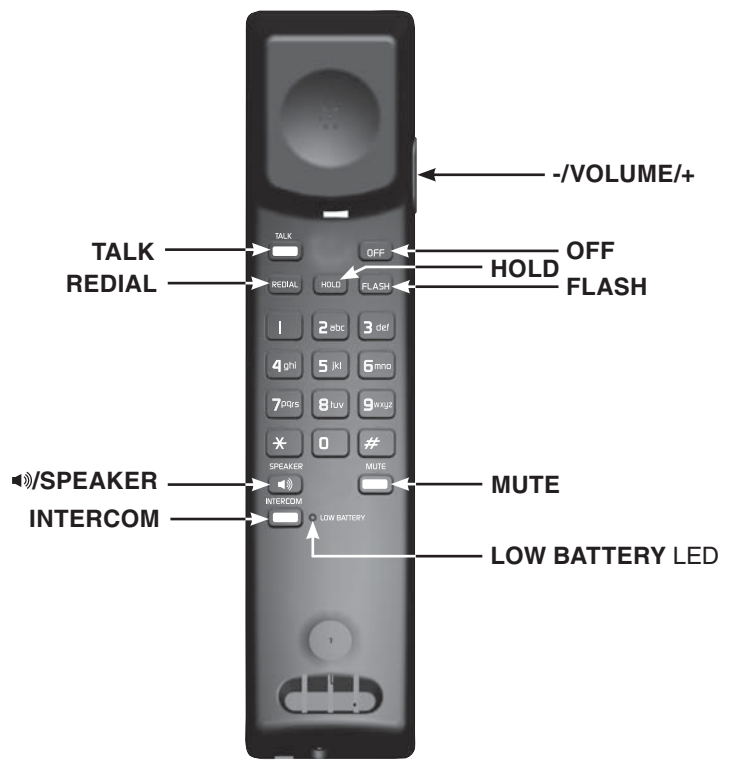
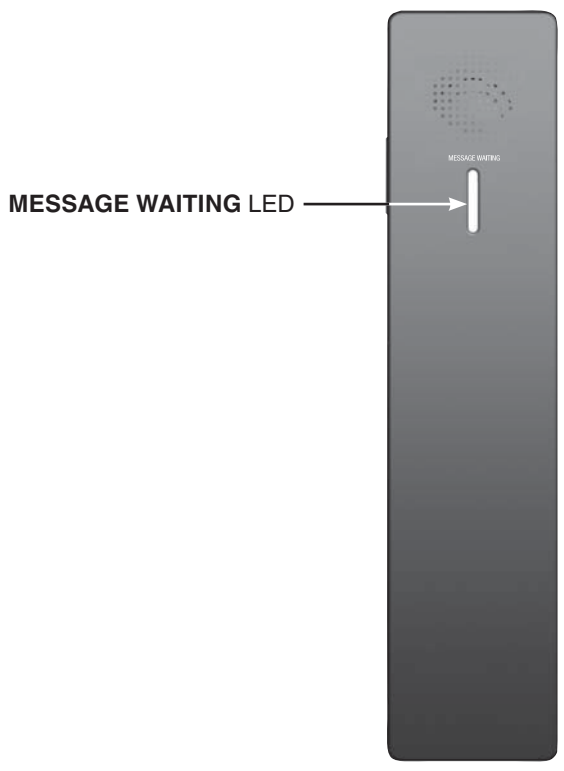
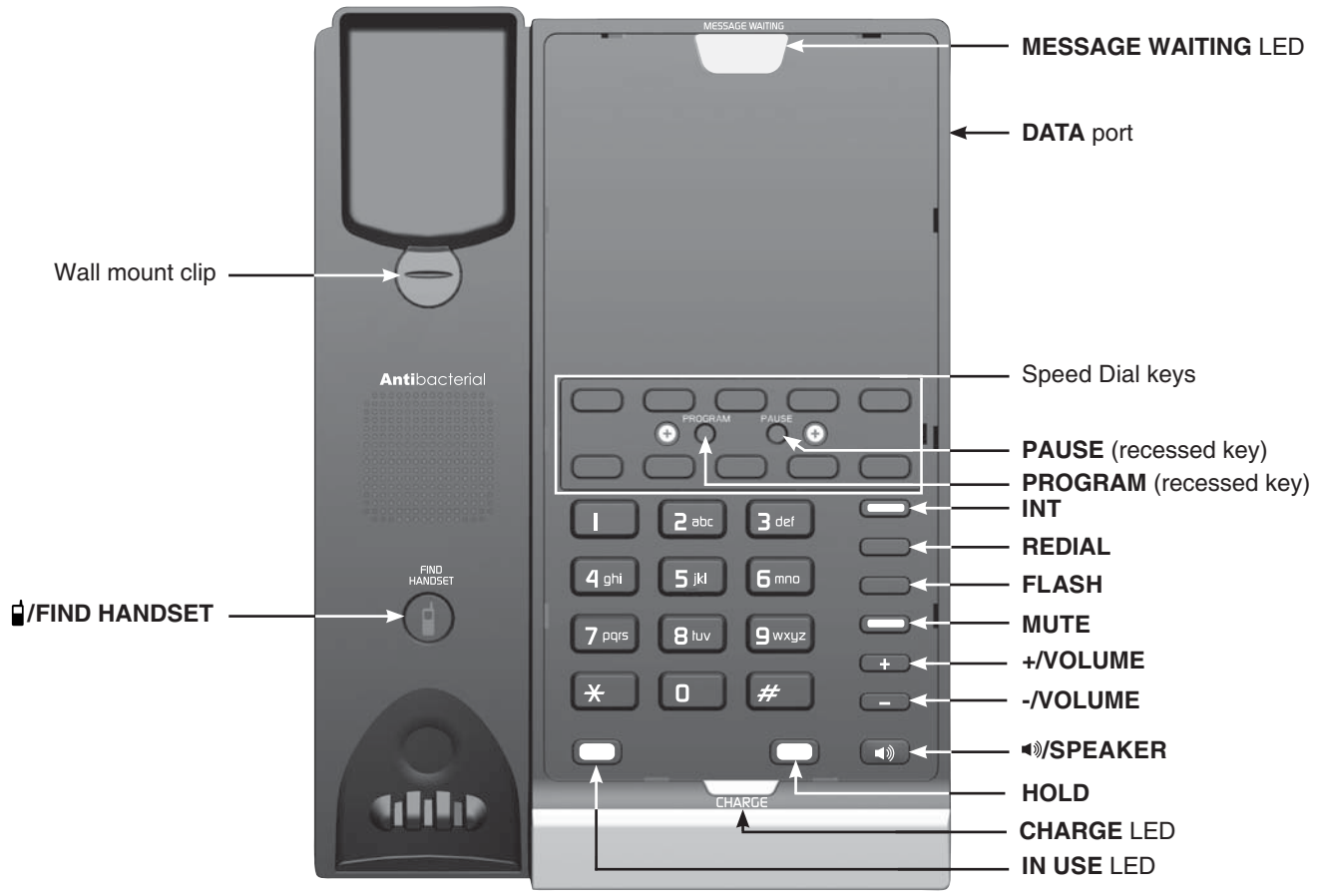

# Telephone layout

## Analog cordless 1-line - CTM-A2411

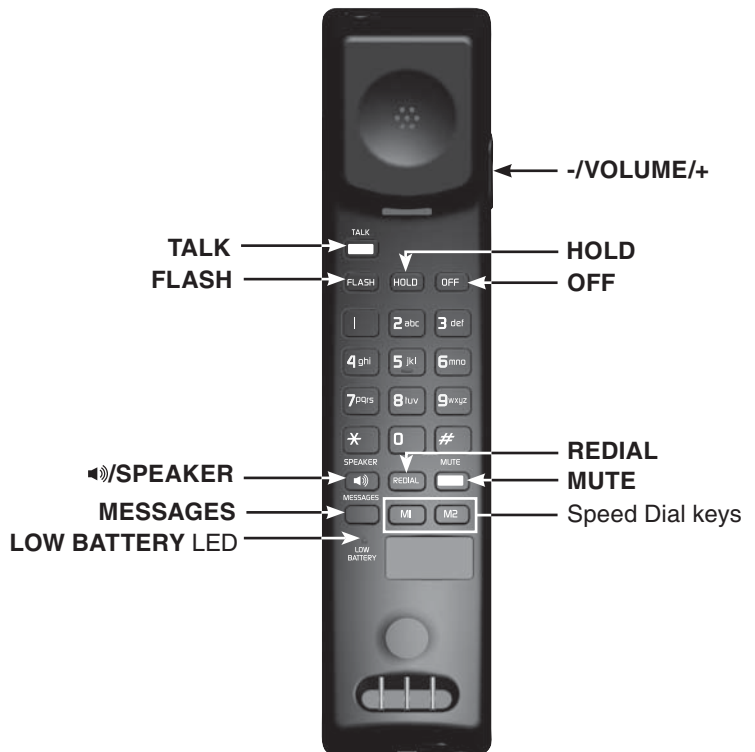
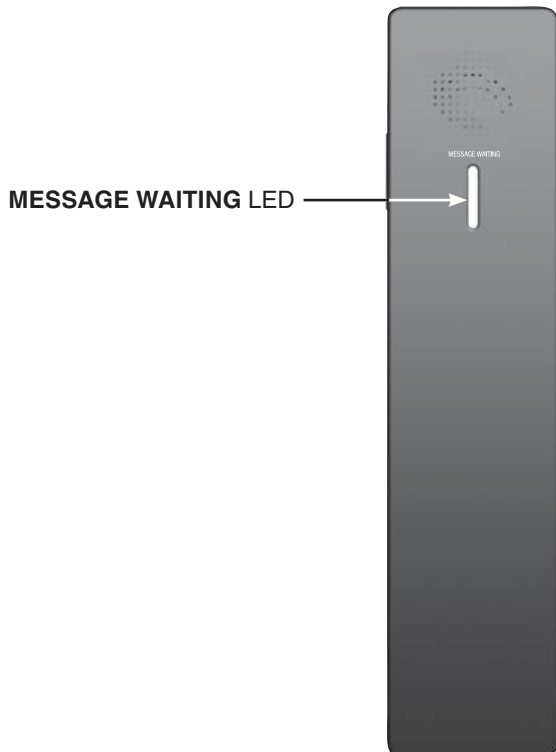

# Telephone layout

## Analog cordless 2-line - A2420

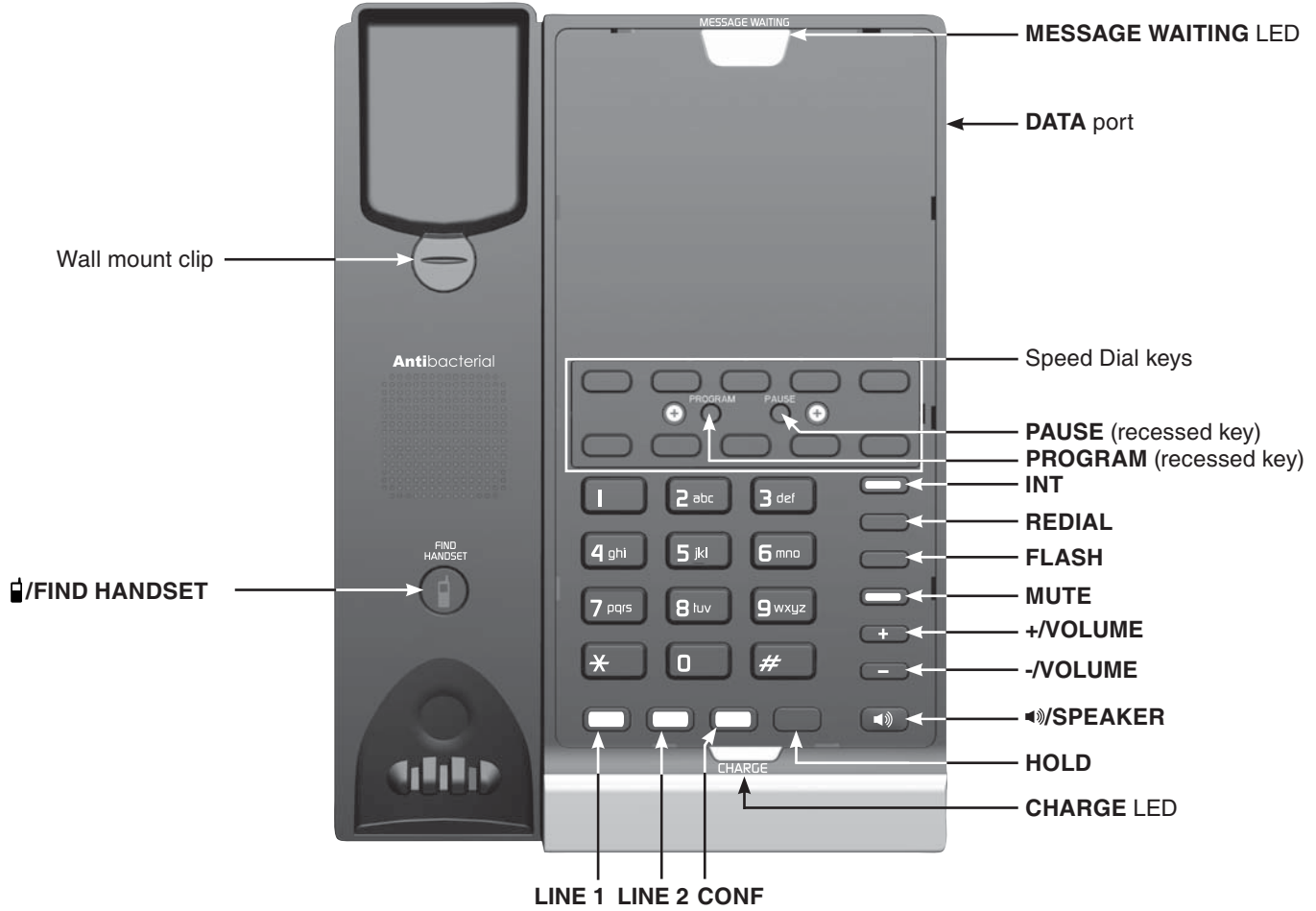

Telephone layout

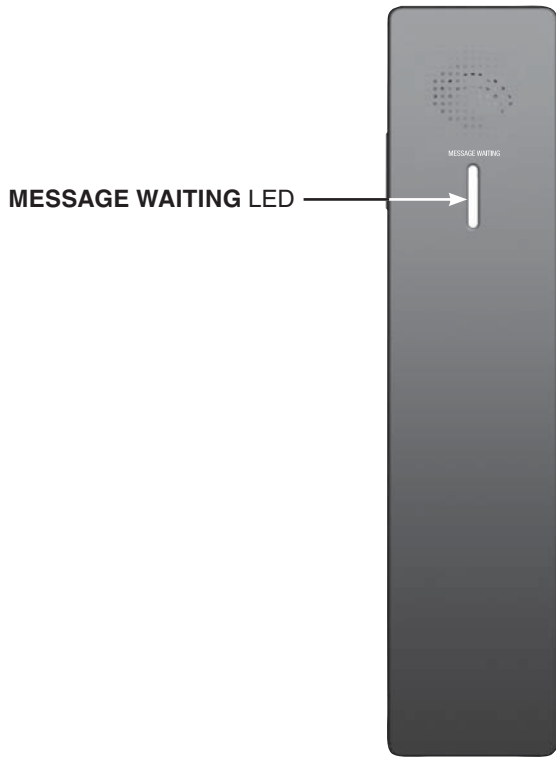

# Telephone layout

## Analog cordless 2-line - CTM-A2421

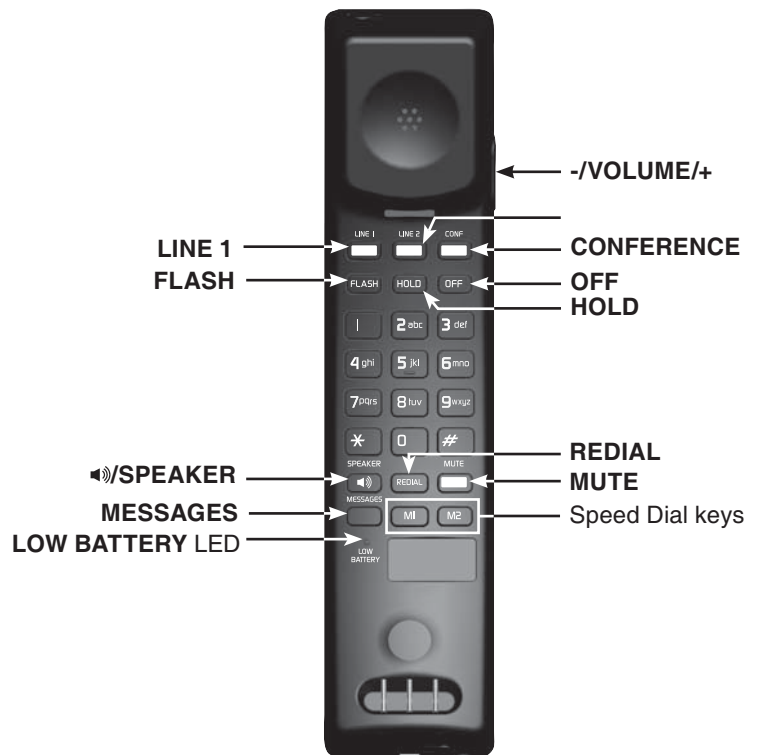
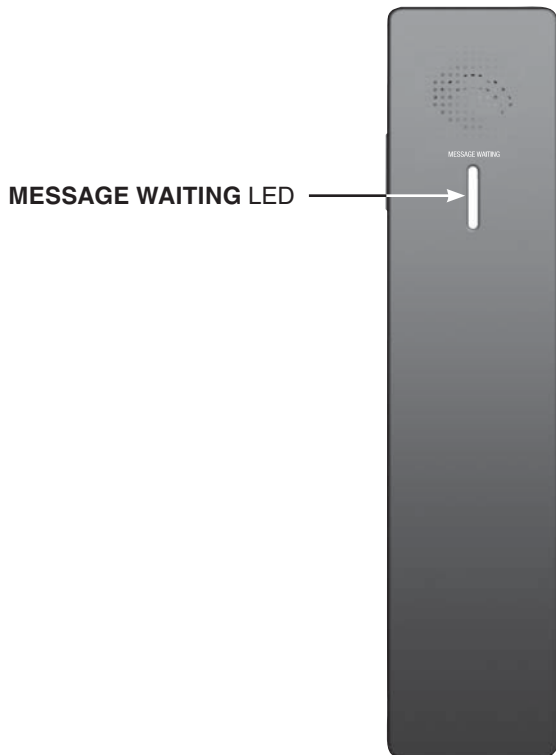
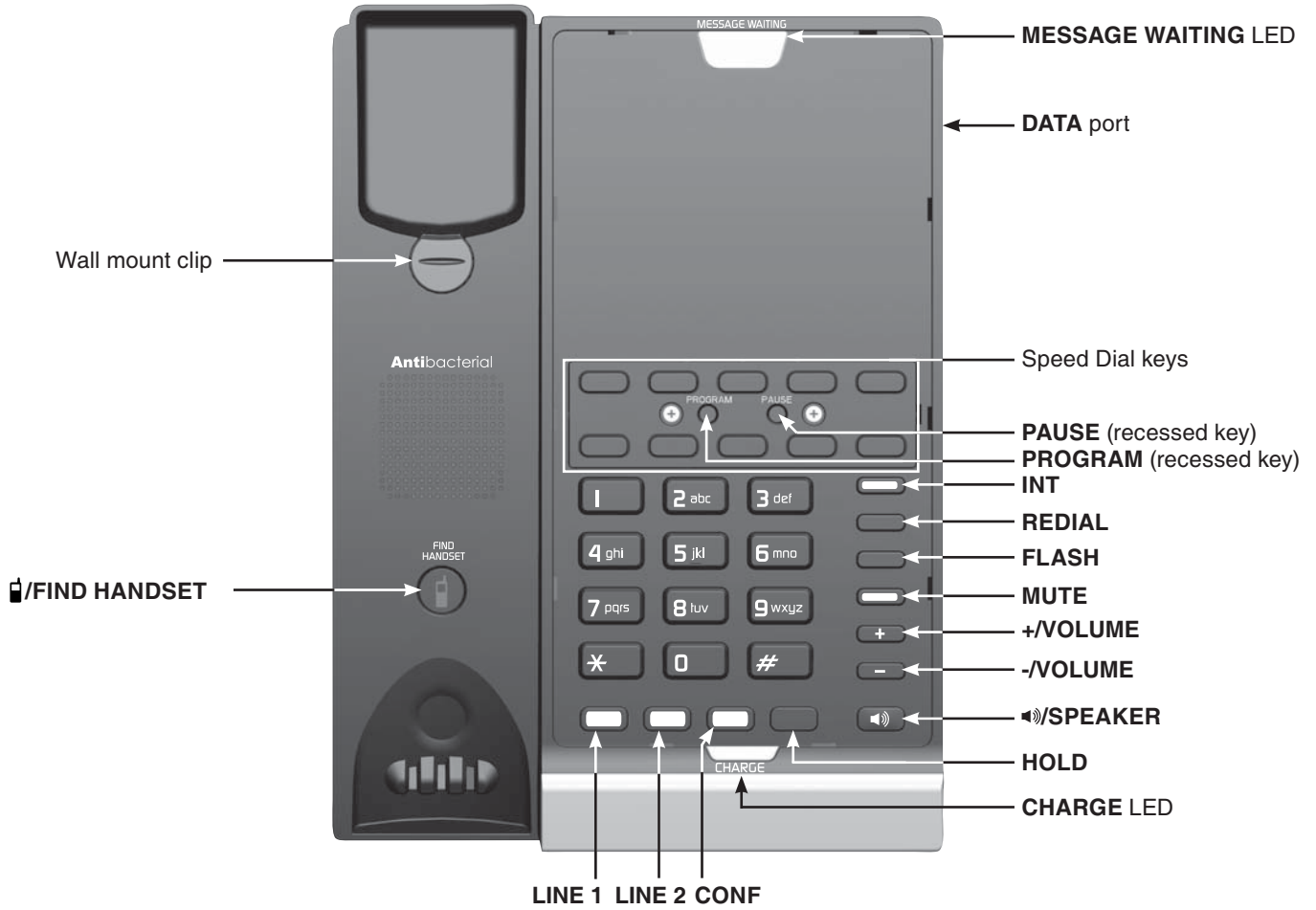

# Telephone layout

## Analog corded/cordless 1-line - CTM-A2510



Telephone layout

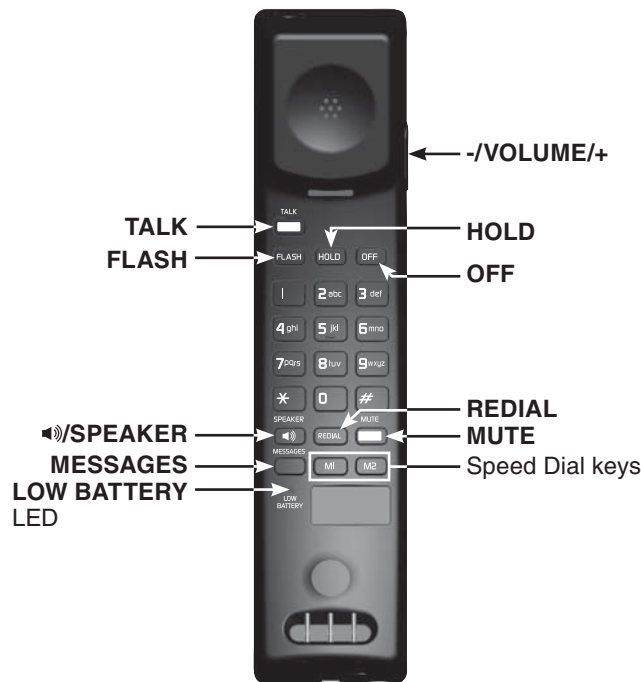

# Telephone layout

## Analog cordless charging base - C4000/C4001

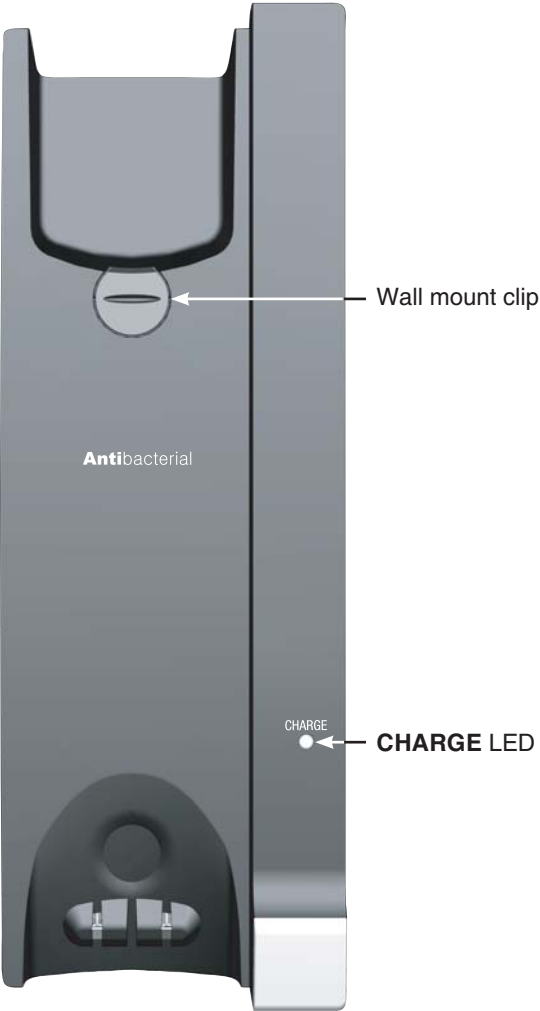



# Telephone layout

## Analog cordless charging stand - C4010/C4011



CHARGE LED

# Telephone layout

## Analog cordless 1-line accessory handset - C4100

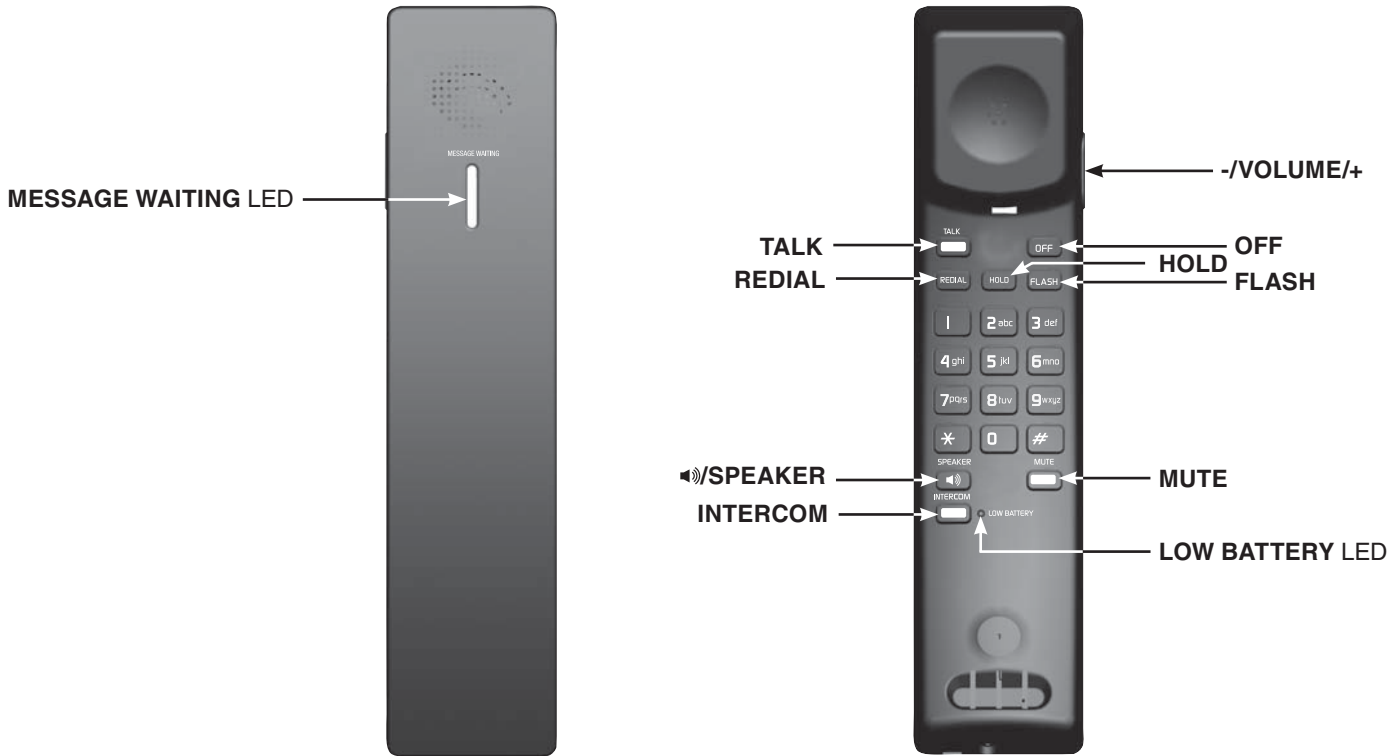

# Telephone layout

## Analog cordless 1-line accessory handset - CTM-C4101

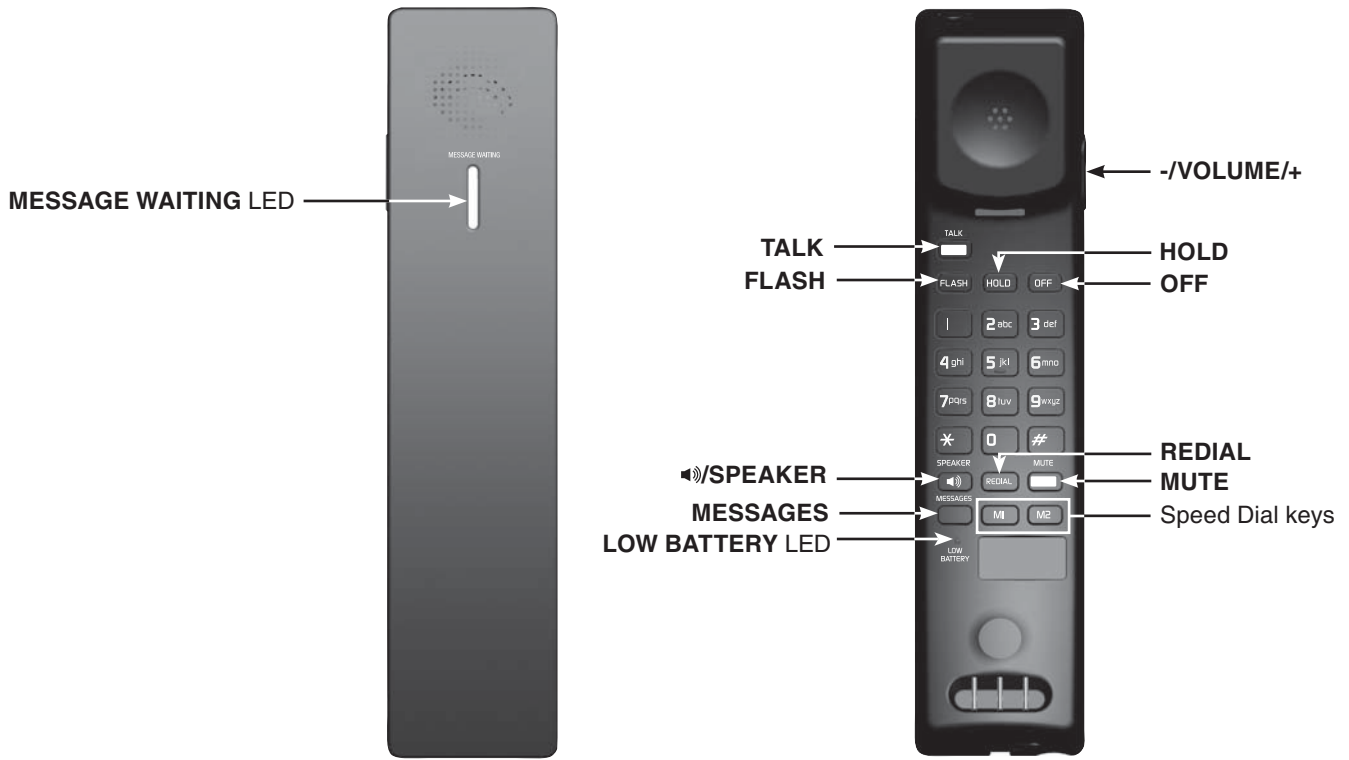

Telephone layout

# Telephone layout

## Analog cordless 2-line accessory handset - C4200

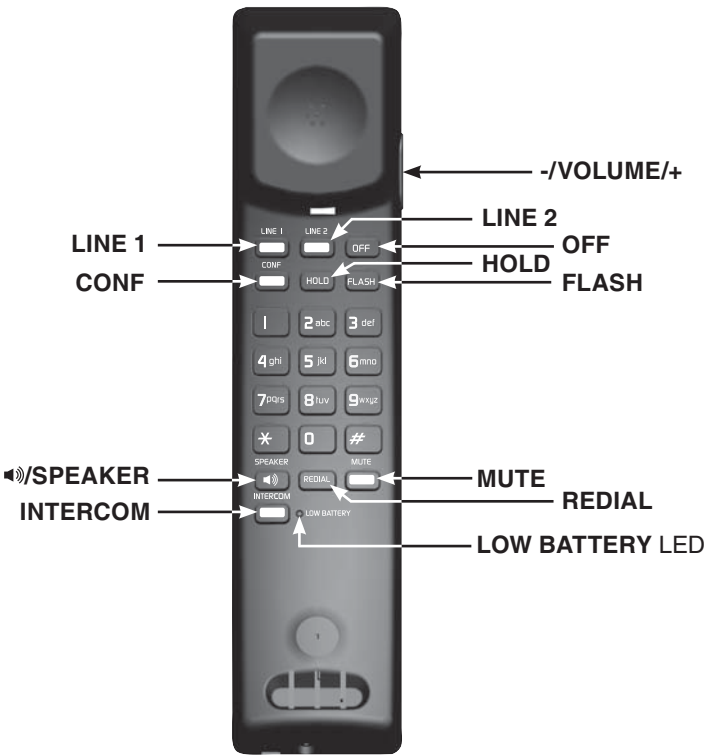
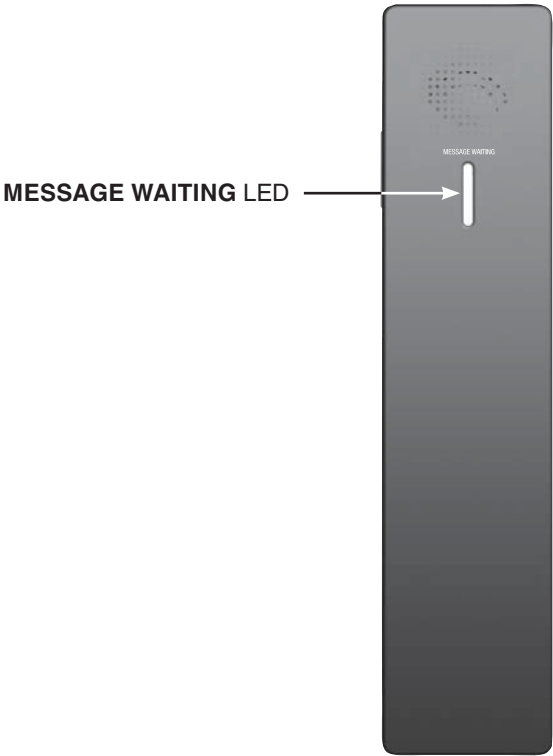

# Telephone layout

## Analog cordless 2-line accessory handset - CTM-C4201

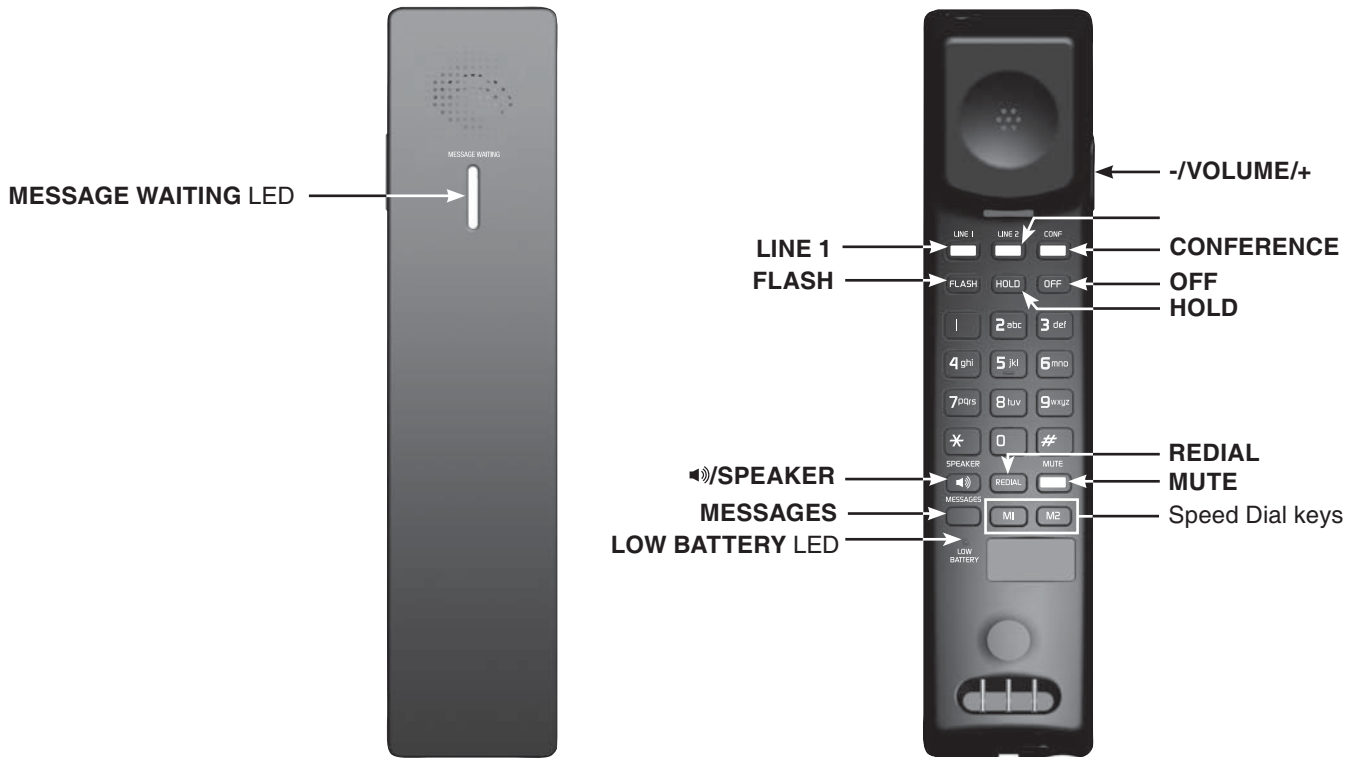

Telephone layout

# Installation

## Analog corded lobby/1-line/2-line - A2100/A2210/A2220

### Telephone base installation

This telephone can be adapted to desktop use or mount on a standard telephone wall plate.

#### Installation option - desktop position

1. Turn the telephone base over with the bottom side facing up. Connect the coiled handset cord to the telephone base.

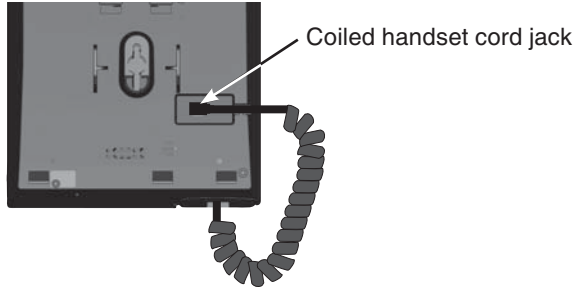

2. Insert the tabs into the grooves to affix the mounting bracket in place.

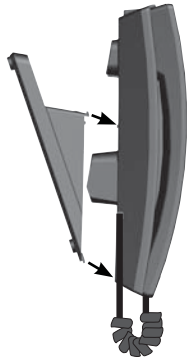

3. Install the telephone base as shown below.

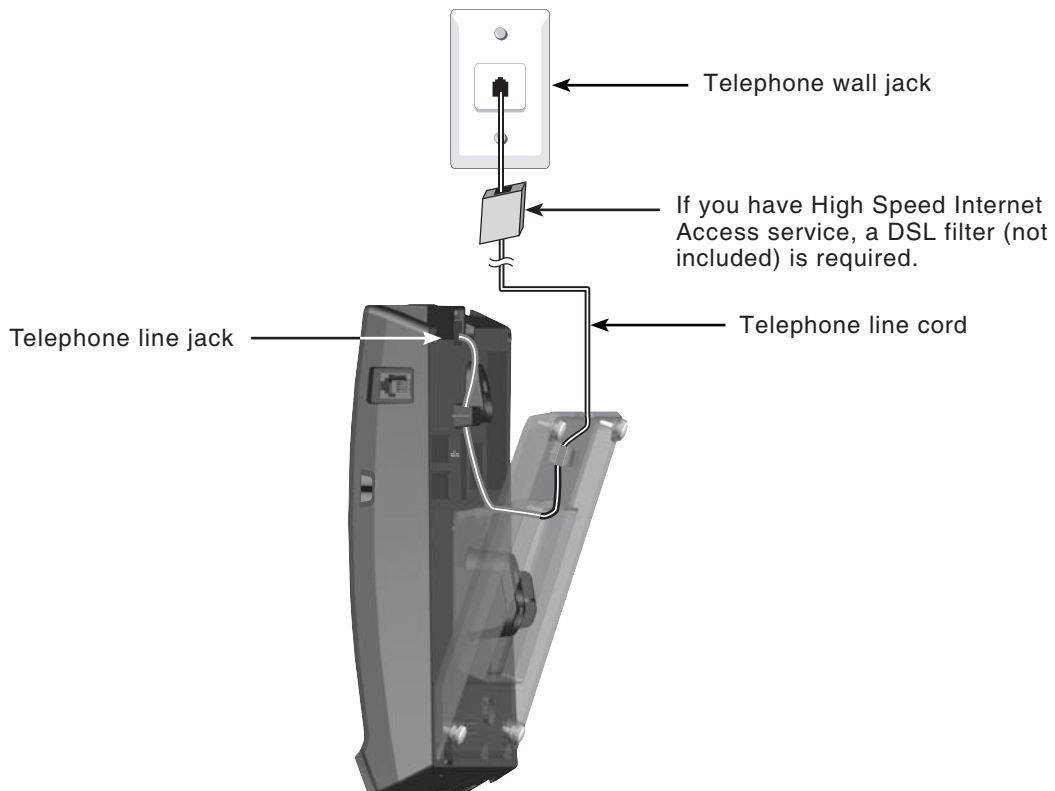

# Installation

## Analog corded lobby/1-line/2-line - A2100/A2210/A2220

### Installation option - converting from desktop to wall mount position

#### To mount the telephone base on the wall:

1. Set aside the handset. On the telephone base cradle, place a coin in the provided slit of the wall mount clip and rotate a half turn (180 degrees). It locks into place with the protruding edge pointing towards the upper edge of the telephone base. This protruding edge holds the handset when the phone is mounted on the wall.

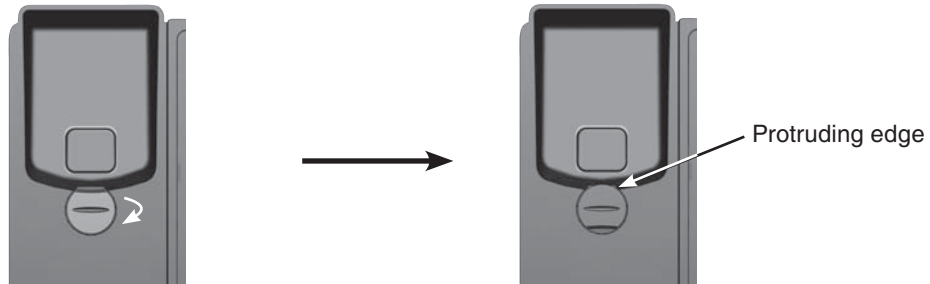

2. Turn the telephone base over with the bottom side facing up. To remove the mounting bracket, firmly push both tabs downward and pull up until both tabs release from the grooves.

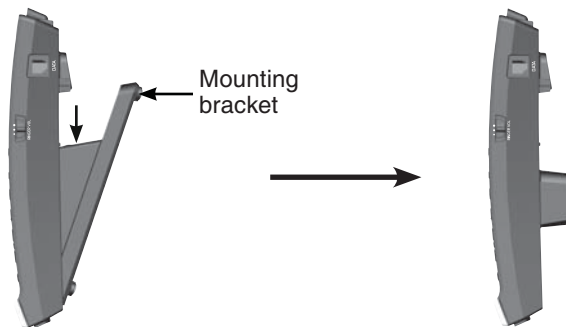

3. Mount the telephone base on the wall by aligning the eyelets with the mounting studs of the wall plate. Then slide the telephone base down on both mounting studs until it locks into place.

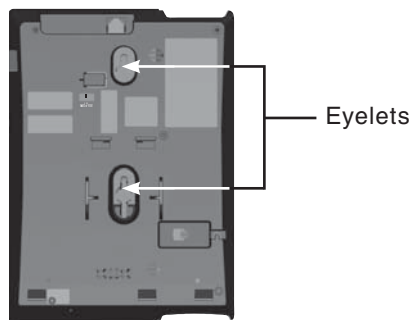

4. Place the handset on the telephone base cradle.

# Installation

## Analog corded trimstyle - A2310

### Telephone base installation

The telephone can be adapted to desktop use or mount on a standard telephone wall plate.

### Installation option - desktop position

1. Turn the telephone base over with the bottom side facing up. Connect the telephone line cord to the telephone base and route along the wire duct.

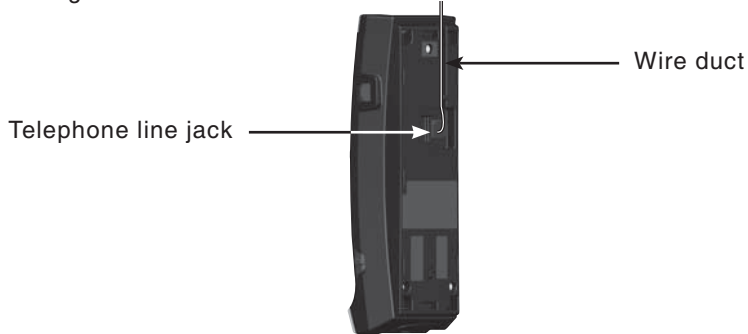

2. Position the mounting bracket as shown. Insert the two small tabs of the mounting bracket into the lower slots on the telephone base. Then press the large tab on the mounting bracket and firmly push it into the upper groove on the telephone base.



3. Install the telephone base as shown below. Then connect the coiled handset cord to the telephone base.





# Installation

## Analog corded trimstyle - A2310

### Installation option - converting from desktop to wall mount position

#### To mount the telephone base on the wall:

1. Set aside the handset. On the telephone base cradle, place a coin in the provided slit of the wall mount clip and rotate a half turn (180 degrees). It locks into place with the protruding edge pointing towards the upper edge of the charging base. This protruding edge holds the cordless handset when the phone is mounted on the wall.

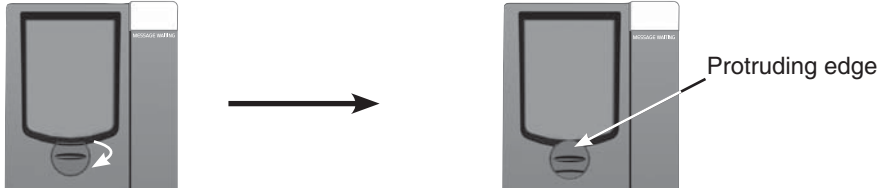

2. Unplug the telephone line cord from the telephone wall jack. Then press the large tab on the mounting bracket to remove it from the upper groove on the telephone base.

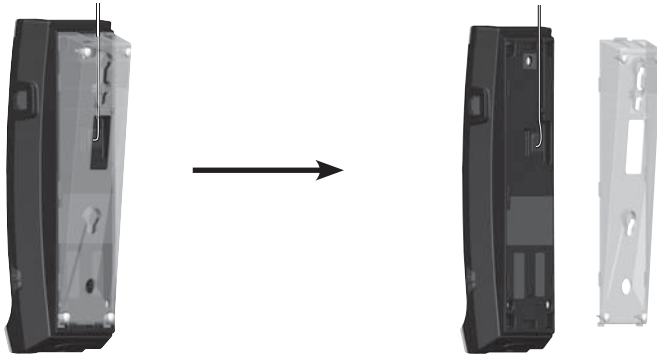

3. Turn the mounting bracket upside down. Remove the telephone line cord from the wire duct and then route it through the rectangular hole on the mounting bracket. Insert the small tabs on the mounting bracket into the upper slots on the telephone base. Then press the large tab on the mounting bracket and firmly push it into the lower groove on the telephone base.

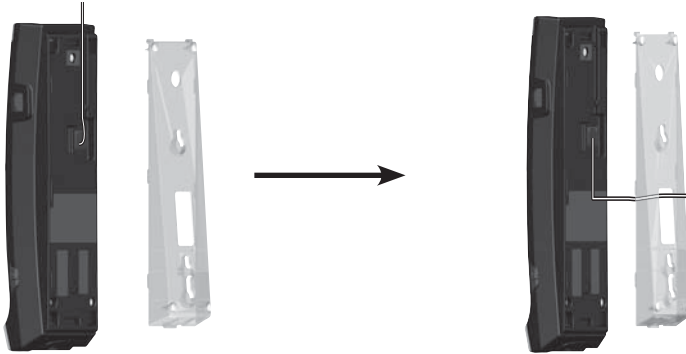

4. Mount the telephone base on the wall by aligning the eyelets with the mounting studs of the wall plate. Then slide the telephone base down on both mounting studs until it locks into place. Place the handset on the telephone base cradle.

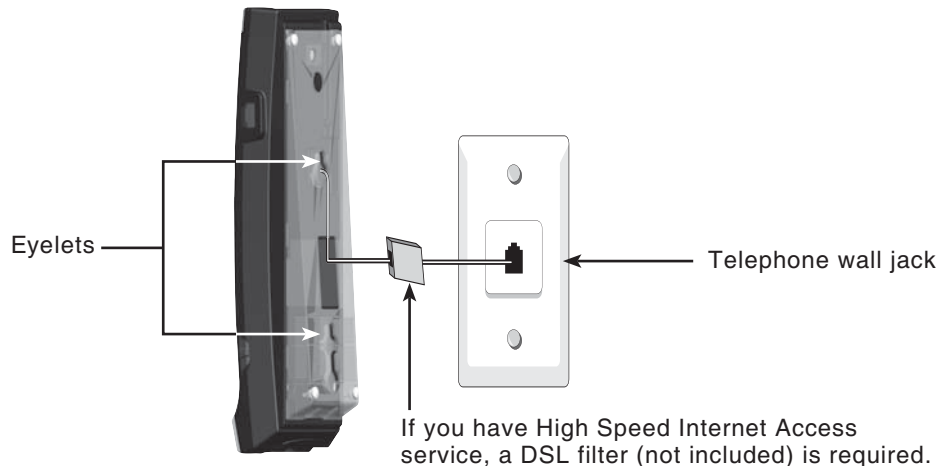

Installation

# Installation

## Analog cordless 1-line/2-line - A2410/CTM-A2411/A2420/CTM-A2421

### Telephone base installation

This telephone can be adapted to desktop use or mount on a standard telephone wall plate.

#### Installation option - desktop position

1. Turn the telephone base over with the bottom side facing up. Insert the tabs into the grooves to affix the mounting bracket in place.



2. Plug the power adapter into an electrical outlet not controlled by a wall switch.

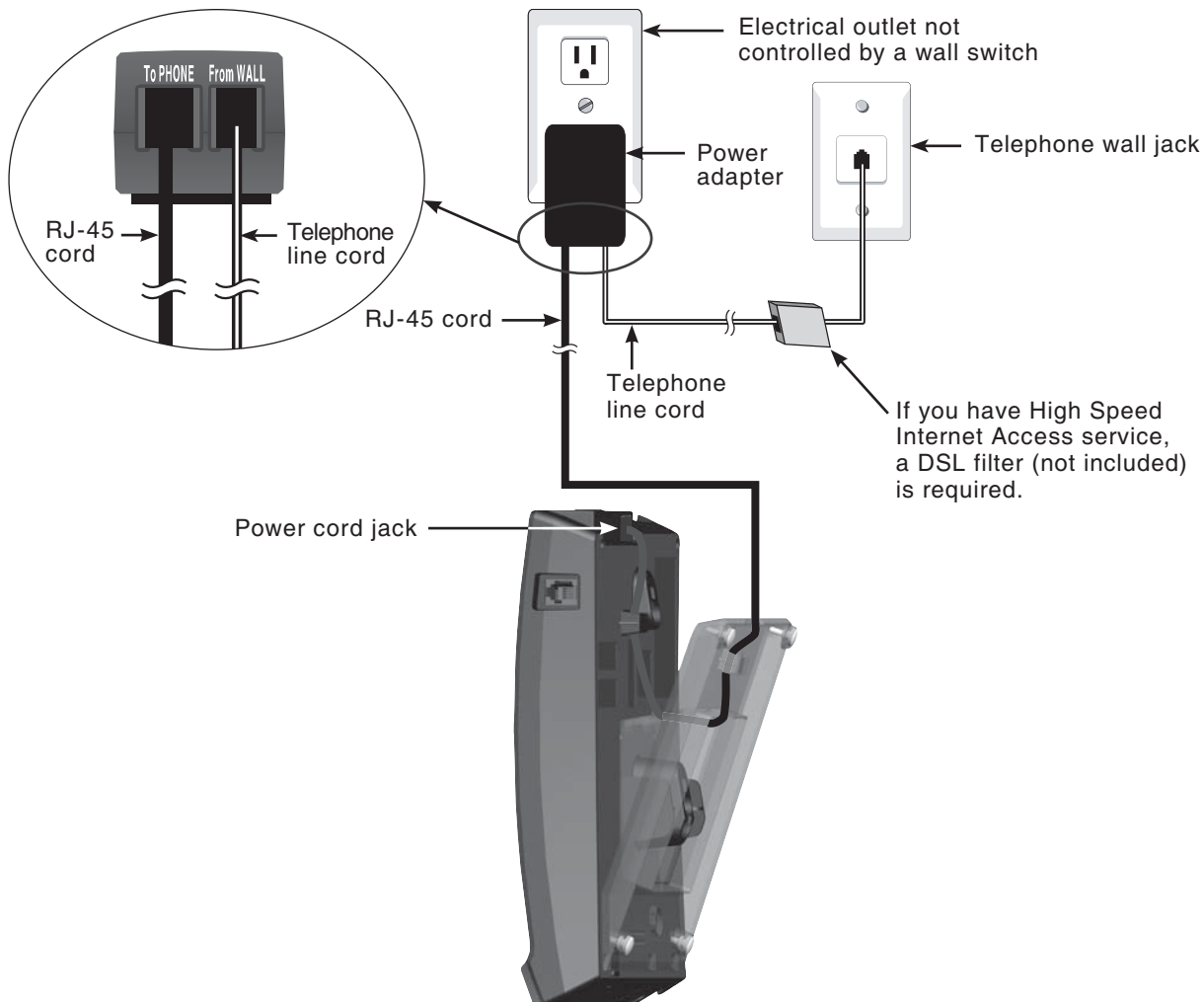

3. When the telephone base has been initially installed, press **⏏/SPEAKER** on the telephone base. Listen for a dial tone and then press **⏏/SPEAKER** again to hang up.

#### CAUTION:

Use only the supplied RJ-45 cord and power adapter. RJ-45 cord is not designed for use in any other IT devices. Misuse of RJ-45 cord on your other IT devices shall be prohibited. To order a replacement, visit our website at [www.vtechhotelphones.com](http://www.vtechhotelphones.com) or call 1-888-907-2007.

# Installation

## Analog cordless 1-line/2-line - A2410/CTM-A2411/A2420/CTM-A2421

### Installation option - converting from desktop to wall mount position

#### To mount the telephone base on the wall:

1. Unplug the power adapter and telephone line cord. Disconnect the power cord from the telephone base.
2. Set aside the handset. On the telephone base cradle, place a coin in the provided slit of the wall mount clip and rotate a half turn (180 degrees). It locks into place with the protruding edge pointing towards the upper edge of the telephone base. This protruding edge holds the handset when the phone is mounted on the wall.

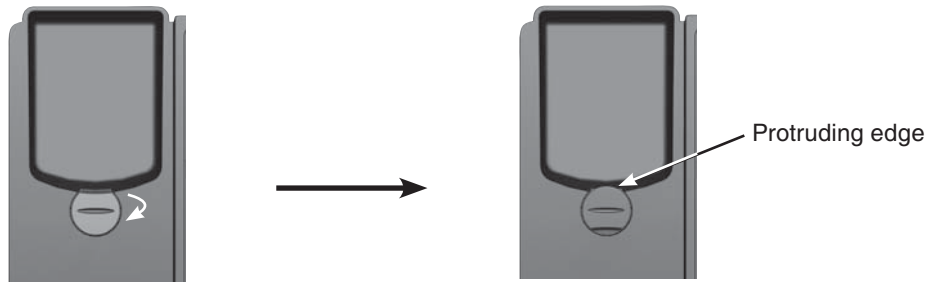

3. Turn the telephone base over with the bottom side facing up. To remove the mounting bracket, firmly push both tabs downward and pull up until both tabs release from the grooves.

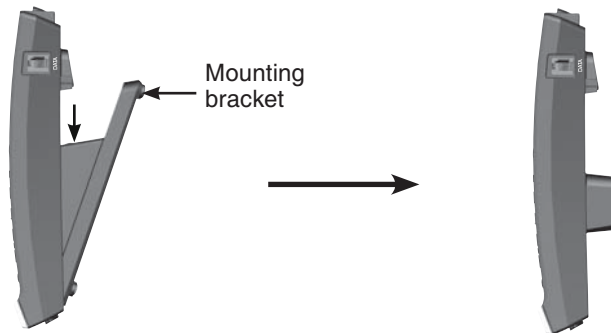

4. Mount the telephone base on the wall by aligning the eyelets with the mounting studs of the wall plate. Then slide the telephone base down on both mounting studs until it locks into place.

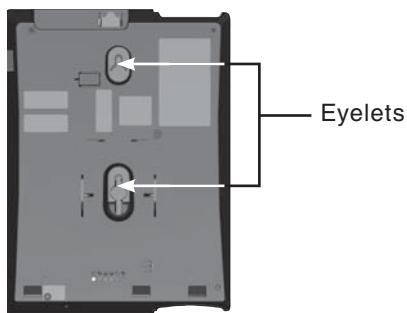

5. Connect the power cord to the telephone base. Plug the power adapter into an electrical outlet not controlled by a wall switch, and plug the telephone line cord into the telephone wall jack. Then place the cordless handset on the telephone base cradle.

# Installation

## Analog cordless 1-line/2-line - A2410/CTM-A2411/A2420/CTM-A2421

### Handset battery installation

Install the battery as shown below.

1. Gently lift the handset cover. Do not detach the speaker wires between the handset cover and the handset.
2. Plug the battery connector securely into the socket inside the handset battery compartment.
3. Place the battery with the label **THIS SIDE UP** facing up and the wires inside the battery compartment.
4. To replace the handset cover, align all the tabs on the handset cover against the corresponding grooves on the handset, then firmly push downward until all the tabs lock in the grooves. Then install the screw at the bottom of the handset.

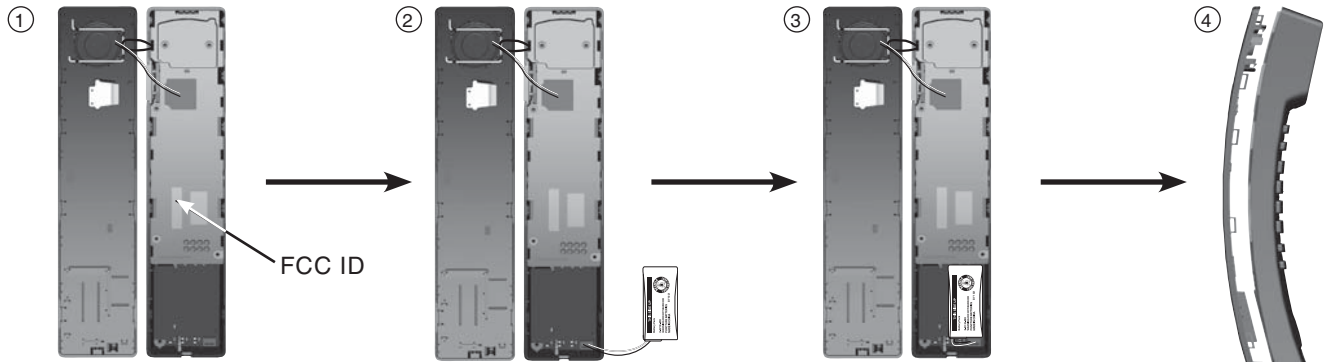

### Replace a handset battery

1. Use a narrow object to open the screw cover and remove the screw. Insert a 5 mm standard screwdriver in the provided slot and then twist and lift to remove the handset cover. Do not detach the speaker wires between the handset cover and the handset.

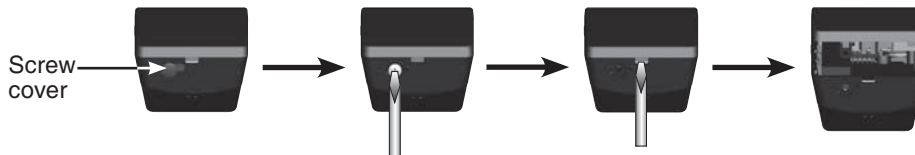

2. Unplug the battery connector from the socket and then remove the battery from the handset battery compartment.
3. Follow Step 2 to Step 4 in **Handset battery installation** above to install a new battery.

### CAUTIONS:

- There may be a risk of explosion if a wrong type of handset battery is used. Use only the supplied rechargeable battery (BT264392/BT266342) or replacement battery (BT266342). To order a replacement, visit our website at [www.vtechhotelphones.com](http://www.vtechhotelphones.com) or call 1-888-907-2007.
- FCC ID is shown on the back of the cordless handset body after the handset cover is removed.
- Dispose of used batteries according to the information in **The RBRC® seal** on page 57.

### Handset registration

Place the cordless handset on the telephone base cradle. Handset registration happens automatically the first time a cordless handset is placed on the telephone base. When the registration process completes, the **MESSAGE WAITING LED** flashes once and you hear 3 rising beeps as confirmation. Each telephone base accommodates up to 4 cordless handsets. When the telephone base has already registered 4 cordless handsets, one of the registered cordless handsets must be deregistered or registered to another telephone base before adding a new cordless handset.

### Handset deregistration

When a registered cordless handset is idle, press **\*331734#** and then press **HOLD**. You hear 3 rising beeps as confirmation when the deregistration process completes.

### Register a handset to another telephone base

Any analog cordless 1-line handset can register to any analog cordless 1-line telephone base. Any analog cordless 2-line handset can register to any analog 2-line telephone base.

When a registered cordless handset is idle, place it on another telephone base. This cordless handset automatically registers to the new telephone base.

### Handset battery charging

The battery must be fully charged before using the cordless handset for the first time. The **CHARGE LED** turns on when the cordless handset is charging on the telephone base, charging base or charging stand. The battery is fully charged after 16 hours of continuous charging. For best performance, keep the cordless handset in the telephone base, charging base or charging stand when not in use.

# Installation

## Analog corded/cordless 1-line - CTM-A2510

### Telephone base installation

This telephone can be adapted to desktop use or mount on a standard telephone wall plate.

### Installation option - desktop position

1. Turn the telephone base over with the bottom side facing up. Connect the coiled handset cord to the telephone base.

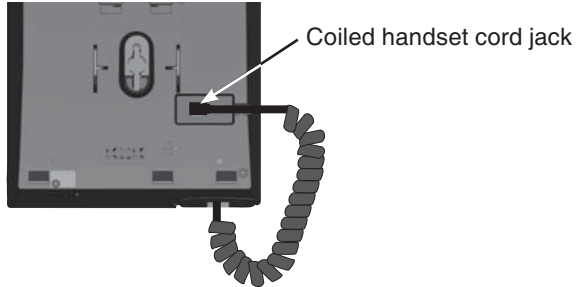

2. Insert the tabs into the grooves to affix the mounting bracket in place.

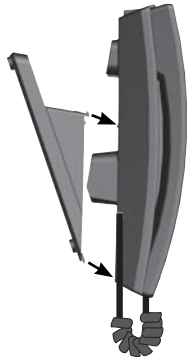

3. Install the telephone base as shown below.

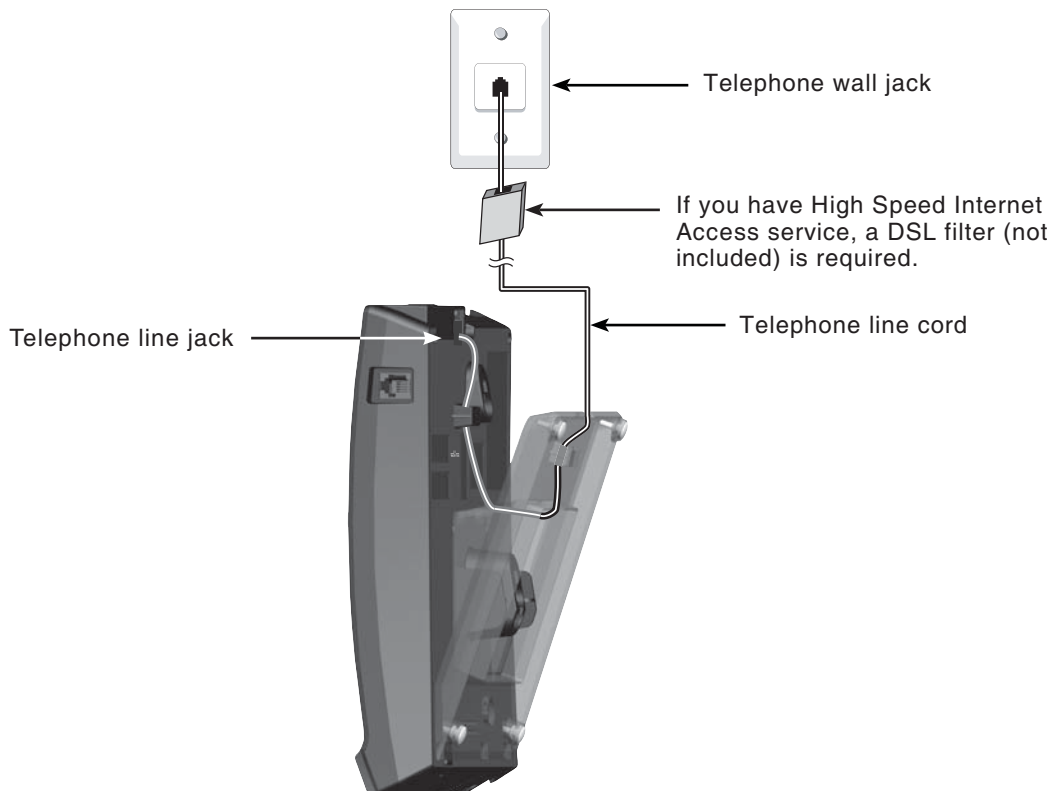

# Installation

## Analog corded/cordless 1-line - CTM-A2510

### Installation option - converting from desktop to wall mount position

#### To mount the telephone base on the wall:

1. Set aside the handset. On the telephone base cradle, place a coin in the provided slit of the wall mount clip and rotate a half turn (180 degrees). It locks into place with the protruding edge pointing towards the upper edge of the telephone base. This protruding edge holds the handset when the phone is mounted on the wall.

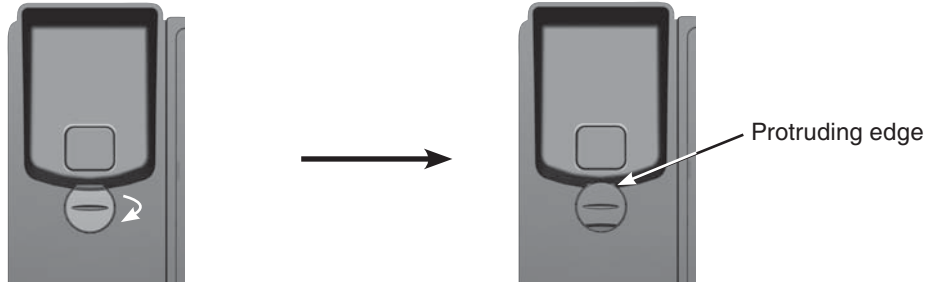

2. Turn the telephone base over with the bottom side facing up. To remove the mounting bracket, firmly push both tabs downward and pull up until both tabs release from the grooves.

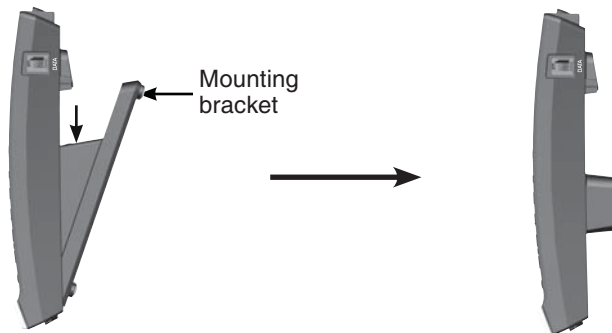

3. Mount the telephone base on the wall by aligning the eyelets with the mounting studs of the wall plate. Then slide the telephone base down on both mounting studs until it locks into place.

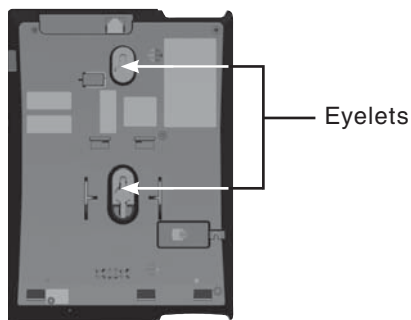

4. Place the handset on the telephone base cradle.

# Installation

## Analog corded/cordless 1-line - CTM-A2510

### Handset battery installation

Install the battery as shown below.

1. Gently lift the handset cover. Do not detach the speaker wires between the handset cover and the handset.
2. Plug the battery connector securely into the socket inside the handset battery compartment.
3. Place the battery with the label **THIS SIDE UP** facing up and the wires inside the battery compartment.
4. To replace the handset cover, align all the tabs on the handset cover against the corresponding grooves on the handset, then firmly push downward until all the tabs lock in the grooves. Then install the screw at the bottom of the handset.

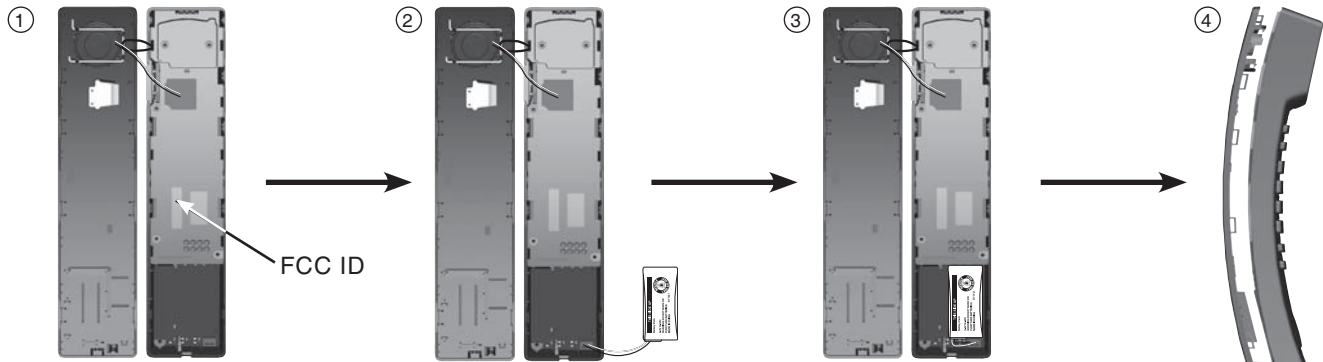

### Replace a handset battery

1. Use a narrow object to open the screw cover and remove the screw. Insert a 5 mm standard screwdriver in the provided slot and then twist and lift to remove the handset cover. Do not detach the speaker wires between the handset cover and the handset.

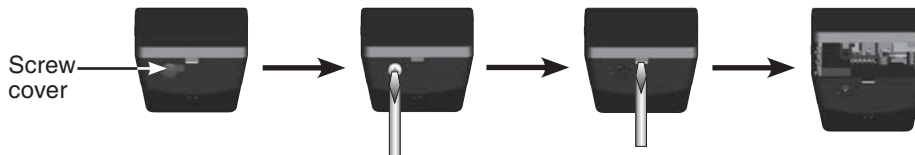

2. Unplug the battery connector from the socket and then remove the battery from the handset battery compartment.
3. Follow Step 2 to Step 4 in **Handset battery installation** above to install a new battery.

### CAUTIONS:

- There may be a risk of explosion if a wrong type of handset battery is used. Use only the supplied rechargeable battery (BT264392/BT266342) or replacement battery (BT266342). To order a replacement, visit our website at [www.vtechhotelphones.com](http://www.vtechhotelphones.com) or call 1-888-907-2007.
- FCC ID is shown on the back of the cordless handset body after the handset cover is removed.
- Dispose of used batteries according to the information in **The RBRC® seal** on page 57.

### Handset registration

When the telephone base is idle, press **\*7247** and then press **HOLD**. The **MESSAGE WAITING** LED turns on for about 90 seconds. Press **\*7247** and then **HOLD** on the cordless handset, the **MESSAGE WAITING** LED on the handset turns on for 90 seconds. When the registration process completes, you hear 3 rising beeps as confirmation. When the telephone base has already registered 4 cordless handsets, one of the registered cordless handsets must be deregistered or registered to another telephone base before adding a new cordless handset.

### Handset deregistration

When a registered cordless handset is idle, press **\*331734#** and then press **HOLD**. You hear 3 rising beeps as confirmation when the deregistration process completes.

### Handset battery charging

The battery must be fully charged before using the cordless handset for the first time. The **CHARGE** LED turns on when the cordless handset is charging on the charging stand. The battery is fully charged after 16 hours of continuous charging. For best performance, keep the cordless handset in the telephone base, charging base or charging stand when not in use.

# Installation

## Analog corded/cordless 1-line - CTM-A2510

### Charging stand installation

The charging stand is designed for desktop use. Install the charging stand as shown below.

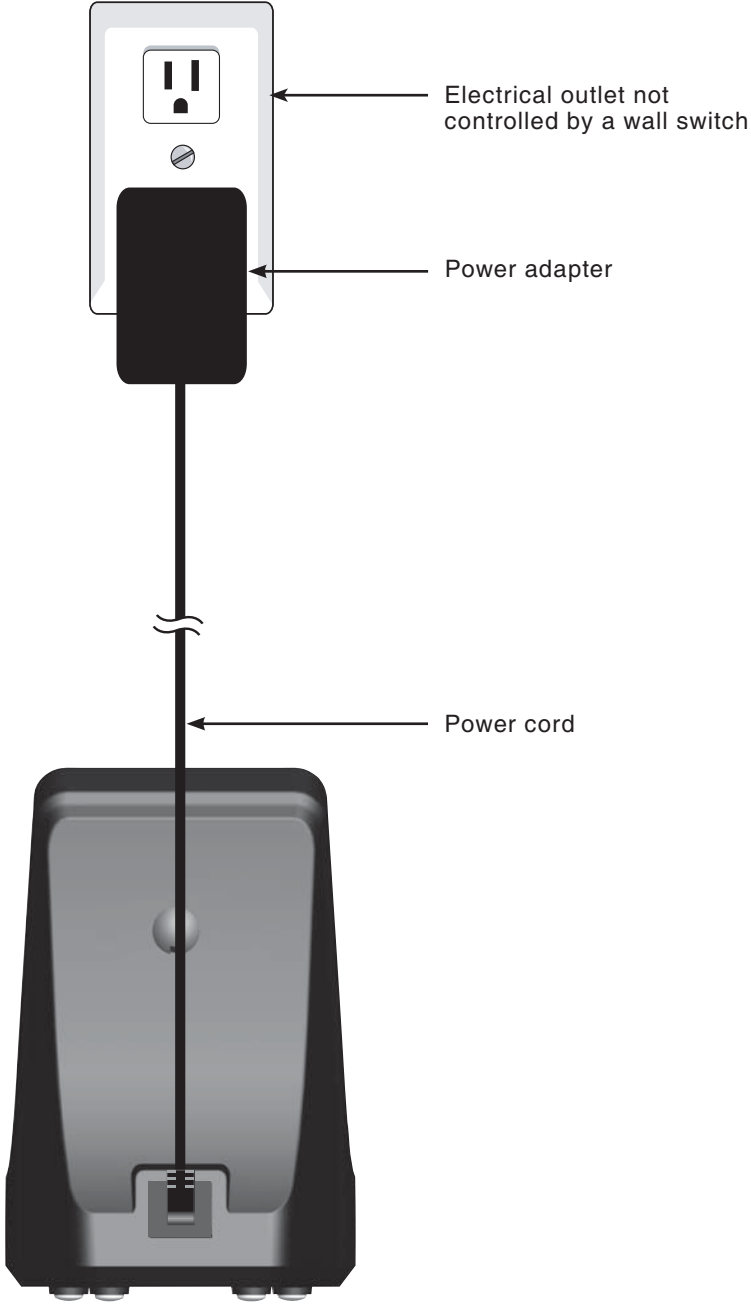



# Installation

## Analog cordless charging base - C4000

### Charging base installation

The charging base can be adapted to desktop use or mount on a standard telephone wall plate.

#### Installation option - desktop position

1. Turn the charging base over with the bottom side facing up. Position the mounting bracket as shown. Connect the power cord to the charging base and route the cord out from the large eyelet on the mounting bracket.

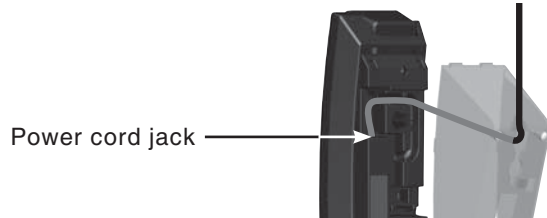

2. Insert the tabs of the mounting bracket as the direction shown below. Then tighten the screw to affix the mounting bracket.

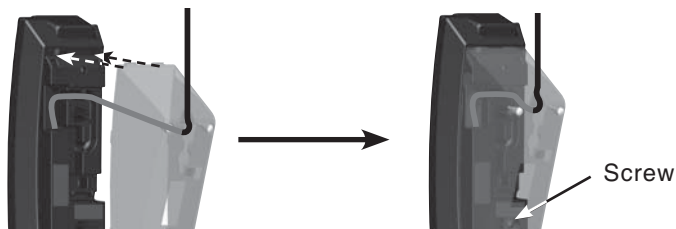

3. Plug the power adapter into an electrical outlet not controlled by a wall switch.

#### Installation option - converting from desktop to wall mount position

1. Unplug the power adapter from the electrical outlet.
2. Set aside the cordless handset. On the telephone base cradle, place a coin in the provided slit of the wall mount clip and rotate a half turn (180 degrees). It locks into place with the protruding edge pointing towards the upper edge of the charging base. This protruding edge holds the cordless handset when the phone is mounted on the wall.

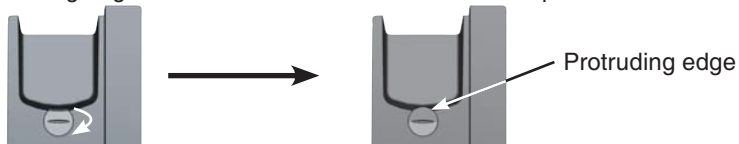

3. Loosen the screw from the mounting bracket and remove the mounting bracket from the grooves.

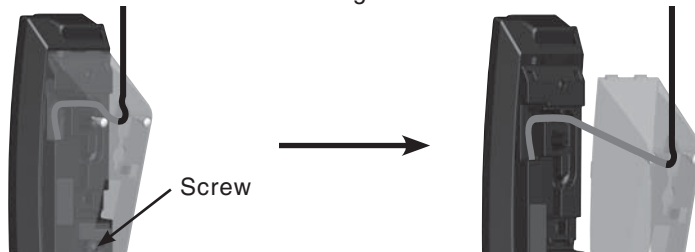

4. Turn the mounting bracket upside down. Insert the tabs of the mounting bracket into the lower grooves on the charging base. Then tighten the screw to affix the mounting bracket.

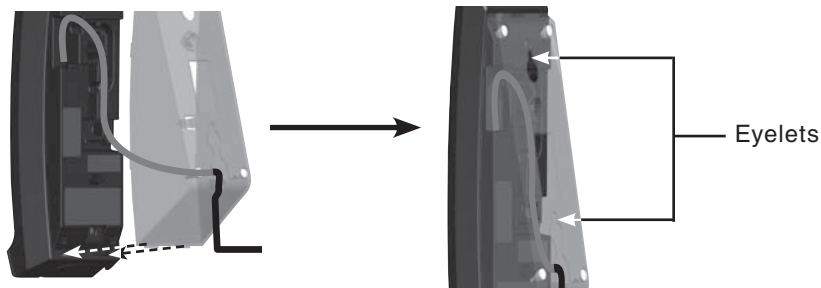

5. Mount the charging base on the wall by aligning the eyelets with the mounting studs of the wall plate. Then slide the charging base down on both mounting studs until it locks into place.
6. Plug the power adapter into an electrical outlet not controlled by a wall switch.

# Installation

## Analog cordless charging base - C4001

### Charging base installation

The charging base can be adapted to desktop use or mount on a standard telephone wall plate.

#### Installation option - desktop position

1. Turn the charging base over with the bottom side facing up. Position the mounting bracket as shown. Connect the power cord to the charging base and route the cord out from the large eyelet on the mounting bracket.

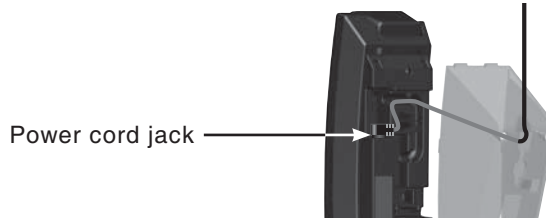

2. Insert the tabs of the mounting bracket as the direction shown below. Then tighten the screw to affix the mounting bracket.

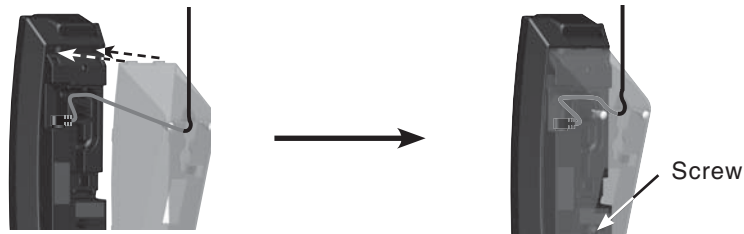

3. Plug the power adapter into an electrical outlet not controlled by a wall switch.

#### Installation option - converting from desktop to wall mount position

1. Unplug the power adapter from the electrical outlet.
2. Remove the cordless handset from the charging base if necessary. On the charging base cradle, place a coin in the slit of the wall mount clip and rotate a half turn (180 degrees). It locks into place with the protruding edge pointing towards the upper edge of the charging base. This protruding edge holds the cordless handset when the phone is mounted on the wall.

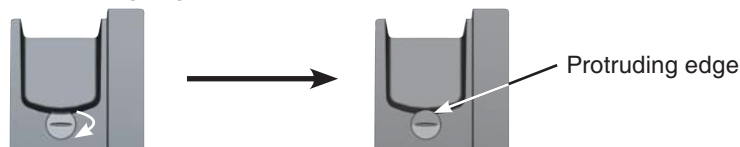

3. Loosen the screw from the mounting bracket and remove the mounting bracket from the grooves.

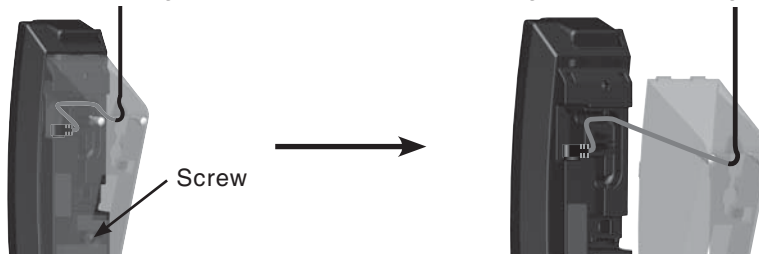

4. Rotate the mounting bracket. Insert the tabs of the mounting bracket into the lower grooves on the charging base. Then tighten the screw to affix the mounting bracket.

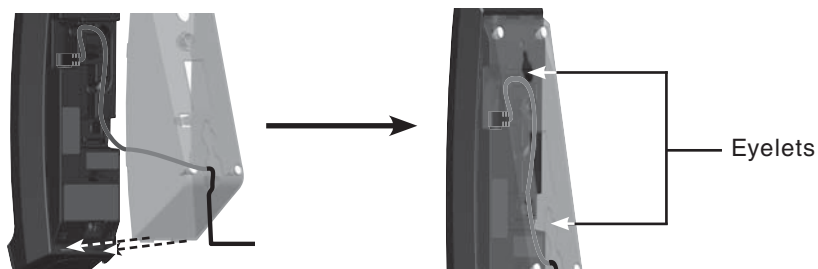

5. Mount the charging base on the wall by aligning the eyelets with the mounting studs of the wall plate. Then slide the charging base down on both mounting studs until it locks into place.
6. Plug the power adapter into an electrical outlet not controlled by a wall switch.

# Installation

## Analog cordless charging stand - C4010

### Charging stand installation

The charging stand is designed for desktop use. Install the charging stand as shown below.

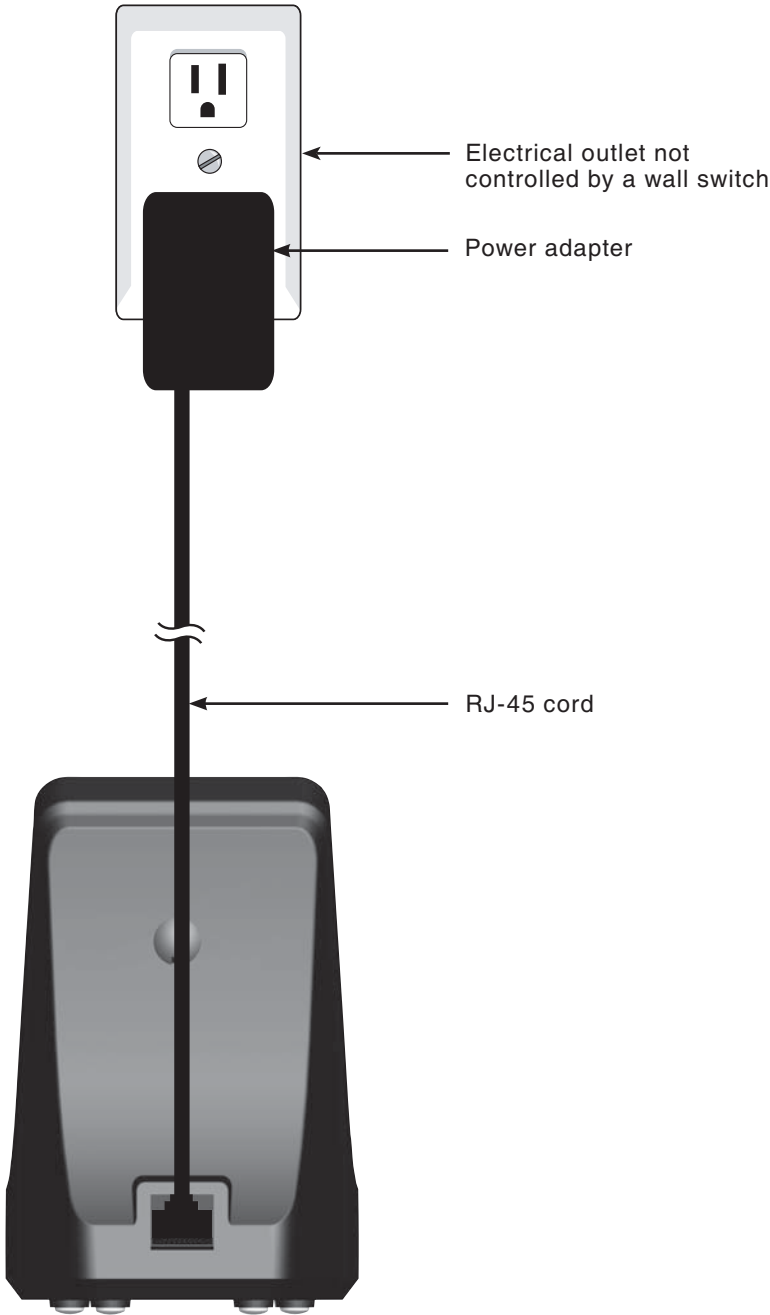

# Installation

## Analog cordless charging stand - C4011

### Charging stand installation

The charging stand is designed for desktop use. Install the charging stand as shown below.

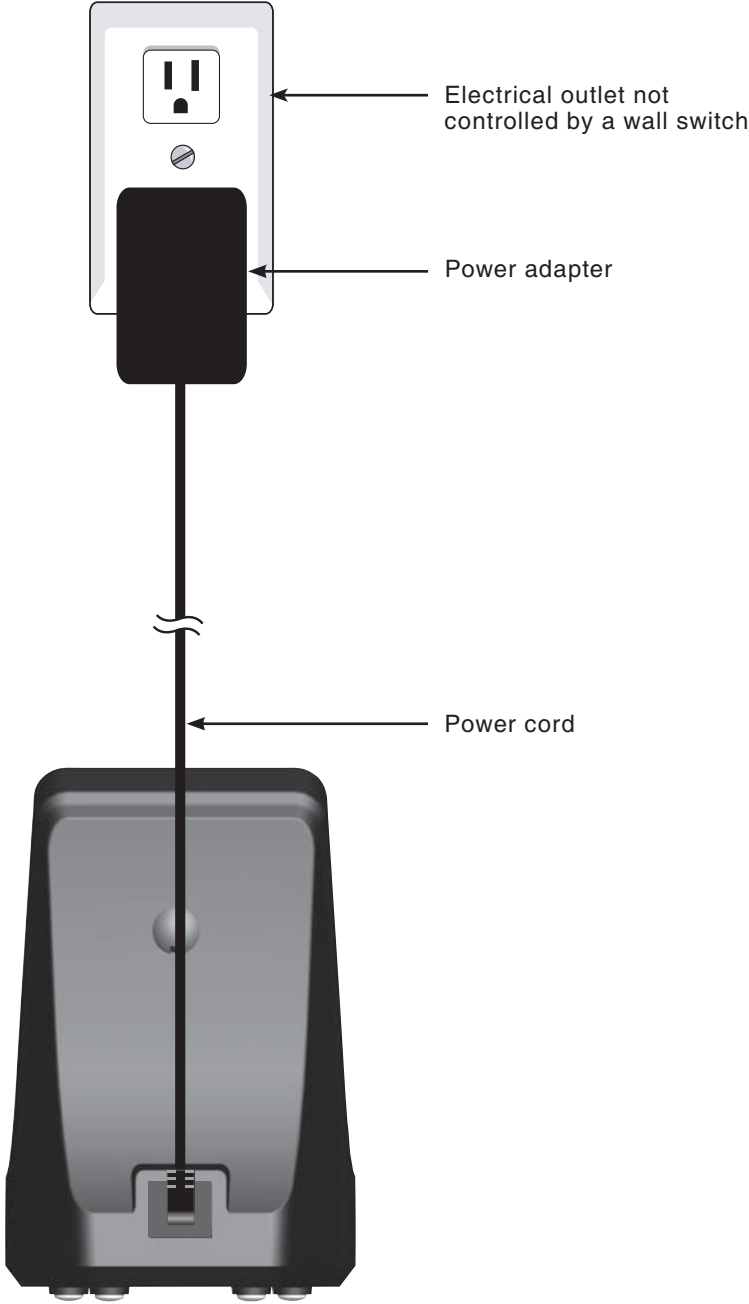

# Installation

## Analog cordless 1-line/2-line accessory handset - C4100/CTM-C4101/C4200/CTM-C4201

### Handset battery installation

Install the battery as shown below.

1. Gently lift the handset cover. Do not detach the speaker wires between the handset cover and the handset.
2. Plug the battery connector securely into the socket inside the handset battery compartment.
3. Place the battery with the label **THIS SIDE UP** facing up and the wires inside the battery compartment.
4. To replace the handset cover, align all the tabs on the handset cover against the corresponding grooves on the handset, then firmly push downward until all the tabs lock in the grooves. Then install the screw at the bottom of the handset.

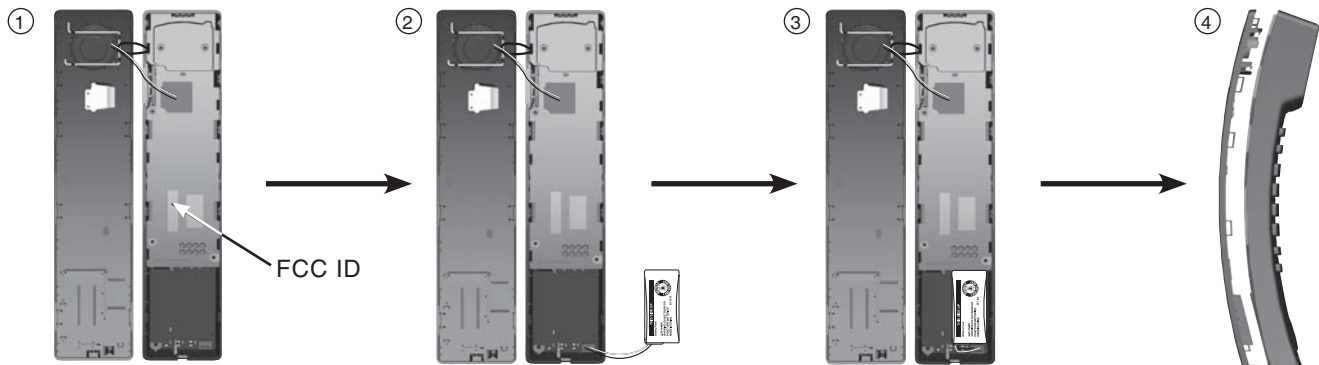

### Replace a handset battery

1. Use a narrow object to open the screw cover and remove the screw. Insert a 5 mm standard screwdriver in the provided slot and then twist and lift to remove the handset cover.

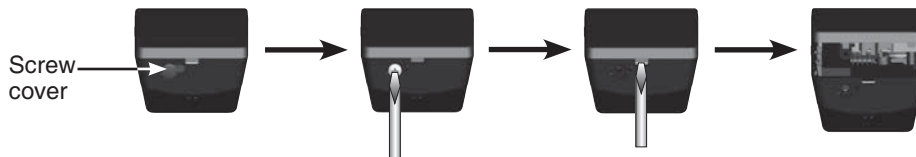

2. Unplug the battery connector from the socket and then remove the battery from the handset battery compartment.
3. Follow Step 2 to Step 4 in **Handset battery installation** above to install a new battery.

### CAUTIONS:

- There may be a risk of explosion if a wrong type of handset battery is used. Use only the supplied rechargeable battery (BT264392/BT266342) or replacement battery (BT266342). To order a replacement, visit our website at [www.vtechhotelphones.com](http://www.vtechhotelphones.com) or call 1-888-907-2007.
- FCC ID is shown on the back of the cordless handset body after the handset cover is removed.
- Dispose of used batteries according to the information in **The RBRC® seal** on page 57.

### Handset registration

Place the cordless handset on the telephone base cradle. Handset registration happens automatically the first time a cordless handset is placed on the telephone base. When the registration process completes, the **MESSAGE WAITING LED** flashes once and you hear 3 rising beeps as confirmation. Each telephone base accommodates up to 4 cordless handsets. When the telephone base has already registered 4 cordless handsets, one of the registered cordless handsets must be deregistered or registered to another telephone base before adding a new cordless handset.

### Handset deregistration

When a registered cordless handset is idle, press **\*331734#** and then press **HOLD**. You hear 3 rising beeps as confirmation when the deregistration process completes.

### Register a handset to another telephone base

Any analog cordless 1-line handset can register to any analog cordless 1-line telephone base. Any analog cordless 2-line handset can register to any analog 2-line telephone base.

When a registered cordless handset is idle, place it on another telephone base. This cordless handset automatically registers to the new telephone base.

### Handset battery charging

The battery must be fully charged before using the cordless handset for the first time. The **CHARGE LED** turns on when the cordless handset is charging on the telephone base, charging base or charging stand. The battery is fully charged after 16 hours of continuous charging. For best performance, keep the cordless handset in the telephone base, charging base or charging stand when not in use.

# Telephone settings

## Analog corded lobby/1-line/2-line/trimstyle - A2100/A2210/A2220/A2310

Default settings are indicated by asterisks (\*).

Setting	Options	Adjustable by:
<b>Handset earpiece volume</b> (for models <b>A2210</b> and <b>A2220</b> only)	1, 2*, 3, 4	<b>User and administrator</b>
<b>Handset earpiece volume</b> (for model <b>A2310</b> only)	1, 2, 3*, 4, 5	<b>User and administrator</b>
<b>Speakerphone volume</b> (for models <b>A2210</b> and <b>A2220</b> only)	1, 2, 3, 4, 5*, 6, 7, 8	<b>User and administrator</b>
<b>Ringer volume</b>	Low, Medium*, High	<b>User and administrator</b>
<b>Ringer tone</b>	Tone 1*, Tone 2, Tone 3	<b>Administrator only</b>
<b>Flash</b> (for models <b>A2210</b> and <b>A2220</b> only)	1 (100ms), 2 (300ms), 3* (600ms)	<b>Administrator only</b>
<b>Voicemail voltage detection</b> (for models <b>A2210</b> , <b>A2220</b> and <b>A2310</b> only)	Disable voicemail voltage detection, Periodic low voltage pulse detection method, Steady high voltage and periodic high voltage pulse detection method	<b>Administrator only</b>

### Ringer tone

There are 3 ringer tone options. For 2-line model (**A2220**), changing the ringer tone of either **LINE 1** or **LINE 2** applies to both phone lines.

#### To change the ringer tone:

- Turn the telephone base over with the bottom side facing up.
  - For lobby (**A2100**), 1-line (**A2210**) and 2-line (**A2220**) models, remove the mounting bracket if it is in desktop position. To remove the mounting bracket, firmly push both tabs downward and pull up until they release from the grooves.
  - For trimstyle model (**A2310**), remove the mounting bracket. To remove the mounting bracket, firmly press down the tab on it and pull out to detach it from the telephone base.

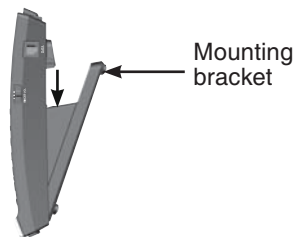

(For **A2100**, **A2210** or **A2220** models)



(For **A2310** model)

- Slide the ringer tone switch to select the desired detented position using a narrow object such as a standard screwdriver.

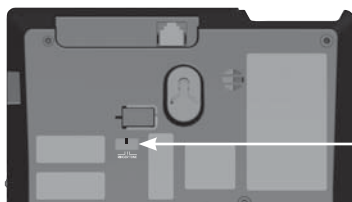

(For **A2100**, **A2210** or **A2220** models)

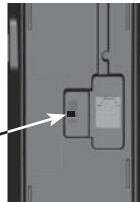

(For **A2310** model)

- Install the mounting bracket accordingly.

### Flash

For 1-line and 2-line models (**A2210** and **A2220**), there are 3 flash duration options that can be programmed.

#### To change the flash duration:

- Remove the faceplate and overlay if they are on the telephone base. Press **☎/SPEAKER** on the telephone base or lift the handset. Then press the recessed **PROGRAM** key. The **MUTE** key flashes when in administrator mode.
- Press **FLASH** and you hear 3 beeps. Then press a dialing key, **1** (100ms), **2** (300ms) or **3** (600ms), to select the desired flash duration. Press the recessed **PROGRAM** key again. You hear 3 rising beeps as confirmation.

# Telephone settings

## Analog corded lobby/1-line/2-line/trimstyle - A2100/A2210/A2220/A2310

### Voicemail voltage detection

For 1-line and 2-line models (**A2210** and **A2220**), there are 3 options to set the voicemail voltage detection on the telephone base.

#### To disable the voicemail voltage detection:

1. Remove the faceplate and overlay if they are on the telephone base. Then remove the sticker on the telephone base.
2. Use a narrow object to unplug all the jumpers from the telephone base.
3. Place the sticker back in place.

#### To set the voicemail voltage detection by the periodic low voltage pulse detection method:

1. Remove the faceplate and overlay if they are on the telephone base. Then remove the sticker on the telephone base.
2. Use a narrow object to unplug all the jumpers from the telephone base. Then plug the jumpers into ①, ② and ③.
3. Place the sticker back in place.

#### To set the voicemail voltage detection by the steady high voltage and periodic high voltage pulse detection method:

1. Remove the faceplate and overlay if they are on the telephone base. Then remove the sticker on the telephone base.
2. Use a narrow object to unplug all the jumpers from the telephone base. Then plug the jumpers into ①, ② and ④.
3. Place the sticker back in place.

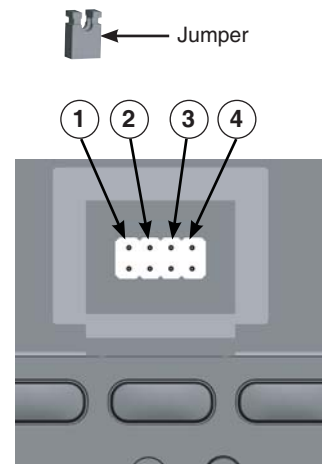

For trimstyle model (**A2310**), there are 3 options to set the voicemail voltage detection on the telephone base.

#### To disable the voicemail voltage detection:

1. Remove the sticker at the bottom of the telephone base.
2. Use a narrow object to unplug all the jumpers from the telephone base.
3. Place the sticker back in place.

#### To set the voicemail voltage detection by the periodic low voltage pulse detection method:

1. Remove the sticker at the bottom of the telephone base.
2. Use a narrow object to unplug all the jumpers from the telephone base. Then plug the jumpers into ①, ② and ③.
3. Place the sticker back in place.

#### To set the voicemail voltage detection by the steady high voltage and periodic high voltage pulse detection method:

1. Remove the sticker at the bottom of the telephone base.
2. Use a narrow object to unplug all the jumpers from the telephone base. Then plug the jumpers into ①, ② and ④.
3. Place the sticker back in place.

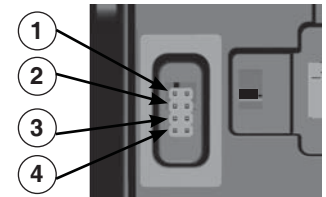

### Speed Dial keys

For 1-line and 2-line models (**A2210** and **A2220**), there are up to 10 programmable guest-service (Speed Dial) keys. Program these keys to automatically dial telephone numbers or to activate telephone system features.

#### To program a Speed Dial key:

1. Remove the faceplate and overlay if they are on the telephone base. Press **Ⓜ/SPEAKER** on the telephone base or lift the handset. Then press the recessed **PROGRAM** key. The **MUTE** key flashes when in administrator mode.
2. Press the desired Speed Dial key where the telephone number is to be stored. You hear 3 beeps.
3. Enter the telephone number (up to 16 digits).
  - To insert a pause in the stored number, press the recessed **PAUSE** key.
4. The telephone stores the number automatically when 16 digits are entered. When the number has less than 16 digits, press the recessed **PROGRAM** key again. You hear 3 rising beeps as confirmation.

#### To clear the programmed Speed Dial key:

1. Remove the faceplate and overlay if they are on the telephone base. Press **Ⓜ/SPEAKER** on the telephone base or lift the handset. Then press the recessed **PROGRAM** key. The **MUTE** key flashes when in administrator mode.
2. Press the Speed Dial key where the telephone number is to be deleted. You hear 3 beeps. Press the recessed **PROGRAM** key again. You hear 3 rising beeps as confirmation.

## Telephone settings

**Analog cordless 1-line/2-line - A2410/CTM-A2411/A2420/CTM-A2421**

**Analog corded/cordless 1-line - CTM-A2510**

**Analog cordless 1-line/2-line accessory handset - CTM-C4101/CTM-C4201**

Default settings are indicated by asterisks (\*).

Setting	Options	Adjustable by:
Listening volume - handset	1, 2, 3, 4*, 5, 6	User and administrator
Speakerphone volume - handset	1, 2, 3, 4*, 5, 6	User and administrator
Speakerphone volume - telephone base	1, 2, 3, 4*, 5, 6	User and administrator
Ringer volume - telephone base	1, 2*, 3	User and administrator
Ringer tone - telephone base	Tone 1*, Tone 2, Tone 3	Administrator only
Flash	1 (100ms), 2 (300ms), 3* (600ms)	Administrator only
RF transmission power - telephone base	1 (low), 2* (middle), 3 (high)	Administrator only
Hold	00 (auto-release disabled), 01 - 14, 15*, 16 - 99 minutes	Administrator only
Voicemail voltage detection - <ul style="list-style-type: none"> <li>• Steady high voltage, periodic high voltage pulse and periodic low voltage pulse detection method</li> <li>• Line reversal method</li> <li>• FSK detection method</li> <li>• Panasonic</li> </ul>	0 (disable), 1 (enable)	Administrator only
Voicemail voltage detection - <ul style="list-style-type: none"> <li>• Siemens</li> </ul>	0 (disable), 1 (50Hz), 2 (25Hz), 3 (20Hz)	Administrator only

### Ringer tone

There are 3 ringer tones options that can be assigned to the telephone base. For 2-line model (**A2420**), changing the ringer tone of either **LINE 1** or **LINE 2** applies to both phone lines.

#### To change the ringer tone:

1. Remove the faceplate and overlay if they are on the telephone base. Then press the recessed **PROGRAM** key.
2. Press **00** and you hear 3 beeps. Then press a dialing key, **1**, **2** or **3**, to select the desired ringer tone. You hear 3 rising beeps as confirmation.

### Flash

There are 3 flash duration options that can be programmed.

#### To change the flash duration:

1. Remove the faceplate and overlay if they are on the telephone base. Then press the recessed **PROGRAM** key.
2. Press **FLASH** or **03** and you hear 3 beeps. Then press a dialing key, **1** (100ms), **2** (300ms) or **3** (600ms), to select the desired flash duration. You hear 3 rising beeps as confirmation.

### RF transmission power

There are 3 RF transmission power options on the telephone base that can be programmed.

#### To change the RF transmission power control level:

1. Remove the faceplate and overlay if they are on the telephone base. Then press the recessed **PROGRAM** key.
2. Press **01** and you hear 3 beeps. Then press a dialing key, **1** (low - coverage of 25% of maximum working distance), **2** (middle - coverage of 50% maximum working distance) or **3** (high - coverage of 100% of maximum working distance), to select the desired RF transmission power control level. You hear 3 rising beeps as confirmation.



# Telephone settings

## Analog cordless 1-line/2-line - A2410/CTM-A2411/A2420/CTM-A2421

## Analog corded/cordless 1-line CTM-A2510

## Analog cordless 1-line/2-line accessory handset - CTM-C4101/CTM-C4201

### Hold

The call on hold timeout duration can be programmed from 01 to 99 minutes. Select **00** to disable the auto-release feature on call on hold.

#### To change the call on hold timeout duration:

1. Remove the faceplate and overlay if they are on the telephone base. Then press the recessed **PROGRAM** key.
2. Press **02** and you hear 3 beeps. Then press the dialing keys from **00** to **99** minutes. You hear 3 rising beeps as confirmation.

### Voicemail voltage detection

There are several voicemail voltage detection methods on the telephone base that can be programmed.

#### To change the voicemail voltage detection by the steady high voltage, periodic high voltage pulse and periodic low voltage pulse detection method:

1. Remove the faceplate and overlay if they are on the telephone base. Then press the recessed **PROGRAM** key.
2. Press **10** and you hear 3 beeps. Then press a dialing key, **0** (disable) or **1** (enable), to select the desired setting. You hear 3 rising beeps as confirmation.

#### To change the voicemail voltage detection by the line reversal method:

1. Remove the faceplate and overlay if they are on the telephone base. Then press the recessed **PROGRAM** key.
2. Press **11** and you hear 3 beeps. Then press a dialing key, **0** (disable) or **1** (enable), to select the desired setting. You hear 3 rising beeps as confirmation.

#### To change the voicemail voltage detection by the FSK detection method:

1. Remove the faceplate and overlay if they are on the telephone base. Then press the recessed **PROGRAM** key.
2. Press **12** and you hear 3 beeps. Then press a dialing key, **0** (disable) or **1** (enable), to select the desired setting. You hear 3 rising beeps as confirmation.

#### To change the voicemail voltage detection by the Panasonic detection method:

1. Remove the faceplate and overlay if they are on the telephone base. Then press the recessed **PROGRAM** key.
2. Press **14** and you hear 3 beeps. Then press a dialing key, **0** (disable) or **1** (enable), to select the desired setting. You hear 3 rising beeps as confirmation.

#### To change the voicemail voltage detection by the Siemens detection method:

1. Remove the faceplate and overlay if they are on the telephone base. Then press the recessed **PROGRAM** key.
2. Press **13** and you hear 3 beeps. Then press a dialing key, **0** (disable), **1** (50Hz), **2** (25Hz) or **3** (20Hz) to select the desired setting. You hear 3 rising beeps as confirmation.

### Speed Dial keys

For cordless 1-line and 2-line models (**A2410/CTM-A2411/A2420/CTM-A2421**) there are up to 10 programmable guest-service (Speed Dial) keys. For corded/cordless model (**CTM-A2510**) there are up to 11 programmable guest-service (Speed Dial) keys. Program these keys to automatically dial telephone numbers or to activate telephone system features.

#### To program a Speed Dial key:

1. Remove the faceplate and overlay if they are on the telephone base. Then press the recessed **PROGRAM** key.
2. Press the desired Speed Dial key where the telephone number is to be stored. You hear 3 beeps.
3. Enter the telephone number (up to 32 digits).
  - To insert a pause in the stored number, press the recessed **PAUSE** key.
4. The telephone stored the number automatically when 32 digits are entered. When the number has less than 32 digits, press the recessed **PROGRAM** key again. You hear 3 rising beeps as confirmation.

#### To clear the programmed Speed Dial key:

1. Remove the faceplate and overlay if they are on the telephone base. Then press the recessed **PROGRAM** key.
2. Press the Speed Dial key where the telephone number is to be deleted. You hear 3 beeps. Press the recessed **PROGRAM** key again. You hear 3 rising beeps as confirmation.

## Telephone settings

### Analog cordless 1-line/2-line - A2410/CTM-A2411/A2420/CTM-A2421

### Analog corded/cordless 1-line CTM-A2510

### Analog cordless 1-line/2-line accessory handset - CTM-C4101/CTM-C4201

The cordless handset of CTM-A2411/CTM-A2421/CTM-A2510 has 3 programmable keys. Program these keys to automatically dial telephone numbers or to activate telephone system features.

#### To program the MESSAGE key on CTM-A2411/CTM-A2421/CTM-A2510 handset using the telephone base:

1. Remove the faceplate and overlay if they are on the telephone base. Then press the recessed **PROGRAM** key.
2. Press **60** and you hear 3 beeps.
3. Enter the telephone number (up to 32 digits).
  - To insert a pause in the stored number, press the recessed **PAUSE** key.
4. The telephone stored the number automatically when 32 digits are entered. When the number has less than 32 digits, press the recessed **PROGRAM** key again. You hear 3 rising beeps as confirmation.

#### To program the M1 key on CTM-A2411/CTM-A2421/CTM-A2510 handset using the telephone base:

1. Remove the faceplate and overlay if they are on the telephone base. Then press the recessed **PROGRAM** key.
2. Press **61** and you hear 3 beeps.
3. Enter the telephone number (up to 32 digits).
  - To insert a pause in the stored number, press the recessed **PAUSE** key.
4. The telephone stored the number automatically when 32 digits are entered. When the number has less than 32 digits, press the recessed **PROGRAM** key again. You hear 3 rising beeps as confirmation.

#### To program the M2 key on CTM-A2411/CTM-A2421/CTM-A2510 handset using the telephone base:

1. Remove the faceplate and overlay if they are on the telephone base. Then press the recessed **PROGRAM** key.
2. Press **62** and you hear 3 beeps.
3. Enter the telephone number (up to 32 digits).
  - To insert a pause in the stored number, press the recessed **PAUSE** key.
4. The telephone stored the number automatically when 32 digits are entered. When the number has less than 32 digits, press the recessed **PROGRAM** key again. You hear 3 rising beeps as confirmation.

#### To clear the programmed MESSAGE key using the telephone base:

1. Remove the faceplate and overlay if they are on the telephone base. Then press the recessed **PROGRAM** key.
2. Press **60** and you hear 3 beeps. Press the recessed **PROGRAM** key again. You hear 3 rising beeps as confirmation.

#### To clear the programmed M1 key using the telephone base:

1. Remove the faceplate and overlay if they are on the telephone base. Then press the recessed **PROGRAM** key.
2. Press **61** and you hear 3 beeps. Press the recessed **PROGRAM** key again. You hear 3 rising beeps as confirmation.

#### To clear the programmed M2 key using the telephone base:

1. Remove the faceplate and overlay if they are on the telephone base. Then press the recessed **PROGRAM** key.
2. Press **62** and you hear 3 beeps. Press the recessed **PROGRAM** key again. You hear 3 rising beeps as confirmation.

#### To program the MESSAGE/M1/M2 key on CTM-A2411/CTM-A2421 cordless handset using the cordless handset:

1. Press **\*234636#** and then **HOLD** when the cordless handset is not in use.
2. Press the desired **MESSAGE/M1/M2** key where the telephone number is to be stored. You hear 3 beeps.
3. Enter the telephone number (up to 32 digits).
  - To insert a pause in the stored number, press the recessed **PAUSE** key.
4. The telephone stored the number automatically when 32 digits are entered. When the number has less than 32 digits, press the desired **MESSAGE/M1/M2** key where the telephone number is to be stored. You hear 3 rising beeps as confirmation.

#### To program the MESSAGE/M1/M2 key on CTM-A2411/CTM-A2421 cordless handset using the cordless handset:

1. Remove the faceplate and overlay if they are on the telephone base. Then press the recessed **PROGRAM** key.
2. Press the desired **MESSAGE/M1/M2** key where the telephone number is to be deleted. You hear 3 beeps. Press the recessed **PROGRAM** key again. You hear 3 rising beeps as confirmation.

# Telephone operation

## Analog corded lobby - A2100

### Receive a call

The telephone rings when there is an incoming call. Lift the corded handset from the telephone base to answer.

### Place a call

Lift the corded handset and it automatically connects to the operator. Refer to your PABX user's manual for automatic dialing.

### End a call

Place the corded handset in the telephone base.

### Volume

Listening volume and ringer volume can be adjusted from the telephone base.

#### To adjust the listening volume:

During a call, press **+VOLUME** or **-VOLUME** to adjust the listening volume. The next call returns to the default listening volume.

#### To adjust the ringer volume:

At any time, slide the **RINGER VOL** switch on the right side of the telephone base to adjust the ringer volume.

### Data port

You can connect your modem or fax machine to the telephone line through the **DATA** port.

# Telephone operation

## Analog corded 1-line - A2210

### Using the corded handset and the telephone base

The corded handset and the telephone base speakerphone cannot be used at the same time. However, calls can be switched between the corded handset and the telephone base speakerphone.

### Receive a call

When there is an incoming call, the telephone rings and the **MESSAGE WAITING** LED flashes.

#### To answer a call using the corded handset:

Lift the corded handset from the telephone base.

#### To answer a call using the telephone base:

On the telephone base, press **◀/SPEAKER**. The **◀/SPEAKER** key illuminates when in speakerphone mode.

### Place a call

Lift the corded handset or press **▶/SPEAKER** on the telephone base. Listen for a dial tone and then dial the desired number, or press a Speed Dial key to dial a programmed number. The **▶/SPEAKER** key illuminates when in speakerphone mode.

### End a call

Place the corded handset in the telephone base, or press **▶/SPEAKER** when in speakerphone mode.

### Switch a call between the corded handset and the telephone base speakerphone

- To switch a call from the corded handset to the telephone base speakerphone, press **▶/SPEAKER** on the telephone base, then place the corded handset on the telephone base cradle.
- To switch a call from the telephone base speakerphone to the corded handset currently on the telephone base cradle, lift the corded handset from the telephone base cradle.
- To switch a call from the telephone base speakerphone to the corded handset which is not on the telephone base cradle, press **▶/SPEAKER** on the telephone base.

### Share a call

During a call, parallel telephones (telephones on the same line) can join the call.

#### To join a call:

During a call, lift the corded handset or press **▶/SPEAKER** to join.

### Volume

Listening volume and ringer volume can be adjusted from the telephone base.

#### To adjust the listening volume:

During a call, press **+/VOLUME** or **-/VOLUME** to adjust the listening volume. The next call returns to the default listening volume.

#### To adjust the ringer volume:

At any time, slide the **RINGER VOL** switch on the right side of the telephone base to adjust the ringer volume.

### Call waiting

1. When you hear a call waiting tone during a call, press **FLASH** on the telephone base to put your current call on hold and take the new incoming call.
2. Press **FLASH** or the switch hook once rapidly at any time to switch back and forth between calls.

### Mute

#### To mute the microphone:

1. During a call, press **MUTE** on the telephone base. The **MUTE** key illuminates when the mute function is turned on. You can hear the party on the other end but they cannot hear you.
2. Press **MUTE** again to resume the conversation. The light on the **MUTE** key turns off.

# Telephone operation

## Analog corded 1-line - A2210

### Hold

When a call is placed on hold, any parallel phone that tries to use the same phone line will take the call off hold and pick the call.

### To place a call on hold:

1. During a call, press **HOLD** on the telephone base to place that call on hold. The **HOLD** key flashes when the call is placed on hold.
2. To release the call from hold, press **⏻/SPEAKER, HOLD** or lift the handset from the telephone base cradle.

### Data port

You can connect your modem or fax machine to the telephone line through the **DATA** port.

# Telephone operation

## Analog corded 2-line - A2220

### Using the corded handset and the telephone base

The corded handset and the telephone base speakerphone cannot be used at the same time. However, calls can be switched between the corded handset and the telephone base speakerphone.

### Receive a call

- When there is a line 1 incoming call, the telephone rings. The **MESSAGE WAITING** LED and **LINE 1** key flash.
- When there is a line 2 incoming call, the telephone rings. **LINE 2** key flashes.

### To answer a call using the corded handset:

Lift the cordless handset. It automatically connects to the ringing line. The respective line key illuminates when in use.

### To answer a call using the telephone base:

Press the flashing line key for the ringing line, or press **☎/SPEAKER**. It automatically connects to the ringing line. The respective line key and the **☎/SPEAKER** key illuminate when in use.

### Place a call

Lift the corded handset, or press **LINE 1**, **LINE 2**, or **☎/SPEAKER** on the telephone base. Listen for a dial tone and then dial the desired number, or press a Speed Dial key to dial a programmed number. The respective line key illuminates when in use. The **☎/SPEAKER** key illuminates when in speakerphone mode.

### End a call

Place the corded handset in the telephone base, or press **☎/SPEAKER** or the active line key when in speakerphone mode.

### Switch a call between the corded handset and the telephone base speakerphone

- To switch a call from the corded handset to the telephone base speakerphone, press **☎/SPEAKER** on the telephone base, then place the corded handset on the telephone base cradle. The active line is selected. When both lines are in use or on hold, **LINE 1** is selected.
- To switch a call from the telephone base speakerphone to the corded handset currently on the telephone base cradle, lift the corded handset from the telephone base cradle. The active line is selected. When both lines are in use or on hold, **LINE 1** is selected.
- To switch a call from the telephone base speakerphone to the corded handset which is not on the telephone base cradle, press **☎/SPEAKER** on the telephone base. The active line is selected. When both lines are in use or on hold, **LINE 1** is selected.

### Share a call

During a call, parallel telephones (telephones on the same line) can join the call.

### To join a call:

During a call on line 1 or line 2, press the respective **LINE 1** or **LINE 2** key to join.

### Speakerphone

- When the telephone is idle, press **☎/SPEAKER**. The first available line is selected, starting with line 1.
- During a call on the handset, press **☎/SPEAKER**. The active line is selected. When both lines are in use or on hold, **LINE 1** is selected.

### Volume

Listening volume and ringer volume can be adjusted from the telephone base.

### To adjust the listening volume:

During a call, press **+VOLUME** or **-VOLUME** to adjust the listening volume. The next call returns to the default listening volume.

### To adjust the ringer volume:

At any time, slide the **RINGER VOL** switch on the right side of the telephone base to adjust the ringer volume.

### Call waiting

1. When you hear a call waiting tone during a call, press **FLASH** on the telephone base to put your current call on hold and take the new incoming call.
2. Press **FLASH** or the switch hook once rapidly at any time to switch back and forth between calls.

# Telephone operation

## Analog corded 2-line - A2220

### Mute

#### To mute the microphone:

1. During a call, press **MUTE** on the telephone base. The **MUTE** key illuminates when the mute function is turned on. You can hear the party on the other end but they cannot hear you.
2. Press **MUTE** again to resume the conversation. The light on the **MUTE** key turns off.

### Hold

When a call is placed on hold, any parallel phone that tries to use the same phone line will take the call off hold and pick the call.

#### To place a call on hold:

1. During a call, press **HOLD** on the telephone base to place that call on hold. The respective line key flashes when the call is placed on hold.
2. Press the flashing line key or **SPEAKER** to release the call from hold. The respective line key illuminates when in use. When both lines are on hold, press **SPEAKER** releases the call on line 1.

### Conference call

This telephone allows three-way conversations.

#### To initiate a conference call:

1. Place a call to the first party.
2. Press **HOLD** to place the first party on hold.
3. Place a second call on the other line.
4. Once the second party is on the line, press **CONF** to start a three-way conference.

#### To initiate a conference call while both calls are on hold:

Press **CONF** to start a three-way conference.

#### To end a conference call:

- Press a line key to maintain the connection with that line and drop the other line.
- When the conference call is in speakerphone mode, press **CONF** or **SPEAKER** on the telephone base to end.
- When the conference call is in handset earpiece mode, place the corded handset back in the telephone base to end.
- When there is more than one telephone on the conference call, the call ends when all telephones hang up.

### Data port

You can connect your modem or fax machine to the telephone line through the **DATA** port. The data port routes to line 2.

# Telephone operation

## Analog corded trimstyle - A2310

### Receive a call

When there is an incoming call, the telephone rings and the **MESSAGE WAITING** LED flashes.

#### To answer a call:

Lift the corded handset from the telephone base.

### Place a call

Lift the corded handset from the telephone base. Listen for a dial tone and then dial the desired number.

### End a call

Place the corded handset in the telephone base.

### Share a call

During a call, parallel telephones (telephones on the same line) can join the call. If the parallel telephone is a 2-line model, this telephone can only share call on one of the lines.

#### To join a call:

During a call, lift the corded handset to join.

### Volume

Listening volume and ringer volume can be adjusted.

#### To adjust the listening volume:

During a call, press **-/VOLUME/+** to adjust the listening volume. The next call returns to the default listening volume.

#### To adjust the ringer volume:

At any time, slide the **RINGER VOL** switch on the right side of the telephone base to adjust the ringer volume.

### Call waiting

1. When you hear a call waiting tone during a call, press **FLASH** on the handset to put your current call on hold and take the new incoming call.
2. Press **FLASH** or the switch hook once rapidly at any time to switch back and forth between calls.

### Mute

#### To mute the microphone:

1. During a call, press **MUTE** on the handset. The **MUTE** LED flashes when the mute function is turned on. You can hear the party on the other end but they cannot hear you.
2. Press any key to resume the conversation. The **MUTE** LED turns off.



# Telephone operation

## Analog cordless 1-line - A2410/CTM-A2411

### Using the cordless handset and the telephone base

The cordless handset and the telephone base cannot be used on the same call. However, calls can be switched between the cordless handset and the telephone base speakerphone.

When the cordless handset or the telephone base is in use, the **TALK** key on the cordless handset and the **IN USE** LED on the telephone base illuminate.

### Receive a call

When there is an incoming call, the telephone rings. The **IN USE** LED and the **MESSAGE WAITING** LED on the telephone base flash, and the **TALK** key on the cordless handset flashes.

#### To answer a call using the cordless handset while it is not on the telephone base, charging base or charging stand:

On the cordless handset, press **TALK** or **☎/SPEAKER**. The **TALK** key illuminates when in use. The **☎/SPEAKER** key illuminates when in speakerphone mode.

#### To answer a call using the cordless handset while it is resting on the telephone base, charging base or charging stand:

Lift the cordless handset from the telephone base, charging base or charging stand. The **TALK** key illuminates when in use. The **☎/SPEAKER** key illuminates when in speakerphone mode.

#### To answer a call using the telephone base:

On the telephone base, press **☎/SPEAKER**. The **IN USE** LED and the **☎/SPEAKER** key illuminate when in use.

### Place a call

#### To place a call using the cordless handset:

On the cordless handset, press **TALK** or **☎/SPEAKER**. Listen for a dial tone and then dial the desired number, or press a Speed Dial key on the telephone base to dial a programmed number. The **TALK** key illuminates when in use. The **☎/SPEAKER** key illuminates when in speakerphone mode.

#### To place a call using the telephone base:

On the telephone base, press **☎/SPEAKER**. Listen for a dial tone and then dial the desired number, or press a Speed Dial key to dial a programmed number. The **IN USE** LED and the **☎/SPEAKER** key illuminate when in use.

### End a call

#### To end a call when using the cordless handset:

Press **OFF** on the cordless handset or place it in the telephone base, charging base or charging stand. The call ends when all handsets hang up.

#### To end a call when using the telephone base:

Press **☎/SPEAKER**.

### Switch a call between the cordless handset and the telephone base speakerphone

- To switch a call from the cordless handset to the telephone base speakerphone, press **☎/SPEAKER** on the telephone base.
- To switch a call from the telephone base speakerphone to the cordless handset which is not on the telephone base cradle, press **TALK** or **☎/SPEAKER** on the cordless handset.
- To switch a call from the telephone base speakerphone to the cordless handset currently on the telephone base cradle, lift the cordless handset from the telephone base.

### Share a call

A maximum of four cordless handsets can be used at the same time on an external call.

#### To join a call:

During a call, press **TALK** or **☎/SPEAKER** on another cordless handset to join.

### Handset speakerphone

During a call, press **☎/SPEAKER** on the cordless handset to switch between speakerphone mode and handset earpiece mode.

# Telephone operation

## Analog cordless 1-line - A2410/CTM-A2411

### Redial

The last dialed number on the cordless handset or the telephone base is stored for 15 minutes.

#### To redial the last dialed number from the cordless handset:

Press **TALK** or **📞/SPEAKER**. Listen for a dial tone. Then press **REDIAL**.

#### To redial the last dialed number from the telephone base:

Press **📞/SPEAKER**. Listen for a dial tone. Then press **REDIAL**.

### Volume

Listening volume can be adjusted on the cordless handset and the telephone base.

#### To adjust the listening volume:

- During a call on the handset, press **-/VOLUME/+** on it to adjust the listening volume. The next call returns to the default listening volume.
- During a call on the telephone base, press **+/VOLUME** or **-/VOLUME** on it to adjust the listening volume. The next call returns to the default listening volume.

Ringer volume of the telephone base can be adjusted.

#### To adjust the ringer volume of the telephone base:

When the telephone base is idle, press **+/VOLUME** or **-/VOLUME** on it to adjust the ringer volume.

### Call waiting

1. When you hear a call waiting tone during a call, press **FLASH** on the cordless handset or telephone base to put the current call on hold and take the new incoming call.
2. Press **FLASH** at any time to switch back and forth between calls.

### Mute

#### To mute the microphone:

1. During a call, press **MUTE** on the cordless handset or telephone base. The **MUTE** key illuminates when the mute function is turned on. You can hear the party on the other end but they cannot hear you.
2. Press **MUTE** again to resume the conversation. The light on the **MUTE** key turns off.

### Hold

When a call is placed on hold, any parallel phone that tries to use the same phone line will take the call off hold and pick the call.

#### To place a call on hold on the cordless handset:

1. During a call, press **HOLD** on the cordless handset. The **TALK** key on the cordless handset and the **HOLD** key on the telephone base flash when the call is on hold.
2. Press **TALK** or **📞/SPEAKER** to release the call from hold, or the call will end automatically after the preset call on hold duration.

#### To place a call on hold on the telephone base:

1. During a call, press **HOLD** on the telephone base. The **HOLD** key flashes when the call is on hold.
2. Press **📞/SPEAKER** to release the call from hold, or the call will end automatically after the preset call on hold duration.

# Telephone operation

## Analog cordless 1-line - A2410/CTM-A2411

### Intercom

Use this feature for conversations between two cordless handsets, or a cordless handset and the telephone base.

#### To initiate an intercom call:

- On the cordless handset, press **INTERCOM** when it is not in use. It beeps and the **INTERCOM** key illuminates. All destination cordless handsets (except the cordless handset on the telephone base) and the telephone base ring, and the **INTERCOM/INT** keys flash.

**-OR-**

- On the telephone base, press **INT** when it is not in use. It beeps and the **INT** key illuminates. All destination cordless handsets (except the cordless handset on the telephone base) ring and the **INTERCOM** keys flash.

#### To initiate an intercom call during a call:

- During a call on the cordless handset, press **HOLD** to put the current call on hold. Then press **INTERCOM**. It beeps and the **INTERCOM** key illuminates. All destination cordless handsets (except the cordless handset on the telephone base) and the telephone base ring, and the **INTERCOM/INT** keys flash.

**-OR-**

- During a call on the telephone base, press **HOLD** to put the current call on hold. Then press **INT**. It beeps and the **INT** key illuminates. All destination cordless handsets (except the cordless handset on the telephone base) ring and the **INTERCOM** keys flash.

#### To answer an intercom call:

- Lift the cordless handset from the telephone base cradle, or press **INTERCOM** or **☎/SPEAKER** on the cordless handset.

**-OR-**

- Press **INT** or **☎/SPEAKER** on the telephone base.

#### To answer an incoming call during an intercom call:

Press **TALK** on the cordless handset or press **☎/SPEAKER** twice on the telephone base. The intercom call ends automatically.

#### To end an intercom call:

- Place the cordless handset in the telephone base cradle, or press **OFF** on the cordless handset.

**-OR-**

- Press **INT** or **☎/SPEAKER** on the telephone base.

### Find handset

Use this feature to find all registered cordless handsets.

#### To start paging:

Press **☎/FIND HANDSET** on the telephone base when the telephone is not in use. All idle cordless handsets beep for 60 seconds.

#### To end paging:

- Press **☎/FIND HANDSET** again on the telephone base.

**-OR-**

- Press any key on the cordless handset to stop the paging tone.

### Data port

You can connect your modem or fax machine to the telephone line through the **DATA** port.

# Telephone operation

## Analog cordless 2-line - A2420/CTM-A2421

### Using the cordless handset and the telephone base

The cordless handset and the telephone base cannot be used on the same call. However, calls can be switched between the cordless handset and the telephone base speakerphone.

When the cordless handset or the telephone base is in use, the corresponding line keys on the cordless handset and the telephone base illuminate.

### Receive a call

When there is an incoming call, the telephone rings. The corresponding line key and the **MESSAGE WAITING** LED on the telephone base flash, and the corresponding line key on the cordless handset flashes.

#### To answer a call using the cordless handset while it is not on the telephone base, charging base or charging stand:

On the cordless handset, press the flashing line key for the ringing line, or press **☎/SPEAKER**. It automatically connects to the ringing line. The respective line key illuminates when in use. The **☎/SPEAKER** key illuminates when in speakerphone mode.

#### To answer a call using the cordless handset while it is resting on the telephone base, charging base or charging stand:

Pick up the cordless handset from the telephone base. It automatically connects to the ringing line. The respective line key illuminates when in use.

#### To answer a call using the telephone base:

On the telephone base, press the flashing line key for the ringing line, or press **☎/SPEAKER**. It automatically connects to the ringing line. The respective line key and the **☎/SPEAKER** key illuminate when in use.

### Place a call

#### To place a call using the cordless handset:

On the cordless handset, press **LINE 1**, **LINE 2** or **☎/SPEAKER**. Listen for a dial tone and then dial the desired number, or press a Speed Dial key on the telephone base to dial a programmed number. The respective line key illuminates when in use. The **☎/SPEAKER** key illuminates when in speakerphone mode. When line 1 or line 2 is in use with a cordless handset, the other line on the cordless handset cannot use the Speed Dial keys from the telephone base.

#### To place a call using the telephone base:

On the telephone base, press **LINE 1**, **LINE 2** or **☎/SPEAKER**. Listen for a dial tone and then dial the desired number, or press a Speed Dial key to dial a programmed number. The line key and the **☎/SPEAKER** key illuminate when in use.

### End a call

#### To end a call when using the cordless handset:

Press **OFF** on the cordless handset or place it in the telephone base, charging base or charging stand. The call ends when all handsets hang up.

#### To end a call when using the telephone base:

Press **☎/SPEAKER** or the respective line key on the telephone base.

### Switch a call between the cordless handset and the telephone base speakerphone

- To switch a call from the cordless handset to the telephone base speakerphone, press the respective line key or **☎/SPEAKER** on the telephone base.
- To switch a call from the telephone base speakerphone to the cordless handset which is not on the telephone base cradle, press the respective line key or **☎/SPEAKER** on the cordless handset.
- To switch a call from the telephone base speakerphone to the cordless handset currently on the telephone base cradle, lift the cordless handset from the telephone base.

### Share a call

A maximum of four cordless handsets can be used at the same time on an external call. If both lines are in use, a maximum of three cordless handsets can be used on one line and the fourth handset can be used on the other line at the same time.

#### To join a call:

During a call on line 1 or line 2, press the respective **LINE 1**, **LINE 2** or **☎/SPEAKER** on another cordless handset to join.

### Handset speakerphone

During a call on the handset, press **☎/SPEAKER** on the cordless handset to switch between speakerphone mode and handset earpiece mode.

### Speakerphone

When the telephone is idle, press **☎/SPEAKER** on the cordless handset or the telephone base. The first available line is selected, starting with line 1.

# Telephone operation

## Analog cordless 2-line - A2420/CTM-A2421

### Redial

The last dialed number on the cordless handset or telephone base is stored for 15 minutes.

#### To redial the last dialed number from the handset or telephone base:

Press **LINE 1**, **LINE 2** or **☎/SPEAKER**. Listen for a dial tone. Then press **REDIAL**.

### Volume

Listening volume can be adjusted on the cordless handset and the telephone base.

#### To adjust the listening volume:

- During a call on the handset, press **-/VOLUME/+** on it to adjust the listening volume. The next call returns to the default listening volume.
- During a call on the telephone base, press **+/VOLUME** or **-/VOLUME** on it to adjust the listening volume. The next call returns to the default listening volume.

Ringer volume of the telephone base can be adjusted.

#### To adjust the ringer volume of the telephone base:

When the telephone base is idle, press **+/VOLUME** or **-/VOLUME** on it to adjust the ringer volume.

### Call waiting

1. When you hear a call waiting tone during a call, press **FLASH** on the cordless handset or telephone base to put the current call on hold and take the new incoming call.
2. Press **FLASH** at any time to switch back and forth between calls.

### Mute

#### To mute the microphone:

1. During a call, press **MUTE** on the cordless handset or telephone base. The **MUTE** key illuminates when the mute function is turned on. You can hear the party on the other end but they cannot hear you.
2. Press **MUTE** again to resume the conversation. The light on the **MUTE** key turns off.

### Hold

When a call is placed on hold, any parallel phone that tries to use the same phone line will take the call off hold and pick the call.

#### To place a call on hold:

1. During a call, press **HOLD** on the cordless handset or telephone base to place that call on hold. The corresponding line key flashes when the call is on hold.
2. Press the flashing line key or **☎/SPEAKER** to release the call from hold, or the call will end automatically after the preset call on hold duration. When both lines are on hold, press **☎/SPEAKER** releases the call on line 1.

### Intercom

Use this feature for conversations between two cordless handsets, or a cordless handset and the telephone base.

#### To initiate an intercom call:

- On the cordless handset, press **INTERCOM** when it is not in use. It beeps and the **INTERCOM** key illuminates. All destination cordless handsets (except the cordless handset on the telephone base) and the telephone base ring, and the **INTERCOM/INT** keys flash.

**-OR-**

- On the telephone base, press **INT** when it is not in use. It beeps and the **INT** key illuminates. All destination cordless handsets (except the cordless handset on the telephone base) ring and the **INTERCOM** keys flash.

#### To initiate an intercom call during a call:

- During a call on the cordless handset, press **HOLD** to put the current call on hold. Then press **INTERCOM**. It beeps and the **INTERCOM** key illuminates. All destination cordless handsets (except the cordless handset on the telephone base) and the telephone base ring, and the **INTERCOM/INT** keys flash.

**-OR-**

- During a call on the telephone base, press **HOLD** to put the current call on hold. Then press **INT**. It beeps and the **INT** key illuminates. All destination cordless handsets (except the cordless handset on the telephone base) ring and the **INTERCOM** keys flash.

#### To answer an intercom call:

- Lift the cordless handset from the telephone base cradle, or press **INTERCOM** on the cordless handset.

**-OR-**

- Press **INT** or **☎/SPEAKER** on the telephone base.

# Telephone operation

## Analog cordless 2-line - A2420/CTM-A2421

### To answer an incoming call during an intercom call:

Press the flashing line key on the cordless handset or telephone base, or press **☎/SPEAKER** twice on the telephone base. The intercom call ends automatically.

### To end an intercom call:

- Place the cordless handset on the telephone base cradle, or press **OFF** on the cordless handset.

**-OR-**

- Press **INT** on the telephone base.

## Conference call

This telephone allows three-way conversations.

### To initiate a conference call:

1. Place a call to the first party.
2. Press **HOLD** to place the first party on hold.
3. Place a second call on the other line.
4. Once the second party is on the line, press **CONF** to start a three-way conference.

### To initiate a conference call while both calls are on hold:

Press **CONF** to start a three-way conference.

### To switch a conference call from the telephone base to the cordless handset:

- During a conference call on the telephone base, press **☎/SPEAKER** or **CONF** on the cordless handset, or lift the cordless handset from the telephone base.
- During a conference call on the telephone base, press **HOLD** on the telephone base and then press **CONF** on the cordless handset.

### To switch a conference call from the cordless handset to the telephone base:

- During a conference call on the cordless handset, press **☎/SPEAKER** or **CONF** on the telephone base.
- During a conference call on the cordless handset, press **HOLD** on the cordless handset and then press **CONF** on the telephone base.

### To end a conference call:

- Press a line key to maintain the connection with that line and drop the other line.
- When the conference call is at the telephone base, press **☎/SPEAKER** or **CONF** on the telephone base.
- When the conference call is on the cordless handset, press **OFF** on the cordless handset, or place it back in the telephone base, charging base or charging stand.
- When there is more than one cordless handset on the conference call, the call ends when all handsets hang up.

## Find handset

Use this feature to find all registered cordless handsets.

### To start paging:

Press **📞/FIND HANDSET** on the telephone base when the telephone is not in use. All idle cordless handsets beep for 60 seconds.

### To end paging:

- Press **📞/FIND HANDSET** again on the telephone base.

**-OR-**

- Press any key on the handset to stop the paging tone.

## Data port

You can connect your modem or fax machine to the telephone line through the **DATA** port. The data port routes to line 2.

# Telephone operation

## Analog corded/cordless 1-line - CTM-A2510

### Using the cordless handset and the telephone base

The cordless handset and the telephone base cannot be used on the same call. However, calls can be switched between the cordless handset and the telephone base speakerphone.

When the cordless handset or the telephone base is in use, the **TALK** key on the cordless handset and the **IN USE** LED on the telephone base illuminate.

### Receive a call

When there is an incoming call, the telephone rings. The **IN USE** LED and the **MESSAGE WAITING** LED on the telephone base flash, and the **TALK** key on the cordless handset flashes.

#### To answer a call using the cordless handset while it is not on the telephone base, charging base or charging stand:

On the cordless handset, press **TALK** or **☎/SPEAKER**. The **TALK** key illuminates when in use. The **☎/SPEAKER** key illuminates when in speakerphone mode.

#### To answer a call using the cordless handset while it is resting on the telephone base, charging base or charging stand:

Lift the cordless handset from the telephone base, charging base or charging stand. The **TALK** key illuminates when in use. The **☎/SPEAKER** key illuminates when in speakerphone mode.

#### To answer a call using the telephone base:

On the telephone base, press **☎/SPEAKER**. The **IN USE** LED and the **☎/SPEAKER** key illuminate when in use.

### Place a call

#### To place a call using the cordless handset:

On the cordless handset, press **TALK** or **☎/SPEAKER**. Listen for a dial tone and then dial the desired number, or press a Speed Dial key on the telephone base to dial a programmed number. The **TALK** key illuminates when in use. The **☎/SPEAKER** key illuminates when in speakerphone mode.

#### To place a call using the telephone base:

On the telephone base, press **☎/SPEAKER**. Listen for a dial tone and then dial the desired number, or press a Speed Dial key to dial a programmed number. The **IN USE** LED and the **☎/SPEAKER** key illuminate when in use.

### End a call

#### To end a call when using the cordless handset:

Press **OFF** on the cordless handset or place it in the telephone base, charging base or charging stand. The call ends when all handsets hang up.

#### To end a call when using the telephone base:

Press **☎/SPEAKER**.

### Switch a call between the cordless handset and the telephone base speakerphone

- To switch a call from the cordless handset to the telephone base speakerphone, press **☎/SPEAKER** on the telephone base.
- To switch a call from the telephone base speakerphone to the cordless handset which is not on the telephone base cradle, press **TALK** or **☎/SPEAKER** on the cordless handset.
- To switch a call from the telephone base speakerphone to the cordless handset currently on the telephone base cradle, lift the cordless handset from the telephone base.

### Share a call

A maximum of two cordless handsets can be used at the same time on an external call.

#### To join a call:

During a call, press **TALK** or **☎/SPEAKER** on another cordless handset to join.

### Handset speakerphone

During a call, press **☎/SPEAKER** on the cordless handset to switch between speakerphone mode and handset earpiece mode.

### Redial

The last dialed number on the cordless handset or the telephone base is stored for 15 minutes.

#### To redial the last dialed number from the cordless handset:

Press **TALK** or **☎/SPEAKER**. Listen for a dial tone. Then press **REDIAL**.

#### To redial the last dialed number from the telephone base:

# Telephone operation

## Analog corded/cordless 1-line - CTM-A2510

Press **📞/SPEAKER**. Listen for a dial tone. Then press **REDIAL**.

### Volume

Listening volume can be adjusted on the cordless handset and the telephone base.

#### To adjust the listening volume:

- During a call on the handset, press **-/VOLUME/+** on it to adjust the listening volume. The next call returns to the default listening volume.
- During a call on the telephone base, press **+/VOLUME** or **-/VOLUME** on it to adjust the listening volume. The next call returns to the default listening volume.

Ringer volume of the telephone base can be adjusted.

#### To adjust the ringer volume of the telephone base:

When the telephone base is idle, press **+/VOLUME** or **-/VOLUME** on it to adjust the ringer volume.

### Call waiting

1. When you hear a call waiting tone during a call, press **FLASH** on the cordless handset or telephone base to put the current call on hold and take the new incoming call.
2. Press **FLASH** at any time to switch back and forth between calls.

### Mute

#### To mute the microphone:

1. During a call, press **MUTE** on the cordless handset or telephone base. The **MUTE** key illuminates when the mute function is turned on. You can hear the party on the other end but they cannot hear you.
2. Press **MUTE** again to resume the conversation. The light on the **MUTE** key turns off.

### Hold

When a call is placed on hold, any parallel phone that tries to use the same phone line will take the call off hold and pick the call.

#### To place a call on hold on the cordless handset:

1. During a call, press **HOLD** on the cordless handset. The **TALK** key on the cordless handset and the **HOLD** key on the telephone base flash when the call is on hold.
2. Press **TALK** or **📞/SPEAKER** to release the call from hold, or the call will end automatically after the preset call on hold duration.

#### To place a call on hold on the telephone base:

1. During a call, press **HOLD** on the telephone base. The **HOLD** key flashes when the call is on hold.
2. Press **📞/SPEAKER** to release the call from hold, or the call will end automatically after the preset call on hold duration.

### Find handset

Use this feature to find all registered cordless handsets.

#### To start paging:

Press **FIND HANDSET** on the telephone base when the telephone is not in use. All idle cordless handsets beep for 60 seconds.

#### To end paging:

- Press **FIND HANDSET** again on the telephone base.

**-OR-**

- Press any key on the cordless handset to stop the paging tone.

### Data port

You can connect your modem or fax machine to the telephone line through the **DATA** port.



# Appendix

## Handset battery

It takes up to 16 hours for the battery to be fully charged. When it is fully charged, you can expect the following performance:

Operation	Operating time
While in handset use (talking*)	Up to 7 hours
While in speakerphone mode (talking*)	Up to 5 hours
While not in use (standby**)	Up to 7 days

\* Operating times vary depending on your actual use and the age of the battery.

\*\* Handset is not charging or in use.

The battery needs charging when:

- A new battery is installed in the handset.
- **LOW BATTERY** LED flashes on the cordless handset.

### CAUTION:

To reduce the risk of fire or injury, read and follow these instructions:

- Use only the supplied rechargeable battery (BT264392/BT266342) or replacement battery (BT266342). To order a replacement, visit our website at [www.vtechhotelphones.com](http://www.vtechhotelphones.com) or call 1-888-907-2007.
- Do not dispose of the battery in a fire. Check with local waste management codes for special disposal instructions.
- Do not open or mutilate the battery. Released electrolyte is corrosive and may cause burns or injury to the eyes or skin. The electrolyte may be toxic if swallowed.
- Exercise care in handling the battery in order not to create a short circuit with conductive materials.
- Charge the battery provided with or identified for use with this product only in accordance with the instructions and limitations specified in this manual.
- Observe proper polarity orientation between the battery and metallic contacts.
- To prevent fire or shock hazard, do not expose this product to water or any type of moisture.

# Appendix

## Troubleshooting

If you have difficulty with the telephones, please try the suggestions below. For customer service, visit our website at [www.vtechhotelphones.com](http://www.vtechhotelphones.com) or call 1-888-907-2007.

### For corded telephones:

#### The telephone does not work at all.

- Make sure the telephone line is plugged into the **TEL** port of the telephone base.
- Make sure the telephone line cord is plugged firmly into the telephone wall jack.
- Disconnect the telephone base from the telephone wall jack and plug in a working telephone. If the other telephone does not work, the problem is probably in the wiring or telephone service. Contact your telephone service provider (charges may apply).

#### There is no dial tone.

- Try all the above suggestions.
- The telephone line cord may be defective. Install a new telephone line cord.
- Disconnect the telephone base from the telephone wall jack and connect a different telephone. If there is no dial tone on this telephone either, the problem is in your wiring or telephone service. Contact your telephone service provider (charges may apply).

#### I cannot dial out.

- Try all the above suggestions.
- Make sure there is a dial tone before dialing.
- Eliminate any background noise. Mute the telephone before dialing, if applicable, or dial from another room in your unit with less background noise.
- If other telephones in your hotel are having the same problem, the problem is in the wiring or telephone service. Contact your telephone service provider (charges may apply).

#### The telephone does not ring when there is an incoming call.

- Make sure the telephone line cord is plugged in properly (pages 12 and 20).
- If other telephones in your hotel are having the same problem, the problem is in the wiring or telephone service. Contact your telephone service provider (charges may apply).
- Test a working telephone at the telephone wall jack. If another telephone has the same problem, the problem is in the telephone wall jack. Contact your telephone service provider (charges may apply).
- The telephone line cord may be defective. Install a new telephone line cord.

#### There is interference during a telephone conversation.

- If there is High Speed Internet Access (HSIA) available at the premises through a telephone line, you may need to install a DSL filter (DSL - digital subscriber line) between the telephone line cord and the telephone wall jack. The filter prevents noise and caller ID problems caused by DSL interference. Contact your DSL service provider for more information about DSL filters.
- If your telephone is plugged in with a modem or a surge protector, plug the telephone (or modem/surge protector) into a different location. If this doesn't solve the problem, relocate your telephone or modem farther apart from each other, or use a different surge protector.
- Disconnect the telephone base from the telephone wall jack. Plug in a different telephone. If calls are still not clear, the problem is probably in the wiring or local telephone service. Contact your telephone service provider (charges may apply).
- If other telephones in your hotel are having the same problem, the problem is in the wiring or telephone service. Contact your telephone service provider (charges may apply).

#### I hear other calls when using the telephone.

- Disconnect the telephone base from the telephone wall jack. Plug in a different telephone. If you still hear other calls, the problem is probably in the wiring or telephone service. Contact your telephone service provider (charges may apply).

# Appendix

## Troubleshooting

### For cordless telephones:

#### The telephone does not work at all.

- Make sure the RJ-45 cord is plugged into the **TEL** port of the telephone base.
- Make sure the power adapter is securely plugged into an outlet not controlled by a wall switch.
- Make sure the telephone line cord is plugged firmly into the power adapter and the telephone wall jack.
- Make sure the battery is installed and charged correctly (page 24). For optimum daily performance, return the cordless handset to the telephone base, charging base or charging stand after use.
- Unplug the electrical power to the telephone base. Wait for approximately 15 seconds, then plug it back in. Allow up to one minute for the cordless handset and telephone base to synchronize.
- Charge the battery in the cordless handset for up to 16 hours.
- If the battery is completely depleted, it may take up to 30 minutes to charge the cordless handset before the **LOW BATTERY** LED flashes on the cordless handset.
- Remove and install the battery again. If that still does not work, it may be necessary to purchase a new battery.
- Disconnect the telephone base from the telephone wall jack and plug in a working telephone. If the other telephone does not work, the problem is probably in the wiring or telephone service. Contact your telephone service provider (charges may apply).

#### There is no dial tone.

- Try all the above suggestions.
- Move the cordless handset closer to the telephone base or adjust the setting of RF transmission power (page 36). It may be out of range.
- The telephone line cord may be defective. Install a new telephone line cord.
- Disconnect the telephone base from the telephone wall jack and connect a different telephone. If there is no dial tone on this telephone either, the problem is in your wiring or telephone service. Contact your telephone service provider (charges may apply).

#### I cannot dial out.

- Try all the above suggestions.
- Make sure there is a dial tone before dialing. It is normal if the cordless handset takes a second or two to synchronize with the telephone base before producing a dial tone. Wait an extra second before dialing.
- Eliminate any background noise. Mute the telephone before dialing, or dial from another room in your unit with less background noise.
- If other telephones in your hotel are having the same problem, the problem is in the wiring or telephone service. Contact your telephone service provider (charges may apply).

#### The **LOW BATTERY** LED flashes on the cordless handset.

- Place the cordless handset in the telephone base, charging base or charging stand for recharging.
- Remove and install the battery again and use it until fully depleted, then charge the cordless handset in the telephone base, charging base or charging stand for up to 16 hours.
- If the above measures do not correct the problem, replace the battery.

#### The battery does not charge in the cordless handset or the battery does not accept charge.

- Make sure the cordless handset is placed in the telephone base, charging base or charging stand correctly. The **CHARGE** LED should be on.
- Remove and install the battery again, then charge for up to 16 hours.
- If the cordless handset is in the telephone base, charging base or charging stand but the **CHARGE** LED is not on, refer to **The CHARGE LED is off** below.
- If the battery is completely depleted, charge it for at least 30 minutes before use.
- If the above measures do not correct the problem, replace the battery.

#### The **CHARGE** LED is off.

- Clean the charging contacts on the cordless handset, telephone base, charging base and charging stand each month with a pencil eraser or a dry non-abrasive fabric.
- Make sure the power adapter and telephone line cord are plugged in correctly and securely.
- Unplug the power adapter. Wait for 15 seconds before plugging it back in. Allow up to one minute for the cordless handset and telephone base to reset.

# Appendix

## Troubleshooting

### For cordless telephones:

#### The telephone does not ring when there is an incoming call.

- Make sure the telephone line cord and the power adapter are plugged in properly (page 22).
- The cordless handset may be too far from the telephone base. Move it closer to the telephone base.
- Adjust the setting of RF transmission power (page 36). It may be out of range.
- If other telephones in your hotel are having the same problem, the problem is in the wiring or telephone service. Contact your telephone service provider (charges may apply).
- Other electronic products such as HAM radios and other DECT phones can cause interference with your cordless phone. Try installing your phone as far away as possible from these types of electronic devices.
- Test a working telephone at the telephone wall jack. If another telephone has the same problem, the problem is in the telephone wall jack. Contact your telephone service provider (charges may apply).
- The telephone line cord may be defective. Install a new telephone line cord.
- Remove and install the battery again and place the cordless handset in the telephone base. Wait for the handset to synchronize with the telephone base. Allow up to one minute for this to take place.

#### The cordless handset beeps and is not performing normally.

- Make sure the power cord is securely plugged into the telephone base. Plug the telephone base into a different working electrical outlet not controlled by a wall switch.
- Move the cordless handset closer to the telephone base or adjust the setting of RF transmission power (page 36). It may be out of range.
- Reset the telephone base by unplugging the electrical power to the base. Wait for 15 seconds and plug it back in again. Allow up to one minute for the cordless handset and the telephone base to synchronize.
- Other electronic products such as HAM radios and other DECT phones can cause interference with your cordless phone. Try installing your phone as far away as possible from these types of electronic devices.

#### There is interference during a telephone conversation or the call fades in and out when I am using the cordless handset.

- Move the handset closer to the telephone base or adjust the setting of RF transmission power (page 36). It may be out of range.
- If there is High Speed Internet Access (HSIA) available at the premises through a telephone line, you may need to install a DSL filter (DSL - digital subscriber line) between the telephone line cord and the telephone wall jack. The filter prevents noise and caller ID problems caused by DSL interference. Contact your DSL service provider for more information about DSL filters.
- Appliances or other cordless telephones plugged into the same circuit as the telephone base can cause interference. Try moving the appliance or telephone base to another outlet.
- Other electronic products such as HAM radios and other DECT phones can cause interference with your cordless phone. Try installing your phone as far away as possible from these types of electronic devices.
- If your telephone is plugged in with a modem or a surge protector, plug the telephone (or modem/surge protector) into a different location. If this doesn't solve the problem, relocate your telephone or modem farther apart from each other, or use a different surge protector.
- The location of your telephone base can impact the performance of your cordless phone. For better reception, install the telephone base in a centralized location within the room, away from walls or other obstructions.
- Disconnect the telephone base from the telephone wall jack and plug in a corded telephone. If calls are still not clear, the problem is probably in the wiring or telephone service. Contact your telephone service provider (charges may apply).
- If other telephones in your hotel are having the same problem, the problem is in the wiring or telephone service. Contact your telephone service provider (charges may apply).

#### I hear other calls when using the telephone.

- Disconnect the telephone base from the telephone wall jack. Plug in a different telephone. If you still hear other calls, the problem is probably in the wiring or telephone service. Contact your telephone service provider (charges may apply).

#### I hear noise on the cordless handset and the keys do not work.

- Make sure the telephone line cord is plugged in securely.

#### Common cure for electronic equipment.

- If the telephone is not responding normally, put the cordless handset in the telephone base. If it does not fix the problem, try the following (in the order listed):
  1. Disconnect the power to the telephone base.
  2. Disconnect the battery on the cordless handset.
  3. Wait a few minutes before connecting power to the telephone base.
  4. Install the battery again and place the cordless handset in the telephone base.
  5. Wait for the cordless handset to synchronize with the telephone base. Allow up to one minute for this to take place.

# Appendix

## Precautions for users of implanted cardiac pacemakers

Cardiac pacemakers (applies only to digital cordless telephones):

Wireless Technology Research, LLC (WTR), an independent research entity, led a multidisciplinary evaluation of the interference between portable wireless telephones and implanted cardiac pacemakers. Supported by the U.S. Food and Drug Administration, WTR recommends to physicians that:

### Pacemaker patients

- Should keep wireless telephones at least six inches from the pacemaker.
- Should NOT place wireless telephones directly over the pacemaker, such as in a breast pocket, when it is turned ON.
- Should use the wireless telephone at the ear opposite the pacemaker.

WTR's evaluation did not identify any risk to bystanders with pacemakers from other persons using wireless telephones.

## Operating range

The cordless telephone operates with the maximum power allowed by the Federal Communications Commission (FCC). Even so, the cordless handset and telephone base can communicate over only a certain distance - which can vary with the locations of the telephone base, cordless handset, the weather, and the layout of the hotel.

When the cordless handset is out of range while on a call, the cordless handset rapidly beeps three times.

If there is a call while the handset is out of range, it may not ring, or if it does ring, the call may not connect well when you answer the call. Move closer to the telephone base to answer the call.

If the handset moves out of range during a telephone conversation, there may be interference.

To improve reception, move closer to the telephone base.

## About cordless telephones

- **Privacy:** The same features that make a cordless telephone convenient create some limitations. Telephone calls are transmitted between the telephone base and the cordless handset by radio waves, so there is a possibility that the cordless telephone conversations could be intercepted by radio receiving equipment within range of the cordless handset. For this reason, you should not think of cordless telephone conversations as being as private as those on corded telephones.
- **Electrical power:** The telephone base of the cordless telephone must be connected to a working electrical outlet. The electrical outlet should not be controlled by a wall switch. Calls cannot be made from the cordless handset if the telephone base is unplugged, switched off or if the electrical power is interrupted.
- **Potential TV interference:** Some cordless telephones operate at frequencies that may cause interference to televisions and VCRs. To minimize or prevent such interference, do not place the telephone base of the cordless telephone near or on top of a TV or VCR. If interference is experienced, moving the cordless telephone farther away from the TV or VCR often reduces or eliminates the interference.
- **Rechargeable batteries:** Exercise care in handling batteries in order not to create a short circuit with conducting material such as rings, bracelets and keys. The battery or conductor may overheat and cause harm. Observe proper polarity between the battery and the battery charger.
- **Nickel-metal hydride rechargeable batteries:** Dispose of these batteries in a safe manner. Do not burn or puncture the battery. Like other batteries of this type, if burned or punctured, they could release caustic material which could cause injury.

## The RBRC® seal



The RBRC® seal on the nickel-metal hydride battery indicates that VTech Communications, Inc. is voluntarily participating in an industry program to collect and recycle these batteries at the end of their useful lives, when taken out of service within the United States and Canada.

The RBRC® program provides a convenient alternative to placing used nickel-metal hydride batteries into the trash or municipal waste, which may be illegal in your area.

VTech's participation in RBRC® makes it easy for you to drop off the spent battery at local retailers participating in the RBRC® program or at authorized VTech product service centers. Please call **1 (800) 8 BATTERY™** for information on Ni-MH battery recycling and disposal bans/restrictions in your area. VTech's involvement in this program is part of its commitment to protecting our environment and conserving natural resources.

**RBRC® is a registered trademark of Rechargeable Battery Recycling Corporation.**

# Appendix

## VTech Hospitality limited warranty program

VTech Communications, Inc., the manufacturer of VTech Hospitality Product ("Product"), warrants to the holder of a valid proof of purchase ("end user" or "you") that the Product and all accessories provided by VTech in the Product's package are free from defects in material and workmanship, pursuant to the following terms and conditions, when installed and used normally and in accordance with the Product's operating instructions. The limited warranty extends to the end user of this Product and applies only if such Product is purchased through a United States of America and/or Canadian distributor. The limited warranty period for this Product is determined based on the following:

### 5 Years – Analog Models

- All Classic Models – corded and cordless
- All Contemporary Models – corded and cordless
- All TrimStyle Models

### 2 Years – SIP Non-Display Models

- All Classic Models – corded and cordless
- All Contemporary Models – corded and cordless
- All TrimStyle Models

During the limited warranty period, VTech's authorized service representative will repair or replace, at VTech's option, without charge, a Product that is not free from defects in materials and workmanship. If VTech's authorized service representative repairs the Product, new or refurbished replacement parts may be used. If the Product is replaced, it may be replaced with a new or refurbished Product of the same or similar design. Repair or replacement of Product, at VTech's option, is the exclusive remedy.

The limited warranty period for the Product begins on the date that the end user takes possession of the Product. This limited warranty also applies to repaired or replacement Products for a period of either: (a) 90 days from the date the repaired or replacement Product is shipped to you; or (b) the time remaining on the original limited warranty as described above; whichever is longer.

This limited warranty does not cover:

1. Product or parts that have been subjected to misuse, accident, shipping or other physical damage, improper installation, abnormal operation or handling, neglect, inundation, fire, water or other liquid intrusion; or
2. Product that has been damaged due to repair, alteration or modification by anyone other than an authorized service representative of VTech; or
3. Product to the extent that the problem experienced is caused by signal conditions, network reliability or cable or antenna systems; or
4. Product to the extent that the problem is caused by use with non-VTech accessories; or
5. Product whose warranty/quality stickers, product serial numbers plates or electronic serial numbers have been removed, altered or rendered illegible; or
6. Product purchased, used, serviced, or shipped for repair from outside the United States or Canada, or used for non-approved commercial or institutional purposes (including but not limited to Products used for rental purposes); or
7. Product returned without valid proof of purchase; or
8. Charges or costs incurred by the end user, and risk of loss or damage, in removing and shipping the Product, or for installation or set up, adjustment of customer controls, and installation or repair of systems outside the unit.
9. Line cords or coil cords, plastic overlays, connectors, power adapters and batteries, if the Product is returned without them. VTech will charge the end user at then-current prices for each of the missing items.
10. NiCd or NiMH handset batteries, or power adapters, which, under all circumstances, are covered by a one (1) year warranty only.

Except as provided by applicable law, you assume the risk of loss or damage during transit and transportation and are responsible for delivery or handling charges incurred in the transport of Product(s) to the service location. VTech's authorized service representative will return repaired or replaced product under this limited warranty to you, transportation, delivery and handling charges prepaid. VTech assumes no risk for damage or loss of the Product in transit.

If the Product failure is not covered by this limited warranty, or proof of purchase does not meet the terms of this limited warranty, VTech will notify you and will request that you authorize the cost of repair and return shipping costs for the repair of Products that not covered by this limited warranty. You must pay for the cost of repair and return shipping costs for the repair of Products that are not covered by this limited warranty.

### Other limitations

This warranty is the complete and exclusive agreement between you and VTech. It supersedes all other written or oral communications related to this Product. VTech provides no other warranties for this Product, whether express or implied, oral or written, or statutory. The warranty exclusively describes all of VTech's responsibilities regarding the Product. No one is authorized to make modifications to this warranty and you should not rely on any such modification.

VTech's liability to end user hereunder shall not exceed the purchase price of the Product. In no event shall VTech be liable for any indirect, special, incidental, consequential, or similar damages (including, but not limited to lost profits or revenue, inability to use the product, or other associated equipment, the cost of substitute equipment, and claims by third parties) resulting from the use of this Product. Some states/provinces do not allow the exclusion or limitation of incidental or consequential damages, so the above limitation or exclusion may not apply to you.

This warranty gives you specific legal rights, and you also have other rights which vary from state to state or province to province.



# Appendix

## FCC, ACTA and IC regulations

### FCC Part 15

This equipment has been tested and found to comply with the requirements for a Class B digital device under Part 15 of the Federal Communications Commission (FCC) rules. These requirements are intended to provide reasonable protection against harmful interference in a residential installation. This equipment generates, uses and can radiate radio frequency energy and, if not installed and used in accordance with the instructions, may cause harmful interference to radio communications. However, there is no guarantee that interference will not occur in a particular installation. If this equipment does cause harmful interference to radio or television reception, which can be determined by turning the equipment off and on, the user is encouraged to try to correct the interference by one or more of the following measures:

- Reorient or relocate the receiving antenna.
- Increase the separation between the equipment and receiver.
- Connect the equipment into an outlet on a circuit different from that to which the receiver is connected.
- Consult the dealer or an experienced radio/TV technician for help.

Changes or modifications to this equipment not expressly approved by the party responsible for compliance could void the user's authority to operate the equipment.

This device complies with Part 15 of the FCC rules. Operation is subject to the following two conditions: (1) this device may not cause harmful interference, and (2) this device must accept any interference received, including interference that may cause undesired operation.

For cordless telephone only - Privacy of communications may not be ensured when using this telephone.

For cordless telephone only - To ensure safety of users, the FCC has established criteria for the amount of radio frequency energy that can be safely absorbed by a user or bystander according to the intended usage of the product. This product has been tested and found to comply with the FCC criteria. The handset may be safely held against the ear of the user. The telephone base shall be installed and used such that parts of the user's body other than the hands are maintained at a distance of approximately 20 cm (8 inches) or more.

This Class B digital apparatus complies with Canadian ICES-003.

### FCC Part 68 and ACTA

This equipment complies with Part 68 of the FCC rules and with technical requirements adopted by the Administrative Council for Terminal Attachments (ACTA). The label on the back or bottom of this equipment contains, among other things, a product identifier in the format US:AAAKXNANXXXX. This identifier must be provided to your telephone service provider upon request.

The plug and jack used to connect this equipment to premises wiring and the telephone network must comply with applicable Part 68 rules and technical requirements adopted by ACTA. A compliant telephone cord and modular plug is provided with this product. It is designed to be connected to a compatible modular jack that is also compliant. An RJ11 jack should normally be used for connecting to a single line and an RJ14 jack for two lines. See the installation instructions in the user's manual.

The Ringer Equivalence Number (REN) is used to determine how many devices you may connect to your telephone line and still have them ring when you are called. The REN for this product is encoded as the 6th and 7th characters following the US: in the product identifier (e.g., if ## is 03, the REN is 0.3). In most, but not all areas, the sum of all RENs should be five (5.0) or less. For more information, please contact your telephone service provider.

This equipment may not be used with Party Lines. If you have specially wired alarm dialing equipment connected to your telephone line, ensure the connection of this equipment does not disable your alarm equipment. If you have questions about what will disable alarm equipment, consult your telephone service provider or a qualified installer.

If this equipment is malfunctioning, it must be unplugged from the modular jack until the problem has been corrected. Repairs to this telephone equipment can only be made by the manufacturer or its authorized agents. For repair procedures, follow the instructions outlined under **VTech Hospitality limited warranty program** in the user's manual.

If this equipment is causing harm to the telephone network, your telephone service provider may temporarily discontinue your telephone service. Your telephone service provider is required to notify you before interrupting service. If advance notice is not practical, you will be notified as soon as possible. You will be given the opportunity to correct the problem and your telephone service provider is required to inform you of your right to file a complaint with the FCC. Your telephone service provider may make changes in its facilities, equipment, operation, or procedures that could affect the proper functioning of this product. Your telephone service provider is required to notify you if such changes are planned.

If this product is equipped with a corded or cordless handset, it is hearing aid compatible.

If this product has memory dialing locations, you may choose to store emergency telephone numbers (e.g., police, fire, medical) in these locations. If you do store or test emergency numbers, please:

Remain on the line and briefly explain the reason for the call before hanging up.

Perform such activities in off-peak hours, such as early morning or late evening.

When the adjunct is used with a leased system, permission of the owner of the equipment must be obtained for connection of the adjunct because modification of the host system is often required.

This product can only be connected to the host equipment and never directly to the network.

### Industry Canada

Operation is subject to the following two conditions: (1) this device may not cause harmful interference, and (2) this device must accept any interference, including interference that may cause undesired operation.

The term "IC:" before the certification/registration number only signifies that the Industry Canada technical specifications were met. This product meets the applicable Industry Canada technical specifications.

# Appendix

## Maintenance

### Taking care of your telephone

Your telephone contains sophisticated electronic parts, so it must be treated with care.

### Avoid rough treatment

Place the handset down gently. Save the original packing materials to protect your telephone if you ever need to ship it.

### Avoid water

Your telephone can be damaged if it gets wet. Do not use the handset outdoors in the rain, or handle it with wet hands. Do not install the telephone base near a sink, bathtub or shower.

### Electrical storms

Electrical storms can sometimes cause power surges harmful to electronic equipment. For your own safety, take caution when using electrical appliances during storms.

### Cleaning your telephone

Your telephone has a durable plastic casing that should retain its luster for many years. Clean it only with a soft cloth slightly dampened with water or mild soap. Do not use excess water or cleaning solvents of any kind.

Remember that electrical appliances can cause serious injury if used when you are wet or standing in the water. If the telephone base should fall into the water, DO NOT RETRIEVE IT UNTIL YOU UNPLUG THE POWER CORD AND/OR TELEPHONE LINE CORD FROM THE WALL. Then remove the telephone by the unplugged cords.



# Appendix

## Technical specifications

### Analog corded lobby - A2100

Power requirement	Line powered 24V or 48V
Size	Telephone base: 8.03 x 5.98 x 3.74 in (204 x 152 x 95 mm) Corded handset: 8.39 x 1.85 x 1.58 in (213 x 47 x 40 mm)

### Analog corded 1-line/2-line - A2210/A2220

Power requirement	Line powered 24V or 48V
Message waiting signal	Steady/periodic high voltage pulse or periodic low voltage pulse
Speed Dial memory	Telephone base: up to 10 memory locations; up to 16 digits
Size	Telephone base: 8.03 x 5.98 x 3.74 in (204 x 152 x 95 mm) Corded handset: 8.39 x 1.85 x 1.58 in (213 x 47 x 40 mm)

### Analog cordless 1-line - A2410/CTM-A2411

### Analog cordless 2-line - A2420/CTM-A2421

Frequency Control	Crystal controlled PLL synthesizer
Transmit frequency	Handset: 1921.536-1928.448 MHz Telephone base: 1921.536-1928.448 MHz
Channels	5
Nominal effective range	Maximum power allowed by FCC and IC. Actual operating range may vary according to environmental conditions at the time of use.
Power requirements	Handset: 2.4V Ni-MH battery Telephone base: 6V DC @600mA
Message waiting signal	Steady/periodic high voltage pulse, periodic low voltage pulse, reverse polarity, FSK, Siemens and/or Panasonic
Speed Dial memory	Telephone base: up to 10 memory locations; up to 32 digits
Size	Telephone base: 8.03 x 6.06 x 3.78 in (204 x 154 x 96 mm) Handset: 8.39 x 1.89 x 1.65 in (213 x 48 x 42 mm)

### Analog corded/cordless 1-line - CTM-A2510

Frequency Control	Crystal controlled PLL synthesizer
Transmit frequency	Handset: 1921.536-1928.448 MHz Telephone base: 1921.536-1928.448 MHz
Channels	5
Nominal effective range	Maximum power allowed by FCC and IC. Actual operating range may vary according to environmental conditions at the time of use.
Power requirements	Handset: 2.4V Ni-MH battery Telephone base: 6V DC @600mA Charging stand: 6VDC @400mA
Message waiting signal	Steady/periodic high voltage pulse, periodic low voltage pulse, reverse polarity, FSK, Siemens and/or Panasonic
Speed Dial memory	Telephone base: up to 10 memory locations; up to 32 digits
Size	Telephone base: 8.03 x 6.06 x 3.78 in (204 x 154 x 96 mm) Handset: 8.39 x 1.89 x 1.65 in (213 x 48 x 42 mm) Charging stand: 3.78 x 2.80 x 4.29 in (96 x 71 x 109 mm)

## Appendix

### Technical specifications

#### Analog cordless charging base - C4000

Power requirement	6V DC @600mA
Size	8.11 x 3.70 x 2.87 in (206 x 94 x 73 mm)

#### Analog cordless charging stand - C4010

Power requirement	6V DC @600mA
Size	3.78 x 2.80 x 4.29 in (96 x 71 x 109 mm)

#### Analog cordless 1-line accessory handset - C4100/C4101

#### Analog cordless 2-line accessory handset - C4200/C4201

Frequency Control	Crystal controlled PLL synthesizer
Transmit frequency	1921.536-1928.448 MHz
Channels	5
Nominal effective range	Maximum power allowed by FCC and IC. Actual operating range may vary according to environmental conditions at the time of use.
Power requirement	2.4V Ni-MH battery
Message waiting signal	Steady/periodic high voltage pulse, periodic low voltage pulse, reverse polarity, FSK, Siemens and/or Panasonic
Speed Dial memory	Telephone base: up to 10 memory locations; up to 32 digits
Size	8.39 x 1.89 x 1.65 in (213 x 48 x 42 mm)

# Index

- A**  
A2100 3, 13–14, 23–24, 27  
A2210 4, 13–14, 23–24, 28  
A2220 5, 13–14, 23–24, 29–30  
A2310 6, 15–16, 23–24, 31–32  
A2410 7, 17–19, 25–26, 32–34  
A2420 8, 17–19, 25–26, 35–37  
About cordless telephones 42  
Answer an intercom call 34, 36  
Autodial key cancellation 24, 26  
Autodial key programming 24, 26
- B**  
Battery charging 19, 22  
Battery installation 19, 22
- C**  
C4000 9, 20  
C4010 10, 21  
C4100 11, 22  
C4200 12, 22  
Call waiting 28, 29, 31, 33, 36  
Cardiac pacemakers 42  
Charging cordless handset 19, 22  
Checklist 1–2  
Conference call 30, 37
- D**  
Data port 30, 37  
Default settings 23, 25  
Deregister a handset 19, 22
- E**  
End a call 27, 28, 29, 31, 32, 35  
End a conference call 30, 37  
End an intercom call 34, 37
- F**  
FCC, ACTA and IC regulations 44  
Find handset 34, 37  
Flash 23, 25, 28, 29, 31, 33, 36
- H**  
Handset battery 38  
Handset battery installation 19, 22  
Handset battery replacement 19, 22  
Handset charging 19, 22  
Handset deregistration 19, 22  
Handset registration 19, 22  
Handset speakerphone 32, 35  
Hold 25, 28, 30, 33, 36
- I**  
Important safety instructions i  
Initiate a conference call 30, 37  
Initiate an intercom call 34, 36  
Installation 13–22  
Intercom 34, 36–37
- J**  
Join a call 28, 29, 31, 32, 35
- L**  
Layout 3–12  
Limited warranty 43  
Listening volume 27, 28, 29, 31, 33, 36
- M**  
Maintenance 45  
Mute 28, 30, 31, 33, 36
- O**  
Operating range 42  
Operation 27–37
- P**  
Pacemaker patients 42  
Paging handset 34, 37  
Parts checklist 1–2  
Place a call 27, 28, 29, 31, 32, 35
- R**  
Range 42  
Receive a call 27, 28, 29, 31, 32, 35  
Redial 33, 36  
Register a handset 19, 22  
Register a handset to another telephone base 19, 22  
Replace a handset battery 19, 22  
RF transmission power 25  
Ringer tone 23, 25  
Ringer volume 23, 25, 27, 28, 29, 31, 33, 36
- S**  
Safety instructions i  
Settings 23–26  
Share a call 28, 29, 31, 32, 35  
Speakerphone 28, 29, 32, 35  
Speed Dial keys 24, 26
- T**  
Technical specifications 46–47  
Telephone layout 3–12  
Telephone operation 27–37  
Telephone settings 23  
Terminate a conference call 30, 37  
Troubleshooting 39–41
- V**  
Voicemail voltage detection 24, 26  
Volume 23, 25, 27, 28, 29, 31, 33, 36
- W**  
Wall mount 14, 16, 18, 20  
Warranty 43

**vtech**<sup>®</sup>

VTECH TELECOMMUNICATIONS LTD.

A member of THE VTECH GROUP OF COMPANIES.

Distributed in the U.S.A. by VTech Communications, Inc., Beaverton, Oregon 97008.  
Distributed in Canada by VTech Technologies Canada Ltd., Richmond, B.C. V6W 1L5.

VTech is the registered trademark of VTech Holdings Limited.

Copyright © 2011 for VTECH TELECOMMUNICATIONS LTD.

All rights reserved. Printed in China.

91-003835-030-100