

Document Title	Document No.	Version
PUB XRPAD 4336 - USER MANUAL	25574	02
This document is confidential and proprietary to PerkinElmer		

The following pages contain the “User Manual”

REVISION	SECTIONS CHANGED	ORIGINATOR	CN	DATE
1.0	Initial release	S. Arnold	4694	2013-04-26
2.0	Safety, Cleaning, Declaration, LBP, IPU, all sections with AP-Mode	S. Arnold		

XRpad™ 4336

Digital X-Ray Cassette Detector



Before using the detector, be sure to read this manual thoroughly along with any other manuals for the software and other system components. Keep this manual where it is easily accessible.

PLEASE NOTE

- ▶ To avoid personal injury or product damage, read the manual and all accompanying information carefully before installation or use of the **XRpad™ 4336** detector.
- ▶ The detector is intended for use by trained and qualified professional personnel who are knowledgeable with the use of x-ray detectors, x-ray systems, and electrical equipment.
- ▶ The user is responsible for using and maintaining the detector according to prescribed installation, usage, maintenance, handling and storage specifications. To keep the detector and its accessories in a safe and proper condition, only trained and qualified professional person(s) shall be in charge of maintenance.
- ▶ X-ray imaging, image processing, image acquisition, and data storage must be performed in accordance with the applicable laws. The user is also responsible for compliance to laws pertaining to the privacy of image data.
- ▶ In no event is PerkinElmer liable for direct, indirect, or consequential injury, damage, or loss of equipment operation time or image data arising from the use of the x-ray detector, its components, and or accessories.



Protection against Ionizing Radiation

- ▶ Exposure of any part of the human body to x-radiation may be harmful to health. Whenever x-ray equipment or radioactive sources are in use, appropriate safety precautions and measures shall be instituted, and all regulatory requirements must be met. It is the responsibility of the x-ray system installer, operator, and user to comply with applicable requirements.
- ▶ The x-ray detector is intended to be installed, maintained, and used by qualified professional personnel who are trained and qualified in the installation, maintenance, and use of x-ray equipment.
- ▶ The x-ray detector does not contain a primary barrier for x-rays or Gamma rays. The x-ray system installer or manufacturer must provide the necessary protection based on the x-ray system's intended use.
- ▶ For portable applications the x-ray system installer or manufacturer must provide the necessary training for the operator to protect them self, the patient, or surrounding persons.





FOR YOUR SAFETY

To avoid personal injury or product damage, read this manual and all accompanying information carefully before handling, installing, or using the **XRpad™ 4336** detector. Follow all instructions, warnings, and cautions in this manual and all warnings and cautions printed on the warning label. Ignoring instructions, warnings, or cautions in the handling, installing, or using of the detector may result in personal injury, death, or product damage. Keep this manual for future reference.

Meaning of Caution Signs

 DANGER	This indicates a potentially hazardous situation which, if ignored, <u>will</u> result in severe personal injury, death, or substantial product damage.
 WARNING	This indicates a potentially hazardous situation which, if ignored, <u>may</u> result in severe personal injury, death, or substantial product damage.
 Caution	This indicates a potential hazardous situation which, if ignored, may result in minor or moderate personal injury or damage to the product.
Note:	This emphasizes or supplements important information about the main text.

Installation and Environmental Use

 WARNING	Do not operate the x-ray detector in or around flammable gases, gas mixtures, liquids, chemicals, or other substances. Ignoring this warning may result in explosion, fire, or electric shock, which may result in severe personal injury, death, or substantial product damage.
 Caution	Do not operate the x-ray detector in a location with the following conditions. <ul style="list-style-type: none"> • Close to fluid or places where fluid is used • Close to heat sources, such as a heater • High temperature environment • High humidity environment • High condensation environment • Extreme cold environment • Dusty environment • Salty or sulphurous environment • Near a vibrating environment Ignoring this caution may result in personal injury or damage to the product.
 WARNING	Do not connect the x-ray detector to any component or accessory, other than manufacturer's specified components and accessories. Ignoring this warning may result in explosion, fire, or electric shock, which may result in severe personal injury, death, or substantial product damage.
 WARNING	Do not modify or alter the x-ray detector, its components, or accessories. Ignoring this warning may result in explosion, fire, or electric shock, which may result in severe personal injury, death, or substantial product damage.













Interface and Power Unit and Cables

<p>⚠ WARNING</p>	<p>Be sure to turn OFF the power of the XRpad™ 4336 detector, including turning off the power supply and or removal of the XRpad™ LBP (Lithium Battery Pack) before servicing, maintaining, connecting, or disconnecting the cables or accessories.</p> <p>Do not touch the power supply, Lithium Battery Pack, detector, cable, connector, or any other electrical component or equipment with wet hands. Ignoring this warning may cause electrical shock, which may result in severe personal injury, death, or substantial product damage.</p>
<p>⚠ WARNING</p>	<p>Disconnect the cables by pulling on the connector and not the cable itself. Ignoring this warning may cause electrical shock, which may result in severe personal injury, death, or substantial product damage.</p>
<p>⚠ WARNING</p>	<p>Do not modify the cables or subject the cable to external stress or damage. Avoid placing anything heavy, including the detector, on the cable, stepping on the cable, pulling the cable, or subjecting the cable to excessive bending or bundling. Ignoring this warning may cause cable failure resulting in electrical shock, which may result in severe personal injury, death, or substantial product damage.</p>
<p>⚠ WARNING</p>	<p>Do not turn ON the power supply or x-ray detector when condensation is formed on the system. Ignoring this warning may cause electrical shock, which may result in severe personal injury, death, or substantial product damage.</p>



Handling

<p>⚠ WARNING</p>	<p>Never disassemble, modify, or alter the x-ray detector, its components, Lithium Battery Pack, battery charger, or accessories. Ignoring this warning may cause electrical shock, and/or unknown hazards, which may result in severe personal injury, death, or substantial product damage.</p>
<p>⚠ WARNING</p>	<p>Do not touch the interface and power unit, or cable and the patient at the same time. Do not let the patient touch the interface and power unit, or cable. Ignoring this warning may cause electrical shock and or unknown hazards, which may result in severe personal injury, death, or substantial product damage.</p>
<p>⚠ Caution</p>	<p>Place the x-ray detector horizontally on a flat, stable surface. If the detector is placed vertically or in any tilted position, the detector must be securely placed in the Bucky tray. Ignoring this caution may result in personal injury or damage to the product.</p>
<p>⚠ Caution</p>	<p>Do not exceed the maximum load weight of 150 kg distributed around the overall surface of the detector (Uniform Load).</p>
<p>⚠ Caution</p>	<p>Do not exceed the maximum load weight of 100 kg distributed on an area of 40 mm in a diameter of the detector surface (Local Load).</p>
<p>⚠ Caution</p>	<p>Do not drop the detector. If the detector is dropped remove the detector from service and inform your establishment safety representative immediately to verify or re-validate the proper function of the detector prior to resuming use of the detector. Further use under abnormal conditions may result in severe personal injury, death, or substantial product damage.</p>

Battery

<p> WARNING</p>	<p>Do not use the XRpad™ LBP (Lithium Battery Pack) if the casing is broken or if it emits an unusual odor, smoke, or excessive heat, or if it leaks any substance. Avoid contact with any substance seeping from the battery pack. If any fluid touches your skin or eyes, wash the affected area with clean running water and immediately seek medical attention.</p>
<p> WARNING</p>	<p>The cells within the XRpad™ LBP contain toxic substances. Do not attempt to open the battery packs. Do not insert any object into the battery pack or use any device to pry at the battery pack casing. Attempting to open the XRpad™ LBP casing will damage the casing which could cause the LBP to release toxic and harmful substances, causing injuries such as electric shock, burns, or cause a fire, and will render the pack unusable.</p>
<p> WARNING</p>	<p>Observe and follow all safety information in this manual and on the warning label found on the XRpad™ LBP. Ignoring warning may result in personal injury or damage to the product.</p>
<p> WARNING</p>	<p>Use only charging devices approved by PerkinElmer and never attempt to bypass or override their charging protection circuits.</p>
<p> WARNING</p>	<p>Keep out of reach of children</p>
<p> WARNING</p>	<p>Remove the XRpad™ LBP if the XRpad™ 4336 detector is not likely to be used for some time.</p>
<p> WARNING</p>	<p>Do not submerge the XRpad™ LBP in water or other liquid.</p>
<p> WARNING</p>	<p>Do not charge the XRpad™ LBP near flammable materials</p>
<p> WARNING</p>	<p>Do not connect the XRpad™ LBP to an electrical outlet directly, or to any other electrical source not described in the manual.</p>
<p> WARNING</p>	<p>Do not drop or hit the battery against hard objects, since this may cause damage to the LBP and risk release of the battery toxic and harmful substances, causing injuries such as electric shock, burns, or cause a fire, and will render the XRpad™ LBP unusable.</p>
<p> WARNING</p>	<p>Do not use the Battery Charger in the patient environment</p>
<p> Caution</p>	<p>Risk of explosion, personal injury, or damage to product if the Battery XRpad™ LBP is replaced by non-OEM approved component</p>

When a Problem Occurs

 WARNING	<p>If any abnormal condition is evident such as smoke, fumes, or strange sounds, unplug the power supply from the AC outlet, and inform your establishment safety representative immediately to contact your dealer, distributor, or PerkinElmer. Further use under abnormal conditions may result in severe personal injury, death, or substantial product damage.</p>
 WARNING	<p>When liquid has been spilled into, or on any part of the x-ray detector, power supply, Lithium Battery Pack, battery charger, or when the detector, its component, or accessory is dropped, unplug the power supply from the AC outlet, and inform your establishment safety representative immediately to contact your dealer, distributor, or PerkinElmer. Further use under abnormal conditions may result in severe personal injury, death, or substantial product damage.</p>

Maintenance and Inspection





 WARNING	<p>Turn OFF the power of the detector when the inspections indicated in this manual are going to be performed. Ignoring this warning may result in electric shock, which may result in severe personal injury, death, or substantial product damage.</p>
 WARNING	<p>When the detector system is going to be cleaned, turn OFF the XRpad™ 4336, remove the XRpad™ LBP, and or unplug the power supply cable from the AC outlet. Never use thinner, benzine, acetone, or other flammable cleaning agents. Ignoring this warning may result in explosion, fire, or electric shock, which may result in severe personal injury, death, or substantial product damage.</p>
 WARNING	<p>The XRpad™ 4336 must be repaired by PerkinElmer authorized personnel only. Ignoring this warning may result in explosion, fire, electric shock, or unknown hazards, which may result in severe personal injury, death, or substantial product damage.</p>
 Caution	<p>Follow the manufacturer's recommendation for inspecting the detector before use.</p>

Table of Contents

1	Scope	9
2	Intended Use.....	9
3	Audience	9
4	Abbreviations	9
5	References	9
6	Definition of Symbols.....	10
7	Regulations	11
8	Description of the XRpad™ 4336.....	12
8.1	Detector Overview	12
8.2	Main Detector Specification.....	13
8.3	Environmental Considerations	13
8.4	Detector Dimensions	14
8.5	Detector Accessories	15
8.5.1	Rechargeable Lithium Battery Pack XRpad™ LBP	16
8.5.2	Interface and Power Unit XRpad™ IPU	19
8.6	Minimum Computer Requirements	21
8.7	Operation.....	21
8.7.1	Wired Detector Operation	22
8.7.2	Wireless Detector Operation.....	23
8.7.3	Before Using the X-ray Detector	23
8.7.4	Power On the XRpad™ 4336 Detector	24
8.7.5	Power Down the XRpad™ 4336	24
8.7.6	General Workflow	25
9	Inspection and Maintenance.....	26
9.1	Daily Inspection	26
9.1.1	Before Turning ON the Power	26
9.1.2	After Turning ON the Power.....	26
9.1.3	After Turning OFF the Power	27
9.2	Monthly Inspection.....	27
9.3	Yearly Inspection.....	28
9.4	Calibration	28
9.5	Cleaning the Detector.....	28
10	After-Sales Service for PerkinElmer Products.....	29
11	Disposal.....	29
12	Declarations.....	30
12.1	Guidance and Manufacturer’s Declaration	30

12.2	Industry Canada statement:.....	33
12.3	Declaration of Conformity for European Union (and EEA).....	34
12.4	Federal Communication Commission Interference Statement (US).....	35

List of Figures

Figure 1	Detector Overview (Front View).....	12
Figure 2	Detector Dimensions.....	14
Figure 3	Patient Vicinity.....	15
Figure 4	Rechargeable Lithium Battery Pack XRpad™ LBP.....	16
Figure 5	Removal of the XRpad™ LBP.....	18
Figure 6	XRpad™ IPU Overview.....	19
Figure 7	Wired Connection of the XRpad™.....	22
Figure 8	Wireless Connection of the XRpad™.....	23

List of Tables

Table 1	Abbreviations.....	9
Table 2	References.....	9
Table 3	Symbols.....	10
Table 4	Standards and Regulations.....	11
Table 5	Detector Overview.....	12
Table 6	Main Detector Specification.....	13
Table 7	Environmental Considerations.....	13
Table 8	Accessories for the XRpad™ 4336.....	15
Table 9	Specification of the XRpad™ LBP.....	16
Table 10	XRpad™ IPU Overview.....	19
Table 11	Specification of the XRpad™ IPU.....	20
Table 12	Guidance and Manufacturer’s Declaration of Electromagnetic Emissions.....	30
Table 13	Guidance and Manufacturer’s Declaration of Electromagnetic Immunity.....	30
Table 14	Recommended Separation Distance between Portable and Mobile RF-Communication Equipment and the X-Ray Detector.....	31
Table 15	Guidance and Manufacturer’s Declaration of Electromagnetic Immunity (Portable Equipment).....	31

1 Scope

This document describes design elements and respective interfaces for the **XRpad™ 4336** detector. Applicable mechanical, electronic, and software interfaces are addressed.

PerkinElmer digital X-ray Flat Panel Detectors and accessories are designed to be integrated into products by x-ray system manufacturers. Manufacturers are responsible for qualifying, validating, and certifying their products for their intended uses and meeting all applicable regulatory requirements.

2 Intended Use

The **XRpad™ 4336** detector, when used with a radiographic imaging system, is intended for use in generating radiographic images of human anatomy for diagnostic x-ray procedures, wherever conventional screen-film (SF), digital radiography (DR), or computed radiography (CR) systems may be used. It is not intended for mammographic use.

Final application and intended use is based on the completed x-ray system design. It is the responsibility of the x-ray system manufacturer to confirm the efficacy and compliance of the x-ray system for its intended use, inclusive of the detector. The Digital Radiography Software referred to in this manual is medical imaging software for radiography, which is typically supplied by the x-ray system manufacturer or third-party provider and is not part of the PerkinElmer **XRpad™ 4336** detector.

3 Audience

This document is for professional users from Original Equipment Manufacturers (OEMs) and system installers who are responsible for installing the **XRpad™ 4336** detector into an x-ray system.

4 Abbreviations

Table 1 Abbreviations

Abbreviation	Description
FoV	Field of View
fps	Frames per second
I/F	Interface
IP	Internet Protocol
LED	Light Emitting Diode
SF	Screen Film
CR	Computed Radiography
DR	Digital Radiography
OEM	Original Equipment Manufacturer

5 References

Table 2 References

	Document Name	Document #
1	XRpad™ LBC Reference Manual	620-005121-002
2	XRpad™ LBP Reference Manual	620-005149-001
3	Digital Radiography Software	Supplied by OEM

6 Definition of Symbols

Table 3 Symbols

Symbol	Description
	This Way Up
	Handle with Care
	Keep Dry
	Reusable
	Disposal (WEEE)
	Refer to Instruction Manual
	Caution
	Manufacturer's name and address.
	Date of Manufacture, YYYY=Year, MM=Month
	Authorized representative in the European Community
	Material Number
	Serial Number
	AC Input
	D.C. Voltage
	Temperature Limitation
	Relative Humidity Limitation
	Potential Equalization
	Functional Earth Connection
	Protection Class I
	Protection Class II
	EMI Sensitive Component
	Battery charge condition <ul style="list-style-type: none"> • Battery Charged (> 75%) • Battery ¾ (<= 75%) • Battery Half (<= 50%) • Battery Low (<= 25%) • Battery Empty (<= 10%) • No Battery
	Wireless Connectivity
	LAN Connection / Missing LAN Connection
	Trigger Connection
	Push Button
	Power Switch
	Do not crush
	Do not expose to fire
	Keep away from children.
	UL Recognized component mark for US and Canada
	Conformity European - Hereby, PerkinElmer Inc., declares that this XRpad™ 4336 is in compliance with the essential requirements and other relevant provisions of Directive 1999/5/EC and 93/42/EEC.

7 Regulations

The **XRpad™ 4336** is designed to be compliant with the standards and/or regulations detailed in Table 3. Manufacturer’s certifications to standards and regulations are valid only if the original accessories (as listed in Table 7) are used according to prescribed instructions. Product certification and warranty are rendered void if any modification or alteration to the product is made, or any instruction, warning, or caution is not followed.

Table 4 Standards and Regulations

Standards and Regulations	Description
ANSI/AAMI Std ES60601-1:2005	Medical electrical equipment Part 1: General Requirements for Basic Safety and Essential Performance
IEC 60601-1:2005, EN 60601-1:2006	General Requirements for Basic Safety for Medical Electrical Equipment
IEC/EN 60601-1-2:2007	Medical Electrical Equipment, Part 1-2: General Requirements for Safety and Essential Performance - Collateral Standard: Electromagnetic Compatibility
CAN CSA C22.2 No 60601-1 08	Medical electrical equipment Part 1: General Requirements for Basic Safety and Essential Performance
FCC Part 15 subpart C	Radio Frequency exposure
ETSI EN 301 893 V.1.7.1 (2012)	Broadband Radio Access Networks (BRAN); 5 GHz high performance RLAN
ISO 10993-5	Biological evaluation of medical devices – Part 5: Tests for in vitro cytotoxicity
ISO 10993-10	Biological evaluation of medical devices - Part 10: Tests for irritation and skin sensitization
ISO 4090	Photography – Medical Radiographic Cassettes/Screens/Films and Hard-Copy Imaging Films – Dimensions and Specifications
EN 60529:1991	Degrees of Protection Provided by Enclosures (IP-code)

8 Description of the XRpad™ 4336

8.1 Detector Overview

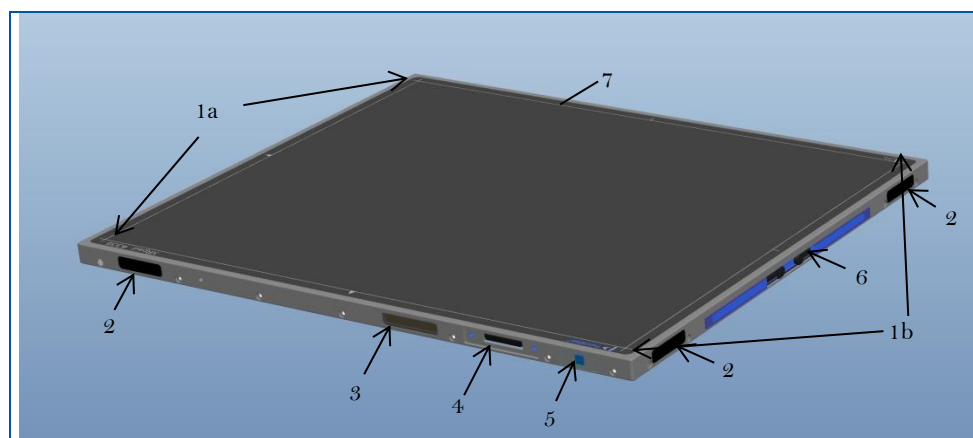

Figure 1 Detector Overview (Front View)

Table 5 Detector Overview

1	Active Area with Markers; a) Top b) Bottom Side of the Image	
2	Antenna; make sure that they is not obstructed	
3	Display	
	Battery charge condition	<ul style="list-style-type: none"> • Battery Charged (> 75%) • Battery ¾ (<= 75%) • Battery Half (<= 50%) • Battery Low (<= 25%) • Battery Empty (<= 10%) • No Battery
	Wireless Connectivity	
	LAN Connection/ No LAN Connection	
4	Power & communication tethered connector	
5	Push Button with a LED (blue light)	
	Short press & LED OFF	Power ON & LED flashes fast
	Short press & LED flashes	Switch on of the Display
	Long Press (4s) & LED flashes	Power OFF
	LED Status (blue light)	
	LED OFF	Detector is not powered
	LED flashing fast	Detector is powering on
LED flashing slowly	Detector is in IDLE Mode	
LED ON	Detector is Ready	
6	Battery Insert	
7	Detector Label	

8.2 Main Detector Specification

Table 6 Main Detector Specification

Purpose	General Radiography
Grey Scale	14-bit, 16384 gray values / 16-bit, 65535 gray values ¹
Transfer Time	
Wired:	500 ms (wired)
Wireless:	3000 ms (wireless)
Maximum Frame Time	5000 ms +/- 1ms
Scintillator	CsI:Tl (direct deposition on aSi photodiodes)
Radiation Energy	40 kV – 160kV
Size	384 mm x 460 mm x 15 mm (ISO 4090)
Weight	3.7 kg
Housing	Solid Carbon-Fiber Front & Back
Interface	Wireless data I/F (802.11n @ 5GHz) Gigabit Ethernet (1000BASE-T) via power & communication tether
Active pixel Number	3530 x 4290
Pitch	100 μm
Total Area	355 mm x 430 mm
Power Rating	
Wired:	Powered by the Interface & Power Unit XRpad™ IPU
Wireless:	Powered by the battery pack XRpad™ LBP

8.3 Environmental Considerations

 WARNING	<p>Storage or use of the detector and power supply in environmental conditions outside the specification may cause fire, electrical shock, and unknown hazards, which may result in severe personal injury, death, or substantial product damage or reduced product lifetime.</p>
--	---

Table 7 Environmental Considerations

Environment	Transportation/Storage ³	Operation
Ambient Temperature⁴ (30d/365d)	-10° to +55°C / 0° to +55°C	+10° to +35°C
Relative Humidity	5% to 90%	30% to 70%
Atmospheric Pressure	700 to 1250 hPa	800 to 1250 hPa
Vibration⁵(EN60068-2-6)	5m ² /s ³ (10 Hz to 100 Hz) 1m ² /s ³ (100 Hz to 2000 Hz)	0.5m ² /s ³ (10 Hz to 100 Hz) 0.1m ² /s ³ (100 Hz to 2000 Hz)
Shock⁵(EN 60068-2-27)	20g (duration 11 ms)	2g (duration 11ms)
Ingress protection rating	IP42 rated (protection against particles > 1mm and Splashing water)	

¹Firmware depending

³In original transport container for 365 days

⁴Temp. Gradient: max 4.5 K/hour

⁵Image quality cannot be guaranteed during shock or vibrations.

8.4 Detector Dimensions

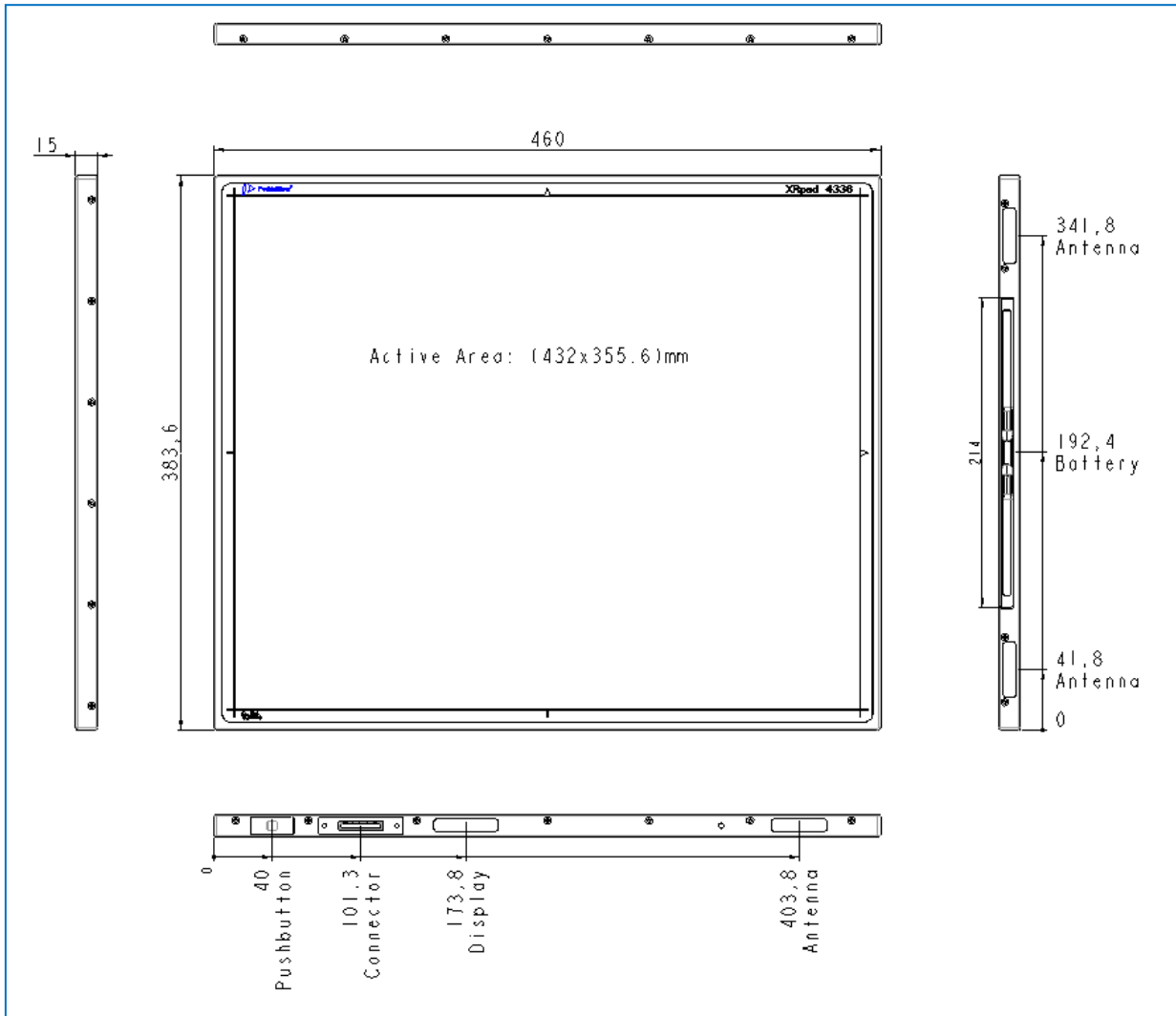

Figure 2 Detector Dimensions

8.5 Detector Accessories

The XRpad™ 4336 shall only be used with its approved OEM Lithium Battery Pack XRpad™ LBP, cables and connectors. Product certification and warranty are rendered void if any modification or alteration to the product is made, or any instruction, warning, or caution is not followed. The wired or wireless connection must be applied to a workstation. It is important that the detector is not directly connected to the clinical network. Connection of the detector directly with the clinical computer network may disturb the IT environment. The imaging workstation and the WiFi access point must comply with IEC 60601-1 or IEC 60950-1.

Table 8 Accessories for the XRpad™ 4336

PerkinElmer Article No.	Description
95510920H	XRpad™ LBP(Lithium Battery Pack)
95510921H	XRpad LBC (Lithium Battery Charger)
95510922H	XRpad™ IPU (Interface Power Unit)
95510931H	XRpad™ LPT Detector Cable, 10m/33ft
95510923H	XRpad™ Protective Insert
95510020H	XRpad™ 4336 Connector Cover Set
95510256H	Trigger Cable 16.5FT / 5M
95510257H	Trigger Cable 65,5FT / 20M
95510621H	XRD GigE Interface Cable 25ft - 7.6m
95510622H	XRD GigE Interface Cable 50ft - 15.25m
95510623H	XRD GigE Interface Cable 100ft - 30.5m

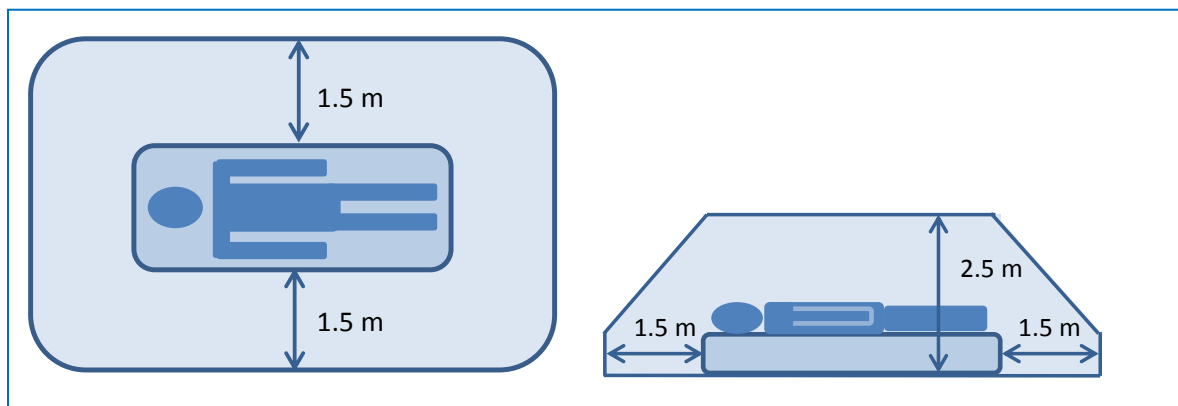

Figure 3 Patient Vicinity

⚠ WARNING	Connection of the detector directly with the clinical computer network may disturb the IT environment.
⚠ WARNING	Do not use any non-medical equipment such as the Battery Charger, WiFi access point in the patient environment.

8.5.1 Rechargeable Lithium Battery Pack XRpad™ LBP

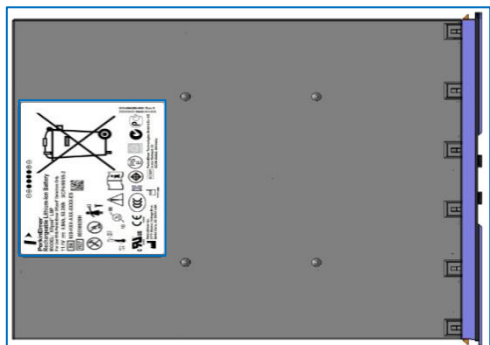

Figure 4 Rechargeable Lithium Battery Pack XRpad™ LBP

 WARNING	<p>Storage or use of the Lithium Battery Pack (XRpad™ LBP) environmental conditions outside the specification may cause fire, electrical shock, and unknown hazards, which may result in severe personal injury, death, or substantial product damage or reduced product lifetime.</p>
--	--

Table 9 Specification of the XRpad™ LBP

Electrical specification	
Voltage	11.1V
Amp-hours	4.8Ah
Capacity	53.3Wh
Charging time	Approximately 3h
Temperature ranges	
Operating (discharging)	-10°C to 60°C
Charging	0°C to 42°C
Transportation	-20°C to 45°C
Storage	15°C to 35°C
Ingress protection rating	IP54
Lifetime	
Charge-discharge cycles	500 cycles under normal usage conditions Battery should be discarded on or before 5 years from date of manufacture.

8.5.1.1 Lithium Battery Pack Charging Instructions

- A new rechargeable Lithium Battery Pack (XRpad™ LBP) comes in a discharged condition and must be charged using the dedicated XRpad™ LBC battery charger before use. Please refer to the XRpad™ LBC battery charger manual for more details.
- The XRpad LBC will charge the XRpad™ LBP to usable condition within three hours depending upon the initial state of charge. The XRpad™ 4336 detector when connected to the XRpad Interface and Power Unit (XRpad™ IPU) can also charge the XRpad™ LBP, but the charge rate is much slower
- A charged battery will eventually lose its charge if unused. Upon initial use (or after a prolonged storage period) the battery may require three to four charge/discharge cycles before achieving maximum capacity.
- The actual battery run-time will depend upon the power demands made by the XRpad™ 4336 detector.
- The XRpad™ LBP is keyed and can only be inserted into the XRpad™ LBC charger in one orientation.

- Check to ensure the **XRpad™ LBP** is clean, dry and free of foreign contamination or debris. If cleaning is necessary, refer to section 7.5.1.6 for cleaning instructions.
- Ensure the **XRpad™ LBC Charger** is powered on.
- Orient the **XRpad™ LBP** to match the orientation of the **XRpad LBC Charger**, and insert the **XRpad™ LBP** firmly into the **XRpad LBC charger**. Keep the **XRpad™ LBP** in the **XRpad™ LBC charger** until all the four charge status LEDs maintain a solid green, indicating a full charge. To remove, lift the battery out of the **XRpad™ LBC charger**.

 WARNING	Do not drop or hit the XRpad™ LBP against hard objects, as this may cause a risk of damage to the XRpad™ LBP which may result in exposure to the corrosive cell contents, fire or explosion.
--	--

8.5.1.2 XRpad Lithium Battery Pack Installation

When there is no **XRpad™ LBP** in the detector or to change a used **XRpad™ LBP**, perform **XRpad™ LBP** removal prior to installing the **XRpad™ LBP**.

 Caution	Risk of explosion, personal injury, or damage to product if the Battery XRpad™ LBP is replaced by non-OEM approved component.
--	--

- Ensure the **XRpad™ 4336** detector is fully supported prior to performing this task to avoid drop or slip of the **XRpad™ 4336** detector, or **XRpad™ LBP**.
- Check to ensure the battery compartment of the **XRpad™ 4336** detector is clean, dry and free of foreign contamination or debris. If cleaning is necessary, refer to section 8.1.5 for cleaning instructions.
- Check to ensure the **XRpad™ LBP** is clean, dry and free of foreign contamination or debris. If cleaning is necessary, refer to section 7.5.1.6 for cleaning instructions.
- The **XRpad™ LBP** is keyed and can only be inserted into the **XRpad™ 4336** detector in one orientation.
- Align the orientation of the **XRpad™ LBP** to match the orientation required on the **XRpad™ 4336** detector.
- Insert the charged **XRpad™ LBP** into the **XRpad™ 4336** detector in the corresponding orientation and gently press on the end cap until the latches secure the **XRpad™ LBP** inside the detector.
- Push the power button on the **XRpad™ 4336** detector to power on.
- Check the battery charge status on the **XRpad™ 4336** detector. If the battery charge status shows sufficient battery charge is present, the **XRpad™ 4336** detector is ready for use. If the battery charge status shows lower than desired battery charge level, replace the battery with a charged battery.

8.5.1.3 XRpad™ LBP Removal

 Caution	Dispose of used XRpad™ LBP according to the instructions in the chapter 11
--	---

- Ensure the **XRpad™ 4336** detector is fully supported prior to performing this task to avoid drop or slip of the **XRpad™ 4336** detector, or **XRpad™ LBP**.
- Power off the **XRpad™ 4336** detector by pressing the power button on the **XRpad™ 4336** detector.
- Move the two sliding latch closer to the center to disengage the **XRpad™ LBP** from the **XRpad™ 4336** detector (see Figure 5). Remove the **XRpad™ LBP** out of the battery

compartment of the **XRpad™ 4336** detector using a slow and steady pull motion, supporting both the **XRpad™ 4336** detector, and the **XRpad LBP**.

- Store the **XRpad™ LBP** in a cool, dry, clean environment if not in use or during recharge of the **XRpad™ LBP** for the next use.

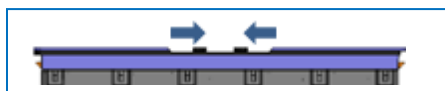

Figure 5 Removal of the **XRpad™ LBP**

8.5.1.4 Transportation and Storage

- Store the **XRpad™ LBP** in a cool, dry, clean environment when not in use. Do not remove the **XRpad™ LBP** from its original packaging until it is required for use.
- Do not leave, expose or store the **XRpad™ LBP** in extremely hot or cold temperatures (e.g., in direct sunlight, nearby heat sources, in cars or car trunks). The **XRpad™ LBP** may overheat causing fire, or performance life will be shortened.
- Do not short-circuit the **XRpad™ LBP**, or store the **XRpad™ LBP** without sufficient packaging in a location where it may be short-circuited.

8.5.1.5 Maintenance of the **XRpad™ LBP**

- Before inserting **XRpad™ LBP** into the **XRpad™ 4336** detector or **XRpad™ LBC** battery charger, inspect the **XRpad™ LBP** for sign of damage, defects or abnormality. Do not use damaged, defective or abnormal condition **XRpad™ LBP**.
- Check to ensure the **XRpad™ LBP** is clean, dry and free of foreign contamination or debris. If cleaning is necessary, refer to section 7.5.1.6 for cleaning instructions.
- The **XRpad™ LBP** has no repairable parts. Do not disassemble. No modification of this product is allowed.
- If the **XRpad™ LBP** gives off an odor or generates heat or in any way appears abnormal during use, recharging or storage, immediately remove it from the device or battery charger and stop using the **XRpad™ LBP**.
- Using a damaged or defective **XRpad™ LBP** may cut operating time or cause the **XRpad™ 4336** detector system to fail.
- If a **XRpad™ LBP** leaks, do not touch the leaking fluid. If the fluid touches your skin or eyes, wash the affected area with clean running water and immediately seek medical attention.
- If the **XRpad™ LBP** has not been used or charged for an extended amount of time (approximately 30 days), check the condition of the **XRpad™ LBP** and recharge if necessary prior to use.

8.5.1.6 Cleaning of the **XRpad™ LBP**

- Avoid exposure of the **XRpad™ LBP** to liquids and solvents when possible.
- Do not allow liquids or solvents to contact the electrical contacts on the **XRpad™ LBP**.
- When necessary, the **XRpad™ LBP** may be clean using a lightly moistened cloth with 70% isopropyl alcohol or 3% hydrogen peroxide.
- Never use thinner, benzene, acetone or any other corrosive or flammable cleaning agents.
- Ensure the **XRpad™ LBP** is completely clean and dry prior to storage, inserting into the **XRpad™ 4336** detector or **XRpad™ LBC** battery charger.

8.5.2 Interface and Power Unit XRpad™ IPU

The XRpad™ IPU is a Power Supply Unit with integrated additionally interfaces. The tethered power and communication cable is connected to the XRpad™ 4336 detector. The communication data are split inside the XRpad™ IPU into Gigabit Ethernet Interface, Detector Trigger Interface, Hand Switch and Generator Interface and Detector Push Button Interface. The Gigabit Ethernet Interface of the XRpad™ IPU is connected via Cat 5e/6 with the imaging Workstation. The maximum cable length is 30m. The AC cable has to be connected to a properly grounded receptacle. The AC cable is removable and will be plugged to an IEC connector. The XRpad™ IPU needs to be connected with a ground by the functional ground connector (Figure 6 (13)) or with the potential of the hospital by the potential equalization connector (Figure 6 (12)) To isolate the equipment electrically from supply mains on all poles simultaneously, the supply mains switch (Figure 6 (1)) must be used.

 WARNING	Connection of the XRpad™ IPU LAN port directly with the clinical computer network may disturb the IT environment.
--	---

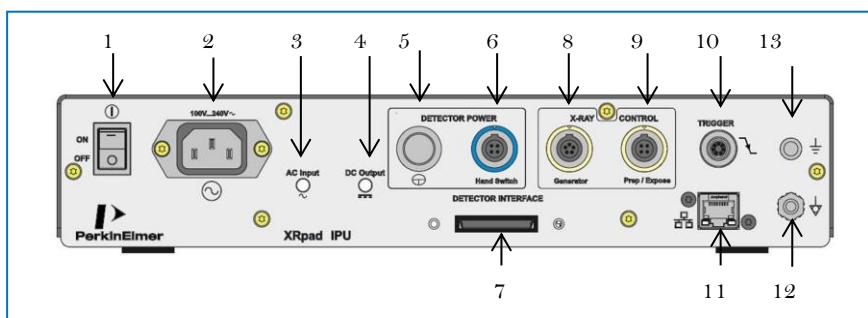

Figure 6 XRpad™ IPU Overview

Table 10 XRpad™ IPU Overview





1	XRpad™ IPU Power Switch	
2	Power In	
3	AC Input LED (Green) (~)	
4	DC output LED (Yellow) ()	
	LED Yellow	DC Output ok, no output load
	LED Green	DC Output ok, output loaded
5	XRpad Push Button ()	
6	XRpad Hand Switch In (Extension of the Push Button)	
7	XRpad Interface and Power I/O	
8	Trigger Out Signal to Generator	
9	Trigger In Signal from Hand Switch (Prep / Expose)	
10	Trigger In/Out I/F ()	
11	LAN port to Imaging Workstation	
12	Potential Equalization Connector	
13	Functional Ground Connector	

Table 11 Specification of the XRpad™ IPU

Electrical specification	
AC Input Voltage [2]	100V .. 240V
AC frequency [2]	50Hz / 60Hz
DC output [7]	12.5V / 5A, 15V / 1A (voltage level is dependent of load)
Trigger In Signal from Hand Switch [8]	5V .. 24V / 10mA (SELV)
Trigger Out Signal to Generator [9]	Same level as Trigger In Signal
Trigger In Signal [10]	3.3V ... 5V (SELV)
Trigger Out Signal [10]	3.3V
DC output 5PF [10]	5V / 100mA
Trigger In Signal [10]	3.3V ... 5V (SELV)
Mechanical Specification	
Size	311 mm x 230 mm x 60 mm
Temperature ranges	
Operating	+10° to +35°C
Transportation/Storage	-10° to 70°C
Relative Humidity	
Operating	10% to 90%
Transportation/Storage	0% to 90%
Ingress protection rating	IP40 rated (protection against particles > 1mm)

 WARNING	<p>All external signals which are connected to the IPU (especially PREP/EXPOSE and Trigger signals) should be from SELV (Separated or safety extra-low voltage) circuit. Ignoring this warning may result in electric shock, which may result in severe personal injury, death, or substantial product damage.</p>
--	--

8.5.2.1 Cleaning of the XRpad IPU

If the XRpad™ IPU surface is dirty or dusty, it should be cleaned with a commercial available ethanol papers or a cleaning cloth tightly wrung out of ethanol or a diluted neutral detergent. If you are using a disinfectant other than those specified, we recommend you consult a specialist for the procedure for disinfection. Turn OFF the XRpad™ IPU and disconnect the AC power cable, the detector power, and detector communication tethered cables before cleaning.



 WARNING	<p>When the Power and Interface Unit is going to be cleaned, be sure to turn OFF the XRpad™ IPU, and unplug all cables. Never use thinner, benzine, acetone, or other flammable cleaning agents. Ignoring this warning may result in explosion, fire, or electric shock, which may result in severe personal injury, death, or substantial product damage.</p>
--	--

8.6 Minimum Computer Requirements

1. Gigabit Ethernet Infrastructure and a free Gigabit Ethernet Port or WiFi Infrastructure
2. Intel compatible Multi Core Processor (>2 GHz)
3. RAM > 4 GB
4. Windows Vista or Windows7 (32bit / 64bit)
5. If a Firewall is used make sure that it allows to connect the detector
6. Access Point
 - a. WPA2 encryption support
 - b. 802.11 AN MIMO 3x3
 - c. Complying with IEC 60601-1 or ICC 60950-1.

8.7 Operation

Before connecting the **XRpad™ 4336** detector, ensure that the Digital Radiography Software is installed as described in its manual. If not, install the software first. The detector can be used in different configurations depending on the desired application. The following sections describe the different use cases.

 WARNING	Do not exceed the maximum load weight of 150 kg distributed around the overall surface of the detector.
 WARNING	Do not exceed the maximum load weight of 100 kg distributed at one location in a 40mm diameter of the detector surface.
 Caution	Check the threshold of the auto trigger mode regularly.

8.7.1 Wired Detector Operation

Figure 7 shows the wired connection of the **XRpad™ 4336** detector in a clinical environment. The AC outlet shall be installed near the Interface and Power Unit **XRpad™ IPU** and shall be easily accessible. The **XRpad™ IPU** may be mounted in an equipment enclosure. In the wired application the **XRpad™ 4336** detector is connected with the **XRpad™ IPU** which powers the **XRpad™ 4336** detector and is responsible for the data transfer. The **XRpad™ IPU** is connected via Cat 5e/6 with the Imaging Workstation. Make sure that the **XRpad™ IPU** is not connected directly with the clinical network. The Trigger I/F of the **XRpad™ IPU** need to be connected with the Generator and with the Hand switch.

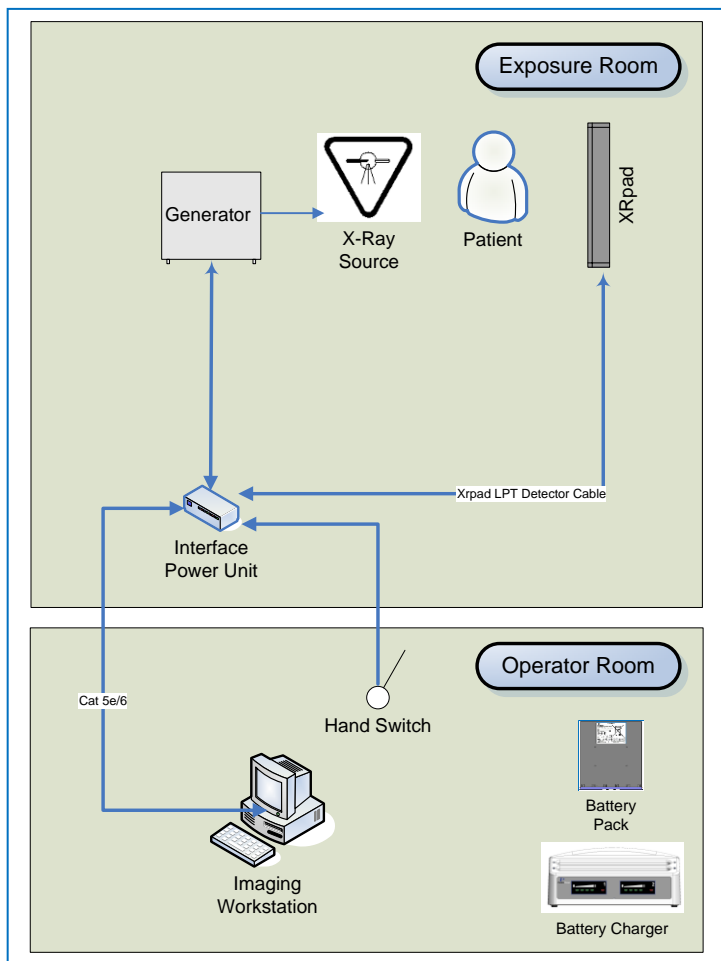

Figure 7 Wired Connection of the **XRpad™**

The **XRpad™ IPU** communicates via a standard Gigabit Ethernet network Interface, and comes equipped with an RJ45 interface port. Due to the overall network traffic it is recommended to use this interface in a direct (Point-to-Point) connection with the host computer in order to achieve optimal speed performance. The **XRpad™ IPU** should be connected to the host computer by one of the PerkinElmer XRD GigE Interface Cables or a CAT5e /CAT6 (shielded twisted pair, stranded or solid copper conductor) cable. The cable length can be up to 30m.

8.7.2 Wireless Detector Operation

Figure 8 shows the wireless connection of the **XRpad™ 4336** detector in a clinical environment. The **XRpad™ 4336** detector is connected via WLAN over a WiFi Access Pointer with the Imaging Workstation. The WiFi Access Pointer may be wall or ceiling mounted to maximize wireless signal strength. Make sure that the Router is not connected directly with the clinical network. Before imaging make sure that the **XRpad™ LBP** charge is sufficient and that the **XRpad™ 4336** detector antenna is not obstructed.

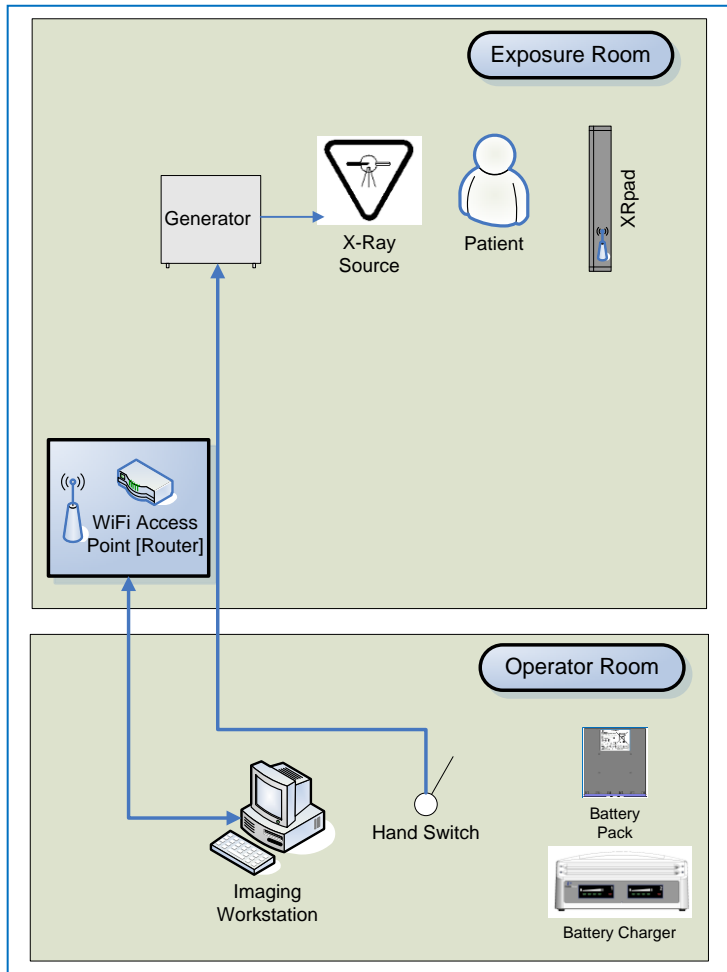



Figure 8 Wireless Connection of the **XRpad™**

8.7.3 Before Using the X-ray Detector

Sudden cooling or heating of the room will cause condensation. In this case, wait until condensation disappears before powering ON the **XRpad™ 4336** detector.

 WARNING	<p>If the detector system is used under condensation conditions, problems in image quality or malfunction of the detector system may occur. In addition, this may cause fire, electrical shock, and unknown hazards, which may result in severe personal injury, death, or substantial product damage.</p>
 Caution	<p>The XRpad™ 4336 should only be used with an inserted XRpad™ LBP or XRpad™ Protective Insert</p>

8.7.4 Power On the XRpad™ 4336 Detector

This chapter describes the power up the **XRpad™ 4336**. For more details check the Digital Radiography Software Manual. Please make sure that the IP setting on your network adapter is set to static IP and in correlation to the **XRpad™ 4336**. The default settings of the **XRpad™ 4336** are “192.168.2.158” for the LAN – connection and “192.168.22.1” for the wireless LAN – connection. It is required that the detector has an **XRpad™ Protective Insert** or an **XRpad™ LPB** inserted into battery compartment.

8.7.4.1 Wired Mode

Plug in the power cord to the Interface and Power Unit **XRpad™ IPU** and switch the Power On. The AC Input LED will turn on (Green) and the DC Output LED will turn ON (Yellow). To power the **XRpad™ 4336** detector, press the **XRpad™ 4336** detector Power push button of the **XRpad™ IPU** or the push button at the **XRpad** itself for 1s. The DC Output LED will turn from Yellow to green. During the initialization of the detector the detector push button LED is flashing fast. Once the **XRpad™ 4336** detector is powered, the **XRpad™ 4336** detector LED will be flashing slowly and the Detector display is showing the current status. After preparing the Radiography Imaging Software for exposure the **XRpad™ 4336** detector LED will turn in a continuously ON. The **XRpad™ 4336** detector LED ON will indicate that the detector is ready for exposure.

8.7.4.2 Wireless Mode

When the detector is not connected to the **XRpad™ IPU** then check the status of the **XRpad™ LBP** to ensure the charge of the battery is more than 50%. If the status is low, exchange the **XRpad™ LBP** with a charged one or use the wired operation mode. Press the detector push button for 1s and the **XRpad™ 4336** detector will be powered up. During the initialization of the detector the detector push button LED is flashing fast. Once the detector is powered the blue LED of the push button will be flashing slowly and the Detector display is showing the current status. After preparing the Radiography Imaging Software for exposure the **XRpad™ 4336** detector LED will turn in a continuously ON. The **XRpad™ 4336** detector LED ON will indicate that the **XRpad™ 4336** detector is ready for exposure.

8.7.5 Power Down the XRpad™ 4336

The **XRpad™ 4336** detector is powered OFF by holding down one of the three push buttons for more than 4 seconds. The following buttons can be used

- **XRpad™ 4336** detector (Figure 1 (5)) (wireless & wired mode)
- **XRpad™ IPU** push button (Figure 6 (5)) (wired mode)
- Extended hand switch push button (wired mode)

8.7.6 General Workflow

The following Workflow indicates the procedure of acquiring a clinical image after startup of the Radiography Imaging Software. Details of the Radiography Imaging Software and the x-ray generator are described in their corresponding Operation Manuals.

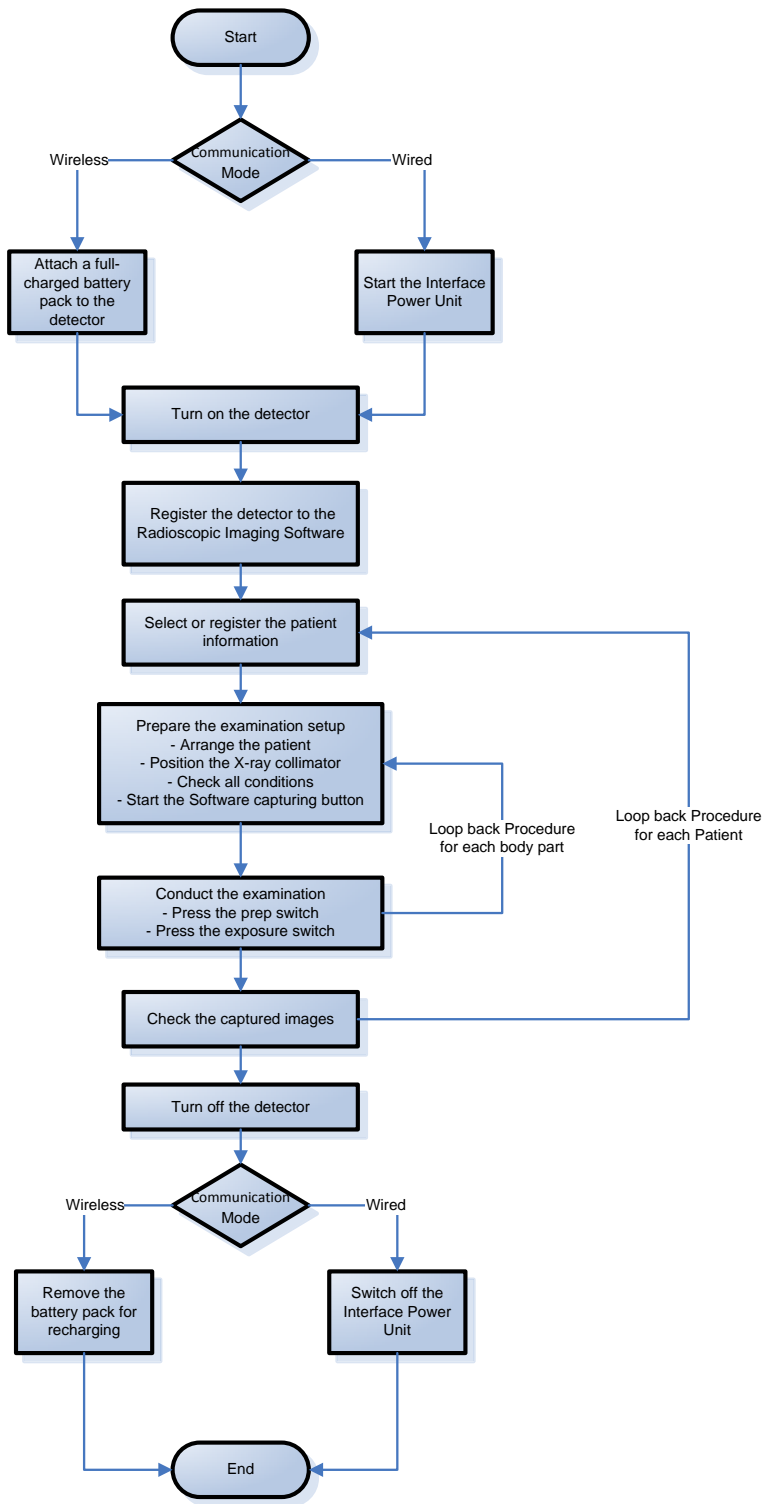



Figure 9 General Workflow

9 Inspection and Maintenance

 WARNING	The XRpad™ 4336 detector must be repaired by PerkinElmer authorized personnel only. Ignoring this warning may result in explosion, fire, electric shock, or unknown hazards, which may result in severe personal injury, death, or substantial product damage.
 Caution	Inspect the XRpad™ 4336 detector before use. In addition, carry out prescribed, regular inspections per the instructions in this manual.

It is important that the detector is used safely and as intended. Inspect the detector and its accessories before use. If any problem is found during the inspection, correct the problem, and take measurements indicated in this chapter. If the problem cannot be corrected, contact your dealer, distributor, or any PerkinElmer subsidiaries (regional service headquarters) listed on the last page of this document. We recommend that you keep records of the inspection close to the detector. You can make copies of the checklist in this chapter or make your own checklist.



9.1 Daily Inspection

Perform the following inspection daily. If there is any problem, inform your establishment safety representative immediately to contact your dealer, distributor, or PerkinElmer subsidiary.

9.1.1 Before Turning ON the Power

	Inspection	Result			Remedy
		Date /	Date /	Date /	
Cables	Check all cables (Power and communication tethered cord, DC-cable, Ethernet cable, Sync cable) to ensure that they are not damaged and the insulation is not damaged.	Good/Bad	Good/Bad	Good/Bad	Contact your dealer, distributor, or any PerkinElmer subsidiaries if there is a problem.
	Check all connector plugs and locks to ensure they are not loose.	Good/Bad	Good/Bad	Good/Bad	Fully insert the cables and lock them.
Detector	Check that the detector is not damaged.	Good/Bad	Good/Bad	Good/Bad	Contact your dealer, distributor, or any PerkinElmer subsidiaries if there is a problem.
	Check that the Battery Pack is not damaged.	Good/Bad	Good/Bad	Good/Bad	Replace the Battery Pack with a new one.
	Check that the detector is not loose and all screws are fixed.	Good/Bad	Good/Bad	Good/Bad	Contact your dealer, distributor, or any PerkinElmer subsidiaries if there is a problem.

9.1.2 After Turning ON the Power

	Inspection	Result			Remedy
		Date /	Date /	Date /	
General	Check that the wireless connectivity symbol  is shown in the display if the Wireless Mode is used.	Good/Bad	Good/Bad	Good/Bad	Connect the Detector and the WiFi Access Pointer as described in the Access Pointer Manual
	Check that the LAN connectivity symbol  is shown in the display if the Wired Mode is used.	Good/Bad	Good/Bad	Good/Bad	Connect the Gigabit Ethernet cable and the tethered power and communication cable properly.

	Check the Battery charge condition	Good/Bad	Good/Bad	Good/Bad	Exchange the Battery Pack with a charged one.
	Check that the detector LED is ON.	Good/Bad	Good/Bad	Good/Bad	Set the Detector to “Exposure Ready” as described in the Radiography Software Manual
	Perform test exposure as described in the Digital Radiography Software Manual.	Good/Bad	Good/Bad	Good/Bad	If any error messages appear, follow the instructions in the Digital Radiography Software Manual. If there is a problem, contact your dealer, distributor, or any PerkinElmer subsidiary.

9.1.3 After Turning OFF the Power

	Inspection	Result			Remedy
		Date /	Date /	Date /	
General	Check that the XRpad™ is turned off normally and that all LEDs are OFF	Good/Bad	Good/Bad	Good/Bad	Check the chapter 8.7.5 for turning off the XRpad™ .
	Make sure that the XRpad™ is clean and disinfected	Good/Bad	Good/Bad	Good/Bad	Check the chapter 9.5 for cleaning the XRpad™ .

9.2 Monthly Inspection

Perform the following inspection at least once a month. If there is a problem, inform your establishment safety department immediately to contact your dealer, distributor, or PerkinElmer subsidiary.

	Inspection	Result			Remedy
		Date /	Date /	Date /	
General	Execute an Image Performance Test, and compare the test results.	Good/Bad	Good/Bad	Good/Bad	Follow the instructions in the Digital Radiography Software Manual for the Performance Test procedure. If there are changes in the performance, acquire new calibration files as described in the Radiography Software Manual. Contact your dealer, distributor, or any PerkinElmer subsidiaries if there is any problem.
	Check the threshold of the auto trigger mode				Follow the instructions in the Digital Radiography Software Manual for the threshold test and if the test fails inform your establishment safety representative immediately to contact your dealer, distributor, or PerkinElmer.
	Make sure that the XRpad™ IPU is clean from dirt or dust.	Good/Bad	Good/Bad	Good/Bad	Use the instructions of chapter 0 for cleaning.

9.3 Yearly Inspection

Perform the following inspection at least once a year. If there is any problem, inform your establishment safety representative immediately to contact your dealer, distributor, or PerkinElmer subsidiary.

	Inspection	Result			Remedy
		Date /	Date /	Date /	
General	Execute an Image Performance Test using a phantom, or an Image Quality Indicator (IQI).	Good/Bad	Good/Bad	Good/Bad	Follow the instructions in the Digital Radiography Software Manual and the manual of your IQI phantom for the Performance Test procedure. Contact your dealer, distributor, or any PerkinElmer subsidiaries if there is any problem.

9.4 Calibration

When exposure conditions have changed significantly (e.g. new energy settings, new x-ray tube, new distances), acquire new gain calibration files. Follow the instructions in the Digital Radiography Software Manual for acquiring new calibration files.

9.5 Cleaning the Detector

 WARNING	<p>When the detector system is going to be cleaned, be sure to turn OFF the XRpad™ 4336 detector, remove the XRpad™ LBP and or unplug the power and communication tethered cable if applicable. Never use thinner, benzine, acetone, or other flammable cleaning agents. Ignoring this warning may result in explosion, fire, or electric shock, which may result in severe personal injury, death, or substantial product damage.</p>
--	--

Turn OFF the detector, and the power and communication tethered cable if applicable and insert the **XRpad™ Protective Insert** into battery compartment before cleaning or disinfecting of the detector. **XRpad™ LBPXRpad™ 4336** If the detector surface is dirty, it should be cleaned with commercial available ethanol papers for disinfection or a cleaning cloth tightly wrung out of ethanol or a diluted neutral detergent.. If you are using a disinfectant other than those specified, we recommend you consult a specialist for the procedure for disinfection.

To clean the **XRpad™ 4336** detector:

1. Turn OFF the **XRpad™ 4336** detector.
2. Unplug the power and communication tethered cable if applicable.
3. Insert the **XRpad Protective Insert** into battery compartment
4. Wipe the detector surface with a commercial available ethanol papers for disinfection or a cleaning cloth tightly wrung out of ethanol or a diluted neutral detergent. Do not allow any fluid, detergent or solution to get inside the battery compartment of the **XRpad™ 4336** detector.
5. Remove any excess detergent or solution.
6. Wipe the detector surface with a clean cloth to completely dry the detector.
7. Allow the detector to completely air dry before turning on detector, or storage.

10 After-Sales Service for PerkinElmer Products

Contact your sales person or distributor for after-sales service (including warranty) or any other information. If information is not available, contact one of the PerkinElmer subsidiaries (regional service headquarters) listed on the last page of this document.

Field service is limited to replacement of the detector or adding and replacing approved accessories by authorized personnel. The detector and its accessories are not intended to be repaired in the field.

For product returns, contact your distributor or PerkinElmer for shipping and packaging instructions. Do not return products to PerkinElmer for repair or service without advance notification. Include all required papers in the shipment.

If the detector or accessories have been contaminated with potentially harmful substances or activated by high energy x-rays, gamma rays, or neutrons, they cannot be accepted without written evidence of decontamination.

To ship the **XRpad™ LBP** (Lithium Battery Pack), follow the local and regional requirements for proper packaging and shipping of Lithium Batteries.

11 Disposal

If the detector is activated by high energy x-rays, gamma rays, or neutrons follow the local radiation protection regulation.

Contact your supplier or distributor, and check the terms of conditions of the purchase contract. This product should not be mixed with other commercial waste for disposal.

A label with a crossed-out wheeled bin symbol and a rectangular bar indicates that the product is covered by the Waste Electrical and Electronic Equipment (WEEE) Directive and is not to be disposed of as unsorted municipal waste. Any products marked with this symbol must be collected separately, according to the regulatory guidelines in your area.

The objectives of this program are to preserve, protect, and improve the quality of the environment, protect human health, and utilize natural resources prudently and rationally. Specific treatment of WEEE is indispensable in order to avoid the dispersion of pollutants into the recycled material or waste stream. Such treatment is the most effective means of protecting the customer's environment. Requirements for waste collection, reuse, recycling, and recovery programs vary by regulatory authority at your location. Contact your local responsible body (for example, your hospital, clinic, establishment, or site manager) or authorized representative for information regarding applicable disposal regulations. Contact PerkinElmer at the Web site listed below for information specific to PerkinElmer products.

Web Address:

<http://www.perkinelmer.com/pages/010/onesource/environmental-health-and-safety/environmental-directives-compliance.xhtml>



The PerkinElmer product may be attached as part of a component to other manufacturers' systems. These other manufacturers are directly responsible for the collection and processing of their own waste products under the terms of the WEEE Directive. Contact these producers directly before discarding any of their products. Consult the PerkinElmer Web site (above) for producer names and Web addresses.

12 Declarations

12.1 Guidance and Manufacturer’s Declaration

Table 12 Guidance and Manufacturer’s Declaration of Electromagnetic Emissions

Guidance and Manufacturer’s Declaration of Electromagnetic Emissions		
The x-ray detector is intended for use in the electromagnetic environment specified below. The installer, x-ray system manufacturer, or user of the x-ray detector is responsible for the usage condition of the detector to be within such environment.		
Emissions Test	Compliance	Electromagnetic Environment – Guidance
RF-emissions CISPR 11	Group 1	The x-ray detector uses RF energy only for its internal function; therefore, its RF emissions are very low and are not likely to cause any interference in nearby electronic equipment. Should any interference (EMC) be detected with any other equipment, reposition the x-ray detector or the other equipment away from each other.
RF-emissions CISPR 11	Class B (wireless) Class A (wired)	The X-Ray Detector is suitable for use in industrial and clinical environments in the wired mode. In the wireless mode the x-ray detector is suitable for use in all environments within Class B.
Harmonic emissions IEC 61000-3-2	Class B (wireless) Class A (wired)	Should any interference (EMC) be detected with any other equipment, reposition the x-ray detector or the other equipment away from each other.
Voltage fluctuations/flicker emissions IEC 61000-3-3	Complies	

Table 13 Guidance and Manufacturer’s Declaration of Electromagnetic Immunity

Guidance and Manufacturer’s Declaration of Electromagnetic Immunity			
The x-ray detector is intended for use in the electromagnetic environment specified below. The installer, x-ray system manufacturer, or user of the x-ray detector is responsible for the usage condition of the detector to be within such environment.			
Immunity Test	IEC 60601 Test	Compliance	Electromagnetic Environment – Guidance
Electrostatic Discharge (ESD) IEC 61000-4-2	Contact: 6 kV Air: 8 kV	Contact: 6 kV Air: 8 kV	Floors should be made of wood, concrete, or ceramic tile. If floors are covered with synthetic material, the relative humidity should be at least 30%.
Electrical fast transients (Burst) IEC 61000-4-4	0.5 kV (AC) 1kV (DC)	0.5 kV (AC) 1kV (DC)	Mains power quality should be that of a typical commercial and/or hospital environment.
Transients-Surges IEC 61000-4-5	1 kV / 2 kV	1 kV / 2 kV	Mains power quality should be that of a typical commercial and/or hospital environment.
Power frequency magnetic field IEC 61000-4-8	3 A/m	3 A/m	Power frequency magnetic fields should be at levels characteristic of a typical location in a typical commercial and/or hospital environment.
Voltage dips and short interruptions IEC 61000-4-11	-95% / 10 ms -60% / 100 ms -30% / 500 ms >-95% / 5000 ms	-95% / 10 ms -60% / 100 ms -30% / 500ms >-95% / 5000 ms	Mains power quality should be that of a typical commercial or hospital environment. If the user of the x-ray detector requires continued operation during power mains interruptions, we recommend that the x-ray detector be powered from an uninterruptible power supply or battery.

Table 14 Recommended Separation Distance between Portable and Mobile RF-Communication Equipment and the X-Ray Detector

Recommended Separation Distance between Portable and Mobile RF-Communication Equipment and the X-Ray Detector			
The x-ray detector is intended for use in the electromagnetic environment specified below. The installer, x-ray system manufacturer, or user of the x-ray detector should assure that it is used in such an environment.			
Rated Maximum Output Power of the Transmitter (W)	150 kHz to 80 MHz	80 MHz to 800 MHz	800 MHz to 2.5 GHz
	$d = 1.2\sqrt{P}$	$d = 1.2\sqrt{P}$	$d = 2.3\sqrt{P}$
0,01	0.12	0.12	0.23
0,1	0.38	0.38	0.73
1	1.2	1.2	2.3
10	3.8	3.8	7.3
100	12	12	23
For a transmitter rated at a maximum output power not listed above, the separation distance can be estimated using the equation in the corresponding column, where P is the maximum output (power rating of the transmitter in watt [W]) according to the transmitter manufacture and d as the recommended separation distance in meter (m).			
Note: This guideline may not apply in all situations. Electromagnetic propagation is absorption and reflection from structures, objects, and people.			

Table 15 Guidance and Manufacturer’s Declaration of Electromagnetic Immunity (Portable Equipment)

Guidance and Manufacturer’s Declaration of Electromagnetic Immunity			
The x-ray detector is intended for use in the electromagnetic environment specified below. The installer, x-ray system manufacturer, or user of the -ray detector should assure that it is used in such an environment.			
Immunity Test	IEC 60601 Test	Compliance	Electromagnetic Environment – Guidance
Conducted radio-frequency fields (CEF) IEC 61000-4-6	3 V 150 kHz to 80 MHz	[V _i] 3 V 150 kHz to 80 MHz	Portable and mobile RF-communication equipment should not be closer to any part of the x-ray detector including the data cables, than the recommended separation distance calculated from the equation appropriate for the frequency of the transmitter. $d = 1.2\sqrt{P}$, 150 kHz to 80 MHz $d = 1.2\sqrt{P}$, for 80 MHz to 800 MHz $d = 2.3\sqrt{P}$, for 800 MHz to 2.5 GHz, where P is the maximum output of the transmitter in watt (W) according to the transmitter manufacture and d is the recommended separation distance in meter (m). Field strengths outside the shielded location from fixed RF transmitters, as determined by an electromagnetic site survey ¹⁰ , should be less than 3 V/m. Interference may occur in the vicinity of equipment marked with the following symbol. 
Radiated electromagnetic field (REF) IEC 61000-4-3	3 V/m 80 MHz to 2.5 GHz	[E _i] 3 V/m 80 MHz to 2.5 GHz	
Note 1: These guidelines may not apply to all situations. Electromagnetic propagation is affected by absorption and reflection from structures, objects, and people.			
Note 2: It is essential that the actual shielding effectiveness and filter attenuation of the shielded location be verified to assure that they meet the minimum specification.			

¹⁰Field strengths from fixed transmitters, such as base stations for radio (cellular/cordless) telephones and land mobile radios, armature radio, AM and FM radio broadcast, and TV broadcast, cannot be predicted theoretically with accuracy. To assess the electromagnetic environment due to fixed RF transmitters, an electromagnetic site survey should be considered. If the measured field strength in the location in which the x-ray detector is used exceeds the applicable RF compliance level above, the x-ray detector should be observed to verify normal operation. If abnormal performance is observed, additional measures may be necessary, such as re-orienting or relocating the x-ray detector.

12.2 Federal Communication Commission Interference Statement (US)

This device complies with Part 15 of the FCC Rules. Operation is subject to the following two conditions: (1) This device may not cause harmful interference, and (2) this device must accept any interference received, including interference that may cause undesired operation.





 Caution	Changes or modifications not expressly approved by PerkinElmer Medical Imaging could void the user's authority to operate the equipment.
--	--

NOTE: This equipment has been tested and found to comply with the limits for a Class A digital device, pursuant to part 15 of the FCC Rules. These limits are designed to provide reasonable protection against harmful interference when the equipment is operated in a commercial environment. This equipment generates, uses, and can radiate radio frequency energy and, if not installed and used in accordance with the instruction manual, may cause harmful interference to radio communications. Operation of this equipment in a residential area is likely to cause harmful interference in which case the user will be required to correct the interference at his own expense.

This transmitter must not be co-located or operating in conjunction with any other antenna or transmitter.
 5.15 ~ 5.25GHz band operation is restricted to indoor environment use only.

12.3 Industry Canada statement (english):

This device complies with RSS-210 of the Industry Canada Rules. Operation is subject to the following two conditions: (1) This device may not cause harmful interference, and (2) this device must accept any interference received, including interference that may cause undesired operation.





 Caution	The device for operation in the band 5150-5250 MHz is only for indoor use to reduce the potential for harmful interference to co-channel mobile satellite systems
 Caution	The maximum antenna gain permitted for devices in the bands 5250-5350 MHz and 5470-5725 MHz shall comply with the e.i.r.p. limit.
 Caution	The maximum antenna gain permitted for devices in the band 5725-5825 MHz shall comply with the e.i.r.p. limits specified for point-to-point and non-point-to-point operation as appropriate.
 Caution	Users should also be advised that high-power radars are allocated as primary users (i.e. priority users) of the bands 5250-5350 MHz and 5650-5850 MHz and that these radars could cause interference and/or damage to LE-LAN devices.

The product comply with the Canada portable RF exposure limit set forth for an uncontrolled environment and are safe for intended operation as described in this manual. The further RF exposure reduction can be achieved if the product can be kept as far as possible from the user body or set the device to lower output power if such function is available.

Note: This equipment does not exceed the Class A limits for radiated emissions as described in the Radio Interference Regulations of the Canadian Department of Communications.

12.1 Industrie Canada déclaration (français):

Le présent appareil est conforme aux CNR d'Industrie Canada applicables aux appareils radio exempts de licence. L'exploitation est autorisée aux deux conditions suivantes : (1) l'appareil ne doit pas produire de brouillage, et (2) l'utilisateur de l'appareil doit accepter tout brouillage radioélectrique subi, même si le brouillage est susceptible d'en compromettre le fonctionnement.

 Avertissement	Les dispositifs fonctionnant dans la bande 5 150-5 250 MHz sont réservés uniquement pour une utilisation à l'intérieur afin de réduire les risques de brouillage préjudiciable aux systèmes de satellites mobiles utilisant les mêmes canaux.
 Avertissement	Le gain maximal d'antenne permis pour les dispositifs utilisant les bandes 5 250-5 350 MHz et 5470-5 725 MHz doit se conformer à la limite de p.i.r.e.
 Avertissement	Le gain maximal d'antenne permis (pour les dispositifs utilisant la bande 5 725-5 825 MHz) doit se conformer à la limite de p.i.r.e. spécifiée pour l'exploitation point à point et non point à point, selon le cas.
 Avertissement	De plus, les utilisateurs devraient aussi être avisés que les utilisateurs de radars de haute puissance sont désignés utilisateurs principaux (c.-à-d., qu'ils ont la priorité) pour les bandes 5 250-5 350 MHz et 5 650-5 850 MHz et que ces radars pourraient causer du brouillage et/ou des dommages aux dispositifs LAN-EL.

Le produit est conforme aux limites d'exposition pour les appareils portables RF pour les Etats-Unis et le Canada établies pour un environnement non contrôlé. Le produit est sûr pour un fonctionnement tel que décrit dans ce manuel. La réduction aux expositions RF peut être augmentée si l'appareil peut être conservé aussi loin que possible du corps de l'utilisateur ou que le dispositif est réglé sur la puissance de sortie la plus faible si une telle fonction est disponible.

Note: Cet appareil numérique ne dépasse pas les limites de la classe A pour les émissions radio, telles que définies dans le Radio Interference Regulations du Département Canadien des Communications.

12.2 Declaration of Conformity for European Union (and EEA)

English	Hereby, PerkinElmer Inc. declares that this XRpad 4336 MED is in compliance with the essential requirements and other relevant provisions of Directive 1999/5/EC.
Česky	PerkinElmer Inc. tímto prohlašuje, že tento XRpad 4336 MED je ve shodě se základními požadavky a dalšími příslušnými ustanoveními směrnice 1999/5/ES.
Dansk	Undertegnede PerkinElmer Inc. erklærer herved, at følgende udstyr XRpad 4336 MED overholder de væsentlige krav og øvrige relevante krav i direktiv 1999/5/EF.
Deutsch	Hiermit erkläre PerkinElmer Inc. dass sich das XRpad 4336 MED in Übereinstimmung mit den grundlegenden Anforderungen und den übrigen einschlägigen Bestimmungen der Richtlinie 1999/5/EG befindet.
Eesti	Käesolevaga kinnitab PerkinElmer Inc. seadme XRpad 4336 MED vastavust direktiivi 1999/5/EU põhinõuetele ja nimetatud direktiivist tulenevatele teistele asjakohastele sätetele.
Espanol	Por medio de la presente PerkinElmer Inc. declara que el XRpad 4336 MED cumple con los requisitos esenciales y cualesquiera otras disposiciones aplicables o exigibles de la Directiva 1999/5/CE.
Français	Par la présente PerkinElmer Inc. déclare que l' appareil XRpad 4336 MED est conforme aux exigences essentielles et aux autres dispositions pertinentes de la directive 1999/5/CE.
Ελληνική	ΜΕ ΤΗΝ ΠΑΡ_ΥΣΑ PerkinElmer Inc. ΔΗΛΩΝΕΙ_ΤΙ XRpad 4336 MED ΣΥΜΜ_ΡΦΩΝΕΤΑΙ ΠΡ_Σ ΤΙΣ_ΥΣΙΩΔΕΙΣ ΑΠΑΙΤΗΣΕΙΣ ΚΑΙ ΤΙΣ_Λ_ΠΙΕΣ_Σ_ΕΤΙΚΕΣ ΔΙΑΤΑ_ΕΙΣ ΤΗΣ_ΔΗΓΙΑΣ 1999/5/ΕΚ.
Italiano	Con la presente PerkinElmer Inc. dichiara che questo XRpad 4336 MED è conforme ai requisiti essenziali ed alle altre disposizioni pertinenti stabilite dalla direttiva 1999/5/CE.
Íslenska	Her með lýsir PerkinElmer Inc. yfir því að XRpad 4336 MED er ísamræmi við grunnkröfur og aðrar kröfur, sem gerðar eru í tilskipun 1999/5/EC.
Latviski	Aržo PerkinElmer Inc. deklare, ka XRpad 4336 MED atbilst Direktivas 1999/5/EK būtiskajam prasibam un citiem ar to saistitajiem noteikumiem.
Lietuviu	Šiuo PerkinElmer Inc. deklaruoja, kad šis XRpad 4336 MED atitinka esminius reikalavimus ir kitas 1999/5/EB Direktyvos nuostatas.
Malti	Hawnhekk, PerkinElmer Inc., jiddikjara li dan XRpad 4336 MED jikkonforma malhtigijiet essenzjali u ma provvedimenti oħrajn relevanti li hemm fid-Dirrettiva 1999/5/EC.
Magyar	Alulírott, PerkinElmer Inc. nyilatkozom, hogy a XRpad 4336 MED megfelel a vonatkozó alapvető követelményeknek és az 1999/5/EC irányélv egyeb előírásáinak.
Nederlands	Hierbij verklaart PerkinElmer Inc. dat het toestel XRpad 4336 MED in overeenstemming is met de essentiële eisen en de andere relevante bepalingen van richtlijn 1999/5/EG.
Norsk	PerkinElmer Inc. erklærer herved at utstyret XRpad 4336 MED er i samsvar med de grunnleggende krav og øvrige relevante krav i direktiv 1999/5/EF.
Polski	Niniejszym PerkinElmer Inc. oświadczam, że XRpad 4336 MED jest zgodny z zasadniczymi wymogami oraz pozostałymi stosownymi postanowieniami Dyrektywy 1999/5/EC.
Português	PerkinElmer Inc. declara que este XRpad 4336 MED está conforme com os requisitos essenciais e outras disposições da Directiva 1999/5/CE.
Suomi	PerkinElmer Inc. vakuuttaa taten etta XRpad 4336 MED tyyppinen laite on direktiivin 1999/5/EY oleellisten vaatimusten ja sita koskevien direktiivin muiden ehtojen mukainen.
Slovensko	PerkinElmer Inc. izjavlja, da je ta XRpad 4336 MED v skladu z bistvenimi zahtevami in ostalimi relevantnimi določili direktive 1999/5/ES.
Svenska	Härmed intygar PerkinElmer Inc. att denna XRpad 4336 MED står i överensstämmelse med de väsentliga egenskapskrav och övriga relevanta

	bestämmelser som framgår av direktiv 1999/5/EG.
--	---

The **XRpad4336** may be operated in:

AT	BE	BG	CH	CY	CZ	DE	DK	EE	ES
FI	FR	GR	HU	IE	IT	IS	LT	LU	LV
MT	NL	NO	RO	PL	PT	SE	SI	SK	UK

USA
PerkinElmer Inc.
 2175 Mission College Blvd
 Santa Clara, CA 95054
 USA
 P: +1 408-565-0796
 F: +1 408-969-6493
fpd@perkinelmer.com
www.perkinelmer.com

Germany
PerkinElmer Technologies GmbH & Co. KG
 In der Rehbach 22
 65396 Walluf
 Germany
 P: +49 6123 971-300
 F: +49 6123 971-600
fpd@perkinelmer.com
www.perkinelmer.com

For a complete listing of our global offices, visit www.perkinelmer.com
 ©2013 PerkinElmer, Inc. All rights reserved. The PerkinElmer logo and design are registered trademarks of PerkinElmer, Inc. or its subsidiaries, in the United States and other countries. All other trademarks not owned by PerkinElmer, Inc. or its subsidiaries that are depicted herein are the property of their respective owners. PerkinElmer reserves the right to change this document at any time without notice and disclaims liability for editorial, pictorial or typographical errors.

Doc 25574/ Rev.02