

POS MobilePro

User manual

VECTRON SYSTEMS



Your Vectron dealer

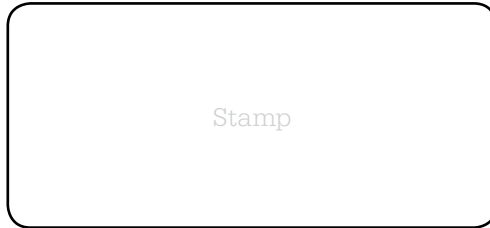

Stamp

Date: 22.07.2008

© 2005 - 2008 by Vectron Systems AG

Subject to error and modification

Manufacturer

Vectron Systems AG

Willy-Brandt-Weg 41

D-48155 Münster

www.vectron.de

Vectron

Leading in POS Technology



Contents

1	Introduction.....	9
2	Notes on safety.....	11
3	Instructions for use	12
4	Disposal.....	13
5	Vectron POS MobilePro.....	15
5.1	Shipment.....	15
5.2	Mode of operation and starting.....	16
5.2.1	Mode of operation.....	16
5.2.2	Power supply.....	19
5.2.3	Switch on and -off.....	19
5.3	Components.....	21
5.3.1	Display.....	21
5.3.2	Keyboard and Soft keys.....	23
5.3.3	Charge contacts.....	25
5.3.4	Battery exchange.....	26
5.3.5	LED-Signals.....	36
5.3.6	Acoustic signal.....	37
5.3.7	Vibration motor.....	37
5.3.8	Wireless LAN.....	38
5.3.9	Bluetooth.....	39
5.3.10	Transponder.....	39
5.3.11	SIM-card reader.....	42
5.3.12	Brightness sensor.....	44
5.3.13	Tilt sensor.....	44
5.3.14	Power management.....	46
5.3.15	Failure of power supply.....	46
5.4	Technical data Vectron POS MobilePro.....	47
6	Charging station and batteries.....	51
6.1	Shipment.....	51
6.2	Mode of operation.....	51
6.3	Charging.....	55
6.4	Service life of batteries.....	56
6.5	Technical data.....	57



7	Putting into operation.....	59
8	Operating the POS system	63
8.1	Sign in and -out at the POS system	63
8.1.1	Sign in by transponder card.....	63
8.1.2	Sign in without transponder card.....	64
8.1.3	Sign out.....	64
8.2	Guest checks and hold buffers.....	64
8.2.1	Starting a new GC.....	64
8.2.2	Close and re-open a GC.....	65
8.2.3	Paying a guest check	65
8.2.4	Guest check split	65
8.2.5	Guest check move	66
8.2.6	Shift change.....	66
8.2.7	Hold buffers	66
8.3	Reports.....	67
8.4	Input and output	69
8.4.1	Input of amounts.....	69
8.4.2	Screen windows.....	69
8.5	Making a sale.....	70
8.5.1	Input of PLUs.....	70
8.5.2	Free price input	70
8.5.3	Payment.....	71
8.6	Void and merchandise return.....	71
8.6.1	Correction	71
8.6.2	Void	71
8.6.3	Merchandise return.....	72
8.7	Change invoice format	72
8.8	Programming the POS system.....	72
8.9	Final remark	73
9	Service and maintenance	75
9.1	Cleaning the display	75
9.2	Cleaning the keyboard.....	75
9.3	Cleaning the housing.....	84
9.4	Cleaning the charge contacts.....	84
9.5	Careful handling of the terminal.....	85



10	Accessories.....	87
10.1	System accessories.....	87
10.1.1	Charging station and batteries.....	87
10.1.2	Transponder.....	88
10.1.3	Touch pen.....	88
10.1.4	Multi-function touch pen.....	88
10.2	Additional accessories.....	89
10.2.1	Mobile thermal printer Vectron MP20.....	89
10.2.2	Leather holster.....	90
10.2.3	Safety swirl.....	93
11	Special functions for Vectron POS MobilePro....	94
11.1	Alphanumeric short cuts.....	94
11.2	Print data server.....	95
11.3	Offline Guest Checks.....	96
12	Additional Vectron products.....	97
12.1	Stationary Vectron POS systems.....	97
12.2	Vectron POS PC.....	98
12.3	Vectron Commander.....	98
13	EC-declaration of conformity for CE-marking... 	99
14	FCC / IC Compliance Statements.....	101
14.1	Vectron POS MobilePro Terminal.....	101
14.2	Vectron POS MobilePro charging station.....	101
15	SAR.....	102
16	Supplement.....	103
16.1	Piktographs.....	103
16.2	Glossary.....	105
16.3	Document revision.....	109



I Introduction

We very much appreciate your purchase of the Vectron POS MobilePro. You have decided in favor of a high quality product that will support you in your daily work.

The Vectron POS MobilePro is a self-contained POS system which uses the same software as the stationary Vectron POS systems.

In addition, the Vectron POS MobilePro is convincing by high-quality features like wireless network communication (Wireless LAN), connection of modern mobile printers through Bluetooth, a high-resolution colour display and simplified operating functions.

Since it is technically comparable to stationary Vectron POS 64-Bit systems, you can easily integrate the Vectron POS MobilePro into an existing ECR network or establish such a network.

MobilePro
US

The high-quality electronics of the Vectron POS MobilePro is protected by a very robust magnesium housing.

In chapter 5 you get an overview on the hardware features and their handling.

This manual describes in chapter 7 how to start the Vectron POS MobilePro.

Chapter 8 informs you on how to operate the Vectron POS MobilePro.

The following chapters contain additional information, e.g. on the maintenance of the system and its components and on optional accessories.

A glossary of terms completes the manual.



Please see the instructions for use and notes on safety on the following pages.

**Note**

This manual does not contain information on the very extensive programming of the Vectron POS MobilePro. This requires detailed knowledge and is therefore incumbent on your Vectron dealer.

For all detailed questions please contact your local Vectron dealer who will be glad to assist you.

Vectron Systems AG



2 Notes on safety

When operating your Vectron POS system please follow these instructions:

- Only by means of proper positioning and maintenance, as well as operation according to the instructions for use, the safety and health of individuals and of animals and property, will not be endangered.
- Improper installation, maintenance or operation may result in injury to the user and damage to the devices.
- Maintenance and repair of the Vectron POS system is to be carried out only by trained personnel, certified by the manufacturer.
- The Vectron POS system has been manufactured to the highest possible standards. However, we cannot guarantee that the delivered components, their constituent parts and the documentation are, and will remain, free of faults.
- The manufacturer does not accept liability in case of improper installation and maintenance and improper operation of the Vectron POS system.



3 Instructions for use

Please follow these instructions.

- Only operate the POS system with the dealer installed peripherals.
 - Do not insert any foreign objects into any openings on the devices.
 - Operate the touch screen exclusively with a touch pen. Do not use biro or sharp objects!
 - Exchange the Vectron B30 battery only when the terminal is switched off.
 - Charge the Vectron B30 battery exclusively in the „Vectron POS MobilePro Charging Station“.
 - Do not leave unused batteries in the charging station.
 - If possible use the batteries to their full capacity and only charge them if the terminal asks you to exchange them.
 - The devices may not be exposed to strong heat. Ensure there is adequate cooling.
 - Do not operate the devices near strong electromagnetic fields (TVs, loudspeakers).
 - Protect the POS system from dust and humidity.
 - Clean only with a damp cloth using a mild cleanser.
 - Keep the packaging material for dispatch.
-

- In case of service please contact your Vectron dealer. When sending the device for repair always use the original packing. For damages due to improper packing the manufacturer does not accept liability.

4 Disposal

The manufacturer assumes a unilateral obligation to take back waste electric and electronic equipment that has been used for commercial purposes, consistent with Art. 9 of European Union Directive 2002/96/EC, last changed by European Union Directive 2003/108/EC. It applies:

- The manufacturer takes back waste electric and electronic equipment that was produced by or on behalf of the company and guarantees a proper recycling of this equipment.
- The legal obligation applies for devices, that will be put on the market after August 13, 2005. In addition, the manufacturer extends this obligation to all devices that have been put on the market as of January 1, 2004.
- Please hand over any waste electric or electronic equipment and any accessories or peripherals that you do not require or that cannot be used anymore to your Vectron dealer. Or send it back to the manufacturer directly, prepaid and marked "Waste electric and electronic equipment".



5 Vectron POS MobilePro

The Vectron POS MobilePro is a mobile POS system with high performance and autonomous applications. The proven Vectron POS software is also applied in the Vectron POS MobilePro. This makes mobile and stationary Vectron POS systems compatible.

In this chapter we will introduce you the Vectron POS MobilePro and explain its functions.

The charging station and its handling will be described in chapter 6.

5.1 Shipment

Standard delivery of the Vectron POS MobilePro comprises:

- One terminal Vectron POS MobilePro, equipment as per order.
- One Vectron B30 battery.
- User manual.
- Dispatch box.
- Software license as per order.



The Vectron POS MobilePro is available with different equipment. Please check the correct delivery on receipt. In case of incorrect delivery please contact your Vectron dealer.

Your dealer will supply the system and install it. You may then start working immediately.



5.2 Mode of operation and starting

The Vectron POS MobilePro is a self-contained POS system, which supports the user in his work independent of the location.

5.2.1 Mode of operation

The Vectron POS MobilePro has a very robust magnesium housing, which is designed to be dust- and waterproof.

Below the high-resolution colour display there is the keyboard with 20 keys, four of which are soft keys. The latter can be assigned individual functions. A brightness sensor activates - if required - automatically the background lighting of keyboard and display. You can take off the whole keyboard unit for cleaning without having to open the housing.

The complete systems electronics and the Vectron POS software are in the terminal, so that you can do without a base station.

The user can sign in to the POS system. This is either made per password or identification number or via the optional built-in transponder reader. This reader recognizes a user card and the Vectron POS software releases the authorization.

The user can now go to the customer and take orders or collect money. Data input and -display takes place on the high-resolution colour display with touch sensor, the so-called touch screen. The booking data is stored in the main memory. Powerful batteries and an efficient energy management avoid data loss. In addition, an integrated system battery powers the main memory with minimum current in case the battery must be exchanged.

Order data is transferred to counter or kitchen via a wireless network connection, so-called Wi-Fi. Thanks to the built-in Wi-Fi-module the Vectron POS MobilePro can easily be integrated into an existing radio network.

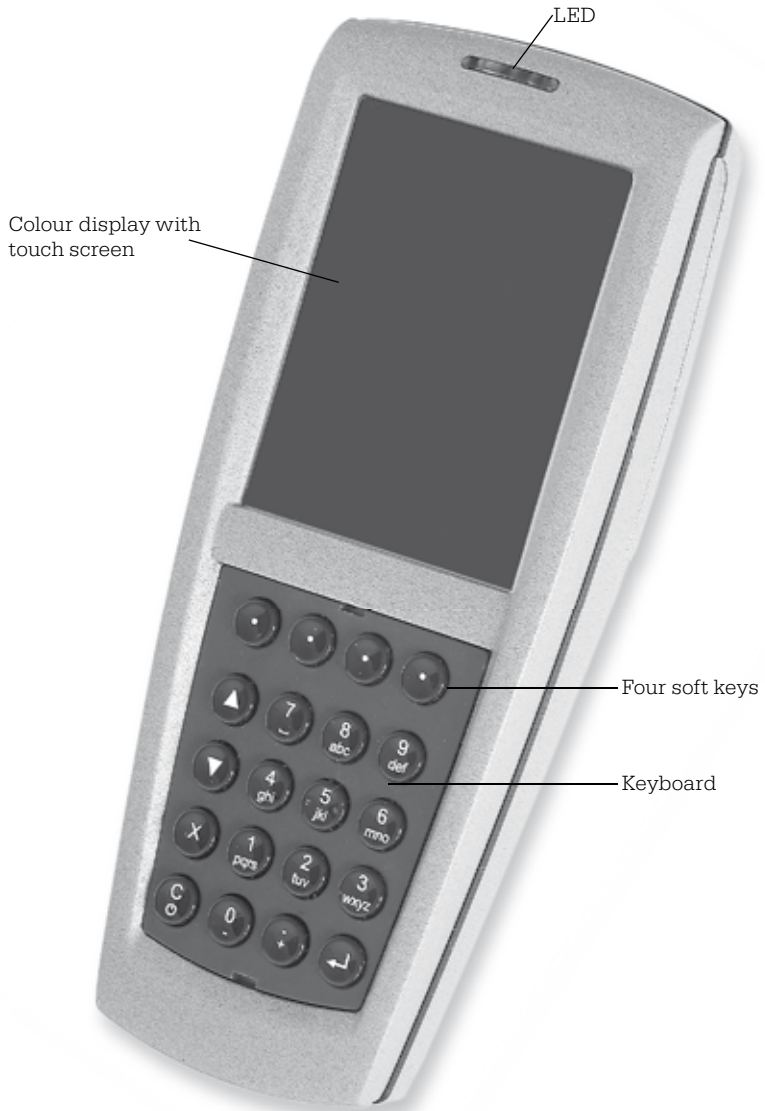

Fig. 1: Vectron POS MobilePro



The radio range is approximately 50 metres for indoor applications and up to 150 metres in open air. A permanent radio communication is not required, all data to be transferred is stored. Via a Wi-Fi connection you can also update the Vectron POS software and read out the data for further processing.

An additional integrated radio module serves for connection of mobile peripherals. Via so-called Bluetooth, e.g. mobile printers can contact the Vectron POS MobilePro via short distances.

The already mentioned optional transponder reader allows to use customer card systems. The presently used format is „Tag-it®“, other formats like Mifare® and Legic® are being prepared.

The tilt sensor facilitates the display of information for the customer. The sensor recognizes a tilt of the terminal and rotates the screen information by 180°.

The integrated SIM-card reader prepares the ground for coded data processing, which can be used e.g. for future payment systems.

The Vectron POS MobilePro has several possibilities for giving signals.

- Three LEDs in the housing serve for optical perception of battery status or warnings.
- Loudspeakers can give acoustic signals.
- A built-in vibration motor serves for an unobtrusive transmission of information.

All three signals can be configured and combined individually.

5.2.2 Power supply

The Vectron POS MobilePro is powered by the exchangeable lithium-ion-battery Vectron B30. The maximum service life is approx. ten hours. This period of course depends on the level of utilization and the configuration of the power management. Discharged batteries can be charged again in the charging station.

5.2.3 Switch on and -off

By pressing the  key the POS MobilePro is switched on and off.

For switch on press the key briefly. The three LEDs above the display blink one after the other.

In case of a new start, e.g. after battery exchange, you see the start screen.





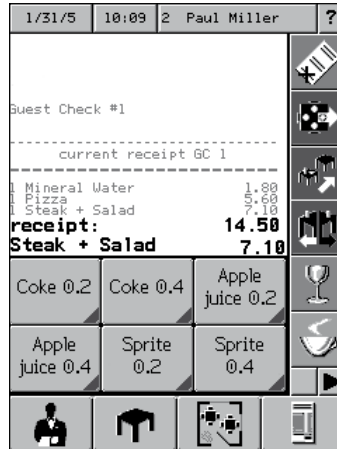

You then see the registration surface and the POS MobilePro is ready for operation.



Your registration surface may differ completely from the figure above. This depends on the programming of the POS MobilePro. Please contact your local Vectron dealer.

For switch off press the  key for two seconds or longer. This does not switch off the POS MobilePro as such but the display and an energy save mode is enabled. This saves the battery and prolongs the service life of the POS system.

On next switch on you therefore do not see the start screen but the registration surface.

For a complete switch off of the Vectron POS MobilePro you must press the  and  keys on top right simultaneously for five seconds. The blue and red LED light up for five seconds.

Then the blue and green LED start to flash parallel with approx. 1 Hz. You can now release the keys. The blue and green LED finally flash up once and go out.

The POS MobilePro is completely switched off.

5.3 Components

The Vectron POS MobilePro boasts high-quality components and a large variety of functions. In this chapter we will describe the components and their functions.

5.3.1 Display

The high-resolution colour display shows all required information. Furthermore, it has a pressure-sensitive surface for touch operation.

The colour display has a transreflective screen with active TFT-technology and a resolution of 240 x 320 pixels and 256 colours. A transreflective display is advantageous because it uses the ambient light for illumination. This saves battery supply and allows application in direct sunlight. You thus get a high-contrast and sharp picture even in case of strong light incidence. The display has a large viewing angle. Its graphical attributes allow an excellent display of photos and pictographs.

You can operate the Vectron POS MobilePro via the touch screen. All display elements can be selected by touch. You can arrange the buttons individually and assign them colours.

**Attention!****Danger of damage!**

Only touch the screen with the suitable touch pen!

Using bios or other sharp objects can damage the device!



Fig. 2: Operating the POS MobilePro with touch pen

If you don't have the touch pen at hand you can exceptionally operate the touch screen with the finger tip. However, depending on the button size this can lead to inaccurate input!

5.3.2 Keyboard and Soft keys

Another operating element of the Vectron POS MobilePro is a keyboard with 20 keys. The keyboard has a numeric pad, four soft keys, two scroll keys (line up or down) and keys for multiplication and input and Delete or On-/Off key.



Danger of damage!

The keyboard may exclusively be operated with fingers or a suitable pen!

Attention!

Using sharp objects can damage the device!

Keyboard

The keys of the POS MobilePro have the following functions:

-  ON-/OFF switch of device or Correction (delete of last character).

-  Close data input.

-  Decimal input.



..... Keys for alphanumeric input
(see chapter 11.1).



..... Scrolling up or down.



..... Multiplication key.

The keys can also be assigned different functions.

Softkeys



The four soft keys below the display can be assigned individual functions, e.g. PLU booking or operator sign in. Please contact your local Vectron dealer.

You can take out the keyboard unit for cleaning, see chapter 9.2. You do not have to open the housing.

5.3.3 Charge contacts

At the bottom of the Vectron POS MobilePro there are two charge contacts for charging an inserted battery in the station.

In order to charge the battery that is in the POS MobilePro, insert the device with the display to the top in the large medium slot of the charge station.

The green LED above the display indicates the charging. The charge contacts permanently supply the POS MobilePro with operating voltage, if it is inserted in the charge station without battery. An operation without battery is therefore possible.



Fig. 3: Charge contacts of Vectron POS MobilePro

Please heed the remarks on the cleaning of charging contacts in chapter 9.4.

5.3.4 Battery exchange

The Vectron POS MobilePro is supplied with power by the Vectron B30 battery. The battery is in a compartment at the rear of the POS MobilePro under a removable lid.

Proceed as follows to exchange the battery:

1. Press the  key for two seconds or longer until the display of the POS system switches off.
2. Turn the locking button of the compartment lid by 90° to the left until you feel a clear resistance. Take off the lid.



Fig. 4: Opening the locking button of the battery compartment

3. Take off the lid by pressing with the thumb on the lower edge of the battery compartment lid. The upper edge of the lid is lifted.



Fig. 5: Lifting the lid



4. Put one or two fingers at the upper edge of the lid and take the lid off from the battery compartment.



Fig. 6: Removing the lid

5. Depending on the design there is a notch at the bottom of the right long side (see fig. 7) or at the bottom of the battery housing (see fig. 8). Put a finger nail at the notch and press the battery to the top.



Fig. 7: Lifting the battery



Fig. 8: Lifting the battery

6. Take out the battery.

Danger of damage!



Attention!

Do not remove the battery by turning round the POS MobilePro when the compartment lid is removed and letting drop the battery out of the compartment.

This may damage the collectors of POS MobilePro irreparably.

- Slide the new battery with the charge contact surface to the front in the battery compartment.

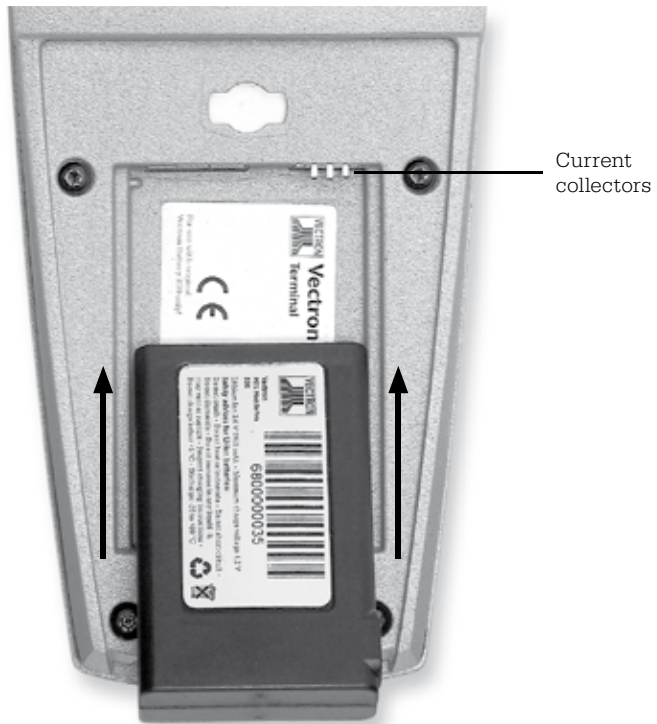

Fig. 9: Inserting the battery

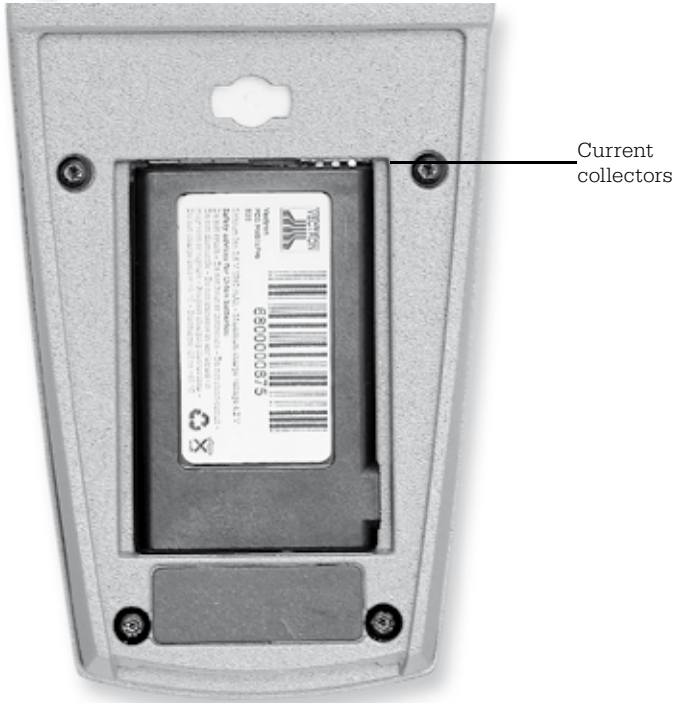

Fig. 10: Inserted battery

8. The charge contact surfaces of the battery (see fig. 21) must contact the current collectors of the POS MobilePro.
9. Put back the battery compartment lid as follows:
 - a. The battery compartment lid has at its bottom two holders. they exactly fit into the recesses left and right of the charge contacts (see fig. 3).
 - b. Put on the battery compartment lid and leave the lid half open on the top (see fig. 11).

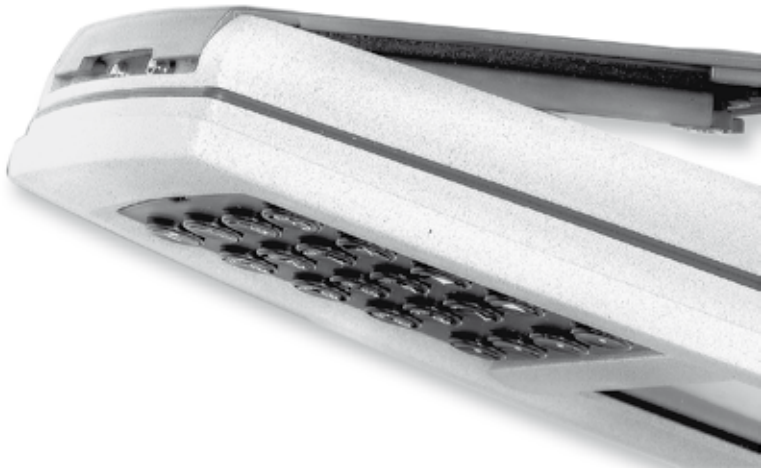

Fig. 11: Putting on the battery compartment lid

- c. Press down the locking button with one finger and turn it by 90° to the right into a horizontal position.



Fig. 12: Closing the battery compartment lid



10. Check that the battery compartment lid is fixed and seated correctly (see fig. 11). If this is not the case (see fig. 13), the Vectron POS MobilePro is not dust- and waterproof!

Furthermore there is the risk that the battery is not charged when you put the terminal into the charging station!



Fig. 13: Battery lid is not closed correctly

11. For switch on press the  key. The Vectron POS MobilePro is now ready for operation.



Caution!

Caution!

Use exclusively batteries type Vectron B30!
Risk of explosion if battery is replaced by an incorrect type!

Battery voltage display

The POS MobilePro has different possibilities to signal that the battery is low and should be exchanged. Normally a window is faded in with the request „Charge battery“. Additional optical and acoustic signals can be configured.

In running mode you can fade in a progress bar to display the voltage of the battery.

Battery protection circuit

The Vectron POS MobilePro has a battery protection circuit, which checks the voltage of a newly inserted battery. In case the battery does not have the required minimum voltage, the red LED flashes twice when being switched on (see below).

If, however, the battery exchange takes place in less than three seconds, the battery protection circuit cannot always recognize the battery exchange correctly. Here, too, the red LED would flash twice when being switched on. You should therefore take at least three seconds for the exchange of the battery. Should the POS MobilePro erroneously reject a charged battery, you can either take the battery out of the terminal for three seconds or put the terminal with the battery into the charging station for a short time. The POS MobilePro will then recognize the charged battery correctly.

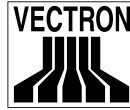

5.3.5 LED-Signals

Above the display there are three LEDs in blue, green and red. They indicate a different operating state and can be programmed individually.

Blue LED

Main function of the blue LED is to indicate new incoming messages by a slow flashing. The Vectron POS MobilePro can be configured so that messages in the ECR network can be sent and received. For instance the kitchen could inform that a meal is ready, which the waiter can now serve. Please contact your local dealer if you want your POS MobilePro to be configured accordingly.

Green LED

Main function of the green LED is to indicate the status of the inserted battery during charge in the charging station. Signals:



- Green LED on: terminal in network mode (charge station).
- Green LED off: terminal in battery mode.
- Green LED flashes: battery is charged.

Red LED

Main function of the red LED is to indicate a critical situation. There are two signals:

- Red LED flashes quickly: battery defect.
- Red LED flashes slowly for ca. 2 sec.
when switching on: battery too weak to switch on the terminal.

Combinations of the three LEDs can indicate different situations:

- Complete switch off with key combination  & :
Red and blue LED light up for approx. five seconds, then the blue and green LED flash parallel with approx. 1 Hz.
- Switch on, voltage too low:
Alternate quick flashing of red and green LED for approx. two seconds.
- Power supply in network mode too low:
Alternate slow flashing of red and green LED.

You can combine the LEDs with the other signals (loudspeaker, vibration motor).

5.3.6 Acoustic signal

The Vectron POS MobilePro has a built-in loudspeaker, which can produce polyphone tones. It is suitable for acoustic warnings.

You can configure the loudspeaker via the Vectron POS software and combine it with other signals (LED, vibration motor).

5.3.7 Vibration motor

The integrated vibration motor serves as noiseless signal. You can combine it with other signals (LED, loudspeaker).



5.3.8 Wireless LAN

The Vectron POS MobilePro has a built-in module for wireless network communication, so-called Wireless LAN. It allows to integrate the POS MobilePro in an existing Vectron POS network without having to use network cables.

The integrated Wireless LAN-module uses the widespread standard 802.11b. This allows communication with nearly all commercial Wireless LAN-peripherals, so-called Access Points.

The Vectron POS MobilePro can communicate with max. 16 different access points but not simultaneously. This is not necessary since data flow takes place from access point to access point. This guarantees that data is always sent to the correct location. Order data for instance is sent to e. g. kitchen or counter.

The range of the Wireless LAN-module is approx. 50 metres indoor and approx. 150 metres in open air. However, the range is reduced by obstacles in the environment. This can be plants and trees, windowpanes, furniture and walls or human bodies. As a general rule a Wireless LAN-connection is interference-free if there is visual contact between the communicating devices.

We recommend to mount access points at a height of at least two metres.

An interrupted Wireless LAN-connection is no restriction since you can use the Vectron POS MobilePro as autonomous POS system. The POS MobilePro stores all entries in the main memory. If data is to be transferred per Wireless LAN to other POS systems, the POS MobilePro re-establishes communication as soon as it comes into the range of the radio network. Data loss is excluded.

Finally, the Wireless LAN-module allows to update the Vectron POS software and to transfer data for further processing to the Vectron Commander.

Please contact your local dealer if you want to establish a Wireless LAN-network.

5.3.9 Bluetooth

Another integrated radio module, so-called Bluetooth, serves for communication with peripherals via short distances. This radio connection enables the Vectron POS MobilePro to contact mobile printers. Further connections to e.g. bar code scanners, PC or mobile phones are being prepared.

The range is approx. five metres. The same provisions as for Wireless LAN apply (see above): obstacles reduce the range or can interrupt communication. For a trouble-free communication there should be visual contact between the devices.



Note

The application of a Bluetooth-module requires an additional license. Please contact your local dealer if you want to connect e.g. a mobile printer per Bluetooth.

5.3.10 Transponder

The Vectron POS MobilePro can have an integrated module for a contactless card system, so-called Transponder, as an option (see chapter 10.1.2). With the transponder users can sign in to the POS system and customer cards can be recognized.

The transponder reads and writes cards without the card having to touch the transponder. The used format is „Tag-IT®“.

For reading or writing of the transponder card hold it to the rear of the terminal. The transponder is behind the dark plastic plate with the product logo.

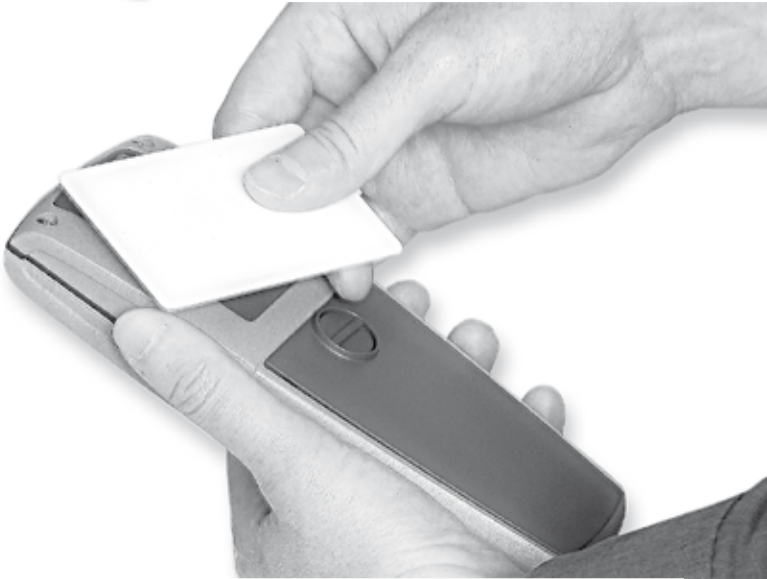

Fig. 14: Using the optional transponder

This technology can be used for user sign in and -out. The user only approaches his transponder card to the housing of the POS Mobile-Pro. The transponder module reads the card data and releases the authorization for this user.

This technology also serves to establish a simple customer card system. The customer gets a transponder card, which he approaches for each booking to the housing of the POS MobilePro. On his card points are debited or credited.



Fig. 15: Using the optional transponder

5.3.II SIM-card reader

For future applications we equipped the Vectron POS MobilePro with a SIM-card reader. It serves e.g. for a coding for cashless payment.

The card reader is under the battery compartment lid next to the current collectors.

Proceed as follows to insert a SIM-card to the reader:

1. Press the  key for two seconds or longer until the display of the POS system switches off.
2. Turn the locking button of the compartment lid by 90 degree to the left and take off the lid (see above, fig. 4).
3. Take out the battery.
4. Take the SIM-card so that the chip is at the bottom. The rounded edge points to the rear.

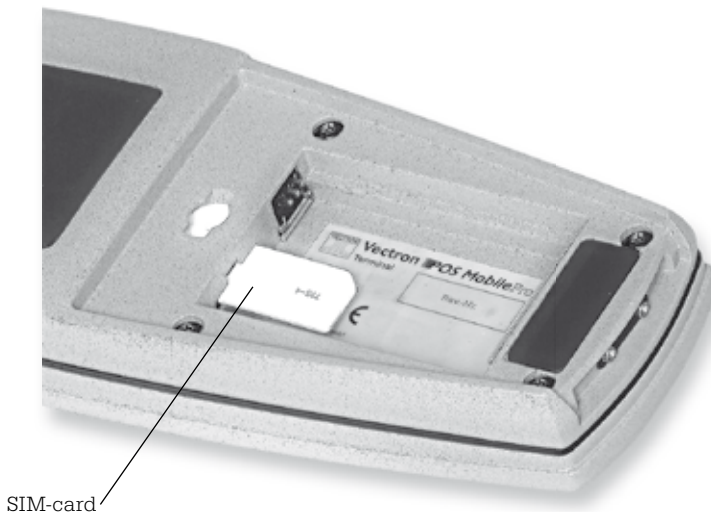



Fig. 16: Adjusting the SIM-card

5. Insert the SIM-card to the card reader.
6. Insert the battery with the charge contacts to the front into the battery compartment (see above, fig. 5).
7. Put back the compartment lid and close it.
8. To start the device press the  key. The Vectron POS MobilePro is now ready for operation.

To remove the SIM-card you require a pair of pincers. Take the SIM-card with the pincers and take it out of the reader.



Fig. 17: Removing the SIM-card

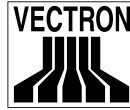

5.3.12 Brightness sensor

An integrated brightness sensor adjusts the background lighting of the display and switches on the keyboard lighting if necessary.

Here, a newly developed power management is applied, which offers various profiles for selection. Thus, you can adjust the Vectron POS MobilePro before starting work to the light conditions and you always have a clear and precise display.

Please ask your local Vectron dealer to present you the profiles under different environmental conditions.

5.3.13 Tilt sensor

A tilt sensor, which is built in the housing of the Vectron POS MobilePro recognizes changes of the horizontal position. You can thus turn the screen of the POS MobilePro by 180° if for instance you want to show the customer the invoice. A turn round the transverse axis and the display points to the bottom. You can program the POS MobilePro so that a turn of the screen switches to another layout format. Thus, you can present the customer e.g. a sorted invoice.

The tilt sensor also recognizes the vertical position of the POS MobilePro, for instance if it is stored in the leather holster. The tilt sensor then switches off the display of the POS system and enables an energy save mode.

On the other hand the tilt sensor switches the display on again if you take the POS MobilePro and bring it into a horizontal position.



Fig. 18: Vectron POS MobilePro with activated tilt sensor



5.3.14 Power management

Some of the previously presented functions and attributes of the Vectron POS MobilePro can be configured so that it switches to an energy save mode if it is not used.

Following components of the POS MobilePro can be switched on and off depending on the requirements: screen, main processor, background lighting for screen and keyboard as well as Wireless LAN- and Bluetooth-module.

For further information see chapter 7.

5.3.15 Failure of power supply

All data in the Vectron POS MobilePro is protected against a sudden failure of the power supply (e.g. removal of battery). This is guaranteed by an integrated system battery, which supplies the data memory of the POS system with minimum current.

The service life of this battery is at least five years. A data loss can therefore be excluded.

In your own interest you should re-establish the power supply in case of failure as soon as possible.

5.4 Technical data Vectron POS MobilePro

Software

- 100,000 PLUs*
- 65,535 Departments*
- 1,000 Operators*
- 65,535 Guest checks or customers*
- 200 Cash registers per network*
- 100 Printers per network*

*) The indicated values are maximum values, which can only be reached with special programming and optimum hardware equipment. Please contact your specialist dealer to assist you with your special requirements.

- Intelligent, partly sensor-controlled power management (brightness- and tilt sensor).
- On- and Offline mode incl. synchronization of order- and print data.
- Improved functions for direct PLU keys via alphanumeric codes.
- Support of Bluetooth peripherals (printers).
- USB backup via ECR network.
- Paging function combined with Vectron ServiceCall.
- Simplified order input through additional touch functions.
- Power management with various profiles for energy saving.

Hardware

- 3.5" TFT-Display with 256 colours, background-lighted, transflective, resolution 240 x 320 pixels.
- Analogue-resistive 4-wire touch panel.
- Keyboard with 20 keys (4 soft keys); background-lighted.
- Magnesium diecast housing, dust- and waterproof.
- 64-Bit Processor with 131 MHz clock frequency.
- 4 MB SRAM (battery-buffered), optional 8 MB.
- 8 MB FlashROM for system software.



- Bluetooth interface for connection of printers. Bluetooth standard 1.1, range approx. 5 meters. Further connections e.g. to bar code scanners, PC or mobile phones are being prepared.
- WLAN network interface, standard 802.11b, transfer rate up to 11 Mbit/s.
- Optional transponder module with 13,56 MHz for a contactless card system (customer cards, operator sign-in etc.); Tag-it[®] standard.
- SIM-card reader.
- Exchangeable 3.6V Li-Ion battery with 1950 mAh, max. operating time 10 hours.
- License memory module.
- Loudspeaker (digitized tones).
- 3 LEDs (red, green, blue) for indication of warnings, messages etc.
- Vibration motor.
- Brightness sensor to control background- and keyboard lighting.
- Tilt sensor to control screen display and -switch off.
- Temperature range -10° ... +50°C.



At the beginning of series production not all of the functions and attributes are available. Please contact your local dealer in case of questions.

Dimensions

- Depth approx. 1.06 in
- Dimensions in inches

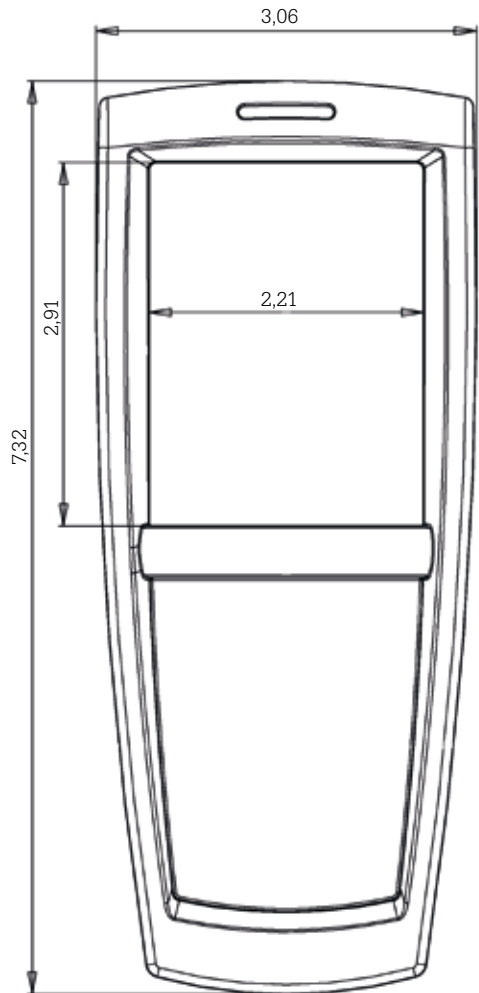

Weight

- approx. 300 g resp. 0.66 lb (incl. battery)



6 Charging station and batteries

The most important accessories of the Vectron POS MobilePro are charge station and batteries. While a battery is comprised in the shipment of the POS MobilePro, the charging station can be purchased separately.

6.1 Shipment

The charging station is delivered as follows:

- One Vectron POS MobilePro Charging Station for charging of two batteries and one terminal.
- External power supply Vectron PS20 with country-specific plug.
- Dispatch box.

MobilePro
US

6.2 Mode of operation

The batteries of the Vectron POS MobilePro are charged in the charging station. This station has two lateral slots for external batteries. In the medium large slot you can charge the battery that is in the Vectron POS MobilePro. You can operate the POS Mobile Pro during charging.

LEDs indicate the operating and charge status.

Charging time is approx. 2,5 hours.

The housing of the charging station is made of plastic and has a metal ground plate.

Four rubber feet at the bottom ensure a fixed, horizontal position. Alternatively you can mount the charging station at the wall. For this purpose you require a mounting angle.



Fig. 19: Charging station for Vectron POS MobilePro



Fig. 20: Terminal and one battery in charging station

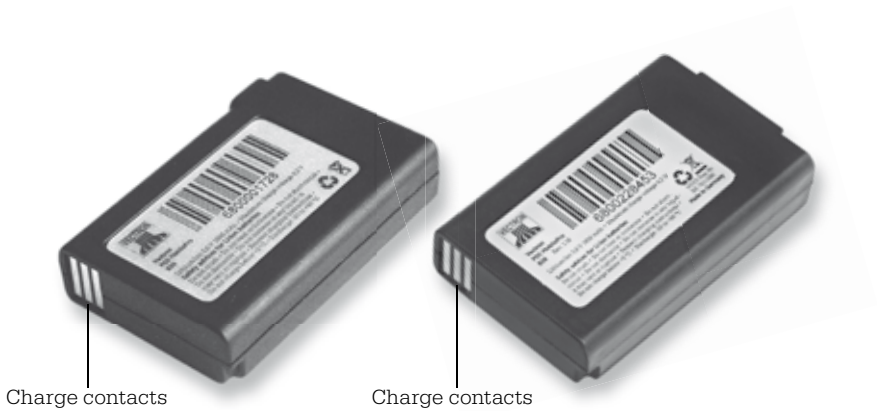

Fig. 21: Battery Vectron B30 - old and new housing shape



Fig. 22: Power supply Vectron PS20

The shape of batteries and slots of the charging station match each other; you cannot insert the batteries the wrong way round.



Attention!

Danger of damage!

For the power supply of the charging station please use exclusively the Vectron PS20 power supply.

Using other devices may damage or destruct the charging station.

6.3 Charging

1. Connect the charging station with the Vectron PS20 power supply to the network. The green LED below the left battery slot designated „Power“ indicates the readiness for operation.
2. Insert one or two batteries carefully into the lateral slots of the charging station. Make sure that the charge contacts are at the front of the bottom. You must see the product label at the right side. The yellow LED (charge control, designated „Charge“ and „End“) flashes slowly.
3. You can charge a third battery, if this is in the Vectron POS MobilePro. Insert the terminal with the charge contacts to the bottom into the station. The green LED above the display flashes.
4. The charging takes approx. 2,5 hours. It is finished when the respective control lamp is permanently on.

Notes

1. The inserting of fully charged batteries to the lateral slots may cause different reactions of the yellow LED: In one slot the battery is immediately recognized as fully charged, the LED is permanently on. In the other slot this recognition may take up to one minute; the LED flashes for the time being. This is due to minimum manufacturing tolerances at the charge contacts of the charging station and does not indicate an error.
2. The charging procedure depends on the temperature. Outside a temperature range of approx. 0°...45°C the charging station interrupts the charging. Please make sure that charging station and batteries are not used outside this temperature range. A thus interrupted charging will be continued automatically.



6.4 Service life of batteries

The Vectron B30 battery is a high-quality, rechargeable Lithium-Ion-battery. To reach its maximum capacity they should be discharged completely three to four times and then charged again.

Symptoms which indicate an exhaustion of the battery capacity:

- The battery must be charged in ever shorter intervals.
- The Vectron POS MobilePro suddenly switches off and can only be used with a newly charged battery. The error message „Battery empty“ is no longer displayed.
- The Vectron POS MobilePro does not react to switch on.



Attention!

Important note:

Exhausted or damaged batteries cannot be repaired but need to be exchanged and disposed of properly!

Tips for a long service life of the batteries:

- If possible use the batteries until the Vectron POS MobilePro fades in the message „Battery empty“ or - when having configured the capacity progress bar - the bar turns red.
- Always charge the discharged batteries completely. This status is indicated by permanently illuminated control lamps.
- Batteries that are not used for a longer period (approx. 2 - 3 months), should be charged to max. 30 %. For this purpose the discharged Vectron B30 must be charged for approx. 40 minutes. Afterwards do not store the battery in the charging station.

6.5 Technical data

- Charging station for simultaneous charging of one terminal Vectron POS MobilePro and two Vectron B30 batteries.
- POS MobilePro can be operated during charging.
- Charging time approx. 2,5 h.
- PC-ABS-plastic housing with metal ground plate.
- Four rubber feet.
- Two charge control lamps (yellow LED).
- One green LED for readiness for operation.
- Power supply via external Vectron PS20.
 - input voltage 90 - 240V.
 - output voltage 24V, max. 1,25A.
- Permissible supply voltage: 12 - 30V.
- Max. power consumption depending on voltage.
- Max. wattage 30W.
- Temperature range (operating condition) 0° ... 40°C.



Dimensions

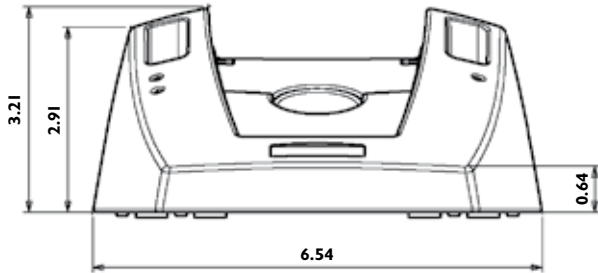

Front view - dimensions in inches

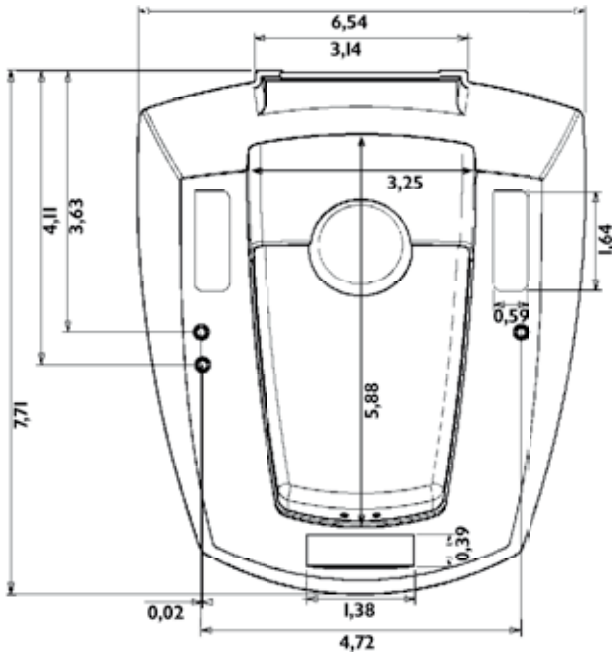

View from top - dimensions in inches

Weight

- approx. 600 g resp. 1.32 lb (without battery and terminal)

7 Putting into operation

In this chapter we will explain how to start the Vectron POS MobilePro.

**Note**

Your local Vectron dealer has already made the preparational work so that the Vectron POS MobilePro is ready for operation. Please ask him to assist you with the first starting.

Please check in particular the following aspects with your local dealer:

1. Make sure your POS system is equipped according to your order.
2. The Vectron POS MobilePro is basically designed to work in an ECR network. In this network you require at least one access point, which establishes a wireless network connection between stationary Vectron POS systems or Vectron POS PC and Vectron POS MobilePro. Please heed the following:
 - a. **Configuration of the access point**

Please ask your dealer to configure the access point so that a wireless network connection between the participating Vectron POS systems can be established.
 - b. **Installation of access point**

Select a central set up site. The access point should be installed in min. 2 m height, measured from bottom.
 - c. **Compatibility**

Prerequisite for operating the Vectron POS MobilePro in an ECR network is that all participating Vectron POS systems use the same Vectron POS software version. For technical reasons, version Vectron POS 4.0.1.0 or higher must be used.



3. The Vectron POS MobilePro has specific profiles. They serve to adjust power save modes and signals to your requirements.

a. **Power save profile**

This profile determines whether and how the background lighting of the display shall be dimmed. You can select between „high“, „medium“, „low“ and „none“. The power saving from „high“ to „none“ decreases continuously because the background lighting is increased step by step.

b. **Signal profile**

This profile determines the signaling of error messages, messages or keyboard- and button use. Decisive here are the environmental noises. You can select between „Normal environment“, „Loud environment“ and „Quiet environment“.

- Normal environment: Signal per loudspeaker
- Loud environment: Signal per loudspeaker and vibration motor
- Quiet environment: Signal per vibration motor and blue LED

Please ask your local dealer to adjust the profiles according to your requirements.

4. Charge a Vectron B30 battery (see above, chapter 6.3).
The charging takes approx. 2,5 hours. It is finished when the respective control lamp is permanently on.
5. Take the battery out of the lateral slot and insert it to the Vectron POS MobilePro (see above, chapter 5.3.4, no. 2 - 4, 7 - 10).
6. Or you take the Vectron POS MobilePro with inserted battery out of the medium slot.
7. Switch on the POS MobilePro by pressing the  key.

8. During the start you see the start screen. You may also hear a start melody.



9. You then see the registration surface and the POS MobilePro is ready for operation.



Your registration surface may differ from that above. This depends on the programming of the POS MobilePro. Please contact your Vectron dealer.

Your Vectron POS MobilePro is now ready for operation.

8 Operating the POS system

In this chapter you get an overview on the functions of your Vectron POS system and an introduction in the basic operational procedures. Normally, your Vectron dealer has adjusted the POS system according to your requirements. Some operations at your POS system may therefore be completely different to those described in this manual. In this case ask your Vectron dealer who will explain the functions particularly installed for you.

**Note**

The buttons on the touch screen display their functions mainly by small pictographs, so-called icons. The icons contained in the Vectron POS software and their meaning are explained in the supplement.

8.1 Sign in and -out at the POS system

Before you can make any entries the clerk has to sign in at the POS system. This allows you to trace at any moment which clerk is responsible for which entries. Different clerks can get different authorizations, e.g. void.

There are different ways to sign in and -out at the Vectron POS MobilePro.



8.1.1 Sign in by transponder card

In case your Vectron POS MobilePro has a built-in transponder reader, you can sign in to the POS system with the transponder card. Hold the card to the rear of the terminal. The transponder is behind the dark plastic plate with the product logo.

If the POS system is programmed to require a secret clerk number you now have to enter this secret number and confirm with <Enter> or .



8.1.2 Sign in without transponder card

You can sign in at the POS system without transponder card if you have been assigned a clerk number and a key is not compulsory. Enter your clerk number and press the <Clerk> or  key. You may have to enter a secret number and confirm it with <Enter> or .

8.1.3 Sign out

Clerk sign out is made by:

- approaching the transponder card again,
- closing the receipt,
- pressing <Clerk> or .

8.2 Guest checks and hold buffers

Guest checks and hold buffers serve to store several invoices simultaneously. This function is often required in restaurants, to store the goods consumed for each guest check.

In retail, it can also be useful to store several invoices simultaneously, if for instance in a bakery there is only one cash register for several clerks. In a supermarket, if a customer forgot his wallet in his car, the entire sale can be stored temporarily in a “hold-buffer” so that other customers can be serviced until the customer returns with his wallet.

8.2.1 Starting a new GC



To open a new guest check, enter the number and depress the <GC> key or .

8.2.2 Close and re-open a GC

By pressing the <GC> key or  the guest check is closed. Depending on the programming, the order is now printed on different printers, e.g. at the counter or in the kitchen. The POS system is now open for other orders.

If you want to re-open a GC to make further entries, repeat the steps (see above).



8.2.3 Paying a guest check

To pay a GC, open it again (see above). If you open a GC again the balance is displayed. If you now press the <Cash> key or  or any other media key, the invoice is printed and all PLUs are deleted from the GC. Before pressing the <Cash> key or  you can enter the amount the customer gives you and the change is displayed.

Depending on the programming of your POS system, there are several other possibilities. For instance you can first print a subtotal invoice and then print the total invoice after the guest decided on the mode of payment.

8.2.4 Guest check split

It may often be necessary to split the guest check, if for instance one guest wants to leave earlier than the others. For these cases you have the function "G.C. Split". This function is only available for clerks who have been vested with the according authorization.

To split a GC it must be opened anew. If necessary, close the GC and open it again. Press <GC split> or . Select the PLUs to be split via the direct PLU or the PLU numbers. After having selected all PLUs finalize the split with <Cash> or  or any other media key. The invoice is printed.

It may happen that a guest changes to a different table. You may then split PLUs from one guest check to another. Proceed as described above, however enter the guest check number to which the



PLUs are to be transferred before pressing <G.C. Split> or . Store the split with <GC> or .

8.2.5 Guest check move

Rather than splitting single PLUs from one check to another, “Check Move” allows the entire check to be moved to another guest check. The clerks must be vested with the according authorization. Proceed as follows:

1. Open the GC to be moved. If the GC has already been opened, close it with <GC> or and open it again via GC number and <GC> key or . G.C. moves can only be carried out if the G.C. is opened anew.
2. Enter the target GC number and press <Check move> or . The GC that has been moved is closed automatically.

8.2.6 Shift change

Shift change means that a guest check is transferred to another clerk (e.g. change of shift). Open the guest check that is to be transferred. Enter the number of the clerk to whom the guest check is to be transferred and press <Shift change> or .

8.2.7 Hold buffers

To open a hold buffer press the respective key. By means of the hold buffer keys you can switch between the individual hold buffers. To close a hold buffer press a media key.

Depending on the programming of the POS system a hold buffer is automatically assigned to a certain clerk. In this case the hold buffer change is automatically carried out if a new clerk signs in.

8.3 Reports

The Vectron POS System offers various reports for a determined period or selected clerks. You can select reports via the <Mode> or <M> key or via other special keys and print them. .

It is also possible to read reports by means of the PC program Vectron Commander and to process them on the computer.



Note

It depends on the programming and on the clerks' authorization which reports can be called. Please contact your Vectron dealer.

By pressing the <Mode> or <M> key you can select between „X-reports“ and „Z-reports“.

“X-reports” are interim reports, the memory is not deleted. All data is kept for further reading and processing.

“Z-reports” are final reports, the memory is reset to zero and the report cannot be restored!

After choosing either an X-report or a Z-report, you may decide which report is to be printed. The following are short descriptions of some of the most common reports:

Operators (Menu Operators etc.)

An overview of the financial data for each operator.

Single operator (Menu Operators etc.)

An overview of the financial data for only one operator.



Operator invoices (Menu GCs/invoices)

Shows the invoices that were created by each operator in the reporting period.

- An **X-report** creates a subtotal invoice with the guest check still open for service.
- A **Z-report** creates a final invoice and closes the guest check.

Open guest checks (Menu GCs/invoices)

Lists all guest checks that have not yet been paid.

Invoices (Menu GCs/invoices)

Shows all invoices that were created in the reporting period.

- An **X-report** creates a subtotal invoice with the guest check still open for service.
- A **Z-report** creates a final invoice and closes the guest check.

Hourly report

Indicates the turnover per hour.

Transactions

Gives an overview of the financial data, including turnover, taxes and cash in drawer totals.

Departments, PLUs, Main groups

Shows financial data according to department, PLUs or Main groups.

Journal

Records all actions carried out at the POS system (programming and financial data) since the last Z-report.

For Transactions, Operators, Operators (single), Departments, PLUs, Main groups and Hourly report you can select between different report levels. For instance there may be a level for daily reports and another level for weekly reports. At the end of a day you can print the Z-reports of level 1, at the end of a week those of level 2. For some reports you may also select an evaluation range and print the report only for selected PLUs.



Please note that due to the amount of data, the printing of invoices, clerk reports and journals may take quite some time.

8.4 Input and output

8.4.1 Input of amounts

Amounts are generally entered into the POS system with two decimals. The dot can also be omitted. For ten Dollars enter "1000" or "10.00", for 3.95 Dollars "395" or "3.95".

8.4.2 Screen windows

Depending on the programming different windows are available on the screen. The most important will be explained here. By means of the key <go to (window)> you can switch between the individual windows or select new ones.

MobilePro
US

Overview on open GCs / open hold-buffers

Displays all those GCs and hold-buffers which have been opened by the currently signed-in clerk. It also shows the total sales for each GC or hold-buffer.

Receipt window

Displays the current receipt or invoice.

Info window

Displays the last entry or information on current actions such as "Void" or "GC split".

Input window

Here you enter amounts or PLU numbers.

GC window

Displays all PLUs of the currently opened GC that have not yet been paid.



8.5 Making a sale

The usual procedure is as follows:

- PLUs or prices are entered,
- the sale is invoiced and passed to the customer,
- the customer pays.

The details of each of these steps are explained in the following. A clerk must be signed-in (see above).

8.5.1 Input of PLUs

There are different ways to enter PLUs:

- Enter the PLU number and press <PLU> key or ^{PLU}.
- Use the direct PLU key (e.g. <Coke 0,2 l>).
- Select a PLU per alphanumeric short cut (see chapter 11.1).
- Scan the bar code of the PLU.



8.5.2 Free price input

When you enter a PLU (see above), it will sell for its preset price. You may also enter a different price, e.g. for goods with small faults that you want to sell cheaper.

Free price input can be locked at your POS system or only be possible for selected clerks.

To carry out free price input, enter a price and select the corresponding PLU or department. Before selecting PLU or department you may have to press the <Price> button.

8.5.3 Payment

The booking is closed if all PLUs have been entered and the customer wants to pay. The signed-in clerk can now display the subtotal by pressing the <Subtotal> key or . The sum is told to the customer. Enter the amount you got from the customer and press <Cash> or . The change is displayed and the receipt is printed. If the customer pays the exact amount you can directly depress <Cash> or  without entering an amount.

If the customer does not pay cash, press the respective media key, e.g. <EC> or <Visa> instead of <Cash> or .

8.6 Void and merchandise return

Void and merchandise return are similar functions.

Void serves to cancel entries.



Merchandise return is a negative account where goods are taken back and money is paid out or deducted from the open balance.

Void and merchandise return can only be carried out by clerks who have been vested with the corresponding authorization.

8.6.1 Correction

Pressing the <Correction> key or  deletes the last entered PLU.

8.6.2 Void

If you wish to delete another PLU press <Void> or . Select the PLU to be deleted via direct PLU key or PLU number (see above). If you want to delete additional PLUs, press the <Void> key or  again.



8.6.3 Merchandise return

For merchandise return it is decisive whether you book to a guest check or not. When working in a guest check, it is only possible to return those PLUs that have previously been sold on this guest check. When working in a cash sale, you may return any PLUs.

To carry out a merchandise return press the <Merchandise Return> key. The further procedure is identical with "Void".

8.7 Change invoice format

Your dealer has adapted the invoice format according to your requests. It may sometimes be necessary to change the format, e.g. to print a receipt for entertainment expenses. In this case press the <Change invoice format> key before closing the invoice.

8.8 Programming the POS system

Improper changes in the programming of the POS system can cause unwanted erratic behaviour during operation.

In order to avoid this, only authorized service staff should have access to the programming area. Vectron POS systems are programmable in a way that safety keys, passwords and unambiguous access restrictions can be assigned individually for every user.

Please contact your local Vectron dealer to advise you with safety precautions that are useful for your company.



8.9 Final remark

We hope that we were able to give you some helpful information about your Vectron POS system. Due to the numerous programming possibilities, the description had to be quite general and the information restricted to the main functions. Your Vectron dealer will gladly answer any of your questions.

Please visit us on the web at www.vectron.de. Here you get additional information and you can send us your inquiries via E-Mail.

9 Service and maintenance

The Vectron POS MobilePro does not contain any parts that can be serviced by the user. Please leave all maintenance and service to your Vectron dealer.

**Attention!**

Danger of damage!

Do not carry out any maintenance or service on your own. Only authorized service staff may open the housing.

9.1 Cleaning the display

To clean the display of your Vectron POS system please use a clean, soft cloth, soaked with isopropyl alcohol if necessary.

**Attention!**

Danger of damage!

Do not use chemical cleansers or cleansers containing solvents or benzene!

9.2 Cleaning the keyboard

You can take off the keyboard for cleaning without having to open the housing of the Vectron POS MobilePro. You require a thin tool like e.g. a screw driver.

We recommend to store the POS MobilePro in the charging station so you can use both hands for taking off the keyboard.

Proceed as follows:

1. At the upper and lower edge of the keyboard grid you see a thin notch. Put the tip of the screw driver into the upper notch. To protect grid and housing place a small rubber- or plastic strip under the screw driver. Carefully lift the keyboard grid to the top by pressing down the screw driver.



Fig. 23: Lifting the keyboard grid

2. Put the tip of the screw driver into the lower notch and put the strip under the screw driver. Carefully lift the keyboard grid to the top.



Fig. 24: Lifting the keyboard grid

3. Take off the keyboard grid. You can see the keyboard pad with the 20 keys of the Vectron POS MobilePro.



Fig. 25: Removed keyboard grid

4. The further procedure depends on whether the POS MobilePro has a removable keyboard pad or not. You can find it out by trying to remove it (see fig. 26).
 - a) **Removable keyboard pad**

Take off the keyboard pad (see fig. 26). Clean the keyboard compartment with a brush. If you want to clean the keyboard pad you can take off the key caps. You can clean the keyboard pad with a brush.



Fig. 26: Removing the keyboard pad

b) **Unremovable keyboard pad**

As of week 12/2006 the POS MobilePro is produced without removable keyboard pad. The keyboard pad is glued fixed to the keyboard compartment. In this case take the key caps off the keyboard pad (see fig. 27). Clean the pad with a brush.



Fig. 27: Unremovable keyboard pad

5. Use a (damp) cloth to clean the key caps.
The keyboard grid can also be cleaned with a cloth.



Attention!

Danger of damage!

Do not use chemical cleansers or cleansers containing solvents or benzine!

- Put the caps back to the keyboard pad (see above, fig. 1).
The exact seating of the caps is guaranteed by a small shape at the inside which matches the notch of the button.



Fig. 28: Putting on the key caps

- Vectron POS MobilePro with removable keyboard pad:**
Put back the keyboard pad. Two holes near the upper and lower edge ensure it is seated exactly.

8. Inserting the keyboard grid is a bit difficult and must be done with utmost precision.

The keyboard grid has at its lateral edges two tongues of approx. 8 mm length. These tongues must be inserted to the lateral grooves of the keyboard compartment.

Start at one side.

tongues



Fig. 29: Inserting the keyboard grid

9. Press the keyboard grid at the other side into the compartment until the tongues lock in the groove.



Fig. 30: Fixing the keyboard grid

10. Check that the individual keys are seated correctly in the keyboard grid. They may not jam, otherwise you cannot operate the Vectron POS MobilePro correctly.

The Vectron POS MobilePro is now ready again for operation.



9.3 Cleaning the housing

The magnesium housing of the Vectron POS MobilePro is equipped with a display and has some plastic parts at front and rear. It is therefore well protected against dirt and must only be cleaned if it is very filthy.

To clean the housing use a damp cloth which is soaked with a mild cleanser. Wipe the dirty surface with the cloth.

Danger of damage!



Attention!

Do not use chemical cleansers or cleansers containing solvents or benzene!

Otherwise the plastic parts of the housing and the display could be damaged.

9.4 Cleaning the charge contacts

The cleaning of charging contacts can considerably prolong the service life of terminal and charging station. Dirty charging contacts impede the charging and may cause a stronger heating and damage of the charging station.

Please check the charging contacts of the terminal regularly and if necessary clean them with a spirit-soaked cotton bud.

Danger of damage!



Attention!

Do not use benzene, solvents or chemical cleaning agents!

9.5 Careful handling of the terminal

In a restaurant, particularly in hectic times, a careless handling may damage or even destroy the terminal. We would therefore like to give you some hints how to protect the Vectron POS MobilePro and thus prolong its service life.

- Do not put the device on a tray with drinks! When serving your guests you may drop glasses and the moisture could damage the device. The POS MobilePro is designed to be waterproof. Yet, it is not designed to be permanently operated in a wet environment. Always carry the POS MobilePro in the optionally available leather holster. This protects the device against humidity and other damage.
- Although carried in the leather holster you cannot exclude that the display is damaged as long as it is not turned to the body. In narrow rooms or during hectic hours you may easily hit tables, counter or other obstacles. The display can scratch until you cannot use it anymore.
Always carry the POS MobilePro with the display turned to the body to protect it from scratches!

10 Accessories

By using high-quality accessories you can perfectly adjust the Vectron POS MobilePro to various requirements.

On the following pages we will present you the accessories available for the POS MobilePro.

You can purchase the accessories from your local Vectron dealer. He will assist you with the configuration of POS system and accessories.

10.1 System accessories

Following items are available:

- Charging station incl. power supply.
- Battery.
- Transponder
- Touch pen.
- Multi-function touch pen.

10.1.1 Charging station and batteries

We described the „Vectron POS MobilePro Charging Station“ incl. power supply „Vectron PS20“ and batteries „Vectron B30“ in chapter 6.



10.1.2 Transponder

We already mentioned the transponder reader of the Vectron POS MobilePro several times (see chapter 5.3.10). It serves for sign in of clerks or for reading customer cards.

The transponder is not included in the standard delivery; however, it can be built-in or retrofitted ex-works.

10.1.3 Touch pen

The touch pen is made of resistant plastic with a rounded tip. It is particularly suitable for operating the touch screen of the Vectron POS MobilePro.



Fig. 31: Touch pen

10.1.4 Multi-function touch pen

The multi-function touch pen is touch pen and biro all in one. By turning the rear part of the cap you can select between cartridge and touch.



Fig. 32: Multi-function touch pen

10.2 Additional accessories

Following additional accessories are available for the Vectron POS MobilePro:

- Mobile thermal printer Vectron MP20.
- Leather holster (to be combined with belt).
- Safety swirl.

10.2.1 Mobile thermal printer Vectron MP20

The mobile thermal printer Vectron MP20 is connected via Bluetooth to the POS MobilePro and communicates directly with the terminal.



Fig. 33: Mobile Thermal printer Vectron MP20

A clip at the rear allows you to wear the printer at the belt. It requires customary thermal paper and can store and print logos. Its housing is light, yet robust and is splash-proof.

10.2.2 Leather holster

To protect the Vectron POS MobilePro we can offer a special leather holster.

This holster can be combined with a belt and allows to carry the POS MobilePro comfortably at the hip.



Fig. 34: Leather holster

The holster is made of robust cowhide to store the terminal as well as touch pen and multi-function touch pen.

The metal lug at the side serves to mount a chain to hold the terminal in case it falls down. The chain can be mounted to the Vectron POS MobilePro by means of a fastening swirl (see below).



Fig. 35: Leather holster with terminal, touch pen and multi-function touch pen



Fig. 36: Belt

10.2.3 Safety swirl

For the Vectron POS MobilePro a safety swirl is available. The safety swirl is mounted at the housing instead of one of the torx screws. By means of a safety strap the POS MobilePro can be carried out around the waist.



Fig. 37: Safety swirl

The swirl turns freely, adjusting to body motion without inhibiting the work process.



Attention!

Danger of damage!

Do not use metal safety straps. When touching the magnesium housing of the POS MobilePro they may cause severe and irreparable damages.



II Special functions for Vectron POS MobilePro

In addition to the already mentioned profiles (see chapter 7) some special functions for the Vectron POS MobilePro have been integrated in the Vectron POS software. These functions support the problem-free operation of the POS system particularly in connection with other Vectron POS systems. We will explain them in the following:

- Alphanumeric short cuts.
- Print data server.
- Offline GCs.

II.1 Alphanumeric short cuts

Alphanumeric short cuts allow an easy and fast booking of PLUs via a combination of numbers. Several letters and numbers are assigned to each number of the numeric keyboard:

0 -0
 1 pqrs1
 2 tuv2
 3 wxyz3
 4 ghi4
 5 jkl5
 6 mno6
 7 _7
 8 abc8
 9 def9



If e.g. you want to book a coke, press key 8. All PLUs starting with A, B or C are displayed. Now press key 6. All PLUs starting with AM, AN, AO, BM, BN, BO, CM, CN or CO are displayed. The PLU „Coke“ should appear on top of the selection list and you can use the touch pen to select and book the PLU.

Prerequisite is that alphanumeric short cuts have been enabled in the Vectron POS software. Please contact your Vectron dealer.

**Note**

Alphanumeric short cuts follow the letter-number-combination of mobile phones.

11.2 Print data server

A print data server receives print data from a terminal, which cannot process and print the data. Technical procedure:

1. Data is entered at the terminal (= Vectron POS MobilePro), the processed data is to be printed.
2. The printer is connected to a stationary Vectron POS system, which is connected to the terminal via Wireless LAN.
3. The stationary POS system receives the unprocessed print data, processes it and prints it on the connected printer.

Advantage of this method is the reduction of data amount. The terminal is relieved and independent of a Wireless LAN-connection.

Otherwise the terminal itself would have to process the print data and send it to the printer via stationary POS system. During this time the Wireless LAN-connection could be interrupted and the print job would not be transmitted in time.

Prerequisite is that the print data server function in the Vectron POS software has been enabled. Please contact your Vectron dealer.



11.3 Offline Guest Checks

This function reserves GCs in an ECR network for some time for exclusive operation by one POS system.

For the Vectron POS MobilePro this means that it can be assigned defined GCs before leaving the Wireless LAN-radio range. This can be made manually or automatically with operator sign in. The operator always finds his GC range in the POS MobilePro and can serve these GCs. This GC range is blocked for the other POS systems or users for the time being.

If the user wants to release again his GC range, e.g. when returning to the Wireless LAN-radio range, this can also be made manually or automatically with operator sign out.

Prerequisite is that the Offline-GC-function has been enabled in the Vectron POS software. Please contact your Vectron dealer.

12 Additional Vectron products

Here we would like to inform you on additional Vectron products, which are designed to perfectly complete the Vectron POS MobilePro.

12.1 Stationary Vectron POS systems

Stationary Vectron POS systems with fast and reliable 64-Bit hardware are ideally applied as single stations. Being perfectly suitable as server they allow data exchange with the Vectron POS MobilePro.

The chart below lists the most important performance data of stationary and mobile systems.

	Vectron POS System			
	ColorTouch	Mini	Vario	MobilePro
Colour display	●	●	●	●
Touch screen	●	●	●	●
Customer display	○	○	○	○
64-Bit Processor	●	●	●	●
SRAM, extendable	2 MB, ●	2 MB, ●	2 MB, ●	4 MB, ●
DRAM	64 MB	64 MB	64 MB	64 MB
FlashROM	8 MB	8 MB	8 MB	8 MB
Network	Ethernet LAN	Ethernet LAN	Ethernet LAN	WLAN
Ports				
• serial	6	6 ○	6	○
• parallel	1	1 ○	1	○
• USB	2	2	2	○
• Cash drawers	2	2	2	○
• PS/2	1	1	1	○
• Bluetooth	○	○	○	●
Transponder	○	○	○	●
Int. card reader	○	○	○	●
Power management	○	○	○	●
Clerk lock	●	●	●	● ¹⁾

● = standard equipment, ○ = optional, ○ = not available.

¹⁾ To be realized via transponder reader.



For further information on stationary Vectron POS systems please refer to the Internet under www.vectron.de.

12.2 Vectron POS PC

Vectron POS PC imports the Vectron POS software to your PC. You only need a PC with Microsoft® Windows® operating system. The advantage of Vectron POS PC is that you can use the Vectron POS software simultaneously with E-Mail-, office- and stock control programs. This allows data exchange within seconds.

For further information on Vectron POS PC please refer to the Internet under www.vectron.de.

12.3 Vectron Commander

The Vectron Commander is a communication- and evaluation software for PCs with Microsoft® Windows® operating system. Via its connection to the Vectron POS system the Vectron Commander can call and evaluate the ECR data. At any time you can get an overview on sales-, order- or working time data etc.

For further information on the Vectron Commander please refer to the Internet under www.vectron.de.



13 EC-declaration of conformity for CE-marking

For the device

Vectron POS MobilePro

We declare that the device complies with the essential requirements as stipulated in the Council directives on electric and electronic products:

1. **89/336/EEC - EMC-Directive**
2. **73/23/EEC or 93/68/EEC - Low Voltage Directive**
3. **1999/5/EU - RTTE-Directive**

Applied standards:

Ad 1 (Electromagnetic compatibility):

- EN 61000-3-2 (2000) and EN 61000-3-3 (1995 + App.) Only for power supply.
- EN 301489-03 V1.4.1 - EMC - SRD.
- EN 301489-17 V1.2.1 - EMC - Wireless LAN & Bluetooth.

Ad 2 (Electric safety):

- EN 60950-1 (2001).

Ad 3 (Radio- or transmitter test):

- EN 300 328-2 V1.2.1 - Wireless LAN & Bluetooth.
- EN 300 330-2 V1.1.1 - SRD.
- EN 50371 (2002) - Restrictions of human exposure to electromagnetic fields.

100



Vectron POS Mobile^{Pro}



This declaration is signed for the Manufacturer / Importer by:

Vectron Systems AG

Jens Reckendorf

A handwritten signature in black ink, appearing to read "J. Reckendorf". The signature is fluid and cursive.

Thomas Stümmler

A handwritten signature in black ink, appearing to read "T. Stümmler". The signature is highly stylized and cursive.

Münster, 6 July 2005.



14 FCC / IC Compliance Statements

14.1 Vectron POS MobilePro Terminal

Section 15.21 Information to user

Changes or modifications not expressly approved by the party responsible for compliance could void the user's authority to operate the equipment.

Section 15.19 Labelling requirements

This device complies with Part 15 of the FCC Rules.

Operation is subject to the following two conditions:

- (1) this device may not cause harmful interference, and
- (2) this device must accept any interference received, including interference that may cause undesired operation.

MobilePro
US



Attention!

The Vectron POS MobilePro can only send with one of the available transmitters at a time.

The software cannot address two or more transmitters simultaneously.

The label with the ID information can be found in the battery compartment.

14.2 Vectron POS MobilePro charging station

Section 15.105 (b)

Note: This equipment has been tested and found to comply with the limits for a Class B digital device, pursuant to part 15 of the FCC Rules. These limits are designed to provide reasonable protection against harmful interference in a residential installation. This equipment generates, uses and can radiate radio frequency energy and, if not installed and used in accordance with the instructions, may



cause harmful interference to radio communications. However, there is no guarantee that interference will not occur in a particular installation.

If this equipment does cause harmful interference to radio or television reception, which can be determined by turning the equipment off and on, the user is encouraged to try to correct the interference by one or more of the following measures:

- Reorient or relocate the receiving antenna.
- Increase the separation between the equipment and receiver.
- Connect the equipment into an outlet on a circuit different from that to which the receiver is connected.
- Consult the dealer or an experienced radio/TV technician for help.

This Class B digital apparatus complies with Canadian ICES-003.
Cet appareil numérique de la classe B est conforme à la norme NMB-003 du Canada.

15 SAR

SAFETY INFORMATION FOR RF EXPOSURE

Body-worn operation has been tested and meets the FCC RF exposure guidelines when used with the Applicants accessories supplied or designated for this product as listed in the filing.

Use of other accessories may not ensure compliance with FCC RF exposure guidelines. The SAR values are measured and keeps the limit values.

16 Supplement

16.1 Piktographs

The Vectron POS MobilePro has installed a set of icons, which can be used in registration mode. The chart below lists the available icons.

Icons and their meaning

Icon	Meaning	Icon	Meaning
	Clear		Seat number
ESC	Escape	PLU	PLU
	Take away		Invoice
	Cancel receipt		Load invoice
	Receipt copy		Recall invoice
	Guest count		Invoice copy
	Inhouse		Seat split
	No invoice		Void
	Clerk		Correction
MNG	Manager funct. only		GC
	Open GC/Clerk		GC 0



Icon	Meaning	Icon	Meaning
	GC split		Side dishes
	Shift change		Beer
	GC move		Icecream
	Table plan		Fish
	Enter GC text		Meat
	X-report		Drinks
	Z-report		Main courses
	Temp. invoice		Dessert
	Subtotal		Pizza
	Cash		Spirits
	Cold drinks		Starters
	Hot drinks		Wine

The software of the POS MobilePro can also use self-created or edited icons of a second icon set. You can either display these icons on buttons or link them to a PLU.

These icons must be edited and brought to a defined format. Please ask your local dealer if you want to create and use your own icons.

16.2 Glossary

- Access Point** Central radio node in a wireless network, which for a certain range supplies the terminals with the wireless network connection.
- Background lighting**..... Serves to make visible the content of LCD-screens even under bad light conditions.
- Bar code**..... Information is coded by means of a certain sequence and width of bars. Mainly used for packaging, contains specific product information, e.g. on content, price etc. The scan code is read with a special scanner.
- Battery** Rechargeable battery.
- Bluetooth**..... Technology for wireless transfer of information via short distances. The Bluetooth-technology uses a freely available radio network and works with 2.45 GHz.
- CE** With the CE-mark a manufacturer confirms that his products were produced in conformity with EU standards and regulations. The abbreviation CE stands for **C**ommunauté **E**uropéenne.
- Clerk key**..... For sign in and out of the clerks.
- DRAM**..... In a dynamic RAM (DRAM) the electric charge must be refreshed with a refresh pulse to keep the data in the memory cells.



- E**thernetStandardized network protocol, used for connecting computers and networks per coaxial cable.
- F**CC**F**ederal **C**ommunications **C**ommission: American authority for approval of communication devices.
- F**lashROM.....Special memory type for system- and application software. Can do without current source or requires only a button cell.
- I**cons.....Icons are small pictographs, which on GUIs symbolize a function (file, program etc.). A touch or click on the icon calls the function.
- L**CD**L**iquid **C**rystal **D**isplay. A layer of liquid crystals is given in between two foils. When a voltage passes through these crystals, they change the angle of optical refraction.
- L**ED.....**L**ight **E**mitting **D**iode = semiconductor emitting light when power is fed.
- M**ain memoryImmediate access storage which loses its content when switching off the current.
- N**etworkGroup of computers that are connected via different lines and share common resources like data and peripherals.
- P**ixelSmallest element of a digital image with defined coordinates for location and colour.



- Port.....Physical or logical connection within a system or between several systems for exchange of information.
- POS.....**P**oint **o**f **s**ale.
- Power management.....Setting to switch on and off components depending on the requirements in order to save energy. For the Vectron POS MobilePro e.g. screen, processor, background lighting, Wireless LAN and Bluetooth.
- S**canner.....Device for reading and forwarding bar codes. The scanner is connected to a computer or POS system.
- SIM-card reader.....**S**ubscriber **I**dentify **M**odule. Device which by means of a SIM-card recognizes authorizations and identifies users.
- Soft keys.....Keys of the Vectron POS Mobile and POS MobilePro, which can be assigned any function.
- Software.....Heading for any type of computer programs.
- SRAM.....Static RAM. A permanent quiescent current preserves the stored information. In switch off mode, this quiescent current is maintained by a battery that is mounted on the main board.
- T**erminal.....Monitor for data display, connected to the central computer; data processing and -storage is made via the central computer. We distinguish:
- Dumb terminals, which only have screen and keyboard but not an own data processor. Data processing is made by the central computer
 - Intelligent terminals correspond more or less to a complete computer.



- TFT** **T**hin **F**ilm **T**ransistor. Display technique which offers a higher contrast and a better image than customary flat screens.
- Touch screen** Pressure-sensitive screen with input function.
- Transflection** Design of LCD-screens. They use the ambient light for the illumination of the display. Saves battery current and allows application under direct sunlight.
- Transponder** Device for wireless communication which reads incoming data contactless and can write on the data carrier.
- UL** **U**nderwriters **L**aboratories. American Organization for examination and certification of products and their safety, particularly in the field of electrical engineering.
- Update** Software-update.
- Wireless LAN** **W**ireless **L**ocal **A**rea **N**etwork. Designation for wireless network according to standard IEEE 802.11.
- X-report** An interim report, the memory is not deleted. All data is kept for further reading and processing.
- Z-report** A final report, the memory is reset to zero and the report cannot be restored.

16.3 Document revision

Date	Modifications
01.06.2005	First creation and publication.
21.06.2005	<ul style="list-style-type: none">• Technical data of charging station corrected.• Keyboard images corrected.
21.07.2005	Notes on charging procedures added.
26.07.2005	Notes on safety for battery Vectron B30 added.
11.10.2005	Notes on battery protection circuit added.
18.11.2005	Note for correct closing of battery compartment lid added (fig. 9).
06.12.2005	Chapter 10.2.3 added.
16.12.2005	Chapter 10.1.3 revised.
30.01.2006	Chapter 10.2.3 expanded.
27.02.2006	Chapter 10.2.1 revised.
01.04.2006	<ul style="list-style-type: none">• Techn. data adjusted (4 instead of 8 MB SRAM).• Chapter 9.2 expanded.
10.05.2006	Chapter 13 added.
31.05.2006	<ul style="list-style-type: none">• Chapter 5.3.3 expanded.• Chapter 9.4 added.



Date	Modifications
14.08.2006	<ul style="list-style-type: none">• Article numbers removed.• Fig. 31 added.• Note on safety for safety straps added.
13.09.2006	Stylus and multi-function stylus renamed.
19.04.2007	<ul style="list-style-type: none">• Chapter 5.3.4 expanded.• Techn. data adjusted.
19.11.2007	<ul style="list-style-type: none">• Bluetooth information updated.• Chapter 10.2.3 removed.• Figures 19 and 21 revised.
22.07.2008	<ul style="list-style-type: none">• Chapter 8.3 corrected.• Chapter 10.1 corrected.• Glossary revised.
