

**VENSTAR®**

**DIGITAL  
THERMOSTAT**



**COMMERCIAL  
THERMOSTAT  
T2800**

**7-DAY  
PROGRAMMABLE**

**UP TO 3-HEAT  
& 2-COOL**

**HEAT  
COOL & HEAT  
PUMP**

- Control up to 3 Heat & 2 Cool Stages
- 3 Configurable Outputs
- Adjustable 2nd & 3rd Stage Timers & Deadbands
- Backlit Display & Button Legends
- Aux Heat Indicator
- Set Point Limiting
- Outdoor Sensor Ready with High/Low Readouts for the Day
- Accepts EZ Programmer™
- Accepts Optional Humidity
- Module: Controls Humidification and Dehumidification
- Accepts Optional IR Remote Control
- Accepts Comfort Call™ Phone Control Accessory

**Meets Commercial California Title 24**

- Use with most Air Conditioning & Heating Systems including: 1 or 2 Stage Electric Cooling & 3 Stage Gas Heating, Heat Pump, Electric or Hydronic Heat.



**OWNER'S  
MANUAL**

© Venstar Inc. 08/07

**VENSTAR®**



**CAUTION**

Follow the Installation Instructions before proceeding.  
Set the thermostat mode to "OFF" prior to changing  
settings in setup or restoring Factory Defaults.



**CAUTION**

NEVER PUT MORE THAN ONE  
JUMPER ON THE SAME MISC  
JUMPER BLOCK!

THIS MAY DAMAGE YOUR  
THERMOSTAT.



**NOTE:** Due to variations in environmental conditions, it is not  
always possible to achieve the desired humidification or  
dehumidification setpoint.

This device complies with Part 15 of the FCC Rules. Operation is  
subject to the following two conditions: (1) this device may not cause  
harmful interference, and (2) this device must accept any interference  
received, including interference that may cause undesired operation.

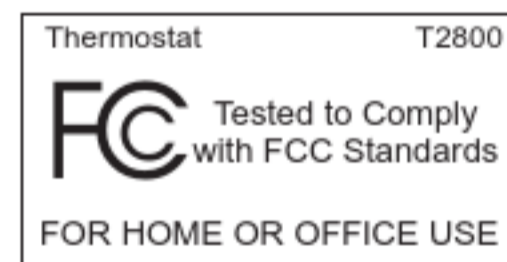

## How to Use This Manual

**VENSTAR®**

The Table of Contents divides the thermostat features into sections making it easier to quickly find information.

The first page of each section contains a more detailed list of the contents within that section, such as the example page shown below.

The diagram shows a page layout for Section 14. At the top is a header bar with 'SECTION 14 Timers and Deadbands' on the left and the 'VENSTAR' logo on the right. Below the header is a 'Section 14 Contents:' section with a bulleted list of five items, each followed by a page number. A small black tab with the number '14' is positioned to the right of the list. At the bottom left of the page is 'Page 14.1'. Callout arrows point to the header, the list items, the '14' tab, and the page number.

**SECTION 14**  
*Timers and Deadbands* **VENSTAR®**

**Section 14 Contents:**

- *Adjusting the Heat/Cool Differential.....14.2*
- *Adjusting the Cycles Per Hour.....14.3*
- *Adjusting the Deadband.....14.4*
- *Adjusting the Minutes of Run-Time Before the Next Stage.....14.6*
- *Selecting 2nd Stage Turn Off Temperature.....14.7*

14

Page 14.1

Header shows section # and title of section

Section contents

Visible section tab on the side of the page

Section and page #

In addition, this manual also has an Index to help you find any information regarding this thermostat quickly.

**Auto-Changeover:** A mode in which the thermostat will turn on the heating or cooling based on room temperature demand.

**Configurable Output Jumper:** Using jumpers on the thermostat you can configure the MISC1, MISC2, and MISC3 terminals to control humidification, dehumidification, 2nd stage cooling, and 3rd stage heating.

**Cool Setpoint:** The warmest temperature that the space should rise to before cooling is turned on (without regards to deadband).

**Deadband:** The number of degrees the thermostat will wait, once setpoint has been reached, before energizing heating or cooling.

**Dehumidify:** To reduce the amount of moisture in the air.

**Differential:** The forced temperature difference between the *heat setpoint* and the *cool setpoint*.

**Heat Setpoint:** The coolest temperature that the space should drop to before heating is turned on (without regards to deadband).

**Humidify:** To increase the amount of moisture in the air.

**Icon:** The word or symbol that appears on the thermostat display.

**Mode:** The current operating condition of the thermostat (i.e. Off, Heat, Cool, Auto, Program On).

**Non-Programmable Thermostat:** A thermostat that does not have the capability of running the *Time Period Programming*.

**Programmable Thermostat:** A thermostat that has the capability of running the *Time Period Programming*.

**Temperature Swing:** *Same as Deadband.*

**Time Period Programming:** A program that allows the thermostat to automatically adjust the *heat setpoint* and/or the *cool setpoint* based on the time of day.



## *Table of Contents*

**VENSTAR®**

<i>Quick Start</i>	<b>1</b>
<i>Getting to Know Your Thermostat</i>	<b>2</b>
<i>Setting Clock and Day</i>	<b>3</b>
<i>Basic Operation</i>	<b>4</b>
<i>Viewing Temperature and Humidity Sensors</i>	<b>5</b>
<i>Programming the Daily Schedule</i>	<b>6</b>
<i>Programming the Fan Operation</i>	<b>7</b>
<i>Thermostat Display Options</i>	<b>8</b>
<i>Humidification</i>	<b>9</b>
<i>Dehumidification</i>	<b>10</b>
<i>Viewing Equipment Run-Times</i>	<b>11</b>
<i>Electric Heat and Heat Pump Operation</i>	<b>12</b>
<i>Timers and Deadbands</i>	<b>13</b>
<i>Energy Save Operation</i>	<b>14</b>
<i>Programming the Run-Time Alerts</i>	<b>15</b>
<i>Programming the Holiday Mode</i>	<b>16</b>
<i>Configuring the MISC Outputs</i>	<b>17</b>
<i>Factory Defaults, Calibration, and Sensors</i>	<b>18</b>
<i>Accessories</i>	<b>19</b>
<i>Advanced Setup Table</i>	<b>20</b>

**Section 1 Contents:**

- *Setting the Clock and Day.....1.2*
- *Selecting the Heat or Cool  
Mode.....1.3*
- *Selecting Your Desired  
Temperature.....1.4*
- *Using the Fan Button.....1.4*

*Note: Following the instructions in this section will allow you to operate your thermostat using the factory default settings. These settings are depicted in the illustrations throughout this manual.*

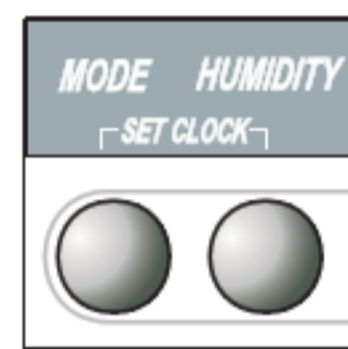

Press the **MODE** and **HUMIDITY** buttons at the same time

*During Setup & Programming:  
Pressing the UP or DOWN buttons will modify the flashing selection.*

### Setting the Clock



### Setting the Day



Press the **MODE** and **HUMIDITY** buttons at the same time to return to normal operation.

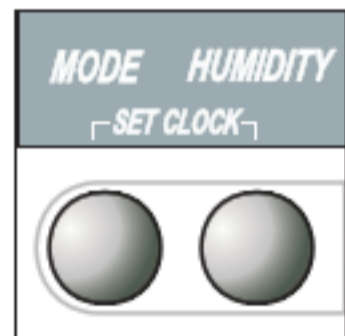

To adjust the Clock or Day use  
Press **MODE** Buttons.

To adjust the time by hours press and hold the **FAN** button while pressing the UP or DOWN buttons.



**1** *Selecting the Heat or Cool Mode*

**Select Mode by Pressing the MODE Button**

**Heating Only**

The **HEAT** setting indicates the temperature the room has to reach before the furnace will turn on to heat the room.



**Cooling Only**

The **COOL** setting indicates the temperature the room has to reach before the air conditioner will turn on to cool the room.

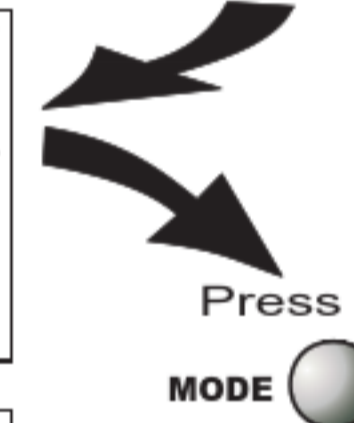

**Heating or Cooling**  
**AUTO** will automatically select heat or cool based on room temperature demand.

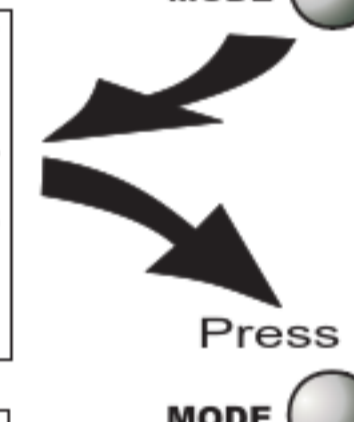

**Time Schedule for Heating or Cooling**  
**Program On** will activate the stored timer operation for the heating and cooling setpoints. (occupied or unoccupied periods)

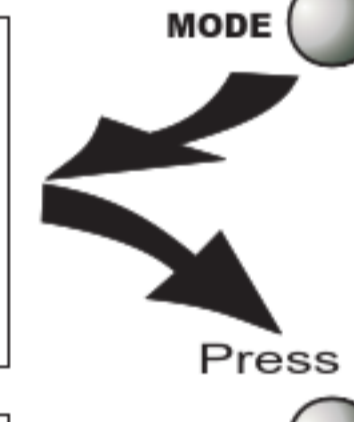

**Off**  
**OFF** indicates both heating and air conditioning systems are turned off.



*Selecting Your Desired Temperature  
(adjusting the setpoints)*

**AUTO OR PROGRAM MODE**

Pressing the UP or DOWN buttons in Auto or Program mode will adjust **both** the heat and cool set temperatures simultaneously.



Adjust the desired set temperature with the



buttons.

**HEAT OR COOL MODE**

Pressing the UP or DOWN buttons in Heat or Cool mode will adjust only the heat or cool set temperature.



Adjust the desired set temperature with the



buttons.

*Using the Fan Button*



Press  
FAN

**Fan On** indicates constant fan operation. If Fan On is selected the fan will run continuously at all times, except in Off, **and** will only run if there is a heating or cooling demand in Unoccupied periods. Pressing the FAN button toggles this feature on or off.

**SECTION 2**  
*Getting to Know Your Thermostat*

**2**

**VENSTAR®**

**Section 2 Contents:**

- *Front Panel Buttons*.....2.2
- *Display Features*.....2.3

*Front Panel*

**2**

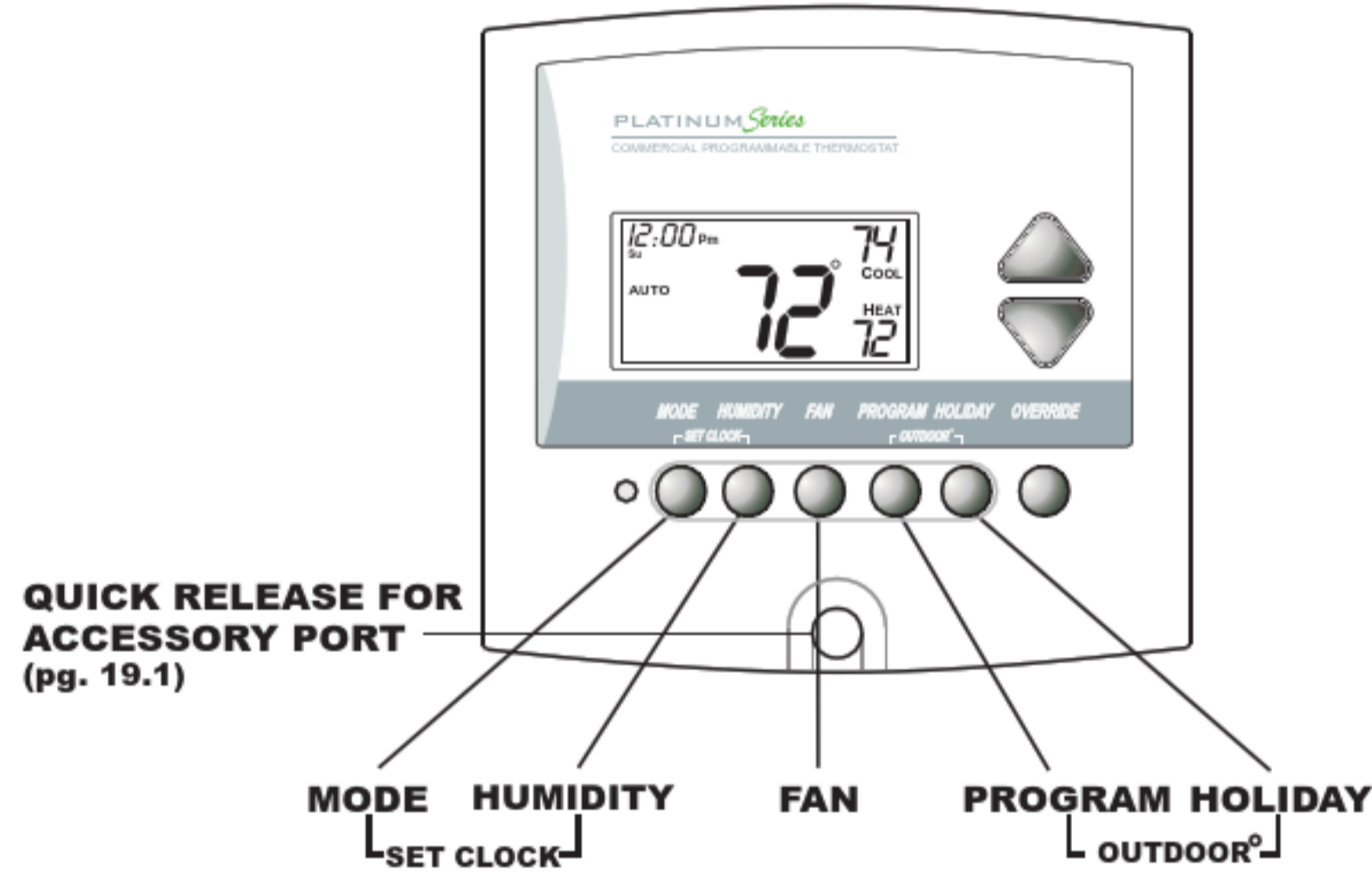
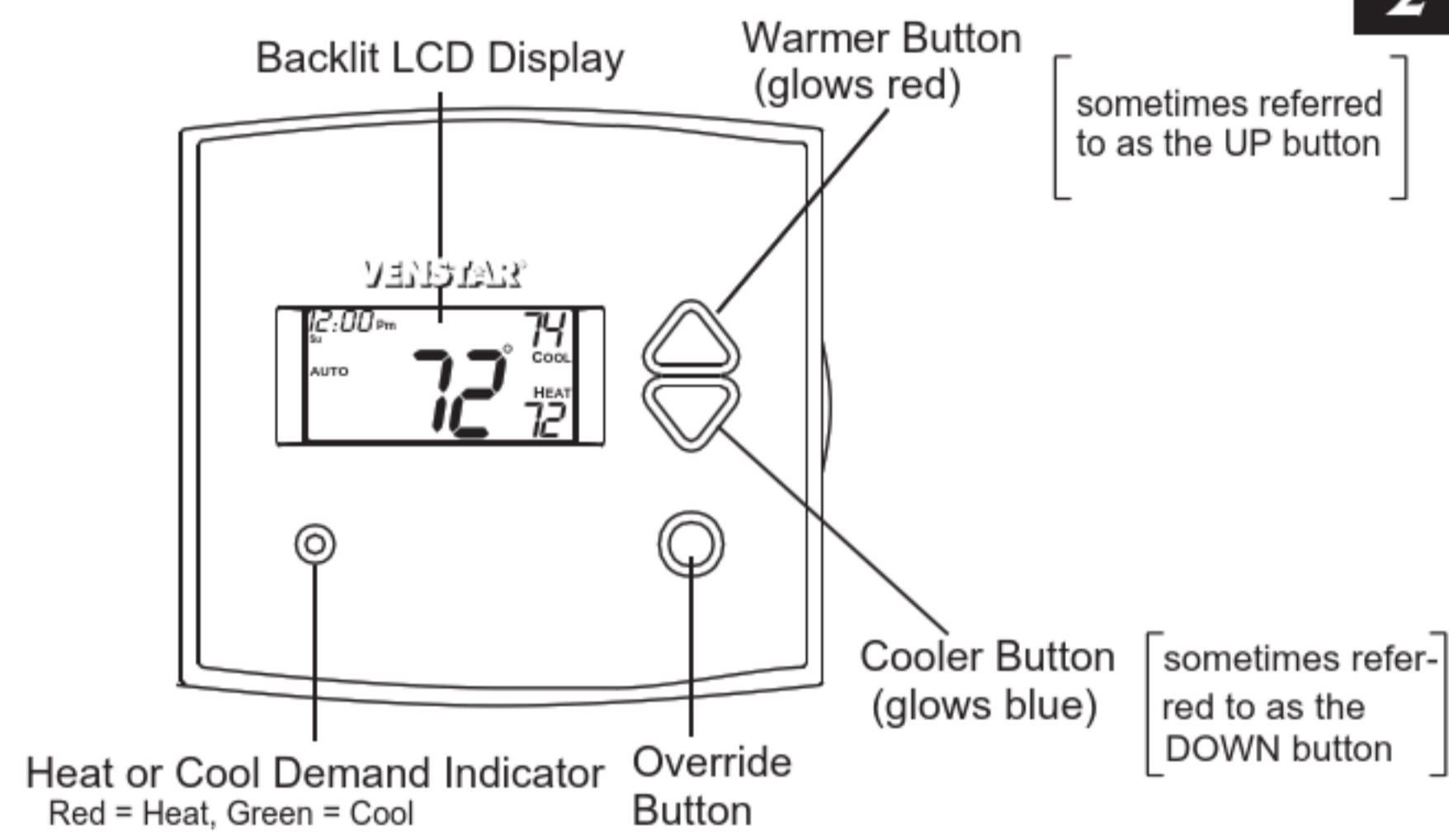

*Display Features*

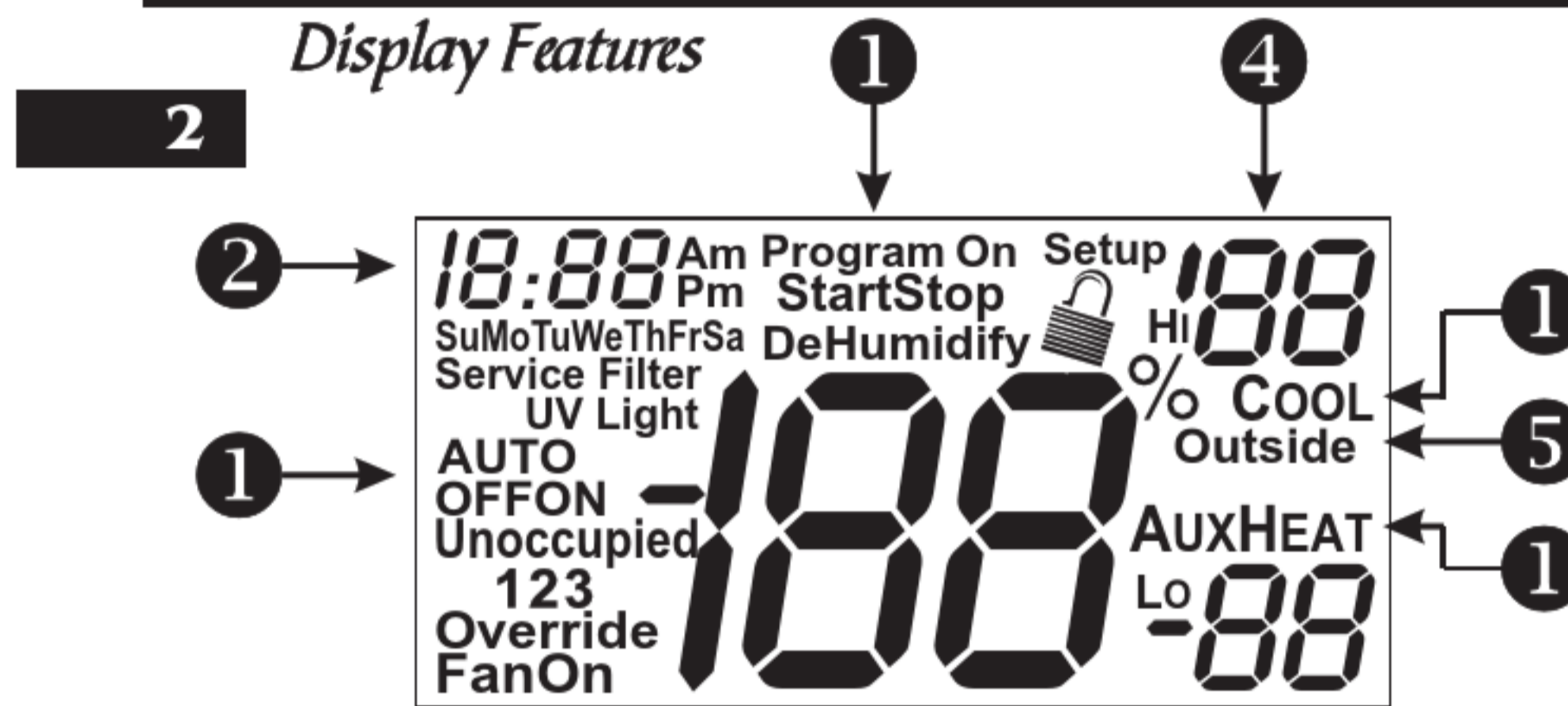

- 1** Mode Indicators - *Section 4*  
 Selects the operational mode of the equipment.  
**HEAT** - Indicates the heating mode.  
**COOL** - Indicates the air conditioning mode.  
**AUTO** - Indicates the system will automatically changeover between heat and cool modes as the temperature varies.  
**OFF** - Indicates heating and cooling is turned off.  
**PROGRAM ON** - Indicates the time period program is enabled to run.
- 2** Clock with Day of the Week - *Section 3*  
 Indicates the current time and day. This clock is also used to program the time period schedule.
- 3** Room Temperature Display - *Section 5*  
 Indicates the current room temperature and displays the outdoor temperature when selected.
- 4** Desired Set Temperature - *Section 4/5*  
 Indicates desired room temperature(s). Also displays the daily highest and lowest outdoor temperatures.
- 5** **Outside** icon - *Section 5*  
 Indicates the temperature displayed is from the optional outdoor sensor.

*Display Features*

**2**

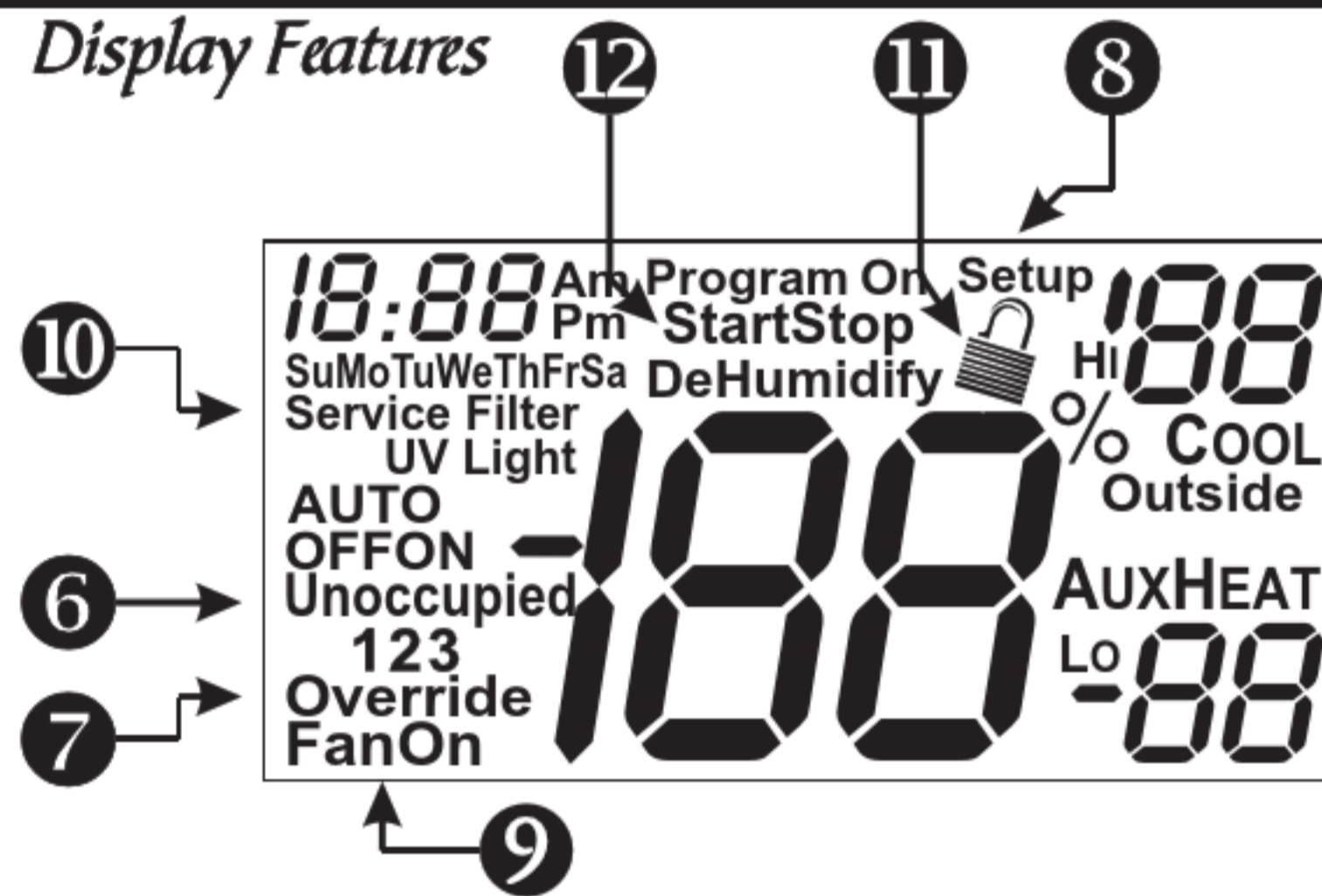

- ⑥ **Occupied & Unoccupied** icons - *Section 6*  
Indicates the program number: Occupied 1,2,3,or Unoccupied.
- ⑦ **Override** icon - *Section 6*  
Indicates the program is currently being overridden for up to 4 hours.
- ⑧ **Setup** icon - *Sections 7-15*  
Indicates the thermostat is in the setup mode.
- ⑨ **Fan On** icon - *Section 7*  
Indicates constant, continuous fan operation. When **Fan On** is not lit - indicates the fan will only operate when necessary to heat or to cool.
- ⑩ **Service Filter** icon - *Section 15*  
Appears when the filter should be serviced under normal conditions. Adjustable from 0 - 1950 hours of blower operation.
- ⑪  icon - *Section 8*  
Indicates keypad has been locked.
- ⑫ **StartStop** icon - *Section 6*  
Appears when programming occupied time periods.

*Display Features*

**2**

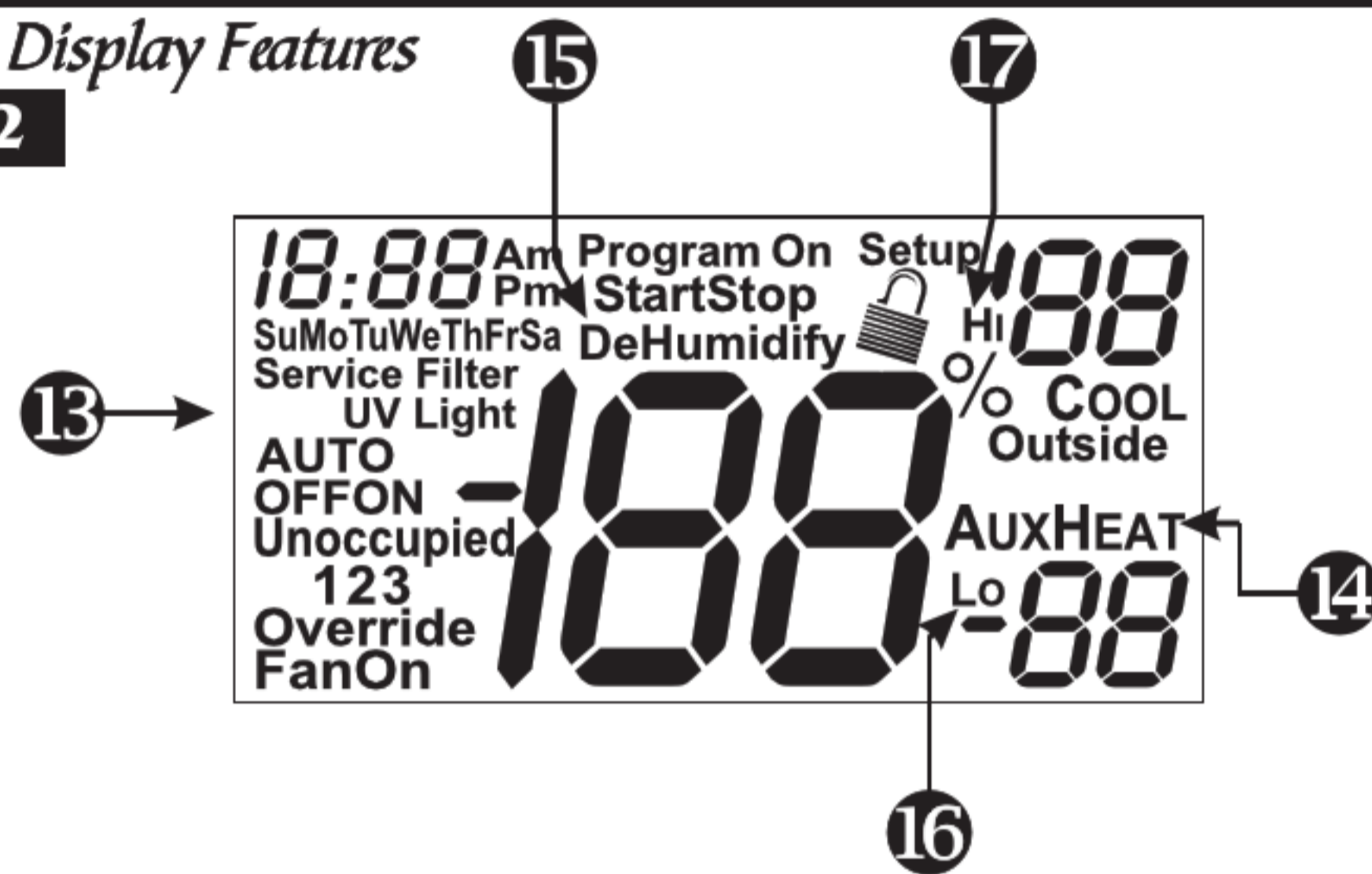

- 13** **UV Light icon** - *Section 11/15*  
Appears when the UV bulb should be serviced under normal conditions. Adjustable from 0 - 1950 days of operation.
- 14** **AuxHeat icon** - *Section 12*  
Indicates 2nd stage electric strip heat is being used when the thermostat is programmed for Heat Pump operation. Only the **Aux** icon will appear during Cool to Dehumidify to indicate Reheat operation.
- 15** **Humidify/DeHumidify icon** - *Sections 9-10*  
Indicates the system is currently humidifying/dehumidifying the air.
- 16** **Lo icon** - *Section 5*  
Indicates the lowest recorded outdoor temperature for the day.
- 17** **Hi icon** - *Section 5*  
Indicates the highest recorded outdoor temperature for the day.

**SECTION 3**  
*Setting the Clock and Day*

**VENSTAR®**

**3**

**Section 3 Contents:**

- *Setting the Clock*.....3.2
- *Setting the Day*.....3.2

*Note: During setup & programming pressing the UP or DOWN buttons will modify the flashing selection.*



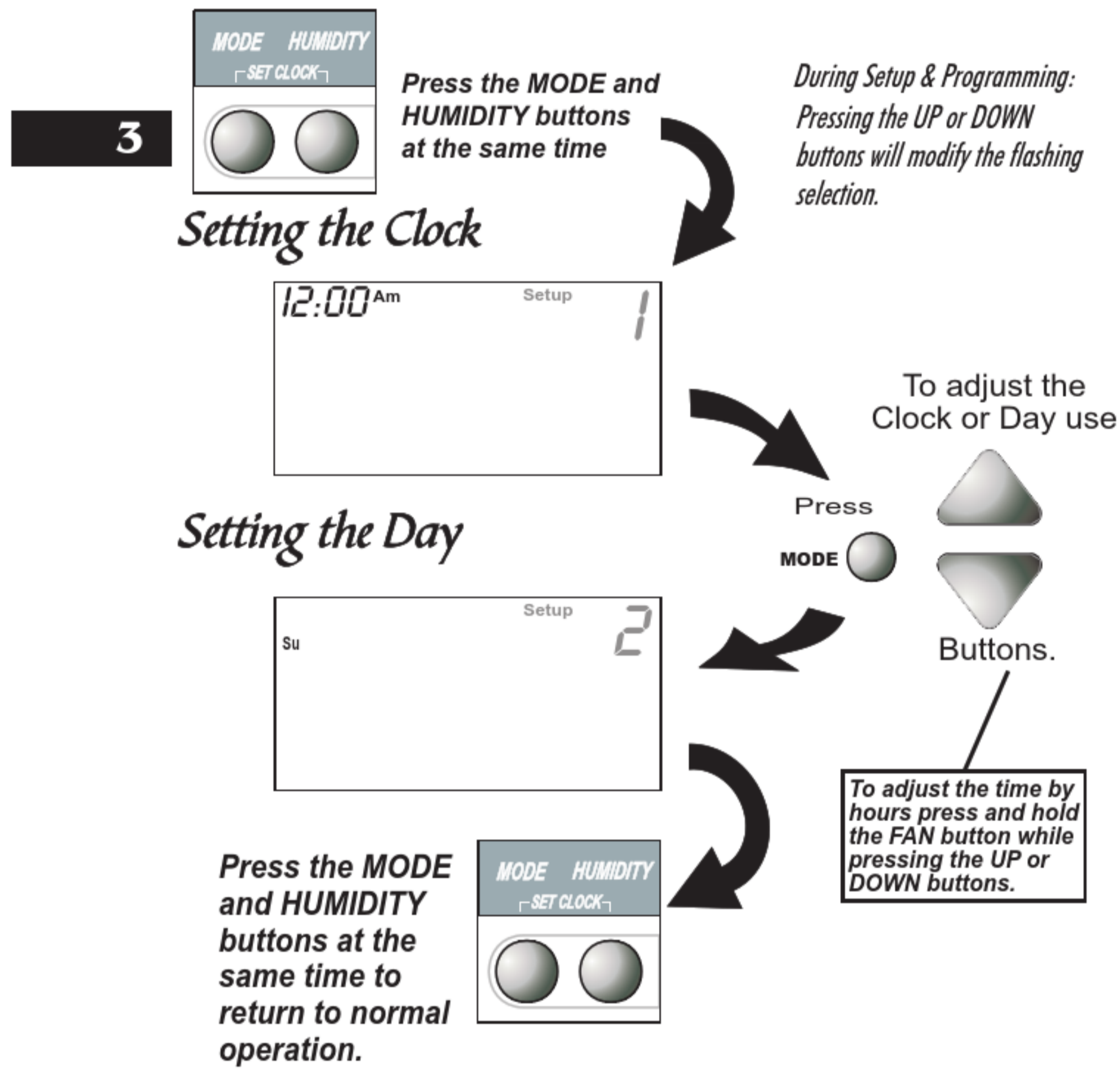

**Section 4 Contents:**

- *Programming for Auto or  
Program Operation.....4.2*
- *Selecting the Proper  
Operating Mode.....4.3*
- *Selecting Your Desired  
Temperature.....4.8*



*Note: During setup & programming pressing the UP or DOWN buttons will modify the flashing selection.*

### *Programmable or Non-Programmable Thermostat*



**4** When the very simplest operation is desired, this thermostat may be configured to be non-programmable, with or without Auto-Changeover. Follow the step below.

If 'NO' is selected, the thermostat will lockout the Program On screen; only the Off, Heat, Cool, and Auto screens may be accessed by pressing the MODE button.

Select 'YES' if you would like your thermostat to be **programmable**, then the Program mode will be accessible through the use of the MODE button.

**MODE**  *Press the MODE button. While holding the MODE, press the PROGRAM*  
**PROGRAM**  *button to enter Setup screens.*

*Note: Press the MODE button momentarily to move through the setup screens. Press and hold the MODE button to move backwards through the setup screens.*

**YES**  Select Yes if you would like the thermostat to be programmable or No for non-programmable.  
**NO** 

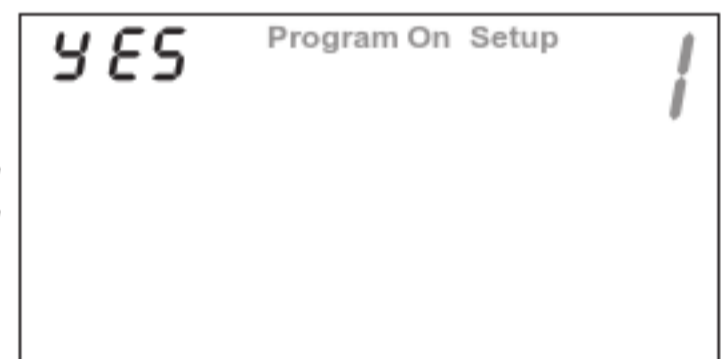

Press the PROGRAM button to leave the Setup screens. If no buttons are pressed, the display will leave the setup screens after 30 seconds.

### *Manual or Auto-Changeover Thermostat*

When the very simplest operation is desired, this thermostat may be configured to be a manual heat and cool thermostat, with or without time period programmability. Follow the step below.

**4**

The thermostat may be programmed to function as a Heat Only or Cool Only thermostat by selecting 'NO' in the setup screen below. This will lockout the Auto-Changeover screen and only allow the Off, Heat, Cool, and Program On screens to be accessed.

**MODE**  *Press the MODE button. While holding the MODE, press the PROGRAM button to enter Setup screens.*

**PROGRAM** 

**MODE**  *Press the MODE button repeatedly until this setup screen appears.*

*Note: Press the MODE button momentarily to move through the setup screens. Press and hold the MODE button to move backwards through the setup screens.*

---

**YES**  Select Yes if you would like the thermostat to be Auto-Changeover or No for a Heat Only and Cool Only Thermostat.

**NO** 

Setup

YES 2

AUTO

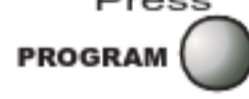
**Press PROGRAM** 

Press the PROGRAM button to leave the Setup screens. If no buttons are pressed, the display will leave the setup screens after 30 seconds.

***Operating Mode when the Thermostat is Configured to be:***

**4**

NON-PROGRAMMABLE WITH MANUAL-CHANGEOVER - If the thermostat is configured to be a non-programmable thermostat with Manual-Changeover, the following screens will be available by pressing the MODE button.

**Select the Mode by Pressing the MODE Button**

**Heating Only**  
The **HEAT** setting indicates the temperature the room has to reach before the furnace will turn on to heat the room.



**Cooling Only**  
The **COOL** setting indicates the temperature the room has to reach before the air conditioner will turn on to cool the room.



**Off**  
**OFF** indicates both heating and air conditioning systems are turned off.

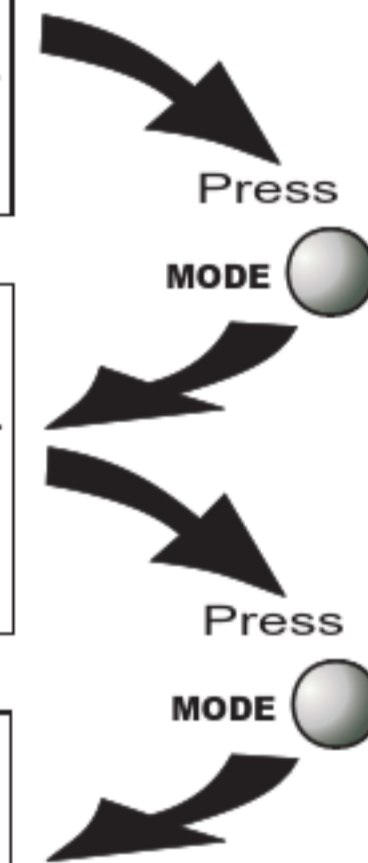

### *Operating Mode when the Thermostat is Configured to be:*

NON-PROGRAMMABLE WITH AUTO-CHANGEOVER - If the thermostat is configured to be a non-programmable thermostat with Auto-Changeover, the following screens will be available by pressing the MODE button

#### **Select the Mode by Pressing the MODE Button**

**Heating Only**  
The **HEAT** setting indicates the temperature the room has to reach before the furnace will turn on to heat the room.



**Cooling Only**  
The **COOL** setting indicates the temperature the room has to reach before the air conditioner will turn on to cool the room.



**Heating or Cooling**  
**AUTO** will automatically select heat or cool based on room temperature demand.



**Off**  
**OFF** indicates both heating and air conditioning systems are turned off.

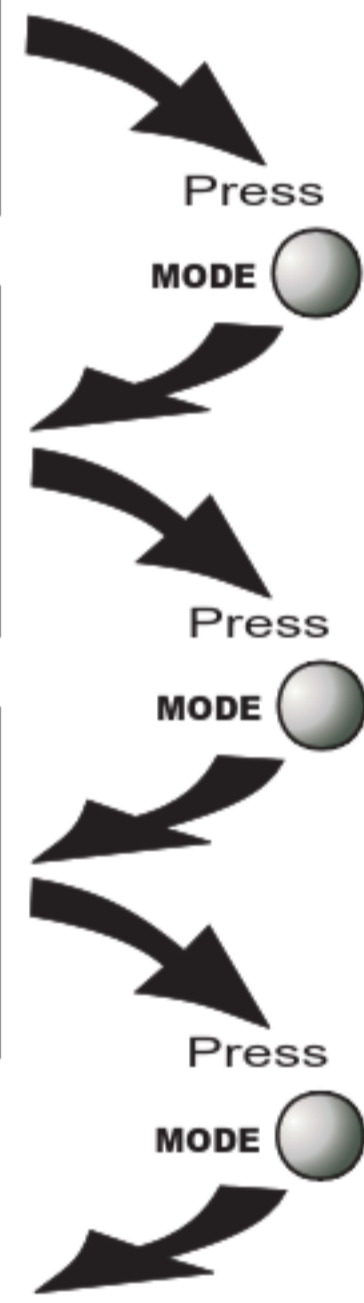

**Operating Mode when the Thermostat is Configured to be:**

**4** PROGRAMMABLE WITH MANUAL-CHANGEOVER - If the thermostat is configured to be a programmable thermostat with Manual-Changeover, the following screens will be available by pressing the MODE button.

**Select the Mode by Pressing the MODE Button**

**Heating Only**  
The **HEAT** setting indicates the temperature the room has to reach before the furnace will turn on to heat the room.

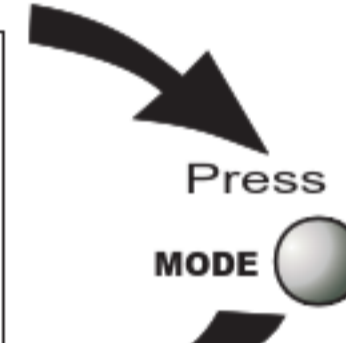

**Cooling Only**  
The **COOL** setting indicates the temperature the room has to reach before the air conditioner will turn on to cool the room.

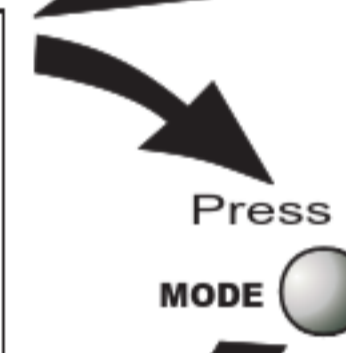

**Time Schedule for Heating Only**  
The **HEAT Program On** setting will activate the time period program for the heating setpoint ONLY (occupied or unoccupied periods).



**Time Schedule for Cooling Only**  
The **COOL Program On** setting will activate the time period program for the cooling setpoint ONLY (occupied or unoccupied periods).

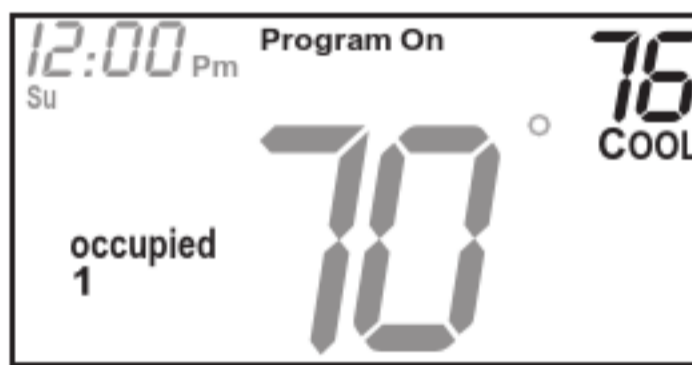

**Off**  
**OFF** indicates both heating and air conditioning systems are turned off.

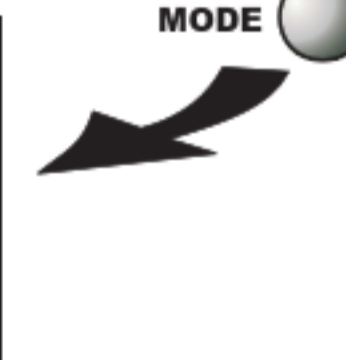

**Operating Mode when the Thermostat is Configured to be:**

PROGRAMMABLE WITH AUTO-CHANGEVER - If the thermostat is configured to be a programmable thermostat with Auto-Changeover, the following screens will be available by pressing the MODE button.

**4**

**Select the Mode by Pressing the MODE Button**

**Heating Only**  
The **HEAT** setting indicates the temperature the room has to reach before the furnace will turn on to heat the room.

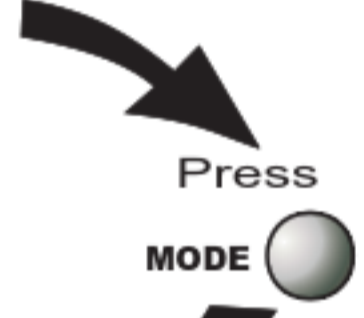

**Cooling Only**  
The **COOL** setting indicates the temperature the room has to reach before the air conditioner will turn on to cool the room.



**Heating or Cooling**  
**AUTO** will automatically select heat or cool based on room temperature demand.



**Time Schedule for Heating or Cooling**  
**Program On** will activate the time period program for the heating and cooling setpoints. (occupied or unoccupied periods)

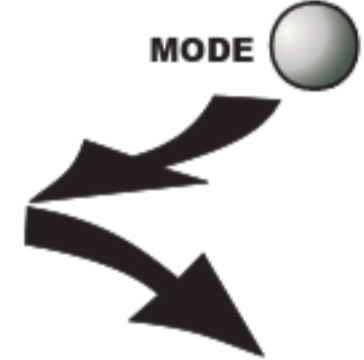

**Off**  
**OFF** indicates both heating and air conditioning systems are turned off.

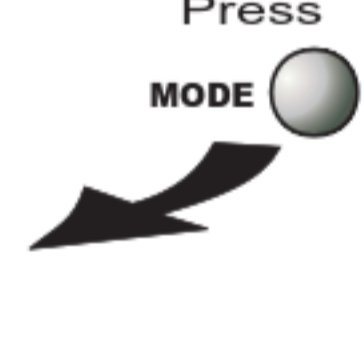



*Selecting Your Desired Temperature (adjusting setpoints)*

**AUTO OR PROGRAM MODE**

**4**

Pressing the UP or DOWN buttons in Auto or Program modes will adjust **both** the heat and cool set temperatures simultaneously. For more information on this see page 13.2.



Adjust the desired set temperature with the



buttons.

---

**HEAT OR COOL MODE**

Pressing the UP or DOWN buttons in Heat or Cool modes will adjust only the heat or cool set temperature.



Adjust the desired set temperature with the



buttons.

*Note: Due to the Random Start feature there will be a 2 to 30 second delay before heating or cooling may be energized. This delay helps to keep multiple thermostats from energizing their outputs at the same time after a power outage.*

**SECTION 5**  
*Viewing the Temperature and Humidity Sensors*

**VENSTAR®**

**5**

**Section 5 Contents:**

- *Viewing the Outdoor  
Temperature.....5.2*
- *Viewing the Indoor  
Humidity.....5.3*

### Viewing the Outdoor Temperature

Requires an outdoor sensor (optional accessory) to be installed. To read the temperature from the outdoor sensor, press the PROGRAM and HOLIDAY buttons. The display will then show the current outdoor temperature along with the highest and lowest temperatures for the day.

**5**

**Press the PROGRAM button. While holding PROGRAM, press the HOLIDAY button to view the Outdoor temperature.**

The highest and lowest temperatures for the day will be displayed along with the current outdoor temperature. This reading is from the sensor connected to RS2.

**High temperature for the day.**  
**Current outdoor temperature.**  
**Low temperature for the day.**

**Press the PROGRAM button. While holding PROGRAM, press the HOLIDAY button to leave the Outdoor temperature screen.**

**Note: If no sensors are connected 2 dashes [- -] will appear on the display.**

One wired or wireless Outdoor sensor can be installed to read the outdoor temperature (RS2).

The Outdoor Sensor measures outdoor air temperature and sends this information to the thermostat; it measures temperature with a range of -40° to 127°F.

The Outdoor Sensor should be connected to the thermostat using solid conductor CAT 5, CAT 5e, or CAT 6 type network communication cable. This is an unshielded cable with four twisted pairs of 24 gauge solid wire; **DO NOT use stranded cable.** The cable length should not exceed 250 feet. If less than 75 feet of cable is required to connect the thermostat to the Outdoor Sensor, a three conductor thermostat cable (18-24 gauge) may be used; this cable is NOT suitable for any length greater than 75 feet.

**IMPORTANT:** Do not use shielded wire. Do not run sensor wiring in the same conduit as the 24VAC thermostat wiring. Electrical interference may cause the sensor to give incorrect temperature readings. See the Outdoor Sensor instructions for further details.

### *Viewing the Indoor Humidity*

Requires the Humidity Module (optional accessory) to be installed. To display the current humidity at the thermostat, press the HUMIDITY button. The display will then show the current indoor humidity along with the humidification setpoint (Section 9).

**5**

**Note:** The humidity reading will not appear unless the Humidity Module has been installed. If the Humidity Module has not been installed dashes will appear in place of the humidity reading.

HUMIDITY  To view the indoor humidity reading, press the HUMIDITY button

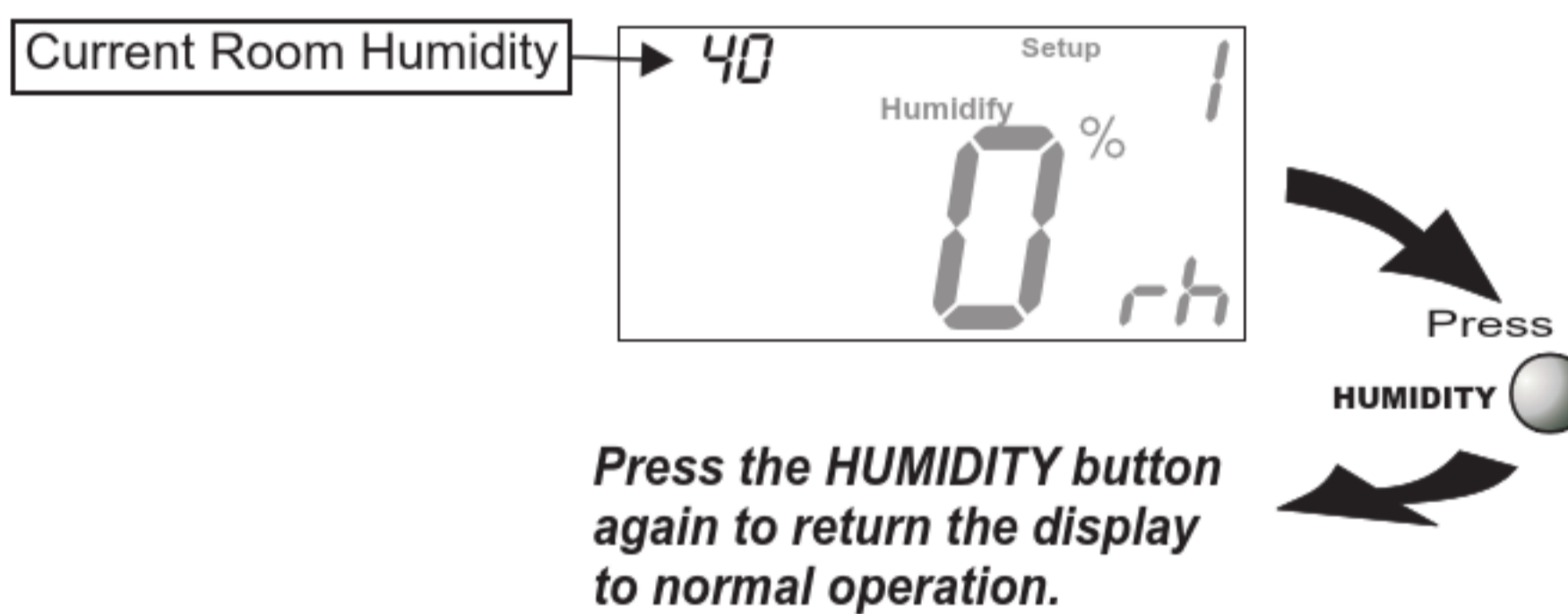

NOTE: Due to variations in environmental conditions, it is not always possible to achieve the desired humidification or dehumidification setpoint.

**SECTION 6**  
*Programming the Daily Schedule*

**VENSTAR®**

**Section 6 Contents:**

<b>6</b>	■ <i>Programming a Daily Schedule.....</i>	<b>6.2</b>
	■ <i>Overriding the Daily Schedule.....</i>	<b>6.6</b>

## Programming a Daily Schedule



Press the **PROGRAM** button to enter time period programming.

Use the Programming Worksheet on the back cover to help with this section.



Select the maximum # of occupied periods to be used on any one day. Typically most installations use only Occupied 1. (1,2 or 3)

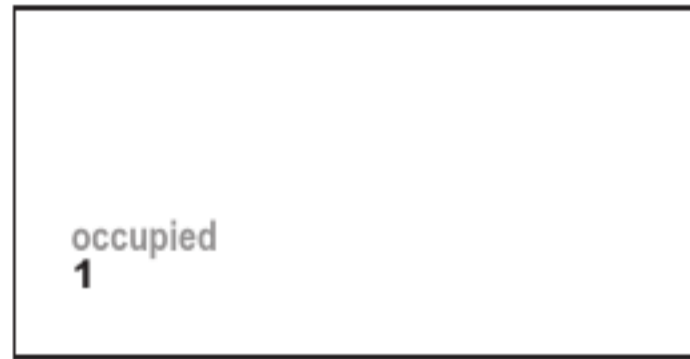

**6**

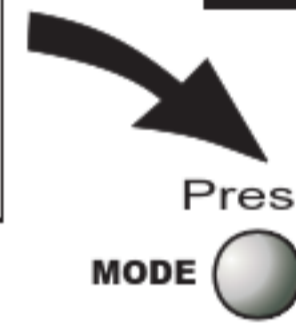

Adjust the cooling setpoint for Occupied 1. (35°- 99°, OF )

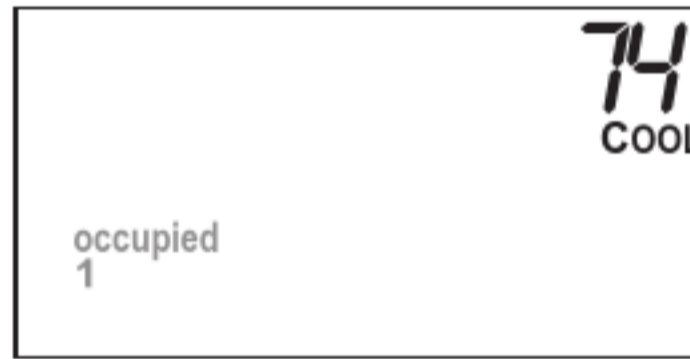

Adjust the heating setpoint for Occupied 1. (OF, 35°- 99°)

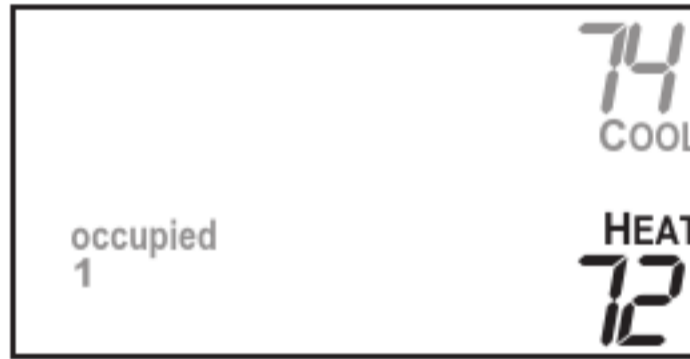

Adjust the cooling setpoint for unoccupied periods. (35°- 99°, OF )

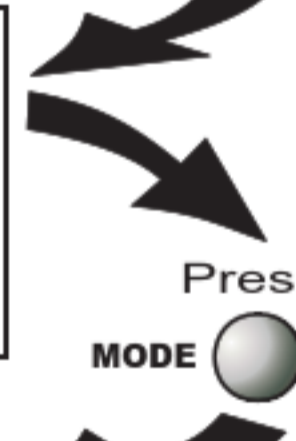
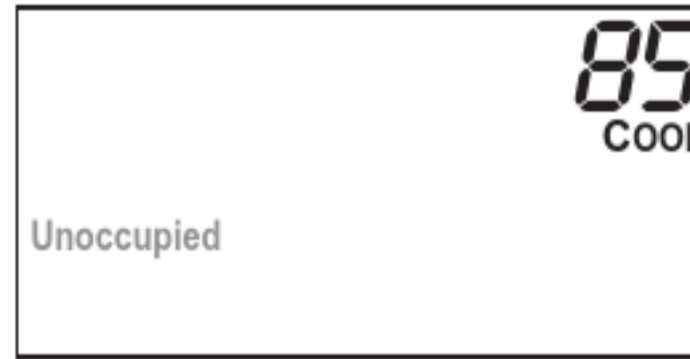

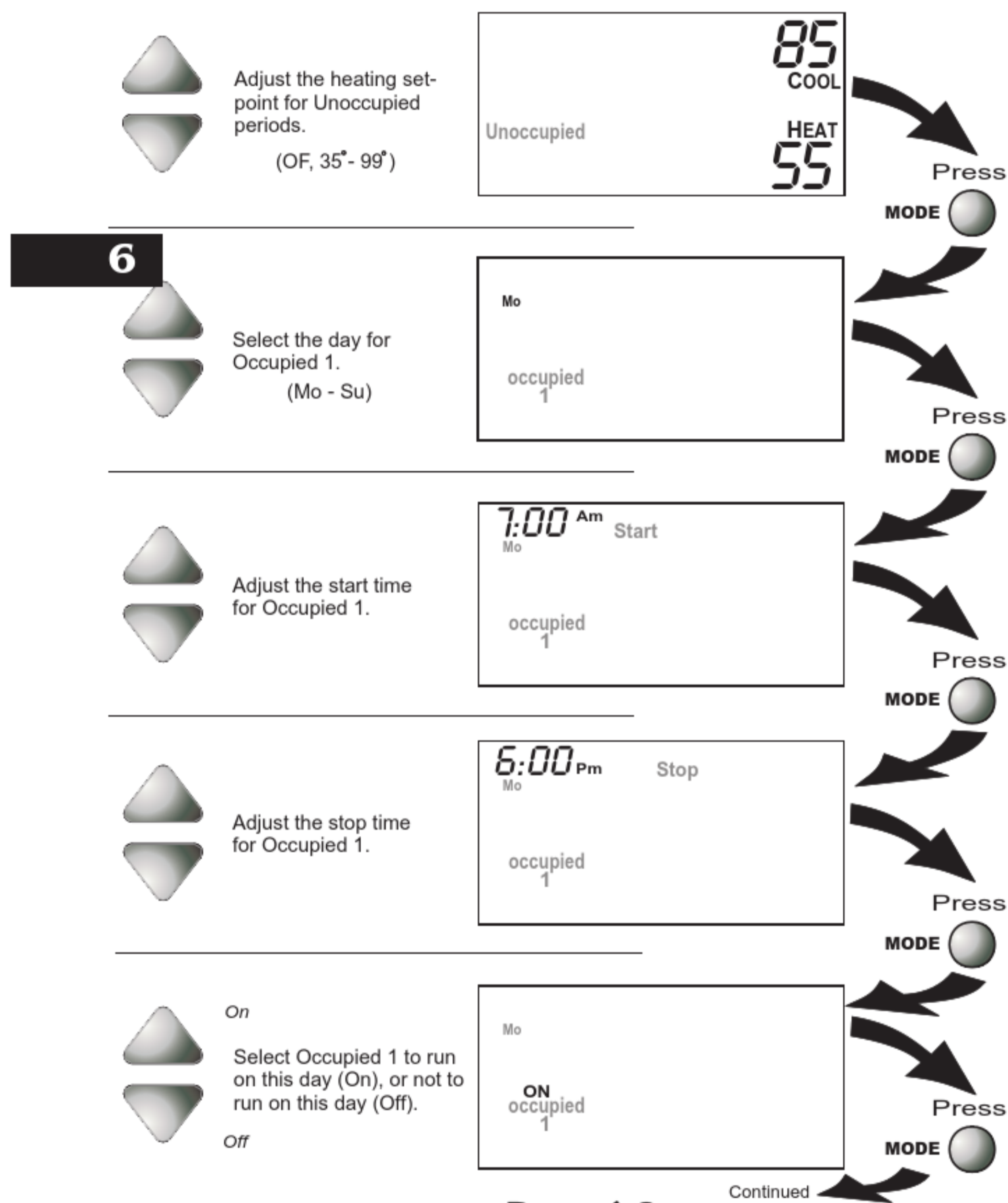

The copy command becomes available after the maximum # of occupied periods are programmed in a day. This example uses only one occupied period.

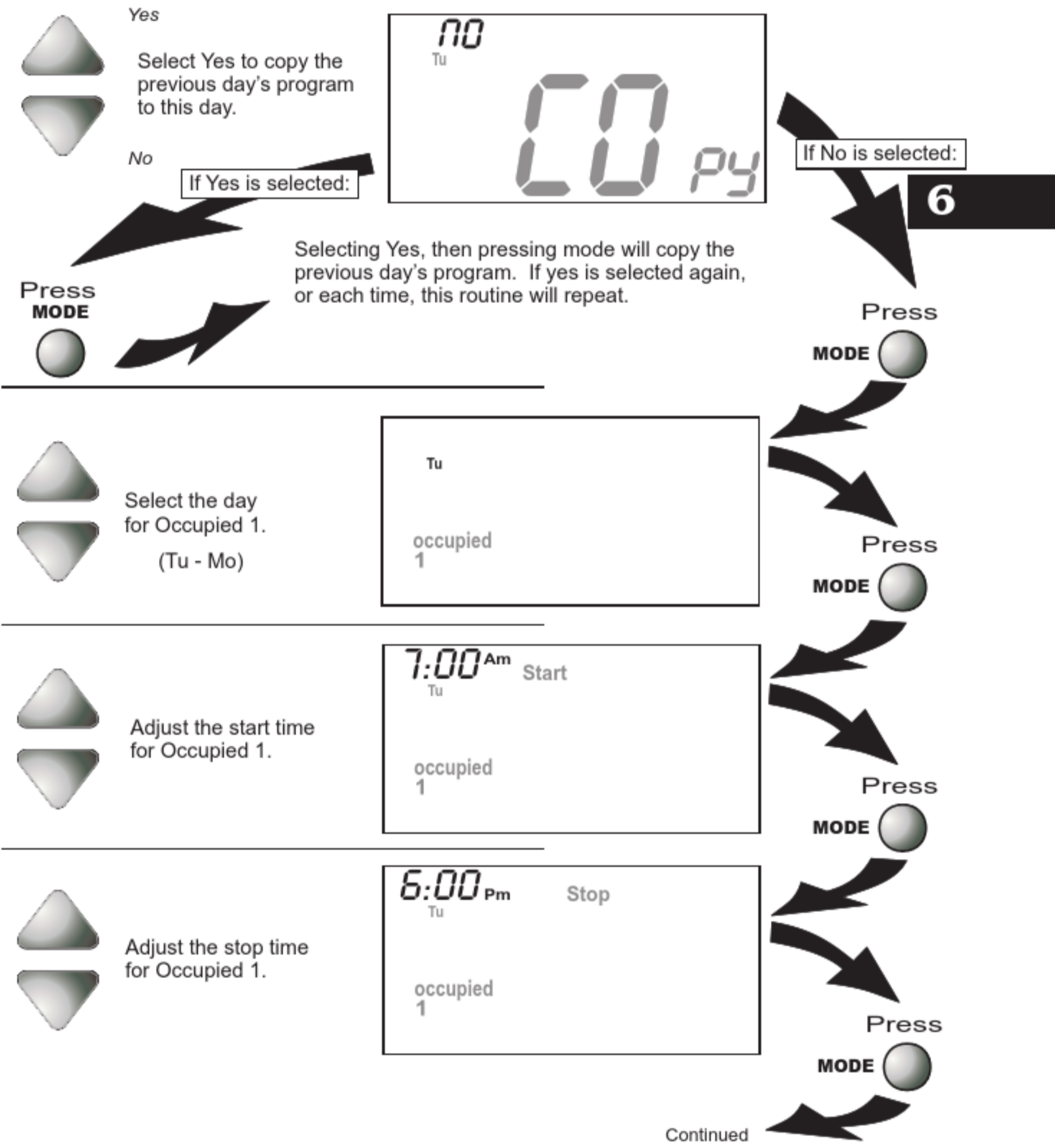





*On*  
Select Occupied 1 to run on this day (On), or not to run on this day (Off).  
*Off*

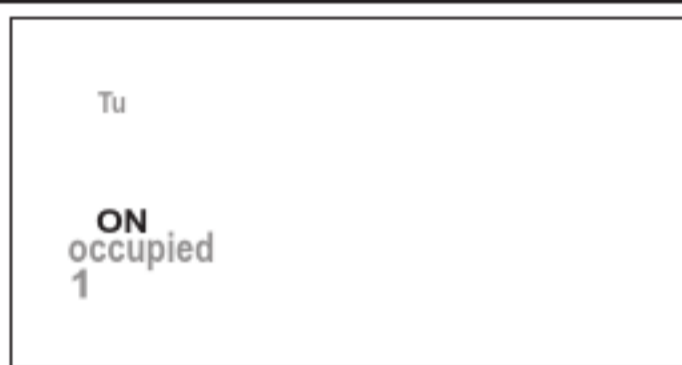

*Yes*  
Select Yes to copy the previous day's program to this day.  
*No* If Yes is selected:



If No is selected:



Selecting Yes, then pressing mode will copy the previous day's program. If yes is selected each time, this routine will repeat.



If **No** is selected, as in previous steps, flashing prompts will appear to input start and stop times for Occupied 1. If more than one occupied period was selected in the first programming step (page 6.2), then the cool and heat setpoints, and start and stop times for each additional occupied period will be prompted.



After programming for all seven days is complete, press the PROGRAM button to leave the Setup screens. If no buttons are pressed, the display will leave the setup screens after 30 seconds.

**PROGRAMMING TIPS**

- \* If only the Occupied 1 period is selected in the first programming step (page 6.2), Occupied 2 & 3 programming steps are skipped. Further, if Occupied 2 is selected, Occupied 3 programming steps are skipped.
- \* Heat & Cool setpoints for Occupied 1 are the same for every day of the week. If desired, Heat & Cool setpoints for Occupied 2 & 3 can be adjusted differently for each day of the week.
- \* **If the start time is set later in the day than the stop time**, the program will run from the start time to midnight and from midnight to the stop time on the same day. *For example: 9pm start, 8am stop, on Monday. In this example the program will run from 12am Monday to 8am Monday and again from 9pm Monday to 12am Tuesday.*
- \* **Unoccupied Operation:** The unoccupied settings take effect at all times when: (1) the program is on **and** (2) the current time is outside a preset occupied period. For this reason start and stop times are not necessary for unoccupied time periods.
- \* If the **same** start and stop times are programmed for an occupied period, then it will run 24 hours.
- \* If one occupied period starts and stops within another occupied period the lower occupied # has priority. *For example: If Occupied 3 is programmed to be on 24 hours, and Occupied 2 is programmed to run that day, then the Occupied 2 setting will take over for Occupied 3 between Occupied 2 start and stop times.*

### *Overriding the Daily Schedule*

The OVERRIDE button may be used to interrupt the normal time schedule programming of the thermostat. Override may only be used when the thermostat is running the time schedule, in Program On mode.

**Unoccupied Operation** - During programmed, unoccupied periods, pressing the OVERRIDE button will temporarily force the thermostat into Occupied 1 comfort settings for 30 minutes. The remaining Override time will alternate with the clock (refer to the second display below). The Override timer can be set up to a maximum of four (4:00) hours, in increments of 30 minutes. If the timer has been set for the maximum time, the next press of the OVERRIDE button will reset the timer, returning the thermostat to the correct time period program for the day.

**6**

**Occupied Operation** - During programmed, occupied periods, a press of the OVERRIDE button will force the thermostat into an unoccupied period for the remainder of the day. During this forced unoccupied period the OVERRIDE button will operate as described above.

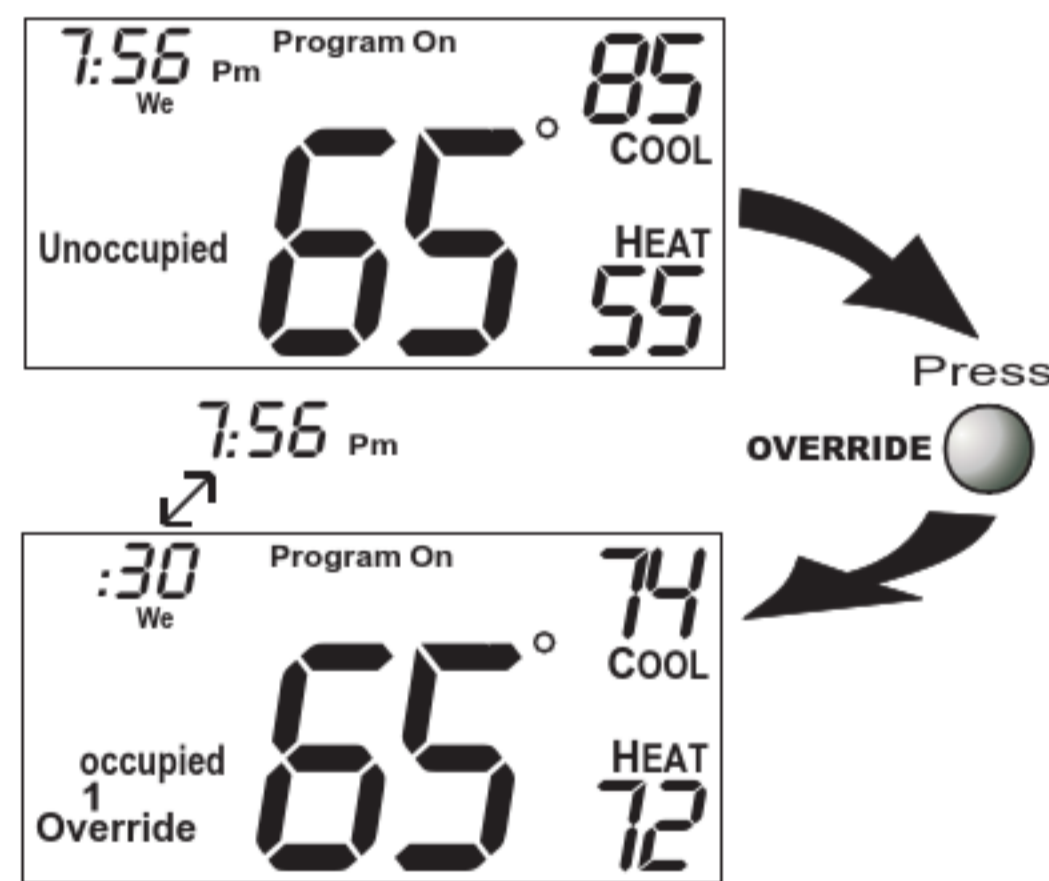

**SECTION 7**  
*Programming the Fan Operation*

**VENSTAR®**

**Section 7 Contents:**

- *Using the Fan Button.....7.2*
- 7** ■ *Smart Fan Operation.....7.2*
- *Setting the Fan-Off Time  
Delay.....7.3*

### *Using the Fan Button*

When the fan is set for automatic operation it will energize any time there is a call for heating or cooling, otherwise the fan will remain off. Pressing the FAN button will energize the fan and display the **FanOn** icon on the thermostat display. To operate the fan in the automatic mode, press the FAN button again and the FanOn icon will disappear.



**7**

**Fan On** indicates constant fan operation. If Fan On is selected the fan will run continuously at all times, except in Off, **and** will only run if there is a heating or cooling demand in Unoccupied periods. Pressing the FAN button toggles this feature on or off.

### *Smart Fan Operation*

This feature allows the fan to run continuously during Occupied 1, 2 or 3 and automatically de-energize during Unoccupied, except when necessary to heat or cool. To use this feature, place the thermostat in the Program On mode. Next, press the FAN button to display the **FanOn** icon (see below).





### *Setting the Fan-Off Time Delay*

To increase cooling efficiency of your unit, the thermostat may be programmed to continue running the fan after a call for cooling has been satisfied. This delay may be set for 30, 60, or 90 seconds. If the Fan Off Delay is set for zero seconds, the fan will not energize after a call for cooling has been satisfied.

**7**

**MODE**  *Press the MODE button. While holding the MODE, press the PROGRAM button to enter Setup screens.*

**PROGRAM** 

**MODE**  *Press the MODE button repeatedly until this setup screen appears.*

*Note: Press the MODE button momentarily to move through the setup screens. Press and hold the MODE button to move backwards through the setup screens.*



Set the Fan Off Delay to 0, 30, 60, or 90 seconds.



Press 

Press the PROGRAM button to leave the Setup screens. If no buttons are pressed, the display will leave the setup screens after 30 seconds.

**Section 8 Contents:**

- *Turning On/Off the Backlight.....8.2*
- *Programming the Thermostat to Display Temperature in Fahrenheit or Celsius.....8.2* **8**
- *Locking/Unlocking the Keypad.....8.3*
- *Programming a Security Level.....8.4*

### Turning On/Off the Backlight

**MODE**  Press the **MODE** button. While holding the **MODE**, press the **PROGRAM** button to enter Setup screens.

**PROGRAM** 

**MODE**  Press the **MODE** button repeatedly until this setup screen appears.

*Note: Press the **MODE** button momentarily to move through the setup screens. Press and hold the **MODE** button to move backwards through the setup screens.*

**8**



Select backlight operation:  
**AUTO** - Light from 6pm to 6am nightly.  
**ON** - Light continuously.  
**OFF** - Light for 8 seconds after a button press.



Press



### Programming the Thermostat to Display Temperature in Fahrenheit or Celsius



**C**  
Select thermostat operation in degrees Fahrenheit or Celsius.  
**F**

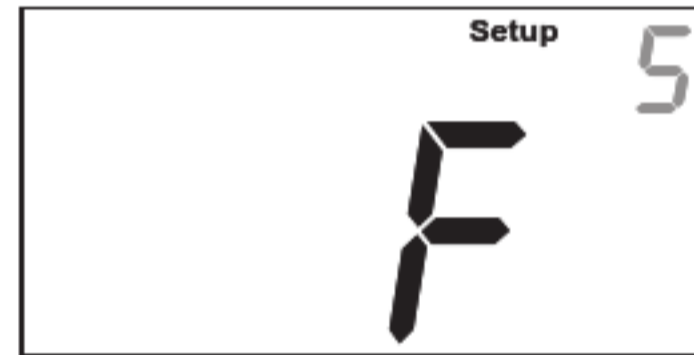

Press



Press the **PROGRAM** button to leave the Setup screens. If no buttons are pressed, the display will leave the setup screens after 30 seconds.

### *Locking/Unlocking the Keypad*

To prevent unauthorized use of the thermostat, the front panel buttons may be disabled. To disable, or 'lock' the keypad, press and hold the MODE button. While holding the MODE button, press the UP and DOWN buttons together. The  icon will appear on the display, then release the buttons.





To **unlock** the keypad, press and hold the MODE button. While holding the MODE button, press the UP and DOWN buttons together. The  icon will disappear from the display, then release the buttons.



### Programming a Security Level

When a security level has been programmed, the thermostat will allow limited adjustment to the setpoints (*steps #7 and 8*). In security levels 2 and 3, the thermostat is forced into the Program On mode. To disable the security feature, set the value in step #6 to 0; this will cause steps # 7 and 8 not to appear.

- MODE**  **Press the MODE button. While holding the MODE, press the PROGRAM button to enter Setup screens.**
  - PROGRAM** 
  - 8** **MODE**  **Press the MODE button repeatedly until this setup screen appears.**
- Note: Press the MODE button momentarily to move through the setup screens. Press and hold the MODE button to move backwards through the setup screens.*



Select the security level:  
 0=No security in effect  
 1=Setpoint range limited  
 2=1+ program on all times  
 3=2 + prohibits setpoint changes

*Step #7 appears only if step #6 is not 0.*

Adjust the maximum allowable heat setpoint when security is in effect.  
 (35° - 99°)

*Step #8 appears only if step #6 is not 0.*

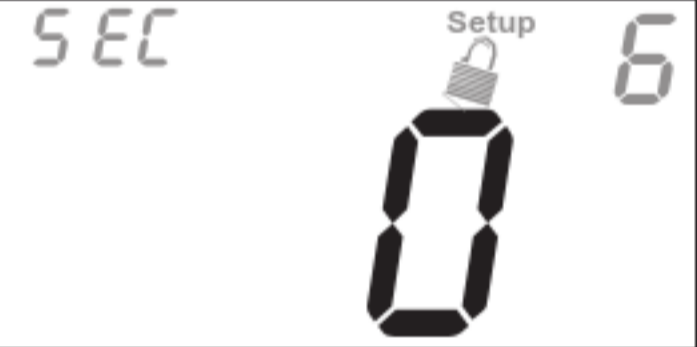
Adjust the minimum allowable cool setpoint when security is in effect.  
 (35° - 99°)

Press



Press



Press



Press the PROGRAM button to leave the Setup screens. If no buttons are pressed, the display will leave the setup screens after 30 seconds.

**Section 9 Contents:**

- **Installing the Humidity  
Module.....9.2**
- **Setting a Thermostat Jumper 9  
for Humidity Operation.....9.3**
- **Adjusting the Humidification  
Setpoint.....9.4**

**NOTE:** The humidification functions described in this section will only be available if a Humidity Module has been properly installed.

**Disclaimer:**

The manufacturer of this thermostat cannot be liable for misinstallation, improper connection or improper programming of the humidity functions of this thermostat that may result in water damage or mold growth.

Additionally, the manufacturer of this thermostat is not responsible for the fitness of the humidifier and/or installation of said humidifier connected to this thermostat. Furthermore, the maintenance of the humidifier components, including but not limited to, the filters and pads are not the responsibility of the thermostat manufacturer.

The Humidifier Service icon is only a suggestive reminder and should not take the place of the humidifier manufacturer's required maintenance requirements and schedule.

### *Installing the Humidity Module*

To install the Humidity Module the thermostat must be detached from the back plate. Plug the Humidity Module into the Humidity Module connector as shown in Figure 2 below. Follow the detailed instructions included with the Humidity Module accessory. Once the Humidity Module has been installed, you must adjust the Humidity jumper setting to HUM as shown in Figure 1 below. This will allow you to access the humidification and dehumidification setup steps.

**For proper humidity operation, this jumper must be set for HUM.**

**9**

**Back of T2800**

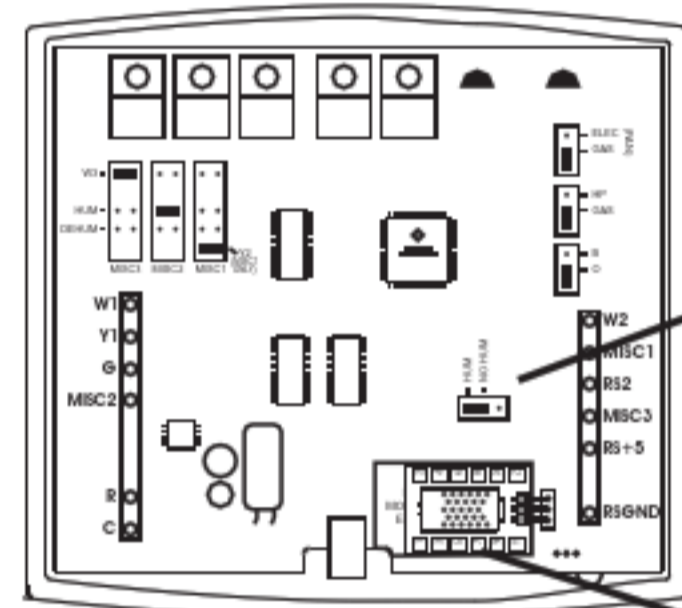

**Figure 1**



**Install the Humidity Module**  
(see Humidity Module Instruction Sheet for more detailed information).

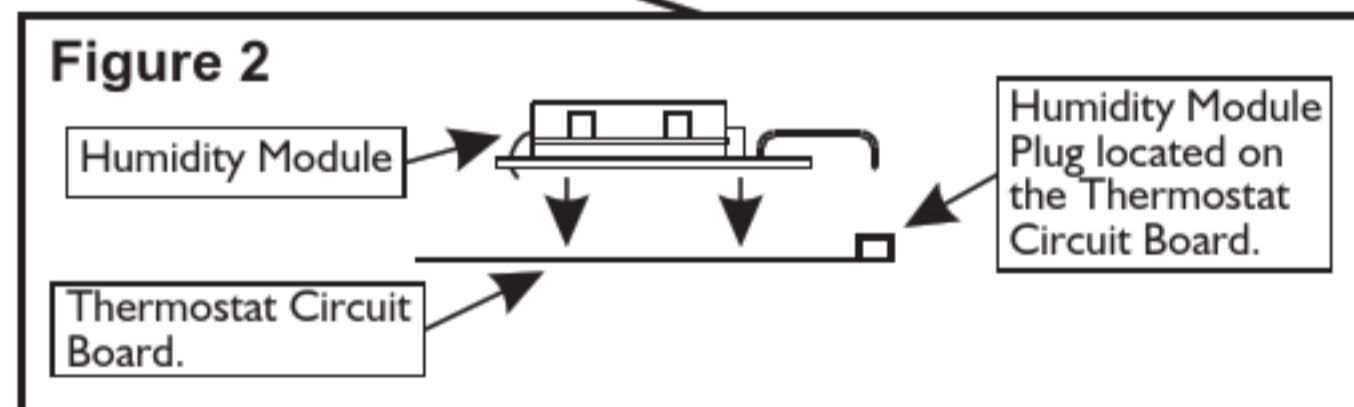

### Setting a Thermostat Jumper for Humidity Operation

To control a MISC output for humidification, place the MISC1, MISC2, or MISC3 jumper on the terminal labeled HUM (see diagram below). This will supply 24VAC to the selected MISC terminal based on the humidification programming in the following pages. Only one of the three outputs (MISC1, MISC2, or MISC3) is required to have this jumper. For more information regarding the MISC1, MISC2, and MISC3 outputs, please see section 17.

In the diagram below, the MISC3 jumper has been set for HUM (humidify) operation.

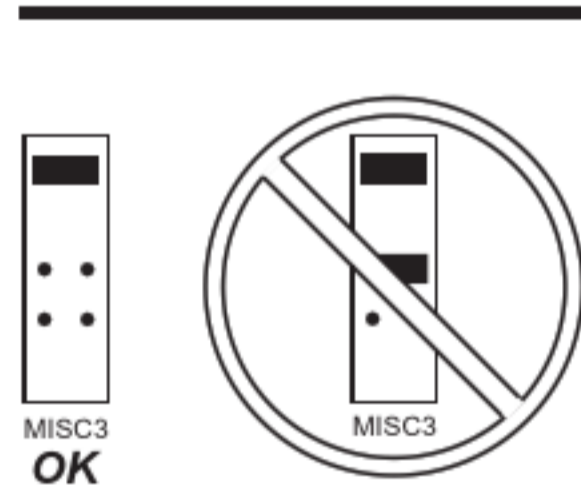
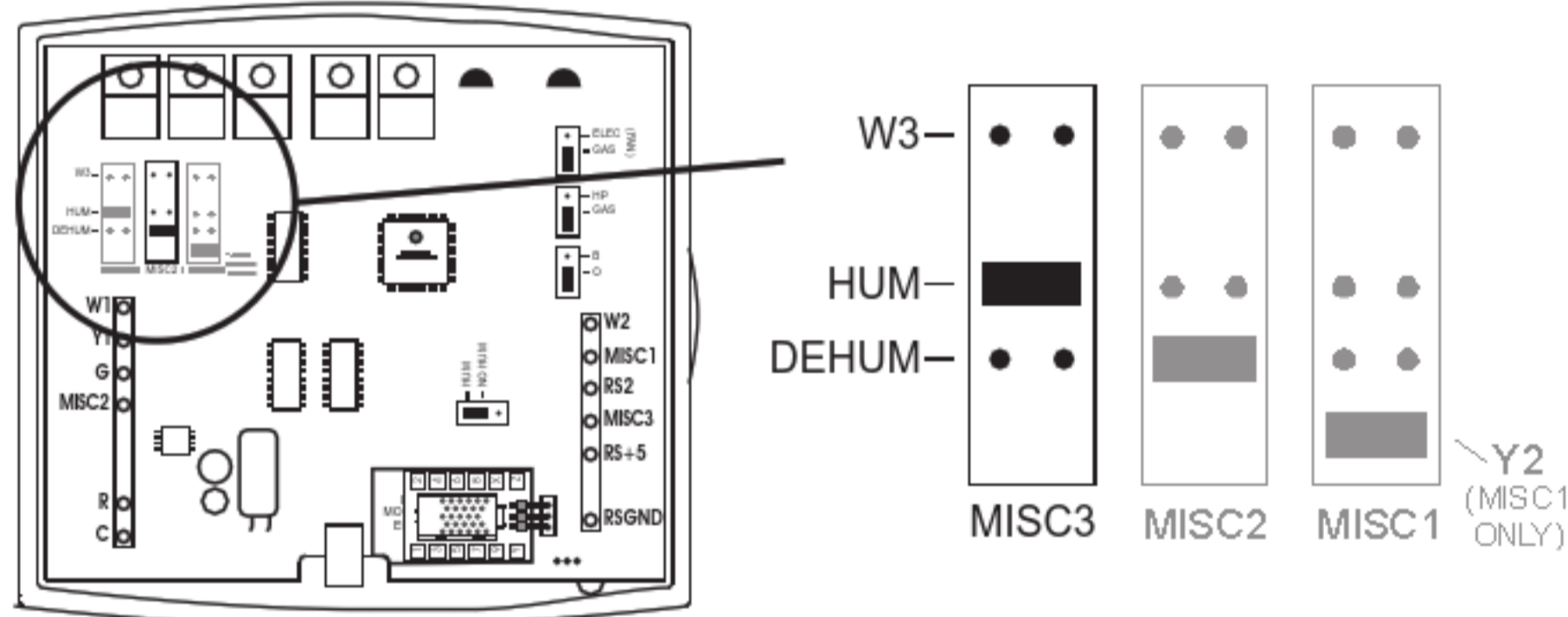

**IMPORTANT CAUTION**

**NEVER PUT MORE THAN ONE JUMPER ON THE SAME MISC JUMPER BLOCK!**  
**THIS MAY DAMAGE THE THERMOSTAT AND VOID YOUR WARRANTY**

### *Adjusting the Humidification Setpoint*

If your HVAC unit is equipped with a humidification system and the Humidity Module has been installed, the thermostat will provide power to the appropriate terminal on the backplate of the thermostat when the humidity in the building falls below the setpoint you have chosen. The value for this setpoint ranges from 0% to 60%.

NOTE: Due to variations in environmental conditions, it is not always possible to achieve the desired humidification or dehumidification setpoint.

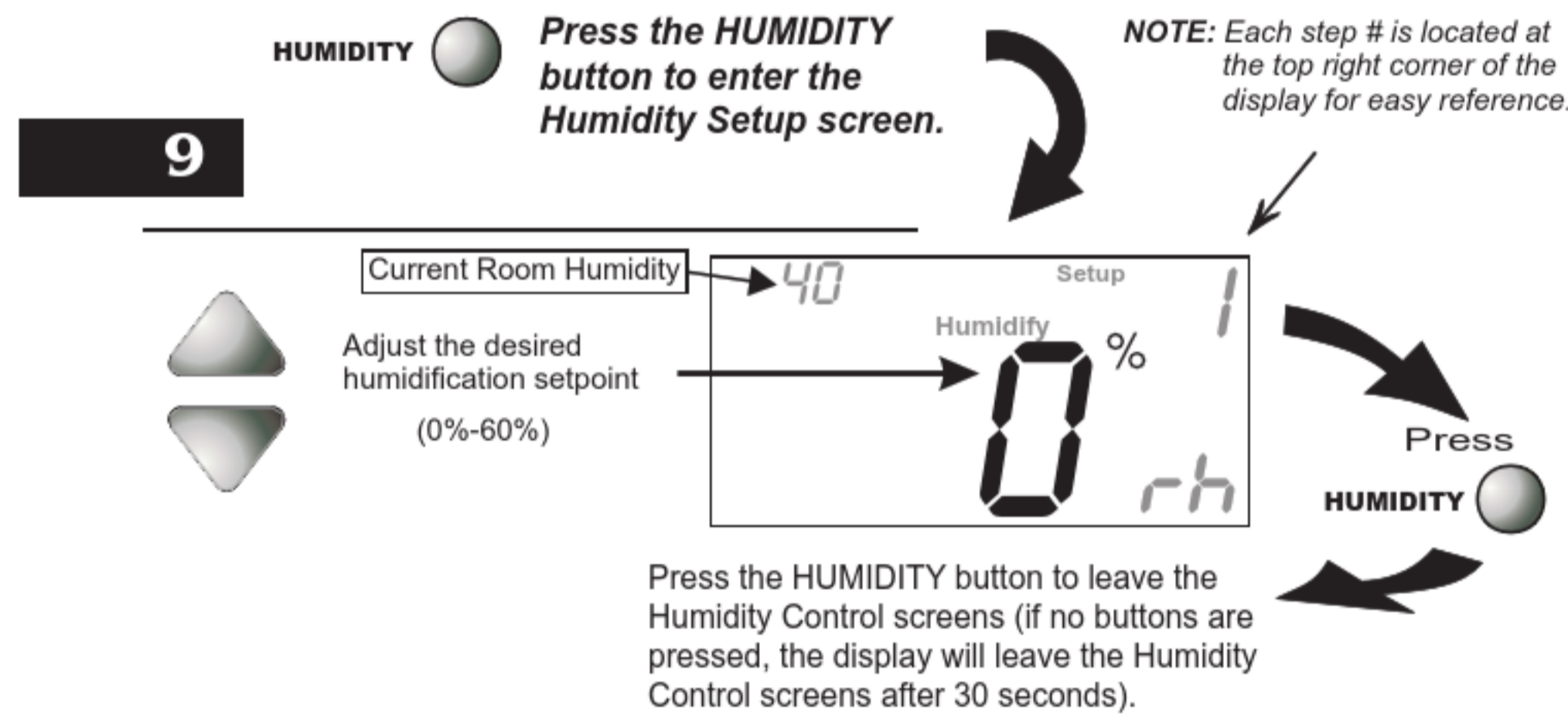

**Humidification Notes:** Press the button to set the humidity setpoint to 0% for no humidification operation.

You cannot set the dehumidify setpoint any lower than the humidify setpoint; a 5% differential is forced between the humidify and dehumidify setpoints.

**Section 10 Contents:**

- *Configuring a Thermostat Output Jumper for Dehumidification Operation.....10.2*
- *Adjusting the Dehumidification Setpoint.....10.3*
- *Using Your Air Conditioner to Dehumidify.....10.4*
- *Using the DEHUM Terminal.....10.5*

*NOTE: The dehumidification functions described in this section will only be available if a Humidity Module has been properly installed. For instructions on installing the Humidity Module please see page 9.2.*

### Setting a Thermostat Jumper for Dehumidification Operation

To control a MISC output for dehumidification, install the Humidity Module and place the Humidity Jumper on HUM (see page 9.2). Then place the MISC1, MISC2, or MISC3 jumper on the terminal labeled DEHUM (see diagram below). This will supply 24VAC to the selected MISC terminal based on the programming in the following pages. Only one of the three outputs (MISC1, MISC2, or MISC3) is required to have a jumper. For more information regarding the MISC1, MISC2, and MISC3 outputs, please see section 17.

**10** In the diagram below, the MISC2 jumper has been set for DEHUM (dehumidification) operation.

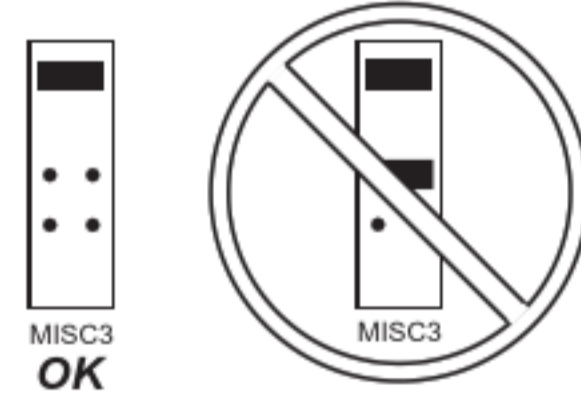
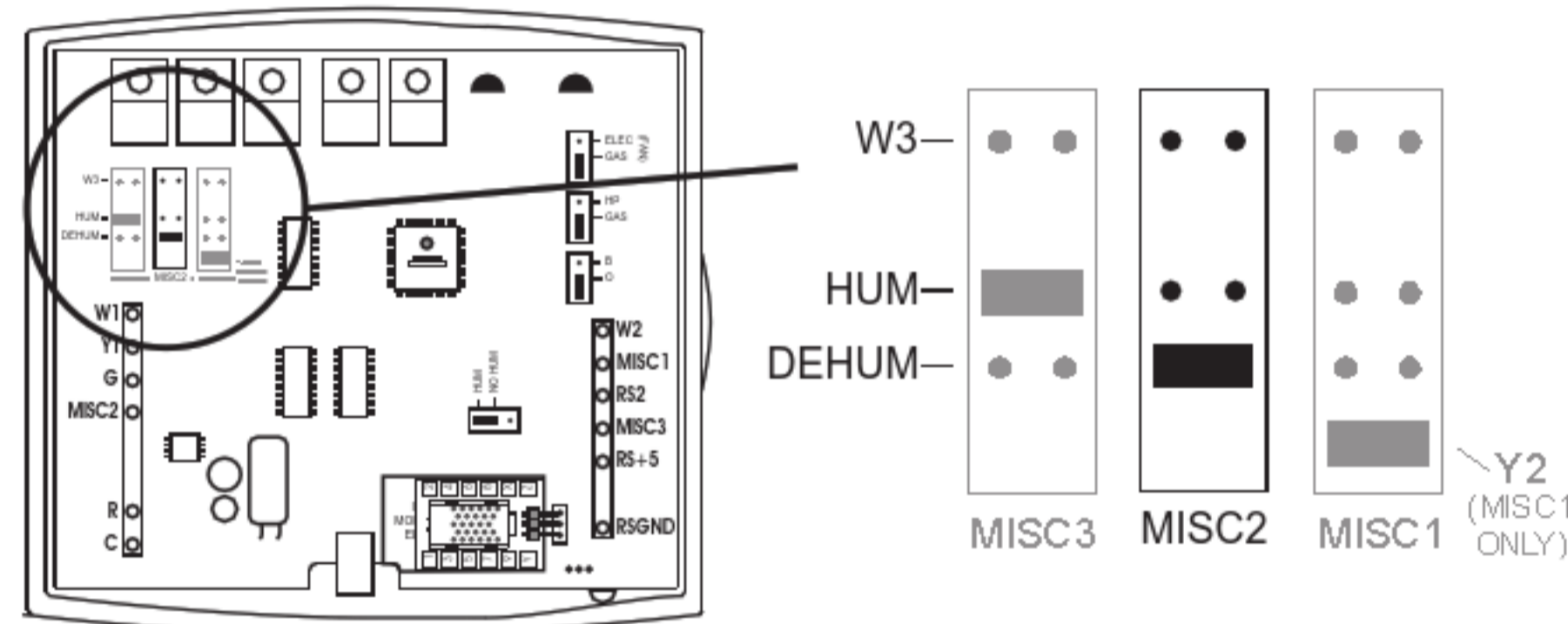

**IMPORTANT CAUTION** 

**NEVER PUT MORE THAN ONE JUMPER ON THE SAME MISC JUMPER BLOCK!**

**THIS MAY DAMAGE THE THERMOSTAT AND VOID YOUR WARRANTY**

### *Adjusting the Dehumidification Setpoint*

**Dehum Terminal:** If a MISC terminal is selected for DEHUM operation (see page 10.2), then the thermostat will provide power to this terminal when the humidity in the building is above the setpoint you have chosen. See page 10.6 for detailed programming instructions. To utilize this feature your HVAC unit must be equipped with a DEHUM terminal.

**Cool to Dehumidify:** If the thermostat is programmed for Cool to Dehumidify operation, then the thermostat will energize the cooling system any time the humidity in the building is above the setpoint you have chosen. See page 10.4 for detailed programming instructions.

In each case, when the indoor humidity falls below the setpoint you have selected, Cool to Dehumidify and the MISC terminal will be de-energized. The value for this setpoint ranges from 25% to 99%.

NOTE: Due to variations in environmental conditions, it is not always possible to achieve the desired humidification or dehumidification setpoint.

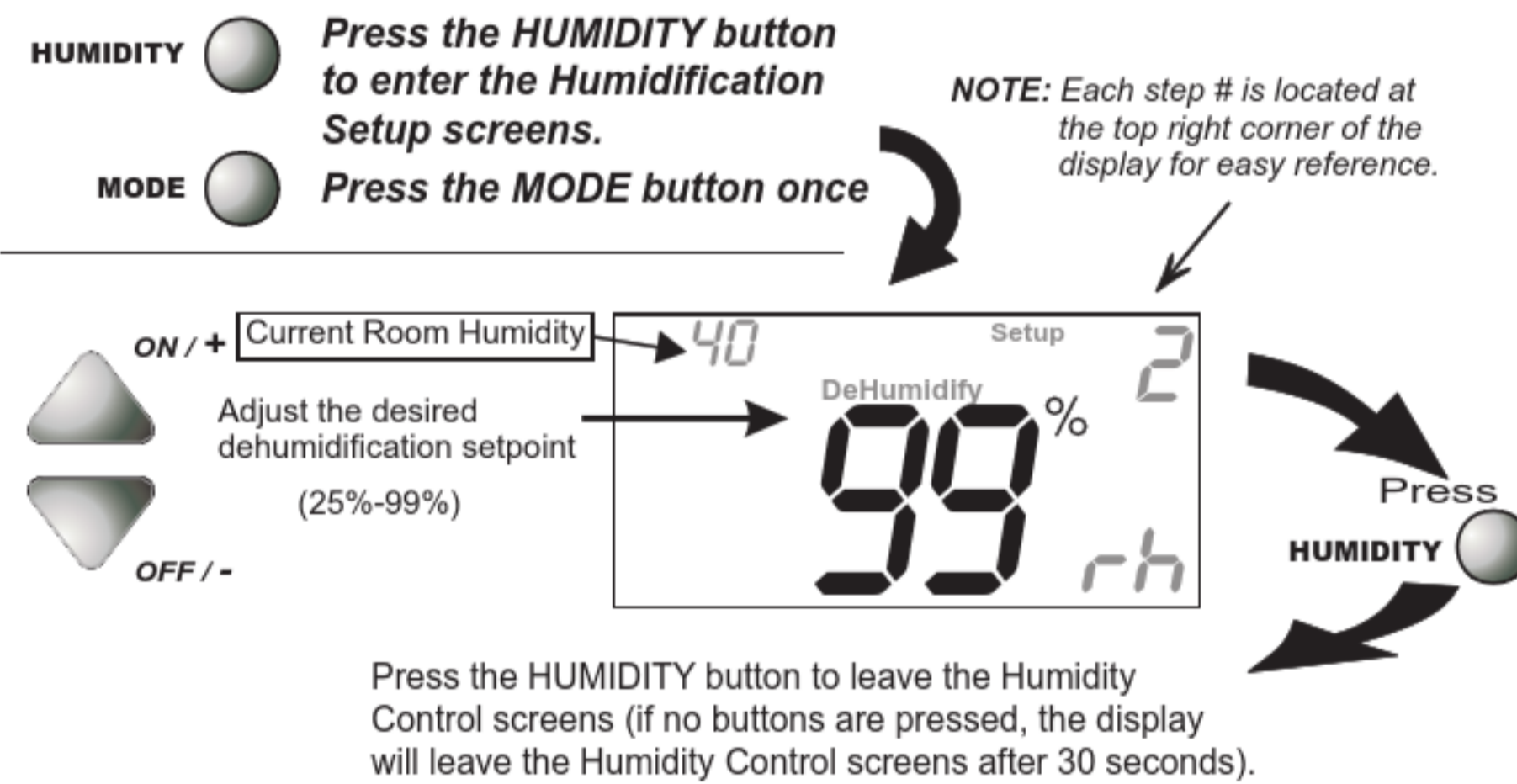



**Dehumidification Notes:** Press the button to set the dehumidification setpoint to 99% for no dehumidification operation. This will lockout Advanced Setup steps 9 and 10 (see page 10.4).

You cannot set the dehumidify setpoint any lower than the humidify setpoint; a 5% differential is forced between the humidify and dehumidify setpoints.



### Using Your Air Conditioner to Dehumidify

If Cool to Dehumidify is on and the Humidity Module is installed, the thermostat has the ability to initiate a cooling cycle for advanced dehumidification operation. When the thermostat detects the humidity percentage is above the setpoint for dehumidification, and heating or cooling is not on, the thermostat will force the compressor to run with the fan, thus reducing moisture in the air. The green LED will blink once every eight seconds to indicate this is taking place. This feature will also allow you to adjust the cooling overshoot of the setpoint, from 0° to 5° (adjustable in step #10). *For Example: If the cooling overshoot is set for 3°F and the cooling setpoint is set for 74°F, then as long as the room temperature reads between 71°F and 74°F this feature will energize the compressor and fan to dehumidify the air.*

- 10** **MODE**  **Press the MODE button. While holding the MODE, press the PROGRAM button to enter Setup screens.**
- MODE**  **Press the MODE button repeatedly until this setup screen appears.**
- Note: Press the MODE button momentarily to move through the setup screens. Press and hold the MODE button to move backwards through the setup screens.*

Steps 9 and 10 only appear if the Dehumidification setpoint is not 99% (see page 10.3).

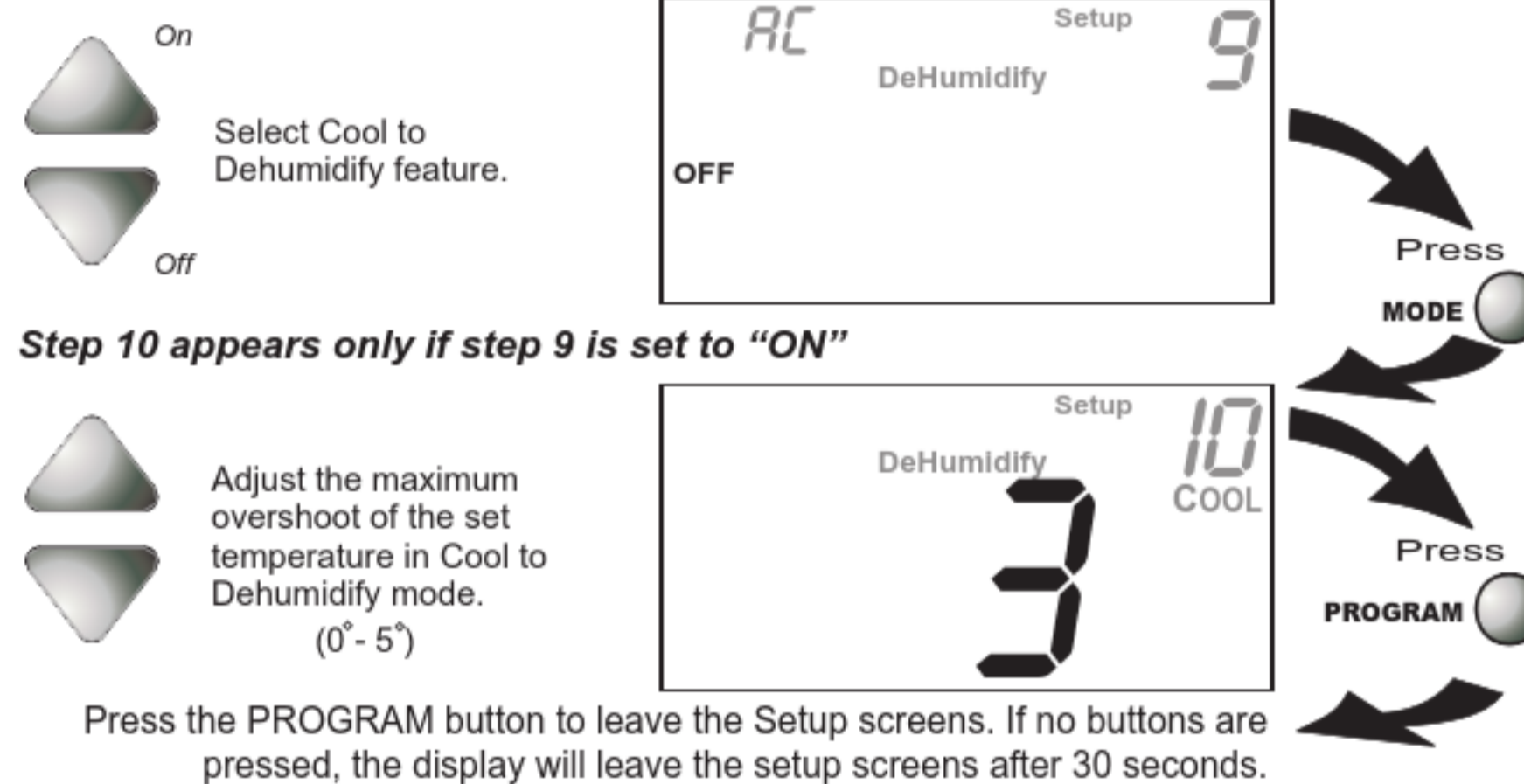

**Dehumidification Notes:** The thermostat must be in the Cool, Auto, or Program On mode for the Cool to Dehumidify feature to be available.

### *Using the Dehum Terminal*

If you configure a MISC output jumper for DEHUM, it may be programmed to operate in one of two ways:

- 1) **Normally Closed (NC):** The thermostat will de-energize the DEHUM terminal to allow the fan to run in low speed when there is a call for 1st stage cooling and the room humidity is greater than the dehumidification setpoint.
- 2) **Normally Open (NO):** The thermostat will energize the DEHUM terminal to allow the fan to run in low speed when there is a call for 1st stage cooling only and the room humidity is greater than the dehumidification setpoint.

**10**

**MODE**  *Press the MODE button. While holding the MODE, press the PROGRAM button to enter Setup screens.*

**PROGRAM** 

**MODE**  *Press the MODE button repeatedly until this setup screen appears.*

*Note: Press the MODE button momentarily to move through the setup screens. Press and hold the MODE button to move backwards through the setup screens.*

---

**NC**  Normally Closed (NC) = DEHUM de-energized for low speed fan.

**NO**  Normally Open (NO) = DEHUM energized for low speed fan.



Press **PROGRAM** 

Press the PROGRAM button to leave the Setup screens. If no buttons are pressed, the display will leave the setup screens after 30 seconds.

**Dehumidification Notes:** The DEHUM terminal will “release” and allow the fan to operate normally if there is call for 2nd stage cooling or if the call for Cooling and/or Cool to Dehumidify has been satisfied.

**SECTION 11**

*Viewing Equipment Run-Times*

**VENSTAR®**

**Section 11 Contents:**

- *Viewing the Override  
Run-Time.....11.2*
- *Viewing the Humidifier  
Run-Time..... 11.3*
- 11** ■ *Viewing the UV Light  
Run-Time.....11.4*

### *Viewing the Override Operation Run-Time*

This display will track the number of hours that your thermostat has been operating in the Override mode (see page 6.6). Press the FAN button to reset the counter.

**MODE**  Press the **MODE** button. While holding the **MODE**, press the **PROGRAM** button to enter Setup screens.

**PROGRAM** 

**MODE**  Press the **MODE** button repeatedly until this setup screen appears.

*Note: Press the **MODE** button momentarily to move through the setup screens. Press and hold the **MODE** button to move backwards through the setup screens.*

Press  Counts the number of hours Override has been active. Press **FAN** to reset the Override Run-Time counter.



**11**

Press  **PROGRAM**

Press the **PROGRAM** button to leave the Setup screens. If no buttons are pressed, the display will leave the setup screens after 30 seconds.

### *Viewing the Humidification Run-Time*

After your humidification system has been operating for the number of days set in step #13 below, the Service Humidify icon will appear. This counter keeps track of the number of days since the Service Humidify icon was reset.

**MODE**  *Press the MODE button. While holding the MODE, press the PROGRAM button to enter Setup screens.*

**PROGRAM** 

**MODE**  *Press the MODE button repeatedly until this setup screen appears.*

*Note: Press the MODE button momentarily to move through the setup screens. Press and hold the MODE button to move backwards through the setup screens.*

**11** Press  **FAN** Counts the number of days the humidifier has been running. Press FAN to reset the Service Humidify counter and remove the icon from the display.

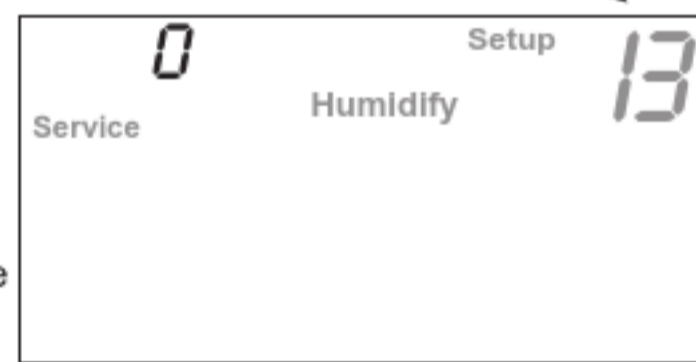



Press  **PROGRAM**

Press the PROGRAM button to leave the Setup screens. If no buttons are pressed, the display will leave the setup screens after 30 seconds.

### *Viewing the UV Light Run-Time*

After the UV light has been operating for the number of days set in step #14 below, the Service UV Light icon will appear. This counter keeps track of the number of days since the UV light icon was last reset.

**MODE**  *Press the MODE button. While holding the MODE, press the PROGRAM button to enter Setup screens.*

**PROGRAM**  *Press the MODE button repeatedly until this setup screen appears.*

**MODE**  *Press the MODE button repeatedly until this setup screen appears.*

*Note: Press the MODE button momentarily to move through the setup screens. Press and hold the MODE button to move backwards through the setup screens.*

---

**Press FAN**  Counts the number of days since the UV Light was last reset. Press FAN to reset the Service UV Light counter and remove the icon from the display.

0      Setup      14

Service UV Light

**11**

**Press PROGRAM** 

Press the PROGRAM button to leave the Setup screens. If no buttons are pressed, the display will leave the setup screens after 30 seconds.

**SECTION 12**  
*Electric Heat and Heat Pump Operation*



**VENSTAR®**

**Section 12 Contents:**

- *Viewing the Heat Pump and Reversing Valve Jumper Setting.....12.2*
- *Viewing the Electric Heat Jumper Setting.....12.3*
- 12** ■ *Using Emergency Heat.....12.4*

### *Viewing the Heat Pump and Reversing Valve Jumper Settings*

Steps 15 and 16 are 'Read Only' and may only be set with the jumpers on the circuit board of the thermostat.

- MODE**  *Press the MODE button. While holding the MODE, press the PROGRAM button to enter Setup screens.*
- PROGRAM** 
- MODE**  *Press the MODE button repeatedly until this setup screen appears.*

*Note: Press the MODE button momentarily to move through the setup screens. Press and hold the MODE button to move backwards through the setup screens.*



**ON** = Heat Pump operation  
**OFF** = Gas Electric operation



**12**



Indicates that the thermostat jumper is set for an **O** reversing valve (energize in cooling) or a **b** reversing valve (energize in heating).



Press 

Press 

Press the PROGRAM button to leave the Setup screens. If no buttons are pressed, the display will leave the setup screens after 30 seconds.





### *Viewing the Electric Heat Jumper Setting*

Placing the jumper on ELEC will cause the thermostat to turn on the fan immediately any time there is a heat demand. Since most gas furnaces control the fan, this feature should be off unless it is necessary for the thermostat to energize the fan with first stage heat.

Step 17 is 'Read Only' and may only be set with the jumpers on the circuit board of the thermostat.

**MODE**  *Press the MODE button. While holding the MODE, press the PROGRAM button to enter Setup screens.*

**PROGRAM** 

**MODE**  *Press the MODE button repeatedly until this setup screen appears.*

**12**

 **ON** indicates that the thermostat jumper is set for Electric Heat operation, or **OFF** for Gas/Electric or Heat Pump operation.



*Note: Press the MODE button momentarily to move through the setup screens. Press and hold the MODE button to move backwards through the setup screens.*

Press  **PROGRAM**

Press the PROGRAM button to leave the Setup screens. If no buttons are pressed, the display will leave the setup screens after 30 seconds.

### *Using Emergency Heat*

**ENTER EMERGENCY HEAT:** Only available if you have a Heat Pump installed. To initiate the Emergency Heat feature, press the FAN button. While holding the FAN button press the UP button. The Cool setpoint display will read 'EH' (emergency heat).

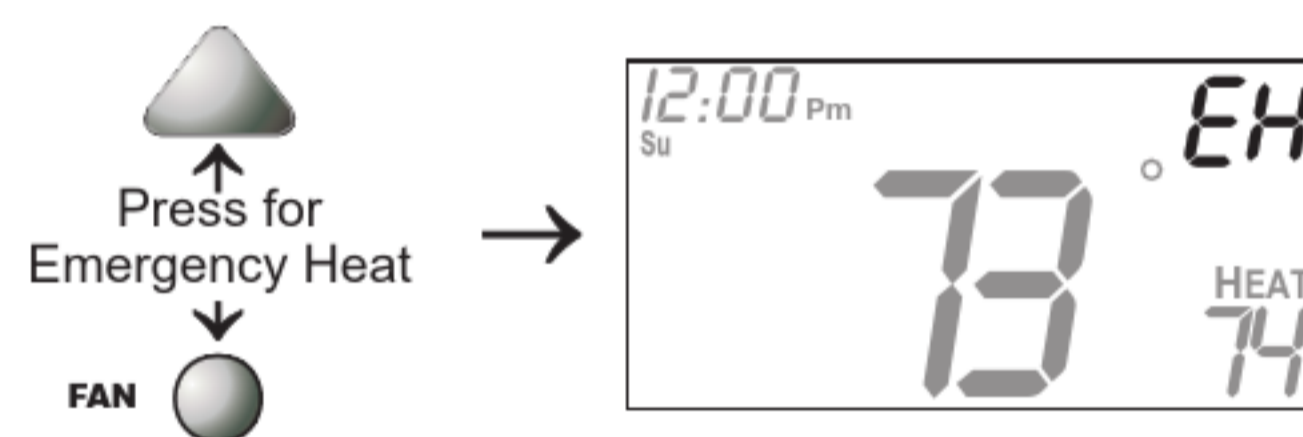

**OPERATION:** During Emergency Heat operation the thermostat will turn on the fan and the 2nd stage of heat when there is a demand for heat. Also during Emergency Heat the 1st stage of heating or cooling will be unavailable.

**12**

**EXIT EMERGENCY HEAT:** Follow the same steps as entering Emergency Heat by pressing the FAN and UP buttons. During Emergency Heat, only OFF and HEAT modes are available by pressing the MODE button.



**Section 13 Contents:**

- *Adjusting the Heat/Cool Differential.....13.2*
- *Adjusting the Cycles Per Hour.....13.3*
- *Adjusting the Deadband.....13.4*
- *Adjusting the Minutes of Run-Time Before the Next Stage.....13.6*
- *Selecting 2nd Stage Turn Off Temperature.....13.7*

**13**

### *Adjusting the Heat/Cool Differential*

The Heat and Cool setpoints will not be allowed to come any closer to each other than the value in this step. This minimum difference is enforced during Auto-Changeover operation.

- MODE**  *Press the MODE button. While holding the MODE, press the PROGRAM button to enter Setup screens.*
- PROGRAM**  *Press the MODE button repeatedly until this setup screen appears.*

*Note: Press the MODE button momentarily to move through the setup screens. Press and hold the MODE button to move backwards through the setup screens.*

 Adjust the minimum **difference** between cooling & heating setpoints.  
(0° - 6°)



Press 

**13**

Press the PROGRAM button to leave the Setup screens. If no buttons are pressed, the display will leave the setup screens after 30 seconds.

**Note:** To increase the spread between the heating and cooling setpoints, press the MODE button until only the heat setpoint is displayed. Adjust the desired setpoint. Wait two seconds after adjusting the set point so the thermostat can accept the change. Press the MODE button until only the cool setpoint is displayed. Adjust the desired setpoint. Wait two seconds after adjusting the set point so the thermostat can accept the change. Press the MODE button again to enter the Auto-Changeover mode where both the heat and cool setpoints are displayed.

### *Adjusting the Cycles Per Hour*

The Cycles Per Hour setting limits the number of times per hour your HVAC unit may energize. For example, at a setting of 6 cycles per hour the HVAC unit will only be allowed to energize once every 10 minutes. The Cycles Per Hour limit may be overridden and reset by pressing the UP or DOWN buttons on the thermostat.

**MODE**  *Press the MODE button. While holding the MODE, press the PROGRAM button to enter Setup screens.*

**PROGRAM** 

**MODE**  *Press the MODE button repeatedly until this setup screen appears.*

*Note: Press the MODE button momentarily to move through the setup screens. Press and hold the MODE button to move backwards through the setup screens.*

**13**



Select the cycles per hour limit.  
d=cycles per hour limit defeated.  
d1=d + defeat 5 min. compressor lockout.  
(d1, d, 2 - 6)



Press 

Press the PROGRAM button to leave the Setup screens. If no buttons are pressed, the display will leave the setup screens after 30 seconds.

### *Adjusting the Deadband*

MULTI-STAGE OPERATION - Controls up to three Heat and two Cool stages.

The **2nd Stage** of heat or cool is turned on when:

(A) The 1st Stage has been on for the time required (*step #23, page 13.6*). It is adjustable from 0-60 minutes and the default is two minutes.

**And**

(B) The temperature spread from the setpoint is equal to or greater than: *the setpoint plus the 1st stage deadband (step #20, next page), plus the 2nd stage deadband (step #21, next page)*. This 2nd stage deadband is adjustable from 0-10 degrees and the default is two degrees.

The **3rd Stage** of Heat is turned on when:

(A) The 2nd stage has been on for the time required (*step #24, page 13.6*). It is adjustable from 0-60 minutes and the default is two minutes.

**And**

(B) The temperature from the setpoint is equal to or greater than: *the setpoint plus the 1st stage deadband (step #20, next page), plus the 2nd stage deadband (step #21, next page) plus the 3rd stage deadband (step #22, next page)*. This 3rd stage deadband is adjustable from 0-10 degrees and the default is two degrees.

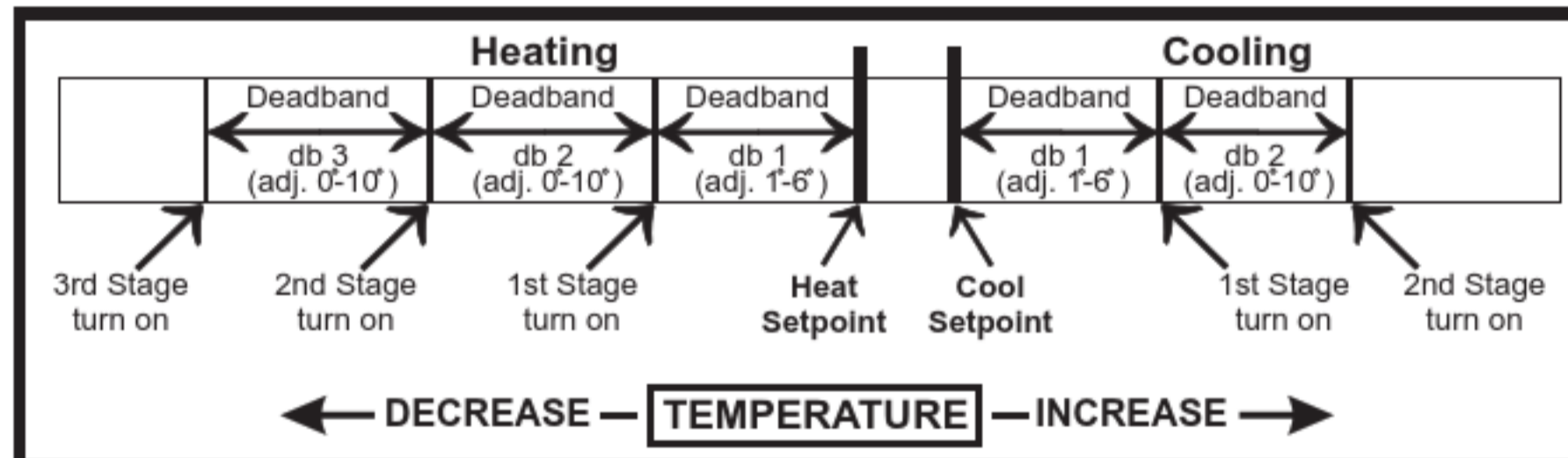

**13**



The above figure assumes the minimum on time for the prior stage has been met to allow the next stage to turn on, once the deadbands have been exceeded.



### *Adjusting the Deadband*

For more detailed information, please see the explanation on the previous page.

- MODE**  *Press the MODE button. While holding the MODE, press the PROGRAM button to enter Setup screens.*
- PROGRAM** 
- MODE**  *Press the MODE button repeatedly until this setup screen appears.*

*Note: Press the MODE button momentarily to move through the setup screens. Press and hold the MODE button to move backwards through the setup screens.*



**13**

 Adjust the deadband for the 1st stage.  
 (1° - 6°)



 Adjust the deadband for the 2nd stage.  
 (0° - 10°)



 Adjust the deadband for the 3rd stage.  
 (0° - 10°)



Press the PROGRAM button to leave the Setup screens. If no buttons are pressed, the display will leave the setup screens after 30 seconds.

### *Adjusting the Minutes of Run-Time Before the Next Stage*

For more detailed information, please see the explanation on page 13.4.

**MODE**  *Press the MODE button. While holding the MODE, press the PROGRAM button to enter Setup screens.*

**MODE**  *Press the MODE button repeatedly until this setup screen appears.*

*Note: Press the MODE button momentarily to move through the setup screens. Press and hold the MODE button to move backwards through the setup screens.*

 Adjust the amount of time stage 1 must be on before stage 2 turns on.  
(0 - 60 min.)



 Adjust the amount of time stage 2 must be on before stage 3 turns on.  
(0 - 60 min.)

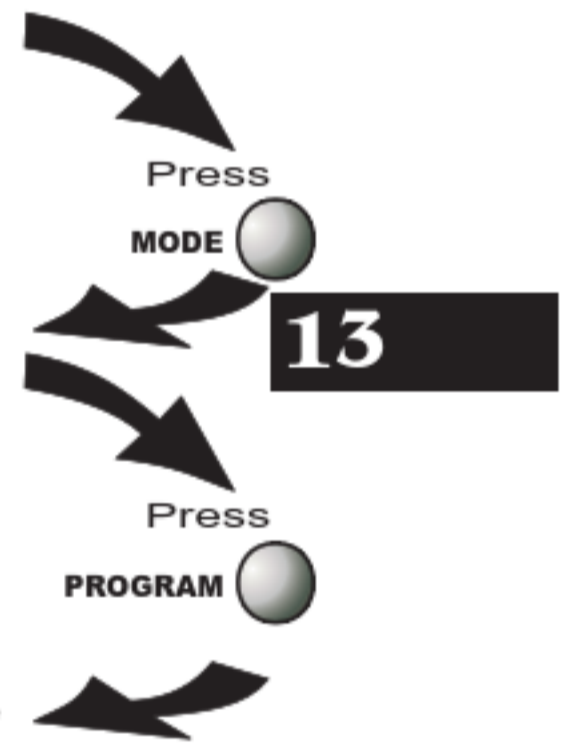

Press the PROGRAM button to leave the Setup screens. If no buttons are pressed, the display will leave the setup screens after 30 seconds.





### Selecting 2nd Stage Turn Off Temperature

If ON is selected, the second stage of cooling or heating will remain energized until the thermostat reaches the setpoint on the thermostat display.

If OFF is selected, the second stage of cooling or heating will turn off after reaching the 1st stage deadband (see page 13.4 for more information).

**13**

**MODE**  **Press the MODE button. While holding the MODE, press the PROGRAM button to enter Setup screens.**

**PROGRAM**  **Press the MODE button repeatedly until this setup screen appears.**

*Note: Press the MODE button momentarily to move through the setup screens. Press and hold the MODE button to move backwards through the setup screens.*

**On**  Select On or Off:  
**On** - 2nd stage will remain on until setpoint is reached.  
**Off** - 2nd stage will turn off after reaching 1st stage deadband.

**Off** 



**Press** 

Press the PROGRAM button to leave the Setup screens. If no buttons are pressed, the display will leave the setup screens after 30 seconds.

## SECTION 14 Energy Save Operation

VENSTAR®

### How to Use the Energy Save Feature

If the thermostat is configured to be programmable (Section 4), and Energy Save has been selected in step #26 (below), the room will attempt to reach the selected comfort temperature at the exact time programmed into the thermostat. Energy Save, more commonly known as Smart Recovery, only works when the thermostat enters Occupied 1 from Unoccupied. For example, if the Unoccupied program is set for 6pm at 55°F heating and 85°F cooling, and the Occupied 1 program is set for 8am at 72°F heating and 75°F cooling, the thermostat will turn the system on before 8am in an effort to bring the temperature to its correct setting at exactly 8am.

The T2800 learns from experience, so please allow 4-8 days after a program change or after initial installation to give Energy Save time to adjust to local weather, the construction of your business, and your heating and cooling system.

**MODE**  **Press the MODE button. While holding the MODE, press the PROGRAM button to enter Setup screens.**

**PROGRAM**  **Press the MODE button repeatedly until this setup screen appears.**

**Note:** Press the MODE button momentarily to move through the setup screens. Press and hold the MODE button to move backwards through the setup screens.

**14**

**On**  
 Select Energy Save on or off.

**Off**  

**ES** Setup **26**  
**OFF**

Press **PROGRAM** 

Press the PROGRAM button to leave the Setup screens. If no buttons are pressed, the display will leave the setup screens after 30 seconds.

**SECTION 15**

*Programming Run-Time Alerts*



**Section 15 Contents:**

- *Setting and Resetting the Service Filter (Fan Run-Time) Alert.....15.2*
- *Setting and Resetting the UV Light Run-Time Alert.....15.3*
- *Setting and Resetting the Humidify Run-Time Alert.....15.4*

**15**

### *How to Set and Reset the Service Filter (Fan Run-Time) Alert*

This counter keeps track of the number of hours of fan run-time whether the fan is energized in the Heating or Cooling modes, or in stand alone fan operation. The Service Filter icon will appear after the preset number of hours of fan run-time in step #28 (below) has been achieved. Setting this counter to zero in step #28 will prevent the Service Filter icon from ever appearing.

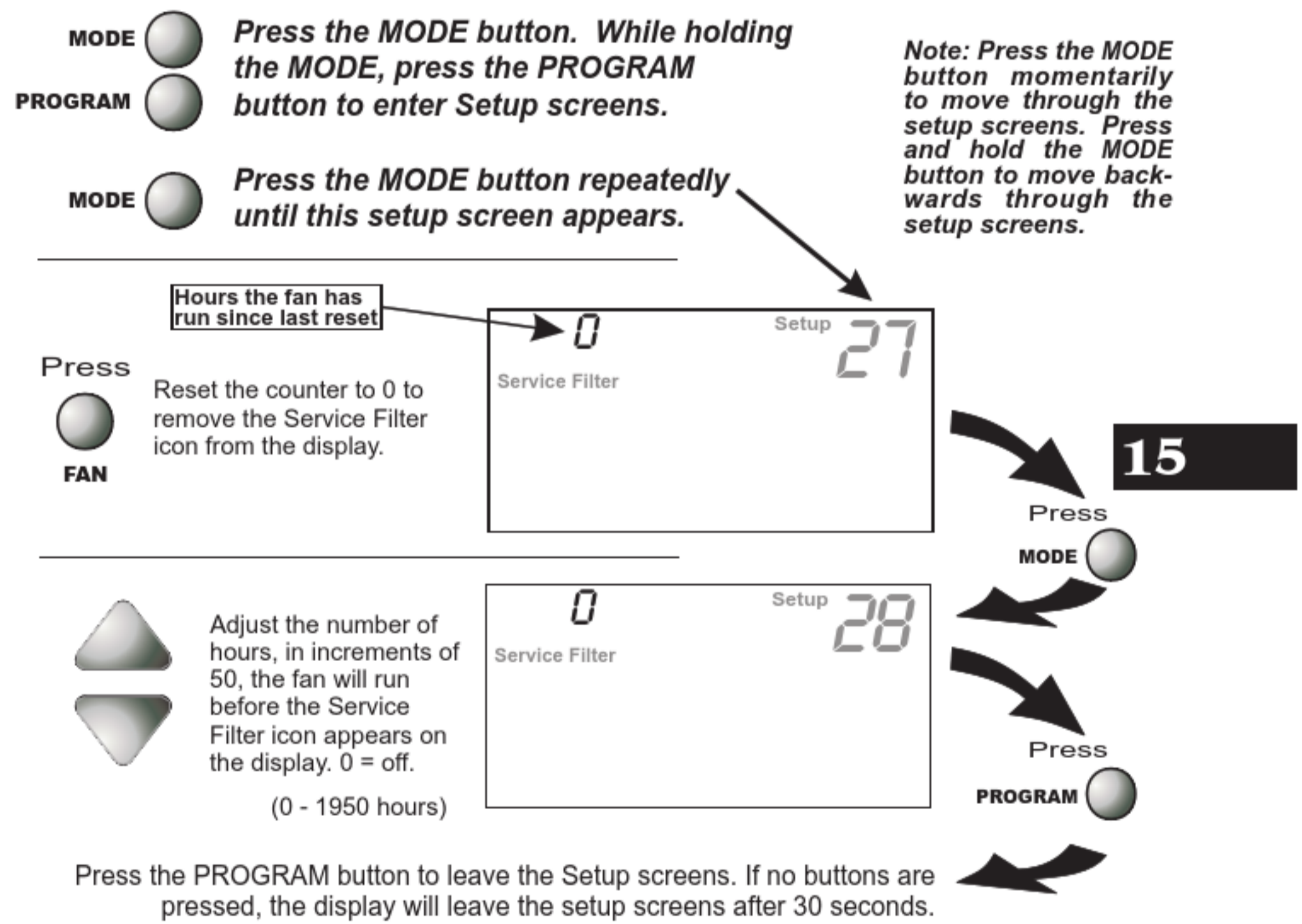

### *How to Set and Reset the UV Light Run-Time Alert*

This counter keeps track of the number of days since the UV Light counter has been reset. The UV Light icon will appear after the number of days has been achieved, as shown in step #29 (below). Setting the counter to zero in Step #29 will prevent the Service UV Light icon from ever appearing.

**MODE**  *Press the MODE button. While holding the MODE, press the PROGRAM button to enter Setup screens.*

**PROGRAM** 

**MODE**  *Press the MODE button repeatedly until this setup screen appears.*

*Note: Press the MODE button momentarily to move through the setup screens. Press and hold the MODE button to move backwards through the setup screens.*

---

**15**  **FAN**

**Days since the UV Light icon has been reset** → **0** Setup **14**

**Service UV Light**

**Press**  *Reset the counter to 0 to remove the Service UV Light icon from the display.*

---

**MODE**  *Press the MODE button repeatedly until this setup screen appears.*

 *Adjust the number of days in increments of 10 before the UV Light icon appears on the display. 0 = off.*

 *(0 - 1990 days)*

**0** Setup **29**



**Service UV Light**

**Press**  **PROGRAM**

*Press the PROGRAM button to leave the Setup screens. If no buttons are pressed, the display will leave the setup screens after 30 seconds.*

## How to Set and Reset the Humidifier Run-Time Alert

This counter keeps track of the number of days since the Service Humidify icon was last reset; this icon will appear after the number of days set in step #30 (*below*) has elapsed. Setting this counter to zero in step #30 will prevent the Service Humidify icon from ever appearing.

- MODE**  **Press the MODE button. While holding the MODE, press the PROGRAM button to enter Setup screens.**
  - PROGRAM**  **Press the MODE button repeatedly until this setup screen appears.**
- Note: Press the MODE button momentarily to move through the setup screens. Press and hold the MODE button to move backwards through the setup screens.*

Days since the last reset of the Service Humidify counter.

Press  **FAN** Reset the counter to 0 to remove the Service Humidify icon from the display.





- MODE**  **Press the MODE button repeatedly until this setup screen appears.**

**15**

 Adjust the number of days in increments of 10 before the Service Humidify icon appears. 0 = Off

 (0 - 1990 days)

Press  **PROGRAM**



Press the PROGRAM button to leave the Setup screens. If no buttons are pressed, the display will leave the setup screens after 30 seconds.

 **The humidifier run-time alert does not take the place of any humidifier manufacturer's recommended maintenance plan; it only serves as a helpful reminder.**

## SECTION 16 Programming Holiday Mode

VENSTAR®

When the thermostat is programmed for a Holiday mode, it will take effect at 12:00 am of the next day. *In order for the Holiday mode to take effect the thermostat must be in the Program On mode.* The thermostat will control to the Unoccupied cooling and heating setpoints set in Section 6, pages 6.2 and 6.3. Holiday setpoints will be enforced for the number of days specified in step #1 (0 - 99 days).

Press  
HOLIDAY 

Press the HOLIDAY button to enter the Holiday programming setup steps.



Select the number of days that the Holiday schedule will be in effect. A value of 0 disables Holiday mode.  
(0 - 99 days)



Press  
HOLIDAY 

Press the HOLIDAY button to exit the setup screens. If no buttons are pressed, the display will leave the setup screens after 30 seconds.

### *Programming Holiday Mode (continued)*

HOLIDAY DISPLAY - When the thermostat is placed into the Holiday mode, the thermostat will display the screen shown below.



To return the thermostat to normal operation from Holiday mode, press the HOLIDAY button and adjust the number of days in step #1 to zero (see previous page).

Press the HOLIDAY button to return to normal operation.

### *Overriding the Holiday Mode*

Pressing the OVERRIDE button during Holiday Mode will temporarily force the thermostat into Occupied 1 comfort settings for 30 min. The remaining Override time will alternate with the clock display.

The Override timer can be set up to a maximum of four (4:00) hours, in increments of 30 minutes. If the timer has been set for the maximum time, the next press of the OVERRIDE button will reset the timer, returning the thermostat to the correct time period program for the day.

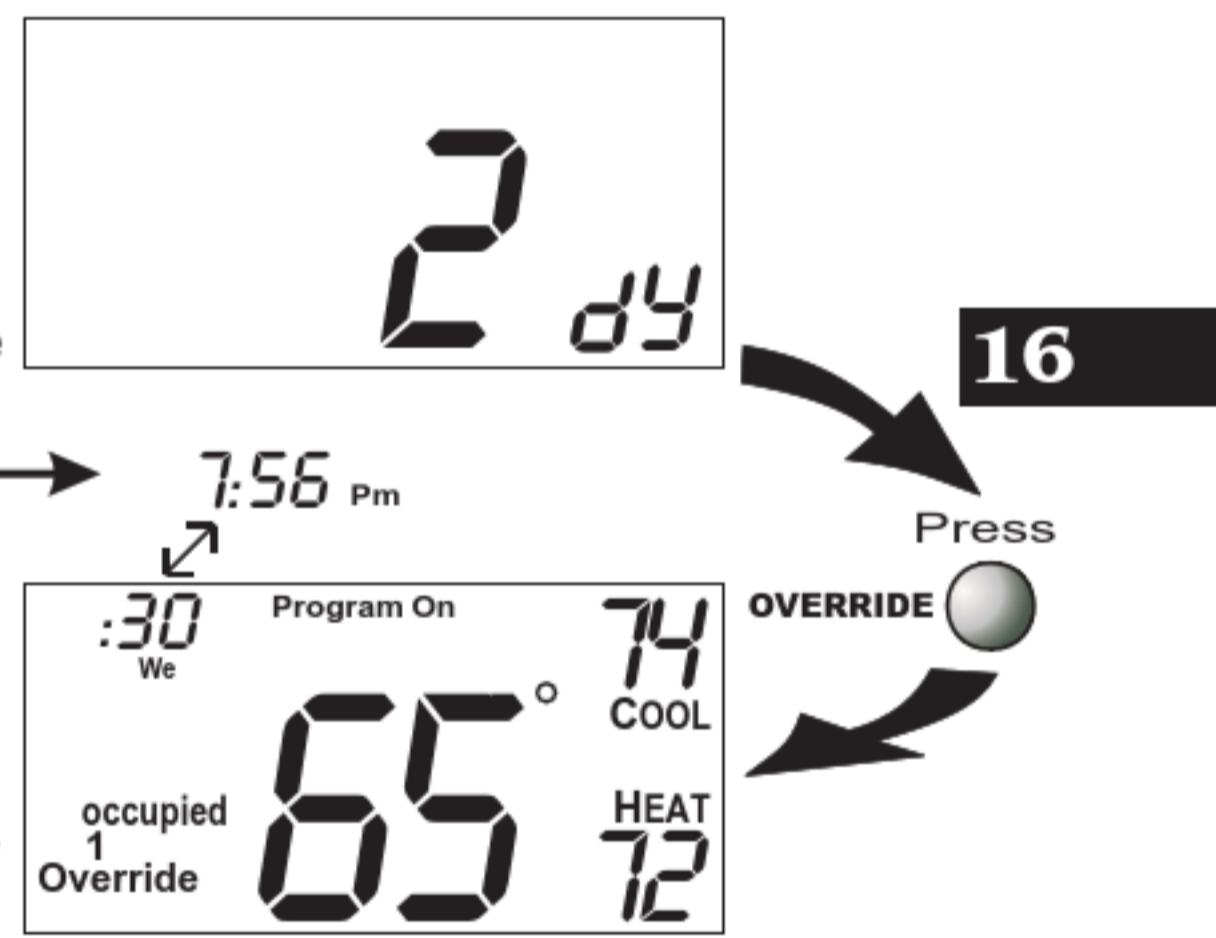



**SECTION 17** *Configuring the MISC Outputs* **VENSTAR®**

**Section 17 Contents:**

- *Configuring the Jumpers.....17.2*
- *Explanation of Jumper Settings.....17.3*

### Configuring the Jumpers

For additional flexibility, your thermostat has three configurable outputs. These outputs are designed to have different functions depending on how the jumpers are set (*below*). Each output, labeled MISC1, MISC2, and MISC3 may be set for one of the four choices available. In the diagram below, the MISC3 jumper has been set for HUM\* (humidification) operation, the MISC2 jumper has been set for DEHUM\* (dehumidification) operation, and the MISC1 jumper has been set for Y2 (second stage cooling) operation.

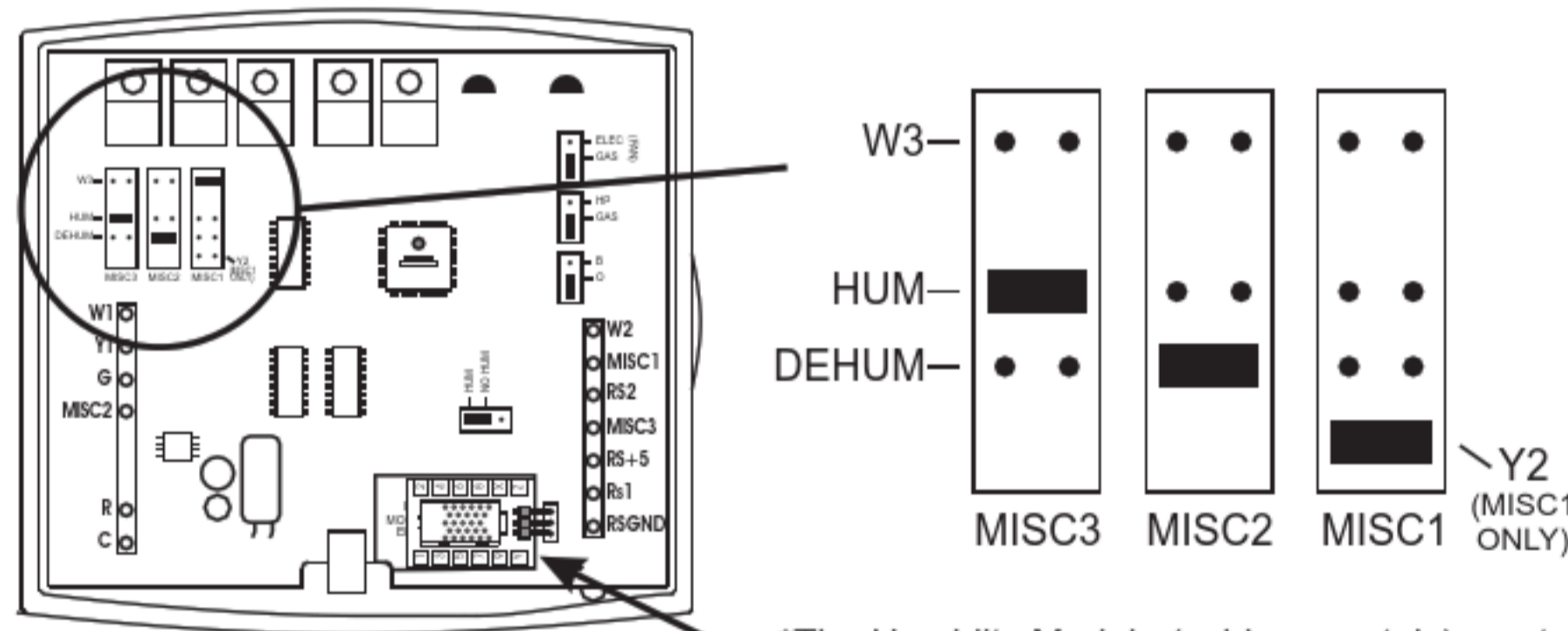

\*The Humidity Module (sold separately) must be installed to operate a humidification and/or dehumidification system.

**CAUTION**  
**NEVER PUT MORE THAN ONE JUMPER ON THE SAME MISC JUMPER BLOCK!**  
**DOING SO MAY DAMAGE YOUR THERMOSTAT.**

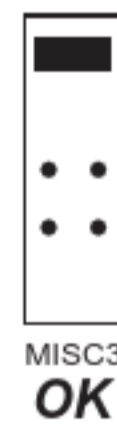

## Explanation of Jumper Settings

### W3 JUMPER SETTING

If the jumper for MISC1, MISC2, or MISC3 is set to W3, the corresponding MISC screw terminal on the backplate will control a third stage of heat.

#### W3 MULTI-STAGE OPERATION EXPLAINED - SECTION 13.4

The **3rd Stage** of Heat is turned on when:

**(A)** The 1st and 2nd stages have been on for the time required (steps 23 and 24, page 13.6). It is adjustable from 0-60 minutes and the default is two minutes.

**And**

**(B)** The temperature from the setpoint is equal to or greater than: *the setpoint plus the 1st stage deadband (step #20, 13.5), plus the 2nd stage deadband (step #21, 13.5) plus the 3rd stage deadband (step #22, 13.5)*. This 3rd stage deadband is adjustable from 0-10 degrees and the default is two degrees.

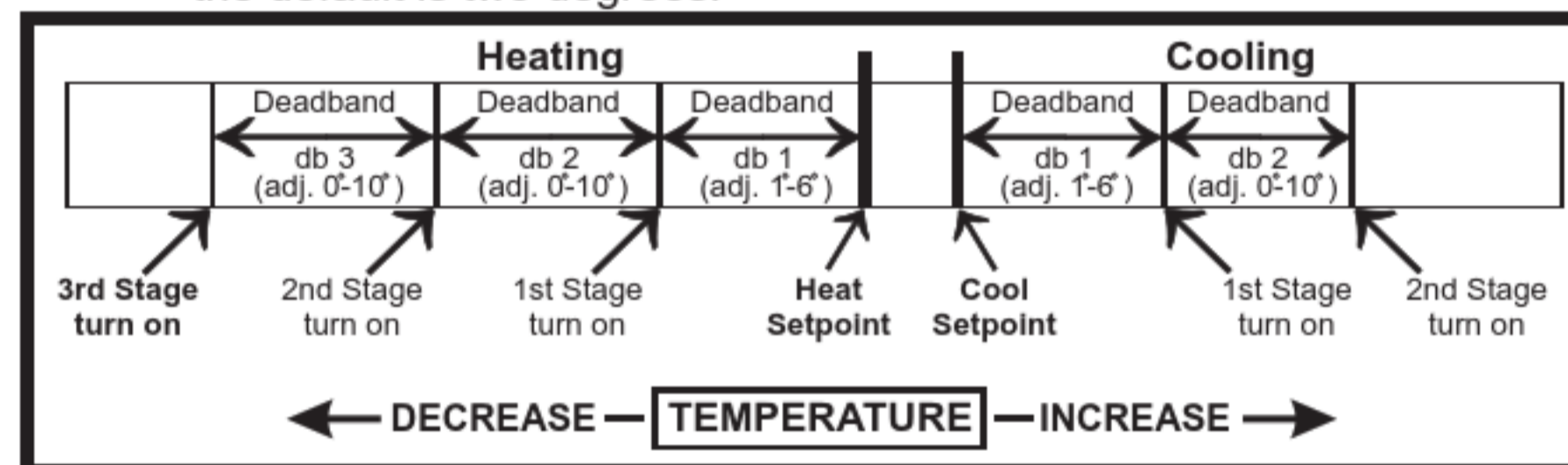

### 17 HUM JUMPER SETTING

If the jumper for MISC1, MISC2, or MISC3 is set to HUM, the corresponding MISC screw terminal on the backplate will control a humidification system.

#### HUMIDIFICATION OPERATION - SECTION 9

If your HVAC unit is equipped with a humidification system and the Humidity Module (sold separately) has been installed, the thermostat will provide power to the MISC1, MISC2, or MISC3 terminal of the thermostat when the humidity in the home falls below the humidity setpoint you have chosen. The value for this setpoint ranges from 0% to 60%. If no humidity is desired or if a humidification system has not been installed, set the value to 0%.

### *Explanation of Jumper Settings (continued)*

#### **DEHUM JUMPER SETTING**

*If the jumper for MISC1, MISC2, or MISC3 is set to DEHUM, the corresponding MISC screw terminal on the backplate will be connected to the dehumidification terminal of a furnace board.*

**NOTE:** *Not all furnaces have a dehumidification terminal.*

#### DEHUMIDIFICATION OPERATION - SECTION 10

If your HVAC unit is equipped with a dehumidification system the thermostat will operate in one of two ways.

- 1) **Normally Closed (NC):** The thermostat will **de-energize** the MISC1, MISC2, or MISC3 terminal of the thermostat (this MISC terminal is connected to the DEHUM terminal on your furnace) to allow the fan to run in low speed when the humidity in the home is above the dehumidify setpoint you have chosen and there is a call for 1st stage cooling.
- 2) **Normally Open (NO):** The thermostat will **energize** the MISC1, MISC2, or MISC3 terminal of the thermostat (this MISC terminal is connected to the DEHUM terminal on your furnace) to allow the fan to run in low speed when the humidity in the home is above the dehumidify setpoint you have chosen and there is a call for 1st stage cooling.

*Explanation of Jumper Settings (continued)*

**Y2 JUMPER SETTING**

*If the jumper for MISC1 is set to Y2 the MISC1 screw terminal on the backplate will control a second stage of cooling.*

Y2 OPERATION - SECTION 13.4

Control up to two Cool stages.

The **2nd Stage** of heat or cool is turned on when:

- (A) The 1st Stage has been on for the time required (*step #23, page 13.6*). It is adjustable from 0-60 minutes and the default is two minutes.

**And**

- (B) The temperature spread from the setpoint is equal to or greater than: *the setpoint plus the deadband (step #24, page 13.6), plus the 2nd deadband (step #21, page 13.5)*. This 2nd deadband is adjustable from 0-10 degrees and the default is two degrees.

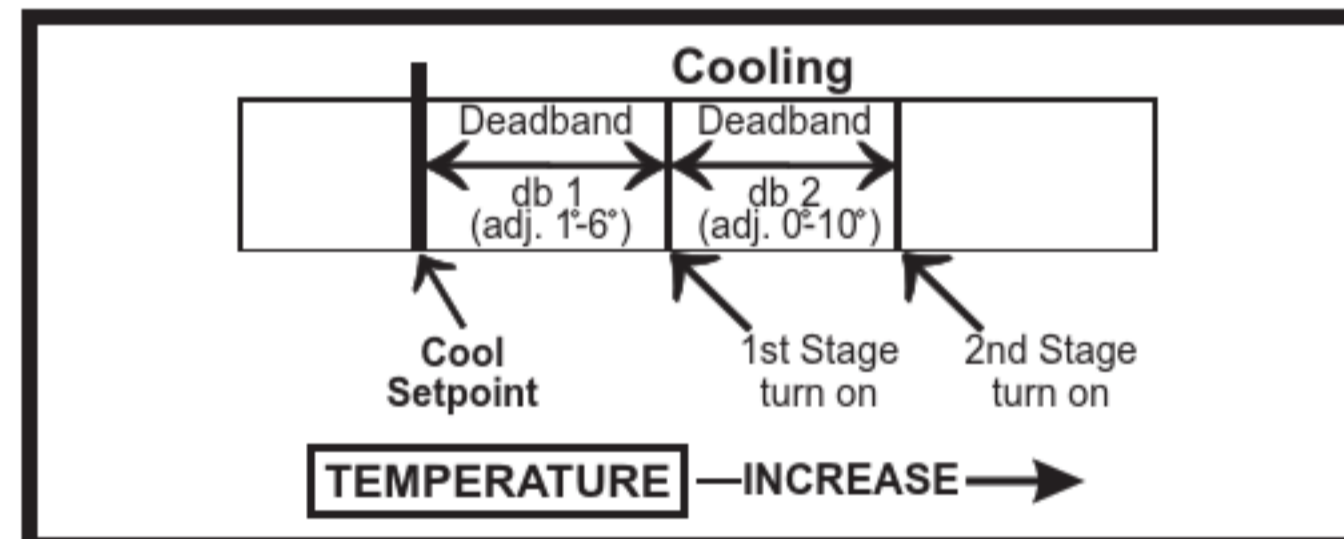

**SECTION 18**  
*Factory Defaults, Calibration, and Sensors*

**VENSTAR®**

**Section 18 Contents:**

- *Resetting the Thermostat to the  
Factory Default Settings.....18.2*
- *Calibrating the Temperature  
and Humidity Sensors.....18.3*

***Resetting the Thermostat to the Factory Default Settings (for default values see page 20.1)***

If, for any reason, you desire to return all the stored settings back to the factory default settings, follow the instructions below.

**WARNING: This will reset all Time Period and Advanced Programming to the default settings. Any information entered prior to this reset may be permanently lost.**

**1**

**MODE**  Place the thermostat in the OFF mode.



**2**

**MODE**  Press and hold the MODE button. While holding the MODE button, press and hold the FAN button for 5 seconds. All icons will appear on the display.

**FAN** 



**3**

**FAN**  After all of the icons appear, release the MODE and FAN buttons. Then press and hold the FAN button for 5 seconds.

**18**



**4**

**MODE**  After the letters **Fd** appear on the display (Factory Default), release the FAN button. Press the MODE button **once** to return to normal operation.





### Calibrating the Temperature and Humidity Sensors

Under normal circumstances it will not be necessary to adjust the calibration of the temperature and humidity sensors. If calibration is required, please contact a trained HVAC technician to correctly perform the following procedure.

- 1**

**MODE**  Place the thermostat in the OFF mode.

- 2**

**MODE**  Press and hold the MODE button. While holding the MODE button, press and hold the FAN button for 5 seconds. All icons will appear on the display.

**FAN** 



- 3**

**PRESS**  **THERMOSTAT SENSOR**

Press the UP and DOWN buttons at the same time twice. The thermostat temperature will be displayed and may be calibrated using the UP or DOWN buttons.

**TWICE** 



**CALIBRATE** 
- 4**

**MODE**  Press the MODE button once. The relative humidity at the thermostat will be displayed and may be calibrated using the UP or DOWN buttons.

**HUMIDITY SENSOR**



**CALIBRATE** 

**18**

After calibration is complete, press the MODE button to return to normal operation.



## SECTION 19

### Accessories

VENSTAR®

**ACCESSORY PORT** - The RJ11 Jack is used to connect the T2800 to the IR Receiver (ACC0431) for wireless communication or the EZ Programmer (ACC0432) for easy downloading or uploading of thermostat information.

*The Accessory Port is located on the bottom of the thermostat.*

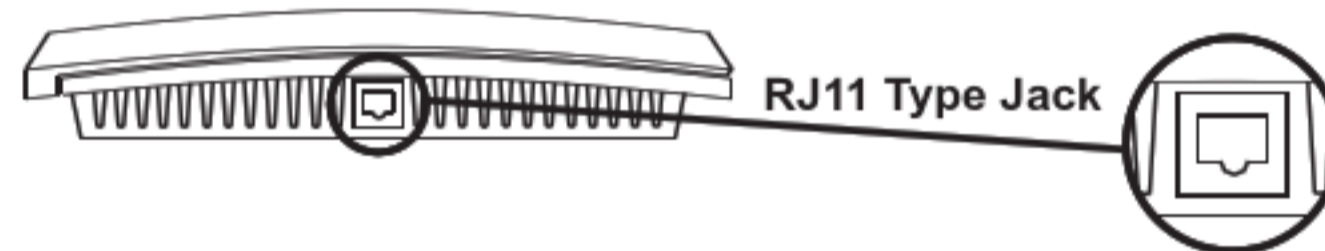

**IR RECEIVER / REMOTE CONTROL** (optional accessory) - When the IR Receiver is connected, the thermostat can be controlled using an IR Remote Control. The thermostat may also interface with other wireless systems in your home. For more information see the manual for the IR Receiver (ACC0431).

**EZ PROGRAMMER** (optional accessory) - When the EZ Programmer is connected, the thermostat Time Period Programming and Advanced Setup Programming can be stored into the EZ Programmer's memory. This information can then be uploaded to other T2800 thermostats. For more information see the manual for the (ACC0432).

**COMFORT CALL** (optional accessory) - When Comfort call is connected, the thermostat's Heating and cooling functionality may be accessed and controlled through the phone. For more information see the manual for Comfort Call (ACC0433).

**19**

## SECTION 20 Advanced Setup Table

**VENSTAR®**

Step#	Description	Pg#	Range	Df*	Step#	Description	Pg#	Range	Df*
1	Programmable Thermostat	4.2	Yes/No	Yes	17	Electric Heat	12.3	read only	--
2	Auto-Changeover Thermostat	4.3	Yes/No	Yes	18	Minimum Heat/Cool Differential	13.2	0 - 6°	2°
3	Fan Off Delay	7.3	0, 30, 60, 90	0	19	Cycles Per Hour	13.3	d1, d, 2-6	6
4	Thermoglow Backlight	8.2	Auto/On/Off	Auto	20	Deadband/Temp. Swing 1st Stage	13.5	1 - 6°	2°
5	F or C	8.2	F/C	F	21	Deadband/Temp. Swing 2nd Stage	13.5	0° - 10°	2°
6	Security Level	8.4	0 - 3	0	22	Deadband/Temp. Swing 3rd Stage	13.5	0° - 10°	2°
7	Max Heat Setpoint	8.4	35° - 99°	80°	23	Minutes Between Stage 1 & 2	13.6	0-60min	2
8	Min Cool Setpoint	8.4	35° - 99°	65°	24	Minutes Between Stage 2 & 3	13.6	0-60min	2
9	Cool to Dehumidify	10.4	On/Off	Off	25	2nd Stage turn off at setpoint	13.7	On/Off	Off
10	Maximum Dehum Overshoot	10.4	0° - 5°	3°	26	Energy Save	14.1	Off/On	Off
11	DEHUM Terminal Polarity	10.5	NO/NC	NC	27	Reset Service Filter Icon	15.2	read only	--
12	Override Run-Time	11.2	read only	--	28	Service Filter Run Time Set	15.2	0 - 1950	0
13	Reset Service Humidify Icon	11.3	read only	--	29	UV Light Run-Time Set	15.3	0 - 1990	0
14	Reset UV Light Icon	11.4	read only	--	30	Service Humidify Run-Time Set	15.4	0 - 1990	0
15	Heatpump Jumper Setting	12.2	read only	--					
16	Reversing Valve Jumper Setting	12.2	read only	--					

\*Df = Factory Default Setting

**VENSTAR** SECTION 21 *Index*



**Accessory Port, 19.1**

**Alerts**

see *Run-Time*

**Auto**

adjust temperature, 1.4, 4.8

changeover, 4.5, 4.7, 20.1

differential, see *Differential*

fan, 7.2

icon, 2.3

lockout, 4.3

mode, 1.3

**AuxHeat icon, 2.4**



**b reversing valve, 12.2**

**Buttons**

down, 1.2, 2.2, 8.3, 12.4

fan, 1.4, 2.2, 7.2, 12.4, 18.2

front panel, 2.2

humidity, 2.2, 5.3, 8.3, 9.3

Holiday, 2.2, 5.2, 16.1

mode, 1.3, 2.2, 4.2,

8.3, 18.2  
 outdoor, 2.2, 5.2  
 Override, 2.2, 6.6  
 up, 1.2, 2.2, 8.3,  
 12.4



**C, 8.2, 20.1**

**Calibration, 18.3**

**Celsius, 8.2**

**Clock**

display, 2.3

setting, 2.2, 3.2

**Compressor Lockout, 13.3**

**Cool**

1st stage  
 deadband, see *Deadband*

dehum, 10.5

minutes of run-time, 13.4, 17.5, 20.1

2nd stage

deadband, see *Deadband*

dehum, 10.5

minutes of run-time, 13.4, 17.5, 20.1

turn off

temperature, 13.7, 20.1  
 Y2 operation, 17.5

deadband, see

*Deadband*

droop, see *Deadband*

electric/heat pump, 12.2

icon, 2.3

indicator, 2.2

mode, 1.3

overshoot, see

*Overshoot*

program, see *Program*

run-time, see *Run-Time*

setpoint, 1.3-1.4, 6.2, 6.5

to dehumidify, see *Dehumidify*

**Copy Function**

see *Program*

**Cycles Per Hour, 13.3, 20.1**



**Day**

display, 2.3

setting, 1.2, 3.2

**Deadband**

1st stage, 13.4-13.5, 13.7, 17.5, 20.1

2nd stage, 13.4-13.5,

**VENSTAR** SECTION 21 *Index*

3rd stage, 13.4-13.5,  
13.7, 20.1

**Dehumidify**

cool to, 10.3, 20.1  
DEHUM jumper,  
10.5  
icon, 2.4  
setpoint, 10.2

**Delay**

fan-off, see *Fan*  
time between stages,  
see *Time Delay*

**Differential**

heat and cool, 13.2,  
20.1  
humidify and  
dehumidify, 9.3,  
10.2

**Disabled Keypad**

see *Keypad Lockout*



**EH, 12.4**

**Electric Heating**

AuxHeat icon, 2.4  
jumper setting, 12.3  
20.1

**Emergency Heat,  
12.4**

**Energy Save, 14.1**

**EZ Programmer, 23.1**



**F, 8.2, 20.1**

**Factory Defaults**

caution, ii  
settings, 18.2  
resetting, 18.2

**Fahrenheit, 8.2**

**Fan**

button function, see  
*Buttons*  
off time delay, 7.3,  
20.1  
on during heat, see  
*Electric Heat*  
on icon, 1.4, 2.4, 7.2  
run-time, 15.2  
2nd stage heat, see  
*Emergency Heat*  
speed, see  
*Dehumidify*  
unoccupied, 7.2

**Fd, 18.2**

**Flashing Selection,  
2.2**



**Gas Furnace**

control the fan, 12.3

jumper, 12.2

**Green Indicator, 2.2**



**Heat**

1st stage  
deadband, see  
*Deadband*  
emergency heat,  
12.4  
minutes of run-  
time, 13.4, 17.5,  
20.1  
2nd stage  
deadband, see  
*Deadband*  
emergency heat,  
12.4  
electric strip heat,  
2.5  
minutes of run-  
time, 13.4, 17.3,  
20.1  
3rd stage  
deadband, see  
*Deadband*  
W3, 17.3  
AuxHeat icon, 2.4  
deadband, see  
*Deadband*  
droop, see *Deadband*  
electric/heat pump,

**VENSTAR** SECTION 21 *Index*

12.2  
 icon, 2.3  
 indicator, 2.2  
 mode, 1.3  
 program, see *Program*  
 run-time, see *Run-Time*  
 setpoint, 1.3-1.4, 6.2, 6.5

**Heat Pump**  
 AuxHeat, 2.4  
 emergency heat, 12.4  
 jumper setting, 12.2

**Hi**  
 icon, 2.4, 5.2  
 security setpoint, 8.4  
 temperature, 5.2

**Holiday**  
 button, see *Buttons*  
 mode, 16.1-16.2  
 programming, 16.1-16.2  
 setpoints, 16.1

**Humidify**  
 icon, 2.4  
 service, 11.3, 15.4, 20.1  
 setpoint, 9.3

**Humidity Module**  
 connector, 9.2  
 installation, 9.2  
 jumper setting, 9.2  
 required for, 5.3,



**Internet-based Operation,**  
 see *Programmable Output*

**IR Receiver, 19.1**  
**IR Remote Control, 19.1**



**Jumpers**  
 DEHUM, 17.3  
 ELEC, 12.3  
 electric heat, 12.3  
 gas electric, 12.2  
 heat pump, 12.2, 20.1  
 HUM, 9.2, 17.2-17.3  
 reversing valve, 12.2, 20.1  
 W3, 17.3  
 Y2, 17.2-17.3



**Keypad Lockout, 2.4, 8.3**



**LCD, 2.2**  
**Locked Indication**  
 see *Keypad Lockout*

**Lo**  
 icon, 2.4, 5.2  
 security setpoint, 8.4  
 temperature, 5.2



**Manual**  
 changeover, 4.4, 4.6  
 cool, 4.3  
 heat, 4.3

**Maximum Outdoor Temperature, see Hi**  
**Minimum Outdoor Temperature, see Lo**

**MISC**  
 jumper, see *Jumpers*  
 output, 17.2-17.3

**Mode icon, 1.3, 2.3**  
**Multi-stage Operation, 13.4**

**VENSTAR** SECTION 21 *Index*



**Non-Programmable Thermostat, 4.2, 4.4-4.5**

**Normally**

**Open/Closed,**  
dehum terminal,  
10.5



**O Reversing Valve, 12.2**

**Occupied I**

daily schedule, see  
*Program*

energy save, 18.1  
icon, 1.3  
mode, 1.3, 4.6-4.7  
override, 6.6  
programming, 6.2-6.5

programming  
worksheet, back  
Page

**Off Mode, 1.3, 2.3**

**Outdoor**

button, see *Buttons*

icon, 2.3  
sensor, 2.3, 5.2  
viewing  
temperature, 2.3,  
5.2

**Override**

button, see *Buttons*  
daily schedule, 6.6  
icon, 2.3  
timer, 6.6  
viewing run-time,  
11.2, 20.1

**Overshoot, 10.3, 20.1**



**Program**

copy, 6.4-6.5  
daily schedule, 6.2-6.5  
mode, 1.4, 4.6-4.8  
on at all times, 8.4  
On icon, 2.3  
override, see

**Override**

setpoint limits, 8.4  
tips, 6.5  
worksheet, back  
page

**Programmable Thermostat, 4.2**



**Red Indicator, 2.2**

**Reset**

thermostat settings,  
see *Factory Defaults*  
run-time  
fan/filter, 15.2,  
20.1  
humidify, 15.4,  
UV light, 15.3,  
20.1

**RS2, see Outdoor Sensor**

**Run-Time**

resetting, see *Reset*  
setting,  
humidifier, 15.4,  
20.1  
service filter, 15.2,  
20.1  
UV light, 11.4,  
15.3, 20.1  
viewing,  
Humidification,  
11.5, 24.1  
override, 11.2,  
UV light, 11.6

**VENSTAR** SECTION 21 *Index*



**Schedule, Daily**,  
see *Program*

**2nd stage turn off temperature**,  
13.7, 20.1

**Security**  
level, 8.4, 20.1  
setpoints, 8.4, 20.1

**Sensor**  
outdoor, see *Outdoor thermostat*, see  
*Thermostat Sensor*

**Service**  
filter icon, see *Reset humidify icon*, see  
*Reset*  
UV light, see *Reset*

**Set Clock**, see *Clock*

**Setpoint**  
cool, see *Cool dehumidification*, 9.4, 10.3, 10.5  
heat, see *Heat holiday*, 16.1  
humidification, 5.3, 9.4, 10.3  
occupied, 6.2  
security, 8.4  
unoccupied, 6.2-6.3

**Setup Icon**, 2.4

**Simplest Operation**,

4.2-4.3  
**Smart Fan**, 7.2  
**Smart Recovery**, see  
*Energy Save*



**Terminal, MISC**, see  
*MISC*

**Thermostat Sensor**  
calibrate, 22.3

**Time**, see *Clock*

**Time Delay**,  
compressor lockout,  
13.3  
cycles per hour,  
13.3, 20.1  
1st to 2nd stage,  
13.6, 20.1  
2nd to 3rd stage,  
13.6, 20.1

**Time Schedule**, see  
*Program*



**Unoccupied**  
icon, 2.3  
operation, 6.5  
override, see  
*Override*

setpoint, 6.2-6.3

**UV Light**  
icon, 2.4  
resetting, see *Reset*  
run-time, see *Run-Time*  
setting, see *Run-Time*



**W3**, see *Jumpers Warranty*, 22.1



**Y2**, see *Jumpers*

## Section 22 Warranty

**VENSTAR®**

One-Year Warranty - This Product is warranted to be free from defects in material and workmanship. If it appears within one year from the date of original installation, whether or not actual use begins on that date, that the product does not meet this warranty, a new or remanufactured part, at the manufacturer's sole option to replace any defective part, will be provided without charge for the part itself provided the defective part is returned to the distributor through a qualified servicing dealer.

THIS WARRANTY DOES NOT INCLUDE LABOR OR OTHER COSTS incurred for diagnosing, repairing, removing, installing, shipping, servicing or handling of either defective parts or replacement parts. Such costs may be covered by a separate warranty provided by the installer.

THIS WARRANTY APPLIES ONLY TO PRODUCTS IN THEIR ORIGINAL INSTALLATION LOCATION AND BECOMES VOID UPON REINSTALLATION.

LIMITATIONS OF WARRANTIES – ALL IMPLIED WARRANTIES (INCLUDING IMPLIED WARRANTIES OF FITNESS FOR A PARTICULAR PURPOSE AND MERCHANTABILITY) ARE HEREBY LIMITED IN DURATION TO THE PERIOD FOR WHICH THE LIMITED WARRANTY IS GIVEN. SOME STATES DO NOT ALLOW LIMITATIONS ON HOW LONG AN IMPLIED WARRANTY LASTS, SO THE ABOVE MAY NOT APPLY TO YOU. THE EXPRESSED WARRANTIES MADE IN THIS WARRANTY ARE EXCLUSIVE AND MAY NOT BE ALTERED, ENLARGED, OR CHANGED BY ANY DISTRIBUTOR, DEALER, OR OTHER PERSON WHATSOEVER.

ALL WORK UNDER THE TERMS OF THIS WARRANTY SHALL BE PERFORMED DURING NORMAL WORKING HOURS. ALL REPLACEMENT PARTS, WHETHER NEW OR REMANUFACTURED, ASSUME AS THEIR WARRANTY PERIOD ONLY THE REMAINING TIME PERIOD OF THIS WARRANTY.

THE MANUFACTURER WILL NOT BE RESPONSIBLE FOR:

1. Normal maintenance as outlined in the installation and servicing instructions or owner's manual, including filter cleaning and/or replacement and lubrication.
2. Damage or repairs required as a consequence of faulty installation, misapplication, abuse, improper servicing, unauthorized alteration or improper operation.
3. Failure to start due to voltage conditions, blown fuses, open circuit breakers or other damages due to the inadequacy or interruption of electrical service.
4. Damage as a result of floods, winds, fires, lightning, accidents, corrosive environments or other conditions beyond the control of the Manufacturer.
5. Parts not supplied or designated by the Manufacturer, or damages resulting from their use.
6. Manufacturer products installed outside the continental U.S.A., Alaska, Hawaii, and Canada.
7. Electricity or fuel costs or increases in electricity or fuel costs for any reason whatsoever including additional or unusual use of supplemental electric heat.
8. ANY SPECIAL INDIRECT OR CONSEQUENTIAL PROPERTY OR COMMERCIAL DAMAGE OF ANY NATURE WHATSOEVER. Some states do not allow the exclusion of incidental or consequential damages, so the above may not apply to you.

This warranty gives you specific legal rights and you may also have other rights which may vary from state to state.



# Programming Worksheet

see Section 6

DAY	PERIOD	START TIME	COOL	HEAT	
M O N D A Y	Unoccupied				
	Occupied 1				
	Occupied 2				
	Occupied 3				
T U E S D A Y	Unoccupied				<i>Copy Mon → Tue</i>
	Occupied 1				<input type="checkbox"/> No
	Occupied 2				<input type="checkbox"/> Yes
	Occupied 3				
W E D N E S D A Y	Unoccupied				<i>Copy Tue → Wed</i>
	Occupied 1				<input type="checkbox"/> No
	Occupied 2				<input type="checkbox"/> Yes
	Occupied 3				
T H U R S D A Y	Unoccupied				<i>Copy Wed → Thu</i>
	Occupied 1				<input type="checkbox"/> No
	Occupied 2				<input type="checkbox"/> Yes
	Occupied 3				
F R I D A Y	Unoccupied				<i>Copy Thu → Fri</i>
	Occupied 1				<input type="checkbox"/> No
	Occupied 2				<input type="checkbox"/> Yes
	Occupied 3				
S A T U R D A Y	Unoccupied				<i>Copy Fri → Sat</i>
	Occupied 1				<input type="checkbox"/> No
	Occupied 2				<input type="checkbox"/> Yes
	Occupied 3				
S U N D A Y	Unoccupied				<i>Copy Sat → Sun</i>
	Occupied 1				<input type="checkbox"/> No
	Occupied 2				<input type="checkbox"/> Yes
	Occupied 3				



Printed on recycled paper.  
P/N 88-603 Rev. 1