

# USER'S MANUAL

Wireless Multi-Alert Receiver (Receiver)  
&  
Wireless Outdoor Motion Detector (Sensor)

Model No.: MA-K100 (Receiver)  
DWS-K200 (Sensor)

## A. Your Wireless Multi-Alert Receiver

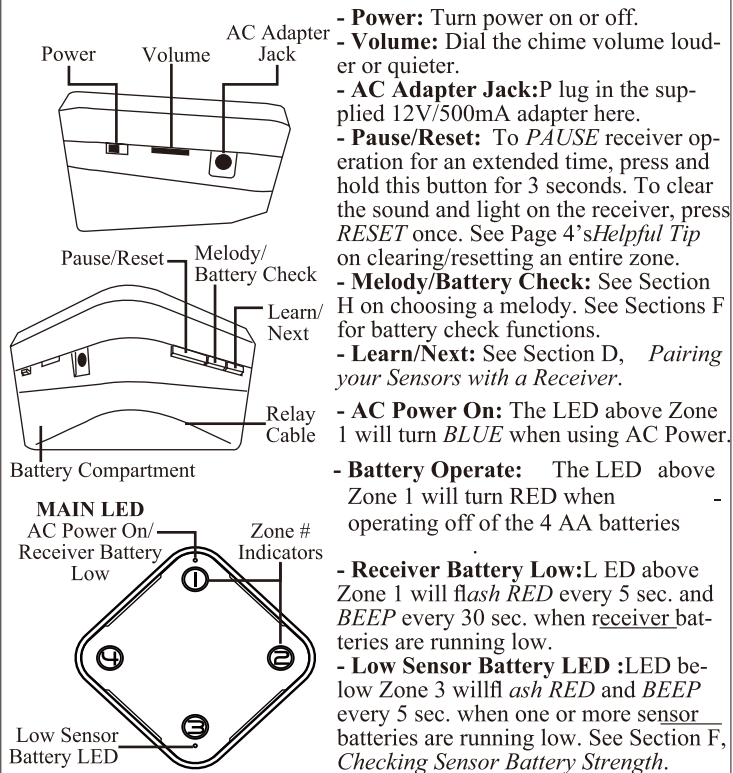

## B. AC Adapter Information

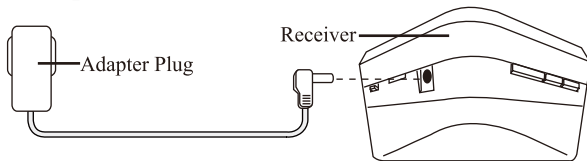

The main power source of the receiver unit is  
**12V/500mA AC/DC adapter.**

## C. Powering Your Sensor

The sensor runs on four (4) AA batteries  
lessly at a maximum distance of 1000m from the receiver.

*(not included) and*

1. Unscrew the four cover screws and remove the cover.  
Install four (4) AA batteries as indicated.

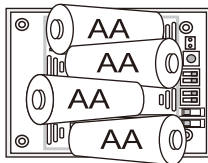

2. Replace the cover  
and secure the four  
screws.

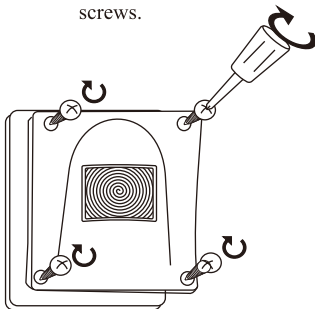

3. Attach the sun  
blocker. *(optional)*

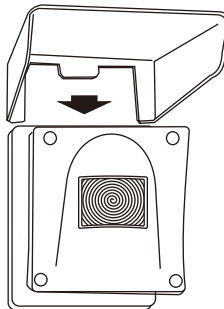

## D. Pairing your Sensors with a Receiver

Your sensor(s) need to be paired with a receiver before your system will properly function. Follow these steps to pair sensor(s) with a receiver unit.

the receiver for 3 seconds to enter Learn Mode. The Zone 1 indicator will light.

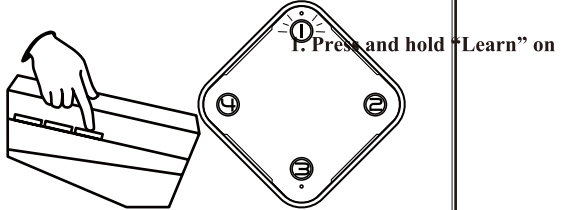

2. Press "Next" to light the zone indicator you wish to pair your sensor with. (If pairing Zone 1, skip this step.) Each zone's indicator will light when selected. Each zone can be paired with up to four (4) sensors. *NOTE: If all spaces are occupied, all zone LEDs will flash THREE TIMES.*

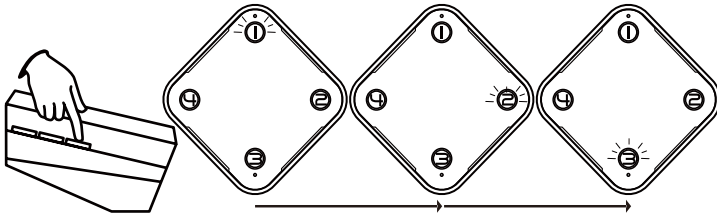

3. Press "Melody" to choose the melody you wish to play when the sensor is triggered. There are a total of 32 melodies to choose from.

*Melody select sequence: Melody 1*

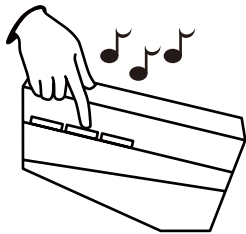

4. To complete the process, activate the sensor you wish to pair by slowly walking past or waving your hand at least one foot from the eye. The sensor eye will light when activated. The receiver will BEEP when successfully paired. To exit Learn Mode, press "Next" until all zone indicators turn off.

*NOTE: If the sensor has already been paired there will be NO SOUND. The indicator of the already paired zone will flash, then the indicator of the new zone chosen in Step 2 will relight. You need to select a different zone to complete the pairing process.*

→ Melody

## E. Installing Receiver Batteries

The receiver is designed to operate using the AC adapter.

**highly recommended that four (4) AAA batteries (not included) be installed for back-up purposes** during unexpected power outages or other circumstances where AC power may be temporarily unavailable.

If you choose to run the receiver off battery power **ONLY**, external relays will not function. (See Section I for relay set up, details, and usages.)

*NOTE: The receiver is equipped with a “Battery Low” alert. The alert will turn off when the receiver batteries are replaced.*

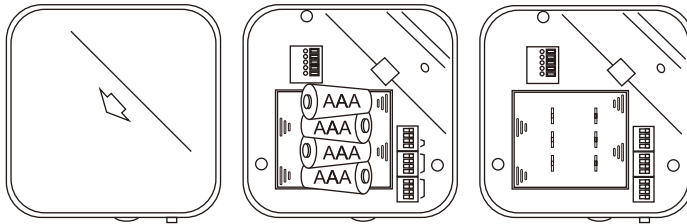

1. Slide panel to open battery compartment.

2. Install four (4) AAA batteries as indicated.  
(not included)

3. Adjust dip switches if needed (see Section G). Replace cover.



### **Helpful Tip! Clearing All the Sensors in a Zone**

If you completely relocate your sensors (for example, if you were to move to a new home and reinstall your alarm system in a different arrangement), **follow these steps to clear sensors from a zone so you can then re-pair the sensors in a new arrangement.**

1. Press and hold “Learn” for 3 seconds to enter Learn Mode.
2. Press “Next” to select which zone you wish to unpair. (If clearing Zone 1, skip this step.)
3. Press and hold “Pause/Reset” for 3 seconds to unpair all the sensors in that zone. The receiver will BEEP when the zone has been unpaired.
4. Press “Next” until all indicators are off to exit Learn Mode.

## F. Checking Sensor Battery Strength

All sensor batteries should be checked frequently to prevent malfunction of the alarm system. Check the sensor batteries by using the receiver's "Battery Check" button and following the instructions below.

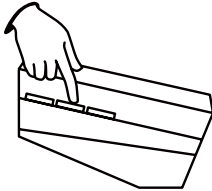

1. Press and hold "Battery Check" for 3 seconds to enter Check Mode. The MAIN LED will light.

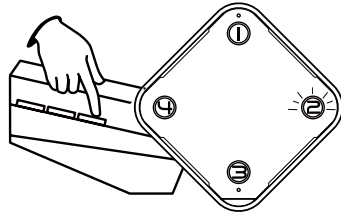

2. Press "Next" to select the zone you want to check.

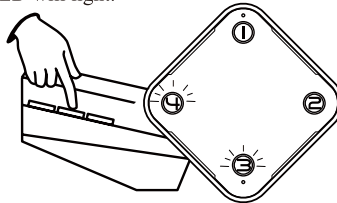

3. Press and hold "Battery Check". The lit LEDs correspond to the sensor(s) in the zone which have batteries that may need replacing.
4. Release button. Repeat Steps 2 & 3 to check remaining zones.



### Helpful Tip! Multiple Receiver Conflicts

**If you are experiencing interference, or you have multiple receivers and/or over 16 sensors, and they utilize the same signal code, you will need to manually change the code in one or more of your sensor units. To do this:**

REMOVE the battery. PRESS and HOLD the button inside the sensor battery compartment before INSERT the battery again. When the LED flash five times, a new signal code has been generated.

*NOTE: The recoded sensor(s) will need to be re-paired with a receiver. See Section D for instructions.*

Hold Test Button for 5 seconds.

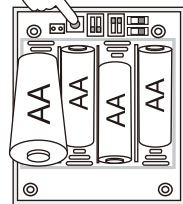

## G. Installing your Sensor

It is recommended that the motion sensor be mounted at least 3 feet (0.9m) from the ground on a sturdy, *non-metal* surface (i.e. a wall or stiff post) with the “eye” pointed toward and slightly down at the target sensing area.

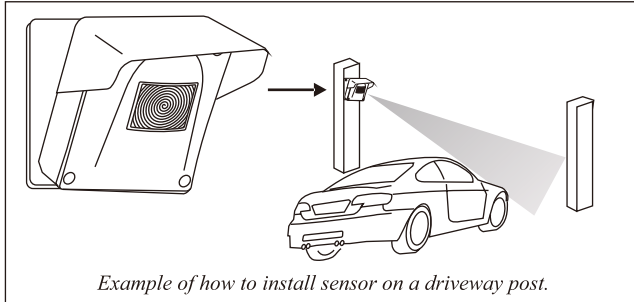

*Example of how to install sensor on a driveway post.*

### To install your sensor(s), follow the instructions below.

need for installation:

- a pencil
- a Phillips screwdriver
- electric drill & 0.31inch (7mm) electric drill bit (*recommended*)

1. Mark the mounting surface with a pencil using the four mounting holes on the sensor mount as a guide.

2. *Recommended:* Use an electric drill with a 0.31 inch (7mm) drill bit to create 1 inch (25mm) deep priming holes prior to fitting the screws. This will help prevent stripping of the screws.

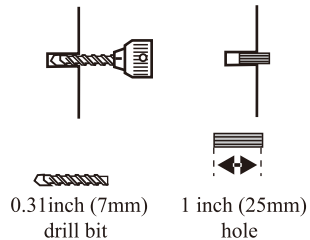
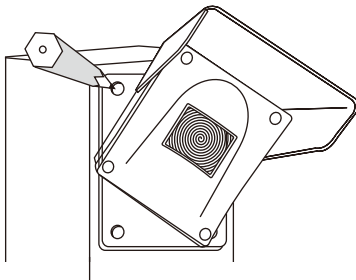

3. Using a Phillips screwdriver, attach the sensor mount to the mounting surface using the provided screws.

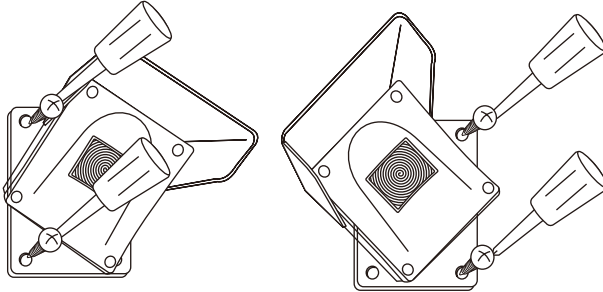

4. Adjust the sensor eye to focus on the area you are monitoring by gently swiveling it on its base.

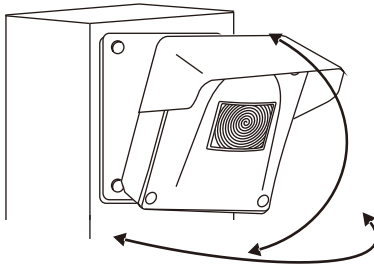

**Congratulations!**

Your Guardline Driveway Alarm System is now ready to serve you!



## H. Advanced Settings: Sensor Adjustments

Several switches are inside the battery compartment which regulate various sensor functions. Follow this guide to adjust your unit to the desired setting(s).

**NOTE: Your unit is already set by the manufacturer to the most commonly used settings. Only make adjustments to these settings if the unit does not work as desired under the factory settings.**

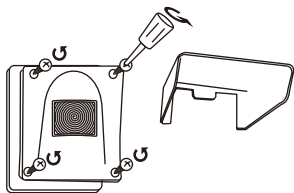

1. Remove the sun shade and the four screws holding the sensor cover in place.

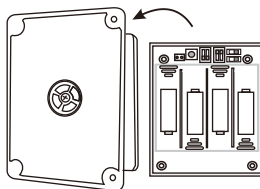

2. Inside the sensor unit is a battery compartment and rows of switches which control the sensor settings.

3. Use the guide below to set the sensor according to your preferences using a pen or other hard, narrow object to move the *black* switch.

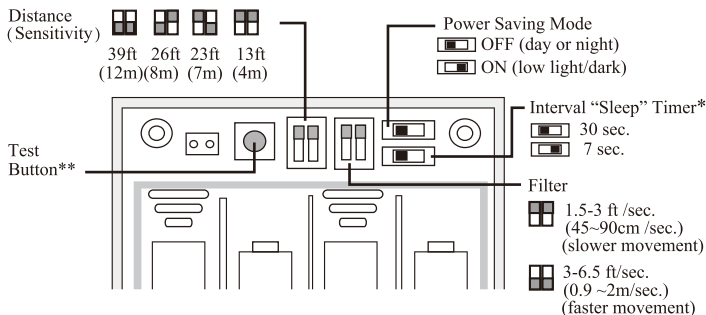

\*After detecting motion, the sensor can "sleep" for either 7 or 30 seconds, allowing an object to pass through the field of vision before setting the alarm off again.

\*\*The Test Button can be pressed during set up to test that the sensor has been correctly paired with its receiver. The Test Button is also used to recode the sensor in cases where more than one receiver is being used (see *Helpful Tip* on Page 5).

## I. Advanced Settings: Receiver Switches & External Devices

**NOTE: Your unit has been set by the manufacturer to the most commonly used settings. It is strongly suggested that the system be used first under its factory settings before adjusting the dip switches. If you are connecting an external device to the receiver, consult with the external device's user manual for installation details and parameters.**

The receiver battery cover must be removed in order to access the dip switches and output terminals (see Section E). Use a pen or other hard, narrow object to move the switches to your preferred setting.

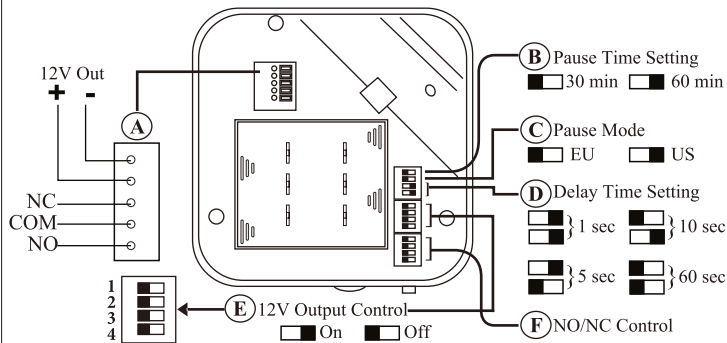

### A. Output Terminal:

External devices, such as gate openers, door releases, or external speakers, can be wired to the receiver using the 12V out relay.

- **12V Out:** This terminal outputs 12V/300mA when the selected zone has been triggered in cooperation with "E" (12V Output Control). *This function is disabled when running on batteries.* Select which zone relays to this output by sliding ONE of the dip switches for zones 1, 2, 3, or 4 to the "On" position.
- **NO (Normal Open)** outputs to a closed circuit when the selected zone has been triggered.
- **COM:** Neutral/Grounding terminal.
- **NC (Normal Closed):** Outputs to an open circuit when the selected zone has been triggered.
- The NO and NC outputs cooperate with "F" (NO/NC Control). You can select which zone relays to these outputs by sliding ONE of the dip switches 1, 2, 3, or 4 to the "On" position.

**B. Pause Time Setting:** Halts receiver operation for an extended time of either 30 or 60 minutes. (See Section A for instructions on pausing.)

**C. Pause Mode:** In EU Mode, the receiver will automatically turn on after the pause has timed out. In US Mode, the receiver will BEEP when the pause time is over, but will NOT automatically turn on.

**D. Delay Time Setting:** Adjusts the chime's delay between alerts. *Example: If set at 10 seconds, there will be 10 seconds between the time the sensor is triggered and when the chime sounds.*

**E. 12V Output Control:** Assigns a zone to the 12V Output terminal ("A") for externally wired devices. See A, Output Terminal, on Page 9 for details.

**F. NO/NC Control:** Selects which zone will connect with the NO/NC terminals.

## J. Manufacturer Default Settings

Listed below are the factory settings for your driveway alarm system.

*NOTE: Your system has been preset by the manufacturer to the most commonly used settings. It is recommended that users test the unit(s) under the default settings before making adjustments. If you have questions about these settings, please contact Customer Service.*

Receiver		Sensor	
Pause Time	30 minutes	Interval "Sleep" Timer	7 seconds
Pause Mode	EU	Power Saving Mode	OFF
Delay Time	1 second	Filter	3-6.5 ft (0.9~2m )/sec
12V Outputs	all OFF	Distance Sensitivity	39 ft (12m)
NO/NC Control	all OFF		



## Why Change Settings?

Though your Guardline Driveway Alarm System is factory set to suit the most common user, sometimes your needs may require more complicated settings. For instance, you may need to turn On the Power Saving Mode to enable motion detection if your sensing area is dark or dimly lit, or if your sensing area is only a sidewalk-width away and not across the road, you may want to change Distance Sensitivity to just 13 feet (4m).

## **FCC Statement:**

This equipment has been tested and found to comply with the limits for a Class B digital device, pursuant to part 15 of the FCC Rules. These limits are designed to provide reasonable protection against harmful interference in a residential installation. This equipment generates, uses and can radiate radio frequency energy and, if not installed and used in accordance with the instructions, may cause harmful interference to radio communications.

However, there is no guarantee that interference will not occur in a particular installation. If this equipment does cause harmful interference to radio or television reception, which can be determined by turning the equipment off and on, the user is encouraged to try to correct the interference by one or more of the following measures:

- \* Reorient or relocate the receiving antenna.
- \* Increase the separation between the equipment and receiver.
- \* Connect the equipment to an outlet on a circuit different from that to which the receiver is connected.

This device complies with part 15 of the FCC rules. Operation is subject to the following two conditions: (1) This device may not cause harmful interference, and (2) this device must accept any interference received, including interference that may cause undesired operation.

**Note: Changes or Modifications not expressly approved by the party responsible could void the user's authority to operate this device**

**The sensor must be fixed mounted and the associated receiver must be used/placed in mobile operating conditions.**