

USER MANUAL

HAX-700

Parts and Function

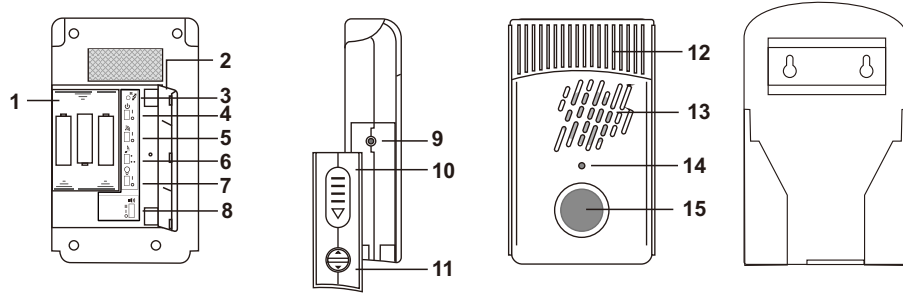

- | | | |
|---------------------------------|-------------------------|---------------------|
| 1. Batteries compartment | 7. Light on/off switch. | 12 Flasher |
| 2. Battery Door | 8. Volume control. | 13. Speaker |
| 3. Regenerates new code button. | 9. Sensor input jack | 14 LED indicator. |
| 5. Transmitter On/off switch. | 10. Anti-take off Cover | 15. Magnetic holder |
| 6. Alert sound selector. | 11 Cover lock | |

Power

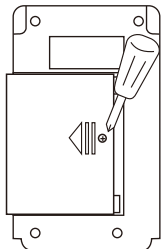

Remove the screw and slide to open the battery cover

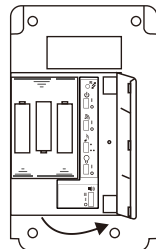

Flip to open the cover

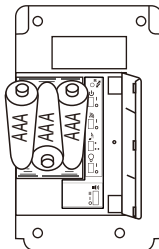

Insert 3 AAA batteries to the battery compartment and close the battery cover

Installation

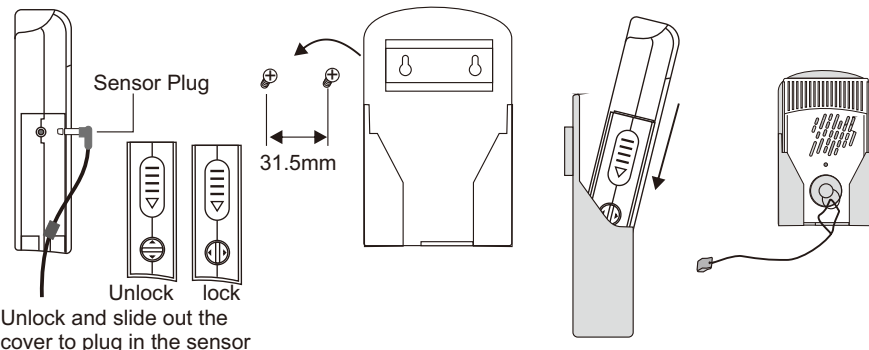

Unlock and slide out the cover to plug in the sensor

Setting

Slide the switches inside the battery cover for your needs.

- Power** Switch to off position when do not use this device.
- Transmitter On/Off switch** On : Send a trigger signal to receiver when triggered
Off : Do not send signal to receiver when triggered.
- Sound selector** Select the suitable sound by slide this switch to or position
- Light On/Off** Turn the flash light on or off by slide this switch.
- Volume control** You can select High / Low / No sound by slide this switch.
- Regenerate a new code** If the RF code is conflict, press the button in the pin hole to regenerate a new code

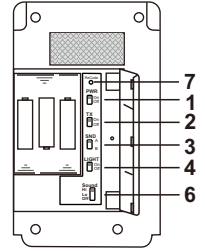

Pairing with receiver

This unit can work stand alone or work with the wireless receiver. If work with the receiver, you need to pairing with the receiver follow to the manual of the receiver.

Operation

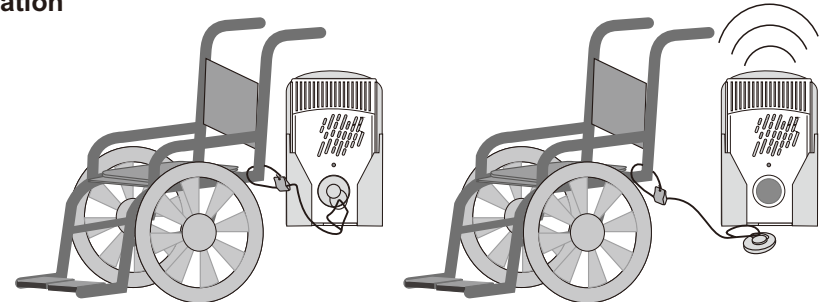

Using the rope attach to the object that you do not want other people move it

Once the magnetic is out of position, the alarm will activated

FCC Statement:

This equipment has been tested and found to comply with the limits for a Class B digital device, pursuant to part 15 of the FCC Rules. These limits are designed to provide reasonable protection against harmful interference in a residential installation. This equipment generates, uses and can radiate radio frequency energy and, if not installed and used in accordance with the instructions, may cause harmful interference to radio communications. However, there is no guarantee that interference will not occur in a particular installation. If this equipment does cause harmful interference to radio or television reception, which can be determined by turning the equipment off and on, the user is encouraged to try to correct the interference by one or more of the following measures:

- Reorient or relocate the receiving antenna.
- Increase the separation between the equipment and receiver.
- Connect the equipment to an outlet on a circuit different from that to which the receiver is connected.

This device complies with part 15 of the FCC rules. Operation is subject to the following two conditions: (1) This device may not cause harmful interference, and (2) this device must accept any interference received, including interference that may cause undesired operation.

Note: Modifications to this product will void the user's authority to operate this equipment.