

USER MANUAL

Multi-Alert System With Dual Alarm Clock

MA-3000k

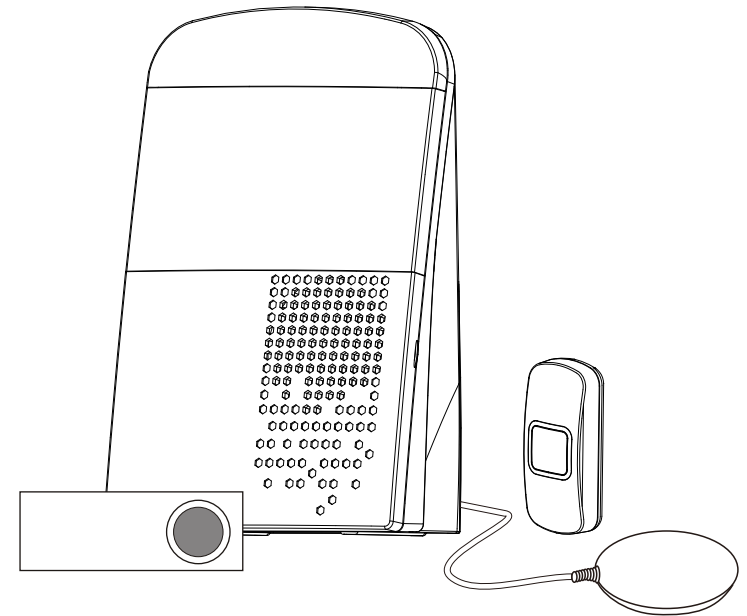

RECEIVER Parts and Function

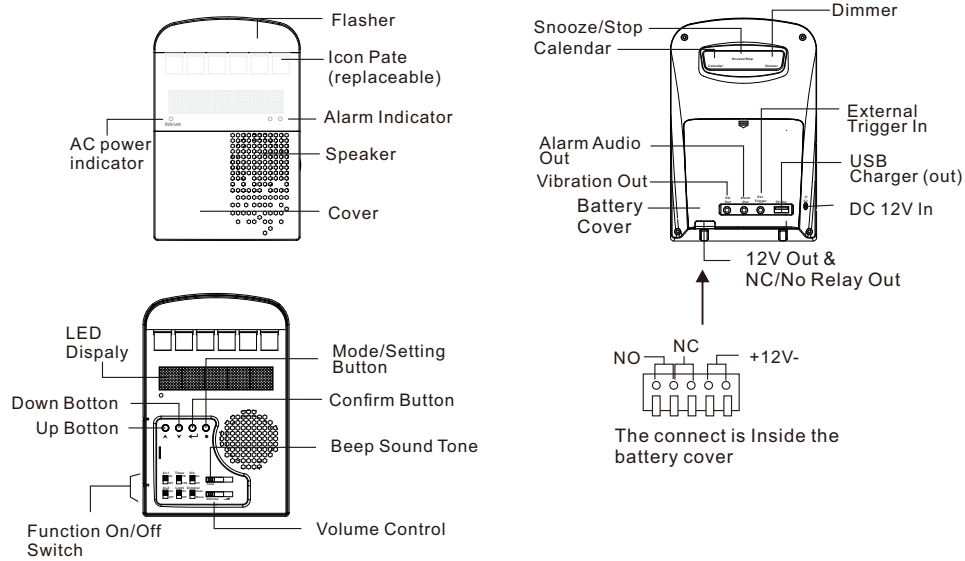

Power

The receiver powered by a 12V 1.2A AC/DC adaptor and backup by 3 pieces 'C' size batteries. Install the backup batteries avoid lost alert information when ac power fail. The AC power indicator will lit when the ac power is good.

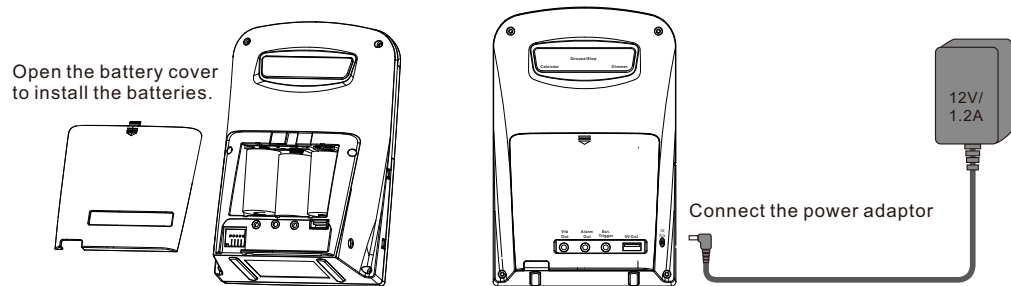

** The display time will blink, when the AC power and the backup batteries are lost before. Press the reset button to stop blinking. (The clock will run with the internal CR2032 battery. Power loss will not affect clock accuracy)

** If ac power is fail, the USB charger, Vibration pad, and 12V output will not work.

Battery Low

Receiver unit:

When the backup batteries are low voltage, the low battery information "BattLo" will show on the display for 1 second every 15 seconds. Replace the batteries as soon as possible.

Sensor unit

When the battery of the sensor/Bell pusher is low voltage. It will send a battery low information with the trigger signal to the receiver. The receiver will blink the zone icon to indicate this sensor battery is low voltage. Replace the battery as soon as possible.

Setting

Please ensures the sound volume is not on the min position before setting.

SET Calendar (Set Cal)

- Press Mode ● button once, The display show **Set Cal**.
- Press confirm ← button to set calendar year. Press Up ▲ / Down ▼ button adjust the year, the year "up to 2099
- Press confirm ← button to set calendar month. Press Up ▲ / Down ▼ button adjust the month. Press confirm ← button to set calendar date.
- Press confirm ← button to finishing and exit the calendar setting.

SET Clock (Set Ck)

The time display will blinking when install batteries and connect to ac power. Please adjust the clock to keep the time is correct.

- Press Mode ● button twice, The display show **Set Ck**.
 - Press confirm ← button to set time format 12 /24 hour. Press Up ▲ / Down ▼ button select the 12 or 24 hour format.
 - Press confirm ← button jump to set minute. Press Up ▲ / Down ▼ button adjust the minute. Press confirm ← button to set hour. Press Up / Down button adjust the hour.
 - Press confirm ← button to finishing and exit the time setting mode.
- *** Each time you press the confirm button, the time second will reset to zero. (The clock will run from zero second after you set the clock.)

SET Alarm Time (Set A1 or A2)

- Press Mode ● button three or four time, The display show **Set A1 or A2**.
 - Press confirm ← button to set alarm minute. Press Up ▲ / Down ▼ button to adjust the alarm minute.
 - Press confirm ← button to set alarm hour. Press Up ▲ / Down ▼ button to adjust the alarm hour.
 - Press confirm ← button to set alarm melody. Press Up ▲ / Down ▼ button to select the alarm melody.
 - Press confirm ← button to set vibration on or off. Press Up ▲ to turn on the vibrator. Press down ▼ to turn off vibrator.
 - Press confirm ← button to set 12V output on or off. Press Up ▲ to turn on the 12V output. Press down ▼ to turn off vibrator the 12V output.
 - Press confirm ← button to set relay output on or off. Press Up ▲ to turn on the relay output. Press down ▼ to turn off vibrator the relay output.
 - Press confirm ← button to finishing and exit the time setting mode.
- Please do not forget turn the alarm switch inside the front cover.

Matching (Pair)

- Press Mode ● button five time, The display show **Pair**
- Press confirm ← button to entering to pair mode. the display show Zone: -1 or Zone:1
Zone 1 = Zone 1 is empty; Zone: 1 = Zone 1 is already paired with the sensor, and if it continues, the new sensor will replace the old one.
- Press up ▲ or down ▼ button to select the zone you want to pair.
- Trigger the transmitter/sensor you want to pair. The display will show linked when the pair is success. then the receiver show the sensor name, Press confirm ← button to confirm or press up ▲ /down ▼ button to select an other sensor name.

If it do not show "linked" information, it show other zone number when trigger the sensor. This sensor is already paired in other zone.

- Then display will show the melody ♪. Press confirm ← button to confirm the default melody or press up ▲ / down ▼ button to select an other melody. (each type of sensor have a default melody)
The melody number from 00 to 32, The #32 is a beep tone, you can adjust the tone lever to change the pitch of the sound.
- *** Select 'None' to mute this sensor

SENSOR NAME	Default	Option	Option
Door Bell	Bell	D. Bell	Knock
Door/window Sensor	Window	Door	Invaide
Mailbox Sensor	Mail	M. Box	Letter
Fall sensor	Fall Al	Pad	Help
Flood detector	Flood	Empty	Full
Toilet pull sensor	Toilet	Help	Slip
Magnet sensor	Magnet	Steal	Lost
Entry mat	Mat	Escape	Enter
PIR/Driveway sensor	PIR	Road	Invaide
Sound sensor	Baby	Cry	Sound
Telephone ring transmitter	Phone	Ring	Call
Garage door	Garage	Open	G.Door
Gas detector	Gas	Danger	Alarm
T3	Smoke	Danger	Fire
T4	CO	Danger	Fire

SENSOR NAME	Default Sound#	SENSOR NAME	Default Sound#	SENSOR NAME	Default Sound#	SENSOR NAME	Default Sound#
Door Bell	1	Flood detector	14	PIR/Driveway sensor	13	Gas detector	10
Door/window Sensor	28	Toilet pull sensor	27	Sound sensor	31	T3	13
Mailbox Sensor	12	Magnet sensor	17	Phone Ring	19	T4	13
Fall sensor	29	Entry mat	15	Garage door	6		

- Press confirm \leftarrow button to set vibration on or off. Press Up to turn on the vibrator. Press down to turn off vibrator.
- Press confirm \leftarrow button to set 12V output on or off. Press Up to turn on the 12V output. Press down to turn off vibrator the 12V output.
- Press confirm \leftarrow button to set relay output on or off. Press Up to turn on the relay output. Press down to turn off vibrator the relay output.
- Press confirm \leftarrow button to finishing and goto next zone pairing.

Replace the icon plate

After pairing the sensor/bell pusher, do not forget change the sensor indication icon come with the sensor. Please keep the original icon plate for unpair the zone.

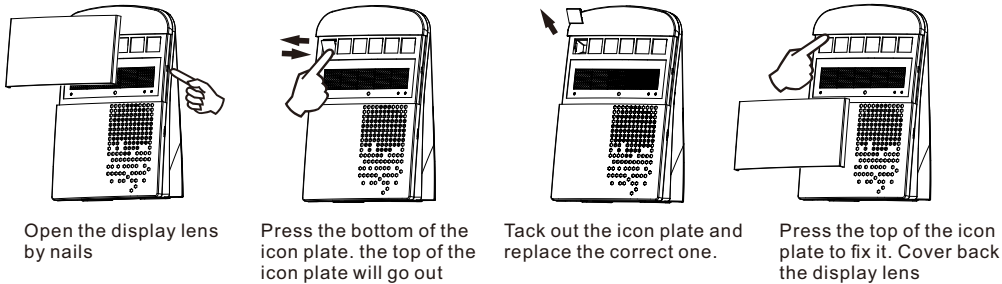

To remove the sensor from the receiver memory (unpair).

- Press Mode button five time, The display show Pair
- Press confirm \leftarrow button to entering to pair mode. the display show Zone -1 or Zone:1
- Press up or down button to select the zone you want to unpair.
- Press and hold the up and down buttons for approx. 3 seconds. The receiver will return a beep tone to confirm this zone is clear. The display will change to show 'zone -x'. ('X' is zone number, '-' is indicating this zone is empty.)

When the zone is paired with sensor the display will show ":" between the "zone" and zone number. eg. zone: 1.
When the zone is empty, the display will show "-" between the "zone" and zone number. eg. zone- 1.

Other Setting

Alarm 1 On/Off (clock alarm 1)

Slide the AL1 switch to on or off position. When Alarm 1 is on the alarm1 indicator will light up

Alarm 2 On/Off (clock alarm 2)

Slide the AL2 switch to on or off position. When Alarm 2 is on the alarm2 indicator will light up.

Timer

Slide the timer switch to select the duration of the relay output and 12V output .

Light On/Off

Slide the master light switch to on or off flasher light.

Vibrator On/Off

Slide the Vib master switch to turn on or off vibrator. This is a master switch.

Dimmer Mode

Auto: The LED display dims automatically in the dark .

Manual: Adjust the LED display brightness by pressing the dimmer button.

Tone Adjust

Slide the tone lever to adjust the tone of the beep sound alert (Sound number 32).

Volume Control

Slide the volume to adjust master sound volume.

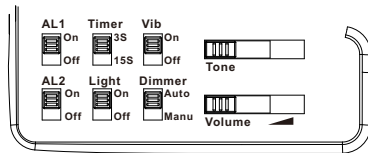

Show Calendar

Press the calendar button once, the display will show the calendar for 10 seconds.

Dimmer

Press the dimmer button to select the brightness of the display

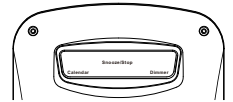

Outlet and inlet

DC Jack : Main power 12V 1A input.

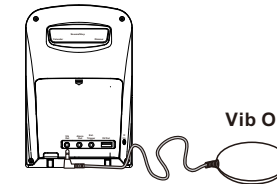
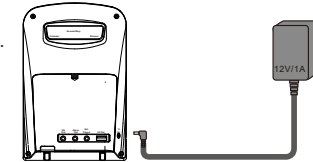

Vib Out: Vibrator connect to this outlet. It provide 12V output to drive the vibrator.

5V output: This is a standard USB socket. It provide DC5V / 1A to charge the mobile device. The charge current depend on the max current of power adaptor and the mobile device .(max. output current is 1A)

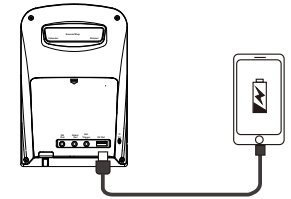

Alarm Out: This is a audio signal output. It con connect to the external amplifier or other alarm system.

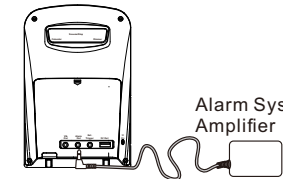

Alarm System or Amplifier

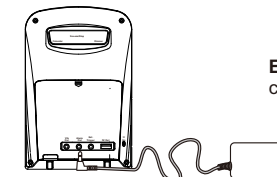

Bluetooth receiver

Ext. Trigger: This is a external trigger input. you can apply a 3-12V DC to trigger this input.

This receive provide some output terminal for special application.

Normal Open(NO) terminal:

This 2 terminal pin is open circuit normally, It will close circuit when the receiver be triggered. The duration is depend on the timer switch setting.

Normal Close (NC) terminal:

This 2 terminal pin is close circuit normally, It will open circuit when the receiver be triggered. The duration is depend on the timer switch setting.

Normally open and normally closed can only choose one connection. (The rating do not exceed 48V/500mA)

12V out terminal:

This 2 terminal pin can provide 12v output to drive some device when the receiver be triggered. The duration is depend on the timer switch setting. The device current do not exceed 200mA.

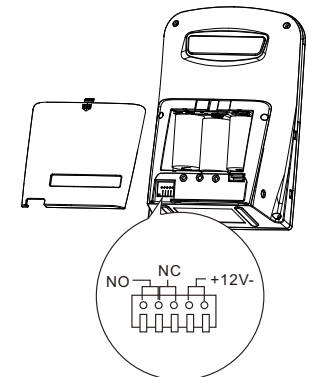

FCC Statement:

This equipment has been tested and found to comply with the limits for a Class B digital device, pursuant to part 15 of the FCC Rules. These limits are designed to provide reasonable protection against harmful interference in a residential installation. This equipment generates, uses and can radiate radio frequency energy and, if not installed and used in accordance with the instructions, may cause harmful interference to radio communications.

However, there is no guarantee that interference will not occur in a particular installation. If this equipment does cause harmful interference to radio or television reception, which can be determined by turning the equipment off and on, the user is encouraged to try to correct the interference by one or more of the following measures:

- * Reorient or relocate the receiving antenna.
- * Increase the separation between the equipment and receiver.
- * Connect the equipment to an outlet on a circuit different from that to which the receiver is connected.

This device complies with part 15 of the FCC rules. Operation is subject to the following two conditions: (1) This device may not cause harmful interference, and (2) this device must accept any interference received, including interference that may cause undesired operation.

Note: Modifications to this product will void the user's authority to operate this equipment.

