



**NURIT 8000**

**Wireless Palmtop  
Solution**

***Installation Manual***

**Copyright Notice**

Copyright© Lipman Electronic Engineering Ltd.  
All rights reserved.

The content of this publication is for informational purposes only and is subject to change without notice. It does not represent a commitment on the part of Lipman Electronic Engineering Ltd.

No part of this publication may be reproduced, transmitted, transcribed, stored in a retrieval system, or translated to any language in any form by any means without the prior written permission of Lipman.

**Trademark Information**

NURIT® is a registered trademark of Lipman Electronic Engineering Ltd. All other product and brand names contained in this manual are trademarks of their respective owners.

**Catalog Number**

DOC00222 ORIG.

**Print Date**

May 2004



## Foreword

Thank you for purchasing the NURIT 8000 Wireless Palmtop Solution. You now own one of the most advanced electronic point-of-sale (POS) terminals manufactured today.

This manual provides basic installation instructions. To fully utilize the features of your NURIT 8000, and for general safety purposes, it is recommended that you familiarize yourself with this manual, the terminal and any peripheral equipment or accessories.



Figure 1 NURIT 8000 - General View



**NURIT 8000**

### **Note**

All graphic images in this manual are for illustrative purposes only. Different models of this terminal may exist and may vary in appearance according to country of use or particular customer requirements.

The basic installation procedure is the same for most units. The operation of the terminal is application-dependent.

It is recommended that you store this manual in a safe place for future reference.

## **Document Conventions**

**Warning** - Failure to follow specific procedures and practices may result in personal injury

**Caution** - Failure to follow specific procedures and practices may result in damage to the NURIT device or other equipment

**Note** - Helpful hints and other important information about the use of the NURIT device



## Table of Contents

Copyright Notice .....	ii
Trademark Information .....	ii
Catalog Number .....	ii
Print Date.....	ii
Foreword.....	iii
Document Conventions .....	iv
Product Regulatory Information .....	1
FCC Compliance Statement.....	1
FCC Part 15 Requirements .....	1
FCC Part 68 Requirements .....	2
FCC Part 24 Requirements .....	4
In Canada: .....	4
EU Directives Compliance Statement .....	4
General Safety Instructions.....	5
Radio Frequency Energy Emission .....	9
Safety Precautions for Medical Devices.....	10
Pacemakers .....	10
Other Medical Devices.....	10
Safety Precautions for Other Electronic Devices ..	11
Specifications .....	12
Initial Setup .....	13
Unpacking the Box .....	13
Contents Checklist .....	14
Selecting a Point-Of-Sale Location .....	17
Optional Accessories .....	19
General Features .....	23



- Installing the Battery Pack ..... 26
  - Battery Pack Maintenance ..... 28
- Connecting the NURIT 8000 to an AC Power Outlet . 30
- Installing the External Modem..... 32
- Connecting the Car Adapter ..... 33
- Loading Paper in the Printer ..... 35
- Installing the Keypad Privacy Shield ..... 37
- Installing a SIM or SAM Card ..... 39
  - Installing the SIM/SAM Cardholder Compartment Cover.. 43
  - Installing a SIM Card in the TEL SIM Slot ..... 45
- Connecting Peripheral Devices..... 47
- Connecting a Cellular Headset ..... 49
- General Care and Maintenance ..... 50
  - Cleaning the NURIT 8000..... 50
  - Cleaning the Printer ..... 51
  - Maintenance Recommendations ..... 52
  - Technical Assistance ..... 52
  - Shipping the NURIT 8000 ..... 53
- Troubleshooting ..... 54
- Appendix A Using the Magnetic Card Reader..... 60
- Appendix B Using the Smart Card Reader ..... 61
- Installation Notes..... 63



## List of Figures

Figure 1	<b>NURIT 8000 - General View</b>	iii
Figure 2	<b>Secure Device Label</b>	13
Figure 3	<b>NURIT 8000 - Box Contents</b>	16
Figure 4	<b>NURIT 8000 - Optional Accessories</b>	19
Figure 5	<b>NURIT 8000 - Top View</b>	25
Figure 6	<b>NURIT 8000 - Bottom View</b>	25
Figure 7	<b>Battery Pack Installation</b>	26
Figure 8	<b>Battery Pack Removal</b>	27
Figure 9	<b>AC Power Connection</b>	30
Figure 10	<b>External Modem Installation</b>	32
Figure 11	<b>Car Adapter Connection</b>	33
Figure 12	<b>Loading Paper in the Printer</b>	36
Figure 13	<b>Keypad Privacy Shield Installation</b>	37
Figure 14	<b>SIM/SAM Cardholder Locking-Clasp</b>	41
Figure 15	<b>SIM/SAM Card Installation</b>	42
Figure 16	<b>SIM/SAM Cardholder Compartment Cover Installation</b>	44
Figure 17	<b>Void Label Installation</b>	44
Figure 18	<b>SIM Cardholder Ejection</b>	45
Figure 19	<b>SIM Card Installation</b>	46
Figure 20	<b>SIM Cardholder Insertion</b>	46
Figure 21	<b>Barcode Reader Connection</b>	48
Figure 22	<b>Cellular Headset Connection</b>	49
Figure 23	<b>Magnetic Card Reader</b>	60
Figure 24	<b>Smart Card Reader</b>	61







## Product Regulatory Information

### **Note**

The following product regulatory information and compliance statements apply to all models of the NURIT 8000 $x$ , where  $x$  represents a suffix, such as **S**, **SVP**, or **Secure**, designating the specific security features of a particular model.

### **Caution**

Changes or modifications to this device that are not expressly approved by the party responsible for compliance could void the user's authority to operate the equipment.

### FCC Compliance Statement



Manufacturer: Lipman Electronic Engineering Ltd.

Model: NURIT 8000

### FCC Part 15 Requirements

This equipment has been tested and found to comply with the limits for Class B digital device, pursuant to Part 15 of the FCC Rules. These limits are designed to provide reasonable protection against harmful interference when the equipment is installed and operated in a commercial environment.



**NURIT 8000**

This equipment generates, uses and can radiate radio frequency energy and, if not installed and used in accordance with the instructions, may cause harmful interference to radio communications. However, there is no guarantee that interference will not occur in a particular installation.

Operation of this equipment in a residential area is likely to cause harmful interference in which case the user will be required to correct the interference at his/her own expense.

If this equipment does cause harmful interference to radio or television reception, which can be determined by turning the equipment off and on, the user is encouraged to try to correct the interference by one or more of the following measures:

- Reorient or relocate the receiving antenna.
- Increase the separation between the equipment and the receiver.
- Connect the equipment into an outlet on a circuit different from that to which the receiver is connected.
- Consult your dealer or an experienced technician for help.

Connection of peripherals to this unit requires the use of grounded, shielded cables to ensure compliance with the class B limits.

#### **FCC Part 68 Requirements**

[Applicable when using optional NURIT 8000 docking station or NURIT 8000 external modem]

The FCC has established rules permitting this device to be directly connected to the telephone network. Standardized FCC Part 68 compliant telephone line cords and modular jacks are used for these connections. This equipment should not be used on party or coin lines.



If this device is malfunctioning, it may be causing harm to the telephone network; this device should be disconnected until the source of the problem can be determined and until repair has been made. If this is not done, the telephone company may temporarily disconnect service.

The telephone company may make changes in its technical operations and procedures; if such changes affect the compatibility or use of this device, the telephone company is required to give adequate notice of the changes. You will be advised to file a complaint with the FCC.

If the telephone company requests information on what equipment is connected to their lines, inform them of:

- The telephone number to which this unit is connected
- The AC Ringer Equivalence Number: 00B
- The USOC jack required: RJ-11C
- The FCC Registration number: (See the underside of the unit and/or applicable unit documentation for this number.)

The Ringer Equivalence Number (REN) is used to determine how many devices can be connected to your telephone line. In most areas, the sum of the RENs of all devices on any one line should not exceed five (5). If too many devices are attached, they may not ring properly. To be certain of the number of devices that may be connected to the line, as determined by the total RENs, contact the telephone company to determine the maximum REN for the calling area.



**NURIT 8000**

### **FCC Part 24 Requirements**

This device may contain a radio transceiver module, (FCC ID number is located on the bottom of the terminal), operating under Part 24 of the FCC rules in a licensed part of the radio spectrum. Qualified personnel must perform service or repairs to the radio portion of this device. Any unauthorized modification to the radio module, shielding, or antenna system may void the user's authority to operate this device.

This device has been tested and meets RF exposure guidelines for hand held operation pursuant to FCC OET Bulletin 65 Supplement C ed. 01-01, IEEE 1528/D1.2 (2003) and Industry Canada RSS-102 (1999).

### **In Canada:**

This digital apparatus does not exceed the class B limits for radio noise emissions from digital apparatuses set forth in the Radio Interference Regulations of the Canadian Department of Communications.

Cet appareil numérique n'émet pas de bruits radioélectriques dépassant les limites applicables aux appareils de la classe B, déterminée par la Réglementation d'Interférence Radio du Ministère canadien des Communications.

### **EU Directives Compliance Statement**



This product complies with the requirements of applicable EU Council Directives.

### **Caution**

Any unauthorized modification of the equipment may void the user's authority to operate this device.



## General Safety Instructions

### **Warning**

Failure to observe these instructions may result in severe personal injury or damage to the NURIT 8000 or other equipment.

### **Note**

These safety instructions are based in general on those provided by Underwriters Laboratories (UL) Inc. U.S.A.

When using the NURIT 8000 or any associated device, the following basic safety precautions should always be observed to reduce the risk of fire, electric shock, or personal injury:

- Read and make sure you understand all instructions.
- Follow all warnings and instructions marked on the device and in this manual.
- Disconnect the device from the power supply and any peripherals before cleaning.
- Do not use liquid or aerosol cleaners. Use a damp cloth for cleaning and/or a soft brush.
- Do not use the device near water, especially when using the AC/DC Power Adapter or external modem.
- Never spill any liquid on the device.



**NURIT 8000**

- Place the device in a stable position on a solid surface. When operated hand-held, grasp the device securely. Serious damage may result if the device falls.
- The optimal operational position for the terminal is hand-held at an angle of approximately 30°. The terminal is also designed for optimal tabletop usage. Keep the terminal a short distance from your body.
- Do not cover slots and openings of the device. They may be provided for ventilation and protection against overheating. Never place the device near radiators, or in a place where proper ventilation is not provided.
- Use only the power source as marked on the device. If you are not sure of the type of the power supplied to your location, consult your dealer or local power company.
- Do not place objects on the power cord. Install the device where no one can step on the cord.
- Do not overload wall outlets and extension cords as this can result in the risk of fire or electric shock.
- Never push objects into the device through slots (other than those specifically intended for the stylus, magnetic stripe or smart cards, or SAM/SIM cards), as this may result in fire or electric shock.



- To reduce the risk of electric shock, do not disassemble any of the equipment or accessories referred to in this manual. If required, take the equipment to a qualified service representative. Opening or removing covers may expose you to dangerous voltages or other risks. Incorrect reassembly can cause electric shock.
- Disconnect the device from the power supply and any peripherals and refer to qualified service personnel under the following conditions:
  - The power supply cable or plug is damaged or frayed.
  - Liquid has been spilled into the device.
  - The device has been exposed to rain or water.
  - The device does not work normally, when following the operating instructions.
  - The device has been dropped or damaged.
  - The device exhibits a distinct change in performance.
- When using the NURIT 8000 optional docking station and/or external modem during thunderstorms, disconnect the telephone line, if possible. There may be a remote risk of electric shock from lightning.
- Never install telephone wiring during a lightning storm.



---

**NURIT 8000**

- Never install telephone jacks in wet locations unless the jack is specifically designed for wet locations.
- Never touch non-insulated telephone wires or equipment unless the telephone line has been disconnected at the network interface.
- Use caution when installing or modifying telephone lines.
- When in the vicinity of a gas leak, do not use the NURIT 8000, a standalone telephone or a telephone connected to a POS terminal or docking station to report the leak.
- Take care when installing an internal battery pack. If installed incorrectly, it may explode. Use only a Lipman supplied battery pack. Discard used battery packs according to local regulations.





## Radio Frequency Energy Emission

Your NURIT 8000 may contain a transmitter and receiver that emit radio frequency (RF) energy. The actual frequency range used by the NURIT 8000 is radio-modem dependent according to the specific model. Digital modulation techniques are used.

During radio communication, the local radio system handling the actual communication controls the actual power transmission output level. This output level may typically vary (relative to the distance between the user location and the cell transmission sites).

- When used properly, the design of this hand-held wireless terminal complies with U.S., Canadian, European and other standards for protection from public exposure to radio frequency (RF) magnetic signals.
- This device has been tested and meets RF exposure guidelines for hand held operation pursuant to FCC OET Bulletin 65 Supplement C ed. 01-01, IEEE 1528/D1.2 (2003) and Industry Canada RSS-102 (1999).

### **Warning**

The NURIT 8000 must be located at a minimum of 20 cm from all persons, and must not be co-located or operated in conjunction with any other antenna or transmitter.



## Safety Precautions for Medical Devices

For those persons using a pacemaker or other medical device, please read the following important safety notes:

- Though most electronic equipment and critical medical devices are shielded against radio-frequency signals, it is important to realize the possibilities of potential interference and to know the standard precautions that may be taken.

### Pacemakers

Industry standards recommend a minimum separation of 15 cm (6 inches) between a wireless phone-type device and a pacemaker to prevent any potential problems.

Individuals using a pacemaker should:

- Always keep the NURIT more than 15 cm (6 inches) from the pacemaker when using the unit for cellular wireless communication or when performing an online transaction.
- Turn off the NURIT immediately and disconnect it from the power supply if you suspect any problem of interference.

### Other Medical Devices

Consult the manufacturer of your medical device to determine its level of shielding. Depending on the proximity to certain equipment, you may be asked not to use your NURIT terminal or one of its accessories.



## Safety Precautions for Other Electronic Devices

- Do not use your NURIT 8000 in an area of potential explosive atmosphere, such as fuel or chemical storage or transfer facilities, or in any area where you would be advised to turn off a vehicle's engine.
- Do not replace the battery pack or charge the NURIT 8000 in an area of potential explosive atmosphere.
- Do not use the NURIT 8000 in a known blasting area.
- Do not place the NURIT 8000 in the area over a vehicle-equipped air bag.
- If the battery pack has been removed, ensure that no metal objects come in contact with its electrical contacts.
- You are using a NURIT 8000 designed for use with a built-in internal antenna. Do not open the device with the intent of tampering with the antenna system. Doing so may damage the unit and violate FCC (Ministry of Communications) regulations.
- Radio frequency energy may affect improperly installed or very sensitive systems. Consult the specific device manufacturer (or airline crew for possible airborne operation) regarding typical problems that may arise when using the device. At the time of the publication of this manual, it is known that use of all radio-type devices is prohibited while airborne.



**NURIT 8000**

## Specifications

Specification	Details
Power	<ul style="list-style-type: none"><li>Terminal: 8.4 VDC at 1.0 A</li><li>AC/DC Adapter (Safety Approved) Input: 100-240 VAC at 50/60 Hz (0.8 A) Output: 8.4 VDC at 1.0 A</li></ul>
Dimensions	<ul style="list-style-type: none"><li>Height: 82 mm (3.23 in)</li><li>Width: 108 mm (4.26 in)</li><li>Depth: 230 mm (9.06 in)</li></ul>
Paper Roll	<ul style="list-style-type: none"><li>57 mm x 38 mm (2.25 in x 1.5 in)</li><li>10.5 mm (0.4 in) core diameter</li></ul>
Weight	<ul style="list-style-type: none"><li>Terminal: 650 g (22.9 oz) Including privacy shield, battery pack and paper roll</li><li>Shipping: 800g (28.2 oz.) Not including this manual</li></ul>
Modem Communication Rate	<ul style="list-style-type: none"><li>56 Kbps (maximum)</li></ul>
Approvals	<ul style="list-style-type: none"><li>EMV Levels 1 and 2</li><li>Visa PED (optional)</li><li>FCC Part 15 Class B</li><li>CE</li></ul>

### Note

Specifications are subject to change without notice following technological improvement of the device and its components.



## Initial Setup

### Unpacking the Box

To unpack the box:

1. Place the box right side up on a stable, flat surface.
2. For secure models of the NURIT 8000, verify that the Secure Device label that seals the box is intact.



Figure 2 Secure Device Label

#### **Caution**

If the Secure Device label is damaged or missing, do not open the box. This could be an indication of device tampering and may affect the validity of the warranty for the device. Notify your Lipman distributor.

3. For secure models of the NURIT 8000, peel off or cut through the Secure Device label.
4. Open the front flap of the box.



**NURIT 8000**

5. Open the top cover of the box.
6. Carefully remove the contents of the box.

**Note**

It is recommended that you save the box for future repacking or moving of the terminal.

7. Carefully inspect the contents for any damaged or missing components.

**Note**

Lipman has taken all measures to provide you with a complete device. If shipping damage is evident, file a claim with the shipping company. Notify your Lipman distributor concerning this damage, and if any components are missing.

## Contents Checklist

The following items should be found inside the box:

**Note**

Any one or more of the included accessories may be already attached to the terminal.

- NURIT 8000 Wireless Palmtop Solution
- AC/DC Power Adapter (boxed)
- Lithium-ion Battery Pack
- Paper Roll Spindle
- Thermal Paper Roll

**NURIT 8000**



- Touch Screen Stylus
- Keypad Privacy Shield
- SIM/SAM Cardholder Cover with Adhesive Void Label
- Documentation Pack

**Note**

Depending on the country of use or the specific application, the documentation package may include any or all of the following:

- Installation Manual
- User Manual
- Quick Reference Manual
- Contents List
- Magnetic Stripe Manager Card
- Limited Warranty Card
- Product Registration Card

**Note**

Depending on the particular model of the NURIT 8000, the external modem or the car adapter may also be included in the contents of the box. See Optional Accessories on page 19.

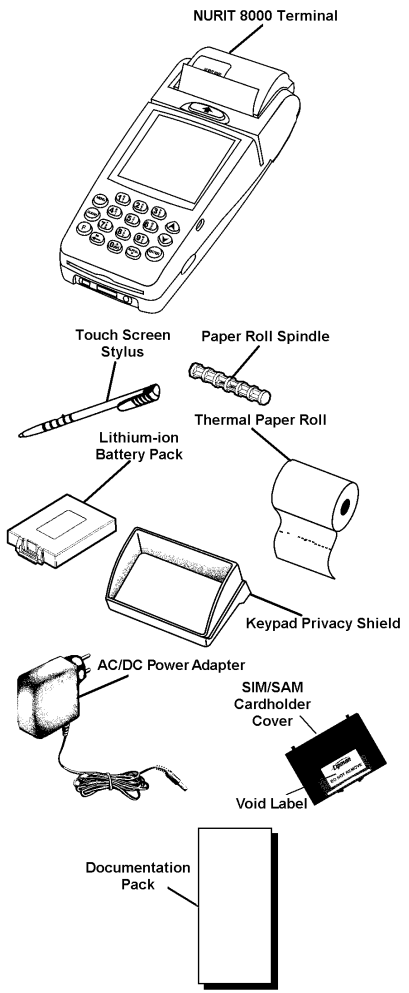
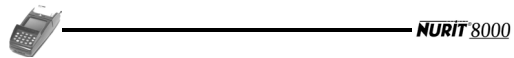

Figure 3 NURIT 8000 - Box Contents





## Selecting a Point-Of-Sale Location

The NURIT 8000 is designed to be operated in the following locations:

- Indoors, using the AC/DC Power Adapter, optional docking station or optional external modem.
- Outdoors, powered only by the built-in battery pack.
- In a car, using the optional car adapter cable.

### **Warning**

Do not locate the terminal where it is exposed to the following:

- Devices that radiate excessive electrical noise or voltage fluctuations, such as air conditioners, fans, electric motors, neon signs, or high-frequency security devices.
- Water containers, such as a sink, a laundry tub or a pool.
- Areas of excessive moisture, heat, oil, dust or debris.
- Direct sunlight or objects that radiate heat.
- Metal partitions or such obstructions that may disrupt radio transmission or reception if your terminal is used as a wireless device.



**NURIT 8000**

### **Caution**

Under no circumstances should the NURIT 8000 be powered or charged outdoors using its AC/DC adapter or docking station.

- When not operated from its hand-held position, place the NURIT 8000 on a flat table or countertop close to the power outlet and any peripherals.
- Do not cover the terminal.
- Maintain good ventilation around the terminal. To meet standard ventilation requirements, at least 22.1 centimeters (8.7 inches) of clear space must be provided around the terminal in its fixed operating location.

### **Note**

Before using the NURIT 8000, remove the thin transparent plastic membrane that covers the LCD screen.

### **Warning**

Do not use a NURIT 8000 that shows any signs of damage.



## Optional Accessories

### Caution

Connection of any accessory that is not explicitly approved by Lipman may cause damage and thus void the Limited Warranty of this equipment.

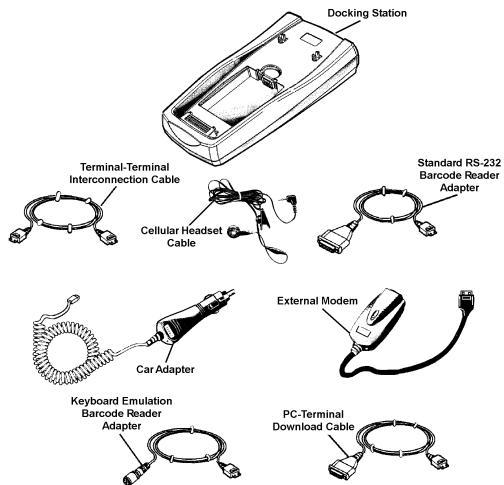

Figure 4 NURIT 8000 - Optional Accessories

### Note

Availability of the optional accessories may vary according to customer requirements. Consult your authorized Lipman representative for information regarding availability of current or future optional accessories.



Accessory	Details
<b>Docking Station</b>	<ul style="list-style-type: none"><li>• Charger for the terminal battery pack and for the optional spare battery</li><li>• Provides convenient connection of the NURIT 8000 to external devices</li><li>• Optional integrated telephone line modem, equivalent to the External Modem accessory</li><li>• Catalog No.: Model-dependent. Contact your service representative.</li></ul>
<b>PC-Terminal Download Cable</b>	<ul style="list-style-type: none"><li>• Cable used for downloading software applications to the terminal</li><li>• Connects to an RS-232 COM port on the PC</li><li>• Catalog No.: FCL09503</li></ul>
<b>Keyboard Emulation Barcode Reader Adapter</b>	<ul style="list-style-type: none"><li>• Enables connection of a PC keyboard or barcode reader to the terminal</li><li>• Facilitates the entry of catalog items and other data</li><li>• Catalog No.: FCL09506</li></ul>



Accessory	Details
<p><b>External Modem</b></p>	<ul style="list-style-type: none"> <li>• Up to 14.4 kbps, 33.6 kbps or 56 kbps telephone line modem</li> <li>• Implements synchronous or asynchronous, HDLC, TCP/IP protocols</li> <li>• Supports FastConnect connectivity</li> <li>• Depending on the particular model of the NURIT 8000, the external modem may be included with the contents of the box as a standard accessory.</li> <li>• Catalog No.: Model-dependent. Contact your service representative.</li> </ul>
<p><b>Car Adapter</b></p>	<ul style="list-style-type: none"> <li>• Connects to standard 12 V cigarette lighter socket</li> <li>• Used to power the NURIT 8000 and to charge its battery pack</li> <li>• Depending on the particular model of the NURIT 8000, the car adapter may be included with the contents of the box as a standard accessory.</li> <li>• Catalog No.: FCL09539</li> </ul>



Accessory	Details
<b>Standard RS-232 Barcode Reader Adapter</b>	<ul style="list-style-type: none"><li>• Enables connection of an RS-232 barcode reader to the terminal</li><li>• Catalog No.: FCL09504</li></ul>
<b>Terminal-Terminal Interconnection Cable</b>	<ul style="list-style-type: none"><li>• Enables peer-to-peer software updating</li><li>• Catalog No.: FCL09505</li><li>• <b>Note:</b> For security reasons, terminal-terminal software updating is not available for terminals with Secure Download enabled.</li></ul>
<b>Cellular Headset Cable</b>	<ul style="list-style-type: none"><li>• Hands-free headset</li><li>• 2.5 mm plug</li><li>• Not supplied by Lipman. Contact your cellular dealer for purchasing details</li></ul>



## General Features

The NURIT 8000 includes the following features:

Feature	Description
LCD Display	<ul style="list-style-type: none"><li>• Graphical LCD display of general operational prompts and messages</li><li>• Black and white</li><li>• 128x128 pixels</li></ul>
Touch Screen	<ul style="list-style-type: none"><li>• Application-dependent touch screen</li></ul>
Stylus	<ul style="list-style-type: none"><li>• Touch screen stylus</li><li>• Integrated stylus storage slot</li></ul>
Keypad	18 keys comprised of: <ul style="list-style-type: none"><li>• 10-key telephone-style keypad section (including the letters of the alphabet and the numerals 0-9)</li><li>• Function and special keys such as 'Cancel', 'Enter' and 'Backspace'.</li></ul>
Keypad Privacy Shield	<ul style="list-style-type: none"><li>• Detachable privacy shield</li></ul>
Smart Card Reader	<ul style="list-style-type: none"><li>• Integrated, front-entry smart card reader</li></ul>
Magnetic Card Reader	<ul style="list-style-type: none"><li>• Integrated, bi-directional reader for magnetic stripe cards</li></ul>



Feature	Description
SAM(s) Compartment	<ul style="list-style-type: none"><li>• Compartment capable of holding up to two SAM cards or one SAM and one SIM card, depending on the model.</li></ul>
SIM Slot	<ul style="list-style-type: none"><li>• Slot for the insertion of a SIM card, depending on the model.</li></ul>
Thermal Printer	<ul style="list-style-type: none"><li>• Quiet and fast integrated printer, using thermal paper.</li></ul>
Connectors	<ul style="list-style-type: none"><li>• 3-pin Power Jack</li><li>• Data Port</li><li>• Headset Jack</li><li>• Docking Station Connector</li></ul>
Battery Pack	<ul style="list-style-type: none"><li>• Smart Lithium-ion battery pack</li><li>• Supplies 7.2 VDC at 1450 mAH (minimum)</li><li>• Fully recharges within three hours (80% charge capacity within one hour)</li></ul>



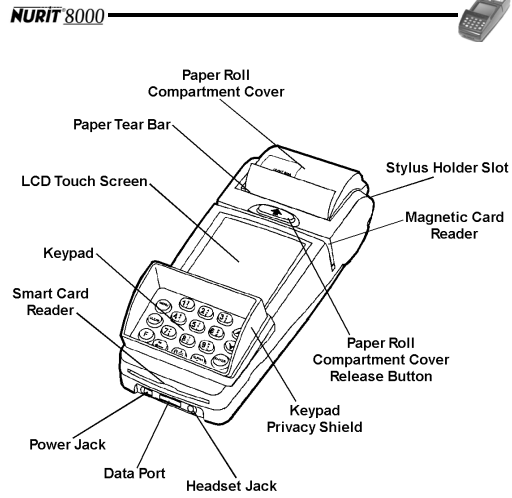

Figure 5 NURIT 8000 - Top View

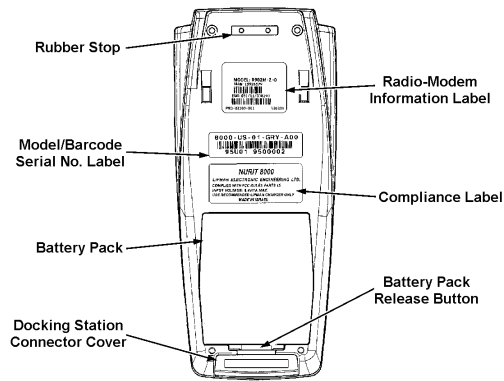

Figure 6 NURIT 8000 - Bottom View



## Installing the Battery Pack

### **Caution**

Before first use, you must charge the battery pack for a period of 12 hours.

#### To install the battery pack:

1. Carefully hold the terminal facedown or place it on a soft, smooth surface so as not to damage the LCD touch screen.
2. Hold the battery pack, verifying that the side with an arrow pictogram is facing upward.
3. Slide the two tabs on the front of the battery pack into the two slots on the front wall of the battery pack compartment.
4. Press down on the battery pack until it snaps into place.

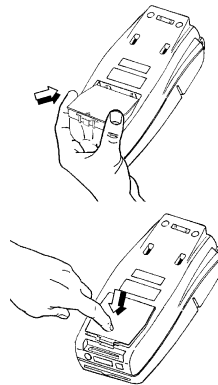
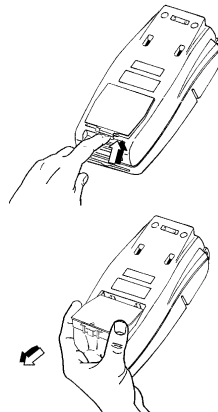

Figure 7 Battery Pack Installation



**To remove the battery pack:**

1. Carefully hold the terminal facedown or place it on a soft, smooth surface so as not to damage the LCD touch screen.
2. Press and lift the locking tab on the battery pack to release it from the compartment.
3. Remove the battery pack from the terminal.



**Figure 8 Battery Pack Removal**



## Battery Pack Maintenance

- The supplied high-performance, smart Lithium-ion battery pack provides 7.2 VDC at 1450 mAH (minimum) capacity.
- When fully discharged, the battery fully recharges within three hours while installed in the terminal. An 80% charge capacity is reached within one hour.
- The terminal can be connected to an AC/DC power supply indefinitely without causing damage to the battery.

### **Caution**

When using the Lipman-supplied AC/DC Power Adapter, the Lithium-ion battery pack must be installed in the terminal.

- In typical use, the lifespan of the battery pack exceeds 500 charge cycles, after which, operating time may very slowly decrease.
- The battery pack has a self-discharge rate, and when not in use, it loses approximately 1% of its charge per day.
- Replace the battery pack when the charge capacity is too weak for normal operation.
- If you intend not to use your NURIT 8000 for an extended period of time, remove the battery pack from the terminal.

**NURIT 8000**



### **Warning**

Do not dispose of the battery pack in a fire. Dispose of used batteries in accordance with local recycling regulations. If you intend to remove the NURIT's battery pack, make sure that the metal contacts do not come in contact with any metal objects.

### **Note**

Extreme temperatures will degrade the performance of your battery pack. Do not store the Lithium-ion battery pack in an ambient temperature below -20°C (4°F) or above 60°C (140°F).



**NURIT 8000**

## Connecting the NURIT 8000 to an AC Power Outlet

You can connect the NURIT 8000 to an AC power outlet using the Lipman-supplied AC/DC Power Adapter.

**To connect the NURIT 8000 to an AC power outlet:**

1. Connect the plug of the AC/DC Power Adapter cable to the 3-pin power jack on the front panel of the NURIT 8000.
2. Connect the AC/DC Power Adapter cable to an AC power outlet.

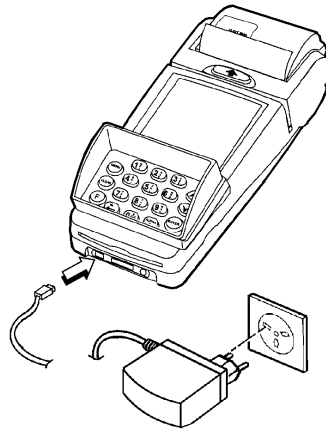

Figure 9 AC Power Connection

**NURIT 8000**



The LED indicator on the AC/DC Power Adapter lights as follows, according to the battery pack charge status:

- **Red**  
The battery pack is charging (less than 80% charged).
- **Green**  
The battery pack is charging (80% or more charged).
- **No Light**  
The battery pack is fully charged or the charger is disconnected from the AC power outlet.



## Installing the External Modem

You can use the optional external fast modem to download applications and parameters to the NURIT 8000 via a standard telephone line.

### To install the external modem:

1. Insert the modem's data plug into the data port on the front panel of the NURIT 8000.
2. Connect a standard telephone line cord from the modem to a standard RJ-11 type modular telephone line outlet.

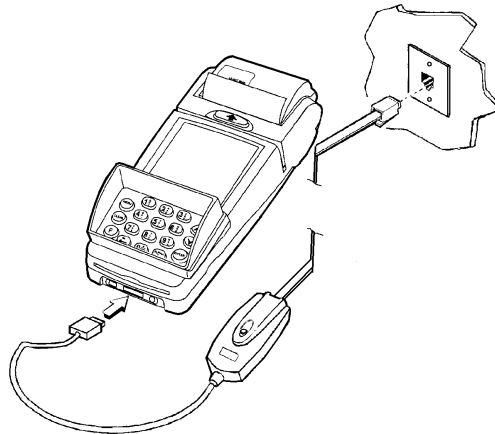

Figure 10 External Modem Installation





## Connecting the Car Adapter

You can use the car adapter battery charger to provide power to the NURIT 8000 and to charge the installed Lithium-ion battery pack.

### To install the car adapter battery charger:

1. Connect the plug of the car adapter battery charger cable to the 3-pin power jack on the front panel of the NURIT 8000.
2. Remove the cigarette lighter from its socket in the car.
3. Plug the car adapter into the cigarette lighter socket.

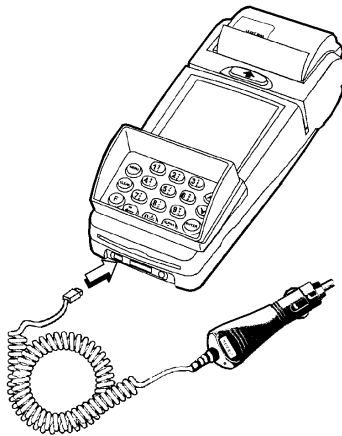

Figure 11 Car Adapter Connection



---

**NURIT 8000**

**To remove the car adapter battery charger:**

1. Unplug the car adapter from the cigarette lighter socket.
2. Unplug the car adapter battery charger cable from the 3-pin power jack on the front panel of the NURIT 8000.



## Loading Paper in the Printer

To load a roll of thermal paper in the printer:

1. Place the terminal on a flat, stable surface.
2. Press the paper roll compartment cover release button in the direction indicated by the displayed arrow.
3. Fully open the paper roll compartment cover.
4. Remove the paper roll spindle from the paper roll compartment
5. Remove the tape strip from a new thermal paper roll.
6. Insert the paper roll spindle into the new paper roll.
7. Unroll approximately 5 cm (2 inches) of paper to facilitate the loading process.
8. While holding the roll, place the spindle into the slots on each side of the paper roll compartment.
9. Ensure that the paper roll feeds from the bottom.



- 10.** Approximately 2.5 cm (1 inch) of paper should extend out of the paper roll compartment between the cover and the paper tear bar.
- 11.** Close the paper roll compartment cover and press down firmly until it snaps into place.

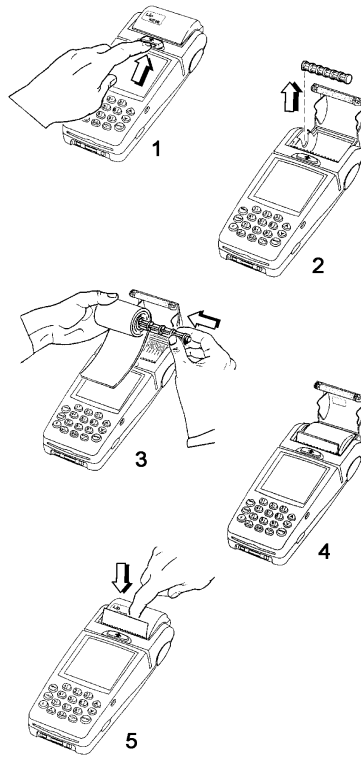

**Figure 12 Loading Paper in the Printer**



## Installing the Keypad Privacy Shield

To install the keypad privacy shield:

1. Place the terminal on a flat, stable surface, or hold it securely in one hand.
2. Position the tabs on the inner front sides of the keypad privacy shield over the indentations on each side of the terminal.
3. Press down the keypad privacy shield until it snaps into place.

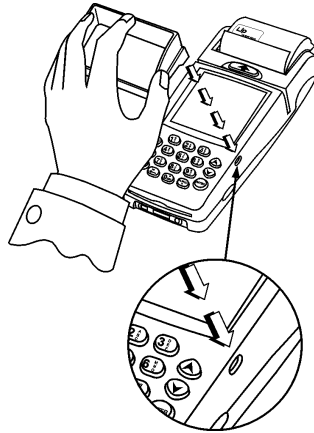

Figure 13 Keypad Privacy Shield Installation



**NURIT 8000**

### **Note**

Failing to install or removing the keypad privacy shield may render the terminal non-compliant with ISO 9564 for PIN protection and may violate card association requirements for PIN Entry Devices.

#### **To remove the keypad privacy shield:**

- 1.** Place the terminal on a flat, stable surface, or hold it securely in one hand.
- 2.** Grasp the keypad privacy shield and pull it away from the terminal.



## Installing a SIM or SAM Card

Depending on the particular model, you can install up to two SAM cards and one SIM card in the NURIT 8000.

Cardholder	Options
SAM1	<ul style="list-style-type: none"> <li>If the model is configured to support the use of a single SAM card, it is placed in the SAM1 cardholder.</li> </ul>
SIM CARD /SAM2	<ul style="list-style-type: none"> <li>If the model is configured to support the use of two SAM cards, and a second SAM card is required, it is placed in the SIM CARD/SAM2 cardholder.</li> <li>If the model implements GSM or GPRS wireless communications technology and is configured to support the use of a single SAM card, the SIM card is placed in the SIM CARD/SAM2 cardholder.</li> </ul>
TEL SIM	<ul style="list-style-type: none"> <li>If the model implements GSM or GPRS wireless communications technology and is configured to support the use of two SAM cards, the SIM card is placed in the TEL SIM slot.</li> <li>If the model of the NURIT 8000 does not implement GSM or GPRS wireless communications technology, or if the model is configured to support the use of a single SAM card, the TEL SIM slot is sealed and inaccessible.</li> </ul>



**NURIT 8000**

#### **Note**

A SIM card must be installed when using a model of the NURIT 8000 that implements GSM or GPRS wireless communications technology.

#### **Caution**

The SAM and SIM contacts can be easily damaged. Do not bend or scratch when installing or removing a SAM or SIM card.

#### **To install a SIM or SAM card:**

1. Carefully hold the terminal facedown or place it on a soft, smooth surface so as not to damage the LCD touch screen.
2. Press and lift the locking tab on the battery pack to release it from the compartment.  
See Figure 8 **Battery Pack Removal**.
3. Remove the battery pack from the terminal.
4. Slide the cardholder locking-clasp in the direction indicated by the engraved arrow to the **OPEN** position.



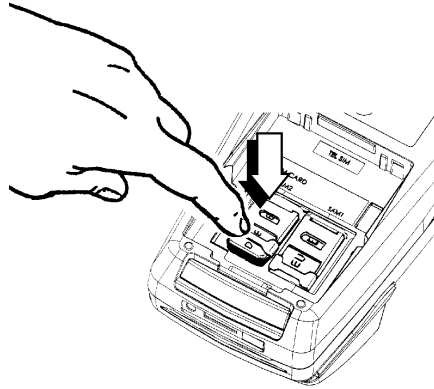

Figure 14 SIM/SAM Cardholder Locking-Clasp

5. Lift the cardholder on its hinge to an upright position.
6. Hold the SAM or SIM card so that its chip side is facing down towards the contacts on the reader.
7. Insert the SAM or SIM card into the cardholder.

**Note**

Make sure that you first slide the end closest to the chip on the card into the grooves of the holder.

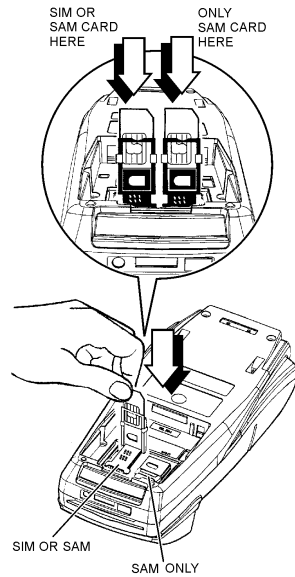

Figure 15 SIM/SAM Card Installation

8. Close the SAM or SIM cardholder.
9. Lock the cardholder by sliding the cardholder locking clasp in the direction indicated by the engraved arrow to the **LOCK** position.
10. Replace the battery pack.  
See Figure 7 **Battery Pack Installation**.



## Installing the SIM/SAM Cardholder Compartment Cover

After installing the SIM/SAM card(s), you can cover the cardholders with the supplied plastic cover. You can also protect this cover from being opened by sticking the included void label over the cutout in the cover.

### To install the SIM/SAM cardholder compartment cover:

1. Carefully hold the terminal facedown or place it on a soft, smooth surface so as not to damage the LCD touch screen.
2. Press and lift the locking tab on the battery pack to release it from the compartment.  
See Figure 8 **Battery Pack Removal**.
3. Remove the battery pack from the terminal.
4. Insert the two square tabs at the top of the plastic cover beneath the upper wall of the SIM/SAM cardholder compartment.
5. Press down on the bottom of the cover until the two tabs snap into place under the lower wall of the SIM/SAM cardholder compartment.

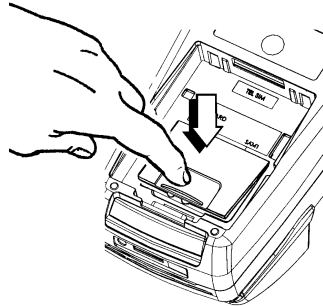

Figure 16 SIM/SAM Cardholder Compartment Cover Installation

6. Peel the back off the **DO NOT REMOVE** void label and stick it over the cutout in the plastic cover.

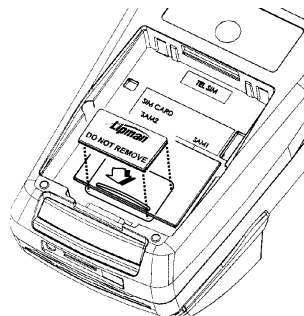

Figure 17 Void Label Installation

7. Replace the battery pack.  
See Figure 7 **Battery Pack Installation.**



## Installing a SIM Card in the TEL SIM Slot

To install a SIM card in the TEL SIM slot:

1. Carefully hold the terminal facedown or place it on a soft, smooth surface so as not to damage the LCD touch screen.
2. Press and lift the locking tab on the battery pack to release it from the compartment.

See Figure 8 **Battery Pack Removal**.

3. Remove the battery pack from the terminal.
4. Using the pointed end of the touch screen stylus (or any instrument with a similarly-sized pointed end), push the SIM cardholder eject button at the front left side of the TEL SIM slot until the SIM cardholder is ejected.

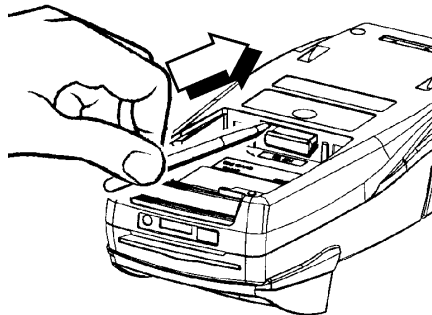

Figure 18 SIM Cardholder Ejection



5. Extract the SIM cardholder fully from the TEL SIM slot.
6. Insert the SIM card into the cardholder with its chip side facing down towards the contacts on the reader.

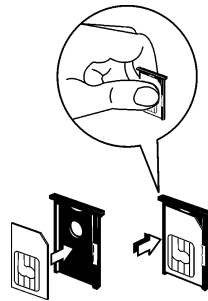

Figure 19 SIM Card Installation

7. Insert the SIM cardholder fully into the TEL SIM slot, as displayed in Figure 20 **SIM Cardholder Insertion**.

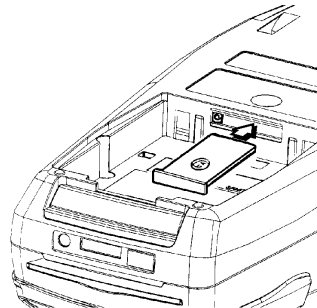

Figure 20 SIM Cardholder Insertion

8. Replace the battery pack.  
See Figure 7 **Battery Pack Installation**.



## Connecting Peripheral Devices

You can connect a variety of optional peripheral devices to the NURIT 8000, including:

- Barcode readers
- Check readers
- Signature capture devices
- Electronic scales
- PCs

### **Note**

Peripheral devices may require special adapter cables for their connection to the NURIT 8000. In addition, certain peripheral devices require an external power supply.

Refer to the specific product documentation of the peripheral devices or contact your local Lipman representative for further details.

To illustrate the procedure for connecting peripheral devices to the NURIT 8000, this section describes how to connect a Keyboard Emulation Barcode Reader to the terminal.



**NURIT 8000**

**To connect a barcode reader to the NURIT 8000:**

1. Connect the barcode reader to the appropriate end of the optional adapter cable (Part No. FCL09506).
2. Insert the other end of the adapter cable into the data port on the front panel of the NURIT 8000.

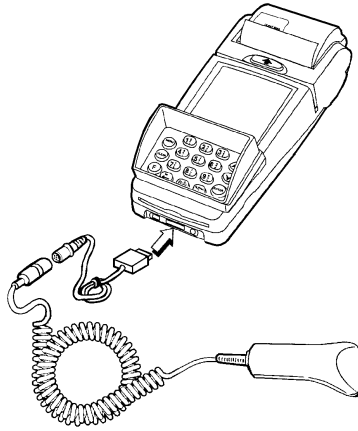

Figure 21 Barcode Reader Connection





## Connecting a Cellular Headset

You can use a standard cellular headset with NURIT 8000 models that support cellular telephone communication.

### To use the cellular headset:

1. Insert the plug on the headset cable into the headset jack on the front panel of the NURIT 8000.
2. Place the earpiece on the headset cable in your ear.

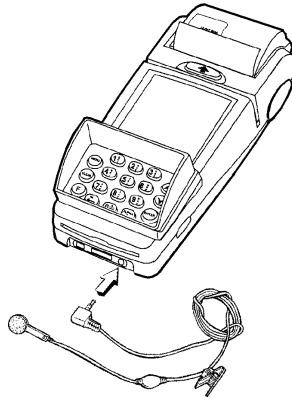

Figure 22 Cellular Headset Connection

### Note

When disconnecting the cellular headset, grasp the plug on the headset cable. Do not pull the cable to disconnect the cellular headset.



## General Care and Maintenance

The NURIT 8000 has been designed to give you long and trouble-free service with minimal operator care. To maintain the accurate functioning of the terminal, protect it from direct sunlight, extreme heat, dampness and dust.

### Cleaning the NURIT 8000

For normal cleaning, observe the following guidelines:

#### **Caution**

- Never use abrasive compounds or solvents, thinners, benzene or synthetic cleansers as they may distort or damage the plastic and critical parts.
  - Never clean the keypad with liquids. Use only a lightly dampened cloth or soft brush.
  - Never rub or strongly press on the LCD touch screen.
- Gently wipe off dirt from the body of the terminal with a soft, damp, lint-free cloth.
  - A very mild dishwashing detergent can be used to dampen the cloth.
  - Alcohol or alcohol-based cleansers may also be used for stains that are more difficult.



- If available, a low-pressure blower can be used to remove dirt or debris accumulated around the keypad buttons and within the paper roll compartment.
- If possible, use a lens blower to remove dust and dirt from the LCD touch screen.
- When necessary, gently wipe the touch screen with a soft cloth or eyeglass lens wiper.

## **Cleaning the Printer**

### **To clean the printer:**

- 1.** Disconnect the terminal from the power supply.
- 2.** Open the paper roll compartment cover.
- 3.** Carefully lift the paper roll and remove any excess pieces of paper or dirt that might be lodged in the compartment. If available, use a low-pressure compressed air gun.
- 4.** Replace the paper roll.
- 5.** Close the paper roll compartment cover.



**NURIT 8000**

## Maintenance Recommendations

To maintain the NURIT 8000 in full working condition, it is recommended that you observe the following guidelines:

- Keep the terminal dry and in the cleanest possible working and storage environment.
- Do not store the terminal in extremely hot or cold areas.
- Do not open the AC/DC Power Adapter.
- Do not shake or drop the terminal.
- Do not attempt to open terminal components, other than the battery pack compartment.

### **Caution**

Opening a secure model of the NURIT 8000 will automatically result in erasure of all secret encryption keys and will render the terminal inoperable.

## Technical Assistance

Contact your Lipman representative for technical assistance and ordering information regarding specific components or accessories.



## Shipping the NURIT 8000

In exceptional circumstances, you may be required to ship your NURIT 8000 to a servicing facility.

### To ship the NURIT 8000:

1. Carefully pack the NURIT 8000, preferably in the original carton.
2. Attach a postage-paid letter to the outside of the package detailing the complaint and including the following information:
  - Serial Number (displayed on the bottom of the terminal)
  - Date of Purchase
  - Name of Dealer
  - Address of Dealer
3. Send the package prepaid and adequately insured.

#### **Note**

Notify a Lipman representative before shipping the NURIT 8000. Shipment must be to an authorized dealer or service center only. Products sent to other locations will be returned at the owner's expense.

Contact your Lipman dealer for the correct address.



## Troubleshooting

The NURIT 8000 has been designed for trouble-free operation. However, minor problems may occur during installation and use. This section briefly describes how to troubleshoot some possible common problems that may arise during the normal operation of the NURIT 8000. Before requesting service for the terminal, read this section to find a possible remedy for the problem. If you are still unable to solve the problem, contact a service representative. Do not try to solve the problem by opening the terminal yourself.

### **Caution**

Turn off the NURIT 8000 or disconnect it from the power supply before connecting or disconnecting any peripheral device.



Problem	Remedy
<p>The terminal appears to have no power</p>	<ol style="list-style-type: none"> <li>1. Verify that the AC/DC Power Adapter is fully plugged into the AC power outlet and that its barrel connector mates properly with the terminal power jack.</li> <li>2. Verify that voltage is reaching the AC power outlet by connecting a different device to this outlet. If you suspect any type of problem at this electrical outlet, contact a certified electrician for a professional inspection.</li> <li>3. Press and hold down the 'ON' key for three (3) seconds.</li> <li>4. Verify that the battery pack is securely installed and sufficiently charged.</li> <li>5. If possible, try to operate the NURIT 8000 with a different Lipman supplied AC/DC Power Adapter.</li> <li>6. Connect the NURIT 8000 to a different AC power outlet.</li> <li>7. Try to adjust the LCD screen contrast settings, using the designated, model-dependent key combination.</li> <li>8. If the problem persists, contact an authorized service representative.</li> </ol>



<b>Problem</b>	<b>Remedy</b>
<b>Transactions cannot be completed successfully</b>	<ol style="list-style-type: none"><li>1. Try to perform the transaction using a different magnetic or smart card (model-dependent).</li><li>2. Make sure you have inserted or swiped the card in the proper manner.</li><li>3. Attempt to complete several transactions manually using the terminal keypad instead of using customer cards. If all these transactions are completed successfully, contact an authorized service representative.</li><li>4. If a manually performed transaction is not completed successfully, verify that the wireless transmission quality is sufficient to complete the transaction. Try changing your location to obtain improved transmission quality.</li><li>5. If the problem persists, contact an authorized service representative.</li></ol>





Problem	Remedy
<p style="text-align: center;"><b>Wireless communication is disrupted or cannot be established</b></p>	<ol style="list-style-type: none"> <li>1. Try moving the terminal to a more open operating area. An enclosed area degrades the quality of wireless reception and transmission.</li> <li>2. Verify that the SIM card being used for wireless communication is installed correctly and is not damaged or malfunctioning.</li> <li>3. In general, the angle of operation does not affect terminal performance. However, for optimal usage, hold the terminal at an angle not exceeding 30°.</li> <li>4. If the problem persists, contact an authorized service representative.</li> </ol>
<p style="text-align: center;"><b>Operation with a peripheral device is not successful</b></p>	<ol style="list-style-type: none"> <li>1. Verify that the peripheral device is properly connected to the terminal.</li> <li>2. Try to verify whether the peripheral device is functioning properly.</li> <li>3. Replace the cable or the adapter cable being used with the peripheral device.</li> <li>4. If the problem persists, contact an authorized service representative.</li> </ol>



<b>Problem</b>	<b>Remedy</b>
<b>The printer does not function properly</b>	<ol style="list-style-type: none"><li>1. Recharge or replace the battery pack.</li><li>2. If the problem persists, connect the terminal to the AC power outlet using the AC/DC Power Adapter.</li><li>3. Verify that the AC/DC Power Adapter is connected properly to the AC power outlet and that its barrel plug mates with the power jack on the front panel of the terminal. Verify that the LCD display is lit.</li><li>4. Verify that the paper roll compartment cover is fully and securely closed.</li><li>5. Open the paper roll compartment cover and check whether the paper roll has been used up. If it has, replace the thermal paper roll.</li><li>6. Verify that the paper roll and spindle are correctly installed.</li><li>7. Verify that the paper has been fed to the printer from the bottom of the paper roll.</li><li>8. Verify that the paper is not jammed or damaged. If it is, reload the paper.</li><li>9. If the problem persists, contact an authorized service representative.</li></ol>



Problem	Remedy
<p>The printer continues to operate when out of paper</p>	<ol style="list-style-type: none"> <li>1. Verify that the paper sensor of the printer mechanism (inside the paper roll compartment) is not blocked by a torn piece of paper or dirt.</li> <li>2. If the problem persists, contact an authorized service representative.</li> </ol>
<p>The magnetic card reader does not function properly</p>	<ol style="list-style-type: none"> <li>1. Verify that the card has been swiped with its magnetic stripe at the bottom and facing the user. See Figure 23 <b>Magnetic Card Reader</b> on page 60.</li> <li>2. Swipe the magnetic card in the opposite direction.</li> <li>3. If possible, try using a different magnetic card.</li> <li>4. If the problem persists, contact an authorized service representative.</li> </ol>
<p>The smart card reader does not function properly</p>	<ol style="list-style-type: none"> <li>1. Verify that the chip end of the smart card is fully inserted with chip side up. See Figure 24 <b>Smart Card Reader</b> on page 61.</li> <li>2. If possible, try using a different smart card.</li> <li>3. If the problem persists, contact an authorized service representative.</li> </ol>



## Appendix A Using the Magnetic Card Reader

A magnetic card reader is located between the terminal's LCD touch screen and the release button of the paper roll compartment cover.

**To use the magnetic card reader:**

1. Grasp the card so that its magnetic stripe is facing you.
2. Place the card into one end of the card reader slot.
3. Swipe the card in a smooth continuous manner in either direction (left-to-right or right-to-left).



Figure 23 Magnetic Card Reader



## Appendix B

### Using the Smart Card Reader

To use the smart card reader:

1. Hold the smart card with the metal chip facing upward and directed toward the opening of the smart card reader at the front of the NURIT 8000.
2. Insert the card into the smart card reader slot.

#### Note

For guidance, a pictogram near the card slot indicates how to insert the smart card into the smart card reader. In addition, insertion direction arrows may be engraved or inscribed on the smart card.

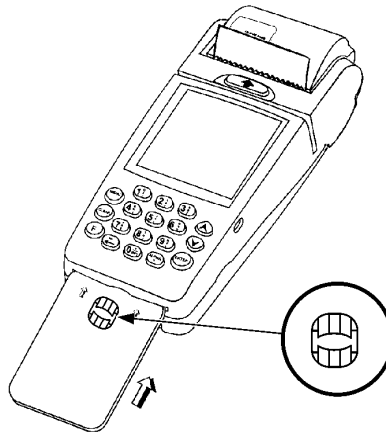

Figure 24 Smart Card Reader



---

**NURIT 8000**

3. Remove the card when prompted by the terminal, depending on the specific application being used.



