

- 1 Remove screw from SIM card access door on back of Omni 3600 terminal (Figure 13).

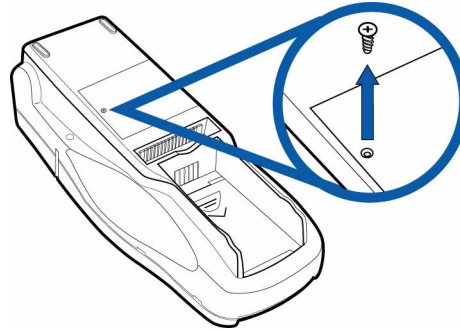

**Figure 13 Remove SIM Door Screw**

- 2 Remove the SIM card access door (Figure 14):

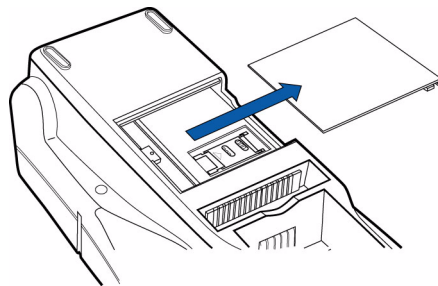

**Figure 14 Slide Off SIM Card Access Door**

- 3 Open the SIM card holder and slide the SIM card supplied by your provider into the cardholder (Figure 15).

**NOTE**



Do not lose the SIM card dust cover or retaining screw.

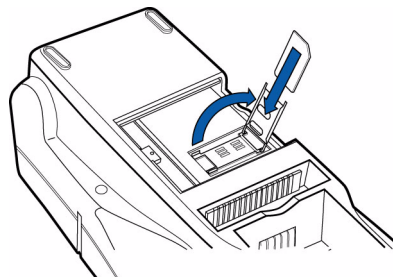

**Figure 15 Insert SIM Card into Cardholder**

**NOTE**



The SIM cardholder has a notch on one corner to ensure the SIM card is positioned correctly. The SIM card has a notch on one corner for easy orientation in the cardholder. Before inserting the SIM card, position it as shown in Figure 15, with the card's gold contacts facing down.

- 4 Replace the SIM card access door and screw.

## Wireless Transactions

To conduct a wireless transaction:

- Ensure the terminal is in an optimal position for transmitting.
- Follow the on-screen instructions provided with your application.

## Smart Card Reader Transactions

To conduct a smart card transaction:

- 1 Position the smart card with the contacts up and insert it into the smart card reader slot in a smooth, continuous motion until it seats firmly (Figure 16).

Leave the smart card in the card reader until the transaction is complete. Premature removal voids the transaction.

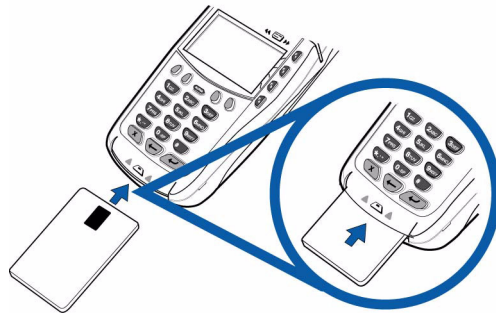

**Figure 16** Using the Primary Smart Card Reader

- 2 Remove the card when the display indicates the transaction is complete.

## Magnetic Card Reader Transactions

To conduct a credit/debit card transaction:

- 1 Position the card with the magnetic stripe facing down and towards the printer.
- 2 Swipe it through the reader from left-to-right, as shown in Figure 17.

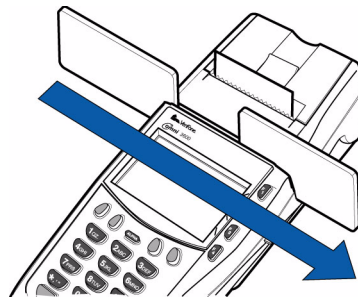

**Figure 17** Using the Magnetic Card Reader

## Antenna (Some Wireless Models)

For some Omni 3600 terminals to establish a wireless connection, an external antenna is provided. This connection allows communication with your service provider to upload transaction data from the terminal and download system upgrades to the terminal. Radio service is activated by your service provider.

### NOTE



Most Omni 3600 terminals have an internal antenna and this section can be ignored.

Only use the antenna designed for your unit. Failure to use the proper antenna results in the inability to establish a wireless connection.

### CAUTION



Never hold the unit by the antenna; doing so may break the connection and void your warranty.

Data transfers can also be performed through the Omni 3600 base (see [Omni 3600 Base Communications Ports](#)).

This section only discusses Omni 3600 terminals with external antenna.

## Installation

The Omni 3600 should arrive from manufacture with the antenna attached. If unattached, use the following procedure to install the antenna:

- 1 Locate the antenna port on the side of the Omni 3600 terminal.
- 2 Align the respective “notch” inside the antenna to the key in the terminal (Figure 18).
- 3 Push gently on the center of the base of the antenna until it locks in position.

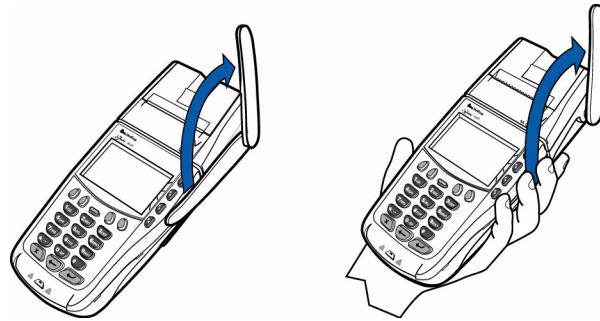

**Figure 18** Antenna Installation

## Orientation

To establish good wireless communication (*uplink*), it is important that the antenna always be vertically aligned with respect to ground and sky (Figure 19). For example, if standing and holding the terminal horizontally, position the antenna at an approximately 90° angle to the unit (that is, pointing up from the printer). This should point the antenna directly at the sky.

If the unit is on a flat surface (for example, a table top) or docked in the Omni 3600 base, position the antenna so that it points directly at the sky. Soft detentes are felt and clicks heard when positioning the antenna. These detentes maintain antenna positions of 60°, 90°, and 180°.



**Figure 19** Correct Antenna Position for Uplink

If an application (for example, SoftPay) is installed in your Omni 3600 unit, a signal strength indicator may appear on the display.

### Replace the Antenna

If your Omni 3600 terminal has difficulties completing wireless transactions, you may have to replace the antenna. Use the following procedure to replace the antenna:

- 1** Remove the existing antenna from the Omni 3600 terminal:
  - a** Rotate the antenna to align with the base of the unit, pointing away from the back.
  - b** Grasp the base of the antenna, close to the body of the terminal.
  - c** Pull gently out until the antenna unsnaps from the antenna port.
- 2** Align the respective notch inside the new antenna to the key in the antenna port on the terminal (Figure 18).
- 3** Push gently on the center of the base of the newly installed antenna until it locks in position.



## Omni 3600 Base

This section discusses the features of the Omni 3600 base, including

- providing power to the Omni 3600 base,
- docking the Omni 3600 terminal,
- charging the smart battery in a docked terminal,
- charging a spare smart battery,
- establishing communications, and
- connecting peripheral devices.

The Omni 3600 base does not support PIN pad connections.

### Unpack the Shipping Carton

Refer to [Figure 20](#) and the following procedure while unpacking the Omni 3600 base shipping carton.

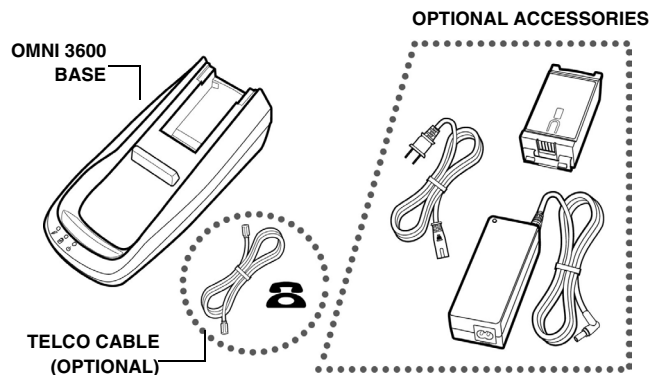

**Figure 20** Omni 3600 Base Shipping Carton Contents

1 Remove the following items:

- Omni 3600 base
- Telco cable (optional)

**NOTE** The power pack and power cable, spare battery packs, and Telco cable are available separately. See [Accessories and Documentation](#) for ordering information.

2 Remove all plastic wrap from the Omni 3600 base and other components.

## Omni 3600 Base Features

This section discusses the features of the Omni 3600 base.

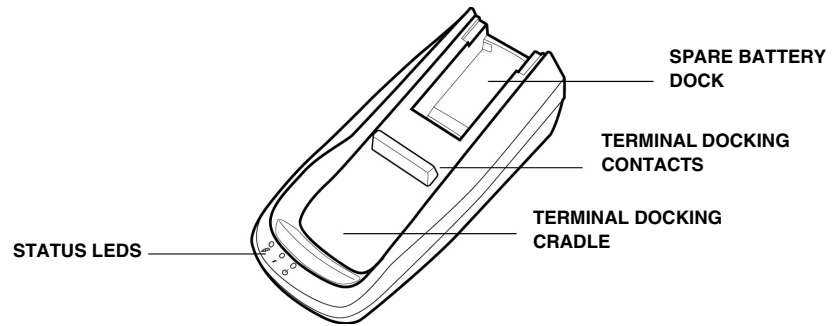

**Figure 21** Omni 3600 Base Features: Top



Avoid touching the contacts in the raised area in the center of the Omni 3600 base. Finger oils tarnish contacts, causing bad connections. If the battery charge state or terminal power LEDs do not light when the terminal is docked, or there is a high occurrence of bad or incomplete data transfers, clean the contacts. See [Maintenance](#) for more information.

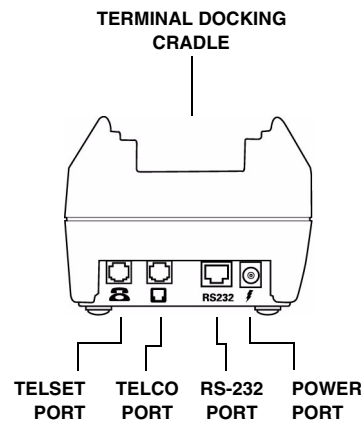

**Figure 22** Omni 3600 Base Features: Back (Telco models)

The Omni 3600 base

- recharges the smart battery within a docked Omni 3600 terminal,
- charges a spare smart battery pack placed in the spare battery dock,
- establishes communications to a host through a 14.4 Kbps modem (Telco port), and
- connects to optional peripherals through the serial (RS-232) port (see [Peripheral Devices](#)).

The following are the physical features of the Omni 3600 base ([Figure 21](#) and [Figure 22](#)):

- Three status LEDs (light emitting diodes) viewed left-to-right



- Terminal power LED:
  - Steady green indicates the battery in the terminal is fully charged or the terminal is docked, but has no battery.
  - Flashing amber indicates the battery in the terminal is receiving a *test charge* and is in the *precharge state*—the Omni 3600 base circuitry is determining the charge state of the battery in terminal.
  - Steady amber indicates the battery in the terminal is recharging.















- Battery charge state LED:
  - Steady green indicates the spare battery docked in the Omni 3600 base is fully charged or is no longer charging.
  - Flashing amber indicates the spare battery is receiving a *test charge* and is in the *precharge state*—the Omni 3600 base circuitry is determining the charge state of the spare battery.
  - Steady amber indicates the battery in the spare battery dock is recharging.



- Omni 3600 base power LED:
  - Steady green indicates the Omni 3600 base is connected to the power adapter.
  - Not lit indicates the Omni 3600 base is not connected to the power pack, the power pack is not connected to the wall outlet, or the power is out.

Table 1 illustrates different LED states.

**Table 1** Omni 3600 Base LED Status

Battery State	LED		
	 Terminal Power	 Spare Battery	 Omni 3600 Base Power
Fully charged battery in Omni 3600 terminal and spare battery in Omni 3600 base			
Pre-charge state			
Charging			
Omni 3600 base has power			

- Docking cradle: For Omni 3600 terminal (Figure 21) smart battery recharging and data transfers.

**NOTE**



The Omni 3600 terminal will not automatically turn off or *sleep* when docked; it must be turned off manually (see [Turn On/Off the Omni 3600 Terminal](#)).

- Spare battery docking station and optional spare battery: The recessed area in the top-rear of the Omni 3600 base is the dock to charge and store a smart battery. The spare battery LED does not light if no spare battery is present.
- ⚡ • Power port: The round port on back of Omni 3600 base (icon at left) connects the Omni 3600 base to the power pack.
- Communications ports: The ports on the back of the Omni 3600 base allow telephone or LAN line connectivity and peripheral device support.

## Power Connection

The Omni 3600 base unit must be plugged in to a power outlet to

- recharge a smart battery in a docked terminal,
- charge spare smart batteries,
- communicate with peripheral devices, and
- establish Telco host connections.

**WARNING**



Do not plug the power pack into an outdoor outlet.

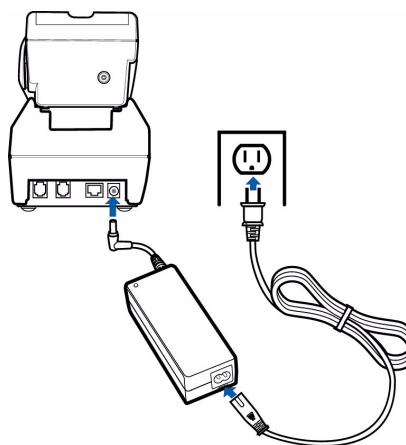

**Figure 23 Power Pack Connection (Docked Terminal)**



**NOTE**



It is recommended that the power pack be plugged into a power surge protector to protect against possible damage caused by lightning strikes and electrical surges.

To connect the Omni 3600 base to power (Figure 23):



-  1 Insert the round barrel connector into the power port (icon at left) on the far right of the Omni 3600 base.
- 2 Insert the power cable into the power pack.
-  3 Plug the power cable into a wall outlet or surge protector. When the Omni 3600 base is powered, the far-right LED (icon at left) lights steady green.

## Omni 3600 Terminal Docking

Place the Omni 3600 terminal in the docking cradle (Figure 23) to recharge the terminal smart battery, establish communications connections for data transfers, and communicate with peripheral devices.

### NOTE



The Omni 3600 terminal will not turn off or enter sleep mode while docked on the Omni 3600 base. This ensures that the unit is not placed into sleep mode during data transfers. **The unit must be turned off manually when docked on the Omni 3600 base.** See [Turn On/Off the Omni 3600 Terminal](#).

## Spare Smart Battery Pack

Spare smart battery packs for the Omni 3600 terminal can be ordered from VeriFone. See [Accessories and Documentation](#) for ordering information. To charge a smart battery in the Omni 3600 base, place the smart battery into the Omni 3600 base spare smart battery dock as shown in Figure 24. The smart battery dock is *keyed* so that the smart battery can only be inserted in one way.

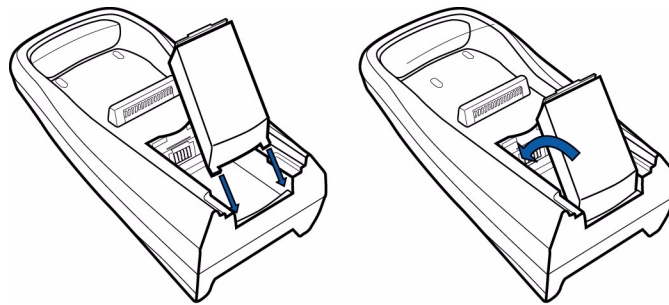

Figure 24 Spare Smart Battery Docking

### NOTE



Allow the spare battery to remain in the Omni 3600 base unit for a minimum of 2 hours, maximum of 4 hours to ensure the battery receives a full charge. Note that a new Li-ion battery's full performance is achieved only after two or three complete charge and discharge cycles.



Keep a spare smart battery charging in the Omni 3600 base battery dock to ensure that a fully charged battery is always available.

**CAUTION**  Conserve battery power by turning the Omni 3600 terminal off when not in use. If the terminal is not to be used for several days, remove the battery from the terminal as it continues to discharge even when the terminal is turned off.

If the Omni 3600 base unit is not plugged in, remove the smart battery from the dock to avoid the smart battery discharging in the Omni 3600 base unit.

On initial use, allow the Omni 3600 smart battery to charge a maximum of 4 hours and *fully discharge* during normal operation to ensure reliable battery operation. See [Smart Battery](#) for charge/discharge procedures.

**WARNING**  Do not dispose of batteries in a fire. Li-ion batteries must be recycled or disposed of properly. Do not dispose of Li-ion batteries in municipal waste sites.



### Omni 3600 Base Communications Ports

The communications ports are located on the back of the Omni 3600 base (see [Figure 25](#)). When the Omni 3600 terminal is docked in the Omni 3600 base, a communication port in the terminal is opened, and data can transfer from the Omni 3600 terminal back and forth through the Omni 3600 base over the modem connection to and from your service provider or merchant contact.

**NOTE**



The Omni 3600 base must be plugged into power to establish communications connections.

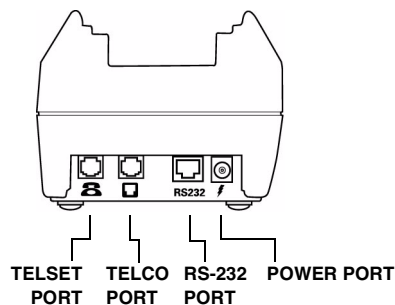

**Figure 25 Omni 3600 Base Connection Ports**

**WARNING**  Do *not* remove the Omni 3600 terminal from the Omni 3600 base during data transfers. This terminates the connection and data loss may result.

### Telephone Line Ports

There are two RJ11-type modular *phone* jacks ([Figure 25](#)) to connect the Omni 3600 base to a telephone line:



- The first port is identified by a telephone-shaped *Telset* icon shown at left. Use this port to connect a telephone to the terminal (*pass-through* connection)



- The second port is identified by the *Telco* icon shown at left. Use this port to directly connect the Omni 3600 series terminal to a telephone wall jack

## Telephone Line Connections

To make a direct connection, connect a telephone cord from the Telco port on the Omni 3600 base directly to a telephone wall jack (Figure 26). Do not string the telephone cord across a walkway or place it so as to interfere in high-traffic areas. With a direct connection, the phone line is dedicated to the terminal.

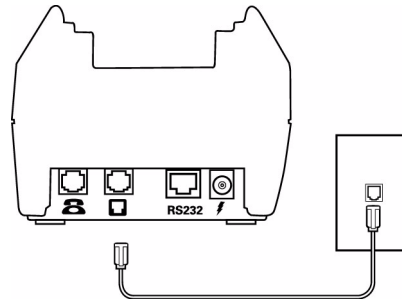

**Figure 26** Direct Connection

Pass-through connection — Run a telephone cord from the Telco port on the Omni 3600 base to the RJ11 jack on a standard telephone (Figure 27). Do not string the telephone cord across a walkway or place it so as to interfere in high-traffic areas. With a pass-through connection, the phone line is busy during downloads.

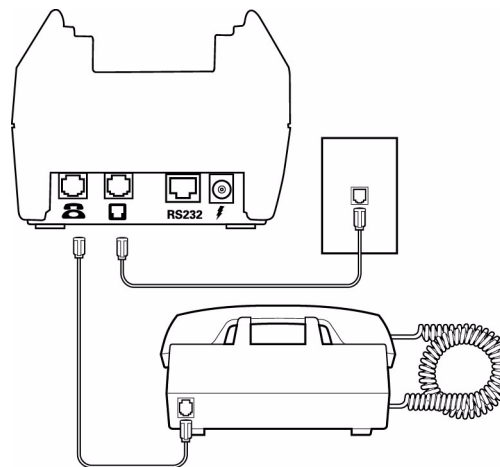

**Figure 27** Pass-through Connection

## Peripheral Devices

The Omni 3600 base supports a line of VeriFone peripheral devices designed to use with point-of-sale terminals. Use the RS-232 port on the back panel of the Omni 3600 base to connect these optional devices.

The following sections discuss the optional devices supported by the Omni 3600. Other optional devices may be supported. For more information, please contact your VeriFone distributor.

### Optional Peripheral Device Port

Right of the RJ11 ports is a RJ45-type modular jack (serial port), labeled RS232:

- The *RS232* serial port (icon shown at left) connects a VeriFone CR 600 check reader or other peripheral device to the Omni 3600 base

The Omni 3600 base does not support external PIN pad devices.

### Check Readers Supported

The Omni 3600 base supports two VeriFone check readers: CR 600 and CR 1000*i*. Contact your VeriFone representative or visit the online store at [www.verifone.com](http://www.verifone.com) for information on these devices. Figure 28 provides an example of a peripheral connection.

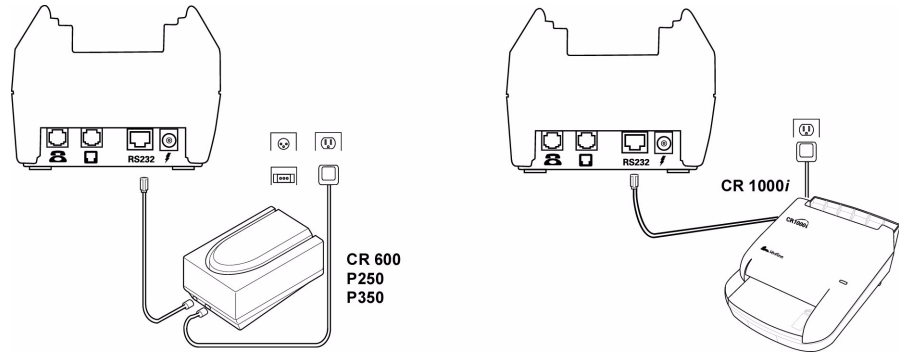

Figure 28 Example Peripheral Connections

### External Printers Supported

Although the Omni 3600 has an internal thermal printer (see [Paper Installation](#)), it may be convenient to print larger print runs (for example, daily or weekly reports) to an external printer. The Omni 3600 base supports three VeriFone external printers: P250, P350, and P900. Contact your VeriFone representative or visit the online store at [www.verifone.com](http://www.verifone.com) for information on these devices. External printer connections are through the same port as check readers (see [Figure 28](#)).



## Maintenance

This section discusses maintenance of the Omni 3600 terminal and Omni 3600 base.

### Cleaning

For normal dirt, use a clean cloth slightly dampened with water and a drop or two mild soap. For stubborn stains, use alcohol or an alcohol-based cleaner.



**CAUTION** Never use thinner, acetone, trichloroethylene, or ketone-based solvents — these chemicals can deteriorate plastic or rubber parts.

Do not spray cleaners or other solutions directly onto the keypad or display.



### Terminal and Base Contacts

Gently swab the contacts with alcohol or contact cleaner to remove dirt. It is important that the exposed contacts in the docking cradle of the base stay clean and unbent.



**CAUTION** Avoid touching the contacts in the raised area in the center of the base and the recessed area on the terminal. Finger oils tarnish contacts, causing bad connections. If the battery charge state or terminal power LEDs do not light when the terminal is docked or there is a high occurrence of bad or incomplete data transfers, clean the contacts.

### Card Readers

The magnetic and smart card readers require no regular maintenance. For card reader service, contact your VeriFone distributor or service provider.



Do not attempt to clean the card readers. Doing so may void your warranty.





## Troubleshooting

VeriFone follows stringent quality control standards in the manufacture of Omni 3600 terminals. Each unit that leaves the factory receives numerous tests to ensure quality and reliable operation. However, should you encounter a problem in operation, read this section for possible causes and solutions.

**NOTE**



The Omni 3600 terminal comes equipped with tamper-evident labels. Do not, under any circumstance, attempt to disassemble the terminal.

### Troubleshooting Guidelines

The troubleshooting guidelines provided in the following section identify various problems and suggest appropriate corrective actions. If you have problems operating your Omni 3600 terminal, please read through these troubleshooting examples. If the problem persists or if it is not described below, contact your local VeriFone representative for assistance.

During normal, day-to-day operation of your Omni 3600 terminal, it is possible that minor malfunctions may occur. Here are some examples of possible problems and steps you can take to resolve them.

**NOTE**



Perform only those adjustments or repairs specified in this guide. For all other services, contact your local VeriFone distributor or service provider. Service conducted by parties other than authorized VeriFone representatives may void the product warranty.

#### Terminal Does Not Start

- Ensure that the smart battery charge state is not below the critically low level.
- Recharge or replace the smart battery.
- Ensure that you pressed the ENTER/ON key for approximately 3 seconds, until the unit lit up.

#### Terminal Does Not Turn Off

The Omni 3600 terminal will not shut off or go into sleep mode while docked in the Omni 3600 base. You must turn off a docked Omni 3600 terminal manually or remove the Omni 3600 terminal from the Omni 3600 base to allow it to enter sleep mode.

#### Terminal Display Does Not Show Correct or Readable Information

- Recharge or replace the battery.
- Dock the Omni 3600 terminal in a powered Omni 3600 base (if you have one) to see if this clears the problem, which points to a discharged battery.

If the problem persists, contact your local VeriFone representative for assistance.

## Smart Battery Will Not Charge

The smart battery must initially receive a full charge and then full discharge to calibrate its full charge capacity. This operation is performed at manufacture; however, it is recommended that the battery receive a full charge/discharge once a year.

### NOTE



Allow the Omni 3600 terminal to remain connected to the power pack for a minimum of 2 hours, maximum of 4 hours to ensure the battery receives a full charge.

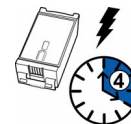

Conserve battery power by turning the Omni 3600 terminal off when not in use. If the terminal is not to be used for several days, remove the battery from the terminal as it continues to discharge even when the terminal is turned off.

To discharge the smart battery, run the unit until the smart battery is fully drained.

### NOTE



The Omni 3600 terminal automatically shuts off when the smart battery reaches the *critically low* charge state. If this occurs, the smart battery must recharge a minimum of 1/2 hour before it can power the terminal. **It make take several recharge attempts to reset the safety circuit** when charging a smart battery that has reached a critically low charge state.

## Telephone Line Connection Does Not Work Properly

- Check the telephone line cord-to-base connections, and all telephone connections.
- Check the telephone line cord.
- If you are using a pass-through (Telset) connection, check that the telephone handset is seated properly in its cradle. Also, check the line using another telephone base unit. If the other telephone works, have the defective telephone repaired or replaced.
- If you are using a direct (Telco) connection, check the Telco cable by plugging it into a working telephone and listening for a dial tone. If this test does not work, replace the Telco cable.
- If it is determined that the telephone line is dead, contact your local telephone company to check the status of the line.

If the problem persists, contact your local VeriFone representative for assistance.

## Printer Does Not Work

- Check battery status. The printer will not print if there is an insufficient charge remaining in the battery to complete the print operation.
- Check if the printer is out of paper and that the roll is properly installed. Open the paper roll cover and install a new roll of printer paper or ensure that the roll is feeding from the bottom.
- Verify that the printer roller and paper roll dust cover are properly installed.

If the problem persists, contact your local VeriFone representative for assistance.



## **Serial Port Does Not Work**

- Check the power cable connection.
- Ensure the outlet has power.
- The serial port on the back panel of the Omni 3600 base is identified by the “RS232” icon. Check that the device connected to the serial port has power and is functioning properly. If possible, perform a self-test on the device in question.
- The cable connecting the optional device to the Omni 3600 base serial port may be defective. Try a different serial cable.

If the problem persists, contact your local VeriFone representative for assistance.

## **Terminal Does Not Process Transactions**

There are several possible reasons why the terminal may not be processing transactions. Use the following steps to troubleshoot failures.

### **Step 1: Check the magnetic card reader**

- Perform a test transaction using several different magnetic stripe cards to ensure the problem is not a defective card.
- Ensure that you are swiping cards properly. With the Omni 3600 card reader, the black, magnetic stripe on the card should face down, away from the keypad.
- Process a transaction manually using the keypad instead of the card reader. If the manual transaction works, the problem may be a defective card reader. Contact your VeriFone distributor or service provider.
- If the manual transaction does not work, proceed to [Step 4](#).

### **Step 2: Check the smart card reader**

- Perform a test transaction using several different smart cards to ensure the problem is not a defective card.
- Ensure that the card is inserted correctly. The chip on the card should be facing up and inward.
- Ensure the MSAM cards are properly inserted in the cardholders and the cardholders are properly secured (see [Install/Replace MSAM Cards](#)).
- If the manual transaction does not process, proceed to [Step 4](#).

### **Step 3: Check the signal strength on-screen (SoftPay)**

- Signal-strength indicator displays at least one bar to indicate connectivity to radio network.
- Check antenna connection and orientation.
- Ensure that the radio has been activated by your service provider.

### **Step 4: Check the telephone line**

- Connect to a working telephone and check for a dial tone. If there is no dial tone, replace the Telco cable.

- If the problem appears to be with the telephone line, check with the party you are trying to call to see if their system is operational. If they are not experiencing difficulties with their line, contact the telephone company and have your line checked.
- If the telephone line works, contact your local VeriFone representative for assistance.

**Keypad Does Not Respond**

- Check the display panel. If it displays the wrong character or nothing at all when you press a key, follow the steps outlined in [Terminal Display Does Not Show Correct or Readable Information](#).
- If pressing a function key does not perform the expected action, refer to the user documentation for that application to ensure you are entering data correctly.

If the problem persists, contact your local VeriFone representative for assistance.



## VeriFone Service and Support

For Omni 3600 terminal or Omni 3600 base problems, contact your local VeriFone representative or service provider.

For Omni 3600 product service and repair information:

- United States: VeriFone Support Services, 1-800-837-4366, Monday–Friday, 8 A.M.–8 P.M. eastern time
- International: Contact your local VeriFone representative

For Omni 3600 supplies:

- VeriFone online store at [www.store.verifone.com](http://www.store.verifone.com)
- United States: VeriFone Support Services, 1-800-837-4366, Monday–Friday, 8 A.M.–8 P.M. eastern time
- International: Contact your local VeriFone representative

### Return a Terminal, Base, or Smart Battery

Before returning an Omni 3600 terminal, Omni 3600 base, or smart battery to VeriFone, you must obtain a Merchandise Return Authorization (MRA) number. The following procedure describes how to return one or more Omni 3600 terminals, Omni 3600 bases, or smart batteries for repair or replacement (U.S. customers only):

#### NOTE



International customers, please contact your local VeriFone representative for assistance with your service, return, or replacement.

- 1 Gather the following information from the printed labels on *each* Omni 3600 terminal (Figure 29), Omni 3600 base (Figure 30), and smart battery (Figure 31) you are returning:
  - Product ID, including the model and part number. For example, “OMNI 3600” and “PTID XXXXXXXX” (if your terminal includes this number)
  - Serial number (S/N XXX-XXX-XXX)
- 2 Within the United States, call VeriFone toll-free at 1-800-837-4366.
- 3 Select the MRA option from the automated message. The MRA department is open Monday–Friday, 8 A.M.–8 P.M., eastern time.
- 4 Give the MRA representative the information gathered in Step 1.

If the list of serial numbers is long, you can fax the list, along with the information gathered in Step 1, to the MRA department. Include a telephone number where you can be reached and your fax number.

Please print clearly to the attention of the “VeriFone MRA Dept.” and send your fax to 727-953-4172 (U.S.). You will be issued an MRA number and the fax returned to you.



One MRA number must be issued for each Omni 3600 terminal or Omni 3600 base you return to VeriFone, even if you are returning several of the same model.

- 5 Describe the problem and provide the shipping address to return the repaired or replacement unit.
- 6 Keep a record of the following items:
  - Assigned MRA number(s)
  - VeriFone serial number assigned to the Omni 3600 terminal, Omni 3600 base, or smart battery you are returning for service or repair (terminal serial numbers are located on the inside of the smart battery compartment; base serial numbers on the bottom of the unit; smart battery serial numbers on the side of the battery)
  - Shipping documentation, such as airbill numbers used to trace the shipment
  - Model(s) returned (model numbers are located on the VeriFone label on the bottom of the Omni 3600 terminal or Omni 3600 base)

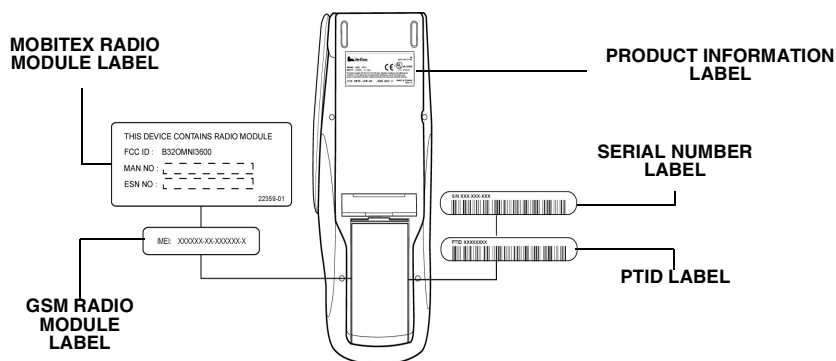
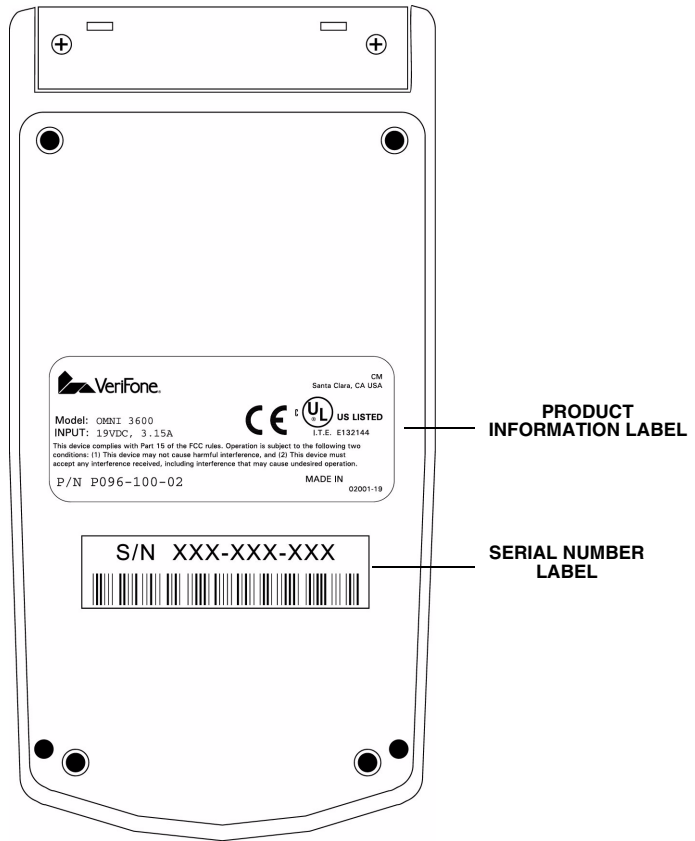
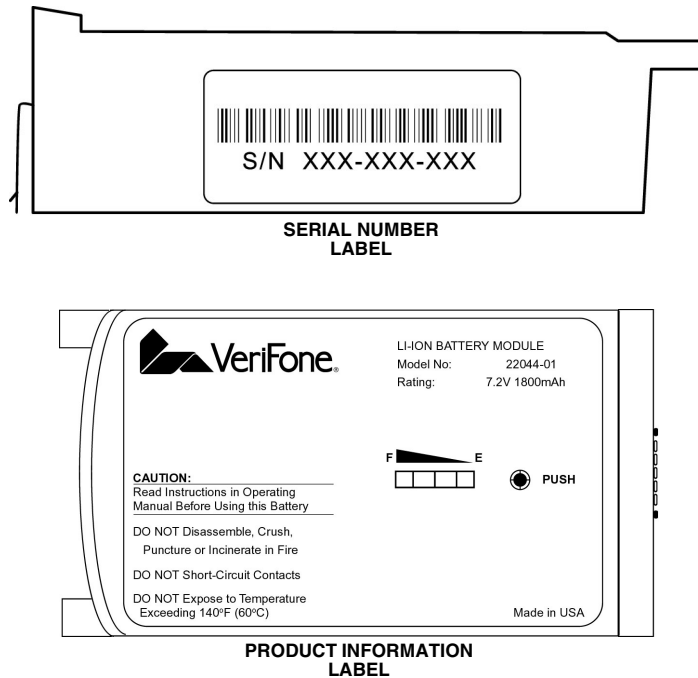

Figure 29 Omni 3600 Terminal Information Label Locations



**Figure 30 Omni 3600 Base Information Label Locations**



**Figure 31 Smart Battery Information Label Locations**





## Specifications

This section provides information on the power requirements, environmental conditions that the units can be subjected to, and unit dimensions.

### Power Requirements

DC power (all Omni 3600 terminals and Omni 3600 bases): DC: 19VDC; 3.16A

DC power pack (all Omni 3600 terminals and Omni 3600 bases):

- Input: 100–240 V ~ (100–240VAC); 50–60 Hz; 1.5A
- Output: 19VDC; 3.16A

Barrel connector polarity (all Omni 3600 terminals and Omni 3600 bases):



### Environmental

Omni 3600 terminal:

- Operating temperature: 0° to + 50° C (32° to 122° F)
- Storage temperature: – 20° to + 70° C (0° to 158° F)
- Relative humidity: 15% to 90%; no condensation

Omni 3600 base:

- Operating temperature: 0° to 55° C (32° to 131° F)
- Storage temperature: – 40° to + 70° C (–40° to 158° F)
- Relative humidity: 15% to 90%; no condensation

### Omni 3600 Terminal Dimensions

- Height: 69 mm (2.72 inches)
- Width: 95 mm (3.74 inches)
- Length: 220 mm (8.64 inches)

### Weight

- Terminal weight: 568 g (1.25 lb)
  - with battery installed: 681 g (1.5 lb)
  - with battery and paper roll installed: 710 g (1.56 lb)
- Shipping weight: 1264 g (2.78 lb): The shipping weight for the Omni 3600 terminal includes: shipping carton, one terminal, power pack and cable, one smart battery, paper roll, and one *Quick Installation Guide*.

## **Omni 3600 Base Dimensions**

---

- Height: 88.9 mm (3.5 inches)
- Width: 95.25 mm (3.75 inches)
- Length: 241.3 mm (9.5 inches)

## **Weight**

- Base station weight: 378 g (0.83 lb)
- Shipping weight: 498 g (1.098 lb): The shipping weight for the Omni 3600 base station includes: shipping carton, one base station, one Telco cable, and one *Quick Installation Guide*.





## Accessories and Documentation

This sections lists accessories and documentation available for the Omni 3600. When ordering, please refer to the part number in the left column.

### How to Order

- VeriFone Online Store at [www.store.verifone.com](http://www.store.verifone.com)
- United States: VeriFone Customer Development Center, 1-800-837-4366, Monday–Friday, 8 A.M.–8 P.M., eastern time
- International: Contact your local VeriFone representative

### Omni 3600 Terminal

This section presents accessory and part replacement ordering information for the Omni 3600 terminal. See [VeriFone Service and Support](#) for product service and repair information.

#### **Download Cables and Adapters**

05651-xx	MOD10-MOD10 (base station-to-base station)
26263-xx	02xxx MOD10-PC DB25F (base station-to-PC)
26264-xx	02xxx MOD10-PC DB9F (base station-to-PC)
22536-01	MOD10 adapter (terminal-to-terminal/PC/telephone)

#### **Cables for Optional Peripherals**

07041-xx	MOD10-MDIN9 (CR 600/CR 1000 <i>i</i> check readers)
----------	---

#### **Base Station**

P096-201-00	Base station
-------------	--------------

#### **Telco Cable**

00124-17	2.1-m (7') telephone line cord, black color, with modular RJ11-type connectors
----------	--

#### **Smart Battery**

22044-02	12V battery pack
----------	------------------

#### **Power Pack**

Contact your local VeriFone distributor to determine which power pack fits your needs.

22161-01	DC power pack (universal)
21973-01	Power cable (U.S.)

<b>Thermal Printer Paper</b>	CRM0043	Standard-grade thermal printer paper, 57-mm (2.25") width, 7.62-m (25') length; single roll
<b>Antenna</b>		Contact your VeriFone distributor to determine the exact antenna for your Omni 3600 terminal.
	22066-XX	Replacement antenna.
<b>VeriFone Cleaning Kit</b>	02746-01	Cleaning kit
<b>Omni 3600 Base</b>	P096-201-00	Base, U.S., 14.4 Kbps modem
	P096-203-00	Base, generic 14.4 Kbps modem
<b>Download Cables</b>	05651-xx	MOD10-MOD10 (base-to-base)
	26263-xx	02xxx Mod 10-PC DB25F (base-to-PC)
	26264-xx	02xxx Mod 10-PC DB9F (base-to-PC)
<b>Cables for Optional Peripherals</b>	07041-xx	MOD10-Mini DIN9 (CR 600/CR 1000i check readers; P250/P355/P900 external printers)
<b>Telephone Line Cord</b>	00124-17	2.1-meter (7-foot) telephone line cord, black color, with modular RJ11-type connectors
<b>Documentation</b>	22377	<i>Omni 3600 Quick Installation Guide</i>
	22378	<i>Omni 3600 Base Station Quick Installation Guide</i>
	22060	<i>Omni 3600 Installation Guide</i>
	19733	<i>Verix Operating System Programmer's Manual</i>



VeriFone, Inc.  
2455 Augustine Drive  
Santa Clara CA 95054-3002  
Tel: 800-VeriFone (837-4366)  
[www.verifone.com](http://www.verifone.com)

VERIX  
OPERATING  
ENVIRONMENT

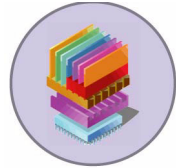

SOFTPAY  
E-PAYMENT  
APPLICATION



VERIX  
DEVELOPER  
TOOLKIT  
DEVELOPMENT  
TOOLS

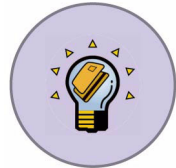

VERISHIELD  
SECURITY  
ARCHITECTURE



OMNI 37XX  
HAND-OVER-COUNTER  
MULTI-APPLICATION  
APPLIANCES



OMNI 33XX  
MULTI-APPLICATION  
APPLIANCES



OMNI 3600  
HAND-HELD  
RADIO MODEM  
APPLIANCES



VERICENTRE  
APPLIANCE  
MANAGEMENT  
SUITE

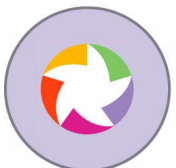

# Omni 3600

## *Installation Guide*