

Omni 5xxx

Installation Guide

VERIFONE
CONFIDENTIAL
DRAFT



Omni 5xxx Installation Guide
© 2004 VeriFone, Inc.

All rights reserved. No part of the contents of this document may be reproduced or transmitted in any form without the written permission of VeriFone, Inc.

The information contained in this document is subject to change without notice. Although VeriFone has attempted to ensure the accuracy of the contents of this document, this document may include errors or omissions. The examples and sample programs are for illustration only and may not be suited for your purpose. You should verify the applicability of any example or sample program before placing the software into productive use. This document, including without limitation the examples and software programs, is supplied "As-Is."

VeriFone, the VeriFone logo, Omni, VeriCentre, Verix, and ZonTalk are registered trademarks of VeriFone. Other brand names or trademarks associated with VeriFone's products and services are trademarks of VeriFone, Inc.

All other brand names and trademarks appearing in this manual are the property of their respective holders.

Comments? Please e-mail all comments in this document to Tell_Us_More@VeriFone.com

WARNING



Do not dispose of the Li-ion smart battery in a fire. Li-ion batteries must be recycled or disposed of properly. Do not dispose of Li-ion batteries in municipal waste sites.



VeriFone, Inc.
2455 Augustine Drive
Santa Clara CA 95054-3002

www.verifone.com

VeriFone Part Number 23216, Revision A.1



CONTENTS

PREFACE 5

Audience 5

Organization 5

Related Documentation 5

Conventions and Acronyms 6

 Document Conventions 6

 Acronym Definitions 6

CHAPTER 1
Terminal Overview

Features and Benefits 10

 Exceptional Ease of Use 10

 Countertop Performance in a “Hand-Over” Design 10

 True Multi-Application Capability 10

CHAPTER 2
Terminal Setup

Select Terminal Location 11

 Ease of Use 11

 Environmental Factors 11

 Electrical Considerations 11

Unpack the Shipping Carton 12

Examine Terminal Features 13

 Front Panel 13

 Connection Ports 14

Establish Telephone Line Connections 15

Install Paper Roll 16

Install/Replace MSAM Cards 18

Connect Optional Device(s) 19

 Connect PIN Pad or Smart Card Reader 20

 Connect Check Reader 21

 External Printers Supported 22

Connect Terminal Power Pack 22

Smart Card Transaction 23

Magnetic Card Reader Use 23

CHAPTER 3
Specifications

Power 25

 DC Power Pack 25

 Temperature 25

 External Dimensions 25

 Weight 25

CHAPTER 4
Maintenance

Clean the Terminal 27

Smart Card Reader 27

CHAPTER 5
VeriFone Service
and Support

Return a Terminal for Service. 29
Accessories and Documentation 30
 Power Pack. 31
 Thermal Printer Paper. 31
 VeriFone Cleaning Kit. 31
 Telephone Line Cord 31
 Swivel Stand 31
 Documentation 31

CHAPTER 6
Troubleshooting
Guidelines

Blank Display 33
Terminal Does Not Dial Out 33
Printer Does Not Print. 34
Printer Paper Jam. 34
Peripheral Device Does Not Work 34
Keypad Does Not Respond 34
Transactions Fail To Process. 35

VERIFONE
CONFIDENTIAL
DRAFT





This guide is your primary source of information for setting up and installing the Omni 5xxx series of terminals.

Audience

This guide is useful for anyone installing and configuring a Omni 5xxx terminal. Basic descriptions of the terminal features are also provided.

Organization

This guide is organized as follows:

Chapter 1, *Terminal Overview*. Provides an overview of the Omni 5xxx series of terminals.

Chapter 2, *Terminal Setup*. Explains how to set up and install the Omni 5xxx terminal. It tells you how to select a location, establish power and telephone line connections, and how to configure optional peripheral devices.

Chapter 3, *Specifications*. Discusses power requirements and dimensions of the Omni 5xxx terminal.

Chapter 4, *Maintenance*. Explains how to maintain your Omni 5xxx terminal.

Chapter 5, *VeriFone Service and Support*. Provides information on contacting your local VeriFone representative or service provider, and information on how to order accessories or documentation from VeriFone.

Chapter 6, *Troubleshooting Guidelines*. Provides troubleshooting guidelines, should you encounter a problem in terminal installation and configuration.

Related Documentation

To learn more about the Omni 5xxx terminal, refer to the following set of documents:

- *Omni 5xxx Quick Installation Guide*, VeriFone Part Number (VPN) - 23219
- *Omni 5xxx Certifications and Regulations*, VPN - 23218
- *Omni 5xxx Reference Manual*, VPN - 23217
- *Verix V Operating System Programmer's Manual*, VPN - 23230
- *Verix V Tools Programmer's Manual*, VPN - 23231



Conventions and Acronyms

This section describes conventions and acronyms used in this guide.

Document Conventions

Various conventions are used to help you quickly identify special formatting. Table 1 describes these conventions and provides examples of their use.

Table 1 Document Conventions

Convention	Meaning	Example
Blue	Text in blue indicates terms that are cross referenced.	See Conventions and Acronyms .
<i>Italics</i>	Italic typeface indicates book titles or emphasis.	You <i>must</i> install a roll of thermal-sensitive paper in the printer.
Courier	The courier type face is used while specifying onscreen text, such as text that you would enter at a command prompt, or to provide an URL.	<code>http://www.verifone.com</code>
	The pencil icon is used to highlight important information.	RS-232-type devices do not work with the PIN pad port.
	The caution symbol indicates possible hardware or software failure, or loss of data.	The terminal is not waterproof or dustproof, and is intended for indoor use only.
	The lightning symbol is used as a warning when bodily injury might occur.	Due to risk of shock do not use the terminal near water.

Acronym Definitions

Various acronyms are used in place of the full definition. Table 2 presents acronyms and their definitions.

Table 2 Acronym Definitions

Acronym	Definitions
AC	Alternating Current
ATM	Automated Teller Machine
CR	Check Reader
EMV	Europay MasterCard and VISA
ITP	Internal Thermal Printer
LCD	Liquid Crystal Display
LED	Light Emitting Diode
MRA	Merchandise Return Authorization
MSAM	Micromodule-Size Security Access Module
PED	PIN-Entry Devices

Table 2 Acronym Definitions (continued)

Acronym	Definitions
PIN	Personal Identification Number
RJ45	Registered Jack 45
RS-232	Recommended Standard 232
SAM	Security Access Module
VPN	VeriFone Part Number

VERIFONE
CONFIDENTIAL
DRAFT



VERIFONE
CONFIDENTIAL
DRAFT



Terminal Overview

This chapter provides a brief description of the Omni 5xxx series of terminals. This series includes the Omni 5100 and Omni 5150 terminals.

The Omni 5xxx terminal series represents the shape of things to come in e-payment. The bold ergonomic design is sleek and stylish, offering countertop power and 32-bit performance in an integrated terminal that can be handed to the consumer for input. In addition, the Omni 5xxx series serves as the entry point to VeriFone's acclaimed multi-application platform—with the capability to securely support payment and value-added applications on a single terminal.

NOTE



VeriFone ships variants of the Omni 5xxx terminal for different markets. Your terminal may have a different configuration. The following devices may or may not be present: a smart card reader, or zero or three MSAM cardholders.



Features At a Glance

- Delivers **power** and **usability** in a **convenient** “hand-over” design.
- Securely supports and runs **payment** and **value-added applications**.
- **Multi-application** operating environment.
- Offers **unsurpassed performance** on **EMV** smart card transactions.
- **32-bit processing** and **multi-tasking** capabilities.
- **Security** architecture meets specifications for PED and sophisticated **file authentication**.

Features and Benefits

Omni 5xxx terminals provide the right combination of features and functions. This includes a triple-track magnetic-stripe card reader, smart card reader, integrated PIN pad, and a quiet, fast, ITP.

Exceptional Ease of Use

- Bold design is sleek, stylish, and lightweight for conveniently handing the terminal to the consumer for PIN entry or other input.
- Intuitive ATM-style interface, large 8 line x 21 character backlit display with split screen capabilities, large keys, and extra-size menu prompts simplify training and reduce calls to the help desk.
- Integrated high-speed thermal printer simplifies paper loading and virtually eliminates paper jams.
- Triple-track, high-coercivity card reader handles most magnetic stripe cards.

Countertop Performance in a “Hand-Over” Design

- 32-bit processing and multi-tasking capabilities make short work of payment, payment-related, and value-added applications.
- Exceptional graphics-handling capabilities of display and printer quickly render logos, graphical fonts, and character-based languages.
- VeriCentre Appliance Management Suite employs advanced file compression to streamline simultaneous downloads of application software to hundreds of terminals.
- Integrated PIN pad offers added convenience to handle PIN-based applications.
- Ensures uncompromising reliability from VeriFone, the worldwide leader in e-payment.

True Multi-Application Capability

- 3 MB or 4 MB of memory and the dynamic memory allocation of the Verix V OS, support two or three typical-sized applications on a single terminal.
- Primary smart card reader and the MSAMs safeguard sensitive financial data and support multiple smart card schemes.
- Omni 5xxx series of terminals and SoftPay EMV software have received EMV Level 1 and Level 2 Type approval for smart card solutions. The Verix EMV Library provides efficient development of other EMV-compliant applications.
- VeriShield security architecture meets published specifications for PED and provides sophisticated file authentication, to prevent execution of unauthorized software on Omni 5xxx terminals.

Terminal Setup

This chapter describes the terminal setup procedure. You will learn how to:

- Select a Location and Protect the Terminal From Adverse Environmental Factors.
- Unpack the Shipping Carton.
- Examine Terminal Features.
- Establish Telephone Line Connections.
- Install Paper Roll in the Printer.
- Connect Optional Device(s).
- Connect Terminal Power Pack.
- Conduct Smart Card or Credit/Debit Transactions. See Smart Card Transaction and Magnetic Card Reader Use.

Select Terminal Location

Use the following guidelines while selecting a location for your Omni 5xxx terminal.

Ease of Use

- Select a location convenient for both merchant and cardholder.
- Select a flat support surface, such as a countertop or table.
- Select a location near a power outlet and a telephone/modem line connection. For safety, do not string the power cord in a walkway or place across a walkway on the floor.

Environmental Factors

- Do not use the terminal where there is high heat, dust, humidity, moisture, or caustic chemicals or oils.
- Keep the terminal away from direct sunlight and anything that radiates heat, such as a stove or motor.
- Do not use the terminal outdoors.

CAUTION



The terminal is not waterproof or dustproof, and is intended for indoor use only. Any damage to the unit from exposure to rain or dust may void any warranty.

Electrical Considerations

- Avoid using this product during electrical storms.
- Avoid locations near electrical appliances or other devices that cause excessive voltage fluctuations or emit electrical noise (for example, air

conditioners, electric motors, neon signs, high-frequency or magnetic security devices, or computer equipment).

- Do not use the terminal near water or in moist conditions.



Due to risk of shock or terminal damage, do not use the terminal near water, in a wet basement, bathtub, wash bowl, kitchen sink, laundry tub, or near a swimming pool.

Unpack the Shipping Carton

Open the shipping carton and carefully inspect its contents for possible tampering or shipping damage. The Omni 5xxx is a secure product and any tampering may cause the terminal to cease to function properly.

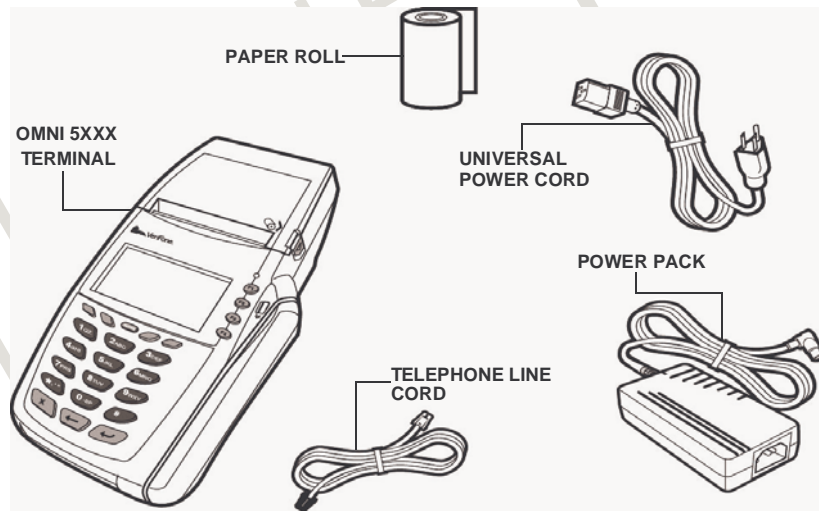

Figure 1 Omni 5xxx Product Components

1 Remove and inspect the following items (see Figure 1):

- Omni 5xxx terminal
- Power pack
- Telephone line cord
- Power cord
- Battery pack
- Paper roll

2 Remove all plastic wrapping from the terminal and other components.

3 Remove the clear protective film from the LCD screen.



Do not use a terminal that has been damaged or tampered with.

The Omni 5xxx terminal comes equipped with tamper-evident labels. If a label or component appears damaged, please notify the shipping company and your VeriFone representative or service provider immediately.

- Save the shipping carton and packing material for future repacking or moving the terminal.

Examine Terminal Features

Before you continue the installation process notice the features of the Omni 5xxx terminal (see Figure 2).

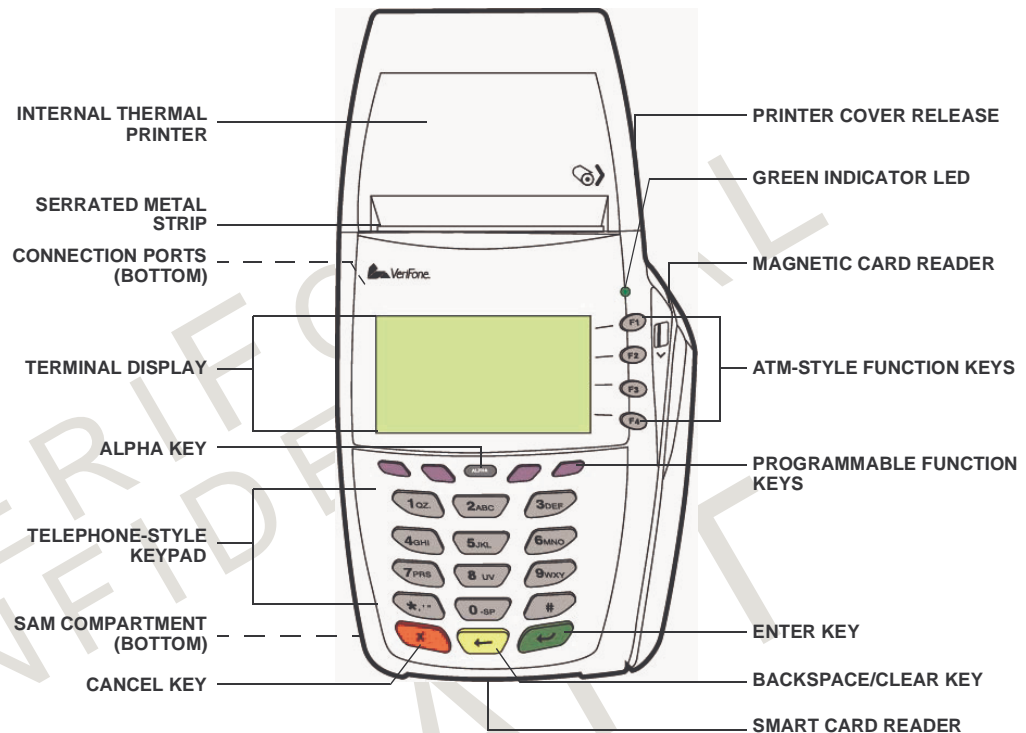



Figure 2 Omni 5xxx Terminal Features (Front Panel)

Front Panel

The front panel includes the following features:

- A **terminal display**, backlit LCD screen.
- Five types of keys:
 - A 12-key, **telephone-style keypad**.
 - Four **ATM-style function keys**, labeled F1 to F4, to the right of the LCD screen.
 - Four unlabeled, **programmable function keys** above the keypad.
 - Three **color-coded function keys** below the keypad (icons at right, left-to-right: CANCEL, BACKSPACE/CLEAR, ENTER).
 - An **ALPHA key** centered at the top of the keypad.
- A **magnetic card reader**, built into the right side. The icon at right shows the proper swipe direction, with the stripe down and facing inward, toward the keypad.
- A green **indicator LED** indicates power is ON.



- An **internal thermal printer**.
- The **smart battery pack** installed in back of unit.
- A **smart card reader**, built into the front of the terminal. The icon shown at right indicates proper card position and insertion direction. 
- A **SAM (security access module) compartment**, built into the bottom of the terminal. The Omni 5xxx terminal contains MSAM cardholders to support multiple stored-value card programs or other merchant card requirements.

NOTE



VeriFone ships variants of the Omni 5xxx terminal for different markets. Your terminal may have a different configuration. The following devices may or may not be present: a smart card reader, or zero or three MSAM cardholders. However, the basic processes described in this guide remain the same, regardless of terminal configuration.

Connection Ports

Turn the terminal upside down to view the connection ports. Notice that the ports are recessed. Different ports are provided to connect the Omni 5xxx to a communications line, optional peripheral devices, and the power supply (see Figure 3).

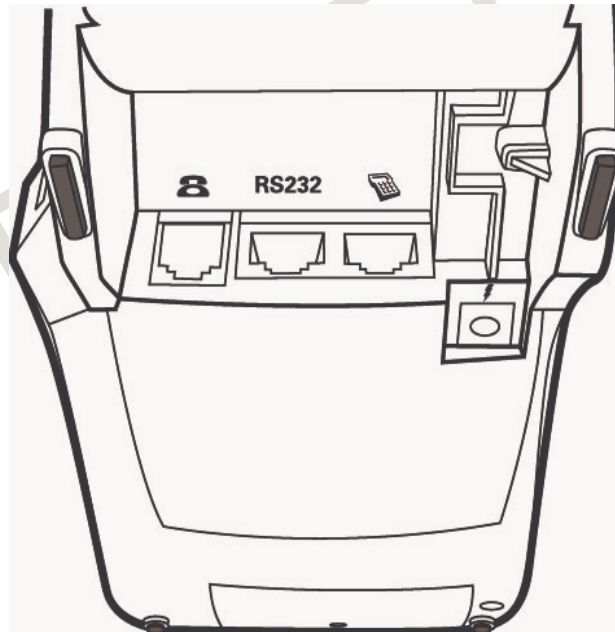



Figure 3 Connection Ports (Bottom View)

- The communications port can be identified by an telephone shaped icon, shown at right. Use this port to connect the Omni 5xxx to a phone line. 
- Two RJ45-type modular jacks (serial ports) are available for attaching optional peripheral devices.

- The RS-232 port, icon shown at right, connects a VeriFone CR 600 check reader, 1000i check reader, or other peripheral device.
- The PIN pad port, icon shown at right, connects a external PIN pad or smart card reader.
- The power connection port uses a round barrel connector. It is identified by the electrical power icon shown at right. Use this port to connect the Omni 5xxx to the power pack to recharge the battery through the unit.

RS232



WARNING



Do not connect the terminal to the power supply until all the peripherals are attached.

Establish Telephone Line Connections

Connect the telephone cord to the communication port on the terminal, then route it directly to a telephone wall jack (see Figure 4). This is a direct connection, and the line is dedicated to the terminal.

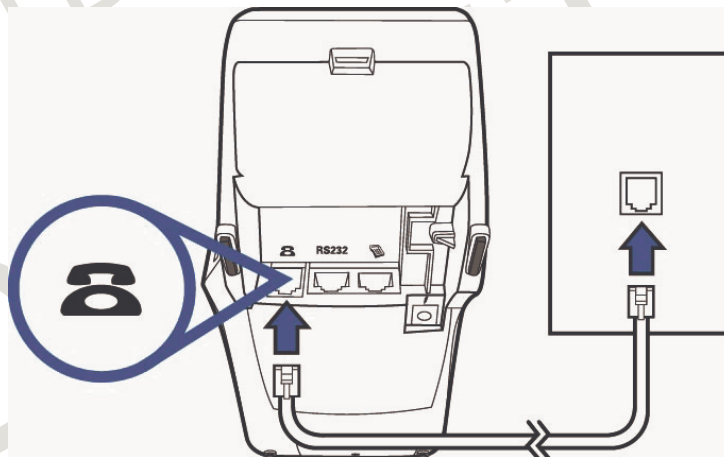

Figure 4 Direct Telephone Connection

WARNING



To reduce the risk of fire, use only No. 26AWG or larger telecommunication line cord.

Install Paper Roll

A fast, quiet thermal printer is built in to the Omni 5xxx terminal.

Before you can process transactions that require a receipt or record, you *must* install a roll of thermal-sensitive paper in the printer.

The ITP uses a roll of single-ply, thermal-sensitive paper 57 millimeters (2.24 inches) wide and 25 meters (82 feet) long. A pink *out-of-paper* indicator line appears on the edge of the paper approximately 18 inches before the end of the roll. After this line appears, there is enough paper remaining on the roll to conclude at least one transaction.



Poor-quality paper can jam printer and create excessive paper dust. To order high-quality VeriFone paper, refer to [Accessories and Documentation](#).

Store thermal paper in a dry, dark area. Handle thermal paper carefully: impact, friction, temperature, humidity, and oils affect the color and storage characteristics of the paper.

Never load a roll of paper with folds, wrinkles, tears, or holes at the edges or in the print area.

To Install a Paper Roll

- 1 Press down on the button located on the side of the terminal to unlatch the paper roll cover, then lift the cover up and back (see Figure 5).

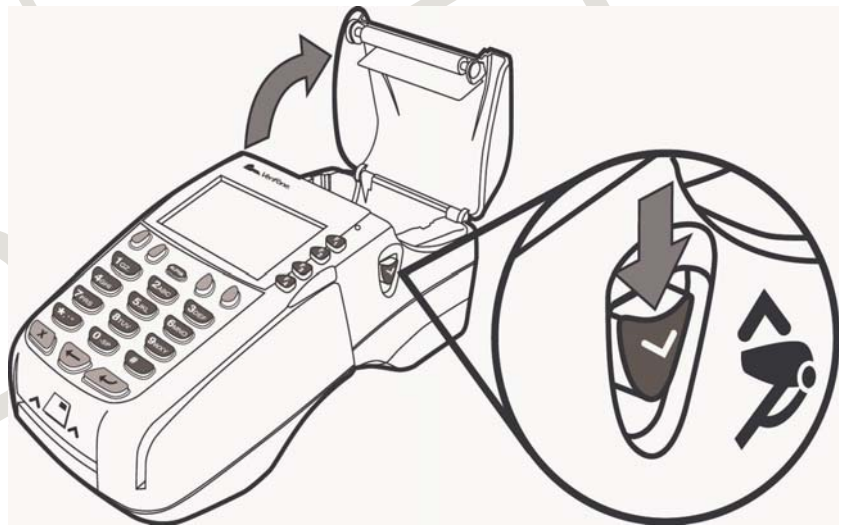

Figure 5 Opening the Printer Cover

- 2 Remove any partial roll of paper in the printer tray by lifting up (see Figure 6).

- 3 Loosen the glued leading edge of the paper or remove the protective strip from the new roll of paper, unwind the paper roll past any glue residue.

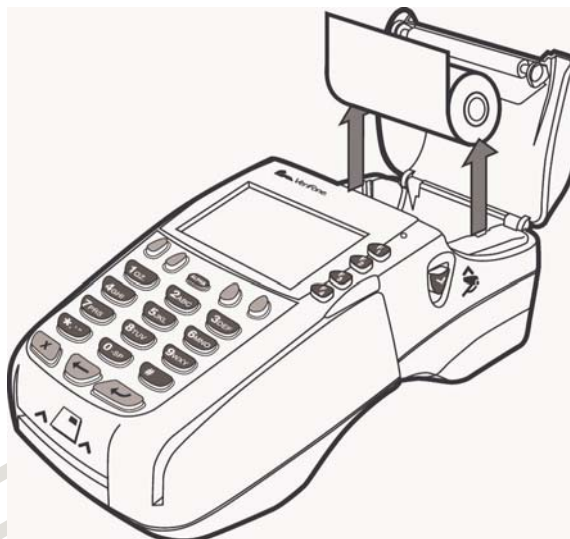

Figure 6 Removing Partial Paper Roll

- 4 Hold the roll so the paper feeds from the *bottom* of the roll (see Figure 7).
- 5 Drop the paper roll into the printer tray.

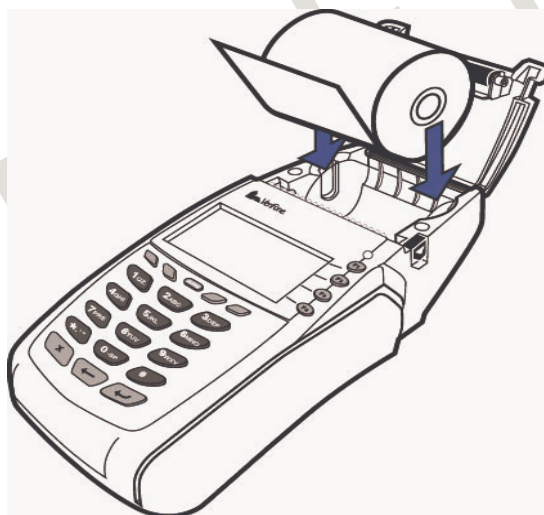

Figure 7 Loading Paper Roll

- 6 Pull paper up past glue residue from printer tray.
- 7 Close the paper roll cover by gently pressing directly on the cover until it clicks shut, allowing a small amount of paper past the glue residue to extend outside the printer door. (see Figure 8).



To prevent the paper roll cover from damaging the print roller, always gently press down on the printer dust cover to close it.

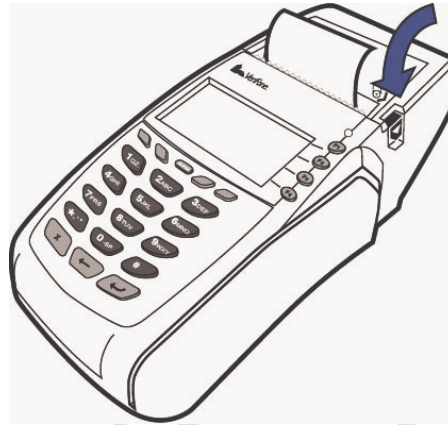

Figure 8 Closing Paper Roll Cover

8 Tear the paper off against the serrated metal strip in the printer.

For paper ordering information, refer to [Accessories and Documentation](#).

Install/Replace MSAM Cards

When you first receive your Omni 5xxx terminal, you may need to install one or more MSAM cards or you may need to replace old cards.



Observe standard precautions for handling electrostatically sensitive devices. Electrostatic discharges can damage this equipment. VeriFone recommends using a grounded anti-static wrist strap.

To change or install MSAMs

- 1 Remove the power cord and/or battery (see [Smart Battery](#)) from the bottom of the terminal.
- 2 Place the terminal upside down on a soft, clean surface to protect the lens from scratches.
- 3 Remove the MSAM compartment door screw and rotate the door up and back to access the MSAM cardholders (see [Figure 9](#)).

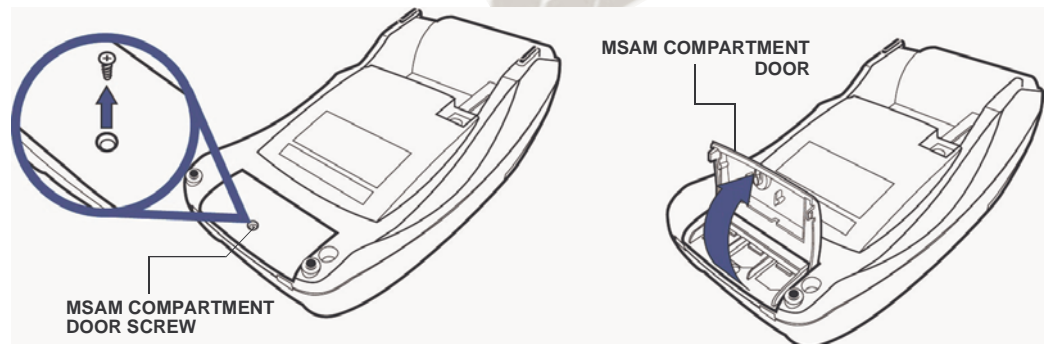

Figure 9 Opening MSAM Compartment Door

- 4 Remove any previously installed MSAM card by sliding the card from the MSAM cardholder.
- 5 Install an MSAM card by aligning the card and carefully sliding it within the guides on the cover until it is fully inserted (see Figure 10).

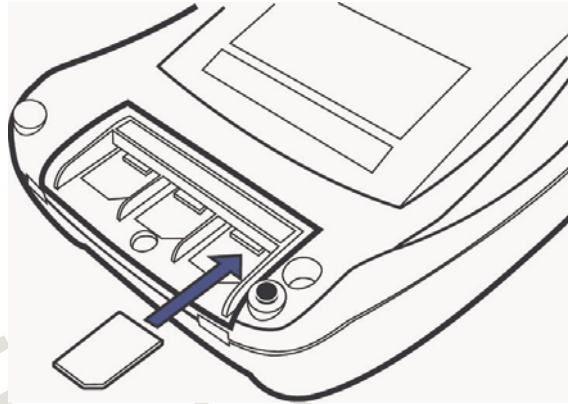

Figure 10 Installing An MSAM Card

NOTE



Before inserting the MSAM card, position it as shown in Figure 10, with the card's gold contacts facing the smart card reader end of the terminal. The cardholder connector base has a set of contacts and a notch on one corner to ensure the MSAM card is positioned correctly. The MSAM card has a notch on one corner to ensure that it fits into the connector base in only one way. The MSAM compartment door will not close properly if the MSAM card(s) are installed incorrectly.

- 6 Replace the MSAM compartment door and reinstall the screw (see Figure 11).

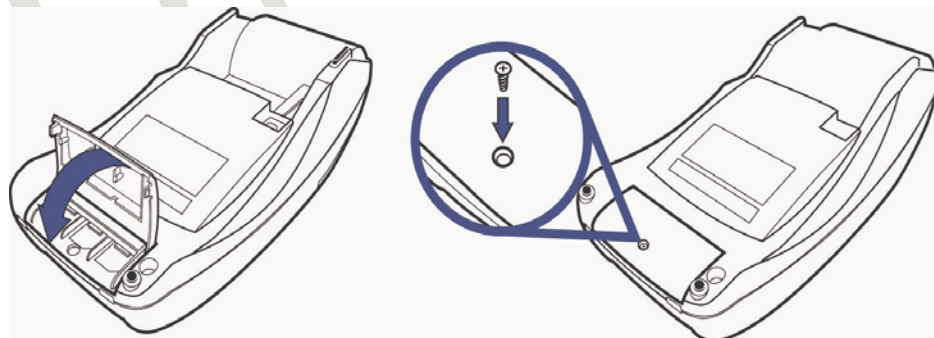

Figure 11 Closing MSAM Compartment Door

**Connect
Optional
Device(s)**

The Omni 5xxx supports some peripheral devices designed for use with electronic point-of-sale terminals.

Use the two ports on the back panel to connect up to two optional devices.



Before connecting any peripheral device, remove the power cord from the bottom of the terminal and ensure that the green indicator LED is not lit. Reconnect the power cord only *after* you are finished connecting the peripheral device(s). For complete information about peripheral installation and use, refer to the user documentation supplied with those devices.

The following sections discuss the most common optional devices supported by this terminal.

Table 3 Optional Devices Supported

Optional Device	Connection Port
CR 600 or CR1000 <i>i</i> (check readers)	RS232
Console	PIN pad
PIN pad	PIN pad
RS-232 Electronic Cash Register	RS232
Smart Card Reader	PIN pad

Other optional devices may be supported. For more information, please contact your VeriFone distributor.

NOTE



RS-232-type devices do not work on the PIN pad port; PIN pad-type devices do not work on the RS-232 port. If an optional peripheral device does not function correctly, check the port connection.

Connect PIN Pad or Smart Card Reader

Use the following procedure to connect a PIN pad or smart card reader.

- 1 Insert the RJ45-type connector on the end of the PIN pad or smart card reader into the port on back of the peripheral device.

To install a PINpad 101, PINpad 201, or PINpad 1000, position and insert the grommet to secure the cable connection.

If a cable is not already connected to the smart card reader or PIN pad, insert the small modular plug on one end of the interface cable into the optional device's modular jack.

- 2 Insert the larger RJ45-type connector on the other end of the PIN pad cable into the PIN pad serial port on the bottom of the terminal.

Figure 12 provides an example of a smart card reader and PIN pad connection to the PIN pad serial port.

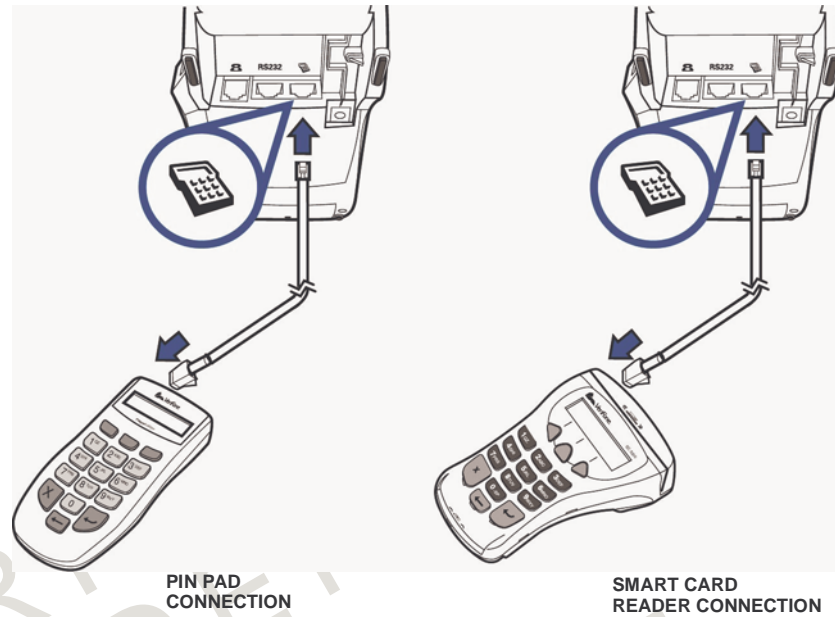

Figure 12 Example PIN Pad Serial Port Connections

Connect Check Reader

The Omni 5xxx terminal supports the CR 600 and CR 1000i check readers. Contact your VeriFone representative or visit the online store at www.store.verifone.com for information on these devices. Figure 13 provides an example of a peripheral connection to the RS-232 port.



Check readers require a separate power source. Before connecting a check reader or similar device, remove the power cord from the bottom of the terminal and ensure that the green indicator LED is not lit.

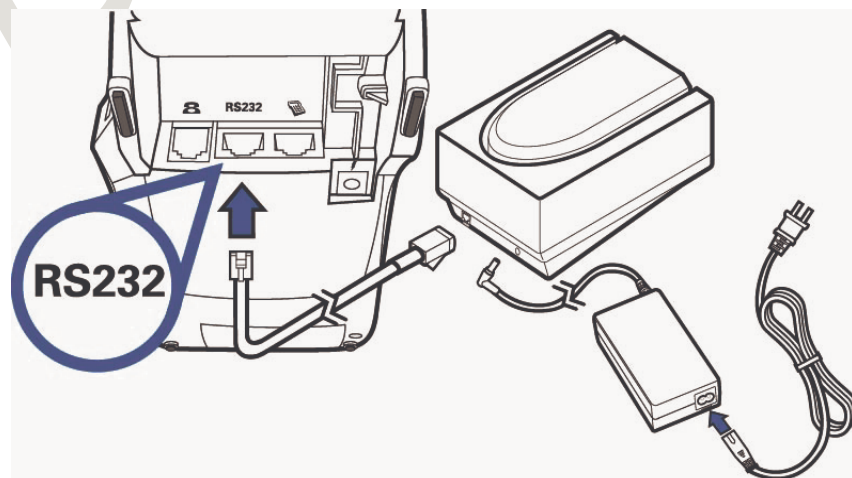

Figure 13 CR 600 Check Reader Connection

External Printers Supported

Although all Omni 5xxx variants have an internal thermal printer, it may be convenient to print larger print runs (for example, daily or weekly reports) to an external printer. The Omni 5xxx terminal supports the VeriFone P250, P350, P900, and P950 external printers. Contact your VeriFone representative or visit the online store at www.store.verifone.com for information on these devices. External printer connections are through the RS-232 port (see Figure 13).

Connect Terminal Power Pack

When you have finished connecting optional peripheral(s), you are ready to connect the Omni 5xxx terminal to the provided or supplied power source.

CAUTION



Only use a VeriFone-supplied power pack. Using an incorrectly rated power supply may damage the terminal or cause it not to work as specified. Before connecting, ensure that the power supply being used to power the terminal matches the requirements specified on the bottom of the terminal. (see Chapter 3, Specifications, for detailed power supply specifications). Obtain the appropriately rated power supply before continuing.

- 1 Insert the round barrel connector (see Figure 14) into the power port, identified by the icon at right.



NOTE



The bottom of the Omni 5xxx has an integrated cable retaining feature to secure the power cord to the terminal.

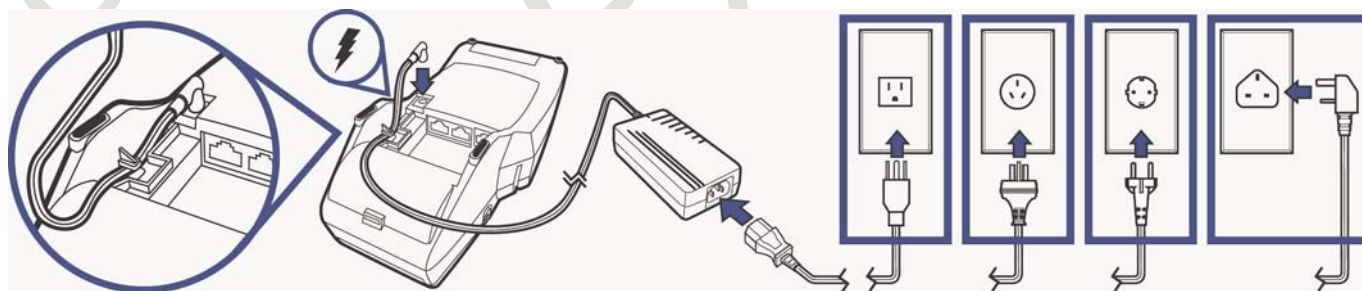

Figure 14 Omni 5xxx Power Pack Connection

- a Route the cable through cable retainer to secure the power cord (see Figure 14).
- 2 Insert the AC power cord into the power pack.
 - 3 Plug the AC power cord into a wall outlet or powered surge protector.

WARNING



Do not plug the power pack into an outdoor outlet or operate the terminal outdoors. Also, disconnecting power during a transaction may cause transaction data files not yet stored in terminal memory to be lost.

NOTE



To protect against possible damage caused by lightning strikes and electrical surges, consider installing a power surge protector.

When the terminal has power, the terminal display lights and the green LED indicator remains lit.

If an application is loaded in the terminal, it starts after the initial VeriFone copyright screen and displays a unique copyright screen. If no application is loaded in the terminal, **DOWNLOAD NEEDED** appears on screen after the initial VeriFone copyright screen.

Smart Battery

The Omni 5xxx wireless terminal uses an Li-ion *smart* battery (see *Accessories and Documentation* for ordering information). The internal logic of the smart battery prevents both overcharging and undercharging (a fault condition in which the battery level goes well below the minimum acceptable charge and the battery becomes unusable).

CAUTION



Note that a new Li-ion battery's full performance is achieved only after two or three complete charge and discharge cycles.

On initial use, allow the Omni 5xxx smart battery to charge 24 hours, then *fully discharge* during normal operation, to ensure reliable battery operation.

The following are features of the smart battery:

- Two Li-ion cells
- A fuel gauge module
 - monitors state of charge (voltage and current),
 - communicates with the terminal (charge parameters and alarms to indicate full discharge),
 - determines full charge capacity (on charge cycle and uninterrupted discharge cycle), and
 - automatically shuts down when cell voltage is extremely low.
- A safety circuit
 - prevents cell damage from overcharge/over-discharge,
 - activates when the battery is left in an unused terminal for extended periods, and
 - resets when battery voltage reaches a preset threshold during the charge cycle.

NOTE



Conserve battery power by turning the Omni 5xxx terminal off when not in use. If the terminal is not to be used for several days, remove the battery from the terminal as it continues to discharge even when the terminal is turned off.

Refer to Spare Smart Battery Pack for smart battery instructions for the Omni 5xxx terminal on the Omni 5xxx terminal.

NOTE



The smart battery pack *must* be installed and holding a minimum of a 1% charge to operate the Omni 5xxx terminal.

Smart Battery Installation

The smart battery installs in a slot on the back of the terminal, as shown in Figure 15. The locking tab clicks when the battery is in place. The slot is *keyed*, so that there is only one way to insert the battery.

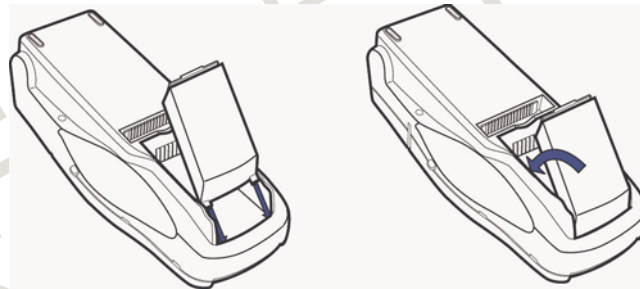

Figure 15 Install the Smart Battery

Smart Battery Removal

To remove the smart battery, press the locking tab at the top of the battery and pull the smart battery from its slot.

Smart Battery Charging

On initial use, the smart battery must be fully charged and *fully discharged* through normal operation. After unpacking your Omni 5xxx terminal, install the battery and connect the power pack to the unit for 24 hours. Disconnect the power pack and allow your Omni 5xxx terminal to remain on until the smart battery completely discharges. Reconnect the power pack to the unit and allow the smart battery to recharge a maximum of 24 hours.

It is also recommended that the smart battery receive a periodic full discharge. To ensure a full discharge, use the unit until the battery is fully drained.

To determine the charge state of the battery, push the “test button” icon (shown in Figure 16) on the bottom of the battery. The bar LED status indicators on the battery each indicate 25% of the charge state. When the battery charge state reaches 10%, the ÷ LED (Figure 16) blinks, indicating a low-charge state. The battery charge state displays at the bottom of the first copyright screen when the terminal is turned on.

NOTE



Conserve battery power by turning the Omni 5xxx terminal off when not in use. If the terminal is not to be used for several days, remove the battery from the terminal as it continues to discharge even when the terminal is turned off.

The smart battery has a safety circuit to protect the Li-ion cells from overcharging and over-discharging. If the battery is over-discharged, the safety circuit shuts down the battery and none of the indicator LEDs (see Figure 16) on the battery pack blink. The battery must then be recharged to restore operation.



The Omni 5xxx terminal automatically shuts off when the smart battery reaches the *critically low* charge state. If this occurs, the smart battery must recharge a minimum of 1/2 hour before it can power the terminal. **It make take several recharge attempts to reset the safety circuit** when charging a smart battery that has reached a critically low charge state.

If the Omni 5xxx terminal is already running an application (for example, SoftPay), a battery status indicator may appear on the display.

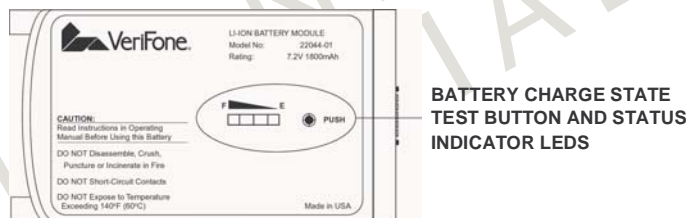

Figure 16 Smart Battery Charge Indicator LEDs and Test Button

Smart Battery Life

To ensure that you get the longest possible performance from the smart battery, it must be allowed to fully discharge periodically. The smart battery can be charged and discharged hundreds of times, but will eventually wear out. When operating times are noticeably shorter than usual, it is time to buy a new battery (see Accessories and Documentation for ordering information).



Do not dispose of batteries in a fire. Li-ion batteries must be recycled or disposed of properly. Do not dispose of Li-ion batteries in municipal waste sites.



Install/Replace SIM Card (GSM models)

The SIM (Subscriber Identity Module) card is a smart card inserted in the Omni 5xxx GSM terminal that contains your GSM radio account information. Use the following procedure to replace or install a SIM card.

- 1 Remove screw from SIM card access door on back of Omni 5xxx terminal (Figure 17).

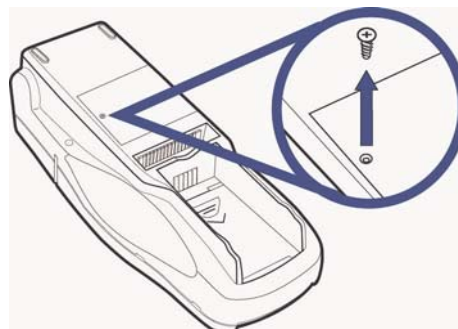

Figure 17 Remove SIM Door Screw

- 2 Remove the SIM card access door (Figure 18):

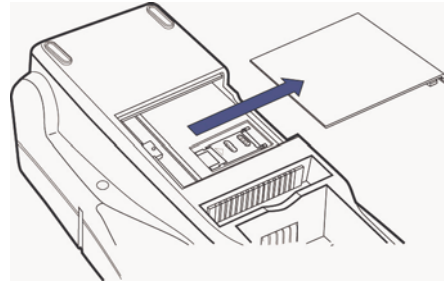

Figure 18 Slide Off SIM Card Access Door

- 3 Open the SIM card holder and slide the SIM card supplied by your provider into the cardholder (Figure 19).

NOTE



Do not lose the SIM card dust cover or retaining screw.



Figure 19 Insert SIM Card into Cardholder

NOTE



The SIM cardholder has a notch on one corner to ensure the SIM card is positioned correctly. The SIM card has a notch on one corner for easy orientation in the cardholder. Before inserting the SIM card, position it as shown in Figure 19, with the card's gold contacts facing down.

- 4 Replace the SIM card access door and screw.

Wireless Transactions

To conduct a wireless transaction:

- Ensure the terminal is in an optimal position for transmitting.
- Follow the on-screen instructions provided with your application.

Smart Card Transaction

The smart card transaction procedure may vary from one application to another. Verify the procedure with your application provider before you perform a smart card transaction.

To Conduct a Smart Card Transaction

- 1 Position a smart card with the contacts facing upward (see Figure 20).
- 2 Insert it into the smart card reader slot in a smooth, continuous motion until it seats firmly.

- 3 Remove the card only when the application indicates the transaction is complete.

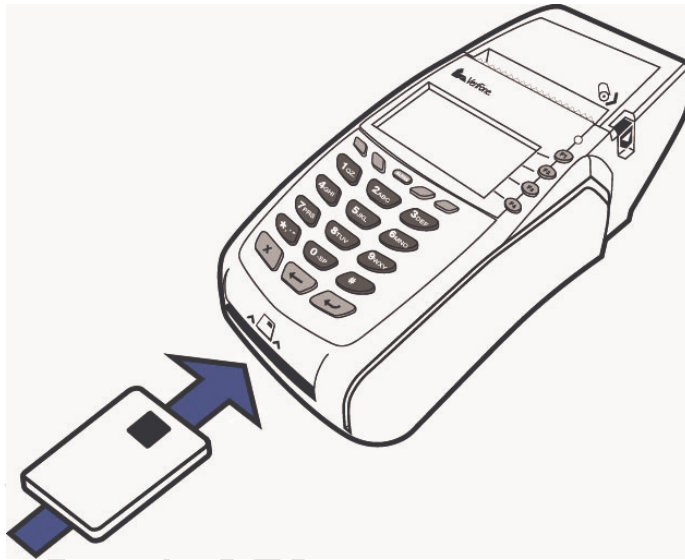

Figure 20 Inserting a Smart Card



Leave the smart card in the card reader until the transaction is complete. Premature card removal will invalidate the transaction.

Magnetic Card Reader Use

The Omni 5xxx supports credit/debit card transactions.

To Conduct a Credit/Debit Card Transaction

- 1 Position a magnetic card with the stripe facing down and in, toward the keypad.
- 2 To ensure a proper read of the magnetic swipe card, the user should insert the magnetic card from the top of the unit, as shown in Figure 21.

- 3 Swipe the card through the magnetic card reader.

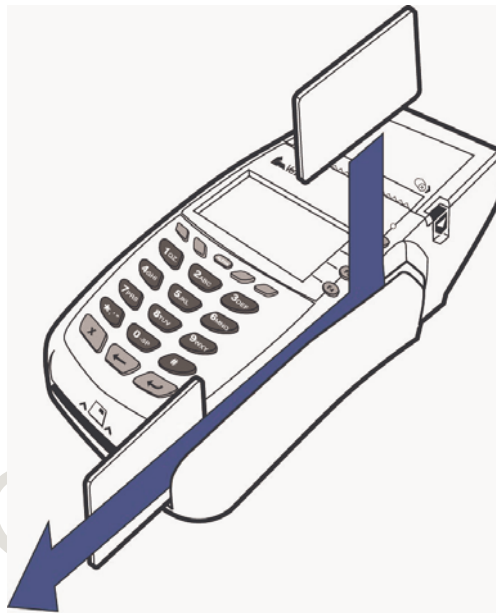

Figure 21 Using the Magnetic Card Reader

Antenna (Some Wireless Models)

For some Omni 5xxx terminals to establish a wireless connection, an external antenna is provided. This connection allows communication with your service provider to upload transaction data from the terminal and download system upgrades to the terminal. Radio service is activated by your service provider.

NOTE



Some Omni 5xxx terminals have an internal antenna and this section can be ignored.

Only use the antenna designed for your unit. Failure to use the proper antenna results in the inability to establish a wireless connection.

CAUTION



Never hold the unit by the antenna; doing so may break the connection and void your warranty.

This section only discusses Omni 5xxx terminals with external antenna.

Installation

The Omni 5xxx should arrive from manufacture with the antenna attached. If unattached, use the following procedure to install the antenna:

- 1 Locate the antenna port on the back side of the Omni 5xxx terminal.
- 2 Align the connector on the end of the antenna with the connector on the end of the terminal.

- 3 Push gently on the center of the base of the antenna until it slides into position.
- 4 Screw the barrel nut finger tight to retain the antenna.

Orientation

To establish good wireless communication (*uplink*), vertically align the antenna always with respect to ground and sky. For example, if standing and holding the terminal horizontally, position the antenna at an approximately 90° angle to the unit (that is, pointing up from the printer). This should point the antenna directly at the sky.

If the unit is on a flat surface (for example, a table top) position the antenna so that it points directly at the sky.

NOTE

If an application (for example, SoftPay) is installed in your Omni 5xxx unit, a signal strength indicator may appear on the display.

Replace the Antenna

If your Omni 5xxx terminal has difficulties completing wireless transactions, you may have to replace the antenna. Use the following procedure to replace the antenna:

- 1 Remove the existing antenna from the Omni 5xxx terminal:
 - a Unscrew the barrel nut to loosen the antenna.
 - b Pull gently on the center of the base of the antenna until it slides out of position.
- 2 Align the connector on the end of the new antenna with the connector on the end of the terminal.
- 3 Push gently on the center of the base of the antenna until it slides into position.
- 4 Screw the barrel nut finger tight to retain the antenna.

VERIFONE
CONFIDENTIAL
DRAFT



Specifications

This chapter discusses power requirements, dimensions, and other specifications of the Omni 5xxx terminal.

Power

Omni 5xxx terminal: 9 V DC; 4 A

DC Power Pack

- UL, ITE listed, Class 2 power supply
 - Input rated: 100 - 240V AC, 50/60 Hz
 - Output rated: 8.6 - 9.4V DC 4.0 A

Barrel connector polarity:



Temperature

- Operating temperature: 0° to 40° C (32° to 104° F)
- Storage temperature: -30° to + 60° C (-22° to 140° F)
- Relative humidity: 5% to 90%; no condensation

External Dimensions

- Length: 209.2 mm (8.2 in)
- Width: 101.8 mm (4.0 in)
- Depth: 72 mm (2.8 in)

Weight

Terminal unit weight: 0.48kg (1.06 lb)

NOTE



CDMA

SAR compliance for body worn operating configurations is limited to the specific belt clips / holsters / accessories that have no metallic component in the assembly. The highest reported SAR values for Omni 5xxx terminals under the FCC ID B32OMNI5600C are: PMS modes (Part 22) - Body-worn 0.567mW/g, PCS modes (Part 24) - Body-worn 0.205mW/g.

GSM/GPRS

SAR compliance for body worn operating configurations is limited to the specific belt clips / holsters / accessories that have no metallic component in the assembly. The highest reported SAR values for Omni 5xxx terminals under the FCC ID B32OMNI5600G are: PMS modes (Part 22) - Body-worn 0.753 mW/g, PCS modes (Part 24) - Body-worn 0.564mW/g.

VERIFONE
CONFIDENTIAL
DRAFT



Maintenance

The Omni 5xxx has no user-maintainable parts.

Clean the Terminal

To clean the terminal, use a clean cloth slightly dampened with water and a drop or two of mild soap. For stubborn stains, use alcohol or an alcohol-based cleaner.



Never use thinner, trichloroethylene, or ketone-based solvents – they may deteriorate plastic or rubber parts.

Do not spray cleaners or other solutions directly onto the keypad or terminal display.

Terminal Contacts

Gently swab the contacts with alcohol or contact cleaner to remove dirt. It is important that the exposed contacts for the battery stay clean and unbent.



Avoid touching the contacts in the raised area in the center of the battery and the recessed area on the terminal. Finger oils tarnish contacts, causing bad connections. If the battery charge state or terminal power LEDs do not light when the terminal is connected to the power supply or there is a high occurrence of bad or incomplete data transfers, clean the contacts.

Card Readers

The magnetic and smart card readers require no regular maintenance. For card reader service, contact your VeriFone distributor or service provider.



Do not attempt to clean the card readers. Doing so may void your warranty.

VERIFONE
CONFIDENTIAL
DRAFT



VeriFone Service and Support

For Omni 5xxx terminal problems, contact your local VeriFone representative or service provider.

For Omni 5xxx product service and repair information:

- USA – VeriFone Service and Support Group, 1-800-VeriFone (837-4366), Monday - Friday, 8 A.M. - 8 P.M., Eastern time
- International – Contact your VeriFone representative

Return a Terminal or Smart Battery for Service

Before returning a Omni 5xxx terminal or smart battery to VeriFone, you must obtain an MRA number. The following procedure describes how to return one or more Omni 5xxx terminals for repair or replacement (U.S. customers only).

NOTE



International customers, please contact your local VeriFone representative for assistance with your service, return, or replacement.

- 1 Gather the following information from the printed labels (see Figure 22 and Figure 23) on *each* Omni 5xxx terminal or smart battery to be returned:
 - Product ID, including the model and part number. For example, “OMNI 5100” and “Pxxx- xxx-xx”
 - Serial number (S/N xxx-xxx-xxx)
- 2 Obtain MRA number(s) by completing one of the following:
 - a Call VeriFone toll-free within the United States at 1-800-VeriFone and follow the automated menu options.
 - Select the MRA option from the automated message. The MRA department is open Monday–Friday, 8 A.M.–8 P.M., Eastern time.
 - Give the MRA representative the information gathered in Step 1. If the list of serial numbers is long, you can fax the list, along with the information gathered in Step 1, to the MRA department at 727-953-4172 (U.S.).
 - b Address a fax to “VeriFone MRA Dept.” with the model and part number(s)
 - Include a telephone number where you can be reached and your fax number.

- c Complete the Inquiry Contact Form at http://www.verifone.com/assistance/pos_assist.cfm.
 - Address the Subject box with to “VeriFone MRA Dept.”
 - Reference the model and part number in the Note box.

NOTE



One MRA number must be issued for each Omni 5xxx terminal you return to VeriFone, even if you are returning several of the same model.

- 3 Describe the problem(s).
- 4 Provide the shipping address where the repaired or replacement unit must be returned.
- 5 Keep a record of the following items:
 - Assigned MRA number(s).
 - VeriFone serial number assigned to the Omni 5xxx terminal or smart battery you are returning for service or repair (terminal serial numbers are located on the bottom of the unit (see Figure 22); smart battery serial numbers on the side of the battery (see Figure 23)).
 - Shipping documentation, such as air bill numbers used to trace the shipment.
 - Model(s) returned (model numbers are located on the VeriFone label on the bottom of the Omni 5xxx terminal).

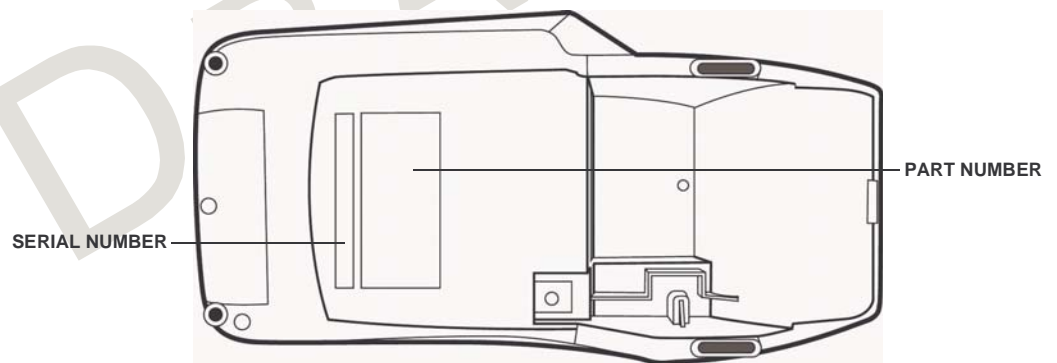

Figure 22 Information Label on Terminal (Bottom View)

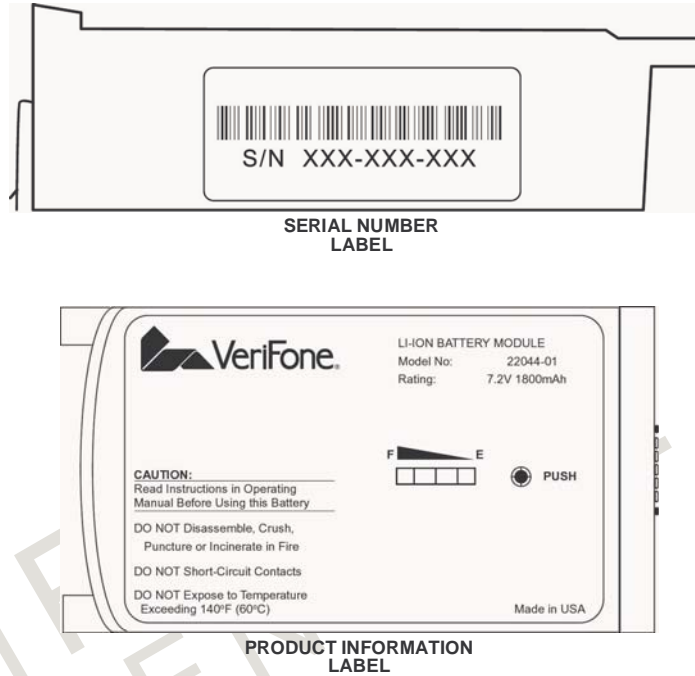

Figure 23 Smart Battery Information Label Locations

Accessories and Documentation

VeriFone produces the following accessories and documentation for the Omni 5xxx terminal. When ordering, please refer to the part number in the left column.

- VeriFone online store at www.store.verifone.com
- USA – VeriFone Customer Development Center, 800-VeriFone (837-4366), Monday - Friday, 7 A.M. - 8 P.M., Eastern time
- International – Contact your VeriFone representative

Power Pack

Contact your local VeriFone distributor to determine which power pack or power cord fits your needs.

CPS10936-3A DC power pack (universal)

21973-01 AC power cord (US)

Thermal Printer Paper

CRM0039-01 CRM0039 in 30-roll bulk package

CRM0040 High-grade thermal printer paper, 57 mm (2.24-inch) width, 25-meter (82-foot) length; single roll; Available in 20-roll or 50-roll bulk packages

VeriFone Cleaning Kit

02746-01 Cleaning Kit

Telephone Line Cord

00124-17 2.1-meter (7-foot) telephone line cord, black, with modular RJ11-type connectors

Swivel Stand	23050-01	Swivel Stand
Documentation	23219	<i>Omni 5xxx Quick Installation Guide</i>
	23218	<i>Omni 5xxx Certifications and Regulations</i>
	23217	<i>Omni 5xxx Reference Manual</i>
	23230	<i>Verix V Operating System Programmer's Manual</i>
	23231	<i>Verix V Tools Programmer's Manual</i>

VERIFONE
CONFIDENTIAL
DRAFT



Troubleshooting Guidelines

The troubleshooting guidelines provided in the following section are included to assist you to successfully install and configure your Omni 5xxx terminal. If you have problems operating your Omni 5xxx terminal, please read through these troubleshooting examples.

If the problem persists even after performing the outlined guidelines or if the problem is not described below, contact your local VeriFone representative for assistance. Typical examples of malfunction you may encounter while operating your Omni 5xxx terminal and steps you can take to resolve them are listed.

NOTE



The Omni 5xxx terminal comes equipped with tamper-evident labels. The Omni 5xxx contains no user serviceable parts. Do not, under any circumstance, attempt to disassemble the terminal. Perform only those adjustments or repairs specified in this guide. For all other services, contact your local VeriFone service provider. Service conducted by parties other than authorized VeriFone representatives may void any warranty.

CAUTION



Using an incorrectly rated power supply may damage the terminal or cause it not to work as specified. Before troubleshooting, ensure that the power supply being used to power the terminal matches the requirements specified on the bottom of the terminal. (See Chapter 3, *Specifications*, for detailed power supply specifications.) Obtain the appropriately rated power supply before continuing with troubleshooting.

Terminal Does Not Start

- Ensure that the smart battery charge state is not below the critically low level.
- Recharge or replace the smart battery.
- Ensure that you pressed the ENTER/ON key for approximately 3 seconds, until the unit lit up.

Terminal Display Does not Show Correct/Readable Info

- Recharge or replace the battery.
- Connect the Omni 5xxx terminal in to a known-good power supply (if you have one) to see if this clears the problem, which points to a discharged battery.

If the problem persists, contact your local VeriFone representative for assistance.

Smart Battery Will Not Charge

The smart battery must initially receive a full charge and then full discharge to calibrate its full charge capacity. This operation is performed at manufacture; however, it is recommended that the battery receive a full charge/discharge once a year.

NOTE

Allow the Omni 5xxx terminal to remain connected to the power pack for a *minimum of 2 hours, maximum of 4 hours* to ensure the battery receives a full charge.

Conserve battery power by turning the Omni 5xxx terminal off when not in use. If the terminal is not to be used for several days, remove the battery from the terminal as it continues to discharge even when the terminal is turned off.

To discharge the smart battery, run the unit until the smart battery is fully drained.

NOTE

The Omni 5xxx terminal automatically shuts off when the smart battery reaches the *critically low* charge state. If this occurs, the smart battery must recharge a minimum of 1/2 hour before it can power the terminal. **It make take several recharge attempts to reset the safety circuit** when charging a smart battery that has reached a critically low charge state.

Blank Display

When the Omni 5xxx terminal display screen does not show correct or clearly readable information:

- Check terminal power connection.
- Remove and reapply power to the terminal.
- Check all cable connections and verify that the telephone line is properly connected.
- If the problem persists, contact your local VeriFone service provider.

Terminal Does Not Dial Out

If the terminal does not dial out:

- Check the telephone line connections.
- Check that the telephone line is working by plugging it into a working telephone and listening for a dial tone.
- Replace the telephone cable that connects the terminal with a cable you know is working correctly.
- If the problem persists, contact your local VeriFone service provider.

Printer Does Not Print

If the printer does not work properly:

- Check battery status or terminal power connection. The printer will not print if there is an insufficient charge remaining in the battery to complete the print operation.
- Check if the printer is out of paper and that the roll is properly installed. Open the paper roll cover and install a new roll of printer paper or ensure that the roll is feeding from the bottom.
- Verify that the printer roller and paper roll dust cover are properly installed.
- If the problem persists, contact your VeriFone distributor or service provider.

Printer Paper Jam

If paper jams inside the printer:

- Press the button on the side of the terminal to unlatch the paper roll cover, then open the cover.
 - Remove the damaged paper from the paper roll and clear the feed mechanism.
 - Install a roll of printer paper, as described in [Install Paper Roll](#).
 - If the problem persists, it may be due to poor paper quality. Install a new roll of higher-quality paper.

WARNING



Poor-quality paper may jam the printer. To order high-quality VeriFone paper, refer to [Accessories and Documentation](#).

Peripheral Device Does Not Work

If any peripheral device (PIN pad or smart card reader) does not work properly:

- Check the power cord connection to the peripheral device.
- Check that the device connected to the proper port has power and is functioning properly. If possible, perform a self-test on the device in question.
- The cable connecting the optional device to the Omni 5xxx terminal serial port may be defective. Try a different serial cable. See [Connect Optional Device\(s\)](#).
- If the problem persists, contact your local VeriFone representative.

Keypad Does Not Respond

If the keypad does not respond properly:

- Check the terminal display. If it displays the wrong character or nothing at all when you press a key, follow the steps outlined in [Transactions Fail To Process](#).
- If pressing a function key does not perform the expected action, refer to the user documentation for that application to ensure you are entering data correctly.
- If the problem persists, contact your local VeriFone representative.

Transactions Fail To Process

There are several reasons why the terminal may not be processing transactions. Use the following steps to troubleshoot failures.

Check Magnetic Card Reader

- Perform a test transaction using one or more different magnetic stripe cards to ensure the problem is not a defective card.
- Ensure that you are swiping cards properly. With the Omni 5xxx card reader, the black magnetic stripe on the card should face down and in toward the keypad and be inserted from the top of the terminal (see [Figure 21](#)).
- Process a transaction manually, using the keypad instead of the card reader. If the manual transaction works, the problem may be a defective card reader.

- Contact your VeriFone distributor or service provider.
- If the manual transaction does not work, proceed to [Check Telephone Line](#).

Check Smart Card Reader

- Perform a test transaction using several different smart cards to ensure the problem is not a defective card.
- Ensure that the card is inserted correctly and that the card is not removed prematurely.
- Ensure the MSAM cards are properly inserted in the cardholders and that the cardholders are properly secured (see [Install/Replace MSAM Cards](#)).
- Contact your VeriFone distributor or service provider.
- If the manual transaction does not process, proceed to [Check Telephone Line](#).

Check Telephone Line

- Disconnect the telephone line from the bottom of the Omni 5xxx terminal and connect it to a working telephone to check for a dial tone. If there is no dial tone, replace the telephone cable.
- If the problem appears to be with the telephone line, check with the party you are trying to call to see if their system is operational. If they are not experiencing difficulties with their line, contact the telephone company and have your line checked.
- If the telephone line works, contact your local VeriFone representative for assistance.



VeriFone, Inc.
2455 Augustine Drive
Santa Clara CA 95054-3002
Tel: (800) VeriFone (837-4366)
www.verifone.com

VERIFONE
CONFIDENTIAL
DRAFT



Omni 5xxx

Installation Guide

