

UX400 CTLS Reader

Installation Guide

UX400 CTLS Reader Installation Guide
© 2013 VeriFone, Inc.

All rights reserved. No part of the contents of this document may be reproduced or transmitted in any form without the written permission of VeriFone, Inc.

The information contained in this document is subject to change without notice. Although VeriFone has attempted to ensure the accuracy of the contents of this document, this document may include errors or omissions. The examples and sample programs are for illustration only and may not be suited for your purpose. You should verify the applicability of any example or sample program before placing the software into productive use. This document, including without limitation the examples and software programs, is supplied "As-Is."

VeriFone, the VeriFone logo, Omni, VeriCentre, Verix, and ZonTalk are registered trademarks of VeriFone. Other brand names or trademarks associated with VeriFone's products and services are trademarks of VeriFone, Inc.

All other brand names and trademarks appearing in this manual are the property of their respective holders.

Comments? Please e-mail all comments on this document to your local VeriFone Support Team.

VeriFone, Inc.
2099 Gateway Place, Suite 600
San Jose, CA, 95110 USA

www.verifone.com



CONTENTS

	PREFACE	5
	Audience	5
	Organization	5
	Related Documentation	5
	Conventions and Acronyms	6
	Document Conventions	6
	Acronym Definitions	7
Device Overview	Features and Benefits	9
	Exceptional Ease of Use	9
	Compliance	9
	Contactless Capabilities	10
Setup	Selecting Reader Location	11
	Environmental Factors	11
	Unpacking the Shipping Carton	12
	Examining the CTLS Reader Features	13
	Front Functions	13
	Back Functions	13
	Connecting Unit to a Controlling Device	14
	Contactless Support	14
	Mounting the Reader	15
	Using the Reader	16
	Conducting a Contactless Transaction	16
Specifications	Power Requirements	17
	Power Consumption	17
	Temperature	17
	External Dimensions	17
	Weight	17
	CTLS Card Reader	17
	Peripheral Ports	17
	Communication	17
Maintenance and Cleaning	Additional Safety Information	19
	Potentially Explosive Environments	19
Service and Support	Service Returns	21
	Accessories and Documentation	23
	Cables	23
	Cleaning Kit	23
	Documentation	23
Troubleshooting Guidelines	Transactions Fail to Process	25



This guide is the primary source of information for setting up and installing the UX400 CTLS Reader.

Audience

This guide describes the CTLS reader's features, and provides the basic information for its installation and configuration.

Organization

This guide is organized as follows:

Chapter 1, Device Overview. Provides an overview of the reader.

Chapter 2, Setup. Explains setup and installation of the device, selecting a location, and establishing connections with other devices.

Chapter 3, Specifications. Discusses the power requirements and dimensions of the CTLS device.

Chapter 4, Maintenance and Cleaning. Explains maintenance of the CTLS device.

Chapter 5, Service and Support. Provides information on contacting your VeriFone service provider and information on how to order accessories or documentations from VeriFone.

Chapter 6, Troubleshooting Guidelines. Provides troubleshooting guidelines should you encounter a problem with unit installation and configuration.

Related Documentation

To learn more about the reader, refer to the following set of documents and their associated VeriFone Part Numbers (VPNs).

UX400 CTLS Reader Certifications and Regulations Sheet	VPN - DOC159-031-EN-A
UX400 CTLS Reader Quick Installation Guide	VPN - DOC159-032-EN-A
UX400 CTLS Reader Reference Guide	VPN - DOC159-034-EN-A
UX300 Manual Card Reader Certifications and Regulations Sheet	VPN - DOC159-021-EN-A
UX300 Manual Card Reader Quick Installation Guide	VPN - DOC159-022-EN-A
UX300 Manual Card Reader Installation Guide	VPN - DOC159-023-EN-A
UX300 Manual Card Reader Reference Guide	VPN - DOC159-024-EN-A



Conventions and Acronyms

This section describes the conventions and acronyms used in this guide.

Document Conventions

Various conventions are used to help you quickly identify special formatting. Table 1 describes these conventions and provides examples of their use.

Table 1 Document Conventions

Convention	Meaning	Example
Blue	Text in blue indicates terms that are cross referenced.	See Conventions and Acronyms .
<p>NOTE</p> 	The pencil icon is used to highlight important information.	If exchanging cables use a VeriFone-approved cable.
<p>CAUTION</p> 	The caution symbol indicates possible hardware or software failure, or loss of data.	Avoid placing metallic objects at the front of the card reader
<p>WARNING</p> 	The lightning symbol is used as a warning when bodily injury might occur.	For safety, do not string cables or cords across a walkway.

Acronym Definitions Various acronyms are used in place of the full definition. [Table 2](#) presents acronyms and their definitions.

Table 2 Acronym Definitions

Acronym	Definitions
CTLS	Contactless
EMV	Europay, MasterCard and Visa; a global standard of IC
IC	Integrated Circuit
LED	Light-Emitting Diode
MRA	Merchandise Return Authorization
NFC	Near Field Communication
RF	Radio Frequency
RJ-45	Registered Jack 45 modular connector
Single CI	Single Contactless Interface
SMA	SubMiniature version A connector. A semi-precision coaxial RF connector. See RF .
SPI	Serial Peripheral Interface



Device Overview

This chapter provides a brief description of VeriFone's UX400 CTLS Reader.

The device is a contactless payment device that works with the UX300 host device. The reader supports transactions in a variety of environments, specifically outdoor and unattended markets.

Features and Benefits

The UX400 is VeriFone's contactless acceptance peripheral device, designed to connect to the UX300 unit. It creates an economical solution for merchants who are looking to expand their payment acceptance options. The contactless card reader allows a customer to quickly pay for items using their contactless card and tapping it near, or on the device, thus completing their transaction with speed and ease, without further input.

Exceptional Ease of Use

The following features of the device simplifies transactions in various environments:

- Integrated proximity sensors for system wake-up from low power mode with card presence.
- CTLS logo placement on device for optimized user experience.
- Bright LEDs to display card transaction progress.



The implementation of the LED color configuration varies by (or may not be present in some) regional locations.

- Buzzer for audio confirmation of contactless transactions.
- Compact, sleek, and stylish shape.
- Quick and easy to use.
- Rugged and reliable design.
- Conducive design supports payment transactions in a variety of payment situations, such as transportation, vending, and kiosk environments.

Compliance

The following EMVCo features of the device ensure secure contactless transactions:

- EMV CTLS Level 1 and Level 2 Type Approval

Contactless Capabilities

The device includes the following contactless capabilities:

- VeriFone's advanced contactless architecture future-proofs your investment with Single Contactless Interface (SingleCI), and side-by-side application architecture systems.
- Supports contactless cards as well as NFC phones, supporting the following protocols:
 - ISO 14443 A&B
 - MiFare (MiFare + / DESfire)
 - ISO 18092 Active Communications (NFC — peer-to-peer mode)
 - FeliCa
 - PayPass
 - payWave

Setup

This chapter describes the setup procedure for the contactless reader, in the following sections:

- Selecting Reader Location
- Unpacking the Shipping Carton
- Examining the CTLS Reader Features
- Connecting Unit to a Controlling Device
- Contactless Support
- Mounting the Reader
- Using the Reader

Selecting Reader Location

Use the following guidelines when selecting a location for your reader:

- Select a location convenient for the customer.
- Select a location near the device that will be connected to the contactless unit.

WARNING



For safety, do not string cables or cords across a walkway.

CAUTION



Avoid placing metallic objects at the front of the card reader.

Environmental Factors

The front panel of the device is dustproof and designed for any rainfall to run off of it, as well as fade-proof from sun exposure, according to IP65 ratings.

Unpacking the Shipping Carton

Open the shipping carton and carefully inspect its contents for possible tampering or shipping damage.

The shipping carton comes with the following:

- The UX400 contactless reader
- 1 SMA (RF) cable
- 1 RJ45 host communication connector

To unpack the shipping carton

1 Remove the unit from the shipping carton. The standard package contains:

- CTLS unit
- 1 SMA coaxial cable
- 1 communication cable for communicating with the UX300 card reader.

Refer to [Accessories and Documentation](#) for more information about the device's related accessories.

2 Remove any protective wrap before mounting the unit.

CAUTION



Remove any protective plastic over the front display before use, or the unit may not work properly.

3 Save the shipping carton and packing material for future repacking or moving of the device.

WARNING



Do not use a unit that has been damaged.

If a label or component appears damaged, please notify the shipping company and your VeriFone service provider immediately.

Examining the CTLS Reader Features

Before you continue the installation process, notice the features of the reader (see Figure 1 and Figure 2).

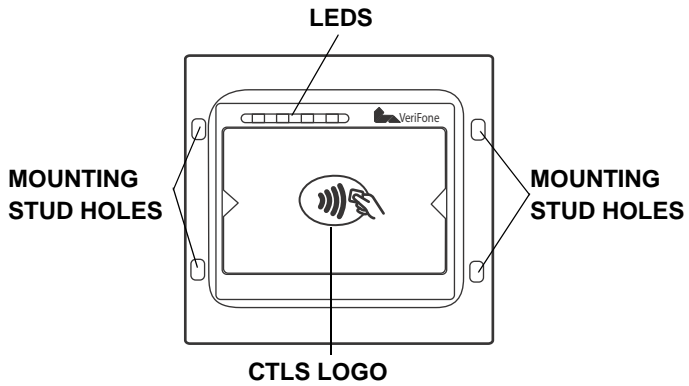

Figure 1 UX400 Front View

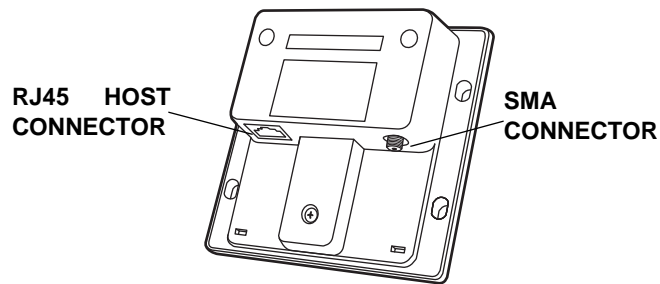

Figure 2 UX400 Rear View

Front Functions The front of the contactless device shows the following:

- Customer-view **indicator LEDs**
- The **CTLS logo**
- **Mounting stud holes**

Back Functions The rear of the contactless device shows the following connectors:

- **RJ-45** host communication connector
- **SMA** (RF) antenna connector

Connecting Unit to a Controlling Device

The device's rear panel has two ports for connection to the UX300 controlling device:

- RJ45–8-pin host connector
- SMA connector

Both connections are necessary for using the contactless unit.



The cables used to connect to the UX300 unit are: CBL159-302-02-X for SMA connection, and CBL159-301-01-X for data connection.

See [Accessories and Documentation](#) for cable ordering information.

To connect to the UX300

- 1 Connect the RJ-45 plug to the rear of the contactless unit.
- 2 Connect the 8-pin connector to the UX300 unit.
- 3 Screw in the SMA connector to the rear of the contactless unit.
- 4 Screw in the SMA connector the UX300 unit.

For further cabling instructions, see [Figure 3](#)

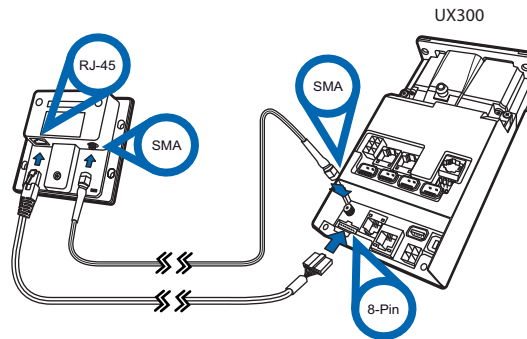

Figure 3 UX400 – UX300 Cabling Connections



To disconnect cables, use the same steps described above in reverse. If exchanging cables, use a VeriFone-approved cable. See [Accessories and Documentation](#) for cable ordering information.

Contactless Support

This device supports the global contactless program specifications from American Express, MasterCard, Visa, Discover, ISIS SmartTap, and Google Wallet with virtually no changes to existing payment hardware or software.

Mounting the Reader

The reader is designed to be flush-mounted to the mounting surface, without further need for any external mounting devices.

CAUTION



Ensure that your mounting frame has a thickness of 2 mm.

NOTE



Your mounting surface may have different installation instructions. Refer to your mounting device's user guide for further instructions.

To mount the CTLS device

- 1 Peel off the plastic liner from the front of the unit.
- 2 Align the unit's stud holes with the stud holes of your mounting surface.
- 3 Flush-mount the reader and secure the unit with M5 nuts.

CAUTION



Avoid placing metallic objects at the front of the card reader.

NOTE



Use M5 mounting studs with a minimum length of 12 mm.

Tighten the nuts using a recommended tightening torque of 7.0 kgfcm.

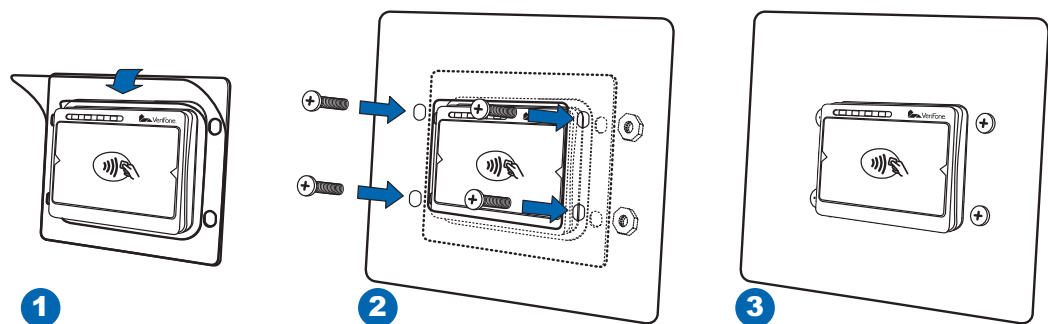



Figure 4 Mounting the Reader

Using the Reader

The contactless reader is only active when signaled by an application for the conduction of a contactless card transaction.

When active, the device's contactless logo lights up.

Conducting a Contactless Transaction

To conduct a contactless transaction, hold the card (within 4 cm) or gently tap against the surface of the contactless antenna, marked by the logo .

The contactless unit uses various audible and visual confirmations to confirm transactions.

NOTE



The actual audible and visual confirmations may vary depending on regional and customer requirements.

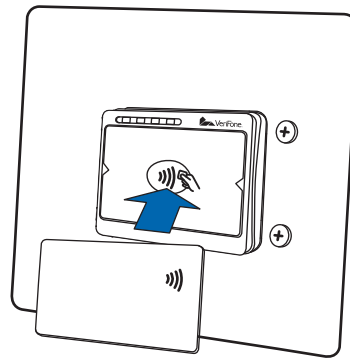

Figure 5 Conducting a Contactless Transaction

Specifications

This chapter discusses power requirements, dimensions, and other specifications of the contactless reader.

- Power Consumption**
- Power consumption mode: 450mW, maximum
 - Sleep mode: 0.3W

- Temperature**
- Operating temperature: -20°C – 70°C (-4°F – 158°F)
 - Storage temperature: -25°C – 70°C (-13°F – 158°F)
 - Relative humidity: 5% to 90% RH non-condensing

NOTE



If this device is to be used in the Nordic countries, or in any environment where the temperature range exceeds the product's operating temperature, it is the responsibility of the integrators to ensure that the ambient environment is controlled in such a way to ensure that the product operates within the specified temperature range.

- External Dimensions**
- Length: 96 mm (3.78 in)
 - Width: 99 mm (3.9 in)
 - Depth: 46 mm (1.81 in)

- Weight**
- Unit weight: 142 gr (5 oz)

- CTLS Card Reader**
- 4 LEDs for CTLS indications

- Peripheral Ports**
- RJ45 host communication port
 - SMA (RF) antenna

- Communication**
- SPI:
 - I²C:



Maintenance and Cleaning

Your contactless device is a product of superior design and craftsmanship and should be treated with care. It has no user-serviceable parts.

The following suggestions will help you protect your warranty coverage.

- Do not store the device in hot areas. High temperatures can shorten the life of electronic devices, damage batteries, and warp or melt certain plastics.
- Do not store the device in cold areas. When the device returns to its normal temperature, moisture can form inside the device and damage electronic circuit boards.
- Do not drop, knock, or shake the device. Rough handling can break internal circuit boards and fine mechanics.
- Do not use harsh chemicals, cleaning solvents, or strong detergents to clean the device. Use only a soft, clean, dry cloth for cleaning.

These suggestions apply equally to your contactless device, or any of its attachments or accessories. If your device is not working properly, take it to the nearest VeriFone-authorized service provider for servicing or replacement.



Never use thinner, trichloroethylene, or ketone-based solvents – they can deteriorate plastic or rubber parts.

Additional Safety Information

The following is additional information for your safety in using this device.

Potentially Explosive Environments

When using the device in areas with potential risk of explosion, such as petrol stations, follow the advice of all signs and instructions. If there has been a leak, do not use this device.



Service and Support

For UX400 problems, contact your local VeriFone representative or service provider.

For device product service and repair information:

- USA – VeriFone Service and Support Group, 1-800-834-4366, Monday - Friday, 8 A.M. - 8 P.M., eastern time.
- International – Contact your VeriFone representative.

Service Returns

Before returning the CTLS reader to VeriFone, you must obtain a Merchandise Return Authorization (MRA) number. The following procedure describes how to return one or more CTLS units for repair or replacement (U.S. customers only).



NOTE

International customers, please contact your local VeriFone representative for assistance with your service, return, or replacement.

- 1 Gather the following information from the printed labels (see [Figure 6](#)) on the bottom of each unit to be returned:
 - Product ID, including the model and part number. For example, “M159-400-xx-WWB” and “PTID xxxxxxxx.”
 - Serial number (S/N xxx-xxx-xxx).
- 2 Within the United States, call VeriFone toll-free at 1-800-834-4366.
- 3 Select the MRA option from the automated message. The MRA department is open Monday–Friday, 8 A.M.–8 P.M., eastern time.

- 4 Give the MRA representative the information gathered in [Step 1](#).
If the list of serial numbers is long, you can fax the list, along with the information gathered in [Step 1](#), to the MRA department at 1-727-953-4172 (U.S.).
 - Please address the fax clearly to the attention of the “VeriFone MRA Dept.”
 - Include a telephone number where you can be reached and your fax number.
 - You will be issued MRA number(s) and the fax will be returned to you.



One MRA number must be issued for each unit you return to VeriFone, even if you are returning several of the same model.

- 5 Describe the problem(s) and provide the shipping address where the repaired or replacement unit must be returned.
- 6 Keep a record of the following items:
 - Assigned MRA number(s).
 - VeriFone serial number assigned to the unit you are returning for service or repair (serial numbers are located on the bottom of the unit, see [Figure 6](#)).
 - Shipping documentation, such as air bill numbers used to trace the shipment.
 - Model(s) returned (model numbers are located on the VeriFone label on the bottom of the unit).

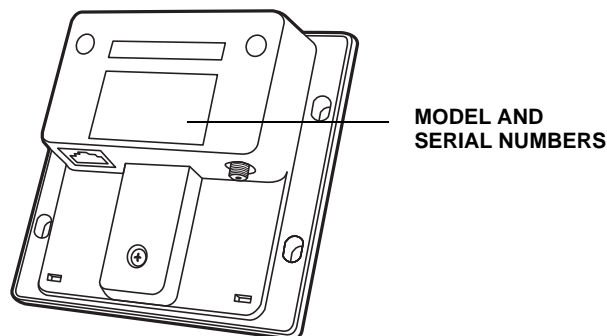

Figure 6 Information Labels on Unit Bottom

Accessories and Documentation

VeriFone produces accessories and documentation for the contactless reader. When ordering, please refer to the part number in the left column.

VeriFone Online Store at www.store.verifone.com

- USA – VeriFone Customer Development Center, 1-800-834-4366, Monday - Friday, 7 A.M. - 8 P.M., eastern time
- International – Contact your VeriFone representative

Cables

The following cables can be used with the CTLS unit. Contact your local VeriFone distributor to determine which cable fits your needs:

CBL159-301-01-X	RJ-45–8-pin connector. UX300–UX400 host communication cable.
CBL159-302-01-X	SMA connector. RF coaxial cable connector from the UX400 to UX300.

Various others, depending on what they connect to. Contact your local VeriFone representative or service provider to identify the best cable for your needs.

Cleaning Kit

02746	VeriFone Cleaning Kit
-------	-----------------------

Documentation

UX400 CTLS Reader Certifications and Regulations Sheet	VPN - DOC159-031-EN-A
UX400 CTLS Reader Quick Installation Guide	VPN - DOC159-032-EN-A
UX400 CTLS Reader Reference Guide	VPN - DOC159-034-EN-A
UX300 Manual Card Reader Certifications and Regulations Sheet	VPN - DOC159-021-EN-A
UX300 Manual Card Reader Quick Installation Guide	VPN - DOC159-022-EN-A
UX300 Manual Card Reader Installation Guide	VPN - DOC159-023-EN-A
UX300 Manual Card Reader Reference Guide	VPN - DOC159-024-EN-A

Troubleshooting Guidelines

This chapter lists possible malfunctions that may occur while operating a UX400 device and the appropriate corrective action. If the problem persists - even after performing the outlined guidelines, or if the problem is not described, contact your local VeriFone representative for assistance.

NOTE



The unit comes equipped with tamper-evident labels. The reader contains no user-serviceable parts. Do not, under any circumstance, attempt to disassemble the unit. Perform only those adjustments or repairs specified in this guide. For all other services, contact your local VeriFone service provider. Service conducted by parties other than authorized VeriFone representatives may void any warranty.

CAUTION



Not all units require use of a power supply.

Using an incorrectly rated power supply may damage the unit or cause it not to work properly. Before troubleshooting, ensure that the power supply used to power the unit matches the requirements specified on the back of the unit (see [Specifications](#) for detailed power supply specifications). If not, obtain the appropriately rated power supply before continuing with troubleshooting.

Transactions Fail to Process

If a contactless transaction fails to process:

- Perform a test transaction using one or more different contactless cards to ensure the problem is not a defective card.
- Ensure that you are conducting the contactless transaction properly (see [Using the Reader](#)).
- Ensure that all cables and external power connections are connected properly to the contactless unit and all external devices (see [Connecting Unit to a Controlling Device](#)).
- If the problem persists, contact your local VeriFone representative.



VeriFone, Inc.
2099 Gateway Place, Suite 600
San Jose, CA, 95110 USA
Tel: (800) VeriFone (837-4366)
www.verifone.com

UX400 CTLS Reader

Installation Guide





2099 Gateway Place, Suite 600
 San Jose CA 95110
 Tel: 800 VeriFone (837-4366)
 www.verifone.com

UX400 CTLS Reader Certifications and Regulations

Electrical

The reference input power rating for the UX400 CTLS Reader is 450mW max.

Location – Electrical Considerations

Do not install this device near electrical appliances or other devices that cause excessive voltage fluctuations or emit electrical noise (for example: air conditioners, neon signs, electric motors, high-frequency or magnetic security devices).

WARNING! This device contains sensitive electronic components that can be permanently damaged if exposed to excessive shock, electrical interference or vibration.

Equipment

Repairs

Do not, *under any circumstances*, attempt any service, adjustments, or repairs on this equipment. Instead, contact your local VeriFone distributor or service provider for assistance. Failure to comply may void the product warranty.

Damage

Carefully inspect the shipping carton and its contents for any damage. If the UX400 CTLS Reader or any product component appears damaged or tampered, immediately notify the shipping company and your VeriFone distributor or service provider.

Do not use a device that has been damaged or tampered with.

Cleaners and Solvents

Never use thinner, trichloroethylene, or ketone-based solvents to clean the device — they may deteriorate the plastic and rubber parts. For best results, use a clean cloth dampened with water and mild soap. To remove stubborn stains, use alcohol or an alcohol-based cleaner.

FCC Compliance

The following product has been tested and certified as compliant with the regulations and guidelines set forth in Part 15 of FCC Rules:

Manufacturer: VeriFone, Inc.
 Brand, Model: UX400 CTLS Reader

Part 15 of FCC Rules

This device complies with the limits for a Class B digital device as specified in Part 15 of FCC Rules which provide reasonable protection against harmful interference in a residential area.

This device complies with Part 15 of the FCC Rules.

Operation is subject to the following two conditions:

- 1 This device may not cause harmful interference; and,
- 2 This device must accept any interference received, including interference that may cause undesired operation.

This equipment generates and uses radio frequency energy, and if not installed and used in accordance with the instructions, may cause harmful interference to radio communications. However, there is no guarantee that interference will not occur in a particular installation.

In the unlikely event that there is interference to radio or television reception (which can be determined by turning the equipment off and on), the user is encouraged to try to correct the interference by one or more of the following measures:

- Increase the separation between the equipment and receiver.
- Connect the equipment into an outlet on a circuit different from that to which the receiver is connected.
- Consult with the dealer or ask an experienced radio/TV technician for help.

Any changes or modifications to this equipment not expressly approved by VeriFone could void the user's authority to operate this equipment. The antenna(s) used for this transmitter must not be co-located or operating in conjunction with any other antenna or transmitter. Use of a shielded interface cable is required to comply with the Class B limits of Part 15 of FCC Rules.

RF Exposure

This device was verified for RF exposure. To comply with Council Recommendation 1999/519/EC, IC RSS-102, and FCC RF exposure requirements, a minimum separation distance of 20 cm must be maintained between the user's body and the device, including the antenna. Any metallic components should be far from this device. Conditions that do not meet these requirements may not comply with Council Recommendation 1999/519/EC, IC RSS-102 and FCC RF exposure requirements and should be avoided.

To comply with the FCC RF exposure compliance requirements, make sure to use only the antenna that is included with the device. This device and its antenna must not be in the same location or operating in the same area in conjunction with any other antenna or transmitter.

Legal Terms and Conditions Regarding PCI SSC Approvals

PCI SSC's approval only applies to PEDs that are identical to the PED tested by a PCI Security Standards Council recognized laboratory. If any aspect of the PED is different from that which was tested by the laboratory - even if the PED conforms to the basic product description contained in the letter, then the PED model should not be considered approved, nor promoted as approved. For example, if a PED contains firmware, software, or physical construction that has the same name or model number as those tested by the laboratory, but in fact are not identical to those PED samples tested by the laboratory, then the PED should not be considered or promoted as approved.

No vendor or other third party may refer to a PED as "PCI Approved," nor otherwise state or imply that PCI SSC has, in whole or part, approved any aspect of a vendor or its PEDs, except to the extent and subject to the terms and restrictions expressly set forth in a written agreement with PCI SSC, or in an approval letter. All other references to PCI SSC's approval are strictly and actively prohibited by PCI SSC.

When granted, an approval is provided by PCI SSC to ensure certain security and operational characteristics important to the achievement of PCI SSC's goals, but the approval does not under any circumstances include any endorsement or warranty regarding the functionality, quality, or performance of any particular product or service. PCI SSC does not warrant any products or services provided by third parties. Approval does not, under any circumstances, include or imply any product warranties from PCI SSC, including, without limitation, any implied warranties of merchantability, fitness for purpose or noninfringement, all of which are expressly disclaimed by PCI SSC. All rights and remedies regarding products and services, which have received an approval, shall be provided by the party providing such products or services, and not by PCI SSC or the payment brand participants.

This equipment operates on a secondary basis. It is not entitled to protection from harmful interference, even for stations of the same type, and may not cause interference to systems operating on a primary basis.

UX400 CTLS Reader Certifications and Regulations

VeriFone Part Number: DOC159-031-EN-A Revision A



Recycling: DO NOT DISCARD!

UNIT MUST BE RECYCLED OR DISPOSED OF PROPERLY
 For proper disposal instructions go to <http://recycle.verifone.com> Please retain this sheet for future reference.

continued on rear cover

