

Verifone[®]

V200t

Installation Guide



V200t Installation Guide
© 2017 Verifone, Inc.

All rights reserved. No part of the contents of this document may be reproduced or transmitted in any form without the written permission of Verifone, Inc.

The information contained in this document is subject to change without notice. Although Verifone has attempted to ensure the accuracy of the contents of this document, this document may include errors or omissions. The examples and sample programs are for illustration only and may not be suited for your purpose. You should verify the applicability of any example or sample program before placing the software into productive use. This document, including without limitation the examples and software programs, is supplied "As-Is."

Verifone and the Verifone logo, are registered trademarks of Verifone. Other brand names or trademarks associated with Verifone's products and services are trademarks of Verifone, Inc.

All other brand names and trademarks appearing in this manual are the property of their respective holders.

Product Warranty

For product warranty information, go to <http://www.verifone.com/terms>.

Comments? Please e-mail all comments on this document to your local Verifone Support Team.

Verifone Inc.
1-800-Verifone
www.verifone.com



CONTENTS

PREFACE 5

Audience 5

Organization 5

Related Documentation 5

Guide Conventions 5

 Acronym Definitions 6

CHAPTER 1

Overview

 V200t Terminal 9

 Front Features 9

 Rear Compartments 10

 Features and Benefits 11

 Exceptional Ease of Use and Ergonomics 11

 Critical Security Protection 11

 Countertop Performance in a Hand-Over Design 12

CHAPTER 2

Setup

 Selecting Location 13

 Environmental Factors 14

 Electrical Considerations 14

 Contactless Considerations 14

 PIN Protection Measures 14

 Unpacking Shipping Carton 15

 Installing or Replacing MSAM, Micro SD and SIM Cards 16

 Opening Card Compartment 16

 Changing or Installing MSAMs 17

 Changing or Installing Micro SD Card 17

 Changing or Installing SIM Cards (for V200t Plus Only) 18

 Establishing Communication 19

 Connecting by Telephone Line 19

 Connecting by Ethernet Cable 19

 Loading Printer Paper 20

 Connecting Optional Devices 21

 Optional Device Connections 21

 Connecting the V200t to a PC 22

 Connecting ECRs to the V200t 22

 Connecting Power Supply 23

 Smart Card Reader 24

 Magnetic Stripe Card Reader Use 24

 Contactless Transactions 25

 Periodic Inspection 25

CHAPTER 3		
Specifications	V200t Terminal	27
	Unit Power Requirements	27
	Temperature	27
	Humidity	27
	External Dimensions	27
	Weight	27
	Memory	27
	Display	27
	Battery Pack	27
	Magnetic Card Reader	27
	Primary Smart Card	28
	SAM Card Reader	28
	SIM Card Reader	28
	Connectivity	28
	Security	28
CHAPTER 4		
Troubleshooting	Display Panel Does Not Work	29
Guidelines	Keypad Does Not Respond	29
	Transactions Fail To Process	29
CHAPTER 5		
Service and Support	Maintenance and Cleaning	31
	Service Returns	31
	Accessories and Documentation	33
	Cables	33
	Power Supply	33
	Battery Pack	33
	Accessories	33
	Documentation	33
APPENDIX A	Caution and Warning Messages	35



This guide is the primary source of information for setting up and installing the V200t device.

Audience

This guide provides simple descriptions of the V200t features and the basic information for installing and configuring the V200t.

Organization

This guide is organized as follows:

[Chapter 1, Overview](#). Provides an overview of a V200t device.

[Chapter 2, Setup](#). Explains how to set up and install the V200t and establish connections with other devices.

[Chapter 3, Specifications](#). Discusses the power requirements and dimensions of V200t.

[Chapter 4, Troubleshooting Guidelines](#). Provides troubleshooting tips.

[Chapter 5, Service and Support](#). Provides information on contacting your Verifone service provider, ordering accessories or documentation from Verifone, and maintaining the V200t unit.

[Appendix A, Caution and Warning Messages](#). Shows the UL/cUL certification-compliant translations of all Warning and Caution messages in this installation guide.

Related Documentation

To learn more about the V200t device, please refer to the following documents and their associated Verifone Part Numbers (VPN):

<i>V200t Certifications and Regulations</i>	VPN DOC470-001-EN
<i>V200t Quick Installation Guide</i>	VPN DOC470-002-EN
<i>V200t Reference Guide</i>	VPN DOC470-004-EN

Guide Conventions



Please refer to the following document conventions for quickly identifying special formatting.

[Table 1](#) describes these conventions and provides examples of their use.

Table 1 Document Conventions

Convention	Meaning	Example
Blue	Text in blue indicates terms that are cross-references.	See Guide Conventions .
<i>Italics</i>	Italic typeface indicates book titles or emphasis.	You <i>must</i> not use this unit underwater.

Table 1 Document Conventions

Convention	Meaning	Example
	The pencil icon is used to highlight important information.	RS-232-type devices do not work on the communication port.
	The caution symbol indicates hardware or software failure, or loss of data.	The unit is not waterproof or dustproof, and is intended for indoor use only.
	The lightning symbol is used as a warning when bodily injury might occur.	Due to risk of shock do not use the unit near water.

Acronym Definitions Please refer to [Table 2](#) for the acronyms used in this manual.

Table 2 Acronym Definitions

Acronym	Definitions
3DES	Triple Data Encryption Algorithm
AC	Alternating Current
ANSI	American National Standards Institute
cUL	Underwriters' Laboratories of Canada
DC	Direct Current
DUKPT	Derived Unique Key Per Transaction Method as defined in the VISA's <i>POS Equipment Requirement: PIN processing and Data Authentication</i> , International Version 1.0, August 1988
ECR	Electronic Cash Register
EMV	Europay, MasterCard, and Visa
GPRS	General Packet Radio Service
HSPA	High Speed Packet Access
ISO	International Organization for Standardization
MRA	Merchandise Return Authorization
MSAM	Multiple Secure Access Module
LAN	Local Area Network
LCD	Liquid Crystal Display
LED	Light-Emitting Diode
PED	PIN Entry Device
PIN	Personal Identification Number
POS	Point-of-Sale
RS-232	Recommend Standard number 232
SAM	Secure Access Module
UL	Underwriters Laboratories

Table 2 **Acronym Definitions** (continued)

Acronym	Definitions
USB	Universal Serial Bus
VPN	Verifone Part Number



Overview

This chapter presents the basics on the V200t terminal.

V200t Terminal

The V200t offers several communication options, enhanced display, increased processing power and two USB peripheral ports.

The V200t terminal uses a robust, sleek, and highly functional design. With modular communication options, enhanced color display, increased processing power, expanded memory, and two USB peripheral ports.

The V200t can utilize over-the-air connectivity, facilitating mobile telephony technology for sending and receiving data using Bluetooth, WiFi, or existing operator-provided 2G and 3G connectivity:

This guide provides an introduction and basic setup procedures for V200t terminals.

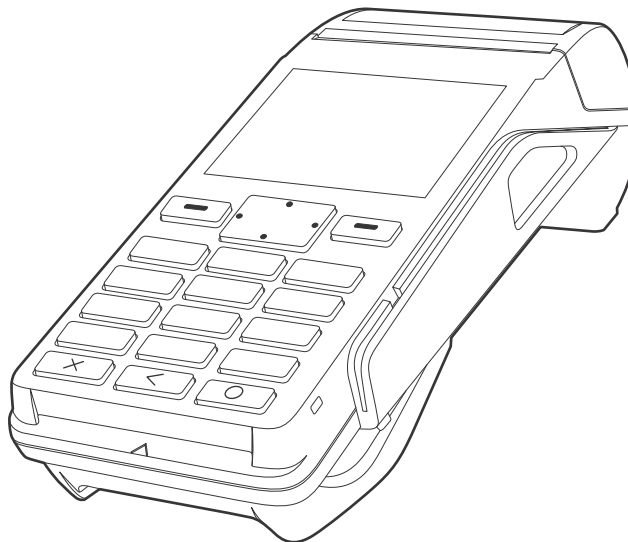

Figure 1 V200t Front View

Front Features The V200t terminal provides the right combination of features and functions:

- **2.8-inch TFT color screen** (QVGA, 240 RGB x 320 pixels)
- 4-way **Navigation Button** with **Selection Keys**
- Backlit **keypad** with tactile and audible feedback.
- **Contactles (CTLS)** reader
- **Smart card** reader
- **Magnetic card** reader

- Integrated thermal **printer**

Rear Compartments After removing the rear covers, the underside of the V200t shows the following:

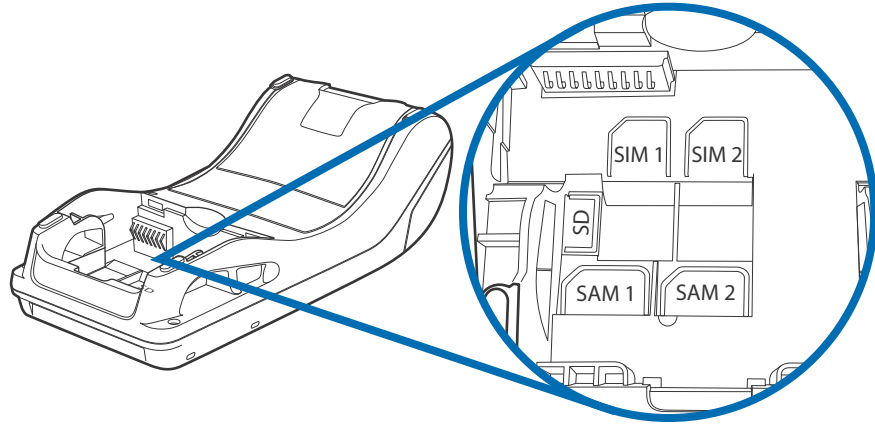

Figure 2 V200t Cards Compartment

- Dual **MSAM slots**
- Dual **SIM slots**
- **Micro SD Card slot**
- **Battery compartment**

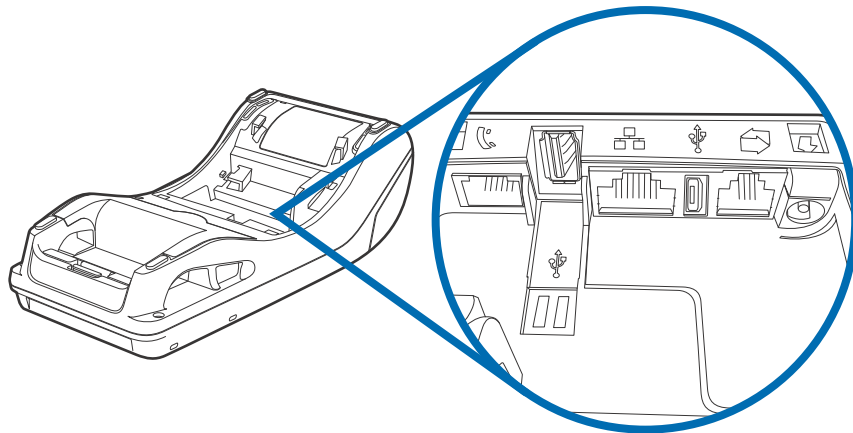

Figure 3 V200t Ports Compartment

- **Ethernet port**
- **RS-232 port**
- **RJ11 port**
- **USB Host/Client port**
- **Power port**

Features and Benefits

The V200t terminal provides the following functionality:

Exceptional Ease of Use and Ergonomics

- Four-way navigation button with two function keys for UI access.
- The contactless functionality offers a convenient payment option for consumers.
- The bold design is sleek, stylish, and lightweight for conveniently handing the terminal to the consumer for PIN entry or other input.
- A large 8-line by 21-character backlit display with backlit keypad, and extra-size menu prompts, simplify training and reduce help desk calls.
- The multiple font-capable integrated thermal printer simplifies paper loading and reduces paper jams. Uses 57 mm wide x 40 mm diameter paper rolls, prints at 30 lines per second (LPS).
- The triple-track, high-coercivity card reader handles most magnetic stripe cards.
- Large, hard-rubber keys provide improved tactile feedback.
- Intuitive keypad interface simplify training and reduce support requests.
- Connects with most POS payment terminals, PCs, and ECRs.
- Supports payment transactions in a variety of payment environments.
- Rugged and reliable design absorbs hard knocks found at point-of-sale counters.
- Sleek and stylish shape occupies minimal counter space.

Critical Security Protection

- Offers a choice of Master/Session or DUKPT key-management methods to protect PIN-based transactions.
- The primary smart card reader and the MSAMs safeguard sensitive financial data and support multiple smart card schemes.
- Certified for ISO7816-3, ISO7816-10 and EMV4.3 standards for smart card solutions.
- Offers secure, reliable PIN input for expanding range of PIN-based transactions.
- PCI 5.x-compliant for secure solutions, meeting the PED standard.
- Meets ISO and ANSI standards for PIN encryption, key management, and MAC.
- The VeriShield security architecture meets published specifications for PCI PTS POI and provides sophisticated file authentication to prevent execution of unauthorized software.
- Key injection simplified and secured with Verifone's SecureKit key loading software.

**Countertop
Performance in a
Hand-Over Design**

- The 32-bit processing and multi-tasking capabilities ensures fast processing of payment, payment-related, and value-added applications.
- Exceptional display and printer graphics-handling capabilities that quickly render logos, graphical fonts, and character-based languages.

Setup

This chapter describes the setup procedure for the V200t, in the following sections:

- Selecting Location
- PIN Protection Measures
- Unpacking Shipping Carton
- Installing or Replacing MSAM, Micro SD and SIM Cards
- Establishing Communication
- Loading Printer Paper
- Connecting Optional Devices
- Connecting Power Supply
- Smart Card Reader
- Magnetic Stripe Card Reader Use
- Contactless Transactions
- Periodic Inspection

Selecting Location

Use the following guidelines to select the best location for the V200t device.

To Select a Location

Choose a location convenient for both merchant and client:

- Far from heavy metal objects,
- A flat support surface such as a countertop or a table,
- Near a power outlet and the terminal or computer that connects to the V200t.



For safety, do not string cables or cords across a walkway.

Environmental Factors

- Do not use the unit where there is high heat, dust, humidity, moisture, or caustic chemicals or oils.
- Keep the unit away from direct sunlight and anything that radiates heat, such as a stove or a motor.
- Do not use the V200t outdoors.



The V200t is not waterproof or dustproof and is intended for indoor use only. Any damage to the unit from exposure to rain or dust can void any warranty.

Electrical Considerations

- Avoid using this product during electrical storms.
- Do not use the V200t unit near water or in moist conditions.
- Disconnect the device from its POS terminal before cleaning.



Due to risk of electrical shock or terminal damage, do not use the terminal near water, including a bathtub, wash bowl, kitchen sink or laundry tub, in a wet basement, or near a swimming pool. Avoid using this product during electrical storms. Avoid locations near electrical appliances or other devices that cause excessive voltage fluctuations or emit electrical noise (for example, air conditioners, neon signs, high frequency or magnetic security devices, or electric motors).

Contactless Considerations

Avoid having metallic objects in proximity of the contactless antenna. If you need to mount the terminal to vertical or inclined surfaces, use a flat, non-metallic mounting plate.



Using an enclosed metal frame or mount may negatively affect contactless performance.

PIN Protection Measures

Use the following techniques to provide effective screening of PIN-entry devices (PEDs) during the PIN entry process. You can use these methods in combination, although in some cases a single method might suffice:

- Position the terminal on the check-in stand in such a way as to block visual observation of the PIN-entry process. Examples include:
 - Visual shields designed into the check-in stand. The shields may be solely for shielding purposes, or may be part of the general check stand design.
 - Position the PED so that it is angled in such a way that PIN spying is difficult.
- Install the PED on an adjustable stand that allows consumers to swivel the terminal sideways and/or tilt it forwards/backwards to a position that makes visual observation of the PIN-entry process difficult.
- Position in-store security cameras so that the PIN-entry keypad is not visible.

The following table describes the two preferred mounting methods and the recommended measures to protect from PIN capture in four observation corridors:

Table 3 Mounting Methods and Protection Measures

Method	Observation Corridors			
	Cashier	Customer in Queue	Customers Elsewhere	On-site Cameras
Countertop with Swivel Stand	No Action Needed.	Customer positions PED	No action needed	Do not install within view of cameras
Countertop without stand	Position the PED to face away from the cashier. Use signage to block cashier's view.	Position the PED between customer and the next in queue. Install the optional privacy shield.	Privacy Shield Installed	Do not install within view of cameras



A swivel stand gives the cardholder freedom to position the V200t to optimize their viewing angle. If you are installing a swivel stand, you must include prompts in your application directing the cardholder to position the V200t strategically to restrict the view of other customers.

Additionally, you may wish to implement the following to further increase security during PIN entry.

- Offer PIN security literature at the point of sale
- Use signage to limit the view of the V200t to just that of the cardholder.

Unpacking Shipping Carton

Carefully inspect the shipping carton and its contents for possible tampering or damage.

- 1 Remove the V200t unit from the shipping carton. The standard package contains the PIN pad, power pack, telephone cable, and printer paper roll. Refer to [Accessories and Documentation](#) for more information on related accessories.



Figure 4 V200t Box Contents

- 2 Remove any protective plastic wrap and place the unit on a table or countertop.

- 3 Remove the clear protective film from the display.
- 4 Replace all the packing materials, close the lid, and save the carton for repacking or moving the V200t unit in the future.



Do not use a unit that has been tampered with or otherwise damaged. This unit comes equipped with tamper-evident label. If a label or component appears damaged, immediately notify the shipping company and your Verifone representative or service provider.

Installing or Replacing MSAM, Micro SD and SIM Cards

You may need to install or replace the Multiple Security Access Module (MSAM), Micro Secure Digital (SD) and Subscriber Identity Module (SIM) cards.



Observe standard precautions in handling electrostatically sensitive devices. Electrostatic discharges can damage the equipment. Verifone recommends using a grounded anti-static wrist strap.

Opening Card Compartment

Use the following steps to get access to the MSAM, Micro SD and SIM card compartments:

- 1 Place the terminal face down on a soft and clean surface to protect the display from scratches.
- 2 Push the locking tab and swing out the compartment cover.
- 3 If it's already installed, remove the battery (VPN BPK470-001-01-A) to get better access to the card slots

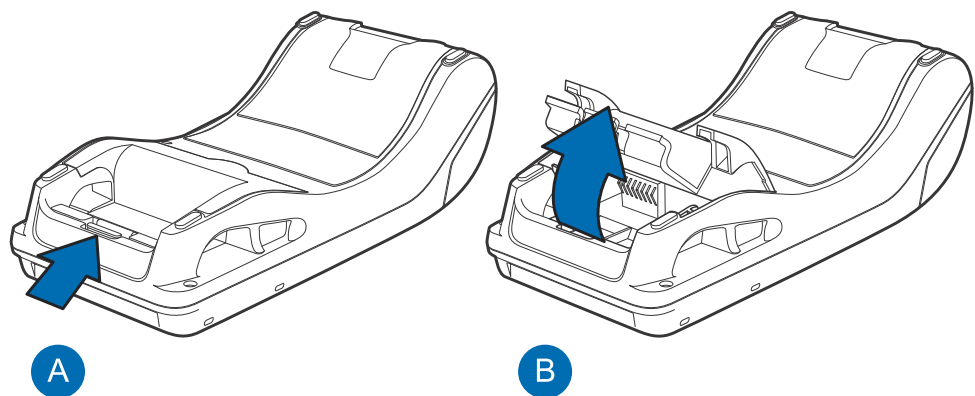

Figure 5 Accessing Cardholders

- 4 The MSAM, Micro SD and SIM cardholders are now accessible.

Changing or Installing MSAMs

To change or install MSAM cards:

- 1 Use steps 1 to 3 of [Opening Card Compartment](#) to get to the MSAM cardholder.
- 2 Remove the old card, if any, and insert the MSAM card carefully into the slot (with the gold contacts facing downward) until fully inserted.

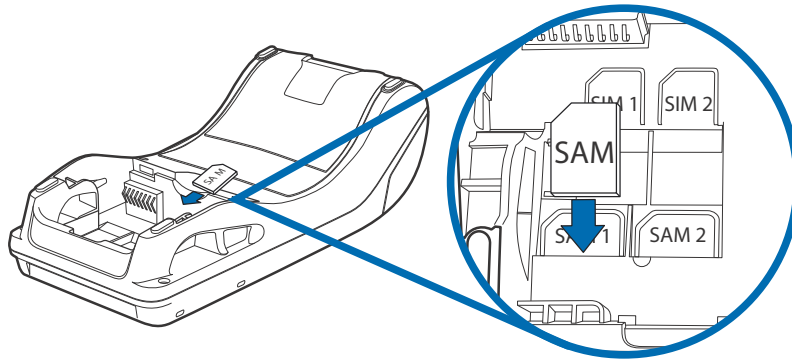

Figure 6 Inserting MSAM Card

NOTE



Insert the card with the card's gold contacts facing away from you, toward the unit. Take note of the notched edge on the MSAM card for quick orientation.

- 3 If you are finished replacing or inserting cards, replace the battery and lock the rear cover back in place.

Changing or Installing Micro SD Card

To change or install Micro SD cards:

- 1 Use steps 1 to 3 of [Opening Card Compartment](#) to get to the Micro SD cardholder.
- 2 Remove the old card, if any, and insert the Micro SD card carefully into the slot (with the gold contacts facing downward) until fully inserted.

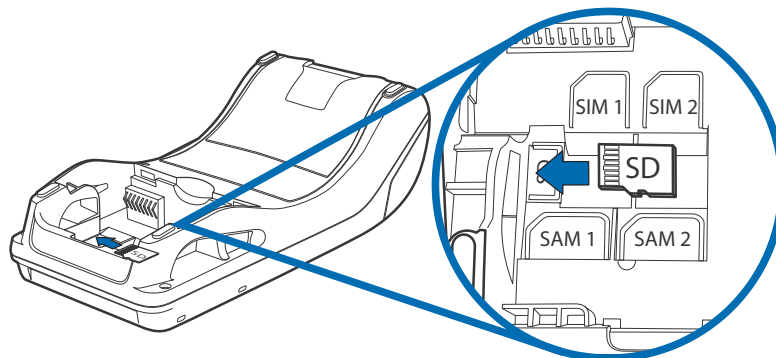

Figure 7 Inserting Micro SD Card

NOTE



Insert the card with the card's gold contacts facing away from you, toward the unit.

- 3 If you are finished replacing or inserting cards, replace the battery and lock the rear cover back in place.

Changing or Installing SIM Cards (for V200t Plus Only)

To change or install SIM cards in V200t Plus units:

- 1 Use steps 1 to 3 of [Opening Card Compartment](#) to get to the SIM cardholder.
- 2 Remove the old card, if any, and insert the SIM card carefully into the slot (with the gold contacts facing downward) until fully inserted.

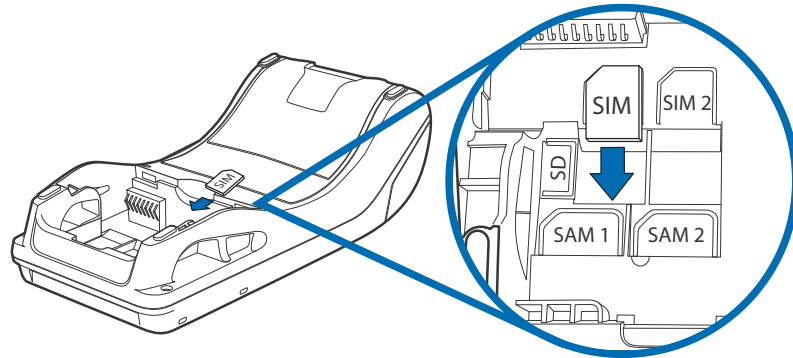

Figure 8 Inserting SIM Card

NOTE



Insert the card with the card's gold contacts facing away from you, toward the unit. Take note of the notched edge on the SIM card for quick orientation.

- 3 If you are finished replacing or inserting cards, replace the battery and lock the rear cover back in place.

Establishing Communication

You can connect the V200t to your network by using the following options:

- Connecting by Telephone Line
- Connecting by Ethernet Cable.

Connecting by Telephone Line

Connect the telephone cord to the communication port on the terminal, then route it directly to a telephone wall jack (see Figure 9). This is a direct connection and the line is dedicated to the terminal.

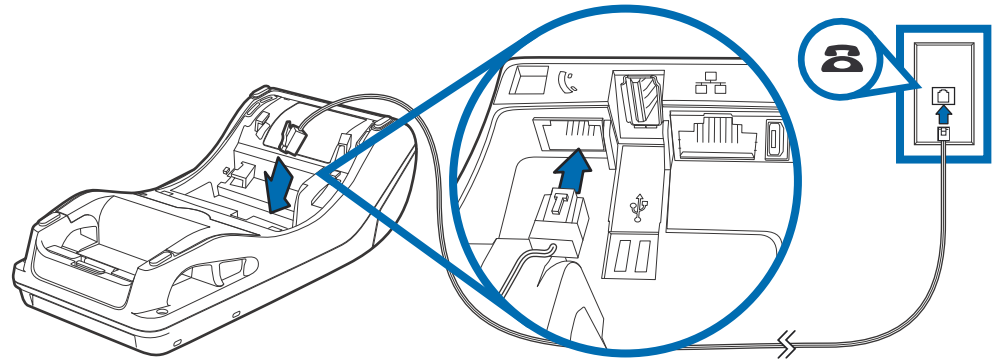

Figure 9 Direct Telephone Connection



To reduce the risk of fire, use only No. 26AWG or larger UL Listed or CSA Certified Telecommunication Line Cord.

Connecting by Ethernet Cable

Connect the ethernet cable to the ETH port on the terminal, then route it directly to a network jack (see Figure 10). This is a direct connection to your network.

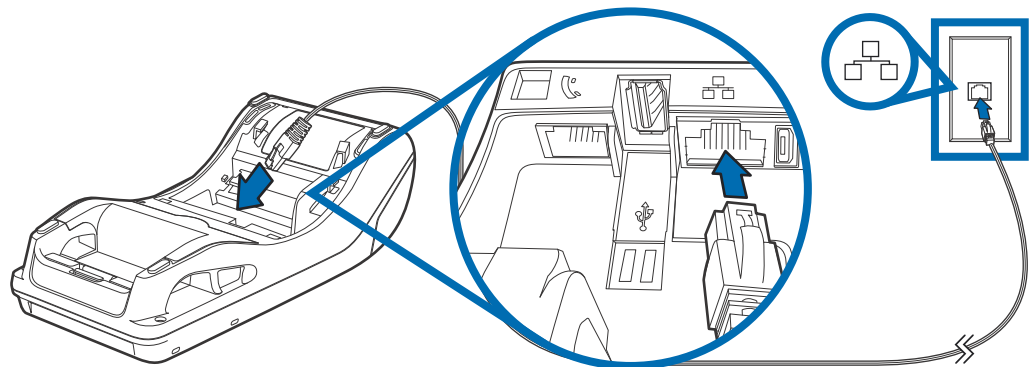

Figure 10 Ethernet Connection

Loading Printer Paper

Before you can process transactions that require a receipt or record, you must install paper in the printer.

The V200t uses a roll of 57 mm wide x 40 mm, single-ply, thermal sensitive paper.

A pink out-of-paper indicator line appears on the edge of the paper before the end of the roll. After this line appears, there is enough paper remaining on the roll to conclude at least one more transaction.



Poor-quality paper can jam the printer and create excessive paper dust. Store thermal paper in a dry, dark area. Handle thermal paper carefully: impact, friction, temperature, humidity, and oils affect the color and storage characteristics of the paper. Never load a roll of paper with folds, wrinkles, tears, or holes at the edges.

- 1 Unlock the paper compartment by pulling up the latch and swinging the door downwards.
- 2 Remove any partial roll of paper in the printer tray by lifting it up.
- 3 Loosen the glued leading edge of the new paper roll or remove the protective strip. Unwind the paper roll past any glue residue.
- 4 Hold the roll so the paper feeds from the *bottom* of the roll.
- 5 Load the paper roll as shown in Figure 11, with the edge of the paper on the top of the roll.

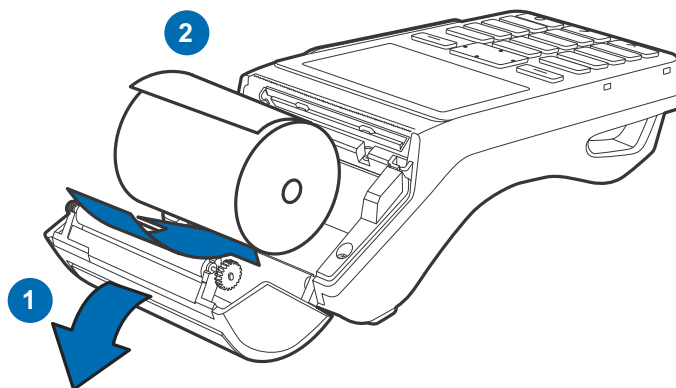

Figure 11 Opening Printer Door and Loading Paper Roll

- 6 Swing the paper roll cover until it clicks shut, allowing a small amount of paper (past the glue residue) to extend outside the printer door.

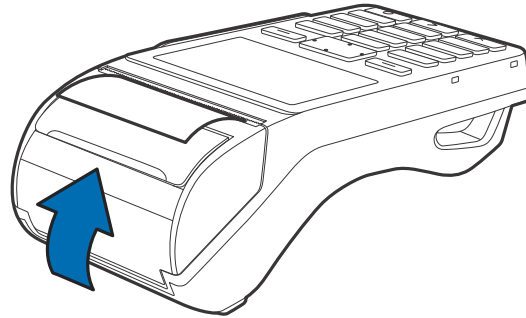

Figure 12 Closing Printer Door

Connecting Optional Devices

The V200t device supports some peripheral devices designed for use with electronic point-of-sale terminals.



Before connecting any peripheral device, remove the power plug from the terminal. Reconnect the power cord only after you are finished connecting the peripheral device(s). For complete information about peripheral installation and use, refer to the user documentation supplied with those devices.

Different terminals support different devices, so for more information about optional devices, please contact your Verifone distributor.

Optional Device Connections

You can connect several devices to your V200t. You can use the following cables for different types of device connections:

- RJ9 to DB9 cable (VPN CBL000-051-02-A)
- Multi-port coiled cable (VPN CBL470-006-02-A)

NOTE



Make sure you replace the rear cover when all cables are installed. This provides some protection to the cables and connectors. Do not carry the terminal by the installed cables or pull the terminal about the by the cables. This may cause a cable to be removed or damage the cables.

CAUTION



Some devices (ECRs and some PIN pads) require a separate power source. Before connecting to any device, remove the power cord from the V200t unit.

Contact your Verifone representative or visit the online store at www.store.verifone.com for information on these devices.

Connecting the V200t to a PC

The following illustration shows how to connect the V200t to a computer via the Multi-Communication port using the RJ9 to DB9 cable (VPN CBL000-051-02-A).

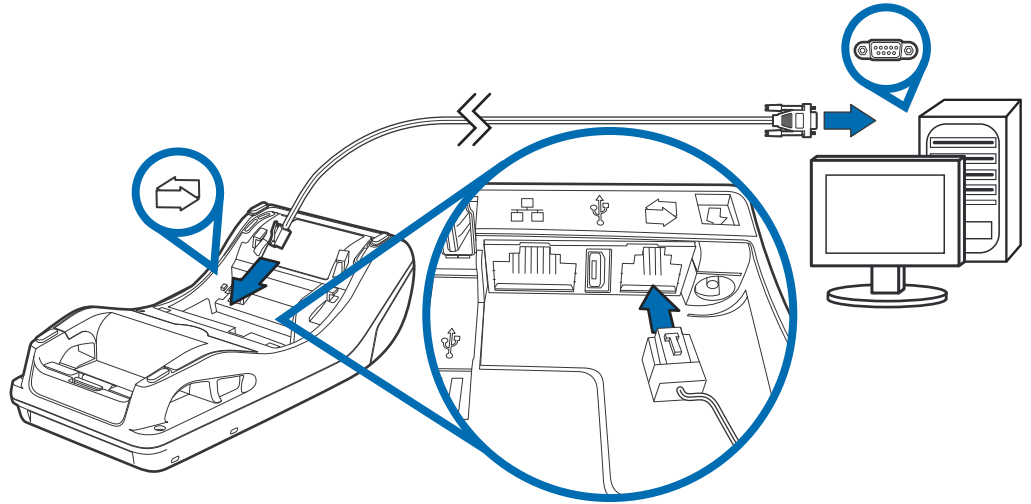

Figure 13 Sample PC Connection

Connecting ECRs to the V200t

The V200t supports electronic cash registers (ECRs).

The following illustration shows how to make a peripheral connection to the Multi-Communication port using the RJ9 to DB9 cable (VPN CBL000-051-02-A)

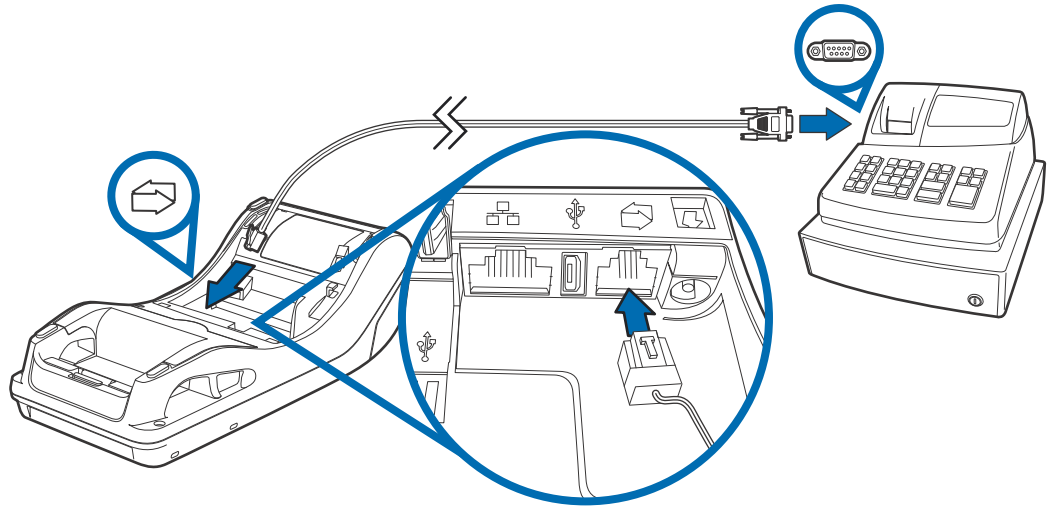

Figure 14 Sample ECR Connection

Connecting Power Supply

Not all configurations and device contexts require the use of a power supply – Verifone ships the power supply unit with the terminal as required.

Contact your Verifone representative if you have changed the context in which the terminal is used or have questions about which power supply should be used.



Using an incorrectly rated power supply can damage the unit or cause it not to work properly. Use only a power pack with VPN PWR470-001-01-A (see [Service and Support](#) for detailed power supply specifications).

Disconnect the power pack cord from the power outlet before connecting a power supply. Connect and route all cables between the terminal, ECR, and PC before plugging the power pack cord into a wall outlet or surge protector.

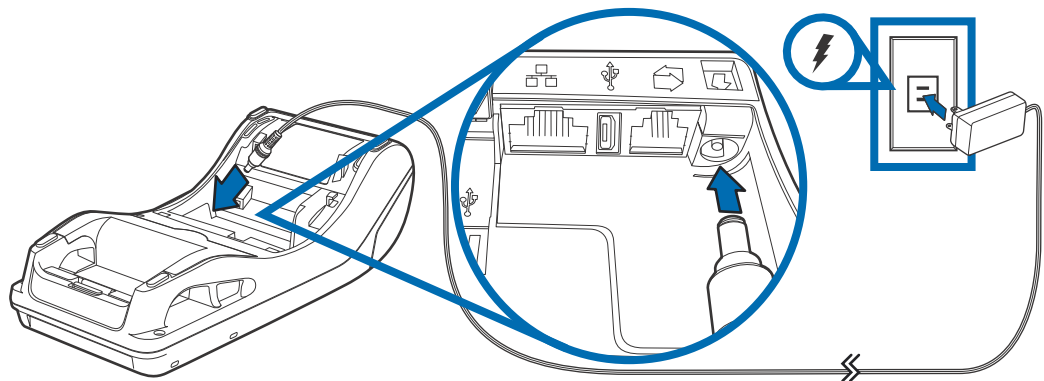

Figure 15 Connecting the Power Pack



Do not plug the power pack into an outdoor outlet or operate the terminal outdoors. Disconnecting power during a transaction can cause transaction data files not yet stored in memory to be lost.

When the terminal has power and an application is loaded, the application starts after the initial Verifone copyright screen and displays a unique copyright screen. If no application is loaded, **DOWNLOAD NEEDED** appears on the display after the initial Verifone copyright screen.



Verifone recommends installing a power surge protector to protect against possible damage caused by lightning strikes and electrical surges.

Smart Card Reader

The smart card transaction procedure can vary depending on the application. Verify the proper procedure with your application provider before performing a smart card transaction.

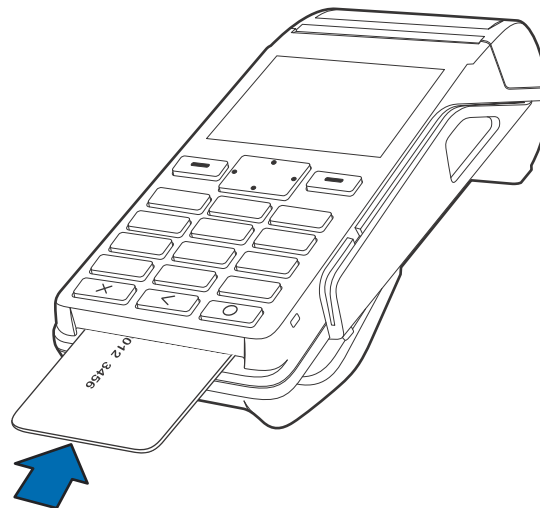

Figure 16 Using the Smart Card Reader

Conducting a Smart Card Transaction

To conduct a smart card transaction:

- 1 Position the smart card with the gold contacts facing upward.
- 2 Insert the card into the smart card reader slot in a smooth, continuous motion until it seats firmly.
- 3 Remove the card when the display indicates the transaction is completed.



Leave the smart card in the card reader until the transaction is completed. Premature removal can void the transaction.

Magnetic Stripe Card Reader Use

The V200t has a magnetic card reader that uses a triple track stripe reader. This gives the unit greater reliability over a wide range of swipe speeds and operating environments.

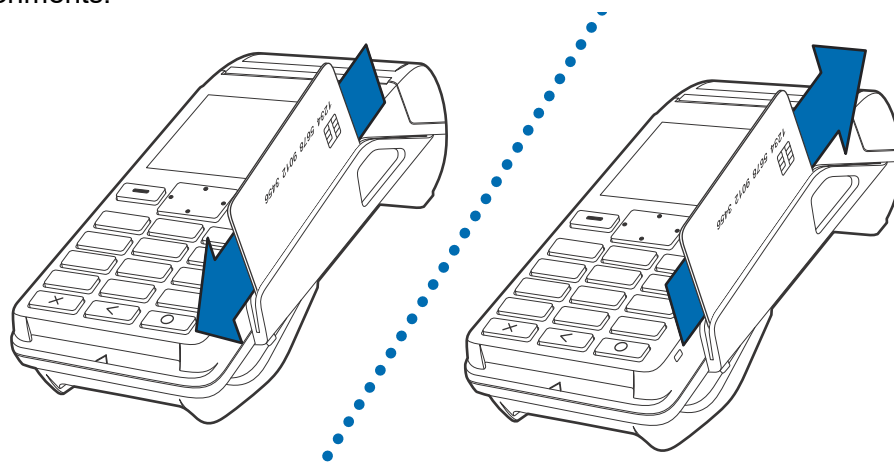

Figure 17 Using the Magnetic Stripe Card Reader

Conducting a Credit/ Debit Card Transaction

To conduct a credit or debit card transaction:

- 1 Position a magnetic card with the stripe facing the keypad.
- 2 Swipe it through the magnetic card reader.

Contactless Transactions

The V200t supports contactless transactions through an integrated contactless module. The terminal only becomes active for contactless smart card transactions when initialized by an application.

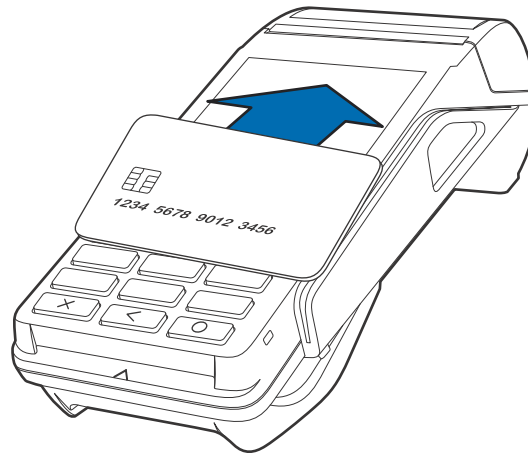

Figure 18 Contactless Transaction

Performing Contactless Transactions

To perform a contactless smart card transaction:

- 1 Gently tap the card onto or hold the card (within 4 cm) against the surface of the display where the contactless logo appears.
- 2 An activated LED visual on the display accompanied by a short beeping sound indicates a successful transaction.

See [Contactless Considerations](#) for more information.

Periodic Inspection

Periodically inspect the terminal for possible tampering. Signs of tampering may include:

- Wires protruding from the device.
- Foreign objects inserted into the smart card or mag stripe slot.
- Signs of damage to the tamper-evident label.
- Warning message on the device display.

NOTE



If any device is found in tamper state, please remove it immediately from service. Keep it available for potential forensic investigation, and notify your company security officer and your local Verifone representative or service provider. For more information on contacting Verifone, refer to [Service and Support](#).



Specifications

This chapter discusses power requirements, dimensions, and other specifications of the V200t terminal.

V200t Terminal

Refer to the following technical information for the V200t terminal:

Unit Power Requirements

- Operating Power: 8 V DC, 2.25 A

Temperature

- Operating temperature: 0° to 50° C (32° to 122° F)
- Storage temperature: -20° to 60° C (-4° to 140° F)

Humidity

- Relative humidity: 5% to 90% (RH non-condensing)

External Dimensions

- Length: 185 mm (7.3 in)
- Width: 78 mm (3.1 in)
- Depth: 54 mm (2.1 in)

Weight

- Unit weight: 274 g (9.66 oz)

Memory

- 384MB (DDR3L: 128MB, NAND Flash: 256MB)

Display

- 2.8" color TFT 240 (RGB) x 320 (HVGA)

Battery Pack

- Single-cell 2450 mAH battery pack.
- Meets IEEE1725 requirements
- EEPROM is included for battery ID
- Integrated Booster, Fuel gauge, charger IC and safety circuits inside

Magnetic Card Reader

- Triple track (tracks 1, 2, 3), high coercivity, bi-directional

Primary Smart Card

- ISO 7816-3, 1.8 V, 3 V, 5 V
- Synchronous and Asynchronous cards
- EMV Approved

SAM Card Reader

- Two Security Access Module (SAM) slots

SIM Card Reader

- Two Security Access Module (SIM) slots

Connectivity

- GSM
 - GPRS/GSM Class 10
 - GPRS DL 85.6 kbps, UL 42.8 kbps
- GPRS (V200t Plus Only)
 - GPRS/GSM Class 10
 - UMTS/HSPA DL 7.2Mbps, UL 5.7Mbps
- Bluetooth
 - BT class 1.5 with up to 100m range as a goal (line of sight)
 - BT v4.1 integrated
 - BT v4.2 security connection support by FW update
- WiFi
 - 2.4Ghz / 5Ghz frequency channel support
- Ethernet RJ45
 - Speed 10 Base-T /100 Base-TX
 - Compliant with IEEE802.3 LAN networks.
- Dial modem RJ11
 - V.92 standard supported, line speeds of up to 56 Kbps
- USB type-A receptacle
 - USB2.0 high speed
- MOD 10 2-in-1 I/O port
 - Supports 5 V / 500 mA to external USB device
 - Total 5 V support is 600 mA

Security

- 3DES encryption, Master/Session and DUKPT key management
- VeriShield file authentication
- PCI PED 5.x approved



Troubleshooting Guidelines

This chapter lists typical malfunctions that may occur while operating a V200t device and the appropriate corrective action. If the problem persists – even after performing the outlined guidelines, or if the problem is not described, contact your local Verifone representative for assistance.

NOTE

The V200t device uses a tamper-evident case and contains no user-serviceable parts. Do not, under any circumstance, attempt to disassemble the unit. Perform only those adjustments or repairs specified in this guide. For all other services, contact your local Verifone service provider. Service conducted by parties other than authorized Verifone representatives may void any warranty.

Display Panel Does Not Work

Use the following steps to check the display panel:

- 1 Check all the cable connections.
- 2 Check the controlling device's AC outlet to be sure the outlet is supplying sufficient power. Substitute the controlling device's power pack with another power pack.
- 3 The controlling device's application program might not be loaded correctly. Download the application program and try again.
- 4 If the problem persists, contact your local Verifone representative.

Keypad Does Not Respond

Use the following steps to check the keypad:

- 1 Check the display panel. If there are no characters, or the wrong characters are displayed, refer to [Display Panel Does Not Work](#).
- 2 If the problem persists, contact your local Verifone representative.

Transactions Fail To Process

There are several possible reasons why the unit may not be processing transactions. Use the following steps to troubleshoot failures.

Check Magnetic Card Reader

- Perform a test transaction using one or more different magnetic stripe cards to ensure the problem is not a defective card.
- Ensure that you are swiping cards properly (see [Magnetic Stripe Card Reader Use](#)).
- Process a transaction manually using the keypad instead of the card reader. If the manual transaction works, the problem may be a defective card reader.

- If the problem persists, contact your local Verifone representative.

Check Smart Card Reader

- Perform a test transaction using several different smart cards to ensure the problem is not a defective card.
- Ensure that the card is inserted correctly (see [Magnetic Stripe Card Reader Use](#)).
- Ensure the MSAM cards are properly inserted in the slots and are properly secured (see [Installing or Replacing MSAM, Micro SD and SIM Cards](#)).
- If the problem persists, contact your local Verifone representative.



Service and Support

Maintenance and Cleaning

The V200t device has no user-serviceable parts. Unless otherwise instructed, do not, under any circumstances, attempt any service, adjustments, or repairs on the unit. Disconnect the device before cleaning.

To clean the unit, periodically use a clean cloth, slightly dampened with water and a drop or two of mild soap. For stubborn stains, use alcohol or an alcohol-based cleaner. For best results, use a Verifone Cleaning Kit (refer to [Accessories and Documentation](#)).



CAUTION

Never use thinner, trichloroethylene, or ketone-based solvents – they can deteriorate plastic or rubber parts.

Because the V200t can be damaged by liquid, do not spray cleaners or other solutions directly onto the keypad or display. Always apply the cleaner to a cloth before cleaning the device.

Service Returns

For V200t equipment failures that cannot be resolved by your help desk or service department, contact one of the following hotlines for product service and repair information:

- USA – Verifone Service and Support Group, 1-800-834-9133, Monday - Friday, 8 A.M. - 7 P.M., EST
- International – Contact your Verifone representative

Before returning V200t unit to Verifone, you must obtain a Merchandise Return Authorization (MRA) number. The following procedure describes how to return one or more V200t for repair or replacement (U.S. customers only).



NOTE

International customers, please contact your local Verifone representative for assistance with your service, return, or replacement.

- 1 Gather the following information from the printed labels on the bottom of *each* V200t device to be returned:
 - Product ID, including the model and part number. For example, "M470-xxx-xx-xxx-x"
 - Serial number (S/N xxx-xxx-xxx)
- 2 Within the United States, call Verifone toll-free at 1-800-834-9133.

- 3 Select the MRA option from the automated message. The MRA department is open Monday–Friday, 8 A.M.–7 P.M., EST.
- 4 Give the MRA representative the information gathered in [Step 1](#).
If the list of serial numbers is long, you can fax the list, along with the information gathered in [Step 1](#), to the MRA department at 1-727-953-4172 (U.S.)
 - Please address the fax clearly to the attention of the “Verifone MRA Dept.”
 - Include a telephone number where you can be reached, as well as your fax number.
 - You will be issued MRA number(s) and the fax will be returned to you.



One MRA number must be issued for each V200t unit you return to Verifone, even if you are returning several of the same model.

- 5 Describe the problem(s).
- 6 Provide the shipping address where the repaired or replacement unit must be returned.
- 7 Keep a record of the following items:
 - Assigned MRA number(s).
 - The serial number assigned to the V200t device (located at the bottom of the unit).
 - Shipping documentation, such as air bill numbers, used to trace the shipment.
 - Model(s) returned (model numbers are located on the bottom of the unit).

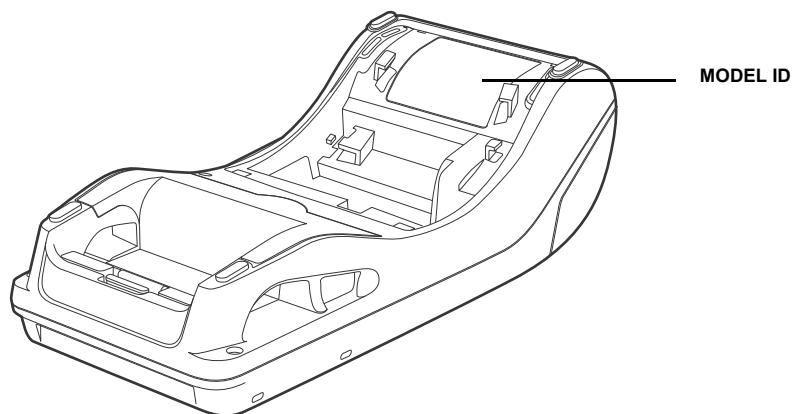

Figure 19 Model ID Location

Accessories and Documentation

Verifone produces accessories and documentation for the V200t. When ordering, please refer to the part number in the left column.

- Verifone Online Store at www.store.verifone.com
- USA – Verifone Customer Development Center, 1-800-Verifone (837-4366)
Monday - Friday, 7 A.M. - 5 P.M., MST
- International – Contact your Verifone representative

Cables

Contact your local Verifone distributor to determine which cable fits your needs.

CBL159-312-01-A	LAN cable for Ethernet connections (CAT5, 2.0 m).
CBL000-051-02-A	RJ9 to DB9 cable
CBL470-006-02-A	Multi-port coiled cable
26264-01-R	Cash register cable, RJ45-SUBD9f, 1.0 m.
26264-02-R	Cash register cable, RJ45-SUBD9f, 2.0 m.

Power Supply

PWR470-001-01-A	Power pack (100-240 V AC Input; 8 V DC, 2.25 A, 18 W Output)
-----------------	--

Battery Pack

BPK470-001-01-A	Battery pack (8 V DC, 800 mA, 6.4 Wh)
-----------------	---------------------------------------

Accessories

02746-01	Verifone Cleaning Kit
----------	-----------------------

Documentation

DOC470-101-EN	V200t Certifications and Regulations
DOC470-102-EN	V200t Quick Installation Guide
DOC470-104-EN	V200t Reference Guide



Caution and Warning Messages

Products with UL/cUL certification should include French translations of Caution and Warning notices. The following table lists all notices found in the document, their location, and the equivalent French translations.

Table 4 Caution and Warning Messages

Notice	Chapter	Page	English Text	French Text
Warning	Setup	page 13	For safety, do not string cables or cords across a walkway.	<i>Par mesure de sécurité, ne pas les câbles de chaîne ou de cordons à travers une passerelle.</i>
Caution	Setup	page 14	This unit is not waterproof or dustproof, and is intended for indoor use only. Any damage to the unit from exposure to rain or dust can void any warranty.	<i>Cet appareil n'est pas étanche ou à la poussière, et est destiné à une utilisation en intérieur. Tout dommage à l'unité de l'exposition à la pluie ou à la poussière peut annuler la garantie.</i>
Warning	Setup	page 14	Due to risk of electrical shock or terminal damage, do not use the terminal near water, including a bathtub, wash bowl, kitchen sink or laundry tub, in a wet basement, or near a swimming pool. Also, avoid using this product during electrical storms. Avoid locations near electrical appliances or other devices that cause excessive voltage fluctuations or emit electrical noise (for example, air conditioners, neon signs, highfrequency or magnetic security devices, or electric motors).	<i>Du fait d'un risque d'électrocution ou d'une détérioration du terminal, ne pas utiliser cet équipement près d'une source d'eau, par exemple près d'une baignoire, d'un lavabo, d'un évier de cuisine ou d'un bac de lavage, dans un sous-sol humide ou à proximité d'une piscine. De même, éviter d'utiliser ce produit lors des orages provoquant des coupures électriques. Éviter de placer le terminal à proximité d'appareils électriques ou autres unités pouvant entraîner des fluctuations de tension importantes ou des interférences électriques, tels que les climatiseurs, enseignes au néon, dispositifs de sécurité à haute fréquence ou équipements électriques.</i>
Caution	Setup	page 14,	Using an enclosed metal frame or mount may negatively affect contactless performance.	<i>L'utilisation d'un cadre métallique fermé ou de montage peut affecter négativement contact performance.</i>
Warning	Setup	page 16	Do not use a unit that has been tampered with or otherwise damaged. This unit comes equipped with tamper-evident label. If a label or component appears damaged, immediately notify the shipping company and your Verifone representative or service provider.	<i>Ne pas utiliser un appareil qui a été altéré ou endommagé. Cet appareil est équipé d'étiquette d'inviolabilité. Si une étiquette ou d'un composant semble être endommagé, en aviser immédiatement la compagnie maritime et votre représentant Verifone ou prestataire de services.</i>

Table 4 Caution and Warning Messages (continued)

Notice	Chapter	Page	English Text	French Text
Caution	Setup	page 16	Observe standard precautions in handling electrostatically sensitive devices. Electrostatic discharges can damage the equipment. Verifone recommends using a grounded anti-static wrist strap.	<i>Respecter les précautions standard dans la manipulation d'appareils sensibles aux décharges électrostatiques. Les décharges électrostatiques peuvent endommager le matériel. Verifone recommande d'utiliser un bracelet anti-statique à la terre.</i>
Caution	Setup	page 23	Using an incorrectly rated power supply can damage the unit or cause it not to work properly. Use only a power pack with VPN DOC470-001-01-A.	<i>L'utilisation d'une alimentation incorrecte peut endommager l'appareil ou ne pas fonctionner correctement. Utilisez uniquement un bloc d'alimentation avec VPN DOC470-001-01-A.</i>
Caution	Setup	page 23	Do not plug the power pack into an outdoor outlet or operate the terminal outdoors. Disconnecting power during a transaction can cause transaction data files not yet stored in memory to be lost.	<i>Ne branchez pas le bloc d'alimentation dans une prise extérieure ou n'utilisez pas le terminal à l'extérieur. La déconnexion de l'alimentation pendant une transaction peut entraîner la perte des fichiers de données de transaction qui ne sont pas encore stockés dans la mémoire.</i>
Caution	Setup	page 24	Leave the smart card in the card reader until the transaction is completed. Premature removal can void the transaction.	<i>Laissez la carte à puce dans le lecteur de carte jusqu'à ce que la transaction soit terminée. Le retrait prématuré peut annuler la transaction.</i>
Caution	Service and Support	page 31	Never use thinner, trichloroethylene, or ketone-based solvents – they can deteriorate plastic or rubber parts. Because this device can be damaged by liquid, do not spray cleaners or other solutions directly onto the keypad or display. Always apply the cleaner to a cloth before cleaning the device.	<i>N'utilisez jamais de diluant, le trichloréthylène ou des solvants cétoniques - ils peuvent détériorer les pièces en plastique ou en caoutchouc. Parce que cet appareil peut être endommagé par un liquide, ne pas vaporiser de nettoyage ou d'autres solutions directement sur le clavier ou l'écran. Toujours appliquer le nettoyant sur un chiffon avant de nettoyer l'appareil.</i>



Verifone, Inc.
1-800-Verifone
www.verifone.com

V200t

Installation Guide

