

VX520-G

Installation Guide



VX520-G Installation Guide
© 2013 VeriFone, Inc.

All rights reserved. No part of the contents of this document may be reproduced or transmitted in any form without the written permission of VeriFone, Inc.

The information contained in this document is subject to change without notice. Although VeriFone has attempted to ensure the accuracy of the contents of this document, this document may include errors or omissions. The examples and sample programs are for illustration only and may not be suited for your purpose. You should verify the applicability of any example or sample program before placing the software into productive use. This document, including without limitation the examples and software programs, is supplied "As-Is."

VeriFone, the VeriFone logo, VeriCentre, Verix, and ZonTalk are registered trademarks of VeriFone. Other brand names or trademarks associated with VeriFone's products and services are trademarks of VeriFone, Inc.

All other brand names and trademarks appearing in this manual are the property of their respective holders.

Comments? Please e-mail all comments on this document to your local VeriFone Support Team.

VERIFONE CONFIDENTIAL
DRAFT

VeriFone, Inc.
2099 Gateway Place, Suite 600
San Jose, CA, 95110 USA

www.verifone.com

VeriFone Part Number DOC252-063-EN-A, Revision A



PREFACE	5
Audience	5
Organization	5
Related Documentation	5
Conventions and Acronyms	6
Document Conventions	6
Acronym Definitions	6
 CHAPTER 1	
Terminal Overview	
Features and Benefits	10
Connectivity	10
Performance	10
Security	10
Form Factor	10
Exceptional Ease of Use	10
Countertop Performance in a Hand-Over Design	11
True Multi-Application Capability	11
Wireless Connectivity	11
 CHAPTER 2	
Terminal Setup	
Selecting Terminal Location	13
Ease of Use	13
Environmental Factors	13
Electrical Considerations	14
Unpacking the Shipping Carton	14
Examining Terminal Features	15
Front Panel	15
Connection Ports	16
Establishing Communication	19
Connecting by Telephone Line	19
Connecting by Ethernet	19
Connecting by GPRS	19
Loading a Paper Roll in the Printer	20
Installing/Replacing MSAM Cards	22
Installing or Replacing SIM Card	23
Connecting Optional Devices	24
Optional Device Connections	24
External Printers Supported	26
Installing the Smart Battery	26
Charging the Smart Battery	27
Connecting the Terminal Power Pack	27
Privacy Shield (Optional)	29
Using the CTLS Reader	29
Using the Smart Card Reader	30
Using the Magnetic Card Reader	30

CHAPTER 3		
Specifications	Power	31
	DC Power Pack	31
	Temperature	31
	External Dimensions	31
CHAPTER 4		
Maintenance	Cleaning the Terminal	33
	Terminal Contacts	33
	Smart Card Reader	33
CHAPTER 5		
Troubleshooting Guidelines	Blank Display	35
	Terminal Does Not Dial Out	36
	Printer Paper Jam	36
	Keypad Does Not Respond	36
	Peripheral Device Does Not Work	36
	Transactions Fail To Process	37
	Printer Does Not Print	38
	Terminal Display Does not Show Correct or Readable Information	38
	Terminal Does Not Start	38
CHAPTER 6		
VeriFone Service and Support	Return a Terminal for Service	39
	Accessories and Documentation	40
	Power Pack	40
	Spare Battery	41
	Printer Paper	41
	Supplementary Hardware	41
	VeriFone Cleaning Kit	41
	Telephone Line Cord	41
	Documentation	41
	INDEX	43



This guide is your primary source of information for setting up and installing the VX520-G terminal.

Audience

This guide is useful for anyone installing and configuring a VX520-G terminal. This manual also provides a basic description of the terminal features.

Organization

This guide is organized as follows:

Chapter 1, Terminal Overview. Provides an overview of the VX520-G terminal.

Chapter 2, Terminal Setup. Explains how to set up and install the VX520-G terminal. It tells you how to select a location, establish power and telephone line connections, and how to configure optional peripheral devices.

Chapter 3, Specifications. Discusses power requirements and dimensions of the VX520-G terminal.

Chapter 4, Maintenance. Explains how to maintain your VX520-G terminal.

Chapter 5, Troubleshooting Guidelines. Provides troubleshooting guidelines, should you encounter a problem in terminal installation and configuration.

Chapter 6, VeriFone Service and Support. Provides information on contacting your local VeriFone representative or service provider, and information on how to order accessories or documentation from VeriFone.

Related Documentation

To learn more about the VX520-G terminal, refer to the following set of documents:

<i>VX 520 GPRS CTLU Certifications and Regulations</i>	VPN DOC252-061-EN
<i>VX 520 GPRS CTLS Quick Installation Guide</i>	VPN DOC252-062-EN
<i>VX 520 GPRS CTLS Reference Manual</i>	VPN DOC252-064-EN
<i>VX 520 Installation Guide</i>	VPN DOC252-003-EN
<i>VX 520 Reference Manual</i>	VPN DOC252-004-EN
<i>VX 520 GPRS Certifications and Regulations</i>	VPN DOC252-021-EN
<i>VX 520 CTLS Certifications and Regulations</i>	VPN DOC252-031-EN
<i>VX 520 CTLS Quick Installation Guide</i>	VPN DOC252-032-EN
<i>VX 520 CTLS Installation Guide</i>	VPN DOC252-033-EN



Conventions and Acronyms

This section describes the conventions and acronyms used in this guide.

Document Conventions

Various conventions are used to help you quickly identify special formatting. Table 1 describes these conventions and provides examples of their use.

Table 1 Document Conventions

Convention		
Blue	Text in blue indicates terms that are cross referenced.	See Conventions and Acronyms .
<i>Italics</i>	Italic typeface indicates book titles or emphasis.	You <i>must</i> install a roll of thermal-sensitive paper in the printer.
Courier	The courier type face is used while specifying onscreen text, such as text that you would enter at a command prompt, or to provide an URL.	<code>http://www.verifone.com</code>
	The pencil icon is used to highlight important information.	RS-232-type devices do not work with the PIN pad port.
	The caution symbol indicates possible hardware or software failure, or loss of data.	The terminal is not waterproof or dust proof, and is intended for indoor use only.
	The lighting symbol is used as a warning when bodily injury might occur.	Due to risk of shock do not use the terminal near water.

Acronym Definitions

Various acronyms are used in place of the full definition. Table 2 presents acronyms and their definitions.

Table 2 Acronym Definitions

Acronym	Definitions
AC	Alternating Current
ATM	Automated Teller Machine
CPU	Central Processing Unit
CR	Check Reader
CTLS	Contactless
DC	Direct Current
EMV	Europay MasterCard and VISA
GPRS	General Packet Radio Service
ITP	Internal Thermal Printer

Table 2 **Acronym Definitions** (continued)

Acronym	Definitions
LCD	Liquid Crystal Display
LED	Light Emitting Diode
MRA	Merchandise Return Authorization
MSAM	Micromodule-Size Security Access Module
PCI	Payment Card Industry
PED	PIN-Entry Devices
PIN	Personal Identification Number
RAM	Random Access Memory
RJ-11	Registered Jack 11
RJ-45	Registered Jack 45
RS-232	Recommended Standard 232
SAM	Security Access Module
SIM	Subscriber Identity Module
VPN	VeriFone Part Number

VERIFONE CONFIDENTIAL DRAFT

VERIFONE CONFIDENTIAL
DRAFT

Terminal Overview

This chapter provides a brief description of the VX520-G terminal:

- The VX520-G is a high performance countertop terminal with enhanced communication options.
- The VX520-G offers several communication options, enhanced display, increased processing power, expanded memory, and two USB peripheral ports.

The VX520-G terminal uses a robust, sleek, and highly functional design.

NOTE



VeriFone ships variants of the VX 520 terminals for different markets. Your terminal may have a different configuration from the features described in this section.



Figure 1 VX520-G Terminal

Features and Benefits

VX520-G terminals provide the right combination of features and functions. This includes a contactless (CTLS) reader, triple-track magnetic-stripe card reader, landed smart card reader, integrated PIN pad, and a quiet internal thermal printer (ITP). The VX520-G is a portable, line- or battery-powered device with added GPRS wireless technology.

Connectivity

- Host USB port
- Client USB port
- Telco port
- RS-232 port
- Ethernet Port

NOTE



The connectivity ports are easily accessible from the underside of the terminal.

NOTE



VeriFone ships variants of the VX 520 terminals for different markets. Your terminal may have a different configuration from the features described in this section.

Performance

- 400 MHz Processor (CPU)
- Increased memory (128 MB Flash, 32 MB RAM)
- 128/64 white backlit LCD
- Fastest encryption/decryption appliance on the market
- Backlit keypad

Security

- Increased Security (PCI 1.3 to PCI 2.0)
- SDA DDA encryption ready
- Leading ECC Performance Benchmark

Form Factor

- The VX520-G is ergonomically designed to fit both the traditional countertop and hand-over models.

Exceptional Ease of Use

- The contactless functionality offers a convenient payment option for consumers.
- The bold design is sleek, stylish, and lightweight for conveniently handing the terminal to the consumer for PIN entry or other input.
- An intuitive ATM-style interface, a large 8-line by 21-character backlit display with backlit keypad, and extra-size menu prompts, simplify training and reduce help desk calls.
- The integrated thermal printer simplifies paper loading and reduces paper jams.

Countertop Performance in a Hand-Over Design

- The triple-track, high-coercivity card reader handles most magnetic stripe cards.
- The 32-bit processing and multi-tasking capabilities ensures fast processing of payment, payment-related, and value-added applications.
- Exceptional display and printer graphics-handling capabilities that quickly render logos, graphical fonts, and character-based languages.
- The VX520-G series of terminals ensures uncompromising reliability from VeriFone, the worldwide leader in e-payment.
- The VX520-G meets the needs of TablePAY, DeliveryPAY, and CarsidePAY markets.

True Multi- Application Capability

- The VX520-G terminal offers 32 MB of random access memory, and 128 MB dynamic memory allocation of the operating system, which supports multiple applications on a single terminal.
- The primary smart card reader and the MSAMs safeguard sensitive financial data and support multiple smart card schemes.
- VX520-G terminals and SoftPay EMV software are certified for EMV Level 1 and Level 2 Type approval for smart card solutions. The Verix V or Vx EMV Library provides development of other EMV-compliant applications.
- The VeriShield security architecture meets published specifications for PCI PED and provides sophisticated file authentication to prevent execution of unauthorized software on VX520-G terminals

Wireless Connectivity

- Customers are not tied to a fixed location with the VX520-G terminals – the point of payment can be almost anywhere.
- “Always-on” wireless connection uses the latest wireless technology (GPRS) for faster transmission and enhanced compatibility with access points and routers.

VERIFONE CONFIDENTIAL
DRAFT



Terminal Setup

This chapter describes the terminal setup procedure. You will learn about:

- Selecting Terminal Location
- Unpacking the Shipping Carton
- Examining Terminal Features
- Establishing Communication
- Loading a Paper Roll in the Printer
- Installing/Replacing MSAM Cards
- Installing or Replacing SIM Card
- Connecting Optional Devices
- Connecting the Terminal Power Pack
- Charging the Smart Battery
- Privacy Shield (Optional)
- Using the CTLS Reader
- Using the Smart Card Reader
- Using the Magnetic Card Reader

Selecting Terminal Location

Use the following guidelines when selecting a location for your VX520-G terminal.

Ease of Use

- Select a location convenient for both merchant and cardholder.
- Select a flat support surface, such as a countertop or table.
- Select a location near a power outlet and a telephone/modem line connection. For safety, do not string the power cord in a walkway or place it across a walkway on the floor.

Environmental Factors

- Do not use the terminal where there is high heat, dust, humidity, moisture, or caustic chemicals or oils.
- Keep the terminal away from direct sunlight and anything that radiates heat, such as a stove or motor.

- Do not use the terminal outdoors.



The terminal is not waterproof or dustproof, and is intended for indoor use only. Any damage to the unit from exposure to rain or dust may void any warranty.

Electrical Considerations

- Avoid using this product during electrical storms.
- Do not place a CTLS device within 10cm from metallic objects to avoid interference to the CTLS field.
- Avoid locations near electrical appliances or other devices that cause excessive voltage fluctuations or emit electrical noise (for example, air conditioners, electric motors, neon signs, high-frequency or magnetic security devices, or computer equipment).
- Do not use the terminal near water or in moist conditions.

Unpacking the Shipping Carton

Open the shipping carton and carefully inspect its contents for possible tampering or shipping damage. The VX520-G terminal is a secure product and any tampering may cause the device to cease to function properly.

To unpack the shipping carton

- 1 Remove and inspect the following items:
 - Terminal
 - Power pack
 - Telephone line cord
 - Power cord
- 2 Remove all plastic wrapping from the terminal and other components.
- 3 Remove the clear protective film from the LCD screen.



Do not use a terminal that has been damaged or tampered with. The VX520-G terminal comes equipped with tamper-evident labels. If a label or component appears damaged, please notify the shipping company and your VeriFone representative or service provider immediately.

- 4 Save the shipping carton and packing material for future repacking or moving the terminal.

Examining Terminal Features

Before you continue the installation process, notice the features of the VX520-G terminal (see Figure 2).

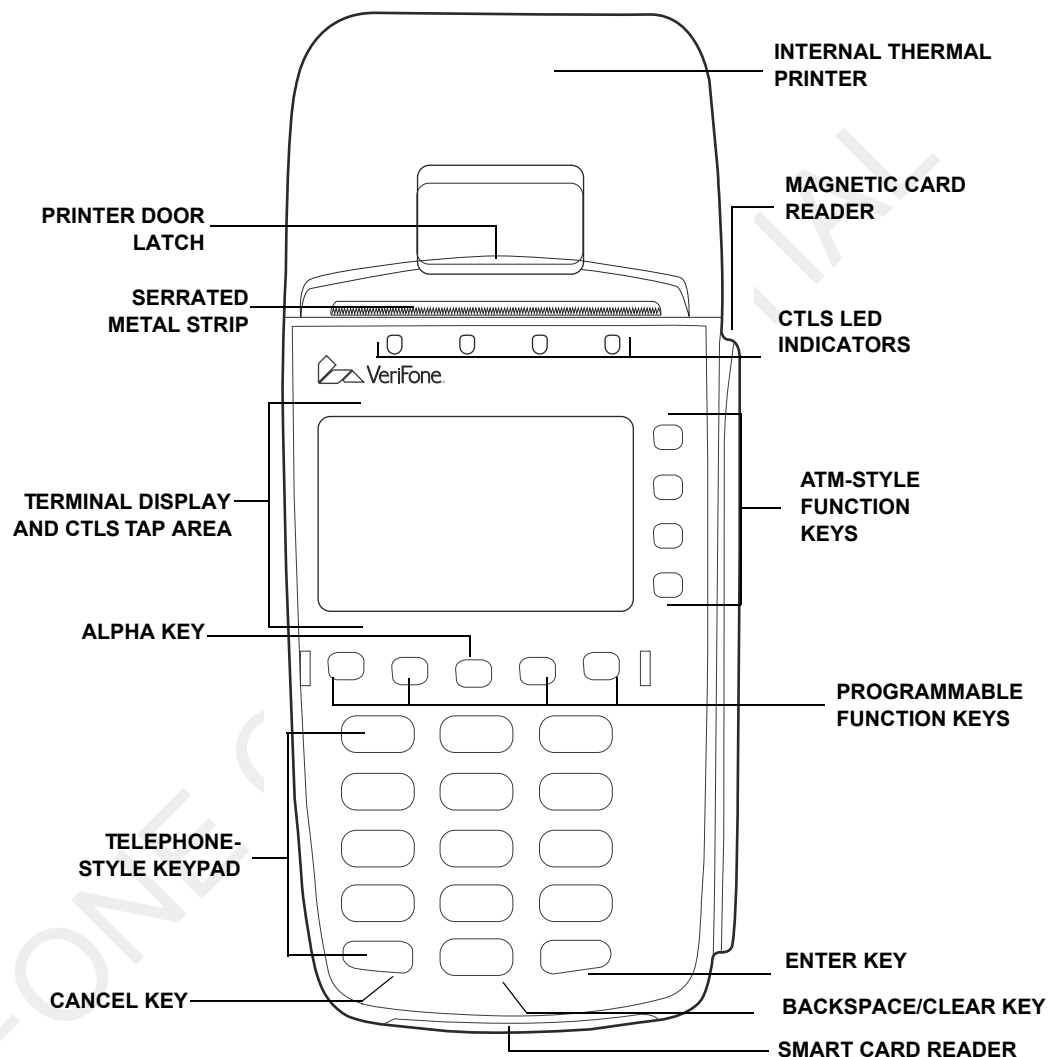

Figure 2 VX520-G Terminal Features (Front Panel)



NOTE



VeriFone ships variants of the VX520-G terminals for different markets. Your terminal may have a different configuration from the features described in this section.

Front Panel The front panel includes the following features:

- A **terminal display**, backlit LCD screen. The screen also acts as the CTLS tapping area for contactless transactions.
- Four **LED indicators** above the terminal display for CTLS transactions.
- Five types of keys:
 - a** A backlit 12-key, **telephone-style keypad**.
 - b** Four **ATM-style function keys**, labeled F1 to F4, to the right of the LCD screen.

- c Four unlabeled, **programmable function keys** above the keypad.
- d Three **color-coded function keys** below the keypad (icons at right; from left to right: CANCEL, BACKSPACE/CLEAR, ENTER). 
- e An **ALPHA key** centered at the top of the keypad.
- A **magnetic card reader**, built into the right side. The icon at right shows the proper swipe direction, with the stripe down and facing inward, toward the keypad. 
- The VeriFone logo **blue indicator LED** indicates power is ON.
- An **internal thermal printer**.
- A **smart card reader**, built into the front of the terminal. The icon shown at right indicates proper card position and insertion direction. 
- Three **SAM (security access module) compartments**, built into the side of the terminal. The VX 520 GPRS CTLS terminal contains MSAM cardholders to support multiple stored-value card programs or other merchant card requirements.

NOTE



VeriFone ships variants of the VX 520 GPRS CTLS terminal for different markets. Your terminal may have a different configuration. However, the basic processes described in this guide remain the same, regardless of terminal configuration.

Connection Ports

Turn the terminal upside down and remove the rear cover to view the connection ports. Notice that the ports are recessed. Different ports provide connections to a communications line, optional peripheral devices, and the power supply.

Figure 3 shows how to open the rear cover of the VX 520 GPRS CTLS terminals.

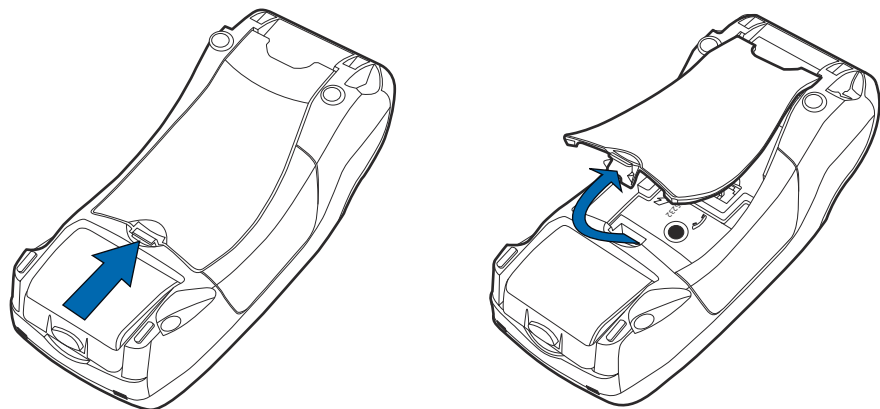

Figure 3 Opening the VX 520 GPRS CTLS Rear Cover

Figure 4 to Figure 5 show the connection ports for the VX 520 GPRS CTLS terminal.

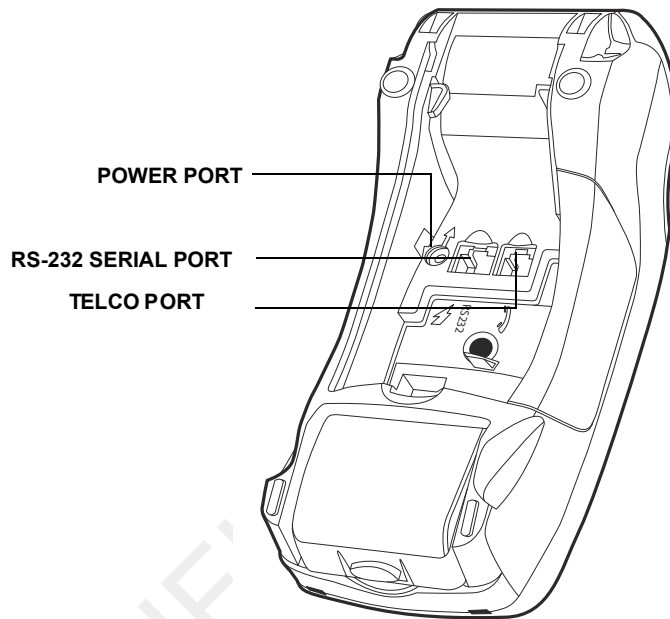

Figure 4 VX 520 GPRS CTLS Power and Connection Ports

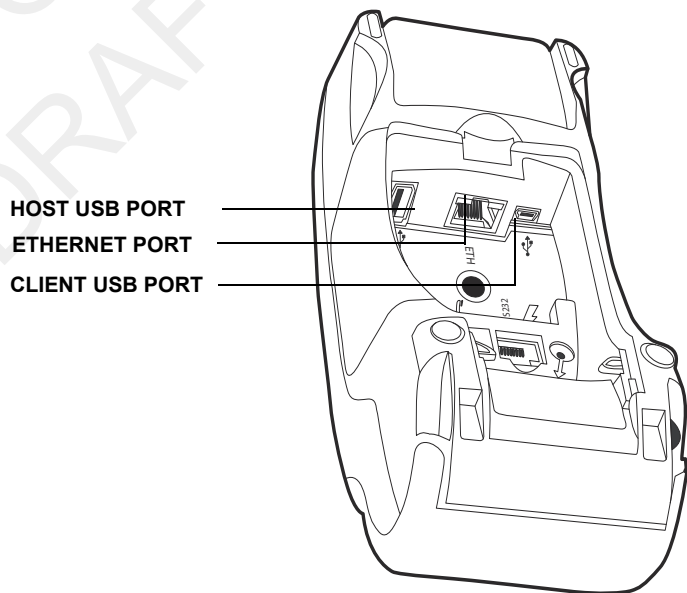

Figure 5 Additional VX 520 GPRS CTLS Connection Ports



WARNING Do not connect the terminal to the power supply until all the peripherals are attached.

To use the connection ports The connection ports offer multiple connectivity for the VX520-G terminal. Please refer to the following list of peripheral devices for the connectivity options.

Host USB Port

- PP1000 USB
- V*810 USB
- VX 820 USB
- Barcode reader
- Biometric reader
- USB flash disk
- USB keyboards

Ethernet Port

- Ethernet cable to router, hub or switch

Client USB Port

- PC
- ECR/Cash register

Telco Port

- Telephone line

RS-232 Port

- PP1000
- V*810
- VX 820
- PC download cable
- Computer
- ECR
- Check reader
- CTLS reader
- Biometric reader
- Barcode reader
- Keyboard

For information on how to attach peripheral devices, see [Connecting Optional Devices](#).

Establishing Communication

You can connect the VX 520 GPRS CTLS using three options: By telephone line, by ethernet and via GPRS.

Connecting by Telephone Line.

Connect the telephone cord to the communication port on the terminal, then route it directly to a telephone wall jack (see Figure 6). This is a direct connection and the line is dedicated to the terminal.

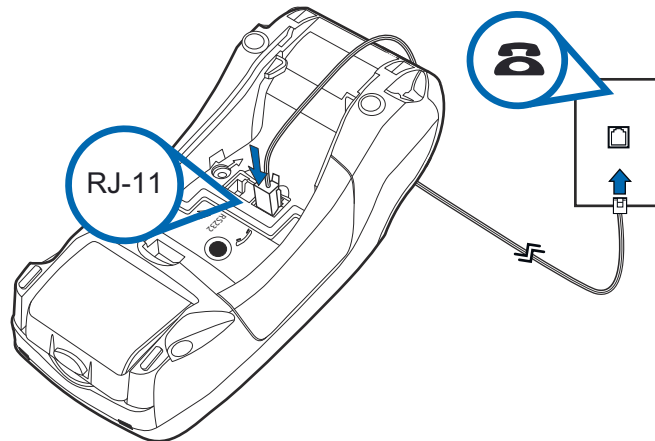

Figure 6 VX 520 GPRS CTLS Direct Telephone Connection



WARNING

To reduce the risk of fire, use only No. 26AWG or larger UL Listed or CSA Certified Telecommunication Line Cord.

Connecting by Ethernet

Connect the ethernet cable to the ETH port on the terminal, then route it directly to a network wall jack (see Figure 7). This is a direct connection to your network.

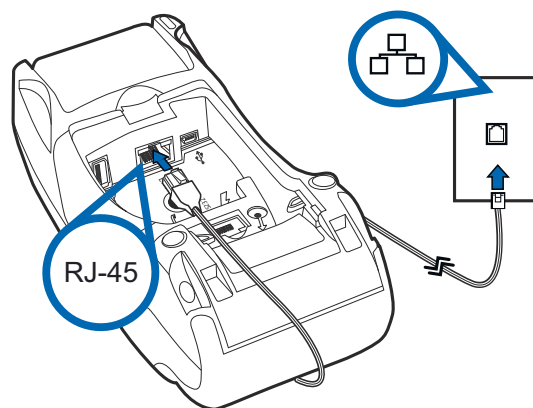

Figure 7 VX 520 GPRS CTLS Ethernet Connection

Connecting by GPRS

Insert the SIM card according to the instructions on [Installing or Replacing SIM Card](#) to get your VX 520 GPRS CTLS connected to the GPRS network provider.

Loading a Paper Roll in the Printer

Before you can process transactions that require a receipt or record, you *must* install paper in the printer.

The VX520-G uses a roll of 40 mm-diameter, single-ply, thermal-sensitive paper.

A pink *out-of-paper* indicator line appears on the edge of the paper before the end of the roll. After this line appears, there is enough paper remaining on the roll to conclude at least one transaction.



CAUTION Poor-quality paper can jam the printer and create excessive paper dust. To order high-quality VeriFone paper, refer to [Accessories and Documentation](#).

Store thermal paper in a dry, dark area. Handle thermal paper carefully: impact, friction, temperature, humidity, and oils affect the color and storage characteristics of the paper.

Never load a roll of paper with folds, wrinkles, tears, or holes at the edges.

- To install a paper roll**
- 1 Hook your finger under the latch and lift up to swing the paper roll cover open (see [Figure 8](#)).

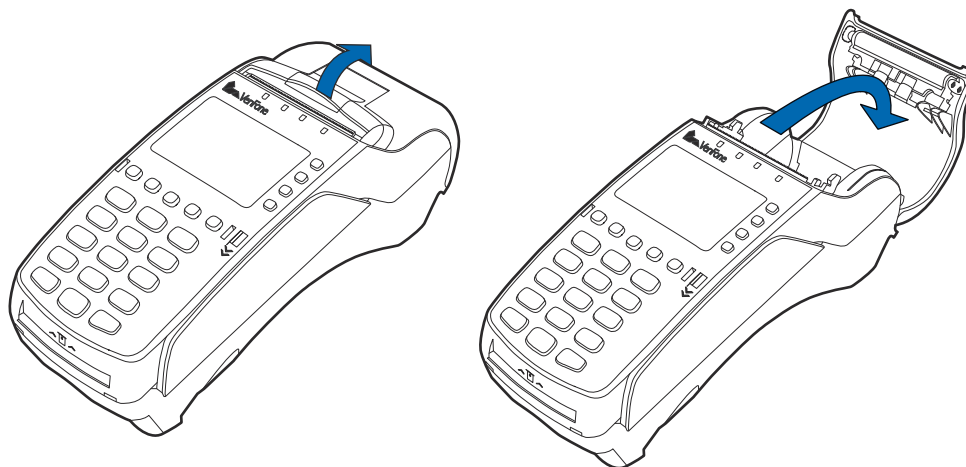

Figure 8 Opening the Printer Cover

- 2 Remove any partial roll of paper in the printer tray by lifting it up.
- 3 Loosen the glued leading edge of the new paper roll or remove the protective strip. Unwind the paper roll past any glue residue.
- 4 Hold the roll so the paper feeds from the *bottom* of the roll.

- 5 Drop the paper roll into the printer tray.

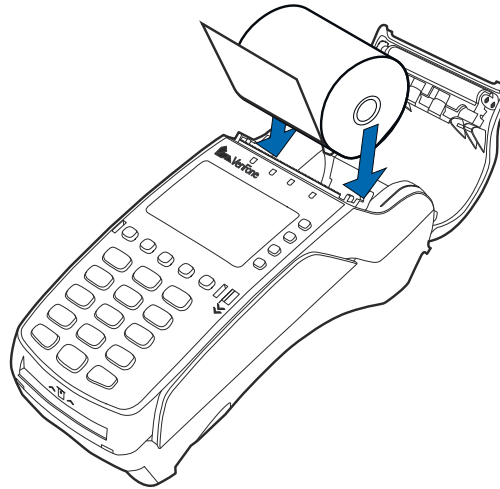

Figure 9 Loading Paper Roll

- 6 Pull paper up past the glue residue.
- 7 Close the paper roll cover by gently pressing directly on the cover until it clicks shut, allowing a small amount of paper past the glue residue to extend outside the printer door. (see [Figure 10](#)).

CAUTION



To prevent the paper roll cover from damaging the print roller, always gently press down on the printer dust cover to close it.



Figure 10 Closing Paper Roll Cover

- 8 Tear the paper off against the serrated metal strip in the printer.

NOTE



For paper ordering information, refer to [Accessories and Documentation](#).

Installing/ Replacing MSAM Cards

When you first receive your VX 520GPRS CTLS terminal, you may need to install one or more MSAM cards or you may need to replace old cards.



CAUTION Observe standard precautions when handling electrostatically sensitive devices. Electrostatic discharges can damage this equipment. VeriFone recommends using a grounded anti-static wrist strap.

To install or replace MSAMs

- 1 Remove the power cord from the power outlet.
- 2 Place the terminal upside down on a soft, clean surface to protect the display from scratches.
- 3 Press the unlocking button and then lift the rear cover to access the MSAM cardholder panel.

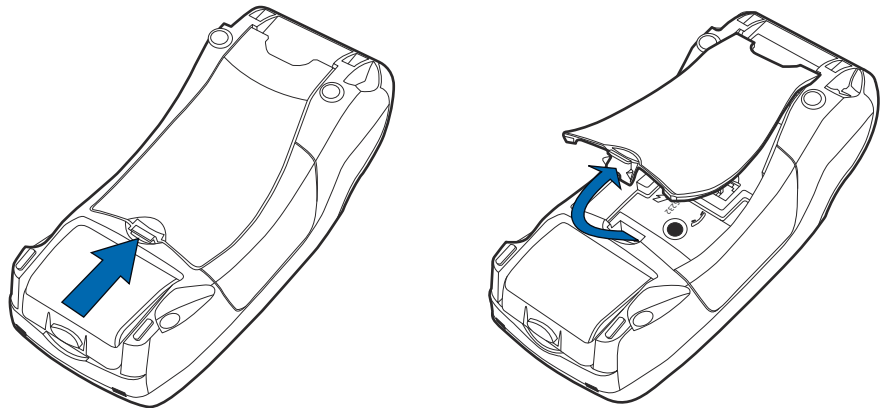

Figure 11 Opening VX 520 GPRS CTLS Rear Cover

- 4 Hold the MSAM cardholder panel, grasp firmly and pull upward to expose the MSAM slots.

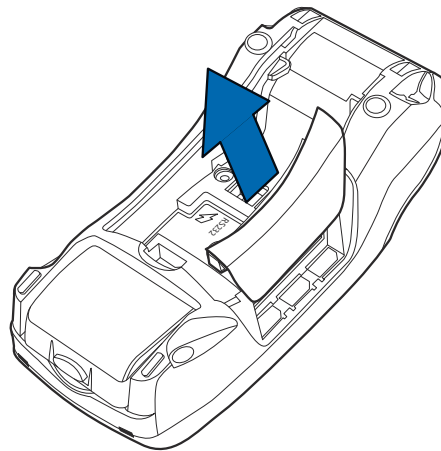

Figure 12 Removing VX 520 GPRS CTLS MSAM Cover

- 5 Remove any previously installed MSAM card by sliding the card from the MSAM cardholder.

- 6 Install an MSAM card by carefully sliding it into the slot until it is fully inserted.

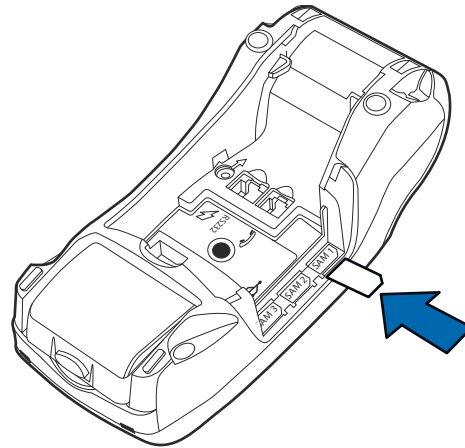

Figure 13 Installing an MSAM Card in a VX 520 GPRS CTLS Terminal



Before inserting the MSAM card, position it as shown in Figure 13, with the card's gold contacts facing down. The cardholder connector base has an image resembling the notched corner of an MSAM card to ensure the card is positioned correctly.

- 7 Close the MSAM cardholder panel, and then replace the terminal rear cover.

Installing or Replacing SIM Card

The VX 520 GPRS terminal supports the installation of a SIM (Subscriber Identity Module) card. Use the following procedure to replace or install a SIM card.

- 1 Place the terminal upside down on a soft, clean surface to protect the display from scratches.
- 2 Remove the battery.

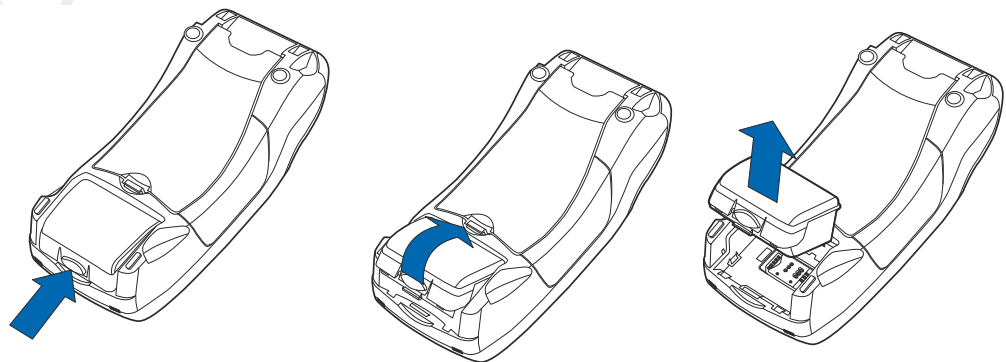

Figure 14 Removing the Smart Battery

- 3 After removing the battery, you will see the SIM compartment.

- 4 Insert the SIM into the cardholder.

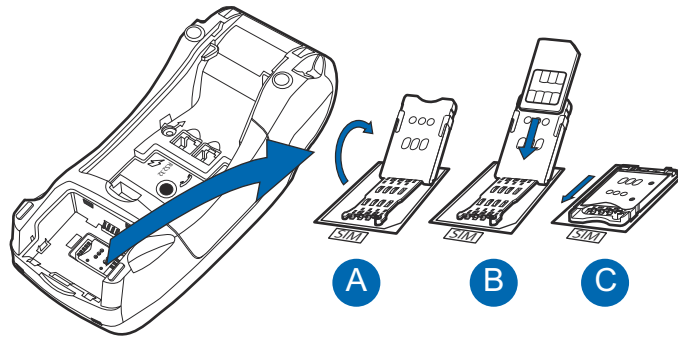

Figure 15 Inserting SIM Card

- 5 Install the battery.

Connecting Optional Devices

The VX 520 GPRS CTLS terminal supports some peripheral devices designed for use with electronic point-of-sale terminals.



CAUTION Before connecting any peripheral device, remove the power cord from the terminal and ensure that the green indicator LED is not lit. Reconnect the power cord only *after* you are finished connecting the peripheral device(s). For complete information about peripheral installation and use, refer to the user documentation supplied with those devices.

Different terminals support different devices, so for more information about optional devices, please contact your VeriFone distributor.

Optional Device Connections

The VX 520 GPRS CTLS terminal has a port that can operate either as a PIN pad port or an RS-232 port, depending on the power source available.

Connecting a PIN Pad to the VX 520 GPRS CTLS

Use the following procedures to connect a PIN pad or smart card reader.



NOTE When the VX 520 GPRS CTLS terminal is powered via the corded power supply, the terminal provides 4.0 A at 9.3V DC. This power will drive most VeriFone accessories. Contact your local VeriFone representative for more information.

- 1 Remove the VX 520 GPRS CTLS terminal rear cover.
- 2 Insert the RJ-45-type connector of the PIN pad or smart card reader into the port of the peripheral device.

To install a PINpad 101, PINpad 201, or PINpad 1000, position and insert the grommet to secure the cable connection.

If a cable is not already connected to the smart card reader or PIN pad, insert the small modular plug on one end of the interface cable into the optional device's modular jack.

- 3 Insert the larger RJ-45-type connector on the other end of the PIN pad cable into the PIN pad serial port on the terminal. [Figure 16](#) provides an example of a smart card reader and PIN pad connection to the PIN pad serial port.

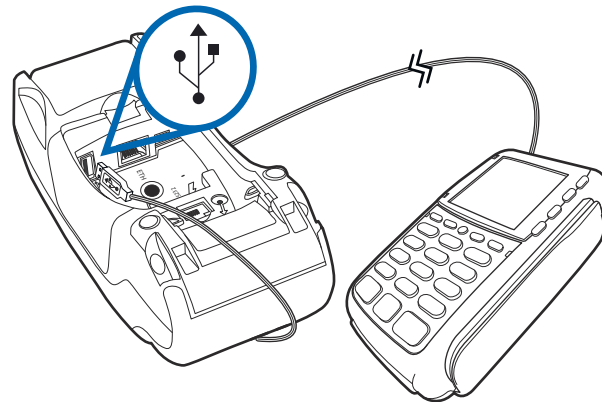

Figure 16 VX 520 GPRS CTLS Sample PIN Pad Connection

**Connecting ECRs to
the VX 520 GPRS
CTLS**

The VX 520 GPRS CTLS terminal also supports electronic cash registers (ECR). Contact your VeriFone representative or visit the online store at www.store.verifone.com for information on these devices.

[Figure 17](#) provides an example of a peripheral connection to the USB port.



ECRs require a separate power source. Before connecting a check reader or similar device, remove the power cord from and ensure that the indicator LED is not lit.

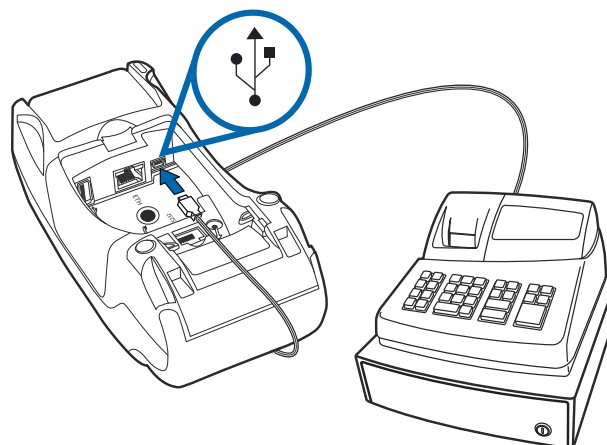

Figure 17 VX 520 GPRS CTLS Sample ECR Connection

External Printers Supported

Although the VX520-G terminal has an internal thermal printer, it may be convenient to print larger print runs (for example, daily or weekly reports) to an external printer. The VX 520-G terminal supports the VeriFone P250, P350, P900, and P950 external printers. Contact your VeriFone representative or visit the online store at www.store.verifone.com for information on these devices. External printers connect through the RS-232 port and require a separate power supply.

Installing the Smart Battery

The smart battery fits in a slot on the back of the VX520-G terminal. The locking tab clicks when the battery is in place. The slot is keyed, so that there is only one way to insert the battery.

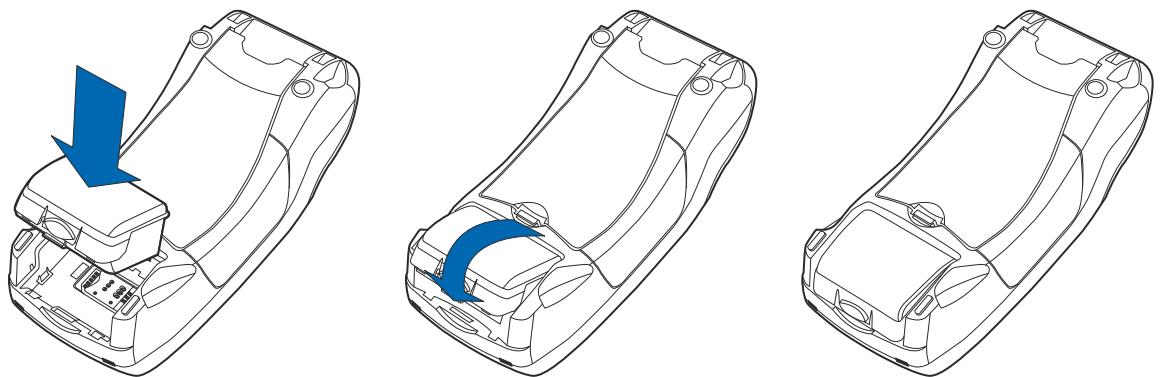

Figure 18 Installing the Smart Battery

Smart Battery Removal

To remove the VX520-G smart battery, press the locking tab and pull the smart battery from its slot.

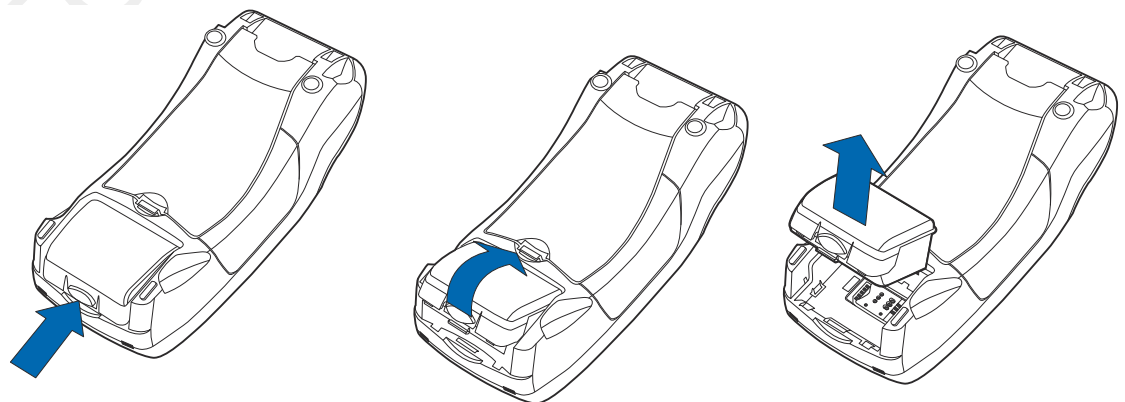

Figure 19 Removing the Smart Battery

Charging the Smart Battery

After installing the battery on your VX520-G terminal, connect the power pack to the unit for at least 6 hours or until fully charged.

The smart battery has a safety circuit to protect the Li-ion cells from overcharging and over-discharging. If the battery is over-discharged, the safety circuit shuts down the battery. The battery must then be recharged to restore operation.

NOTE



The VX520-G terminal automatically shuts off when the smart battery reaches the critically low charge state. If this occurs, the smart battery must be recharged for a minimum of 1/2 hour before it can power the terminal. It may take several recharge attempts to reset the safety circuit when charging a smart battery that has been discharged below this critical state.

Battery Life

The VX520-G smart battery can be charged and discharged hundreds of times, but will eventually wear out. When operating times are noticeably shorter than usual, it is time to buy a new battery (see [Accessories and Documentation](#) for ordering information).

WARNING



Do not dispose of batteries in a fire. Li-ion batteries must be recycled or disposed of properly. Do not dispose of Li-ion batteries in municipal waste sites.

Connecting the Terminal Power Pack

When you have finished connecting optional peripherals, you are ready to connect the VX520-G terminal to the provided power source.

WARNING



Using an incorrectly rated power supply may damage the terminal or cause it not to work as specified. Before troubleshooting, ensure that the power supply being used to power the terminal matches the requirements specified on the bottom of the terminal. (See [Chapter 3, Specifications](#), for detailed power supply specifications.) Obtain the appropriately rated power supply before continuing with troubleshooting.

NOTE



Plugging in the power pack to a power source automatically turns on the terminal.

To connect the terminal power pack

- 1 Remove the terminal rear cover to access the power port.

- 2 Insert the round barrel connector (see Figure 20) into the power port.

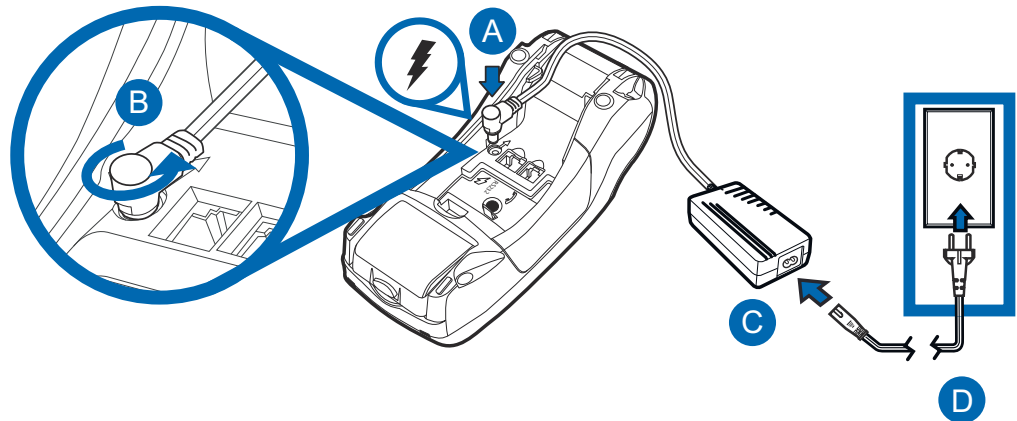

Figure 20 VX 520 GPRS CTLS Power Connection

- 3 Rotate the power plug counter-clockwise and flush against the side panel to lock the plug in place.
- 4 Route the cable in the direction of the arrow above the power port and sling the cable over the underside of the thermal paper container.
- 5 Close the terminal rear cover.
- 6 Insert the AC power cord into the power pack.
- 7 Plug the AC power cord into a wall outlet or powered surge protector.

WARNING Do not plug the power pack into an outdoor outlet or operate the terminal outdoors.



Disconnecting the power during a transaction may cause transaction data files not yet stored in terminal memory to be lost.

To protect against possible damage caused by lightning strikes and electrical surges, consider installing a power surge protector.

NOTE



VeriFone recommends connecting wall power in the following order:

- 1 Connect the terminal to the power supply.
- 2 Connect the power supply to the power cord (if applicable).
- 3 Connect the power cord to the wall outlet.

When the terminal has power, the terminal lights are activated and the LED indicator remains lit.

If an application is loaded in the terminal, it starts after the initial VeriFone copyright screen and usually displays a unique copyright screen. If no application is loaded in the terminal, **DOWNLOAD NEEDED** appears on screen after the initial VeriFone copyright screen.

Privacy Shield (Optional)

The privacy shield protects the customers' PIN entry from being seen by the cashier or other customers. The illustration (Figure 21) shows an example of a VX520-G with the optional privacy shield.



Figure 21 Optional Privacy Shield



NOTE Merchants who install the terminal without the privacy shield must ensure the cardholder's privacy when entering his PIN by positioning the terminal away from open view.

Using the CTLS Reader

The VX520-G function only gets activated when an application signals the start of a contactless smart card transaction.

To perform a contactless smart card transaction:

- 1 Gently tap the card onto or hold the card (within 4 cm) against the surface of the RFID canopy (see Figure 22).
- 2 An activated LED visual on top of the terminal display accompanied by a short beeping sound indicates a successful transaction.



Figure 22 Using a CTLS Card



NOTE Make sure you prevent the contactless module from coming into contact with metallic surfaces while in use. Taking care of the module ensures proper function throughout the operating life of your VX520-G.

Using the Smart Card Reader

The smart card transaction procedure may vary from one application to another. Verify the procedure with your application provider before performing a smart card transaction.

To conduct a smart card transaction

- 1 Position a smart card with the contacts facing upward (see [Figure 23](#)).
- 2 Insert the smart card into the smart card reader slot in a smooth, continuous motion until it seats firmly.
- 3 Remove the card only when the application indicates the transaction is complete.

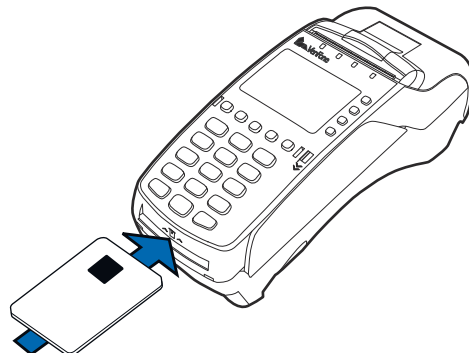

Figure 23 Inserting a Smart Card



Leave the smart card in the card reader until the transaction is complete. Premature card removal will invalidate the transaction.

Using the Magnetic Card Reader

The VX520-G terminal supports credit or debit card transactions.

To conduct a credit or debit card transaction

- 1 Position a magnetic card with the stripe in the card reader and facing inward, toward the keypad.
- 2 To ensure a proper read of the magnetic swipe card, the user should insert the magnetic card from the top of the unit, as shown in [Figure 24](#).
- 3 Swipe the card through the magnetic card reader.

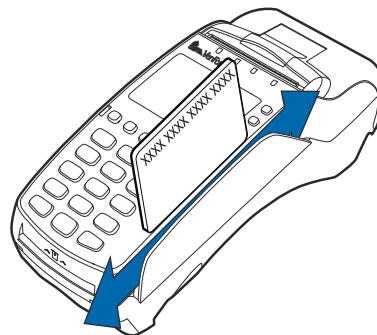

Figure 24 Using the Magnetic Card Reader

Specifications

This chapter discusses power requirements, dimensions, and other specifications of the VX520-G terminal:

Power VX520-G terminal:

37.2W: 9.3V DC; 4.0 A

NOTE



The VX 520 uses an 18-watt wall-mount power supply as a standard power source. An optional 37.2-watt power supply may also be used for all other variants of the VX 520. The VX520-G requires the 37.2-watt power supply.

DC Power Pack UL, ITE listed, LPS power supply:

a Input rated: 100 - 240V AC, 50/60 Hz

b Output rated:

37.2W: 9.3V DC; 4.0 A

Barrel connector polarity:



Temperature

- Operating temperature: 0° to 40° C (32° to 104° F)
- Storage temperature: -30° to + 60° C (-22° to 140° F)
- Relative humidity: 5% to 85%; no condensation

External Dimensions

- Length: 203 mm (7.9 in)
- Width: 87 mm (3.4 in)

VERIFONE CONFIDENTIAL
DRAFT

Maintenance

The VX520-G terminal has no user-maintainable parts.

Cleaning the Terminal

To clean the terminal, use a clean cloth slightly dampened with water and a drop or two of mild soap. For stubborn stains, use alcohol or an alcohol-based cleaner.

CAUTION



Never use thinner, trichloroethylene, or ketone-based solvents – they may cause deterioration of plastic or rubber parts.

Do not spray cleaners or other solutions directly onto the keypad or terminal display.

Terminal Contacts

Gently swab the contacts with alcohol or contact cleaner to remove the dirt. It is important that the exposed contacts of the VX520-G terminal stay clean and unbent.

CAUTION



Avoid touching the contacts of the terminal. Finger oils tarnish contacts, causing bad connections. When experiencing a high occurrence of bad or incomplete data transfers, clean the contacts.

Smart Card Reader

Do not attempt to clean the smart card reader. Doing so may void any warranty. For smart card reader service, contact your VeriFone distributor or service provider.

VERIFONE CONFIDENTIAL
DRAFT

Troubleshooting Guidelines

The troubleshooting guidelines provided in the following section are included to assist you to successfully install and configure your VX520-G terminal. If you have problems operating your VX520-G, please read through these troubleshooting examples.

If the problem persists even after performing the outlined guidelines or if the problem is not described below, contact your local VeriFone representative for assistance. Typical examples of malfunction you may encounter while operating your VX520-G terminal and steps you can take to resolve them are listed.

NOTE



The VX520-G terminal comes equipped with tamper-evident labels. This terminal contains no user serviceable parts. Do not, under any circumstance, attempt to disassemble the terminal. Perform only those adjustments or repairs specified in this guide. For all other services, contact your local VeriFone service provider. Service conducted by parties other than authorized VeriFone representatives may void any warranty.

CAUTION



Using an incorrectly rated power supply may damage the terminal or cause it not to work as specified. Use only a VeriFone-supplied power pack with the correct output ratings. Before troubleshooting, ensure that the power supply being used to power the terminal matches the requirements specified on the bottom of the terminal. (See [Specifications](#) for detailed power supply specifications.) Obtain the appropriately rated power supply before continuing with troubleshooting.

Blank Display

When the terminal display screen does not show correct or clearly readable information:

- Check terminal power connection.
- Remove and reapply power to the terminal.
- Check the battery status.
- Check all cable connections and verify that the telephone line is properly connected.
- If the problem persists, contact your local VeriFone service provider.

Terminal Does Not Dial Out

If the terminal does not dial out:

- Check the telephone line connections.
- Check that the telephone line is working by plugging it into a working telephone and listening for a dial tone.
- Replace the telephone cable that connects the terminal with a cable you know is working correctly.
- If the problem persists, contact your local VeriFone service provider.

Printer Paper Jam

If paper jams inside the printer:

- Open the paper roll cover.
 - Remove the damaged paper from the paper roll and clear the feed mechanism.
 - Install printer paper.
 - If the problem persists, it may be due to poor paper quality. Install a new roll of higher-quality paper.

CAUTION



Poor-quality paper may jam the printer. To order high-quality VeriFone paper, refer to [Accessories and Documentation](#).

Keypad Does Not Respond

If the keypad does not respond properly:

- Check the terminal display. If it displays the wrong character or nothing at all when you press a key, follow the steps outlined in [Transactions Fail To Process](#).
- If pressing a function key does not perform the expected action, refer to the user documentation for that application to ensure you are entering data correctly.
- If the problem persists, contact your local VeriFone representative.

Peripheral Device Does Not Work

If any peripheral device (PIN pad or smart card reader) does not work properly:

- Check the power cord connection to the peripheral device.
- Check that the device connected to the proper port has power and is functioning properly. If possible, perform a self-test on the device in question.
- The cable connecting the optional device to the terminal serial port may be defective. Try a different serial cable. See [Connecting Optional Devices](#).
- If the problem persists, contact your local VeriFone representative.

Transactions Fail To Process

There are several reasons why the terminal may not be processing transactions. Use the following steps to troubleshoot failures.

Check the Magnetic Card Reader

- Perform a test transaction using one or more different magnetic stripe cards to ensure the problem is not a defective card.
- Ensure that you are swiping cards properly. With the card reader, the black magnetic stripe on the card should face down and inward, toward the keypad and must be inserted from the top of the terminal.
- Process a transaction manually, using the keypad instead of the card reader. If the manual transaction works, the problem may be a defective card reader.
- If the manual transaction does not work, proceed to [Check the Telephone Line](#).
- Contact your VeriFone distributor or service provider.

Check the Smart Card Reader

- Perform a test transaction using several different smart cards to ensure the problem is not a defective card.
- Ensure that the card is inserted correctly and that the card is not removed prematurely.
- Ensure the MSAM cards are properly inserted in the cardholders and that the cardholders are properly secured (see [Installing/Replacing MSAM Cards](#)).
- If the manual transaction does not process, proceed to [Check the Telephone Line](#).
- Contact your VeriFone distributor or service provider.

Check the Telephone Line

- Disconnect the telephone line from the terminal and connect it to a working telephone to check for a dial tone. If there is no dial tone, replace the telephone cable.
- If the problem appears to be with the telephone line, check with the party you are trying to call to see if their system is operational. If they are not experiencing difficulties with their line, contact the telephone company and have your line checked.
- If the telephone line works, contact your local VeriFone representative for assistance.

Printer Does Not Print

If the printer does not work properly:

- Check terminal power connection.
- Check if the printer is out of paper and that the roll is properly installed. Open the paper roll cover and install a new roll of printer paper or ensure that the roll is feeding from the bottom.
- Verify that the printer roller and paper roll dust cover are properly installed.
- If the problem persists, contact your VeriFone distributor or service provider.

Terminal Display Does not Show Correct or Readable Information

- Connect the terminal in to a known-good power supply (if you have one) to see if this clears the problem.
- If the problem persists, contact your local VeriFone representative for assistance.

Terminal Does Not Start

Make sure you press the **ENTER** key for approximately 3 seconds, until the unit lights up.

VeriFone Service and Support

For terminal problems, contact your local VeriFone representative or service provider.

For product service and repair information:

- USA – VeriFone Service and Support Group, 1-800-VeriFone (837-4366), Monday - Friday, 8 A.M. - 8 P.M., Eastern time
- International – Contact your VeriFone representative

Return a Terminal for Service

Before returning a VX520-G terminal to VeriFone, you must obtain an MRA number. The following procedure describes how to return one or more VX520-G terminals for repair or replacement (U.S. customers only).

NOTE



International customers are advised to contact their local VeriFone representative for assistance regarding service, return, or replacement of terminals.

To return a terminal for service

- 1 Get the following information from the printed labels on the bottom of *each* VX520-G terminal to be returned:
 - Product ID, including the model and part number. For example, “VX520-G” and “Pxxx- xxx-xx,” “Mxxx-xx-xx-xxx,” or “2xxxx-xx”
 - Serial number (S/N xxx-xxx-xxx)
- 2 Obtain the MRA numbers by completing one of the following:
 - a Call VeriFone toll-free within the United States at 1-800-VeriFone and follow the automated menu options.
 - Select the MRA option from the automated message. The MRA department is open Monday to Friday, 8 A.M.–8 P.M., Eastern Time.
 - Give the MRA representative the information you gathered in Step 1. If the list of serial numbers is long, you can fax the list, along with the information gathered in Step 1, to the MRA department at 727-953-4172 (U.S.).
 - b Address a fax to “VeriFone MRA Dept.” with the model and part number(s)
 - Include a telephone number where you can be reached and your fax number.

- c Complete the Inquiry Contact Form at http://www.verifone.com/aboutus/contact/contact_form.cfm.
 - Address the Subject box with to “VeriFone MRA Dept.”
 - Reference the model and part number in the Note box.

NOTE



One MRA number must be issued for each VX520-G terminal you return to VeriFone, even if you are returning several of the same model.

- 3 Describe the problem(s).
- 4 Provide the shipping address where the repaired or replacement unit must be returned.
- 5 Keep a record of the following items:
 - Assigned MRA number(s).
 - VeriFone serial number assigned to the VX520-G terminal you are returning for service or repair (terminal serial numbers are located on the bottom of the unit).
 - Shipping documentation, such as air bill numbers used to trace the shipment.
 - Model(s) returned (model numbers are located on the VeriFone label on the bottom of the VX520-G terminal).

Accessories and Documentation

VeriFone produces the following accessories and documentation for the VX520-G terminal. When ordering, please refer to the part number in the left column.

- VeriFone online store at www.store.verifone.com
- USA – VeriFone Customer Development Center, 800-VeriFone (837-4366), Monday - Friday, 7 A.M. - 8 P.M., Eastern time
- International – Contact your VeriFone representative

Power Pack

Contact your local VeriFone distributor to determine which power pack or power cord fits your needs.

VPN PWR258-001-01-A

36W power supply

VPN WIR30017

AC power cord (US)

NOTE



The VX 520 uses an 18-watt wall-mount power supply as a standard power source. An optional 37.2-watt power supply may also be used for all other variants of the VX 520. However, the VX520-G requires the 37.2-watt power supply to optimize battery charging.

Spare Battery	VPN 24016-01-R	VX 520 GPRS CTLS spare battery
Printer Paper	VPN PPR 268-001-01-A	40 mm (1.57 in) diameter, 57 mm (2.24 in) wide
Supplementary Hardware	STA252-001-01-A Swivel	stand
	STA252-005-01-A W	all-mount stand
VeriFone Cleaning Kit	VPN 02746-01	Cleaning kit
Telephone Line Cord	VPN CBL000-001-01-A	2.1 meter (7 foot) telephone line cord, black, with modular RJ-11-type connectors
Documentation	VPN DOC252-061-EN	<i>VX 520 GPRS CTLS Certifications and Regulations</i>
	VPN DOC252-062-EN	<i>VX 520 GPRS CTLS Quick Installation Guide</i>
	VPN DOC252-064-EN	<i>VX 520 GPRS CTLS Reference Manual</i>
	VPN DOC252-003-EN	<i>VX 520 Installation Guide</i>
	VPN DOC252-004-EN	<i>VX 520 Reference Manual</i>
	VPN DOC252-021-EN	<i>VX 520 GPRS Certifications and Regulations</i>
	VPN DOC252-031-EN	<i>VX 520 CTLS Certifications and Regulations</i>
	VPN DOC252-032-EN	<i>VX 520 CTLS Quick Installation Guide</i>
	VPN DOC252-033-EN	<i>VX 520 CTLS Installation Guide</i>

VERIFONE CONFIDENTIAL
DRAFT



A

- accessories **40**
 - documentation **41**
 - ordering **41**
 - power packs **40**
 - printer paper **41**
 - spare battery **41**
 - telephone line cord **41**
 - VeriFone cleaning kit **41**

B

- battery
 - charging **27**

C

- charging
 - Smart battery **27**
- cleaning kit **41**
- connection ports
 - VX520-G **16**
- contact VeriFone **39**

D

- dial out problems
 - troubleshooting **36**
- displays
 - troubleshooting **35, 38**
- documentation **40**
 - acronym definitions **6**
 - conventions **6**
 - ordering **41**

E

- electrical considerations **14, 22**
- electrostatic discharges **22**
 - prevention **22**
- environmental factors **13**
- external printers
 - VX520-G RS-232 port connection **26**
- external printers supported

VeriFone external printers **26**

I

- installation
 - connecting a PIN pad to VX520-G **24**
- installation VX520-G
 - connecting a smart card reader to VX520-G **24**
 - connecting optional device(s) **24**
 - connecting the terminal power pack **27**
 - connecting the terminal to a telephone line **19**
- MSAM cards **22**
- SIM cards **24**
- Smart battery **26**
- terminal location **13**
- unpacking the shipping carton **14**
- integrated printers
 - paper jams **36**
 - troubleshooting **38**
- integrated printers VX520-G
 - about the integrated printer paper **20**

K

- keypads
 - troubleshooting **36**

M

- maintenance **39**
 - avoid cleaning Smart Card Reader **33**
 - cleaning the terminal **33**
 - cleaning the terminal contacts **33**
 - returning a terminal for repair or replacement **39**
- MSAM cardholders **22**
- MSAM cards
 - installation **22**

O

- optional devices
 - connecting **24**

P

- paper
 - for integrated printers **20**
- paper jams
 - troubleshooting **36**
- peripheral devices
 - troubleshooting **36**
- peripherals
 - troubleshooting **36**
- power packs
 - AC version **40**
 - connecting **27**
 - DC version **40**
 - ordering **40**
- printer paper **41**
 - 40 mm thermal **41**
- printer paper VX520-G
 - storage **20**
- printers
 - troubleshooting **38**
- privacy shield
 - VX520-G **29**

S

- Service **39**
- service
 - returning a terminal for repair or replacement **39**
- SIM cardholders **24**
- SIM cards
 - installation **24**
- Smart battery
 - installation **26**
- spare battery **41**
- specifications
 - VX520-G external dimensions **31**
 - VX520-G power **31**
 - VX520-G power pack **31**
 - VX520-G temperature **31**

T

- technical support **39**
 - contacting VeriFone **39**
 - returning a terminal for repair or replacement **39**
- telephone line connections **19**
- telephone line cords

- ordering **41**
- terminal features
 - VX520-G general **15**
- terminals
 - accessories **40**
 - benefits **10**
 - cleaning **33**
 - documentation **40**
 - environmental factors **13**
 - repair **39**
 - replacement **39**
 - troubleshooting **35, 38**
 - VX520-G features **15**
- transactions
 - VX520-G contactless cards **29**
 - VX520-G magnetic cards **30**
 - VX520-G smart cards **30**
- troubleshooting
 - displays **35, 38**
 - keypads **36**
 - peripheral devices **36**
 - peripherals **36**
 - printers **38**
 - starting the terminal **38**
 - terminal transactions **37**
 - terminals **36, 38**

V

- VX520-G
 - charging Smart battery **27**
 - multi-application capability **11**
 - SIM card installation **23**
 - Smart battery **27**
- VX520-G terminals
 - electrical considerations **14**
- VX520-G wireless capability **11**

VERIFONE CONFIDENTIAL
DRAFT



VeriFone, Inc.
2099 Gateway Place, Suite 600
San Jose, CA, 95110 USA
Tel: (800) VeriFone (837-4366)
www.verifone.com

VX520-G

Installation Guide

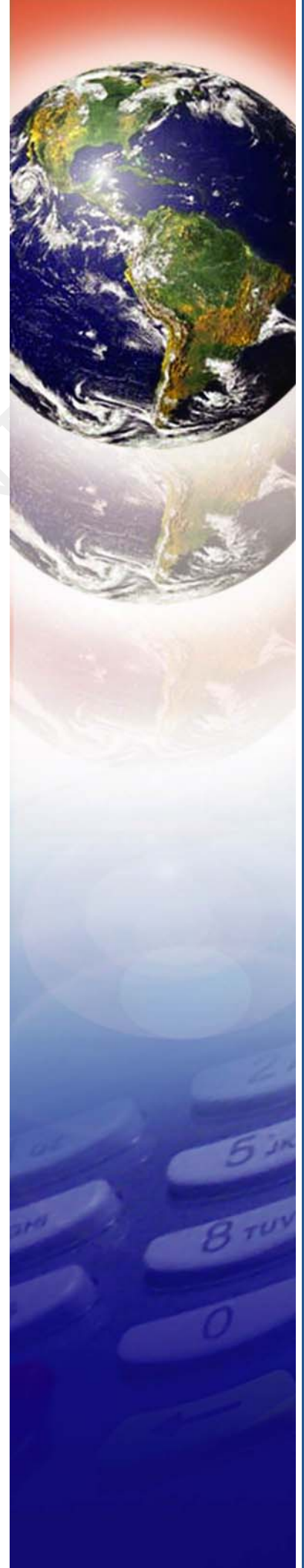

VERIFONE CONFIDENTIAL
DRAFT