

# VX 685/NX 690

## *Installation Guide*



VX 685/VX 690 Installation Guide  
© 2015 Verifone, Inc.

All rights reserved. No part of the contents of this document may be reproduced or transmitted in any form without the written permission of Verifone, Inc.

The information contained in this document is subject to change without notice. Although Verifone has attempted to ensure the accuracy of the contents of this document, this document may include errors or omissions. The examples and sample programs are for illustration only and may not be suited for your purpose. You should verify the applicability of any example or sample program before placing the software into productive use. This document, including without limitation the examples and software programs, is supplied "As-Is."

Verifone, the Verifone logo, VeriCentre, and Verix are registered trademarks of Verifone. Other brand names or trademarks associated with Verifone's products and services are trademarks of Verifone, Inc.

All other brand names and trademarks appearing in this manual are the property of their respective holders.

**Comments?** Please e-mail all comments in this document to your local Verifone Support Team.

Verifone, Inc.  
2099 Gateway Place, Suite 600  
San Jose, CA, 95110 USA

[www.verifone.com](http://www.verifone.com)

Verifone Part Number DOC260-003-EN-C, Revision C



# CONTENTS

**PREFACE** . . . . . 5

Audience . . . . . 5

Organization . . . . . 5

Related Documentation . . . . . 5

Guide Conventions . . . . . 6

    Acronym Definitions . . . . . 7

**CHAPTER 1**  
**Terminal Overview**

Features and Benefits . . . . . 10

    Exceptional Ease of Use . . . . . 10

    Performance and Durability . . . . . 10

    Security . . . . . 10

    Contactless Capability . . . . . 11

    Communication Technology . . . . . 11

Differences Between VX 685 and VX 690 Terminals . . . . . 11

**CHAPTER 2**  
**Setup**

Terminal Location . . . . . 13

    Ease of Use . . . . . 13

    Environmental Factors . . . . . 13

    Electrical Considerations . . . . . 14

Inside the Shipping Carton . . . . . 14

Terminal Features . . . . . 15

    Front Panel . . . . . 15

Connection Port . . . . . 16

Paper Roll . . . . . 16

SIM Card . . . . . 17

MSAM Card . . . . . 18

Micro SD Card . . . . . 20

Optional Devices . . . . . 20

Battery Features . . . . . 21

    Battery Life . . . . . 21

    Battery Behavior . . . . . 21

Terminal Power Source . . . . . 22

Base Stations . . . . . 24

    Charging Base . . . . . 24

    BT Base . . . . . 24

    Terminal and Base . . . . . 25

    Dial-up and Ethernet Connections . . . . . 26

    Powered Serial . . . . . 27

    External Devices . . . . . 28

3G, GPRS, and GPS Support . . . . . 28

    GPS Receiver . . . . . 28

    3G/GPRS . . . . . 28

VX 690 BT/Wi-Fi Support . . . . . 29

    Bluetooth Support . . . . . 29

Wireless Transaction .....	34
Smart Card Reader .....	34
Magnetic Card Reader .....	35
Contactless Smart Card Transaction .....	35

**CHAPTER 3**  
**Specifications**

Power Rating .....	37
Power Pack .....	37
Temperature .....	37
External Dimensions .....	37
Weight .....	37
Processor .....	37
Memory .....	37
Display .....	37
Magnetic Card Reader .....	37
Primary Smart Card .....	37
SAM Card Reader .....	38
Keypad .....	38
Peripheral Ports .....	38
Security .....	38

**CHAPTER 4**  
**Maintenance and**  
**Cleaning**

Additional Safety Information .....	40
Power Adapter .....	40
Potentially Explosive Environments .....	40
Card Readers .....	40

**CHAPTER 5**  
**Service and Support**

Service Returns .....	41
Accessories and Documentation .....	42

**CHAPTER 6**  
**Troubleshooting**  
**Guidelines**

Terminal Does Not Start .....	45
Terminal Display Does Not Show Correct/Readable Info .....	45
Blank Display .....	46
Printer Does Not Print .....	46
Printer Paper Jam .....	46
Keypad Does Not Respond .....	47
Transactions Fail To Process .....	47

**APPENDIX A**  
**Battery Information**

Charging .....	49
Advantages .....	49
Precautions .....	50
Notable Battery Specifications .....	51
Safety/Protection Circuit .....	51
Cell Temperature Monitoring .....	51
ESD Protection .....	51
Trip Recovery .....	51
Battery FAQs .....	51
Battery Specific Terms and Definitions .....	52
General Battery Terms and Definitions .....	52



This guide is the primary source of information for setting up and installing the terminal.

## Audience

This guide is useful to anyone installing and configuring the terminal.

## Organization

This guide is organized as follows:

[Chapter 1, Terminal Overview](#). Provides an overview of the terminal.

[Chapter 2, Setup](#). Explains setup and installation of the terminal, selecting a location, and establishing connections with other devices.

[Chapter 3, Specifications](#). Discusses power requirements and dimensions of the terminal.

[Chapter 4, Maintenance and Cleaning](#). Explains maintenance of the terminal.

[Chapter 5, Service and Support](#). Provides information on contacting your Verifone service provider and information on how to order accessories or documentations from Verifone.

[Chapter 6, Troubleshooting Guidelines](#). Provides troubleshooting guidelines should you encounter a problem in terminal installation and configuration.

[Appendix A, Battery Information](#). Provides information about the battery.

## Related Documentation

Refer to the following set of documents to learn more about the terminal:



VX 690 Certifications and Regulations Sheet	VPN - DOC260-001-EN
VX 690 Quick Installation Guide	VPN - DOC260-002-EN
VX 685/VX 690 Reference Guide	VPN - DOC260-004-EN
VX 690 Charging Base Certifications and Regulations Sheet	VPN - DOC260-005-EN
VX 690 BT Base Certifications and Regulations Sheet	VPN - DOC260-006-EN
VX 685/VX 690 Charging Base Quick Installation Guide	VPN - DOC260-007-EN
VX 690 BT Base Quick Installation Guide	VPN - DOC260-008-EN
VX 690 3G-BT-WiFi Certifications and Regulations Sheet	VPN - DOC260-009-EN
VX 690 3G-BT-WiFi Quick Installation Guide	VPN - DOC260-010-EN
VX 685 Certifications and Regulations Sheet	VPN - DOC262-001-EN

VX 685 Quick Installation Guide	VPN - DOC262-002-EN
Verix eVo Volume I: Operating System Programmers Manual	VPN - DOC00301
Verix eVo Volume II: Operating System and Communication Programmers Manual	VPN - DOC00302
Verix eVo Volume III: Operating System Programming Tools Reference Manual	VPN - DOC00303
VX 690 HW ERS Rev A00	SPC260-007-01-A
VX 690 Base ERS	SPC260-010-01-A
VX 690 PRD Rev. A02-2	SPC260-001-01-A
VX 690 OS ERS Rev 0.04	
VX 685 HW ERS Rev 004	SPC262-001-01-A
VX 685 OS ERS Rev 0.01	

## Guide Conventions

Various conventions are used to help you quickly identify special formatting. [Table 1](#) describes these conventions and provides examples of their use.

**Table 1 Document Conventions**

Convention	Meaning	Example
Blue	Text in blue indicates terms that are cross references.	See <a href="#">Guide Conventions</a> .
<i>Italics</i>	Italic typeface indicates book titles or emphasis.	You <i>must</i> not use this unit underwater.
<b>NOTE</b> 	The pencil icon is used to highlight important information.	RS232-type devices do not work on the VX 685/VX 690 communication port.
<b>CAUTION</b> 	The caution symbol indicates hardware or software failure, or loss of data.	The unit is not waterproof or dustproof, and is intended for indoor use only.
<b>WARNING</b> 	The lightning symbol is used as a warning when bodily injury might occur.	Do not use the terminal near water due to risk of shock.

**Acronym Definitions** Acronyms are used in place of the full definition. [Table 2](#) presents acronyms and their definitions.

**Table 2 Acronym Definitions**

Acronym	Definitions
3DES	Triple Data Encryption Standard
AES	Advanced Encryption Standard Algorithm
API	Application Programming Interface
ARM	Advanced RISC Machine
BBM	Battery Backed Memory
CAPK	Certification Authority Public Key
CBC	Cipher Block Chaining mode
DEA/DES	Data Encryption Algorithm/Standard
DUKPT	Derived Unique Key Per Transaction Method as defined in the VISA's POS Equipment Requirement: PIN processing and Data Authentication, International Version 1.0, August 1988
ECR	Electronic Cash Register
EMV	Joint Europay, MasterCard and Visa Standard
MAC	Message Authentication Code
MMU	Memory Management Unit
MSAM	Multiple Secure Access Module
OS	Operating System
PIN	Personal Identification Number
POS	Point-of-Sale
RFID	Radio Frequency Identification
SAM	Secure Access Module
SC	Smart Card (Integrated Chip Card)
SD	Secure Digital
SR	Ship Release
SRAM	Static Random Access Memory
UI	User Interface
USB	Universal Serial Bus







## Terminal Overview

The terminal is a portable and battery-powered device designed to fit comfortably during handheld consumer-facing applications. It features a colored 3.5" QVGA display, touch screen, and backlit spill-resistant keypad. It supports a variety of communication technologies including GPRS, 3G radio with GPS/A-GPS, 802.11 a/b/g/n wireless fidelity (Wi-Fi), and Bluetooth. Refer to [Table 3](#) for a detailed list of features available on VX 685 and VX 690.



Figure 1 VX 685/VX 690 Terminal

## Features and Benefits

The terminal focuses on optimizing cost structure and providing better form factor. It provides the right combination of features and functions in a sleek and ergonomic device that fits in the palm of your hand.

### Exceptional Ease of Use

- Bold, ergonomic design—sleek, stylish, and lightweight for conveniently handing the unit for PIN entry or other input.
- Large 3.5" QVGA display for boundless application possibilities and easy readability under various lighting conditions.
- Touchscreen for icon-based applications or electronic signature capture support.
- Intuitive telco-style keypad with large, colored control keys, and interchangeably detects key presses from tactile keypad and the touchscreen.
- 40 mm diameter paper roll with a trouble-free, drop-in, "clam shell" loading, and dual tear bar that allows receipts to be torn in any direction.
- Quiet and fast integrated thermal printer with a rear placement to maximize the user interface area.
- Unidirectional magnetic stripe card reader with an extended blade for optimal card reading.

### Performance and Durability

- Fast transactions due to powerful 400 MHz ARM11 processor.
- High-capacity 3.7 V 2450 mAh Li-ion battery.
- Standard base for drop-and-go charging and full feature Bluetooth base for VX 690 for full back-up connectivity options and support to some peripheral device.
- Terminal and base support peripheral connection via the USB Host and USB device ports. Bluetooth base also supports peripheral connection via the serial connection port.
- Rounded corners and drop resistant to three feet on concrete floor to minimize breakage.
- 192 MB memory (128 MB flash, 64 MB RAM) with optional removable micro SD flash memory.

### Security

- Incorporates tamper-detection circuitry to resist unauthorized intrusion and supports a broad spectrum of software-based security features.
- PCI 3.X approved for debit and other PIN-based transactions.
- EMV Level 1 Type Approval.
- Supports reliable security available including SSL, VeriShield file authentication, and VeriShield Protect to help prevent fraud and other intrusions.

- Contactless Capability**
- Advanced contactless architecture that future-proofs investment with a single contactless interface (SingleCI), SoftSAMs, and side-by-side application architecture.
  - On-screen tap zone (CTLS logo) for optimized user experience.
  - Contactless version accepts EMV and mag-stripe contactless payments as well as PIN-based transactions.

- Communication Technology**
- GPRS/3G/GPS: Long-range wireless payment for retailers that have no physical location limitations.
  - Bluetooth®: Simple, plug-and-play installation for locations that need short-range wireless capability.
  - Wi-Fi: Ideal for retailers that need multiple wireless devices and have an existing IP infrastructure.

**Differences Between VX 685 and VX 690 Terminals**

VX 685 and VX 690 terminals are mostly identical and offer the same general benefits. It is important to know the differences in their intrinsic features.

**Table 3 Features Comparison**

Features	VX 685 GPRS	VX 690 3G-BT	VX 690 3G-BT-WiFi
Processor	400 MHz ARM 11	400 MHz ARM 11	400 MHz ARM 11
OS	Verix OS	Verix OS	Verix OS
Memory	64 MB SDRAM/128 MB Flash	64 MB SDRAM/128 MB Flash	64 MB SDRAM/128 MB Flash
Display	3.5" QVGA	3.5" QVGA	3.5" QVGA
Touchscreen	Resistive type	Capacitive Type	Capacitive Type
Radio	GPRS (Gemalto BGS2-W)	3G (Cinterion PHS8-P)	3G (Cinterion PHS8-P)
Bluetooth	NA	Yes	Yes
Wi-Fi	NA	NA	Yes
GPS	NA	Yes	Yes
Magnetic card reader	Triple Track, bi-directional	Triple track, bi-directional	Triple track, bi-directional
Smart card reader	ISO 7816, 1.8 V, 3 V, 5 V, synchronous and asynchronous cards	ISO 7816, 1.8 V, 3 V, 5 V, synchronous and asynchronous cards	ISO 7816, 1.8 V, 3 V, 5 V, synchronous and asynchronous cards
SAM slots	2	2	2
SIM	Single	Dual	Dual
Micro SD	NA	Yes	Yes
Audio speaker	NA	Yes	Yes
USB integrated	1 Host/client	1 Host/client	1 Host/client
Security	PCI 3.0	PCI 3.0	PCI 3.0
CTLS	NXP PN512 C2	NXP PN512 C2	NXP PN512 C2
Printer	30 lps	30 lps	30 lps

**Table 3**      **Features Comparison** (continued)

<b>Features</b>	<b>VX 685 GPRS</b>	<b>VX 690 3G-BT</b>	<b>VX 690 3G-BT-WiFi</b>
Battery	3.7 V DC/2450 mAh	3.7 V DC/2450 mAh	3.7 V DC/2450 mAh
Paper roll	40 mm	40 mm	40 mm
Charger	5 V DC/2.2 A	5 V DC/2.2 A	5 V DC/2.2 A
Dimension (mm)	163 x 78 x 52	163 x 78 x 52	163 x 78 x 52



## Setup

This chapter describes the setup procedure for:

- Terminal Location.
- Inside the Shipping Carton.
- Terminal Features.
- Connection Port.
- Paper Roll.
- SIM Card.
- MSAM Card.
- Micro SD Card.
- Optional Devices.
- Battery Features.
- Terminal Power Source.
- Base Stations.
- 3G, GPRS, and GPS Support.
- VX 690 BT/Wi-Fi Support.
- Smart Card Reader.
- Magnetic Card Reader.
- Contactless Smart Card Transaction.

### **Terminal Location**

---

The following are guidelines used to select an ideal location for the terminal.

#### **Ease of Use**

- Select a location convenient for both merchant and cardholder.
- Select a flat support surface, such as a countertop or table.
- Select a location near a power outlet, ECR, or computer connected to the terminal. Do not string cables or cords across a walkway for safety.

#### **Environmental Factors**

- Do not use the unit where there is high heat, dust, humidity, moisture, or caustic chemicals or oils.
- Keep the unit away from direct sunlight and anything that radiates heat, such as a stove or a motor.

- Do not use the terminal outdoors.

**CAUTION**

The terminal is not waterproof or dustproof. It is intended for indoor use only. Any damage to the unit from exposure to rain or dust can void any warranty.

**Electrical Considerations**

- Avoid using this product during electrical storms.
- Avoid locations near electrical appliances or other devices that cause excessive voltage fluctuations or emit electrical noise (for example, air conditioners, electric motors, neon signs, high-frequency or magnetic security devices, or computer equipment).
- Do not use the terminal near water or in moist conditions.

**WARNING**

Do not use the terminal near water, including a bathtub, wash bowl, kitchen sink or laundry tub, in a wet basement, or near a swimming pool to avoid shock or damage.

**Inside the Shipping Carton**

Open the shipping carton and carefully inspect its contents for possible tampering or shipping damage. The terminal is a secure product. Tampering causes it to cease to function or to operate in an unsecured manner.

**Unpacking the Shipping Carton**

To unpack the shipping carton:

- 1 Remove and inspect the contents of the shipping carton. The terminal ships in multiple configurations, the carton may include all or any of the following:
  - Terminal
  - Power pack
  - Paper roll
  - Ethernet cable
  - Telephone line cable
- 2 Remove all plastic wrapping from the terminal and components.
- 3 Remove the clear protective film from the display.
- 4 Save the shipping carton and packing material for future repacking or moving of the device.

**WARNING**

Do not use a tampered or damaged unit. The terminal comes equipped with tamper-evident labels. If a label or component appears damaged, please notify the shipping company and your Verifone service provider immediately.

## Terminal Features

Familiarize yourself with the terminal features before continuing with the installation process:

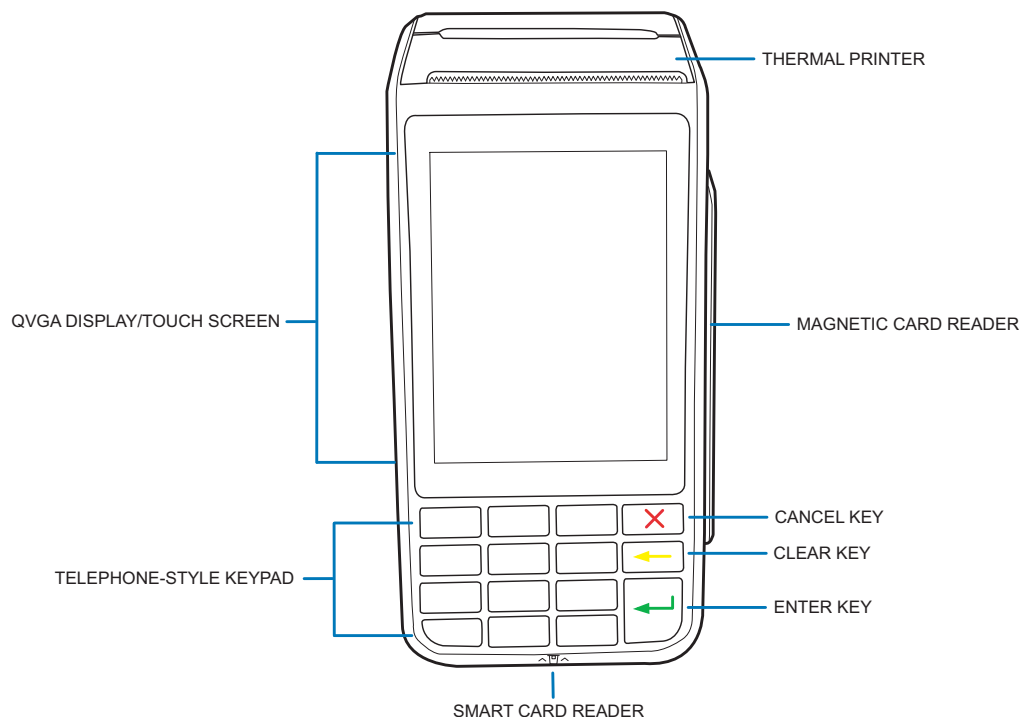
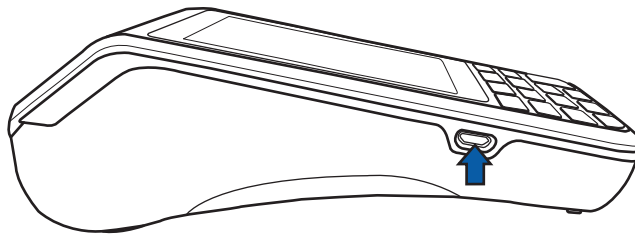

**Figure 2** VX 685/VX 690 Features

**Front Panel** The front panel offers the following features:

- A touchscreen display.
- A set of keys that include:
  - A 12-key, telephone-style keypad (keypads may vary in style).
  - Three color-coded function keys on the right side of the keypad (from top to bottom: CANCEL, CLEAR, ENTER).
- A magnetic card reader, built into the right side. An icon shows the proper swipe direction, with the stripe facing down and towards the keypad.
- A smart card reader, built into the unit's front side. An icon indicates the proper card position and insertion direction.

**Connection Port** The terminal has one primary micro-USB port used for power and download.



**Figure 3** Micro-USB Port on the Terminal

## Paper Roll

A fast and quiet thermal printer is built into the terminal. You must install a roll of thermal-sensitive paper in the printer before you can process transactions that require a receipt or record.

The ITP uses a roll of single-ply and thermal-sensitive paper 40 mm in diameter. A pink out-of-paper indicator line appears on the edge of the paper approximately 18 inches before the end of the roll. After this line appears, there is enough paper remaining on the roll to conclude at least one transaction.



**CAUTION** Poor-quality paper can jam the printer and create excessive paper dust. Refer to Accessories and Documentation to order high-quality Verifone paper. Store thermal paper in a dry and dark area. Handle thermal paper carefully. Impact, friction, temperature, humidity, and oils affect the color and storage characteristics of the paper. Never load a roll of paper with folds, wrinkles, tears, or holes at the edges in the print area.

### *Installing or Replacing a Paper Roll*

To install or replace a paper roll:

- 1 Gently pull the latch on top of the terminal to unlock the compartment.
- 2 Lift the printer cover up and back.
- 3 Remove any partial roll of paper in the printer tray.
- 4 Loosen the glued leading edge of the new roll of paper or remove the protective strip, if applicable. Unwind the paper roll past any glue residue.
- 5 Hold the roll so the paper feeds from the *bottom* of the roll when the terminal is inverted.



- Drop the paper roll into the printer tray.

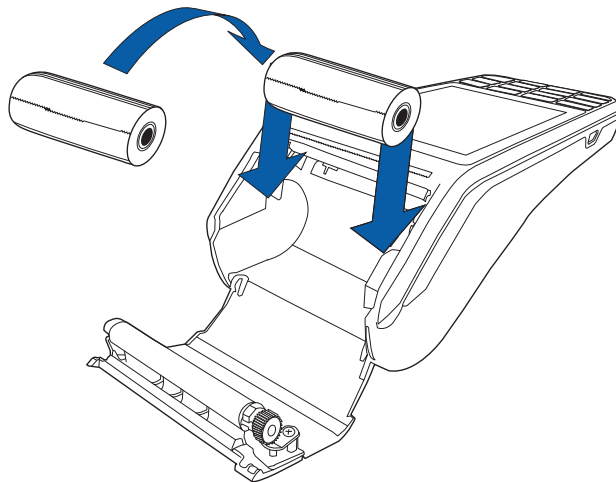

**Figure 4** Installing Paper Roll Cover



Gently press down on the paper roll cover to close it to prevent damaging the print roller.

## SIM Card

VX 685 has a single SIM slot that enables communication to the network provider. VX 690 supports dual SIM. SIM slot 1 is preferred for single SIM use. When dual SIM is employed, it is ideal to use SIM cards from two different network providers. This allows the terminal to switch SIMs when it detects poor signal or no network.

### *Installing or Replacing a SIM Card*

To install or replace a SIM card:

- Turn off the terminal.
- Place the terminal face down on a soft and clean surface to protect the lens from scratches.
- Lift the battery pack to expose the SIM slots.



Position the card's gold contacts facing away from you, toward the unit. The card slot in the terminal has a set of contacts. The SIM card has a notch on one corner to ensure that it fits into the connector base in only one way.

- 4 Align the card to match the embossed number and carefully slide it into the slots until fully inserted.

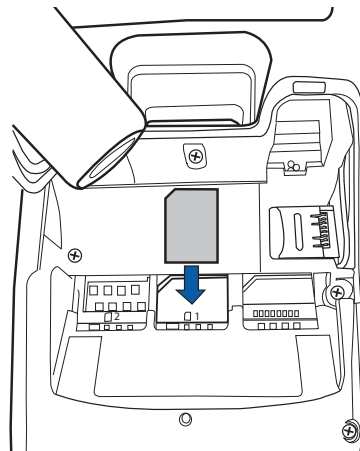

**Figure 5 SIM Card Insertion**

To replace SIM card, gently slide out the old SIM card before inserting a new SIM.

## **MSAM Card**

You may need to install one or two multiple security access module (MSAM) cards or replace an old one.



**CAUTION** Observe standard precautions in handling electrostatically sensitive devices. Electrostatic discharge can damage the equipment. Verifone recommends using a grounded anti-static wrist strap.

### ***Installing or Replacing MSAM Card***

To install or replace MSAM cards:

- 1 Power off the terminal.
- 2 Place the terminal face down on a soft and clean surface to protect the lens from scratches.
- 3 Remove the back cover of the unit.

- Lift the battery pack to expose the SAM slots. The slots are located just below the micro SD card slot.

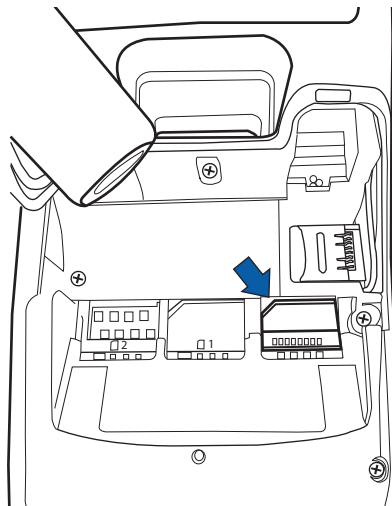
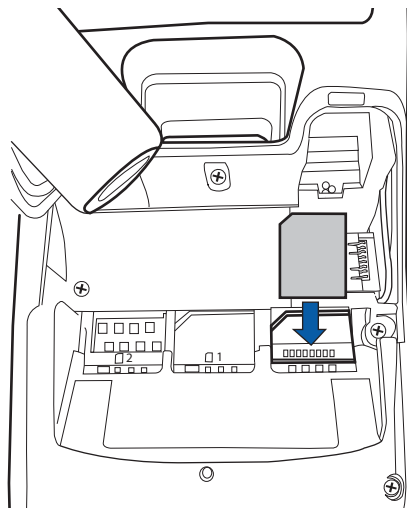

**Figure 6 SAM Slots**



**NOTE** Position the card's gold contacts facing away from you, toward the unit. The card slot in the terminal has a set of contacts. The MSAM card has a notch on one corner to ensure that it fits into the connector base in only one way.

- Carefully slide the cards one at a time into the slots until fully inserted.



**Figure 7 SAM Insertion**

To replace SAM card, gently slide out the old SAM card before inserting a new one.

## Micro SD Card

VX 690 supports micro SD for additional memory.

### Installing or Replacing Micro SD Card

To install or replace Micro SD card:

- 1 Turn off the terminal.
- 2 Place the terminal face down on a soft and clean surface to protect the lens from scratches.
- 3 Lift the battery pack to expose the micro SD card slot.
- 4 Insert the micro SD card into its slot.

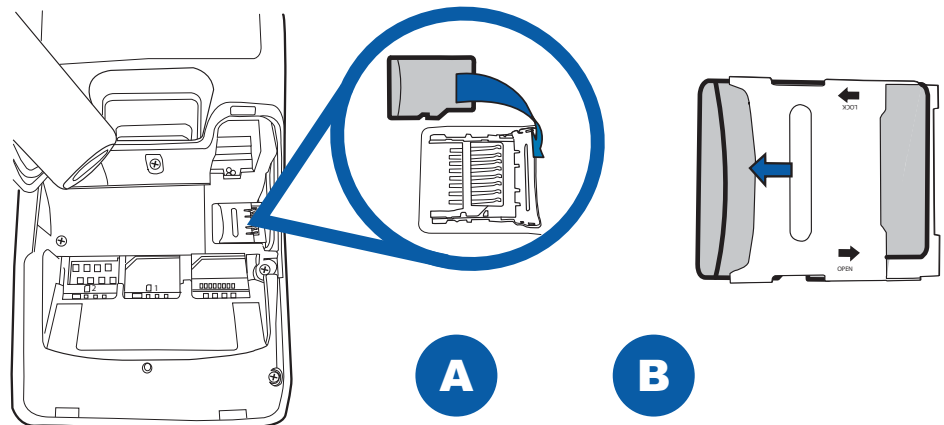

**Figure 8** Inserting a Micro SD Card

To replace Micro SD card, gently slide out the old micro SD card before inserting a new one.

### Optional Devices

The terminal supports peripheral devices designed for use with electronic point-of-sale system such as biometric scanner and barcode reader via the Micro-USB port.



Power limitations for peripheral devices should be considered. The side micro-USB supports up to 300 mA. USB 1.1 supports up to 200 mA.

Reconnect the power cord only *after* you are finished connecting the peripheral device(s). Refer to the user documentation supplied with those devices for complete information about peripheral installation and use.

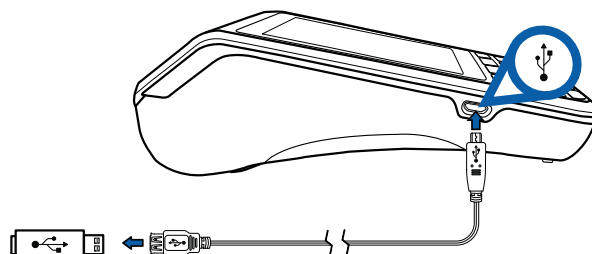

**Figure 9** Connecting Peripheral Devices to the Terminal via the Micro-USB Port

## Battery Features

The terminal uses a single cell, 2450 mAh Li-ion battery (see [Accessories and Documentation](#) for ordering information). The internal logic of the battery prevents both overcharging and undercharging—a fault condition where the battery level goes well below the minimum acceptable charge and the battery becomes unusable.

The battery has a safety circuit that prevents cell damage from overcharge, over-discharge, or overheating; and activates when the battery is left in an unused terminal for extended periods.

- The battery is not customer-changeable and therefore should not be disconnected and removed.
- Li-ion batteries are not affected by shallow charging. When the terminal has no external power source or battery, the coin cell battery provides power to the security circuit.
- Disconnecting and removing the battery, as well as unplugging the terminal power pack, reduce the life of the coin cell battery, which does not recharge and must be replaced when drained.
- Conserve battery power by turning the terminal off when not in use.
- Keep the Li-ion battery inserted in the terminal and power up the terminal periodically to check the battery charge. Do not let the battery charge fall below 10% for extended periods of time as this may permanently diminish the battery capacity. Recharge the battery by attaching the micro-USB end of the power pack to the terminal and plugging the other end of the power pack into a wall outlet.

See [Battery Information](#) for more specific information about battery.

### Battery Life

VX 685 terminal keeps track of the charging current going into the battery. The battery is considered healthy until its capacity is reduced to 70% of the theoretical capacity. Check the batteries when the number of cycles exceeds 600 full cycles. `get_battery_value()` supports battery life:

- `int get_battery_value(BATTERYLIFE);`
- `int get_battery_value(BATTERYCYCLES);`

See *Verix eVo Volume I: Operating System Programmers Manual*, VPN - DOC00301 for more information.

### Battery Behavior

The terminal shifts to power pack mode and starts up automatically when the terminal is connected to a non-battery power source, regardless of the battery charge state.

### Manual Startup

Hold the green key down for about four seconds until the terminal displays the startup screen. The time required to hold the green key down to power up the terminal is configurable (see *VX 690 Reference Guide*, VPN - DOC260-004-EN for more information). The terminal lights up once power is on.

---

**NOTE**

When the terminal has power and an application is loaded, the application starts after the initial Verifone copyright screen. If no application is loaded, **DOWNLOAD NEEDED** appears on the display after the initial Verifone copyright screen.

---

### Manual Shutdown

Hold the red key down for about four seconds until the terminal displays the shutdown verification screen. The time required to hold the red key down to shut down the terminal is configurable (see *VX 690 Reference Guide*, VPN - DOC260-004-EN for more information).

## Terminal Power Source

---

The terminal is either powered by an external power pack or the single cell Li-ion rechargeable battery, which can be charged in the terminal by the AC/DC power pack through the micro-USB connector for VX 690 and pin connector for VX 685.

When you have finished installing the necessary cards and/or optional devices, you are ready to connect the terminal to the power source.

---

**WARNING**

Do not connect the terminal to the power supply until all peripherals are attached.

Using an incorrectly rated power supply can damage the unit or cause it not to work properly. Use only a power pack with P/N PWR260-001-XX-A for VX 690 and P/N PWR262-001-XX-A for VX 685. See [Specifications](#) for detailed power supply specifications.

Do not plug the power pack into an outdoor outlet or operate the terminal outdoors. Disconnecting power during a transaction can also cause unstored data files to be lost.

---

---

**NOTE**

Verifone recommends installing a power surge protector to protect against possible damage caused by lightning strikes and electrical surges.

---

**Connecting VX 690  
Terminal to a Power  
Source**

To connect VX 690 terminal to a power source:

- 1 Insert the micro-USB connector to the micro-USB port found on the side of the terminal.
- 2 Plug the AC power cord into a wall outlet or power surge protector.

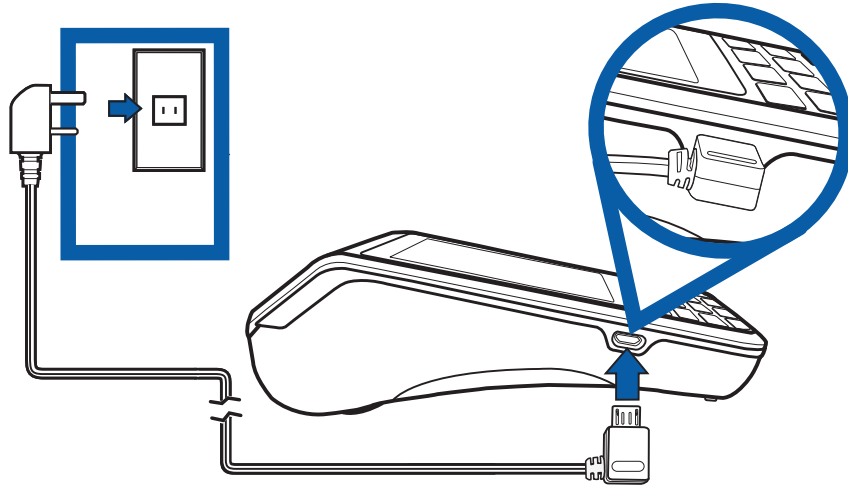
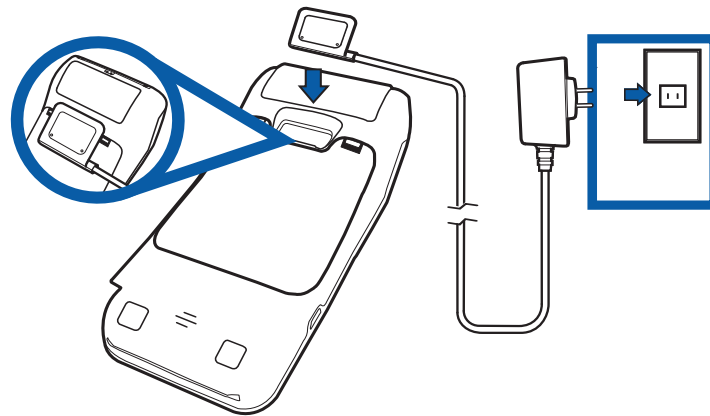

**Figure 10 Connecting VX 690 to Power Source**

**Connecting VX 685  
Terminal to a Power  
Source**

To connect VX 685 terminal to a power source:

- 1 Insert the pin connector into the pin slot located at the back of the terminal.
- 2 Plug the AC power cord into a wall outlet or power surge protector.



**Figure 11 Connecting VX 685 to Power Source**

## Base Stations

Verifone ships variants of the base station for different markets. Your base may have a different configuration.

### Charging Base

A base to charge the terminal and provide a docking station when the terminal is not in use. The base can be positioned on a countertop.

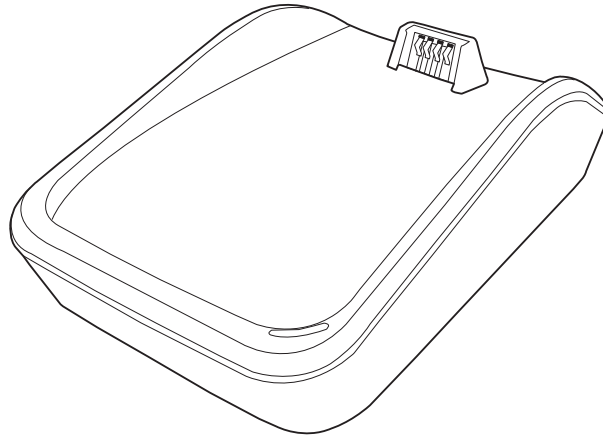

**Figure 12** Charging Base

### BT Base

A base that supports power, dial-up, Ethernet, powered RS-232, USB device connectivity, USB Host, and Bluetooth device. Apart from charging the battery, it allows the terminal to use dial and Ethernet options, support peripheral devices, download/debug tasks, and conduct transactions over Bluetooth.

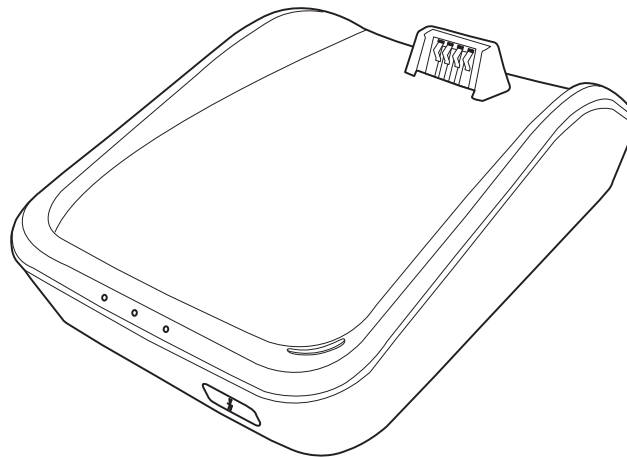
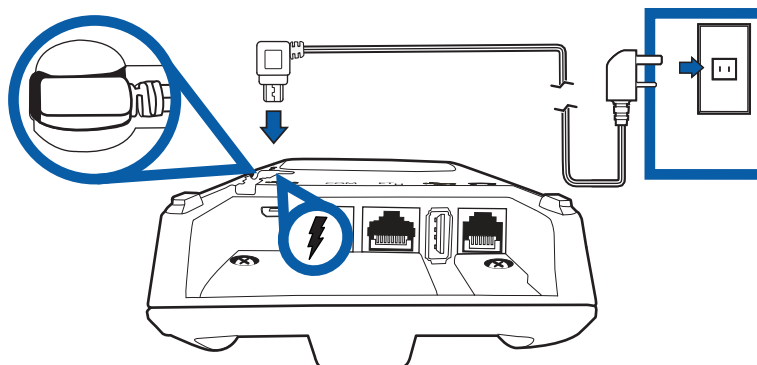

**Figure 13** BT Base



**Powering Up the Base** To power up the base:

- 1 Insert the micro-USB plug into the micro-USB port on the base.
- 2 Plug the AC power cord into a wall outlet or a power surge protector.



**Figure 14 Connecting Base to Power Source**

**WARNING** Using an incorrectly rated power supply can damage the unit or cause it not to work properly. Use only a power pack with P/N PWR260-001-XX-A. See [Specifications](#) for detailed power supply specifications.



Do not plug the power pack into an outdoor outlet or operate the terminal outdoors. Disconnecting power during a transaction can also cause unstored transaction data files to be lost.

**Terminal and Base** The terminal can be placed on the base when not in use. This ensures continuous charging of the battery.

**Docking the Terminal on the Base** To dock the terminal on the base:

- 1 Place the top portion of the terminal on the base. Ensure that the recess on the bottom of the terminal sits on top of the docking connector.

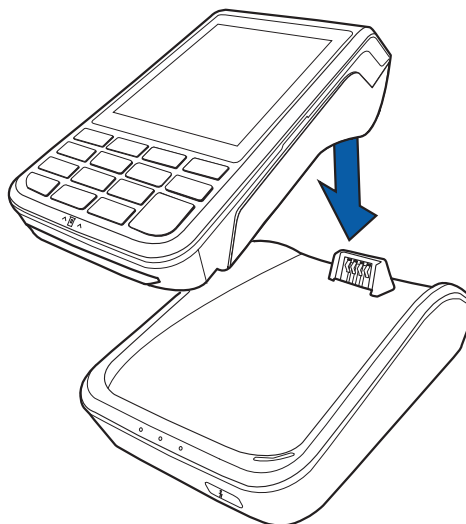

**Figure 15 Docking the Terminal on the Base**

**Undocking the terminal from the base**

To undock the terminal from the base:

- 1 Gently lift the terminal from the base.



**Figure 16 Undocking the Terminal from the Base**



When conducting customer transactions, you can remove the terminal from the base.

**Dial-up and Ethernet Connections**

The terminal allows for dial-up and Ethernet connections for full back-up connectivity.

**Creating a Dial-Up Connection**

To create a dial-up connection:

- 1 Connect the telephone cable to the communication port on the base.
- 2 Route the other end of the cable directly to a telephone wall jack. This is a direct connection and the line is dedicated to the terminal.

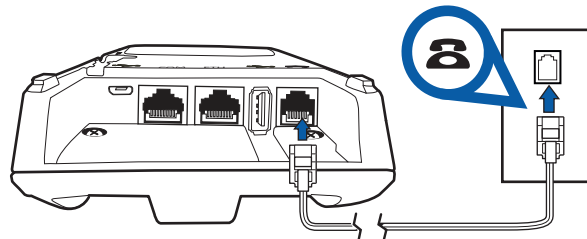
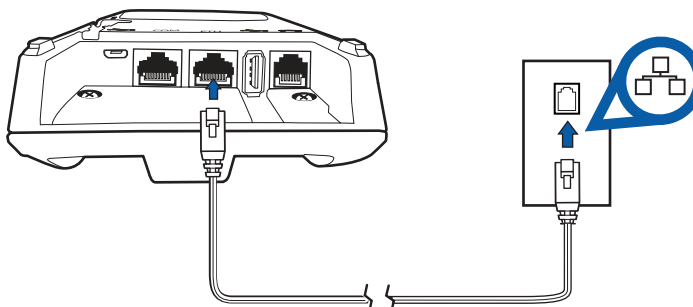

**Figure 17 Direct Telephone Connection**

**Creating an Ethernet Connection**

To create an Ethernet connection:

- 1 Connect the Ethernet cable to the port on the base.
- 2 Route the other end of the cable directly to a data wall jack (or router/hub).



**Figure 18 Ethernet Connection**

**Powered Serial**

The powered serial on the base can be used in debug options or downloading applications.

**Connecting to the Powered Serial**

To connect to the powered serial:

- 1 Connect the RS-232 cable to the COM port on the base.
- 2 Route the other end of the cable to the PC.

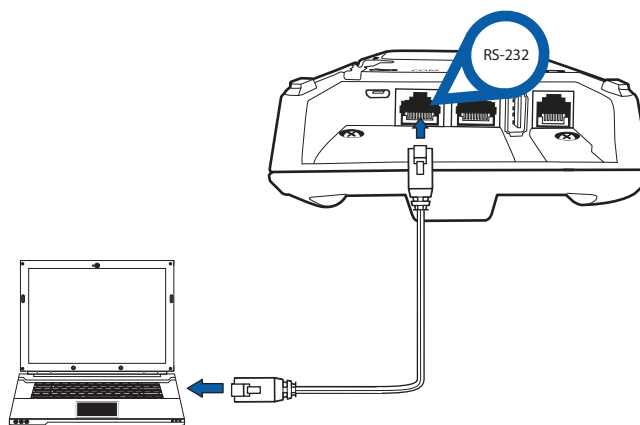

**Figure 19 Connection to the COM Port**

**External Devices**

The base supports peripheral devices such as electronic cash register, check reader, barcode reader, and biometric scanner through a serial connection. Micro-USB port is for PC connection and USB Host port is for USB flash drive.

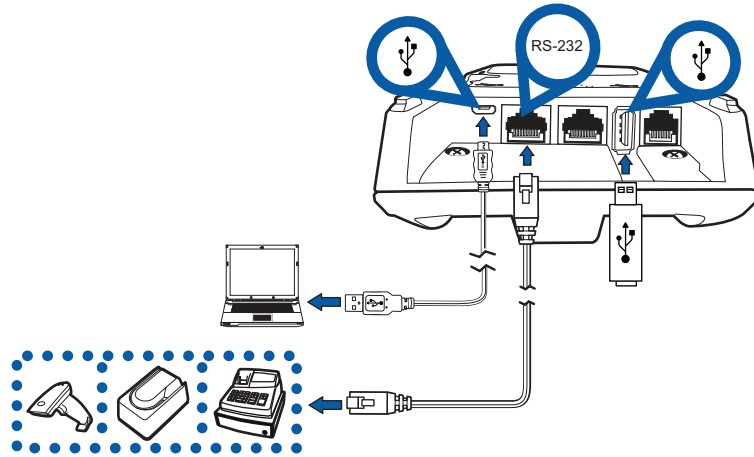

**Figure 20 Connecting Peripheral Devices**



**CAUTION** Remove the power cord from the terminal before connecting any peripheral device. Reconnect the power cord only *after* you have finished connecting the peripheral device(s).

**Connecting  
Peripherals or  
External Devices**

To connect peripherals or external devices:

- 1 Connect the micro-USB/USB cable of the device to the micro-USB/USB port of the base.
- 2 Refer to the user documentation supplied with those devices for complete information about the peripheral installation and use.

**3G, GPRS, and  
GPS Support**

VX 690 uses the Cinterion PHS8-P radio module. This module provides wireless connectivity using HSPA+ technology. The PHS8-P radio module is optimized for high bandwidth and allows a downlink speed of 14.4 Mbps and an uplink speed of 5.7 Mbps.

**GPS Receiver**

The Cinterion PHS8-P radio module on VX 690 integrates a GPS receiver that offers the full performance of GPS/A-GPS technology, allowing customers to implement geo-fencing applications.

**3G/GPRS**

Allows for a wider range of communication for wireless transaction payment using the available operator-provided 3G infrastructure.



**NOTE** VX 685 uses integrated Gemalto BGS2-W module to support GSM/GPRS radio features.

## VX 690 BT/Wi-Fi Support

VX 690 Wi-Fi/BT integrated module uses Broadcom BCM4330 chip, which provides SDIO interface for Wi-Fi and UART interface for Bluetooth. The module includes an integrated WLAN RF transceiver for Wireless LAN systems with advanced power management unit, and an integrated radio transceiver for Bluetooth wireless systems.

### Bluetooth Support

VX 690 uses the Bluetooth base station. Up to seven devices can be registered with the same communications device, but only one transaction may be undertaken at a time. Do not pair more than three terminals with the base station. When more than three terminals are required, additional base stations must be suitably positioned on site to obtain maximum radio coverage.

#### NOTE



The terminal can only communicate to a base station to which it is paired.

The terminal and the Bluetooth base station are both Class 1 Bluetooth devices providing secure radio communication up to 100 meters, unobstructed. The terminal may be registered (paired) with more than one base station. It must be paired to secure the communication. The terminal may easily be switched among paired devices using the standard menu options provided in Verix Commserver.

### Establishing Bluetooth Connections

To establish Bluetooth connections:

- 1 Ensure the terminal is not more than five meters away from the Bluetooth Base Station for initial pairing.
- 2 Terminal and Bluetooth Base Station must be powered on.
- 3 Follow the on-screen instructions displayed on the terminal.

Bluetooth base relays wireless data received from the terminal via modem and then transmits back the response to the terminal.

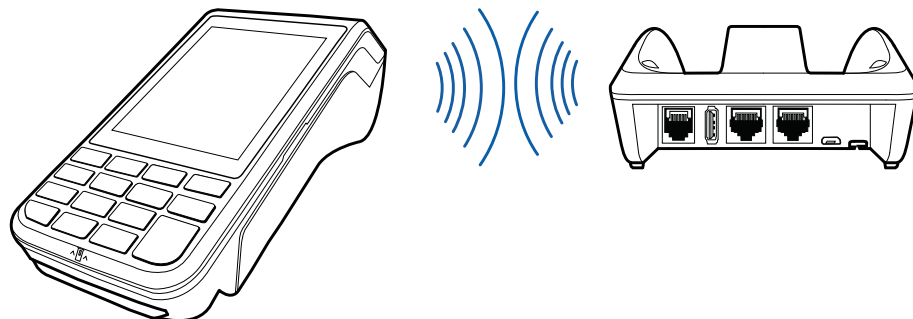

**Figure 21 Terminal Communicating with a Bluetooth Base**

Bluetooth Base Station should be placed in a position that services all of the card payment areas in your premises to improve the range performance of the terminal. The ideal placement is to position the base station within line of sight of all areas of card acceptance.

**Searching for a  
Bluetooth Base  
Station**

Use the terminal to search and establish a connection between the Bluetooth version of the terminal and the Bluetooth Base Station.

To search for a Bluetooth Base Station using the terminal:

- 1 Power on the terminal.
- 2 Select the Options menu shown on the terminal display.
- 3 Select Bluetooth on the Network Control Panel.
- 4 Click Bluetooth to access the Bluetooth menu.

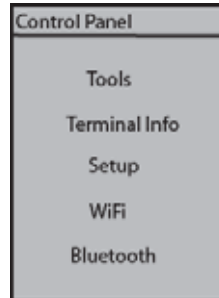

- 5 Enter your password and press the Enter key to access the Setup menu.



6 Press Enter key to start searching for a base station.

**NOTE**



Discovery is selected by default on the Setup menu.



There is a short delay as the terminal searches for the base station. The message is shown on the terminal display.

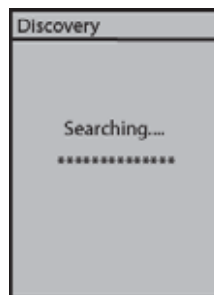

The base station's name is displayed once the terminal discovers the Bluetooth Charging Base Station.



**NOTE**



Press the Bluetooth switch found in front of the Bluetooth Base if the devices are unable to find each other after two minutes. The three LEDs will blink after pressing the switch indicating that the Bluetooth Base is discoverable.

**CAUTION**



Pressing the Bluetooth switch while there is an existing Bluetooth connection may result in loss of connection, loss of modem profile, and loss of all modem settings/configuration.

***Pairing the Terminal with a Bluetooth Base Station***

Even after you have successfully searched for a Bluetooth Base Station using the terminal, you will not be able to conduct Bluetooth transactions until you have paired the terminal and the base station.

To pair the terminal with the base station:

- 1 Navigate to the BT Devices menu.
- 2 Select the base station's name and press the Enter key.



The BT Devices menu appears on the terminal screen if pairing is successful. The name of the Bluetooth Base Station appears on the first line of the BT Devices menu.

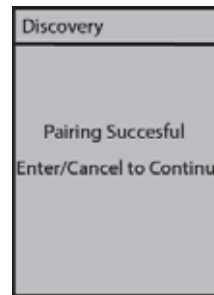

If everything is connected properly and the terminal is unable to go online, refer to [Troubleshooting Guidelines](#).

***Setting the Connection Information for a Paired Device***

To set the connection information for a paired device:

- 1 Select Paired Device.
- 2 Select a device from the list.
- 3 Select either Ethernet, Modem, or Serial (this is for XPS019) on the BT Device Port.



**Pairing with Another  
Bluetooth Charging  
Base Station**

The terminal may be paired with additional Bluetooth Base Station once the terminal is paired with a Bluetooth Base Station and initialized.

To pair a terminal with another Bluetooth Base Station:

- 1 Select Discovery on the terminal's Setup menu and press Enter.

**NOTE**

Make sure the terminal is within five meters from the Bluetooth Base Station, which must be powered on.

- 
- 2 Select the appropriate base station name displayed on the terminal and press Enter.
  - 3 Select Yes on the Discover menu when Pair with Device screen appears.

The terminal and base station are then paired. The terminal makes the new Bluetooth Base Station the default pairing device.

If everything is connected properly and the terminal is unable to go online, refer to [Troubleshooting Guidelines](#).

**Removing a Paired  
Bluetooth Charging  
Base Station**

To remove a Bluetooth Base Station to which a terminal has been paired:

- 1 Navigate to the BT Devices menu.
- 2 Select the Bluetooth Base Station you want to remove as a pair.
- 3 Select Remove and press the Enter key.

The Bluetooth Base Station's name will disappear from the display when the base station is removed.

**Removing a Paired  
Device via Network  
Control Panel of EOS**

To remove a paired device via Network Control Panel of EOS:

- 1 Select Bluetooth on the Menu.
- 2 Select Setup on the Bluetooth menu.
- 3 Select a paired device on the Setup menu.
- 4 Select Remove.

## Wireless Transaction

VX 690 supports wireless transactions.

### Conducting Wireless Transaction

To conduct a wireless transaction:

- 1 Ensure the terminal is in an optimal position for transmitting.
- 2 Follow the on-screen instructions provided with your application.

## Smart Card Reader

The smart card transaction procedure can vary depending on the application. Verify the proper procedure with your application provider before performing a smart card transaction.

### Using the Smart Card Reader

To use the smart card reader:

- 1 Position the smart card with the gold contacts facing upward.
- 2 Insert the card into the smart card reader slot in a smooth, continuous motion until it sets firmly.
- 3 Remove the card only when the display indicates the transaction is complete.

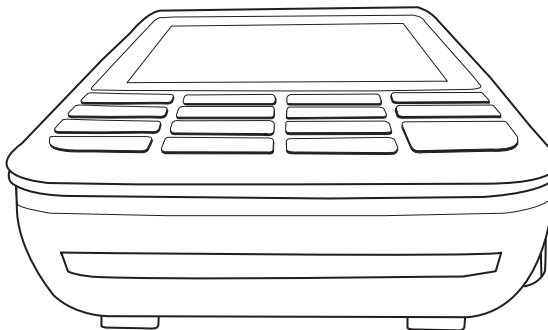

Figure 22 Smart Card Reader



#### CAUTION

Leave the smart card in the card reader until the transaction is completed. Premature card removal can invalidate a transaction.

## Magnetic Card Reader

The terminal has a magnetic card reader that uses a triple track stripe reader. This gives the unit greater reliability over a wide range of swipe speeds and operating environments.

### Using the Smart Card Reader (Credit/Debit Card Transaction)

To use the smart card reader (credit/debit card transaction):

- 1 Position a magnetic card with the stripe in the card reader and facing the keypad.
- 2 Swipe it through the magnetic card reader starting from the top of the unit downward.

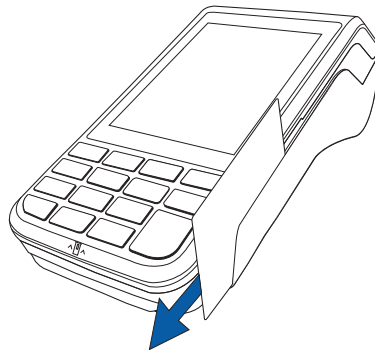

**Figure 23** Using the Magnetic Card Reader

## Contactless Smart Card Transaction

The terminal supports contactless transactions through an integrated contactless module. The terminal only becomes active for contactless smart card transactions when initialized by an application.

### Performing a Contactless Smart Card Transaction

To perform a contactless smart card transaction:

- 1 Gently tap the card onto or hold the card (within 4 cm) against the surface of the RFID canopy.
- 2 An activated LED visual on the display accompanied by a short beeping sound indicates a successful transaction.



**Figure 24** Contactless Smart Card Transaction



Do not let metallic surfaces come in contact with the contactless module to ensure that it works properly.





## Specifications

This chapter discusses power requirements, dimensions, and other specifications of the terminal.

- Power Rating**
  - 5 V DC, 2.2 A
  
- Power Pack**
  - PWR260-001-XX-A (VX 690)
  - PWR262-001-XX-A (VX 685)
  - UL/cUL, ITE listed, LPS power supply
  - Input rated: 100-240 V AC, 50/60 Hz
  - Output rated: 5 V DC, 2.2 A, 11 W
  
- Temperature**
  - Operating temperature: 0° to 50° C (32° to 122° F)
  - Storage temperature: -20° to 70° C (-4° to 158° F)
  
- External Dimensions**
  - Length: 173.25 mm (6.82 in.)
  - Width: 87 mm (3.43 in.)
  - Depth: 31.7 mm (1.25 in.)
  
- Weight**
  - Unit weight: 0.27 kg (0.6 lbs)
  - Shipping weight: 0.850 kg (1.9 lbs)
  
- Processor**
  - 400 MHz ARM 11
  
- Memory**
  - 192 MB memory (128 MB flash, 64 MB RAM)
  
- Display**
  - 3.5" QVGA
  - Supports up to 26 lines x 26 characters
  
- Magnetic Card Reader**
  - Triple track (tracks 1, 2, 3), high coercivity, bi-directional
  
- Primary Smart Card**
  - ISO 7816, 1.8 V, 3 V, 5 V
  - Synchronous and asynchronous cards

## **SAM Card Reader**

---

The terminal has two Security Access Modules (SAMs).

## **Keypad**

---

- 3 x 5 Secure Keypad Matrix
- Keys can be simulated on touchscreen

## **Peripheral Ports**

---

The micro-USB port on the terminal and on the base supports peripheral attachment such as USB flash, biometric scanner, and barcode reader. Micro-USB to USB converter adaptor is used for USB flash drive, application download, and debugging.

## **Security**

---

Complies to PCI 3.x plus country specifics.

## Maintenance and Cleaning

Your terminal device is a product of superior design and craftsmanship and should be treated with care. It has no user-serviceable parts. The following suggestions will help you protect your warranty coverage.

- Keep the device dry. Precipitation, humidity, and all types of liquids or moisture can contain minerals that will corrode electronic circuits. If your device does get wet, switch off the power, and allow the device to dry completely before replacing it.
- Do not use or store the device in dusty and dirty areas. Its moving parts and electronic components can be damaged.
- Do not store the device in hot areas. High temperatures can shorten the life of electronic devices, damage batteries, and warp or melt certain plastics.
- Do not store the device in cold areas. Moisture can form inside the device and damage electronic circuit boards when the device returns to its normal temperature.
- Do not drop, knock, or shake the device. Rough handling can break internal circuit boards and fine mechanics.
- Do not use harsh chemicals, cleaning solvents, or strong detergents to clean the device. Use only a soft, clean, and dry cloth for cleaning.
- Do not paint the device. Paint can clog the moving parts and prevent proper operation.
- Keep the device free from any small and loose items (such as paper clips, staples, or coins) that could accidentally get inside it through an opening, such as the SD card reader slot or the primary smart card reader slot.
- Do not attempt to open the device other than as instructed in this guide. This device has security features that protect it from tampering. For example, the file content will be deleted if the device's outer casing is opened.

These suggestions apply equally to your terminal device, or any of its attachments or accessories. If your device is not working properly, take it to the nearest authorized service facility for servicing or replacement. For your safety, have this device serviced only by a Verifone-authorized service provider.



**CAUTION** Never use thinner, trichloroethylene, or ketone-based solvents – they can deteriorate plastic or rubber parts. Do not spray cleaners or other solutions directly onto the keypad or display.

## **Additional Safety Information**

---

The following are additional safety information in using this device.

- Power Adapter** Use only the power adapter that came with your device. Adapters for other electronic devices may look similar, but they may affect your device's performance or damage it.
- Potentially Explosive Environments** Do not use this device in any area with a potentially explosive atmosphere. Follow all signs and instructions. Potentially explosive atmospheres include areas where you would normally be advised to turn off your vehicle engine. Sparks in such areas could cause an explosion or fire resulting in bodily injury or even death.
- Card Readers** Do not attempt to clean the card readers. Doing so can void any warranty. Contact your Verifone distributor or service provider for card reader service.



## Service and Support

Contact your local Verifone representative or service provider for any problems on your terminal.

For product service and repair information:

- USA – Verifone Service and Support Group, 1-800-834-4366, Monday - Friday, 8 A.M. - 8 P.M., Eastern time.
- International – Contact your Verifone representative.

### Service Returns

You must obtain a Merchandise Return Authorization (MRA) number before returning the terminal to Verifone. The following procedure describes how to return one or more terminals for repair or replacement (U.S. customers only).



For international customers, please contact your local Verifone representative for assistance with your service, return, or replacement.

#### *Returning One or More Terminals for Repair or Replacement*

- 1 Gather the following information from the printed labels on the bottom of each terminal to be returned:
  - Product ID, including the model and part number. For example, “VX 690”, “m260-xxx-xx”, and “PTID xxxxxxxx.”
  - Serial number (S/N xxx-xxx-xxx).
- 2 Obtain the MRA numbers by completing the following:
  - Call Verifone within the United States toll-free at 1-800-Verifone and follow the automated menu options.
    - Select the MRA option from the automated message. The MRA department is open Monday–Friday, 8 A.M.–8 P.M., Eastern time.
    - Give the MRA representative the information gathered in [Step 1](#). If the list of serial numbers is long, you can fax the list, along with the information gathered in [Step 1](#), to the MRA department at 1-727-953-4172 (U.S.).
  - Address the fax clearly to the attention of the “Verifone MRA Dept.” Include a telephone number where you can be reached and your fax number.
  - Complete the Inquiry Contact Form at [http://www.verifone.com/aboutus/contact/contact\\_form.cfm](http://www.verifone.com/aboutus/contact/contact_form.cfm).

- Address the Subject box with to “Verifone MRA Dept.”
- Reference the model and part number in the Note box



One MRA number must be issued for each terminal you return to Verifone, even if you are returning several of the same model.

- 3 Describe the problem(s).
- 4 Provide the shipping address where the repaired or replacement unit must be returned.
- 5 Keep a record of the following items:
  - Assigned MRA number(s).
  - Verifone serial number assigned to the terminal you are returning for service or repair (serial numbers are located on the bottom of the unit).
  - Shipping documentation, such as air bill numbers used to trace the shipment.
  - Model(s) returned (model numbers are located on the Verifone label on the bottom of the terminal).

## Accessories and Documentation

Verifone produces accessories and documentation for the terminal. Refer to the part number in the left column when ordering.

Verifone Online Store at [www.store.verifone.com](http://www.store.verifone.com)

- USA – Verifone Customer Development Center, 1-800-834-4366, Monday - Friday, 7 A.M. - 8 P.M., Eastern time
- International – Contact your Verifone representative

Below are accessories used with your terminal. Contact your Verifone distributor to determine which of the accessories fit your requirements.

**Table 4** Accessories and VPNs

Accessory	Part Number	Description
Power pack	PWR260-001-XX-A	VX 690 DC power pack
	PWR262-001-XX-A	VX 685 DC power pack
Printer paper	PPR260-001-01-A	40 mm
Verifone cleaning Kit	VPN 02746-01	Cleaning kit
Serial dongle	VPN M267-D08-00	
Telephone line cable	VPN CBL000-001-01-A	2.1-meter (7-foot) telephone line cable, black, with modular RJ11-type connectors)

Refer to the following set of documents to learn more about the terminal:

VX 690 Certifications and Regulations Sheet	VPN - DOC260-001-EN
VX 690 Quick Installation Guide	VPN - DOC260-002-EN
VX 685/VX 690 Reference Guide	VPN - DOC260-004-EN
VX 690 Charging Base Certifications and Regulations Sheet	VPN - DOC260-005-EN
VX 690 BT Base Certifications and Regulations Sheet	VPN - DOC260-006-EN
VX 685/VX 690 Charging Base Quick Installation Guide	VPN - DOC260-007-EN
VX 690 BT Base Quick Installation Guide	VPN - DOC260-008-EN
VX 690 3G-BT-WiFi Certifications and Regulations Sheet	VPN - DOC260-009-EN
VX 690 3G-BT-WiFi Quick Installation Guide	VPN - DOC260-010-EN
VX 685 Certifications and Regulations Sheet	VPN - DOC262-001-EN
VX 685 Quick Installation Guide	VPN - DOC262-002-EN
Verix eVo Volume I: Operating System Programmers Manual	VPN - DOC00301
Verix eVo Volume II: Operating System and Communication Programmers Manual	VPN - DOC00302
Verix eVo Volume III: Operating System Programming Tools Reference Manual	VPN - DOC00303
VX 690 HW ERS Rev A00	SPC260-007-01-A
VX 690 Base ERS	SPC260-010-01-A
VX 690 PRD Rev. A02-2	SPC260-001-01-A
VX 690 OS ERS Rev 0.04	
VX 685 HW ERS Rev 004	SPC262-001-01-A
VX 685 OS ERS Rev 0.01	





## Troubleshooting Guidelines

This chapter lists typical examples of malfunctions that you may encounter while operating your terminal and the steps that you can take to resolve them.

The troubleshooting guidelines provided in the following sections are included to assist successful installation and configuration of the terminal. Please read these troubleshooting examples if you are having problems operating your unit. Contact your local Verifone representative for assistance if the problem persists even after performing the outlined guidelines or if the problem is not described.

**NOTE**

The terminal comes equipped with tamper-evident labels. It contains no user-serviceable parts. Do not, under any circumstance, attempt to disassemble the unit. Perform only those adjustments or repairs specified in this guide. Contact your local Verifone service provider for all other services. Service conducted by parties other than authorized Verifone representatives may void any warranty.

**CAUTION**

Not all units require use of a power supply.

Use only a Verifone-supplied power pack. Using an incorrectly rated power supply may damage the unit or cause it not to work properly. Ensure that the power supply used to power the unit matches the requirements specified on the back of the unit (see [Specifications](#) for detailed power supply specifications) before troubleshooting. If not, obtain the appropriately rated power supply before continuing with troubleshooting.

### Terminal Does Not Start

If the terminal does not start:

- Ensure that the smart battery charge state is not below the critically low level.
- Recharge or replace the smart battery.
- Ensure that you pressed the green ENTER/ON key for approximately four seconds, until the unit lights up.

### Terminal Display Does Not Show Correct/Readable Info

If the terminal display does not show correct/readable info:

- Recharge or replace the battery.
- Connect the terminal into a known-good power supply (if you have one) to see if this clears the problem.
- If the problem persists, Contact your local Verifone representative for assistance if the problem persists.

## Blank Display

When the terminal display does not show correct or clearly readable information:

- The battery pack may not be connected properly. Remove and reinstall the battery pack.
- Check all power and cable connections.
- Remove and reapply power to the terminal.
- Contact your local Verifone service provider if the problem persists.

## Printer Does Not Print

If the printer does not work properly:

- Make sure the battery is properly installed in the terminal. The printer does not print if there is no battery in the terminal.
- Check battery status or terminal power connection. The printer does not print if there is an insufficient charge remaining in the battery to complete the print operation.
- Check if the printer is out of paper (slow red blinking light) and that the roll is properly installed. Open the paper roll cover and install a new roll of printer paper or ensure that the roll is feeding correctly. A solid red indicator light indicates a printer error.
- Verify that the printer door is properly latched.
- Contact your local Verifone service provider if the problem persists.

## Printer Paper Jam

If paper jams inside the printer:

- Press the button at the bottom of the terminal to unlatch the paper roll cover, then open the cover.
- Remove the damaged paper from the paper roll and clear the feed mechanism.
- Install a roll of printer paper.
- If the problem persists, it may be due to poor paper quality. Install a new roll of higher-quality paper.



Poor-quality paper may jam the printer. Refer to [Accessories and Documentation](#) to order high-quality Verifone paper.

## **Keypad Does Not Respond**

If the keypad does not respond properly:

- Check the terminal display. If it displays the wrong character or nothing at all when you press a key, follow the steps outlined in [Transactions Fail To Process](#).
- Refer to the user documentation for that application if pressing a function key does not perform the expected action to ensure you are entering data correctly.
- Contact your local Verifone representative if the problem persists.

## **Transactions Fail To Process**

There are several possible reasons why the unit may not be processing transactions. Use the following steps to troubleshoot failures.

### ***Checking Magnetic Card Reader***

To check magnetic card reader:

- 1 Perform a test transaction using one or more different magnetic stripe cards to ensure the problem is not a defective card.
- 2 Ensure that you are swiping cards properly (see [Magnetic Card Reader](#)).
- 3 Process a transaction manually using the keypad instead of the card reader. If the manual transaction works, the problem may be a defective card reader.
- 4 Contact your local Verifone representative if the problem persists.

### ***Checking Smart Card Reader***

To check smart card reader:

- 1 Perform a test transaction using several different smart cards to ensure the problem is not a defective card.
- 2 Ensure that the card is inserted correctly (see [Smart Card Reader](#)).
- 3 Ensure the MSAM cards are properly inserted in the slots and are properly secured (see [MSAM Card](#)).
- 4 Contact your local Verifone representative if the problem persists.





## Battery Information

The terminal uses a high-capacity Lithium-ion battery pack. The internal logic of the battery prevents both overcharging and undercharging (a fault condition in which the battery level goes well below the minimum acceptable charge and the battery becomes unusable).

**NOTE**



The terminal operates on battery power or on power pack power. The battery charger in the terminal remains active whenever the power pack is connected.

### Charging

The battery has a safety circuit to protect the Lithium-ion cells from overcharging and over-discharging. If the battery is over-discharged, the safety circuit shuts down the battery. Recharge the battery to restore operation.

**NOTE**



The terminal automatically shuts off when the battery reaches the critically low charge state. If this occurs, recharge the battery for a minimum of 30 minutes before it can power the terminal. A safety circuit that has been discharged below its critical state may take several recharge attempts to reset.

### Advantages

Lithium-ion batteries have numerous advantages over other types of rechargeable batteries.

#### High energy density

Lithium-ion batteries have twice the energy density of standard nickel-cadmium batteries. This means they can store more energy than other rechargeable batteries.

#### Light weight

Lithium is the lightest metal enabling the manufacture of lightweight devices.

#### Long Life

Lithium-ion batteries require low maintenance. They do not exhibit memory effects, thereby eliminating the need for scheduled cycling to prolong the battery life.

#### Does Not Require Prolonged Initial Charging

Unlike their nickel-cadmium counterparts, lithium-ion batteries do not require prolonged initial charging. A regular charge cycle is enough.

### Low Self-Discharge Rate

Lithium-ion batteries have a lower self-discharge rate compared to other types of battery (the self-discharge rate for a lithium-ion battery is less than one-half of that of a nickel-cadmium battery). This means that once they are charged, they will retain their charge for a longer time than other types of rechargeable batteries. Other battery types can lose anywhere from 1-5% of their charge per day, (depending on the storage temperature) even if they are not installed in a terminal. Lithium-ion batteries will retain most of their charge even after months of storage.

### High Voltage Capacity

Lithium-ion batteries operate at higher voltages than other rechargeable batteries, about 3.6 volts for lithium-ion versus 1.2 volts for nickel-metal-hydride or nickel-cadmium batteries. This means a single cell can often be used rather than multiple metal-hydride or nickel-cadmium cells.

**Precautions** Observe the following precautions when handling lithium-ion batteries.

### Aging Effects

Battery packs are subject to aging, even when they are not used.

- Aging leads to deterioration in capacity or battery life.

**TIP**

Storing the battery in a cool environment (25 °C or less) at 40% charge reduces the effects of aging.

- 
- Batteries fail after 2 or 3 years, or approximately 300 charge-discharge cycles.
  - Chemicals may also affect the aging properties of batteries.

### Transportation Restrictions

- It is illegal to ship fully charge batteries by air because they may cause accidental explosions.
- Shipment of large quantities of lithium-ion batteries may be subject to regulatory control.

**NOTE**

These precautions do not apply to personal carry-on battery packs.

---

### Storage Precautions

- Do not fully charge batteries before storage. Keep the batteries partially charged before storing them, then charge them fully before actual usage.

- Do not store batteries when they are fully depleted. Charge an empty battery for at least one hour before storage. When a depleted battery self discharges, it may become unusable.
- Do not stock pile batteries. Avoid buying dated battery stocks even at reduced prices. Always check the date when the batteries were manufactured.



Do not dispose of batteries in a fire. Lithium-ion batteries must be recycled or disposed of properly. Do not dispose of Lithium-ion batteries in municipal waste sites.



## Notable Battery Specifications

The battery is designed to offer optimum protection to the terminals and their users.

### Safety/Protection Circuit

The battery features a safety/protection circuit that provides the following benefits:

- Limits the peak voltage in each cell during charging – a field effect transistor (FET) opens if voltage level in any cell reaches 4.28 V.
- Prevents cell voltage from dropping too low during discharge – a field effect transistor (FET) opens if voltage in any cell reaches 2.3 V.
- Limits the current going in and coming out of the battery pack. A field effect transistor (FET) opens the current path when charge current exceeds 6.5 A or when the discharge current exceeds 7 A. This prevents damage caused by shorting the battery contacts.

### Cell Temperature Monitoring

A discrete thermistor is built into the battery pack to prevent cell or terminal damage during charging. The terminal's OS monitors the cell temperature using the thermistor and automatically shuts down the charger if the temperature exceeds 50°C or falls below 0°C.

### ESD Protection

Electrostatic discharge (ESD) protection:  $\pm 8$  KV air discharge,  $\pm 4$  KV contact discharge

### Trip Recovery

The battery features a trip recovery system, which resolves faulty or hazardous conditions that led to a safety trip. Application of current through the charger resets the safety circuit.

## Battery FAQs

### Should I allow the battery to discharge completely before charging?

No. It is better to recharge the battery often and avoid frequent full discharge. However, allow a full discharge once a month to enable reset.

### Should I charge the battery partially or fully?

It does not matter whether you charge the battery fully or partially. Charging a full battery will not harm the battery.

### Should I charge the battery before putting it into storage?

It is advisable to store the battery with a 40% charge. However, storing the battery in a cool place is more important than the state of charge. Make sure the battery is not fully depleted before storage otherwise, the safety/protection circuit may trip.

### Will the battery heat up during charging?

It is normal for the battery to emit a small amount of heat during charging. The battery is equipped with a temperature sensor that will disrupt the flow of charge current when extreme temperature levels are detected.

---

**NOTE**

The recommended operating temperature for the terminal is from 0°C to 50°C (32°F to 122°F).

---

## Battery Specific Terms and Definitions

---

The following terms and definitions apply to the terminal's battery.

### Percent of Charge (%)

The ratio of the RC (remaining charge) value to the FC (full charge = 2450 mAh) value multiplied by 100%. The range is from 0 to 100.

The Percent of Charge value is available to terminal applications via OS calls. It is updated every 20 seconds.

### Remaining Charge (RC)

The amount of usable energy in the battery at a given time in mAh. The OS writes RC=FC at the end of charge. The range is from 0 to FC.

The RC value is available to terminal applications via OS calls. It is updated every 20 seconds.

### Safety/Protection Circuit

The terminal is equipped with a safety/protection circuit that protects the terminal from damage. For more information, see [Safety/Protection Circuit](#).

### Voltage

Under system load, the terminal reports battery pack voltage. The range is from 3 V to 4.2 V. It is updated every 20 seconds.

## General Battery Terms and Definitions

---

The following terms and definitions apply to most battery types, in general.

### Ampere-hour, Amp-hour (Ah)

A unit of electrical energy. It is the specified current flowing for one hour. Two ampere-hour is two amps of current flowing for one hour.

### **Battery Cell**

The battery cell is the basic electrochemical unit used to store energy. Each cell is typically rated 3.7 V. The terminal uses one lithium-ion rechargeable cell per battery pack.

### **Battery Pack**

A battery pack is an assembly of battery cells, safety circuit, temperature sensor, terminal contacts, and plastic case.

### **Battery Status, State of Charge**

This refers to the amount of electrical charge stored in the battery, expressed as a percentage of the difference between the fully-charged and fully-discharged states.

### **Capacity**

This refers to the amount of available energy in a fully charged battery, expressed in ampere-hours (Ah) or milliampere hours (mAh).



The capacity of terminal's high capacity battery pack is 2450 mAh typical (new).

---

### **Charge**

The amount of usable electrical energy stored in the battery, expressed in coulombs.

### **Charge Rate**

This refers to the amount of current applied to the battery during charging.



Charge rate for the terminal's battery: Initially 1 A tapering to zero at end of charge.

---

### **Charge Time**

The amount of time required to charge a battery. Maximum charge time refers to the amount of time to fully charge a fully discharged battery.



Typical charge time for the terminal's battery: 2450 mAh in approximately 3.33 hours.

### **Charging**

Refers to the process of converting electrical energy, in the form of electric current, from an external source (charger) into chemical energy within a battery cell.

### **Current**

The flow of electrons through a conductor, measured in amperes

### **Cycle**

This refers to the number of charge/discharge cycles the battery can endure before it loses its ability to store useful charge.



The terminal's battery pack retains approximately 70% of its original charge after 300 cycles.

---

### **Dead Battery**

A battery is considered “dead” when it deep discharges to the point that it can no longer accept a charge or when it has reached the end of its cycle life.

### **Deep Discharge**

The state of a battery that has been discharged well below its useful charge level. When a battery is in this state, it may be difficult to recharge. This characteristic indicates a reduced cycle life.

### **Discharge Time, Run Time**

This refers to the amount of time a battery can provide power to a system before it discharges fully. It is a function of the load that receives power from the battery.

### **Discharging**

Refers to the process of converting the chemical energy of a battery into electrical energy, and the transfer of the electrical energy into a load.

### **Self-Discharge Rate**

The amount by which the charge of the battery is reduced without providing any current to an external terminal or load.

### **Shelf-Life**

The length of storage under specified conditions that a battery can endure while retaining the ability to give a satisfactory performance upon full charge.

---

**NOTE**



The shelf life of the terminal battery pack is 6 months at 30% initial charge.

---

### **Voltage**

This is the unit of potential power or electric pressure, which is the force that causes current to flow through an electric conductor. It is measured in volts.



Verifone, Inc.  
2099 Gateway Place, Suite 600  
San Jose, CA, 95110 USA  
1-800-VERIFONE  
[www.verifone.com](http://www.verifone.com)

# VX 685/VX 690

## *Installation Guide*

