

Vertex Standard

EVX-5300 EVX-5400

OPERATING MANUAL

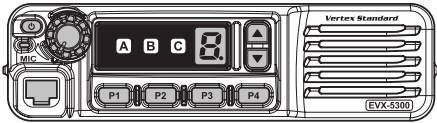

EVX-5300

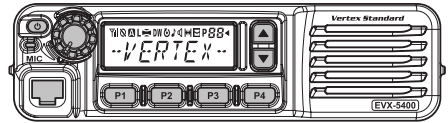

EVX-5400

PROGRAMMABLE FUNCTIONS/FEATURES

- 6 Programmable Function Keys
- 2-Tone Encode/Decode*¹
- 5-Tone Encode/Decode*¹
- MDC-1200® Encode/Decode*¹
- Horn Alert
- PA (Public Address)
- Scan
- Group Scan*²
- Dual Watch
- FM-Scan (Follow-Me Scan)
- TA Scan
- Encryption*¹
- Privacy
- VOX
- Talk Around
- Emergency
- Lone Worker
- TX Save Disable
- Direct Channel Entry*^{2, 3}
- Code Up/Down*²
- Code Set*²
- Speed Dial*^{2, 3}
- DTMF Code Set*^{2, 3}
- ID Check*²
- ARTS™/ARTSII™ (Auto Range Transpond System)*¹

*¹: Analog mode only

*²: EVX-5400 only

*³: Requires Optional MH-75A&J

Congratulations!

You now have at your fingertips a valuable communications tool: a Vertex Standard two-way radio! Rugged, reliable and easy to use, your Vertex Standard radio will keep you in constant touch with your colleagues for years to come, with negligible maintenance downtime.

Please take a few minutes to read this manual carefully. The information presented here will allow you to derive maximum performance from your radio.

We're glad you joined the Vertex Standard team. Call on us anytime, because communications is our business. Let us help you get your message across.

NOTICE !

There are no owner-serviceable parts inside the transceiver. All service jobs must be referred to an authorized Vertex Standard Service Representative. Consult your Authorized Vertex Standard dealer for installation of optional accessories.

SAFETY/WARNING INFORMATION

WARNING - DO NOT operate the **EVX-5300/-5400** radio when any person(s) (bystanders) outside the vehicle are within the distances shown in the chart at the bottom of this section.

Safety Training information:

Antennas used for this transmitter must not exceed an antenna gain of 0 dBi. The radio must be used in vehicle-mount configurations with a maximum operating duty cycle not exceeding 50 %, in typical Push-to-Talk configurations.

This radio is restricted to occupational use, work related operations only where the radio operator must have the knowledge to control the exposure limits of passengers and bystanders by maintaining the minimum separation distance shown below.

Failure to observe these restrictions will result in exceeding the FCC RF exposure limits.

Antenna Installation:

For rear deck trunk installation, the antenna must be located at least the following distance away from rear-seat passengers in order to comply with the FCC RF exposure requirements.

For roof top installations, the antenna must be placed in the center of the roof.

Unsafe Radiation Distance

VHF Model	UHF Model
2.9 Feet (0.89 m)	2.1 Feet (0.64 m)

INTRODUCTION

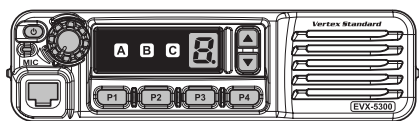

EVX-5300

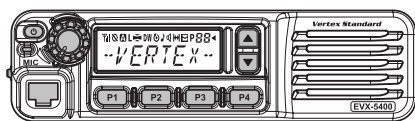

EVX-5400

The **EVX-5300/-5400** series are full-featured Digital/Analog transceiver designed for flexible mobile and base station business communications in the VHF/UHF Land Mobile bands. This transceiver designed for reliable business communications in a wide variety of applications with a wide range of operating capability provided by their leading-edge design.

The **EVX-5300/-5400** operates using the TDMA protocol for spectrum and power efficiency and lower total equipment cost compared to FDMA. Digital eliminates noise and static from voice transmit to only deliver the intended voice message crisply and clearly. The **EVX-5300/-5400** feature the AMBE+2™ vocoder for enhanced voice quality.

This transceiver allows up to 8 memory channels. Important channel frequency data is stored in the flash memory on the CPU, and is easily programmable by a Vertex Standard licensed dealers using a personal computer with Vertex Standard Programming equipment **FIF-12** USB Programming Interface and **CT-104A** Connection Cable for **FIF-12** and **CE142** Software. Or, once programmed, cloning cable **CT-4** can be used to program portable to portable directly.

The pages which follow will detail the many advanced features provided in the **EVX-5300/-5400** series transceiver. After reading this manual, you may wish to consult with your Network Administrator regarding precise details of the configuration of this equipment for use in your application.

For North American Users Regarding 406 MHz Guard Band

The U.S. Coast Guard and National Oceanographic and Atmospheric Administration have requested the cooperation of the U.S. Federal Communications Commission in preserving the integrity of the protected frequency range 406.0 to 406.1 MHz, which is reserved for use by distress beacons. Do not attempt to program this apparatus, under any circumstances, for operation in the frequency range 406.0 - 406.1 MHz if the apparatus is to be used in or near North America.

WARNING! FCC RF EXPOSURE REQUIREMENTS

THIS DEVICE COMPLIES WITH PART 15 OF THE FCC RULES. OPERATION IS SUBJECT TO THE FOLLOWING TWO CONDITIONS: (1) THIS DEVICE MAY NOT CAUSE HARMFUL INTERFERENCE, AND (2) THIS DEVICE MUST ACCEPT ANY INTERFERENCE RECEIVED, INCLUDING INTERFERENCE THAT MAY CAUSE UNDESIRE OPERATION.

THE GRANTEE IS NOT RESPONSIBLE FOR ANY CHANGES OR MODIFICATIONS NOT EXPRESSLY APPROVED BY THE PARTY RESPONSIBLE FOR COMPLIANCE. SUCH MODIFICATIONS COULD VOID THE USER'S AUTHORITY TO OPERATE THE EQUIPMENT.

This equipment has been tested and found to comply with the limits for a Class B digital device, pursuant to part 15 of the FCC Rules. These limits are designed to provide reasonable protection against harmful interference in a residential installation. This equipment generates, uses and can radiate radio frequency energy and, if not installed and used in accordance with the instructions, may cause harmful interference to radio communications. However, there is no guarantee that interference will not occur in a particular installation. If this equipment does cause harmful interference to radio or television reception, which can be determined by turning the equipment off and on, the user is encouraged to try to correct the interference by one or more of the following measures:

- Reorient or relocate the receiving antenna.
- Increase the separation between the equipment and receiver.
- Connect the equipment into an outlet on a circuit different from that to which the receiver is connected.
- Consult the dealer or an experienced radio/TV technician for help.

WARNING! IC RSS GENERAL REQUIREMENTS

ENGLISH

- ❑ This device complies with Industry Canada license-exempt RSS standard(s). Operation is subject to the following two conditions: (1) this device may not cause interference, and (2) this device must accept any interference, including interference that may cause undesired operation of the device.
- ❑ Under Industry Canada regulations, this radio transmitter may only operate using an antenna of a type and maximum (or lesser) gain approved for the transmitter by Industry Canada. To reduce potential radio interference to other users, the antenna type and its gain should be so chosen that the equivalent isotropically radiated power (e.i.r.p.) is not more than that necessary for successful communication.
- ❑ Antennas used for this transmitter (identify the device by certification number, or model number if Category II) must not exceed an antenna gain of 0 dBi. The radio must be used in vehicle-mount configurations with a maximum operating duty cycle not exceeding 50 %, in typical Push-to-Talk configurations. Antenna types having a gain greater than 0 dBi are strictly prohibited for use with this device.

FRENCH

- ❑ Le présent appareil est conforme aux CNR d'Industrie Canada applicables aux appareils radio exempts de licence. L'exploitation est autorisée aux deux conditions suivantes : (1) l'appareil ne doit pas produire de brouillage, et (2) l'utilisateur de l'appareil doit accepter tout brouillage radioélectrique subi, même si le brouillage est susceptible d'en compromettre le fonctionnement.
- ❑ Conformément à la réglementation d'Industrie Canada, le présent émetteur radio peut fonctionner avec une antenne d'un type et d'un gain maximal (ou inférieur) approuvé pour l'émetteur par Industrie Canada. Dans le but de réduire les risques de brouillage radioélectrique à l'intention des autres utilisateurs, il faut choisir le type d'antenne et son gain de sorte que la puissance isotrope rayonnée équivalente (p.i.r.e.) ne dépasse pas l'intensité nécessaire à l'établissement d'une communication satisfaisante.
- ❑ Antennes utilisées pour cet émetteur (identifier le dispositif par son numéro de certification ou son numéro de modèle s'il fait partie du matériel de catégorie II) ne doit pas dépasser un gain de l'antenne de 0 dBi. La radio doit être utilisée dans des configurations de montage en véhicule avec un maximum d'utilisation en fonctionnement n'excédant pas 50 %, dans des configurations typiques de Push-to-Talk. Types d'antenne ayant un gain supérieur à 0 dBi sont strictement interdits pour une utilisation avec cet appareil.

CONTROLS & CONNECTORS (EVX-5300)

Front Panel

Important! - All buttons located on the Front Panel are Programmable Function (PF) keys, configured according to your network requirements and programmed by your Vertex Standard dealer. The instructions below describe a typically-configured radio.

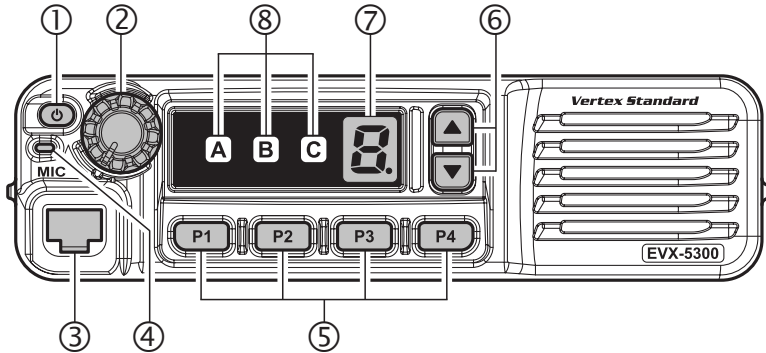

① PWR (⏻) Button

Press and hold in this button for 2 seconds to toggle the transceiver's power "on" and "off".

② VOL Knob

Turn this control clockwise to increase the volume.

③ Microphone Jack

Connect the microphone plug to this jack.

④ TX/BUSY Indicator

Indicates transceiver's Transmit/Receive Status.

⑤ [P1] - [P4] Keys (Programmable Function Keys)

These keys can be set up for special applications, such as High/Low power selection, Monitor, Talk-Around, etc., as determined by your network requirements and programmed by your Vertex Standard dealer.

⑥ [▼]/[▲] Keys (Programmable Function Keys)

In the factory default, pressing either key changes the current channel.

CONTROLS & CONNECTORS (EVX-5300)

⑦ Channel Number Indicator

Indicates the operating channel.

⑧ Transceiver Status Indicator

The “A”, “B”, and “C” indicators show current transceiver status, which can be customized via programming by your Vertex Standard dealer to meet your communications/network requirements. The possible these indicators are explained below.

TRANSCIVER STATUS INDICATOR

STATUS	INDICATOR			DESCRIPTION
	A	B	C	
MONI				This indicator is illuminated constantly when the signaling feature is disabled. The indicator blinks while the audio is passing normally.
SCAN CH				Illuminates the indicator when the scan enabled channel is recalled
PRI-1				Illuminates the indicator when the Priority-1 channel is activated
Low Power				Illuminates the indicator when the radio's transmitter is set to the “Low Power” mode
TA (Talk Around)				Illuminates the indicator when the “Talk Around” function is activated.
Privacy/Encryption				Illuminates the indicator when the “Voice Scrambler” function is enabled.
Emergency				Illuminates the indicator when the “Emergency” feature is activated.
Horn Alert				Illuminates the indicator when the “Horn Alert” feature is activated.
PA (Public Address)				Illuminates the indicator when the radio is turned to a PA amplifier.
Lock				Illuminates the indicator when the “Lock” feature is activated.
RFC				Illuminates the indicator when the radio is in the “Ready for Communication” condition while operating with the 2-Tone or 5-Tone signaling.

CONTROLS & CONNECTORS (EVX-5400)

Front Panel

Important! - All buttons located on the Front Panel are Programmable Function (PF) keys, configured according to your network requirements and programmed by your Vertex Standard dealer. The instructions below describe a typically-configured radio.

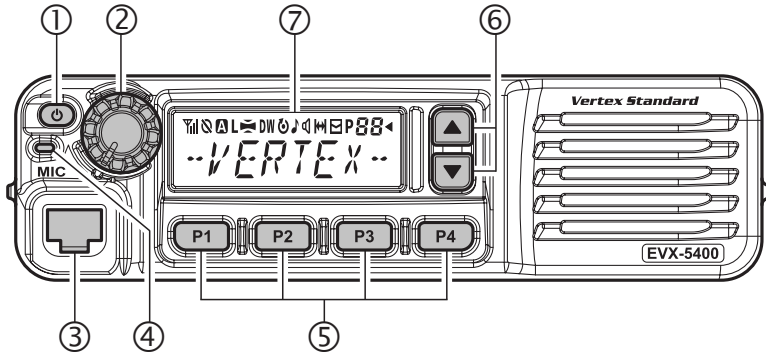

① PWR (⏻) Button

Press and hold in this button for 2 seconds to toggle the transceiver's power "on" and "off".

② VOL Knob

Turn this control clockwise to increase the volume.

③ Microphone Jack

Connect the microphone plug to this jack.

④ TX/BUSY Indicator

Indicates transceiver's Transmit/Receive Status.

⑤ [P1] - [P4] Keys (Programmable Function Keys)

These keys can be set up for special applications, such as High/Low power selection, Monitor, Talk-Around, etc., as determined by your network requirements and programmed by your Vertex Standard dealer.

⑥ [▼]/[▲] Keys (Programmable Function Keys)

In the factory default, pressing either key changes the current channel.

CONTROLS & CONNECTORS (EVX-5400)

⑦ LCD (Liquid Crystal Display)

The display includes a 8-character alpha-numeric section showing Channel nametags/identity information and error messages, and an upper icon row displaying feature status (see below).

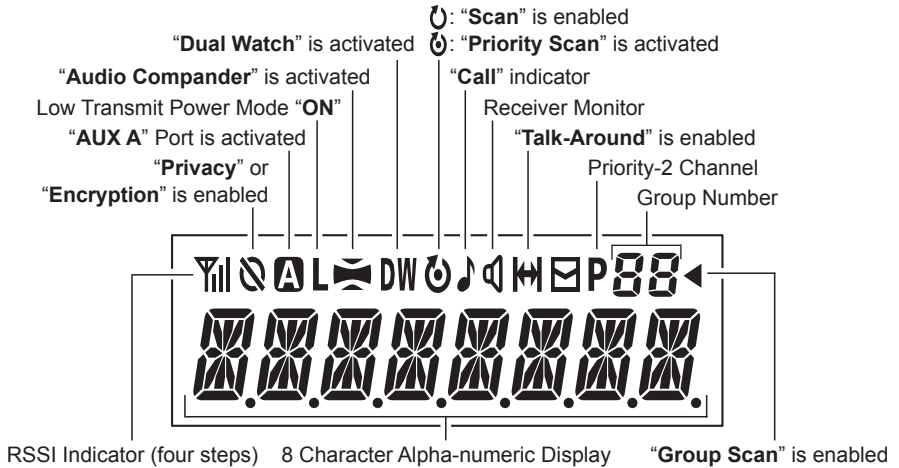

CONTROLS & CONNECTORS

Rear Panel

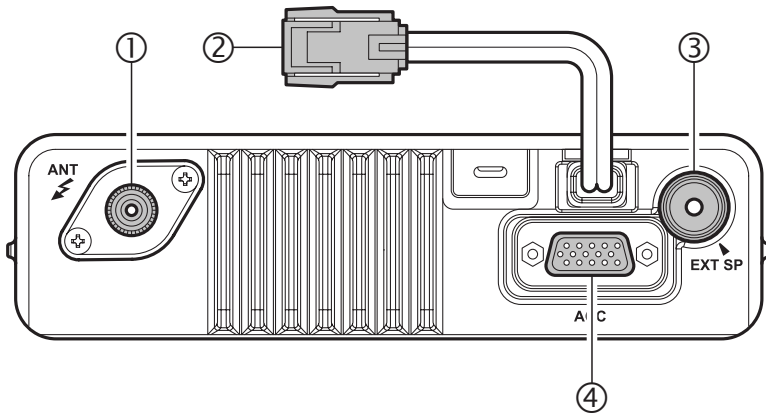

① Antenna Jack

The 50-Ohm coaxial feedline to the antenna must be connected here, using a mini-UHF plug.

② 13.6V DC Cable Pigtail with Connector

The supplied DC power cable must be connected to this 2-pin connector. Use only the supplied fused cable, extended if necessary, for power connection.

⚠ Replace only with the same or equivalent type fuse.

③ External Speaker Jack

An external loudspeaker may be connected to this 2-contact, 3.5-mm mini-phone jack.

Caution: Do not connect either wire of this line to ground, and be certain that the speaker has adequate capability to handle the audio output (12 W) from the radio.

④ D-Sub 15-Pin Accessory Connector

External TX audio line input, PTT (Push To Talk), Squelch, and external RX audio line output signals may be obtained from this connector for use with accessories such as data transmission/reception modems, and external Channel control input etc.

BASIC OPERATION OF THE TRANSCEIVER

Important! - Before turning on the radio the first time, confirm that the power connections have been made correctly and that a proper antenna is connected to the antenna jack.

Switching Power ON/OFF

- Press and hold in the **PWR**(☺) button for 2 seconds to turn the radio on. The display will become illuminated.
- Press the [▼]/[▲] key to choose the desired operating channel. In the **EVX-5400**, a channel name will appear on the display. The radio announces the channel number, if the Channel Announcement Feature is enabled via the clone editor software.
- In the **EVX-5400**, if you want to select an operating channel from a different group, press the **PF** key which is programmed to the Group Up/Down feature to select the group you want before selecting the operating channel. See page 9 for more information on the Programmable Function keys.

Setting the Volume

- Turn the **VOL** knob clockwise to increase the volume, and counterclockwise to decrease it.

Transmitting

- To transmit, monitor the channel and make sure it is clear.
- Press the **PF** key which is programmed to the Monitor feature to listen for channel activity.
- When receiving a call, transmit only after the incoming call ends. The radio cannot receive a call and transmit simultaneously.

The Channel Announcement Feature works as described below.

In the EVX-5300:

The maximum number of channels is 8.

The radio announces the channel number digit by digit.

In the EVX-5400:

The maximum number of channels is 512 (16 channels maximum per group). The radio announces Channels 1 - 9 by digit, while Channels 10 - 16 are announced by number.

For example, "Channel 1" is announced as "one" and "Channel 10" is announced as "one zero".

BASIC OPERATION OF THE TRANSCEIVER

- ❑ Press the **PTT** switch.
If the channel is clear, the **TX/BUSY** indicator will glow red. The radio is now transmitting. While holding in the **PTT** switch, speak across the face of the microphone in a clear and normal voice. For best transmission, hold the microphone about 1-1/2 to 2 inches (4 ~ 5 cm) away from your mouth. Release the **PTT** switch to receive.
- ❑ If the BCLO (Busy Channel Lockout) feature has been programmed on an *analog channel*, the radio will not transmit when a carrier is present. Instead, the radio will generate short beep three times and the **EVX-5400** indicates “CH BUSY” on the display.
Release the **PTT** switch and wait for the channel to be clear of activity.
- ❑ If the BTLO (Busy Tone Lockout) feature has been programmed on an *analog channel* or CCLO (Color Code Lockout) feature has been programmed on a *digital channel*, the radio can transmit only when there is no carrier being received or when the carrier being received includes the correct tone (CTCSS tone or DCS code) on an *analog channel* or correct code on a *digital channel*.

Transmit Time-Out Timer

If the selected channel has been programmed for automatic time-out, you must limit the length of each transmission. While transmitting, a beep will sound 10 seconds before time-out. Another beep will sound just before the deadline; the red “**TX**” indicator will disappear and transmission will cease soon thereafter. On the **EVX-5400**, “TIME OUT” will be indicated on the display. To resume transmitting, you must release the **PTT** switch and wait for the “penalty timer” to expire (if you press the **PTT** switch before this timer expires, the timer restarts, and you will have to wait another “penalty” period)

Key Lock

In order to prevent accidental operating function/feature change or inadvertent transmission, various aspects of the front panel’s keys may be locked out.

To activate the Locking feature, press and hold in the [**P1**] key while turning the radio on. To disable the Locking feature, repeat this power-on procedure.

ADVANCED OPERATION

Programmable Function (PF) Keys

The **EVX-5300/-5400** includes six Programmable Function (**PF**) keys. These **PF** keys can be customized, via programming by your Vertex Standard dealer, to meet your communications/network requirements.

The possible **PF** key programming features are illustrated on the next page, and these functions are explained beginning after page 12. For further details, contact your Vertex Standard dealer.

In this chapter, the following icons are used to indicate features supported in either the “Analog” mode or “Digital” mode:

 **A**: Indicates a “Analog” mode only feature.

 **D**: Indicates a “Digital” mode only feature.

For features that are available in both “Analog” and “Digital” modes, no icon is shown.

For future reference, check the box next to each function that has been assigned to the **PF** key on your particular radio, and keep it handy.

ADVANCED OPERATION

FUNCTION	PROGRAMMABLE KEY (PRESS KEY/PRESS & HOLD KEY)						MICROPHONE KEY (PRESS KEY/PRESS & HOLD KEY)					
	P1	P2	P3	P4	▲	▼	A	B	C	D	*	#
None	/	/	/	/	/	/	/	/	/	/	/	/
Monitor	/	/	/	/	/	/	/	/	/	/	/	/
Monitor -Momentarily-	/-	/-	/-	/-	/-	/-	/-	/-	/-	/-	/-	/-
Dimmer/Lamp	/	/	/	/	/	/	/	/	/	/	/	/
Low Power	/	/	/	/	/	/	/	/	/	/	/	/
Privacy/Encryption	/	/	/	/	/	/	/	/	/	/	/	/
SET* ¹	/	/	/	/	/	/	/	/	/	/	/	/
SQL OFF	/	/	/	/	/	/	/	/	/	/	/	/
SQL OFF -Momentarily-	/-	/-	/-	/-	/-	/-	/-	/-	/-	/-	/-	/-
SQL Set* ¹	/	/	/	/	/	/	/	/	/	/	/	/
Beep OFF	/	/	/	/	/	/	/	/	/	/	/	/
VOX	/	/	/	/	/	/	/	/	/	/	/	/
VOX Set* ¹	/	/	/	/	/	/	/	/	/	/	/	/
AF Min Volume	/	/	/	/	/	/	/	/	/	/	/	/
Horn Alert	/	/	/	/	/	/	/	/	/	/	/	/
PA (Public Address)	/	/	/	/	/	/	/	/	/	/	/	/
EXT ACC 1	/-	/-	/-	/-	/-	/-	/-	/-	/-	/-	/-	/-
EXT ACC 2	/	/	/	/	/	/	/	/	/	/	/	/
Emergency	/-	/-	/-	/-	/-	/-	/-	/-	/-	/-	/-	/-
Lone Worker	/	/	/	/	/	/	/	/	/	/	/	/
Group Up* ¹	/	/	/	/	/	/	/	/	/	/	/	/
Group Down* ¹	/	/	/	/	/	/	/	/	/	/	/	/
Channel Up	/	/	/	/	/	/	/	/	/	/	/	/
Channel Down	/	/	/	/	/	/	/	/	/	/	/	/
Speed CH Up* ¹	-/	-/	-/	-/	-/	-/	-/	-/	-/	-/	-/	-/
Speed CH Down* ¹	-/	-/	-/	-/	-/	-/	-/	-/	-/	-/	-/	-/
PRI-1	/	/	/	/	/	/	/	/	/	/	/	/
PRI-2	/	/	/	/	/	/	/	/	/	/	/	/
PRI-2 Set	/	/	/	/	/	/	/	/	/	/	/	/
PRI-2 Disable	/	/	/	/	/	/	/	/	/	/	/	/
Direct CH 1	/	/	/	/	/	/	/	/	/	/	/	/
Direct CH 2	/	/	/	/	/	/	/	/	/	/	/	/
Direct CH 3	/	/	/	/	/	/	/	/	/	/	/	/
Direct CH 4	/	/	/	/	/	/	/	/	/	/	/	/
Direct CH Entry* ¹	-/-	-/-	-/-	-/-	-/-	-/-	/	/	/	/	/	/
Scan	/	/	/	/	/	/	/	/	/	/	/	/
Group Scan* ¹	/	/	/	/	/	/	/	/	/	/	/	/
Dual Watch	/	/	/	/	/	/	/	/	/	/	/	/
FM-Scan	/	/	/	/	/	/	/	/	/	/	/	/
Scan Set	/	/	/	/	/	/	/	/	/	/	/	/
Group Scan Set* ¹	/	/	/	/	/	/	/	/	/	/	/	/
TA Scan	/	/	/	/	/	/	/	/	/	/	/	/
Talk Around	/	/	/	/	/	/	/	/	/	/	/	/
Reset	/	/	/	/	/	/	/	/	/	/	/	/

※1: This function cannot assign to **EVX-5300**.

ADVANCED OPERATION

FUNCTION	PROGRAMMABLE KEY (PRESS KEY/PRESS & HOLD KEY)						MICROPHONE KEY (PRESS KEY/PRESS & HOLD KEY)					
	P1	P2	P3	P4	▲	▼	A	B	C	D	*	#
CALL 1	/	/	/	/	/	/	/	/	/	/	/	/
CALL 2	/	/	/	/	/	/	/	/	/	/	/	/
CALL 3	/	/	/	/	/	/	/	/	/	/	/	/
CALL 4	/	/	/	/	/	/	/	/	/	/	/	/
CALL 5	/	/	/	/	/	/	/	/	/	/	/	/
Code Up ^{×1}	/	/	/	/	/	/	/	/	/	/	/	/
Code Down ^{×1}	/	/	/	/	/	/	/	/	/	/	/	/
Code Set ^{×1, 2}	/	/	/	/	/	/	/	/	/	/	/	/
Speed Dial ^{×1, 2}	/	/	/	/	/	/	/	/	/	/	/	/
DTMF Code Set ^{×1, 2}	-/-	-/-	-/-	-/-	-/-	-/-	/	/	/	/	/	/
Call	/	/	/	/	/	/	/	/	/	/	/	/
Status Set ^{×1}	/	/	/	/	/	/	/	/	/	/	/	/
Status Up ^{×1}	/	/	/	/	/	/	/	/	/	/	/	/
Status Down ^{×1}	/	/	/	/	/	/	/	/	/	/	/	/
Status Check ^{×1}	/	/	/	/	/	/	/	/	/	/	/	/
Duty	/	/	/	/	/	/	/	/	/	/	/	/
ID Check ^{×1}	/	/	/	/	/	/	/	/	/	/	/	/
ARTS Login ^{×1}	/	/	/	/	/	/	/	/	/	/	/	/
TX Save Disable	/	/	/	/	/	/	/	/	/	/	/	/
Lock	/	/	/	/	/	/	/	/	/	/	/	/

×1: This function cannot assign to **EVX-5300**.

×2: Requires the optional **MH-75A&J**.

ADVANCED OPERATION

Description of Operating Functions

MONITOR

Press (or press and hold) the assigned **PF** key to cancel any signaling features.

MONITOR -MOMENTARILY-

Cancel any signaling features while pressing the assigned **PF** key.

DIMMER/LAMP

In the **EVX-5400**, press (or press and hold) the assigned **PF** key to select the brightness level of the display and keypad (“Dimmer” function). Available selections are four levels.

In the **EVX-5300**, press (or press and hold) the assigned **PF** key to toggle the back light of the display and keypad “On” and “Off” (“Lamp” function).

LOW POWER

Press (or press and hold) the assigned **PF** key to set the radio’s transmitter to the “Low Power” mode. Press (or press and hold) the **PF** key again to return to “High Power” operation when in difficult terrain.

In the **EVX-5300**, when the radio’s transmitter is set to “Low Power” mode, the Transceiver Status Indicator (“**A**”, “**B**” or “**C**”) will illuminate, if the “**Low Power**” status is assigned to one of the Transceiver Status Indicator.

In the **EVX-5400**, when the radio’s transmitter is set to “Low Power” mode, the “**L**” icon will be indicated on the display.

PRIVACY / ENCRYPTION

Press (or press and hold) the assigned **PF** key to toggle the Privacy (analog mode)/ Encryption (digital mode) feature “On” and “Off”. The Privacy/Encryption feature initiates an encryption algorithm that will protect your communication from unauthorized eavesdropping.

In the **EVX-5300**, when the Privacy feature is activated, the Transceiver Status Indicator (“**A**”, “**B**” or “**C**”) will illuminate, if the “**Privacy**” status is assigned to one of the Transceiver Status Indicator.

In the **EVX-5400**, when the Privacy feature is activated, the “” icon will be indicated on the display.

ADVANCED OPERATION

SET (This function is only available in the EVX-5400)

Press (or press and hold) the assigned **PF** key to activate the “User Set” (Menu) Mode.

SQL OFF

Press (or press and hold) the assigned **PF** key to open the SQL to hear background noise (unmute the audio).

SQL OFF -MOMENTARILY-

Opens the SQL to hear background noise (unmute the audio) while pressing the assigned **PF** key.

SQL SET

You can manually adjust the squelch level using this function:

- Press (or press and hold) the assigned **PF** key. A tone will sound, and the current squelch level will appear on the display.
- Press the [▼]/[▲] key to select the desired squelch level.
- Press the [**P4**] key (or **MH-75A8J**'s [**D**] key) to store the new setting. The display indicates “- SET -” briefly, then reverts to the normal channel indication. You may cancel the new setting by pressing the [**P3**] key (or **MH-75A8J**'s [**C**] key). In this case, the display indicates “- CANCEL -” briefly.

BEEP OFF

Press (or press and hold) the assigned **PF** key to toggle the beeper “On” and “Off”.

VOX

Press (or press and hold) the assigned **PF** key to turn the VOX function “On” or “Off”. You may disable the VOX function temporarily by pressing the **PTT** switch.

VOX SET (This function is only available in the EVX-5400)

You can manually adjust the VOX Gain using this function:

- Press (or press and hold) the assigned **PF** key. A tone will sound, and the current VOX Gain level will appear on the display.
- Press the [▼]/[▲] button to select the desired VOX Gain level.
- Press the [**P4**] key (or **MH-75A8J**'s [**D**] key) to store the new setting. The display indicates “- SET -” briefly, then reverts to the normal channel indication. You may cancel the new setting by pressing the [**P3**] key (or **MH-75A8J**'s [**C**] key). In this case, the display indicates “- CANCEL -” briefly.

ADVANCED OPERATION

AF MIN VOLUME

Press (or press and hold) the assigned **PF** key to reduce the audio output to the (lower) level programmed by your Vertex Standard dealer.

HORN ALERT

Press (or press and hold) the assigned **PF** key to turn the Horn Alert function “On” or “Off”. If you receive a call from the base station with the signaling, horn alert will be activated and your vehicles horn will sound.

In the **EVX-5300**, when the Horn Alert function is activated, the Transceiver Status Indicator (“**A**”, “**B**” or “**C**”) will illuminate, if the “**Horn Alert**” status is assigned to one of the Transceiver Status Indicator.

In the **EVX-5400**, when the Horn Alert function is activated, “- HA -” will be indicated on the display.

PA (PUBLIC ADDRESS)

Press (or press and hold) the assigned **PF** key to use the transceiver as a PA amplifier. The public address can be used even while scanning and receiving a call.

In the **EVX-5300**, when the Public Address function is activated, the Transceiver Status Indicator (“**A**”, “**B**” or “**C**”) will illuminate, if the “**Public Address**” status is assigned to one of the Transceiver Status Indicator.

In the **EVX-5400**, when the Public Address function is activated, “- PA -” will be indicated on the display.

EXT ACC 1

Activates the output port “1” of the D-Sub 15-pin Accessory Connector while pressing the assigned **PF** key.

EXT ACC 2

Press (or press and hold) the assigned **PF** key to toggle the output port “2” of the D-Sub 15-pin Accessory Connector “On” and “Off”.

EMERGENCY

The **EVX-5300/-5400** includes an “Emergency” feature which may be useful if you have someone monitoring on the same frequency as your transceiver’s channel.

Press the assigned **PF** key to initiate an emergency call. For further details contact your Vertex Standard dealer.

ADVANCED OPERATION

LONE WORKER

Press (or press and hold) the assigned **PF** key to toggle the Lone Worker feature “On” and “Off”.

The Lone Worker feature is designed to emit an alarm for 30 seconds when the Lone Worker Timer (programmed by your Vertex Standard dealer) has expired. If the user does not reset the timer by pressing the **PTT** switch, the radio switches to the Emergency mode.

To revive the radio from the Emergency mode, just press (or press and hold) the **PF** key which is assigned the Emergency feature or turn off the radio.

GROUP UP/DOWN (This function is only available in the EVX-5400)

Press (or press and hold) the assigned **PF** key to select a different group of channels.

CHANNEL UP/DOWN

Press (or press and hold) the assigned **PF** key (generally the [▲]/[▼] key) to select a different channel within the current group.

SPEED CH UP/DOWN (This function is only available in the EVX-5400)

Press and hold the assigned **PF** key causes the radio to begin stepping (repeatedly) upward or downward through the channels.

PRI-1/PRI-2

Press (or press and hold) the assigned **PF** key to recall the pre-programmed priority channel directly. This is pre-programmed by your Vertex Standard dealer.

PRI-2 SET

Press (or press and hold) the assigned **PF** key to toggle the current channel to the priority channel 2 “enable” and “disable”.

PRI-2 DISABLE

Press (or press and hold) the assigned **PF** key to disable the priority channel 2 of the group temporarily.

DIRECT CH 1 TO DIRECT CH 4

Press (or press and hold) the assigned **PF** key to recall the pre-programmed channel directly. This is pre-programmed by your Vertex Standard dealer.

ADVANCED OPERATION

DIRECT CH ENTRY

(This function is only available in the **EVX-5400** and requires the Optional **MH-75A8J** 16-Keypad Microphone)

You can recall the desired channel directly using this function:

- Press (or press and hold) the assigned **PF** key. A tone will sound, and the current group/channel number will appear on the display.
- Enter the desired group number (two digits) and channel number (two digits) on the **MH-75A8J**'s keypad.
- Press the [**P4**] key (or **MH-75A8J**'s [**D**] key) to store the new setting. The display indicates “- **SET** -” briefly, then reverts to the normal channel indication. You may cancel the new setting by pressing the [**P3**] key (or **MH-75A8J**'s [**C**] key). In this case, the display indicates “- **CANCEL** -” briefly.

SCAN

The Scanning feature is used to monitor multiple channels programmed into the transceiver. While scanning, the transceiver will check each channel for the presence of a signal, and will stop on a channel if a signal is present. **EVX-5300/-5400** can scan both digital and analog frequency programmed channels simultaneously.

To activate scanning:

- Press (or press and hold) the assigned **PF** key to activate scanning on the channel which is pre-programmed into the scan list by your Vertex Standard dealer.
- The scanner will search the programmed channels, looking for active ones; it will pause each time it finds a channel on which someone is speaking.
- Press (or press and hold) the assigned **PF** key again to disable scanning. Operation will revert to the programmed revert channel.

Note: Your Vertex Standard dealer may have programmed your radio to stay on one of the following channels if you press the **PTT** switch during the scanning pause:

- “Scan Pause” channel (“Talk Back”)
- “Last Busy” channel
- “Priority-1/-2” channel
- “User Programmed” channel (“Select Channel”)
- “Scan Start” channel

ADVANCED OPERATION

GROUP SCAN (This function is only available in the EVX-5400)

The Scanning feature is used to monitor multiple channels programmed into the transceiver. While scanning, the transceiver will check each channel of the programmed group for the presence of the signal, and will stop on a channel if a signal is present.

Press (or press and hold) the assigned **PF** key to activate the scanning on the selected groups.

DUAL WATCH

The Dual Watch feature is similar to the SCAN feature, except that only two channels are monitored:

- The current operating channel; and
- The Priority-1/-2 channel.

To activate Dual Watch:

- Press (or press and hold) the assigned **PF** key.
- The scanner will search the two channels; it will pause each time it finds a channel on which someone is speaking.

To stop Dual Watch:

- Press (or press and hold) the assigned **PF** key.
- Operation will revert to the “Dual Watch Start” channel.

FM-SCAN (FOLLOW-ME SCAN)

FM-Scan (Follow-Me Scan) feature checks a User-assigned Priority Channel regularly as you scan the other channels. Thus, if only Channels 1, 3, and 5 (of the 8 available channels) are designated for “Scanning,” the user may nonetheless assign Channel 2 as the “User-assigned” Priority Channel via the FM-Scan (Follow-Me Scan).

To activate the FM-Scan (Follow-Me Scan), first select the channel you want to designate as the “User-Assigned Priority Channel” and press (or press and hold) the assigned programmable key. Then press (or press and hold) the Channel Up/Down key (generally the [▲]/[▼] key) to recall to the “Scanning Start” channel which has been programmed by your dealer to activate the scanner. When the scanner stops on an “Active” channel, the User-assigned Priority Channel will automatically be checked every few seconds; if activity is found on the User-assigned Priority Channel, the radio will switch between it and the Dealer-Assigned Priority Channel, if any.

ADVANCED OPERATION

SCAN SET

Press (or press and hold) the assigned **PF** key to add/delete the current channel to/from your scanning list.

In the **EVX-5300**, when you delete channel, the Transceiver Status Indicator (“**A**”, “**B**” or “**C**”) will turn off, if the “**SCAN CH**” status is assigned to one of the Transceiver Status Indicator. To restore a particular channel to your scanning list, press (or press and hold) the assigned **PF** key again; the Transceiver Status Indicator (“**A**”, “**B**” or “**C**”) will illuminate.

In the **EVX-5400**, when you delete channel, the display indicates “- **SCN SKIP** -” briefly and the “**U**” icon will disappear from the display. To restore a particular channel to your scanning list, press (or press and hold) the assigned **PF** key again; the display indicates “- **SCN SET** -” briefly and “**U**” icon will appear on the display.

Furthermore, press (or press and hold) the assigned **PF** key while the scanner is paused, this removes the channel from the scan list temporarily.

GROUP SCAN SET (This function is only available in the EVX-5400)

You may wish to have the Scanner pass through more than one Group during the scanning process (normally, scanning is performed within the current group only). *To include the current Group in the scanning loop*, press (or press and hold) the assigned programmable key (the “**◀**” icon will appear on the display). *To remove a current Group from Group Scan*, press (or press and hold) the assigned programmable key again (the “**◀**” icon will disappear from the display).

TA SCAN

Press (or press and hold) the assigned **PF** key to toggle the TA (Talk Around) scan feature “On” and “Off.”

While TA scan is enabled, the transceiver will search both the transmit and receive frequencies (In the **EVX-5400**, the “**TA**” icon will blink on the display). When a signal is encountered on the receive frequency, the transceiver will pause until the signal disappears (In the **EVX-5400**, “**TA**” icon will appear but not blink). When a signal is encountered on the transmit frequency, the transceiver will check for activity on the receive frequency every few seconds (interval programmed by your Vertex Standard dealer).

Note: The TA Scan feature does not activate on the Simplex Channel.

ADVANCED OPERATION

TALK AROUND

Press (or press and hold) the assigned **PF** key to activate the Talk Around feature when you are operating on duplex channel systems (separate receive and transmit frequencies, utilizing a “repeater” station). The Talk Around feature allows you to bypass the repeater station and talk directly to a station that is nearby. This feature has no effect when you are operating on “simplex” channels, where the receive and transmit frequencies are already the same.

In the **EVX-5300**, when the “TA” function is activated, the Transceiver Status Indicator (“**A**”, “**B**” or “**C**”) will illuminate, if the “**Talk Around**” status is assigned to one of the Transceiver Status Indicator.

In the **EVX-5400**, when the “TA” function is activated, the “” icon will be indicated on the display.

Note that your Vertex Standard may have made provision for “Talk Around” channels by programming “repeater” and “Talk Around” frequencies on two adjacent channels. If so, the key may be used for one of the other Pre-Programmed Functions.

Note: The Talk Around feature does not activate on the Simplex Channel.

RESET

Press (or press and hold) the assigned **PF** key to reset the RFC (Ready for Communication) condition.

CALL 1 TO CALL 5

Press (or press and hold) the assigned **PF** key to send a 2-Tone or 5-Tone sequential burst which is pre-programmed.

CODE UP/DOWN (This function is only available in the EVX-5400)

Press (or press and hold) the assigned **PF** key to select a 2-Tone or 5-Tone encode code from the pre-programmed encode list.

ADVANCED OPERATION

CODE SET (This function is only available in the EVX-5400)

- Press (or press and hold) the assigned **PF** key to change the 5-Tone encoding digit.
To change the tones, select the desired digit using the [**P1**]/[**P2**] keys (or **MH-75A8J**'s [**A**]/[**B**] keys), then change the number using the [**▼**]/[**▲**] keys.
- Press the [**P4**] key (or **MH-75A8J**'s [**D**] key) to store the new setting. The display indicates “- SET -” briefly, then reverts to the normal channel indication.
You may cancel the new setting by pressing the [**P3**] key (or **MH-75A8J**'s [**C**] key). In this case, the display indicates “- CANCEL -” briefly.

You may enter the 5-Tone encoding code directly from the microphone's numeric key ([**0**] - [**9**]) and [*****] key (wild card), if the optional **MH-75A8J** microphone is used.

SPEED DIAL (This function is only available in the EVX-5400)

Your Vertex Standard dealer may have pre-programmed Auto-Dial telephone number memories into your radio.

To dial a number:

- If the optional **MH-75A8J** microphone is used, press (or press and hold) the assigned **PF** key, then press the microphone's numeric key ([**0**] - [**9**]) corresponding to the Auto-Dial memory number which is provided by your Vertex Standard Dealer, then press the **PTT** switch. The DTMF tones sent during the dialing sequence will be heard in the speaker.
- If the normal (without keypad) microphone is used, press the [**▼**]/[**▲**] keys to select the Auto-Dial memory number which is pre-programmed by your Vertex Standard dealer, then press the **PTT** switch. The DTMF tones sent during the dialing sequence will be heard in the speaker.

DTMF CODE SET

(This function is only available in the **EVX-5400** and requires the Optional **MH-75A8J** 16-Keypad Microphone)

Press (or press and hold) the assigned **PF** key to start storing the DTMF dialing sequence. After entering to enter all DTMF digits from the **MH-75A8J**'s keypad, you can transmit the code by pressing the **PTT** switch.

ADVANCED OPERATION

CALL

When using the DTMF Paging System

This feature, if enabled, allows the user to change the 3-digit Page Call code, used to call other similarly-equipped stations. Press (or press and hold) the assigned programmable key, followed by the three digits representing the Page Call code of the station you wish to call. Three tones will be heard after the last key is pressed (the new code will now be transmitted).

The receiver squelch of the other station will be opened, and you can begin communication.

When using the 2-tone/5-tone Signaling System

This feature, if enabled, press (or press and hold) the assigned **PF** key to send a 2-tone/5-tone sequential tone.

When using the MDC1200 System

This feature, if enabled, press (or press and hold) the assigned **PF** key to send an MDC1200 code.

- Press (or press and hold) the assigned **PF** key to enter the “Call Menu” mode.
- Press the [**▼**]/[**▲**] keys (or [**P1**]/[**P2**] keys) to select the desired Call mode, then press the [**P4**] key to accept the selection. (You may cancel the selection by pressing the [**P3**] key).
- Press the [**▼**]/[**▲**] (or [**P1**]/[**P2**] keys) to select the station to be called. You may enter the station’s ID number (four digits) directly from the microphone’s key ([**0**] - [**9**], [**A**] - [**D**], [**#**]: substitute for “E”, and [*****]: wild card), if the optional **MH-75A8J** microphone is used.
- Press the **PTT** switch to send an MDC1200 call.

STATUS SET (This function is only available in the **EVX-5400**)

Press (or press and hold) the assigned **PF** key to change the 5-tone status code. To change the status code, select the desired digit by pressing the [**P1**] key, then change the number by pressing the [**P2**]/[**P3**] key, and store the number by pressing the [**P4**] key.

You may enter the 5-tone status code directory from the microphone’s numeric key ([**0**] - [**9**]), if the optional **MH-75A8J** microphone is used.

ADVANCED OPERATION

STATUS UP/DOWN (This function is only available in the EVX-5400)

Press (or press and hold) the assigned **PF** key to select a 5-tone status code from the pre-defined status list.

STATUS CHECK (This function is only available in the EVX-5400)

Press (or press and hold) the assigned **PF** key to check the 5-tone receive status code. When you press this key, the display will indicate the “Message” corresponding to the receive status condition per the pre-defined status list.

DUTY

Press (or press and hold) the assigned **PF** key to toggle the Duty function of the 2-tone/5-tone decoder “On” and “Off”.

When the Duty function is set to “On”, the user will always hear (depending on the sub-audio signaling) all traffic on the paging channel. The radio will sound the paging alert when it receives the programmed 2-tone/5-tone code.

When the Duty function is set to “Off”, the user will NOT hear normal radio traffic on the paging channel. The radio will sound the paging alert and unmute only when it receives the programmed 2-tone/5-tone code.

ID CHECK (This function is only available in the EVX-5400)

This function allows logged ID of the DTMF Signaling and 5-tone Signaling to be reviewed and relayed (5-tone Signaling only) to a specific station:

- Press (or press and hold) the assigned **PF** key to display the logged ID of the DTMF Signaling and 5-tone Signaling.
- Press the [**P4**] key to select the category (“DTMF Signaling” or “5-tone Signaling”) to be reviewed, then press the [**▼**]/[**▲**] keys to select the ID.
- Press the [**P2**] key to toggle the display between the “ID code display” and “Tag display”.
- Press the [**P1**] key to send the Call back, when recalling the ID of the “5-tone Signaling”, if desired.

TX SAVE DISABLE

Press (or press and hold) the assigned **PF** key to disable the Transmit Saver, if you are operating in a location where high power is almost always needed.

The Transmit Saver reduces the transmit power when a very strong signal from an apparently nearby station is being received.

ADVANCED OPERATION

LOCK

Press (or press and hold) the assigned **PF** key to lock the various aspects of the front panel's keys. The precise lockout configuration must be programmed by your Vertex Standard dealer.

ARTS™ (AUTO RANGE TRANSPOND SYSTEM)

This system is designed to inform you when you and another ARTS™-equipped station are within communication range.

During ARTS™ operation, when the radio receives an incoming ARTS™ signal, a short beep will sound, and “IN SERV” (“In Service”) will be indicated on the display for 2 seconds*. If you move out of range for more than two minutes, your radio senses that no signal has been received; a short triple-beep will sound, and “OUT SERV” (“Out of Service”) will be displayed on the display for 2 seconds*. If you subsequently move back into communication range, as soon as the other station transmits, a short beep will sound and “IN SERV” will be indicated again on the display for 2 seconds*.

※: **EVX-5400** only.

ARTSII™ (AUTO RANGE TRANSPOND SYSTEM)

The ARTSII™ system is enhanced feature of the ARTSII™ which can be finding out the communication range of the radio individually by using the MDC-1200® Encode/Decoder.

Note: **EVX-5300** will be able to be decoded by display radios with ARTSII™ enabled, but will not be able to decode the other radios encode signals.

USER SET MODE

The **EVX-5400** includes a “User Set” (Menu) Mode which allows the user to define or configure various settings, such as Squelch, Display contrast, etc. To activate the “User Set” (Menu) Mode:

- Press the **PF** key assigned to the “**SET**” function.
- Select the User Set Mode item you wish to change using the [**P1**]/[**P2**] keys, then use the [**▼**]/[**▲**] keys to adjust the setting of the selected item.
- Press the [**P4**] key to store the new configuration.
You may cancel the selection by pressing the [**P3**] key.
- Press the programmable key assigned to the “**SET**” function to exit to normal operation.

DISPLAY	
SQL	Sets the Squelch level.
Beep	Enables/Disables the Key Beeper.
Bell	Enables/Disables the Bell function. (alert tone activated by incoming signaling)
Light	Enables/Disables the back light of the display and keypad.
Key	Enables/Disables the Key Lock function.
PTT	Enables/Disables the PTT Lock function.
DIMMER	Sets the LCD Brightness level.
Scan	Engages/Disengages Scanning.
DW	Engages/Disengages Dual Watch.
AF	Sets the minimum Audio Volume level.
CONTRAST	Sets the LCD Contrast level.
VOX	Sets the VOX Gain level.
Encryption	Enables/Disables the disabling the Encryption Unit temporarily. ENB: Enables the disabling the Encryption Unit. DIS: Disables the disabling the Encryption Unit.
TX Save	Enables/Disables the TX Save function.

OPTIONAL ACCESSORIES

MH-67A8J	Standard Microphone
MH-75A8J	16-Keypad Microphone
MD-12A8J	Desktop Microphone
MLS-100	External Speaker (12 W Peak Power)
LF-6	Line Filter
CE142	PC Programming Software
CT-4	Programming Cable (Radio to Radio Clone Cable)
FIF-12	USB Programming Interface
CT-104A	Connection Cable for FIF-12 (8-pin DIN ↔ 8-pin Modular)

Availability of accessories may vary; some accessories are supplied standard per local requirements, others may be unavailable in some regions.

Check with your Vertex Standard Dealer for changes to this list.

The AMBE+2™ voice coding Technology embodied in this product is protected by intellectual property rights including patent rights, copyrights and trade secrets of Digital Voice Systems, Inc. This voice coding Technology is licensed solely for use within this Communications Equipment. The user of this Technology is explicitly prohibited from attempting to decompile, reverse engineer, or disassemble the Object Code, or in any other way convert the Object Code into a human-readable form.

U.S. Pat. Nos. #5,870,405, #5,826,222, #5,754,974, #5,701,390, #5,715,365, #5,649,050, #5,630,011, #5,581,656, #5,517,511, #5,491,772, #5,247,579, #5,226,084 and #5,195,166.

DISPOSAL OF YOUR ELECTRONIC AND ELECTRIC EQUIPMENT

Products with the symbol (crossed-out wheeled bin) cannot be disposed as household waste.

Electronic and Electric Equipment should be recycled at a facility capable of handling these items and their waste by products.



In EU countries, please contact your local equipment supplier representative or service center for information about the waste collection system in your country.

NOTICE !

There are no owner-serviceable parts inside the transceiver. All service jobs must be referred to an authorized Vertex Standard Service Representative. Consult your Authorized Vertex Standard Dealer for installation of optional accessories.

Part 15.21: Changes or modifications to this device not expressly approved by Vertex Standard could void the user's authorization to operate this device.



Vertex Standard LMR, Inc.



Copyright 2013
Vertex Standard LMR, Inc.
All rights reserved.

No portion of this manual
may be reproduced
without the permission of
Vertex Standard LMR, Inc.