



HF/50 MHz TRANSCEIVER

FT-2000

OPERATING MANUAL



VERTEX STANDARD CO., LTD.

4-8-8 Nakameguro, Meguro-Ku, Tokyo 153-8644, Japan

VERTEX STANDARD

US Headquarters

1090 Walker Street, Cypress, CA 90630, U.S.A.

YAESU EUROPE B.V.

P.O. Box 75525, 1118 ZN Schiphol, The Netherlands

YAESU UK LTD.

Unit 12, Sun Valley Business Park, Winnall Close
Winchester, Hampshire, SO23 0LB, U.K.

VERTEX STANDARD HK LTD.

Unit 5, 20/F., Seaview Centre, 139-141 Hoi Bun Road,
Kwun Tong, Kowloon, Hong Kong

VERTEX STANDARD (AUSTRALIA) PTY., LTD.

Normanby Business Park, Unit 14/45 Normanby Road
Notting Hill 3168, Victoria, Australia

ABOUT THIS MANUAL . . .

The **FT-2000** is a leading-edge transceiver with a number of new and exciting features, some of which may be unfamiliar to you. In order to gain the most enjoyment and operating efficiency from your **FT-2000**, we recommend that you read this manual in its entirety, and keep it handy for reference as you explore the many capabilities of your new transceiver.

Before using your **FT-2000**, be sure to read and follow the instructions in the “Before You Begin” section of this manual.

GENERAL DESCRIPTION

Congratulations on the purchase of your Yaesu amateur transceiver! Whether this is your first rig, or if Yaesu equipment is already the backbone of your station, rest assured that your transceiver will provide many hours of operating pleasure for years to come.

The **FT-2000** is an elite-class HF transceiver providing exceptional performance both on transmit and receive. The **FT-2000** is designed for the most competitive operating situations, whether you primarily operate in contest, DX, or digital-mode environments.

Built on the foundation of the popular **FTdx9000** transceiver, and carrying the proud tradition of the **FT-1000** series, the **FT-2000** provides up to 100 Watts of power output on SSB, CW, and FM (50 Watts AM carrier). Digital Signal Processing (DSP) is utilized throughout the design, providing leading-edge performance on both transmit and receive.

Available as an option for the **FT-2000** is the Data Management Unit (**DMU-2000**), which provides extensive display capabilities via a user-supplied computer monitor. Included are Band Scope, Audio Scope, X-Y Oscilloscope, World Clock, Rotator Control, and extensive transceiver status displays, in addition to station logging capability.

For exceptional protection from strong nearby incoming signals, the Yaesu-exclusive VRF (Variable RF Front-End Filter) serves as a high-performance Preselector-ideal for multi-operator contest environments. This filter is manually tuned, allowing the operator to optimize sensitivity or signal rejection with the twist of a knob. And for then ultimate in receiver RF selectivity, the optional RF μ Tuning Kits may be connected via the rear panel, providing extraordinarily sharp selectivity to protect your receiver from close-in interference on a crowded band.

In addition to the contribution of the VRF Preselector, superb receiver performance is a result of direct lineage from the legendary **FTdx9000**, **FT-1000D**, and **FT-1000MP**. You may select, in the front end, one of two RF preamplifiers, or IPO (Intercept Point Optimization) utilizing direct feed to the first mixer, and/or three levels of RF attenuation in 6-dB steps.

Dual Receive is built into every **FT-2000**. The Main receiver utilizes DSP filtering, incorporating many of the features of the **FTdx9000**, such as Variable Bandwidth, IF Shift, and Passband Contour tuning. Digital Noise Reduction and Digital Auto-Notch Filtering are also provided, along with a manually-tuned IF Notch filter. The Sub receiver, used for monitoring within the same band as the Main band, is an analog type ideal for watching both sides of a pile-up, or keeping an ear on a DX station working stations by call area, etc.

On the transmit side, the Yaesu-exclusive Three-Band Parametric Microphone Equalizer allows precise and flexible adjustment of the wave-form created by your voice and microphone. The Amplitude, Center Frequency, and Bandwidth of equalization may be adjusted independently for the low-frequency, mid-range, and high-audio-frequency spectra, and the transmitted bandwidth may also be adjusted, as well.

Advanced features include Direct Keyboard Frequency En-

try and Band Change, Speech Processor, IF Monitor for Voice modes, CW Pitch control, CW Spot switch, Full CW QSK, adjustable IF Noise Blanker, and all-mode Squelch. Two TX/RX antenna ports, plus a receive-only antenna port, are provided on the rear panel. Two key jacks are provided (one each on the front and rear panels), and they may be configured independently for paddle input or connection to a straight key or computer-driven keying interface. Both Digital Voice Recording and CW Message Memory are provided.

Frequency setup is extraordinarily simple on the **FT-2000**. Besides direct frequency entry for both the Main and Sub VFOs, separate keys are provided for band selection, and each band key accesses three independent VFO frequency/mode/filter settings per band, so you can establish separate VFO settings for three different parts of each band. The two (Main and Sub) VFOs allow simultaneous reception and display of two different frequencies, even in different modes and with different IF bandwidths. Receiver audio can be completely or partially mixed, or monitored separately in each ear.

In addition, 99 memories are provided, each of which stores its own mode and IF filter selection, in addition to frequency, Clarifier offset, and scan-skip status. What's more, five quick-recall ("QMB") memories can instantly store operational settings at the push of a button.

The built-in automatic antenna tuner includes 100 memories of its own, automatically storing antenna matching settings for quick automatic recall later.

Interfacing for digital modes is extremely simple with the **FT-2000**, thanks to dedicated AFSK and FSK connection jacks on the rear panel. Optimization of the filter passbands, DSP settings, carrier insertion point, and display offset are all possible via the Menu programming system.

The Yaesu CAT system provides a direct link to the transceiver CPU for computer control and customization of tuning, scanning, and other operating functions. The **FT-2000** includes a built-in data level converter for direction connection to a personal computer serial port. Yaesu products are supported by most all of the leading contest and DX logging programs, and the extensive programming protocol is described in the CAT System Manual, supplied with this transceiver, if you wish to write your own software!

Advanced technology is only part of the **FT-2000** story. Vertex Standard stands behind our products with a worldwide network of dealers and service centers. We greatly appreciate your investment in the **FT-2000**, and we look forward to helping you get the most out of your new transceiver. Please feel free to contact your nearest dealer, or one of Vertex Standard's national headquarters offices, for technical advice, interfacing assistance, or accessory recommendation. And watch Vertex Standard U.S.A.'s Home Page for late-breaking information about Vertex, Standard Horizon, and Yaesu products: <http://www.vertexstandard.com>.

Please read this manual thoroughly, so as to gain maximum understanding of the full capability of the **FT-2000**, and we thank you again for your purchase!

TABLE OF CONTENTS

General Description	1	Advanced Interference-Suppression Features:	
Accessories & Options	4	RF Front End	53
Supplied Accessories	4	Using the VRF (Variable RF Front-end Filter)	53
Available Options	4	Interference Rejection	
Before You Begin	5	(Signals Off Frequency by Just a Few kHz)	54
Connecting AC Power	5	R.FLT (Roofing Filters)	54
AC Input Voltage Selection	5	Interference Rejection (Signals within 3 kHz)	55
Extending the Front Feet	6	CONTOUR Control Operation	55
Adjusting the Main Tuning Dial Torque	6	IF SHIFT Operation	56
Resetting the Microprocessor	7	WIDTH (IF DSP Bandwidth) Tuning	57
Resetting Memories (Only)	7	Using IF Shift and Width Together	57
Menu Resetting	7	IF Notch Filter Operation	58
Full Reset	7	Digital Noise Reduction (DNR) Operation	59
Installation and Interconnections	8	Digital Notch Filter (DNF) Operation	59
Antenna Considerations	8	NARROW (NAR) One-Touch IF Filter Selection	60
About Coaxial Cable	8	IF Noise Blanker (NB) Operation	61
Grounding	9	Tools for Comfortable and Effective Reception	62
Connection of Antenna and Power Cables	10	AGC (Automatic Gain Control)	62
Connection of Microphone and Headphone	11	SLOPED AGC Operation	63
Key, Keyer, and Computer-Driven Keying		Mute Feature (Main (VFO-A) Band)	63
Interconnections	12	SSB/AM Mode Transmission	64
VL-1000 Linear Amplifier Interconnections	13	Using the Automatic Antenna Tuner	66
Interfacing to Other Linear Amplifiers	14	ATU Operation	66
Plug/Connector Pinout Diagrams	15	About ATU Operation	67
Front Panel Controls & Switches	16	Lithium Battery Replacement	68
Display Indications	28	Enhancing Transmit Signal Quality	69
Rear Panel	32	Using the Speech Processor	69
Basic Operation: Receiving on Amateur Bands	35	Adjusting the SSB Transmitted Bandwidth	70
Operation on 60-Meter (5 MHz) Band		Parametric Microphone Equalizer	71
(U.S. version only)	38	Transmitter Convenience Features	72
CLAR (Clarifier) Operation on Main (VFO-A)	39	Voice Memory	72
LOCK	40	Voice Memory Operation from	
DIM	40	the optional FH-2 Remote Control Keypad	73
Convenience Features	42	VOX (Automatic TX/RX Switching using Voice Control)	74
Dual Receive	42	MONITOR	74
Using Headphones for Dual Receive	43	Split Operation Using the TX Clarifier	75
Sideband Diversity Reception	43	Split-Frequency Operation	76
Bandwidth Diversity Reception	44	VFO Tracking Feature	76
P.BACK (Audio Playback) from		Quick Split Operation	77
Main (VFO-A) Receiver	45	CW Mode Operation	78
P.BACK feature from		Setup for Straight Key	
the optional FH-2 Remote Control Keypad	45	(and Straight Key emulation) Operation	78
“MY Bands” Operation	46	Using the Built-in Electronic Keyer	79
Band Stack Operation	47	Full Break-in (QSK) Operation	79
C.S (Custom Switch)	47	Setting the Keyer Weight	
Rotator Control Functions	48	(Dot/Space:Dash) Ratio	80
More Frequency Navigation Techniques	49	Selecting the Keyer Operating Mode	80
Keyboard Frequency Entry	49		
Using the [SUB VFO-B] knob	49		
Using the UP/DOWN switches of			
the supplied MH-31B8 Hand Microphone	49		
Receiver Operation (Front End Block Diagram)	50		
IPO (Intercept Point Optimization)	51		
ATT	51		
RF Gain (SSB/CW/AM Modes)	52		

TABLE OF CONTENTS

CW Convenience Features	81	VFO and Memory Scanning	101
CW Spotting (Zero-Beating)	81	VFO Scanning	101
Using CW Reverse	82	Memory Scan	102
CW Delay Time Setting	83	PMS	103
CW Pitch Adjustment	83	Packet Operation	104
Contest Memory Keyer	84	Packet Setup (Including Subcarrier Frequency) ..	104
Message Memory	84	Basic Setup	104
Transmitting in the Beacon Mode	85	RTTY (Radio Teletype) Operation	105
TEXT Memory	86	Setting Up for RTTY Operation	105
Contest Number Programming	87	Basic Setup	105
Decrementing the Contest Number	87	Miscellaneous AFSK-Based Data Modes	106
Contest Memory Keyer		About the Transverter Output Terminal	107
(Using the optional FH-2 Remote Control Keypad)	88	Menu Mode	108
Message Memory	88	Using the Menu	108
TEXT Memory	90	Menu Mode Reset	108
FM Mode Operation	92	AGC Group	112
Basic Operation	92	DISPLAY Group	112
Repeater Operation	93	DVS Group	113
Memory Operation	94	KEYER Group	113
Convenient Memory functions	94	GENERAL Group	114
QMB (Quick Memory Bank)	95	S IF SFT Group	116
Standard Memory Operation	96	MODE-AM Group	116
Memory Storage	96	MODE-CW Group	117
Memory Channel Recall	96	MODE-DAT Group	118
Checking a Memory Channel's Status	97	MODE-FM Group	119
Erasing Memory Channel Data	97	MODE-RTY Group	119
Moving Memory Data to		MODE-SSB Group	120
the Main Band (VFO-A)	98	RX AUDIO Group	120
Memory Tune Operation	98	RX DSP Group	121
Memory Groups	99	SCOPE Group	122
Memory Group Assignment	99	TUNING Group	123
Choosing the Desired Memory Group	99	TX AUDIO Group	124
Operation on Alaska Emergency Frequency:		TX GNRL Group	125
5167.5 kHz (U.S. Version Only)	100	Specifications	126
		Installation of the Optional Filter	
		(YF-122C & YF-122CN)	128

ACCESSORIES & OPTIONS

SUPPLIED ACCESSORIES

Hand Microphone (MH-31B8)	1 pc	A07890001
AC Power Cord	1 pc	T9017882: USA T9013285: Europe T9013283A: Australia
Spare Fuse (10 A)	1 pc	Q0000099
4-pin DIN Plug	1 pc	P0091004
5-pin DIN Plug	1 pc	P0091006
1/4-inch 3-contact Plug	1 pcs	P0090008
3.5 mm 3-contact Plug	1 pcs	P0091046
3.5 mm 2-contact Plug	1 pcs	P0090034
RCA Plug	2 pcs	P0091365
Operating Manual	1 pc	
CAT Reference Book	1 pc	
Warranty Card	1 pc	

AVAILABLE OPTIONS

MD-200A8X	Ultra-High-Fidelity Desk-Top Microphone
MD-100A8X	Desk-Top Microphone
YH-77STA	Lightweight Stereo Headphone
SP-2000	External Speaker with Audio Filter
VL-1000/VP-1000	Linear Amplifier/AC Power Supply
DMU-2000	Data Management Unit
RF μTuning Kit A	For 160 m Band
RF μTuning Kit B	For 80/40 m Bands
RF μTuning Kit C	For 30/20 m Bands
FH-2	Remote Control Keypad
YF-122C	Collins® CW Filter (500 Hz/2 kHz: -6 dB/-60 dB)
YF-122CN	Collins® CW Filter (300 Hz/1 kHz: -6 dB/-60 dB)

CONNECTING AC POWER

Before connecting the AC power, check the label on the rear panel which indicates the AC mains voltage for which your transceiver is currently set. If the voltage on this label does not match your AC mains voltage, a switch on the internal power supply in the transceiver must be moved. This requires only a screwdriver and is not difficult (see below), but you should make sure the power supply is set up correctly before connecting power. Always use a 10-Amp fuse in the fuse holder, whether operating on 100 - 120 VAC or 200 - 240 VAC. Do not use an improper fuse. If you have any doubts about the procedure, contact your dealer for assistance.

After making certain the AC voltage for which the transceiver is set matches your mains voltage, connect the AC power cord to the 3-pin AC jack on the rear panel. Wait until all other transceiver interconnections have been made before connecting the other end of the power cord to the wall outlet.



CAUTION

Permanent damage will result if improper AC supply voltage is applied to the transceiver. Your warranty does not cover damage caused by application of improper supply voltage, or use of an improper fuse.

AC Input Voltage Selection

- Make certain that all cables are disconnected from the transceiver.
- Remove the three screws from each side of the transceiver, and three screws from the top edge of the rear panel. Slide the top cover toward the rear about 1/2 inch (1 cm), then remove the top cover.
- Locate the voltage selector switch on the power supply unit at the left side of the transceiver (just behind the Main [POWER] switch).
- Move the AC range switch to the “115” position for operation from 100 - 120 VAC, or to the “230” position for operation from 200 - 240 VAC.
- Replace the top cover and its nine screws.
- Always use the 10-Amp fuse in the fuse holder, whether operating on 100 - 120 VAC or 200 - 240 VAC.
- Change the voltage marking on the label on the rear panel to match the new voltage setting.

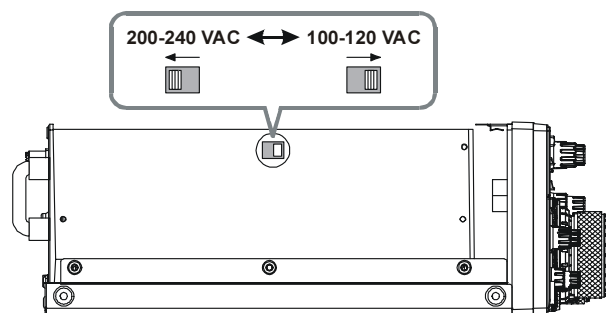
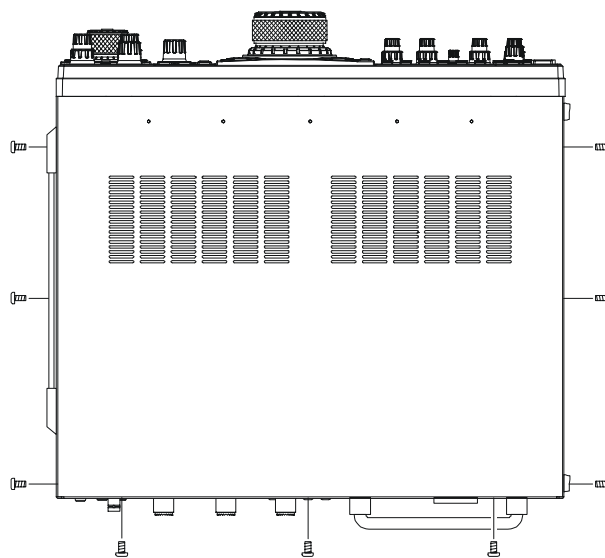

BEFORE YOU BEGIN

EXTENDING THE FRONT FEET

In order to elevate the front panel for easy viewing, the front left and right feet of the bottom case may be extended.

- Pull the front legs outward from the bottom panel.
- Rotate the legs counter-clockwise to lock them in the extended position. Be sure the legs have locked securely in place, because the transceiver is quite heavy and an unlocked leg could result in damage, should the transceiver move suddenly.

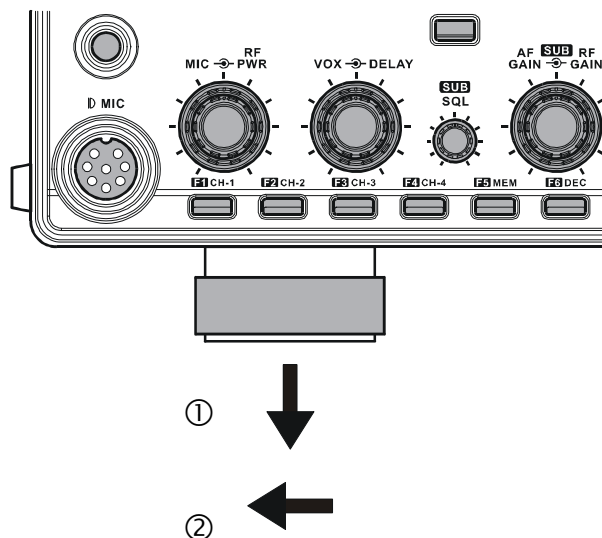

Retracting the Front Feet

- Rotate the legs clockwise, and push them inward while rotating to the right.
- The front feet should now be locked in the retracted position.

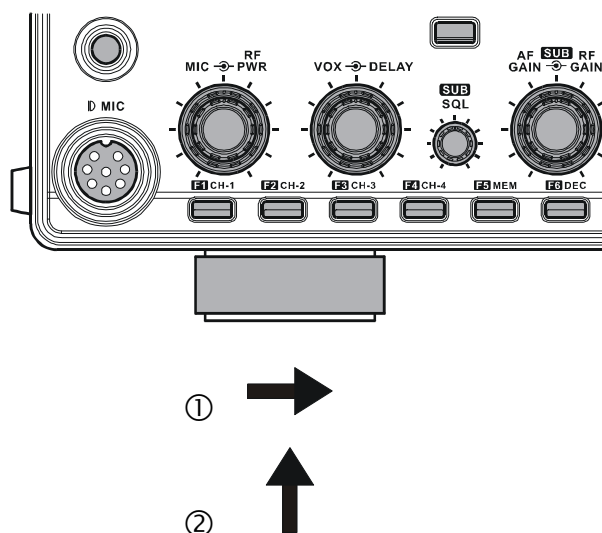

ADJUSTING THE MAIN TUNING DIAL TORQUE

The torque (drag) of the Main Tuning Dial knob may be adjusted according to your preferences. Simply hold down the rear skirt of the knob, and while holding it in place rotate the knob itself to the right to reduce the drag or to the left to increase the drag. Available adjustment range is 120°.

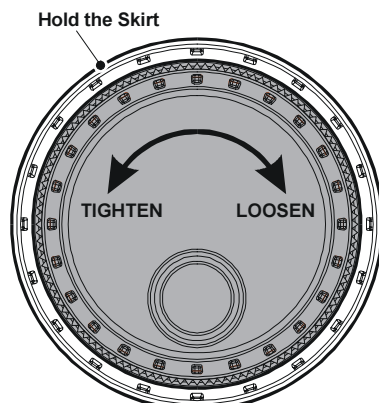

RESETTING THE MICROPROCESSOR

RESETTING MEMORIES (ONLY)

Use this procedure to reset (clear out) the Memory channels previously stored, without affecting any configuration changes you may have made to the Menu settings.

1. Press the front panel's **[POWER]** switch to turn the transceiver off.
2. Press and hold in the **[A▶M]** button; while holding it in, press and hold in the front panel's **[POWER]** switch to turn the transceiver on. Once the transceiver comes on, you may release the **[A▶M]** button.

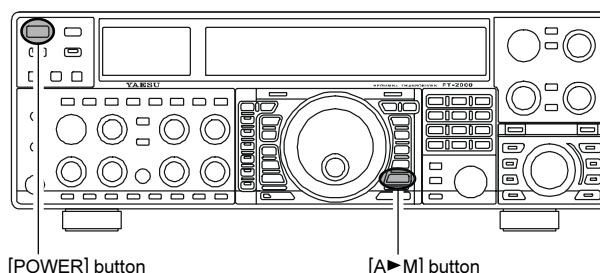

MENU RESETTING

Use this procedure to restore the Menu settings to their factory defaults, without affecting the memories you have programmed.

1. Press the front panel's **[POWER]** switch to turn the transceiver off.
2. Press and hold in the **[MENU]** button; while holding it in, press and hold in the front panel's **[POWER]** switch to turn the transceiver on. Once the transceiver comes on, you may release the **[MENU]** button.

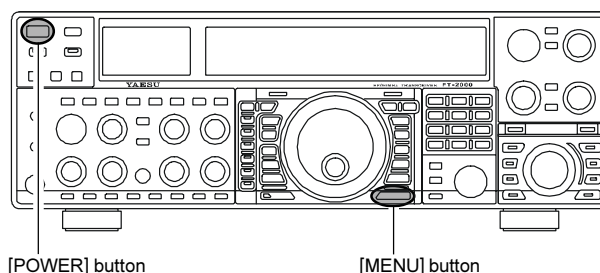

FULL RESET

Use this procedure to restore all Menu and Memory settings to their original factory defaults. All Memories will be cleared out by this procedure.

1. Press the front panel's **[POWER]** switch to turn the transceiver off.
2. Press and hold in the **[FAST]** and **[LOCK]** buttons; while holding them in, press and hold in the front panel's **[POWER]** switch to turn the transceiver on. Once the transceiver comes on, you may release the other two switches.

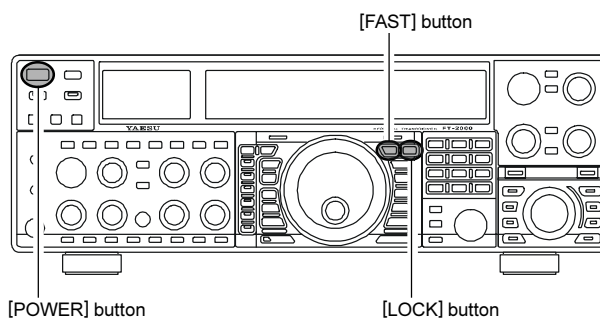

INSTALLATION AND INTERCONNECTIONS

ANTENNA CONSIDERATIONS

The **FT-2000** is designed for use with any antenna system providing a 50 Ohm resistive impedance at the desired operating frequency. While minor excursions from the 50-Ohm specification are of no consequence, the transceiver's Automatic Antenna Tuner may not be able to reduce the impedance mismatch to an acceptable value if the Standing Wave Ratio (SWR) present at the Antenna jack is greater than 3:1.

Every effort should, therefore, be made to ensure that the impedance of the antenna system utilized with the **FT-2000** be as close as possible to the specified 50-Ohm value.

Note that the "G5RV" type antenna does not provide a 50-Ohm impedance on all HF Amateur bands, and an external wide-range antenna coupler must be used with this antenna type.

Any antenna to be used with the **FT-2000** must, ultimately, be fed with 50 Ohm coaxial cable. Therefore, when using a "balanced" antenna such as a dipole, remember that a balun or other matching/balancing device must be used so as to ensure proper antenna performance.

The same precautions apply to any additional (receive-only) antennas connected to the RX ANT jack; if your receive-only antennas do not have an impedance near 50 Ohms at the operating frequency, you may need to install an external antenna tuner to obtain optimum performance.

ABOUT COAXIAL CABLE

Use high-quality 50-Ohm coaxial cable for the lead-in to your **FT-2000** transceiver. All efforts at providing an efficient antenna system will be wasted if poor quality, lossy coaxial cable is used. This transceiver utilizes standard "M" ("PL-259") type connectors, except for the "RX OUT" BNC connector.

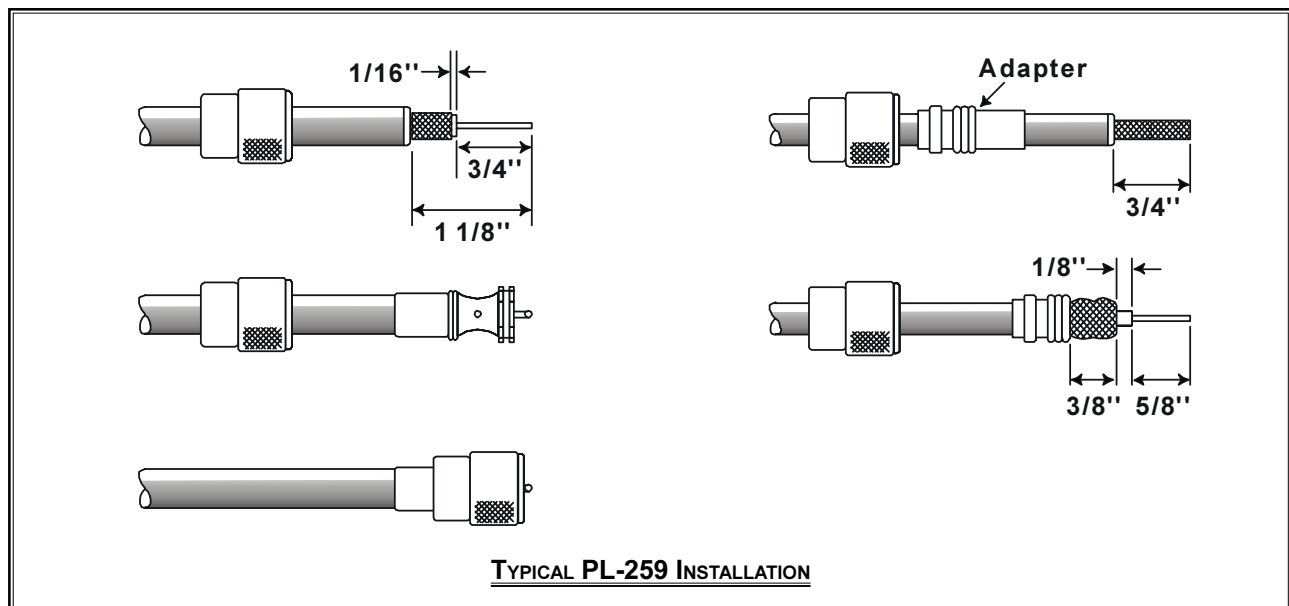

INSTALLATION AND INTERCONNECTIONS

GROUNDING

The **FT-2000** transceiver, like any other HF communications apparatus, requires an effective ground system for maximum electrical safety and best communications effectiveness. A good ground system can contribute to station efficiency in a number of ways:

- ❑ It can minimize the possibility of electrical shock to the operator.
- ❑ It can minimize RF currents flowing on the shield of the coaxial cable and the chassis of the transceiver; such currents may lead to radiation which can cause interference to home entertainment devices or laboratory test equipment.
- ❑ It can minimize the possibility of erratic transceiver/accessory operation caused by RF feedback and/or improper current flow through logic devices.

An effective earth ground system may take several forms; for a more complete discussion, see an appropriate RF engineering text. The information below is intended only as a guideline.

Typically, the ground connection consists of one or more copper-clad steel rods, driven into the ground. If multiple ground rods are used, they should be positioned in a “V” configuration, and bonded together at the apex of the “V” which is nearest the station location. Use a heavy, braided cable (such as the discarded shield from type RG-213 coaxial cable) and strong cable clamps to secure the braided cable(s) to the ground rods. Be sure to weatherproof the connections to ensure many years of reliable service. Use the same type of heavy, braided cable for the connections to the station ground bus (described below).

Inside the station, a common ground bus consisting of a copper pipe of at least 25 mm (1”) diameter should be used. An alternative station ground bus may consist of a wide copper plate (single-sided circuit board material is ideal) secured to the bottom of the operating desk. Grounding connections from individual devices such as transceivers, power supplies, and data communications devices (TNCs, etc.) should be made directly to the ground bus using a heavy, braided cable.

Do not make ground connections from one electrical device to another, and thence to the ground bus. This so-called “Daisy-Chain” grounding technique may nullify any attempt at effective radio frequency grounding. See the drawing below for examples of proper grounding techniques.

Inspect the ground system - inside the station as well as outside - on a regular basis so as to ensure maximum performance and safety.

Besides following the above guidelines carefully, note that household or industrial gas lines must never be used in an attempt to establish an electrical ground. Cold water pipes may, in some instances, help in the grounding effort, but gas lines represent a significant explosion hazard, and must never be used.

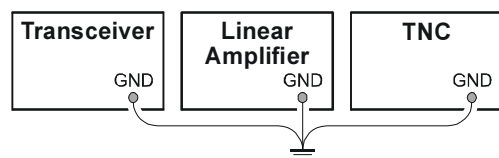

PROPER GROUND CONNECTION

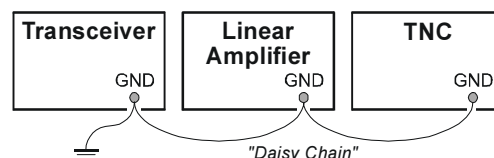

IMPROPER GROUND CONNECTION

INSTALLATION AND INTERCONNECTIONS

CONNECTION OF ANTENNA AND POWER CABLES

Please follow the outline in the illustration regarding the proper connection of antenna coaxial cables, as well as the AC power cable.

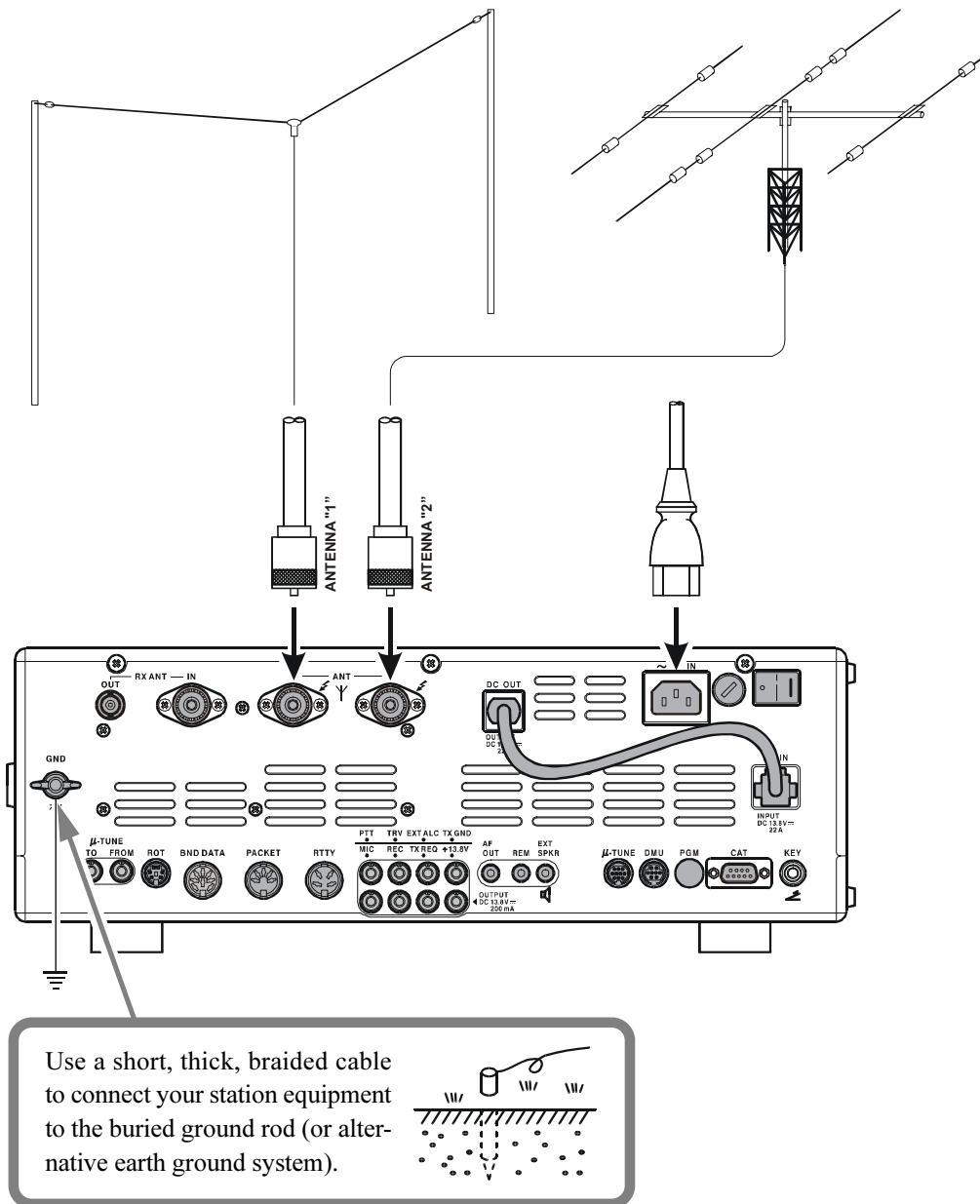

ADVICE:

- Do not position this apparatus in a location with direct exposure to sunshine.
- Do not position this apparatus in a location exposed to dust and/or high humidity.
- Ensure adequate ventilation around this apparatus, so as to prevent heat build-up and possible reduction of performance due to high heat.
- Do not install this apparatus in a mechanically-unstable location, or where objects may fall onto this product from above.
- To minimize the possibility of interference to home entertainment devices, take all precautionary steps including separation of TV/FM antennas from Amateur transmitting antennas to the greatest extent possible, and keep transmitting coaxial cables separated from cables connected to home entertainment devices.
- Ensure that the AC power cord is not subject to undue stress or bending, which could damage the cable or cause it to be accidentally unplugged from the rear panel AC input jack.
- Be absolutely certain to install your transmitting antenna(s) such that they cannot possibly come in contact with TV/FM radio or other antennas, nor with outside power or telephone lines.

INSTALLATION AND INTERCONNECTIONS

CONNECTION OF MICROPHONE AND HEADPHONE

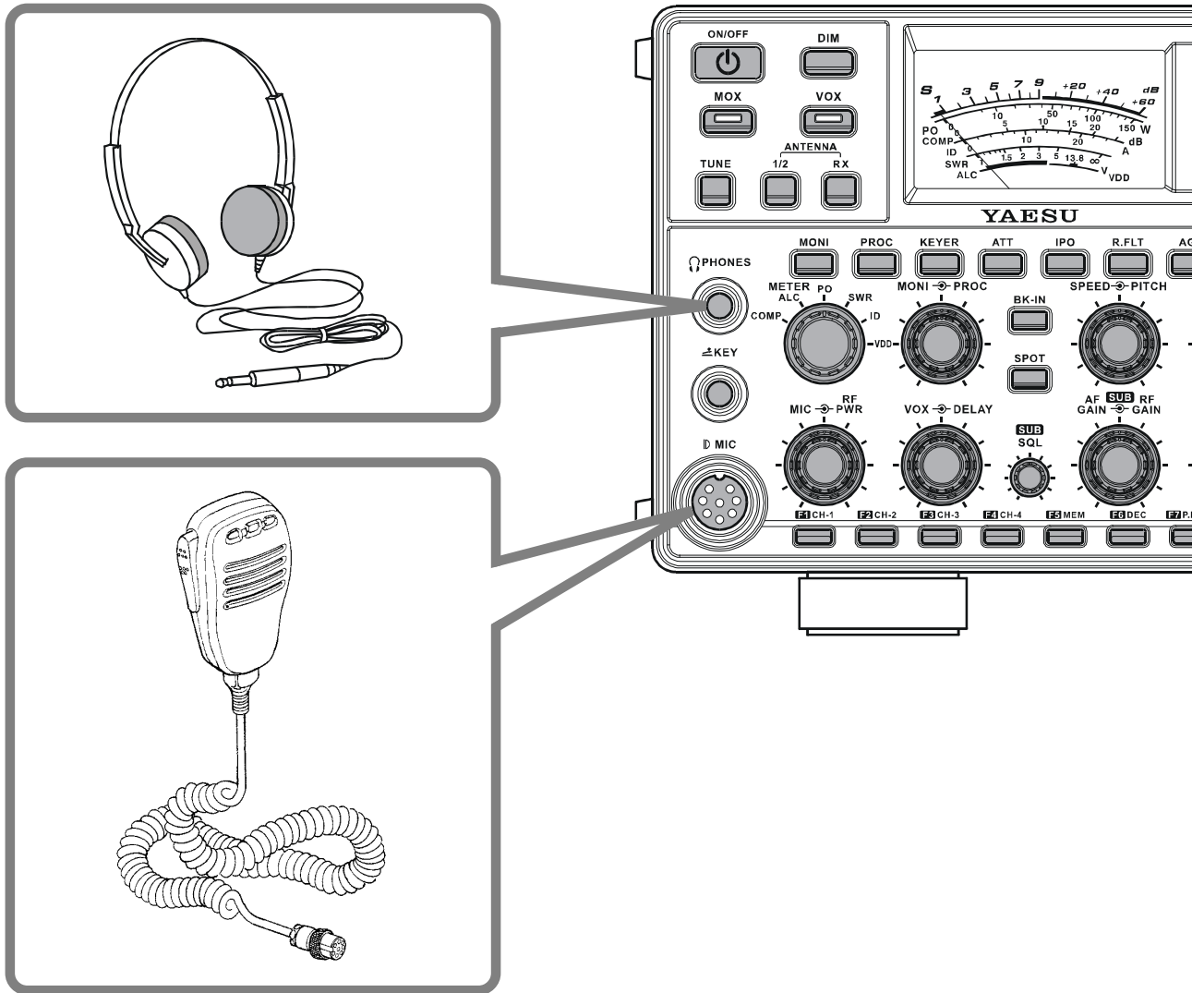

INSTALLATION AND INTERCONNECTIONS

KEY, KEYSER, AND COMPUTER-DRIVEN KEYING INTERCONNECTIONS

The **FT-2000** includes a host of features for the CW operator, the functions of which will be detailed in the “Operation” section later. Besides the built-in Electronic Keyer, two key jacks are provided, one each on the front and rear panels, for convenient connection to keying devices.

The Menu system allows you to configure the front and rear panel **KEY** jacks according to the device you wish to connect. For example, you may connect your keyer paddle to the front panel **KEY** jack, and use Menu item “052 A1A F-TYPE” for paddle input, while connecting the rear panel’s **KEY** jack to the keying line from your personal computer (which emulates a “straight key” for connection purposes), and configure the rear panel jack using Menu item “054 A1A R-TYPE.”

Both **KEY** jacks on the **FT-2000** utilize “Positive” keying voltage. Key-up voltage is approximately +5V DC, and key-down current is approximately 1 mA. When connecting a key or other device to the **KEY** jacks, use *only* a 3-pin (“stereo”) 1/4” phone plug; a 2-pin plug will place a short between the ring and (grounded) shaft of the plug, resulting in a constant “key-down” condition in some circumstances.

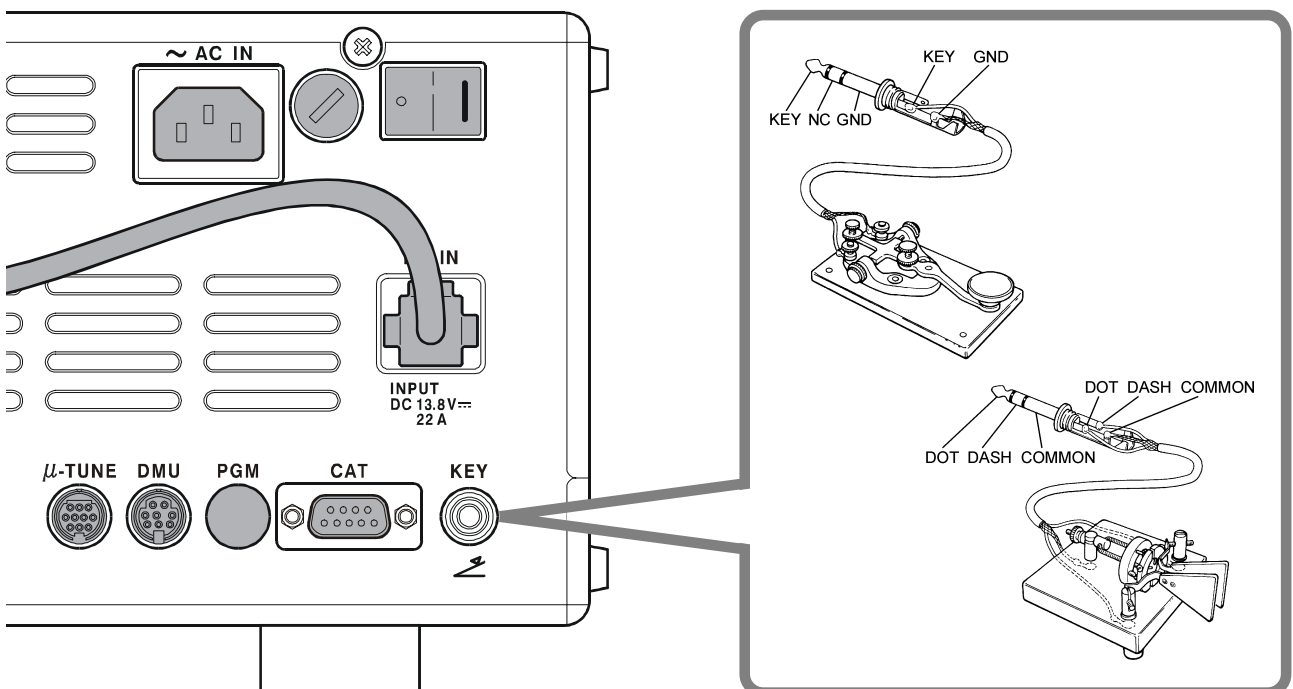
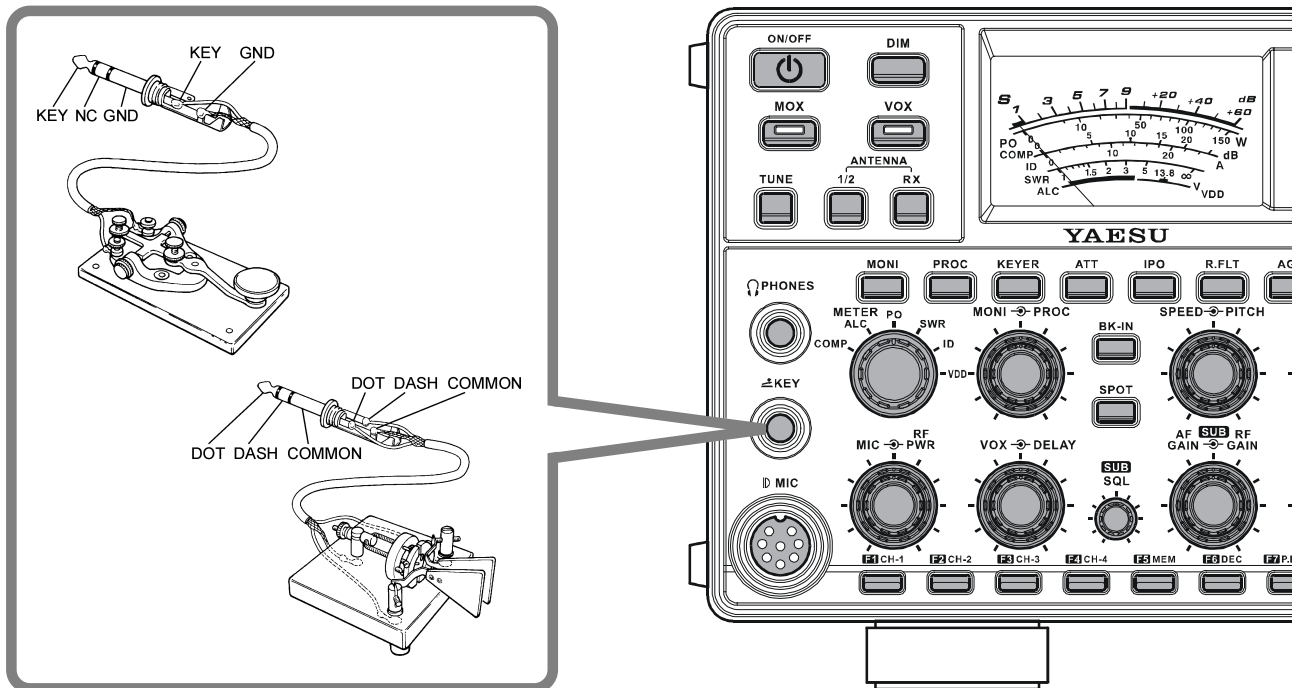

INSTALLATION AND INTERCONNECTIONS

VL-1000 LINEAR AMPLIFIER INTERCONNECTIONS

Be sure that both the **FT-2000** and **VL-1000** are turned off, then follow the installation recommendations contained in the illustration.

NOTE:

- ❑ Please refer to the **VL-1000** Operating Manual for details regarding amplifier operation.
- ❑ Please do not attempt to connect or disconnect coaxial cables when your hands are wet.

About the CONTROL Cable

The VL-1000 may be operated with the FT-2000 whether or not the CONTROL Cable is connected; however, the CONTROL Cable allows you to tune up the amplifier automatically by just pressing the [F SET] or [TUNE] key on the VL-1000, so as to transmit a carrier for tuning purposes.

To link the FT-2000 and VL-1000 Power switches, set the VL-1000 REMOTE switch to the "ON" position.

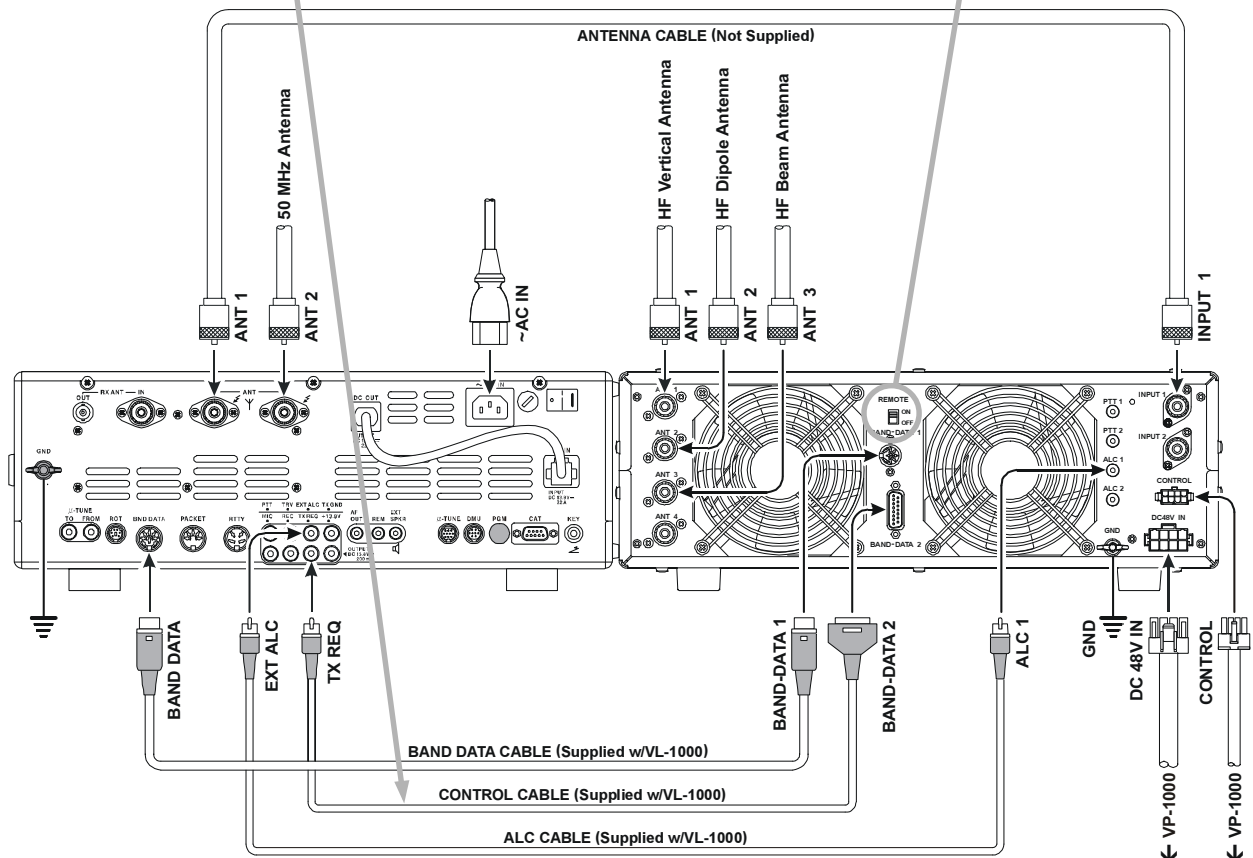

INSTALLATION AND INTERCONNECTIONS



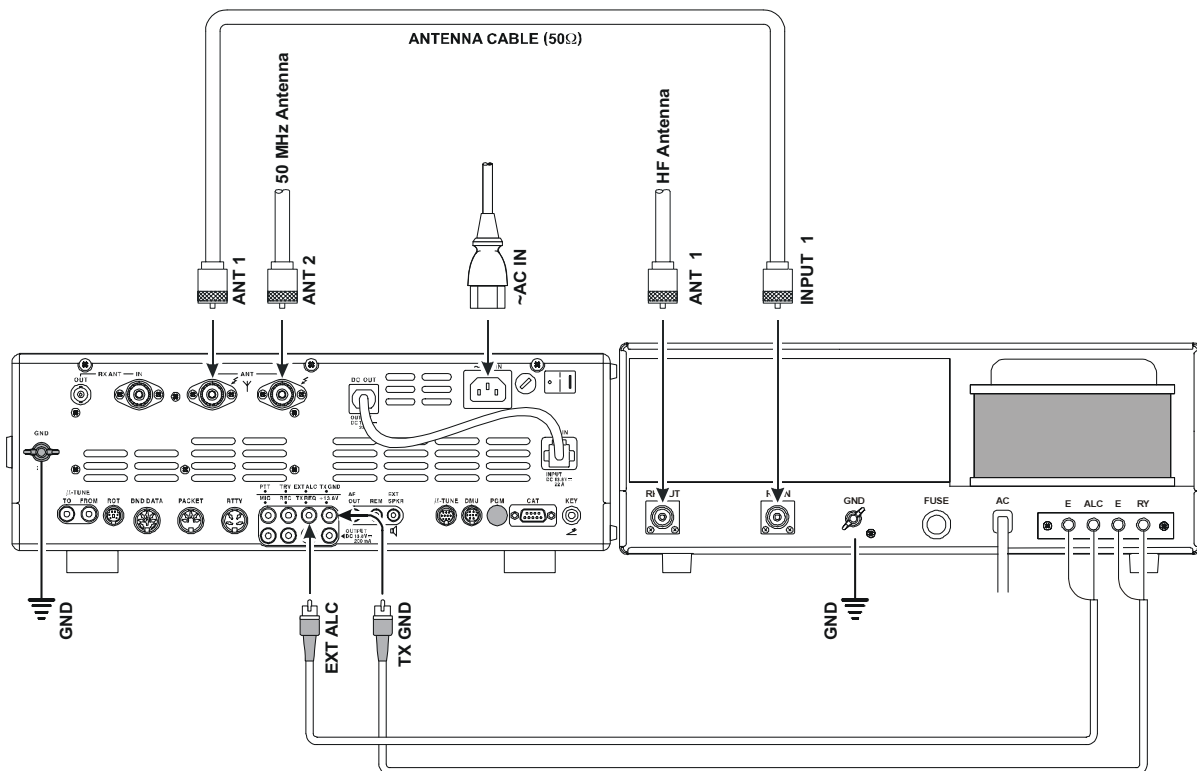

INTERFACING TO OTHER LINEAR AMPLIFIERS

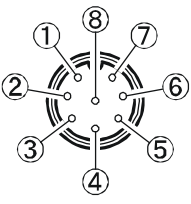
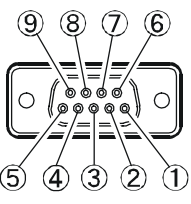
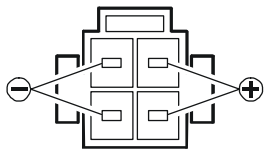
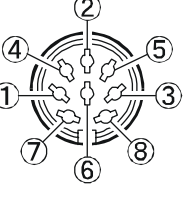
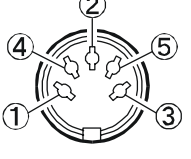

NOTE

- ❑ The TX/RX switching in the linear amplifier is controlled by switching components in the transceiver. The relay circuit of the **FT-2000** used for this switching is capable of switching AC voltage of 100 Volts at up to 300 mA, or DC voltages of 60 V at 200 mA or 30 V at up to 1 Amp. In order to engage the switching relay, use Menu item “144 tGEn ETX-GND;” set this Menu item to “EnA (Enable)” to activate the amplifier switching relay.
- ❑ The specified range for ALC voltage to be used with the **FT-2000** is 0 to -4 Volts DC.
- ❑ Amplifier systems utilizing different ALC voltages will not work correctly with the **FT-2000**, and their ALC lines must not be connected if this is the case.

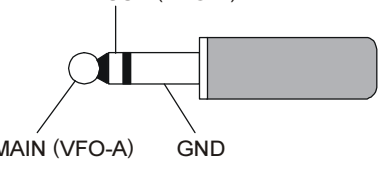
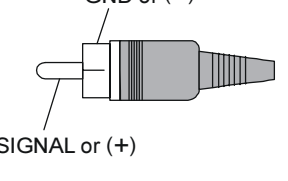
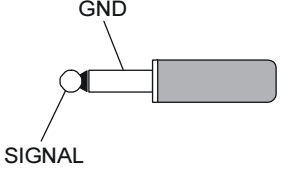
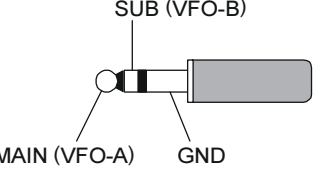
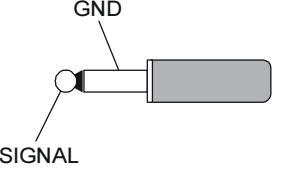
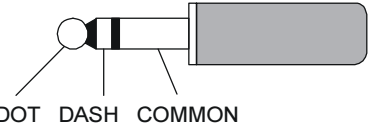
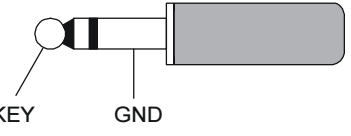
PLUG/CONNECTOR PINOUT DIAGRAMS

MIC	CAT	DC IN
 <ul style="list-style-type: none"> ① UP ② +5V ③ DOWN ④ FAST ⑤ GND ⑥ PTT ⑦ MIC GND ⑧ MIC <p>(as viewed from front panel)</p>	 <ul style="list-style-type: none"> ① N/A ② SERIAL OUT ③ SERIAL IN ④ N/A ⑤ GND ⑥ N/A ⑦ RTS ⑧ CTS ⑨ NC <p>(as viewed from rear panel)</p>	 <p>(as viewed from rear panel)</p>
BAND DATA	PACKET	RTTY
 <ul style="list-style-type: none"> ① +13V ② TX GND ③ GND ④ BAND DATA A ⑤ BAND DATA B ⑥ BAND DATA C ⑦ BAND DATA D ⑧ LINEAR <p>(as viewed from rear panel)</p>	 <ul style="list-style-type: none"> ① DATA IN ② GND ③ PACKET PTT ④ DATA OUT ⑤ BUSY <p>(as viewed from rear panel)</p>	 <ul style="list-style-type: none"> ① SHIFT ② RX OUT ③ PTT ④ GND <p>(as viewed from rear panel)</p>
ROT (ROTATOR)	PHONE	RCA PLUG
 <ul style="list-style-type: none"> ① CW ROTATION ② CCW ROTATION ③ SPEED ④ DIRECTION ⑤ GND ⑥ NC <p>(as viewed from rear panel)</p>	 <p>SUB (VFO-B) MAIN (VFO-A) GND</p>	 <p>GND or (-) SIGNAL or (+)</p>
REM (REMOTE)	AF OUT	EXT SPKR
 <p>GND SIGNAL</p>	 <p>SUB (VFO-B) MAIN (VFO-A) GND</p>	 <p>GND SIGNAL</p>
KEY		
<p>For Internal Keyer</p>  <p>DOT DASH COMMON</p>		<p>For Straight Key</p>  <p>KEY GND</p>
 <p>Do not use 2-conductor type plug</p>		

IMPORTANT NOTE:

The μ -TUNE, DMU, and PGM connectors are special connectors for this transceiver. Please do not connect any accessory or other device not specifically approved by Vertex Standard. Failure to observe this precaution may cause damage not covered by the Limited Warranty on this apparatus.

FRONT PANEL CONTROLS & SWITCHES

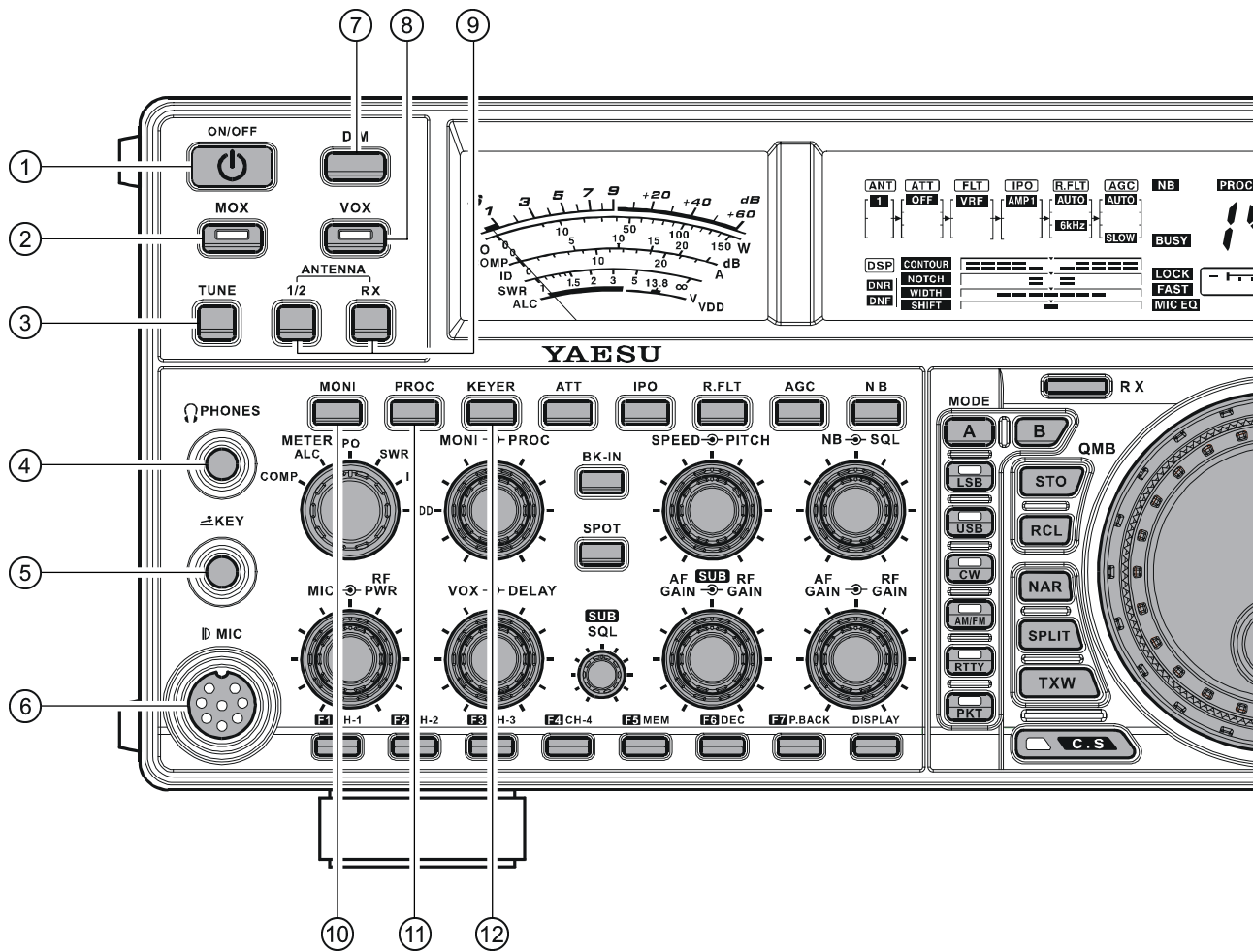

① POWER Switch

Press and hold in this switch for one second to turn the transceiver on, after first setting the rear panel [POWER] switch to the “I” position. Press and hold in this switch for one second, similarly, to turn the transceiver off.

ADVICE:

- ❑ This is the actual power On/Off switch for turning on the transceiver. If the rear panel’s [POWER] switch is set to the “O” position, the front panel [POWER] switch will not function.
- ❑ If you press this switch momentarily while the transceiver is turned on, the transceiver’s audio will be muted for three seconds.

② MOX Switch

Pressing this button engages the PTT (Push to Talk) circuit, to activate the transmitter (the LED inside this button will glow red). It must be turned off (the red LED will be off) for reception. This button replicates the action of the Push to Talk (PTT) switch on the microphone. When engaging the [MOX] button (the LED inside this button glows red) or otherwise causing a transmission to be started, be certain you have either an antenna or 50-Ohm dummy load connected to the selected Antenna jack.

③ TUNE Switch

This is the on/off switch for the FT-2000’s Automatic Antenna Tuner.

Pressing this button momentarily places the antenna tuner in line between the transmitter final amplifier and the antenna jack (“TUNER” icon will appear in the display). Reception is not affected.

Pressing and holding in this button for 1/2 second, while receiving in an amateur band, activates the transmitter for a few seconds while the automatic antenna tuner rematches the antenna system impedance for minimum SWR. The resulting setting is automatically stored in one of the antenna tuner’s 100 memories, for instant automatic recall later when the receiver is tuned near the same frequency.

Pressing this button momentarily, while the Tuner is engaged, will take the Automatic Antenna tuner out of the transmit line.

NOTE:

When the Automatic Antenna Tuner is tuning itself, a signal is being transmitted. Therefore, be absolutely certain that an antenna or dummy load is connected to the selected antenna jack before pressing and holding in the [TUNE] button to start antenna tuning.

FRONT PANEL CONTROLS & SWITCHES

④ PHONES Jack

A 1/4-inch, 3-contact jack accepts either monaural or stereo headphones with 2- or 3-contact plugs. When a plug is inserted, the loudspeaker is disabled. With stereo headphones such as the optional **YH-77STA**, you can monitor both Main (VFO-A) and Sub (VFO-B) receiver channels at the same time during Dual Receive operation.

NOTE:

When wearing headphones, we recommend that you turn the AF Gain levels down to their lowest settings before turning power on, to minimize the impact on your hearing caused by audio “pops” during switch-on.

⑤ KEY Jack

This 1/4-inch, 3-contact jack accepts a CW key or keyer paddles (for the built-in electronic keyer), or output from an external electronic keyer. Pinout is shown on page 15. Key up voltage is 5 V, and key down current is 1 mA. This jack may be configured for keyer, “Bug,” “straight key,” or computer keying interface operation via Menu item “052 A1A F-TYPE” (see page 117). There is another jack with the same name on the rear panel, and it may be configured independently for Internal Keyer or pseudo-straight-key operation.

NOTE:

You cannot use a 2-contact plug in this jack (to do so produces a constant “key down” condition).

⑥ Microphone Connector

This 8-pin jack accepts input from a microphone utilizing a traditional YAESU HF-transceiver pinout.

⑦ DIM Switch

Press this button to lower the illumination intensity of the analog meter and the frequency display. Press it once more to restore full brightness.

ADVICE:

Menu Items “008 diSP DIM MTR” and “009 diSP DIM VFD” allow you to configure the dimming levels for the analog meter and the frequency display independently, so you can customize the brightness levels.

⑧ VOX Switch

This button enables automatic voice-actuated transmitter switching in the SSB, AM, and FM modes. While activated, the LED inside this button glows red. The controls affecting VOX operation are the front panel’s [VOX] and [DELAY] knobs. By proper adjustment of these controls, hands-free voice-actuated operation is possible.

⑨ ANTENNA Select Switch

[1/2]: Pressing this selects either the ANT 1 or 2 jack on the rear panel, and allows convenient antenna switching at the press of button. The selected antenna jack is indicated at the upper left corner of the display.

[RX]: Normally, the antenna connected to the ANT 1 or 2 jack is used for receive (and always used for transmit). When the [RX] switch is pressed, an antenna connected to the RX ANT will be used during receive.

⑩ MONI (Monitor) Switch

This button enables the transmit monitor in the SSB, CW, AM, and FM modes. While activated, the “**MONI**” icon appears in the display. Adjustment of the Monitor level is accomplished using the [MONI] knob.

ADVICE:

When using headphones, the Monitor is highly useful for making adjustments to the Parametric Equalizer or other voice quality adjustments, because the voice quality heard in the headphones is such a “natural” reproduction of the transmitted audio quality.

⑪ PROC (Processor) Switch

This button enables the Speech Processor for SSB transmission. While activated, the “**PROC**” icon appears in the display. Adjustment of the Processor level is accomplished using the [PROC] knob.

ADVICE:

The Speech Processor is a tool for increasing the average power output through a compression technique. However, if the [PROC] knob is advanced too far, the increase in compression becomes counter-productive, as intelligibility will suffer. We recommend that you monitor the sound of your signal using the Monitor (with headphones).

When the optional **DMU-2000** Data Management Unit is connected, you may use the Audio Scope/Oscilloscope page to help you adjust the setting of the compression level of the Speech Processor for optimum performance using your voice and microphone.

⑫ KEYER Switch

This button toggles the internal CW keyer on and off. While activated, the “**KEYER**” icon appears in the display. The Keyer sending speed and the CW Hang Time are adjusted via the front panel’s [SPEED] and [DELAY] knobs.

FRONT PANEL CONTROLS & SWITCHES

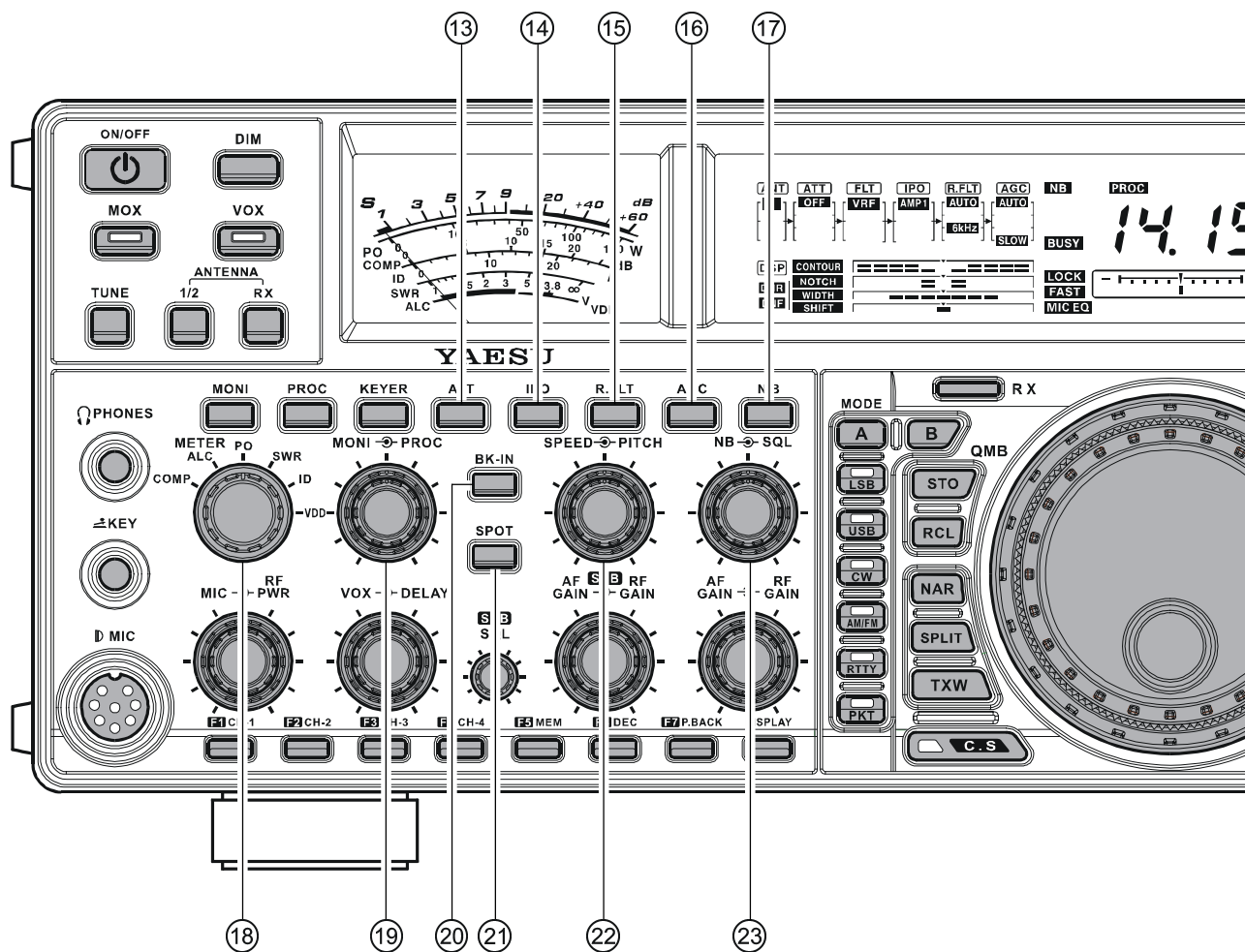

13 ATT Switch

This button selects the degree of attenuation, if any, to be applied to the receiver input.

Available selections are -6 dB, -12 dB, -18 dB, or OFF, and the selected attenuation level appears in the ATT column of the Receiver Configuration Indicator on the display.

ADVICE:

- The Attenuator affects *both* the Main (VFO-A) and Sub (VFO-B) receivers.
- The Attenuator may be used in conjunction with the [IPO] switch to provide two stages of signal reduction when an extremely strong signal is being received.

14 IPO (INTERCEPT POINT OPTIMIZATION) Switch

This button may be used to set the optimum front end characteristics of the receiver circuit for a very strong-signal environment. Available selections are AMP 1 (low distortion amplifier), AMP 2 (2-stage low-distortion RF amplifier), or ON (bypasses the front end RF amplifier), and the selected receiver RF amplifier appears at the IPO column of the Receiver Configuration Indicator in the display.

ADVICE:

The IPO switch affects both the Main (VFO-A) and Sub (VFO-B) receivers.

15 R.FLT Switch

This button selects the bandwidth for the Main Band (VFO-A) receiver's first IF Roofing Filter. Available selections are 3 kHz, 6 kHz, 15 kHz, or Auto, and the selected bandwidth appears in the FLT column of the Receiver Configuration Indicator on the display.

ADVICE:

- The Roofing Filter selection applies to the Main band (VFO-A) only.
- Because the roofing filter is in the first IF, the protection it provides against interference is quite significant. When set to AUTO, the SSB bandwidth is 6 kHz, while CW is 3 kHz and FM/RTTY are 15 kHz. On a crowded SSB band, however, you may wish to select the 3 kHz filter, for the maximum possible interference rejection.

FRONT PANEL CONTROLS & SWITCHES

⑩ AGC Switch

This button selects the AGC characteristics for the receiver. Available selections are FAST, MID, SLOW, or AUTO, and the “AGC” icon will change according to the AGC characteristics selected.

Press the [AGC] button repeatedly to select the desired receiver-recovery time constant. Press and hold in the [AGC] button for two seconds to disable the AGC (for testing or weak-signal reception).

When the [AGC] button is pressed independently, it applies to the Main band (VFO-A) receiver.

When you press the [B] button, followed by the [AGC] button (within five seconds of pressing the [B] switch), it affects the Sub band (VFO-B) receiver.

ADVICE:

If the AGC receiver-recovery time is set to “Off” by pressing and holding in the [AGC] button, the S-meter will no longer deflect. Additionally, you will likely encounter distortion on stronger signals, as the IF amplifiers and the following stages are probably being overloaded.

⑪ NB Switch

This button turns the IF Noise Blanker on and off.

Press this button momentarily to reduce a short-duration pulse noise; the “NB” icon will appear in the display.

Press and hold in this button for one second to reduce a longer-duration man-made pulse noise; the “NB” icon will blink for three seconds, then will appear continuously in the display.

Press this button again to disable the noise blanker; the “NB” icon will disappear.

ADVICE:

When you press (or press and hold) the [NB] button momentarily, it affects the Main band (VFO-A) receiver. When you press the [B] button, then press (or press and hold in) the [NB] button (within five seconds of pressing the [B] button), it affects the Sub band (VFO-B) receiver.

⑫ METER Switch

This control switch determines the function of the meter during transmission.

COMP: Indicates the speech compressor level (SSB mode only).

ALC: Indicates the relative ALC voltage.

PO: Indicates the average power output level.

SWR: Indicates the Standing Wave Ratio (Forward: Reflected).

ID: Indicates the final amplifier drain current.

VDD: Indicates the final amplifier drain voltage.

⑬ MONI → PROC Knobs

MONI Knob

The inner [MONI] knob adjust the audio level of the transmit RF monitor during transmission (relative to the AF GAIN control), when activated by the [MONI] button.

PROC Knob

The outer [PROC] knob sets the compression (input) level of the transmitter RF Speech Processor in the SSB and AM modes, when activated by the [PROC] button.

⑭ BK-IN Switch

This button turns the CW break-in capability on and off. While the CW break-in is activated, the “BK-IN” icon appears in the display.

⑮ SPOT Switch

This button turns on the CW receiver spotting tone; by matching the SPOT tone to that of the incoming CW signal (precisely the same pitch), you will be “zero beating” your transmitted signal on to the frequency of the other station.

The Sub (VFO-B) frequency display will indicate the offset tone frequency when this button is pressed.

⑯ SPEED → PITCH Knobs

SPEED Knob

The inner [SPEED] knob adjusts the keying speed of the internal CW keyer (4 ~ 60 WPM). Clockwise rotation increases the sending speed.

When turning this knob while pressing the [KEYER] button, the Sub (VFO-B) frequency display shows the keying speed.

PITCH Knob

The outer [PITCH] knob selects your preferred CW tone pitch (from 300 ~ 1050 Hz, in 50 Hz increments). The Tx sidetone, receiver IF passband, and display offset from the BFO (carrier) frequency are all affected simultaneously. The Pitch control setting also affects the operation of the CW Tuning Indicator, as the center frequency of the CW Tuning Indicator will follow the setting of this control.

⑰ NB → SQL Knobs

NB Knob

The inner [NB] knob adjusts the noise blanking level when the (analog) IF noise blanker is activated by pressing the [NB] button.

SQL Knob

The outer [SQL] knob sets the signal level threshold at which the Main (VFO-A) receiver audio is muted, in all modes. It is very useful during local rag-chews, to eliminate noise between incoming transmissions. This control is normally kept fully counter-clockwise (off), except when scanning and during FM operation.

FRONT PANEL CONTROLS & SWITCHES

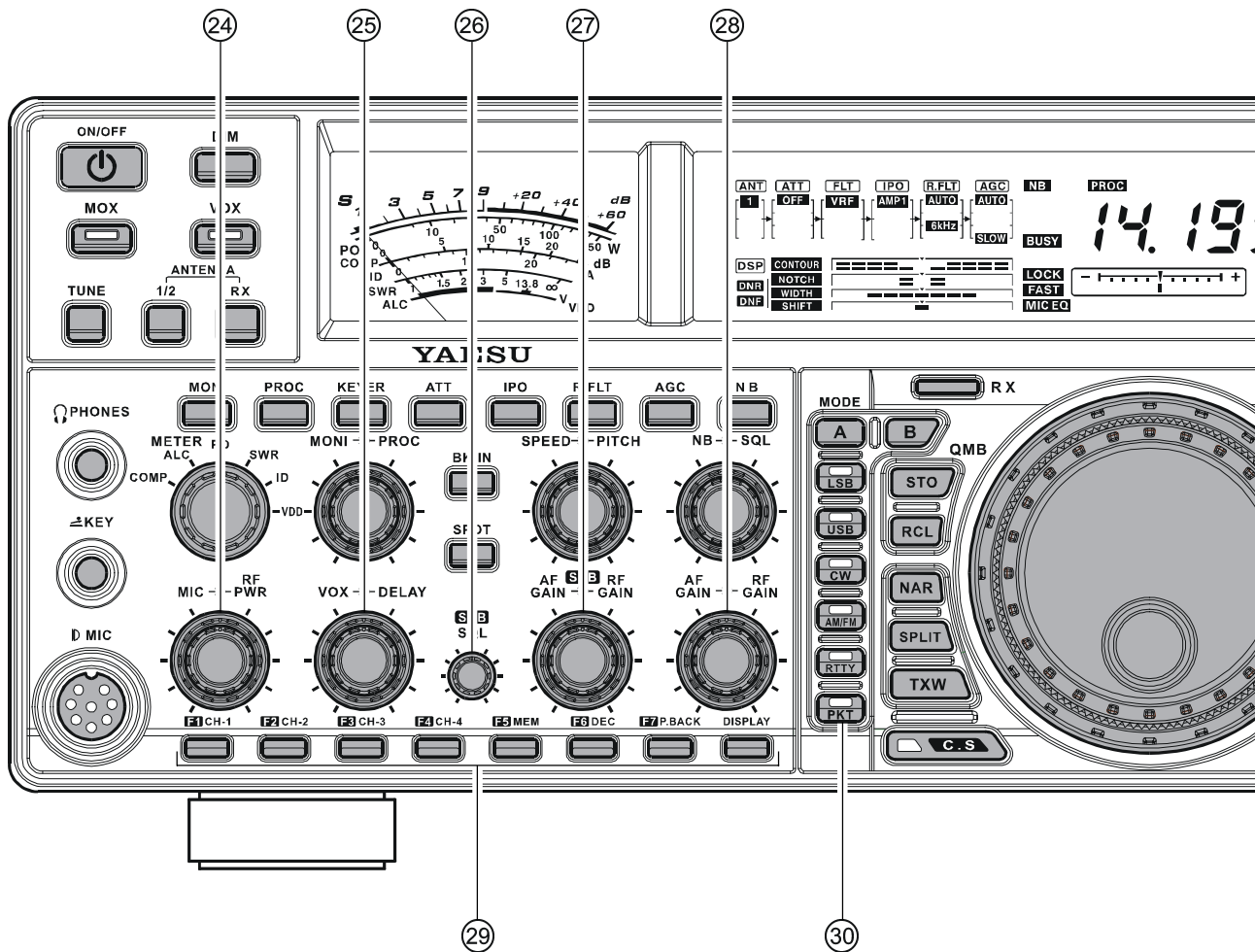

24 MIC → RF PWR Knobs

MIC Knob

The inner [MIC] knob adjusts the microphone input level for (non-processed) SSB transmission.

ADVICE:

If you adjust the MIC Gain while speaking in a somewhat-louder-than-normal voice level, watch the ALC level and adjust the MIC Gain so that the ALC reaches just to the right edge of the ALC scale. Then, when you speak in a more normal voice level, you'll be certain not to be over-driving the mic amplifier stage.

RF PWR Knob

The outer [RF PWR] knob is the main RF Power output control for the transceiver, active in all operating modes. Clockwise rotation increases the power output. Adjust this control for the desired power output from the **FT-2000**.

25 VOX → DELAY Knobs

VOX Knob

The inner [VOX] knob sets the gain of the VOX circuit, to set the level of microphone audio needed to activate the transmitter during voice operation while the [VOX] switch is engaged. The [VOX] switch must be switched "ON" to engage the VOX circuit.

DELAY Knob

The outer [DELAY] knob sets the hang time of the VOX circuit for voice operation and keying delay for CW operation.

During voice operation, this knob sets the hang time, between the moment you stop speaking, and the automatic switch from transmit back to receive. Adjust this for smooth VOX operation, so the receiver is only activated when your transmission is ended and you wish to receive.

For CW operation, this knob sets the keying delay, between the moment you stop sending, and the automatic switch from transmit back to receive during "Semi-break-in" operation. Adjust this just long enough to prevent the receiver from being restored during word spaces at your preferred sending speed.

FRONT PANEL CONTROLS & SWITCHES

②6 SUB SQL Knob

This knob sets the signal level threshold at which Sub (VFO-B) receiver audio is muted, in all modes. It is very useful during local rag-chews, to eliminate noise between incoming transmissions. This control is normally kept fully counter-clockwise (off), except when scanning and during FM operation.

②7 SUB AF GAIN ↔ SUB RF GAIN

AF GAIN Knob

The inner [SUB AF GAIN] knob sets the Sub (VFO-B) receiver's audio volume level. Typically, you will operate with this control set between the 9 o'clock and 10 o'clock positions.

RF GAIN Knob

The outer [SUB RF GAIN] knob is the Sub (VFO-B) receiver's RF gain control, which adjusts the gain of the Sub (VFO-B) receiver's RF and IF amplifier stages. This control is normally left in the fully clockwise position.

②8 AF GAIN ↔ RF GAIN Knobs

AF GAIN Knob

The inner [AF GAIN] knob sets the Main (VFO-A) receiver's audio volume level. Typically, you will operate with this control set between the 9 o'clock and 10 o'clock positions.

RF GAIN Knob

The outer [RF GAIN] knob is the Main (VFO-A) receiver's RF gain control, which adjusts the gain of the Main (VFO-A) receiver's RF and IF amplifier stages. This control is normally left in the fully clockwise position.

②9 F1 - F7 / DISPLAY Keys

These keys can be used to control the Voice Memory capability for the SSB/AM/FM modes, and the Contest Keyer for the CW mode. You can also play back up to 15 seconds of incoming received audio, as well, for verification of a missed callsign or other purposes. When the optional **DMU-2000** Data Management Unit is connected, you can also use the "Function" keys for the various functions associated with each "page" of the external display's capability.

[F1(CH 1)] - [F4(CH 4)] key

In the case of Voice Memory, up to 20 seconds of audio may be stored on each channel. For CW messages, up to 50 characters ("PARIS" specification) may be stored into each channel. See page 72 (Voice Memory) or page 84 (Contest Keyer) for details.

[F5(MEM)] key

This key is pressed for the purpose of storing either a Voice Memory or a Contest Keyer Memory channel's contents. See page 72 (Voice Memory) or page 84 (Contest Keyer) for details.

[F6(DEC)] key

When utilizing the sequential contest number capability of the Contest Keyer, press this key to decrement (back up) the current Contest Number by one digit (i.e. to back up from #198 to #197, etc.). See page 87 for details.

[F7(P.BACK)] key

Press and hold in this button for 2 seconds to activate the recording feature of the internal Digital Voice Recorder. The Voice Recorder allows you to record the Main band (VFO-A) receiver audio for the most-recent 15 seconds. While you're recording the receiver audio, the "**REC**" icon will appear in the display.

Press this button momentarily to stop the recording, then press this button momentarily again to play back the receiver audio for the most-recent 15 seconds of reception before you stopped the recording.

While playing back the receiver audio, the "**PLAY**" icon will appear in the display.

Press and hold in this button for 2 seconds again to resume recording.

[DISPLAY] key

Press and hold in this key for two seconds to cause the [F1(CH 1)] - [DISPLAY] keys to act as "Function" keys for the optional **DMU-2000** Data Management Unit if connected.

③0 MODE Switches

[A], [B] Switch

Pressing the [A] or [B] button will illuminate the respective indicator imbedded within the switch, allowing adjustment of the operating mode on the Main (VFO-A) or Sub (VFO-B) band. Usually, the [A] button glow Red, signifying that the Main band (VFO-A) is being adjusted. Similarly, pressing the [B] button will cause its indicator to blink Orange for five seconds, signifying Sub band (VFO-B) adjustment.

ADVICE:

When changing bands, confirm the [A] or [B] button illumination status at first, *then* press the appropriate [BAND] button, so as to change operating frequencies on the proper (Main or Sub) band.

[LSB], [USB], [CW], [AM/FM], [RTTY], [PKT] Switch

Pressing the [LSB], [USB], [CW], [AM/FM], [RTTY], or [PKT] button will select the operating mode. Pressing the [CW], [AM/FM], [RTTY], or [PKT] button multiple times will switch between the alternate operating features that can be used on these modes (covered later).

FRONT PANEL CONTROLS & SWITCHES

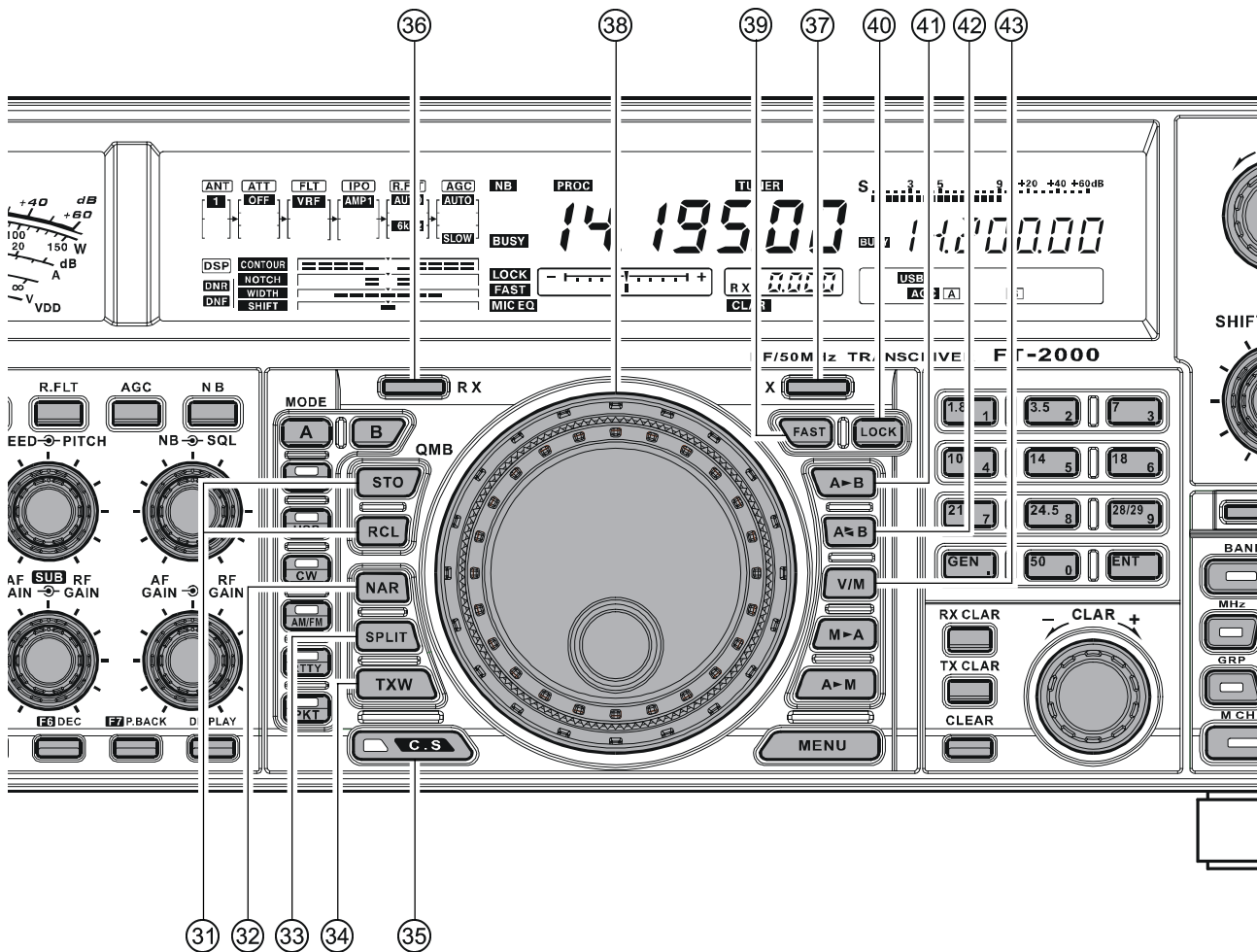

31 QMB (Quick Memory Bank) Switches STO (Store) Button

Pressing this button copies operating information (frequency, mode, bandwidth, and also repeater direction/shift frequency and CTCSS functions on the FM mode) into consecutive QMB Memories.

RCL (Recall) Button

Pressing this button recalls one of up to five Quick Memory Bank memories for operation.

32 NAR (Narrow) Switch

In the SSB/CW modes on the Main band (VFO-A), this button is used to set the bandwidth of the DSP (digital) IF filters to a user-programmed bandwidth (default values are SSB: 1.8 kHz and CW/RTTY/PSK: 300 Hz).

ADVICE:

When [NAR] has been engaged, the [WIDTH] knob will be disabled, although the [SHIFT] knob still works normally.

In the SSB/CW modes on the Sub Band (VFO-B), this button is used to toggle the receiver's bandwidth between wide (2.4 kHz) and narrow (1.0 kHz).

ADVICE:

When the Sub Band's (VFO-B) optional YF-122C (500 Hz) or YF-122CN (300 Hz) CW narrow filter is installed, the optional narrow filter will be activated when the [NAR] switch has been engaged on the CW/RTTY/PSK modes.

In the AM mode, this button is used to toggle the receiver's bandwidth between wide (9 kHz) and narrow (6 kHz).

In the FM mode on the 28 MHz and 50 MHz bands, this button is used to toggle the FM deviation/bandwidth between wide (± 5.0 kHz Dev./25.0 kHz BW) and narrow (± 2.5 kHz Dev./12.5 kHz BW).

Pressing the [A] or [B] button (located above the [MODE] selection buttons) will select either the Main band (VFO-A) or Sub band (VFO-B) for individual bandwidth setting.

FRONT PANEL CONTROLS & SWITCHES

③③ SPLIT Switch

Pressing this button to activate split frequency operation between the Main band (VFO-A), used for reception, and the Sub band (VFO-B), used for transmission. If you press and hold in the [SPLIT] button for two seconds, the “Quick Split” feature will be engaged, whereby the Sub band VFO (VFO-B) will automatically be set to a frequency 5 kHz higher than the Main band (VFO-A) frequency with same operating mode, and the transceiver will be placed in the Split mode.

③④ TXW “TX Watch” Switch

Pressing this button lets you monitor the transmit frequency when split frequency operation is engaged. Release the button to return to normal operation.

③⑤ C.S Switch

Press this button momentarily to recall a favorite Menu Selection directly.

To program a Menu selection as the short-cut, press the [MENU] button to enter the Menu, then select the Menu item you want to set as the short-cut. Now press and hold in the [C.S] button for two seconds; this will lock in the selected Menu item as the short-cut.

③⑥ RX Indicator/Switch

This button, when pressed, engages the Main band (VFO-A) receiver; the LED inside this button will glow Green when the Main receiver is active.

When the Main (VFO-A) receiver is active, pressing this button momentarily will mute the receiver, and the indicator will blink. Pressing the button once more will restore receiver operation, and the indicator will glow Green steadily.

③⑦ TX Indicator/Switch

When this button is pushed, the LED inside this button will glow Red, and the transmitter will be engaged on the same frequency and mode as set up for the Main band (VFO-A) (subject to any Clarifier offset, of course).

ADVICE:

If this indicator is not illuminated, it means that the Sub (VFO-B) TX indicator has been selected (it will be glowing Red). In this case, transmission will be effected on the frequency and mode programmed for the Sub (VFO-B) band.

③⑧ Main Tuning Dial Knob

This large knob adjusts the operating frequency of the Main band (VFO-A) or a recalled memory. Clockwise rotation of this knob increases the frequency. Default tuning increments are 10 Hz (100 Hz in AM and FM modes); when the [FAST] button is pressed, the tuning steps increase. The available steps are:

ADVICE:

OPERATING MODE	1 STEP	1 DIAL ROTATION
LSB/USB/CW/RTTY/PKT(LSB)	10 Hz (100 Hz)	10 kHz (100 kHz)
AM/FM/PKT(FM)	100 Hz (1 kHz)	100 kHz (1 MHz)

Numbers in parentheses indicate steps when the [FAST] button is On.

The tuning steps for the Main Tuning Dial knob are set, at the factory, to 10 Hz per step. Via Menu item “116 tun DIALSTP,” however, you may change this setting from 10 Hz to 1 Hz instead. When 1 Hz basic steps are selected, the action of the [FAST] button will be changed to 1/10 of the values listed above.

③⑨ FAST Switch

Pressing this button will increase or decrease the tuning rate of the Main Tuning Dial knob by a factor of ten, as mentioned in the previous section.

When this function is activated, the “FAST” icon appears in the display.

④⑩ LOCK Switch

This button toggles locking of the Main Tuning Dial knob, to prevent accidental frequency changes. When the button is active, the Main Tuning Dial knob can still be turned, but the frequency will not change, and the “LOCK” icon appears in the display.

④① [A▶B] Switch

Press this button momentarily to transfer data from the Main band (VFO-A) frequency (or a recalled memory channel) to the Sub band (VFO-B), overwriting any previous contents in the Sub band (VFO-B). Use this key to set both Main band (VFO-A) and Sub band (VFO-B) receivers to the same frequency and mode.

④② [A◀B] Switch

Pressing this button momentarily exchanges the contents of the Main band (VFO-A) (or a recalled memory channel) and the Sub band (VFO-B).

④③ [V/M] Switch

This button toggles Main band (VFO-A) receiver operation between the memory system and the VFO. Either “MR” or “MT” will be displayed to the under the main frequency display field to indicate the current selection. If you have tuned off of a Memory channel frequency (MT), pressing this button returns the display to the original memory contents (MR), and pressing it once more returns operation to the Main VFO (no icon).

FRONT PANEL CONTROLS & SWITCHES

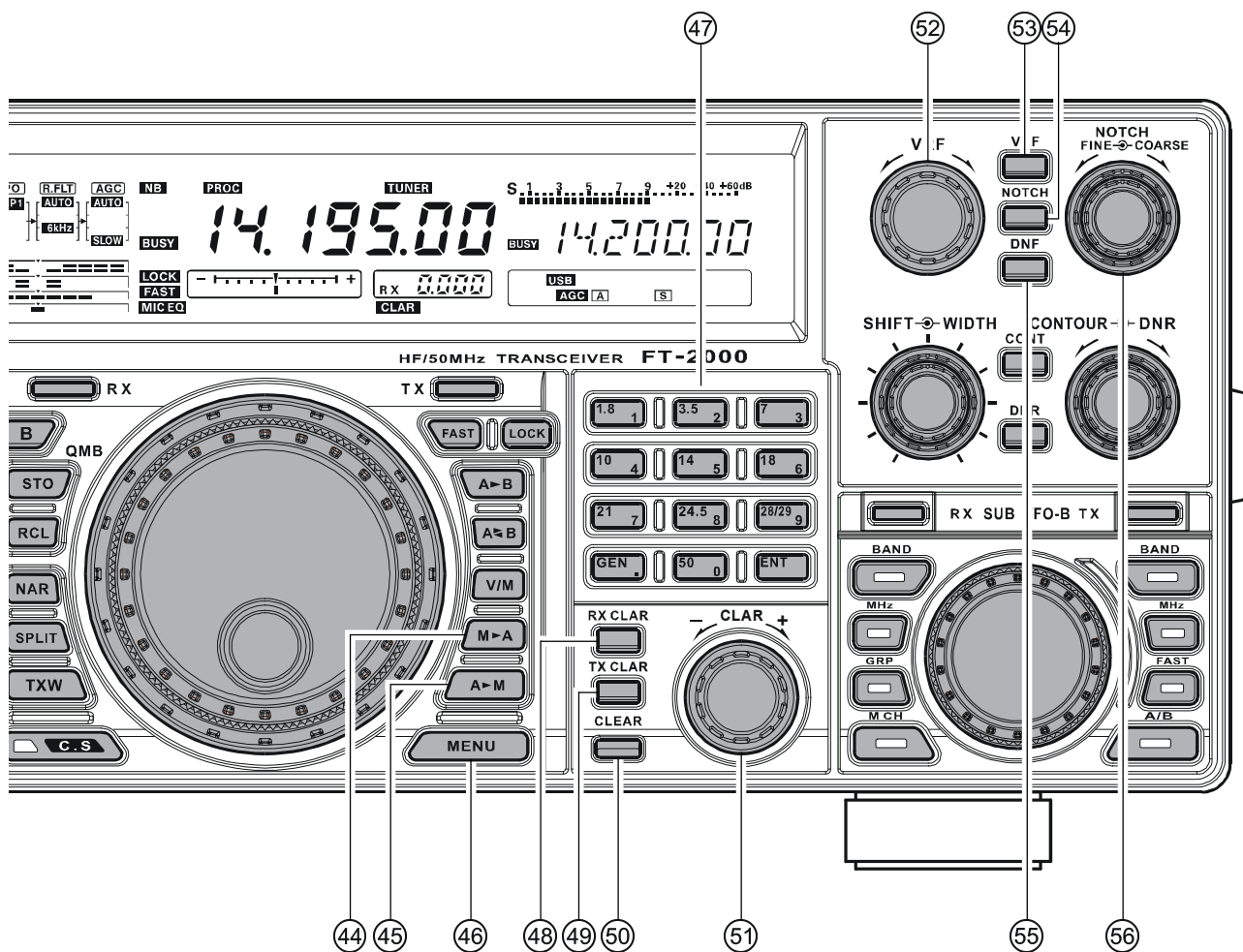

④④ [M▶A] Switch

Pressing this button momentarily displays the contents of the currently-selected memory channel for three seconds.

Holding this button in for 2 seconds copies the data from the currently-selected memory to the Main VFO (VFO-A), as two beeps sound. Previous data in the Main VFO will be overwritten.

④⑤ [A▶M] Switch

Pressing and holding in this key for 1/2 second (until the double beep) copies the current operating data from the Main band (VFO-A) into the currently selected memory channel, overwriting any previous data stored there.

Also, pressing and holding in this button after recalling a memory, without first retuning, causes the memory channel to be “masked,” and repeating the process restores the masked memory.

④⑥ MENU Switch

This button is used for gaining access to the Menu system, for configuring various transceiver characteristics. Menu operation is described in detail, in this manual, beginning on page 108.

IMPORTANT NOTE:

Pressing this button momentarily activates the Menu, and the Menu items will appear on the display; once you are finished, you must press and hold in the [MENU] button for two seconds to save any configuration changes (momentarily pressing the [MENU] button to exit will not save the changes).

④⑦ BAND Keys

These keys allow one-touch selection of the desired Amateur band (1.8 ~ 50 MHz).

What’s more, these keys may be used for direct entry of a desired operating frequency during VFO operation.

FRONT PANEL CONTROLS & SWITCHES

④8 RX CLAR Switch

Pressing this button activates the RX Clarifier, to allow offsetting the Main (VFO-A) receiving frequency temporarily. Press this button once more to return the Main receiver to the frequency shown on the main frequency display field; the Clarifier offset will still be present, though, in case you want to use it again. To cancel the Clarifier offset, press the [CLEAR] button.

④9 TX CLAR Switch

Pressing this button activates the TX Clarifier, to allow offsetting the Main (VFO-A) transmit frequency temporarily.

Press this button once more to return the transmitter to the Main (VFO-A) frequency shown on the main frequency display field; the Clarifier offset will still be present, though, in case you want to use it again. To cancel the Clarifier offset, press the [CLEAR] button.

⑤0 CLEAR Switch

Pressing this button clears out any frequency offset you have programmed into the Clarifier register (thereby setting the offset to “Zero”).

⑤1 CLAR Knob

This knob tunes the Clarifier offset frequency up to 9.99 kHz.

⑤2 VRF Knob

This knob tunes the passband of the VRF (Variable RF Filter) preselector circuit for maximum receiver sensitivity (and out-of-band interference rejection).

ADVICE:

- The relative position of the VRF passband can be observed on the Tuning Offset Indicator of the display via Menu item “O10 diSP BAR SEL.”
- When the optional RF μ Tuning Kit is connected, this knob allows adjustment of the center frequency of the μ -Tuning filter passband (which is much narrower than that of the VRF).

⑤3 VRF Switch

This button turns the VRF filter on and off. While activated, the “VRF” icon will appear in the FLT column of the Receiver Configuration Indicator on the display.

ADVICE:

When the optional RF μ Tuning Kit is connected, pressing this button will engage the μ -Tuning filter. The μ Tuning Kit provides much better RF selectivity than any other RF filter in the Amateur industry, yielding outstanding protection from high RF levels not far removed from the current operating frequency.

⑤4 NOTCH Switch

This button turns the Main band (VFO-A) receiver’s IF Notch Filter on and off.

When the IF Notch Filter is activated, the peak position of the IF Notch Filter is depicted graphically in the display. The IF Notch Filter center frequency is adjusted via the [NOTCH] knob.

⑤5 DNF Switch

This button turns the Main band (VFO-A) receiver’s Digital Notch Filter on and off. When the Digital Notch Filter is activated, the “DNF” icon appears in the display. This is an automatic circuit, and there is no adjustment knob for the DNF.

⑤6 NOTCH Knob

This knob adjusts the center frequency of the Main band (VFO-A) receiver’s IF Notch Filter. The Notch Filter is engaged via the [NOTCH] button.

Initially, the approximate center frequency of the IF Notch Filter is adjusted by the outer [COARSE] knob; then, fine tuning of the center frequency is adjusted by the inner [FINE] knob.

FRONT PANEL CONTROLS & SWITCHES

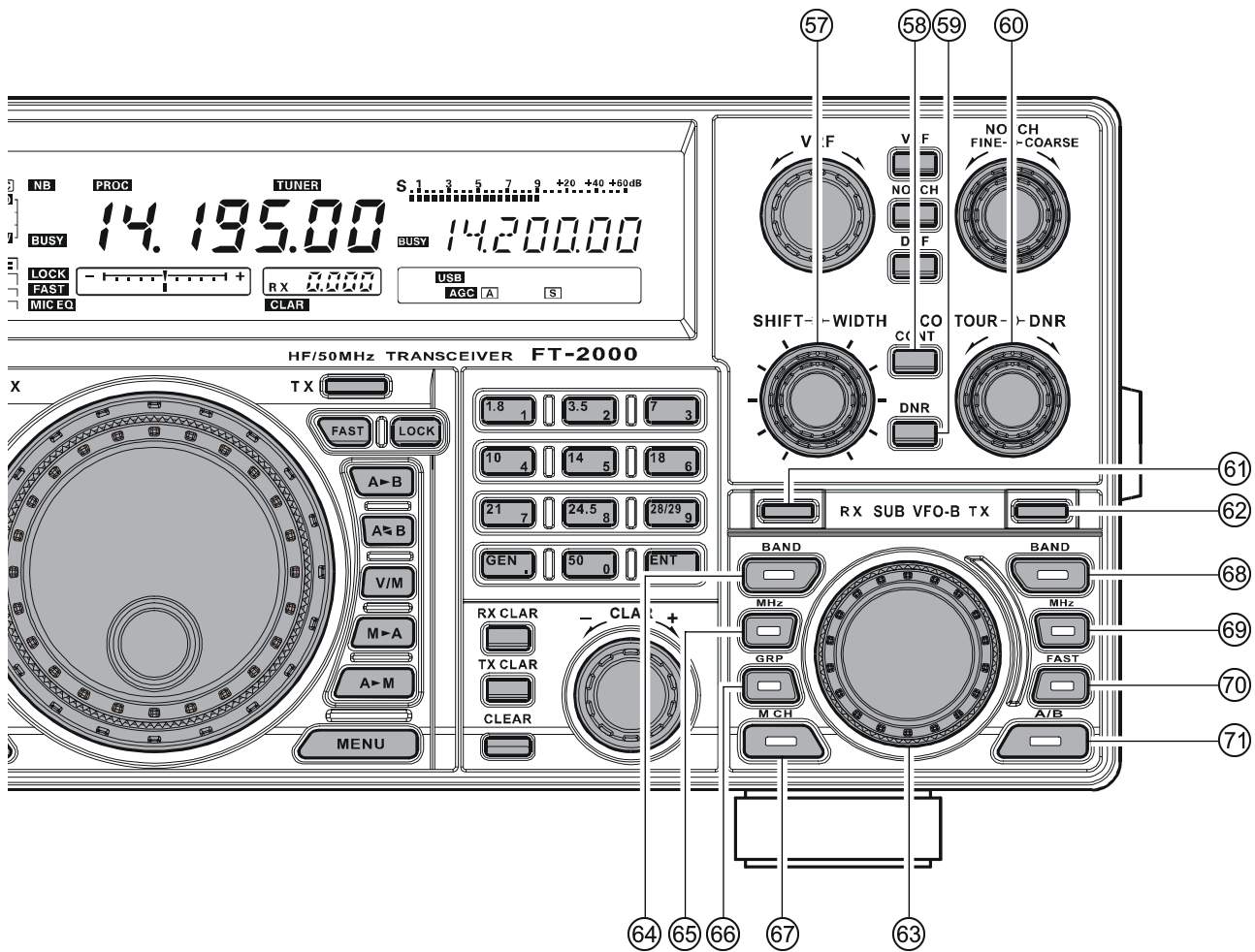

57 SHIFT \leftrightarrow WIDTH Knobs (EXCEPT ON FM MODE)

SHIFT Knob

The inner [SHIFT] knob provides adjustment of the IF DSP passband, using 20 Hz steps for precise adjustment and easy reduction of interference on either side of your operating frequency. The total adjustment range is ± 1 kHz. The normal operating setting for this knob is straight up, in the 12 o'clock position.

ADVICE:

You may shift the Sub band (VFO-B) filter passband via Menu item "042 S-iF LSB SET" through "049 S-iF PKT-USB."

WIDTH Knob

The outer [WIDTH] knob sets the overall bandwidth of the IF DSP filter for the Main (VFO-A) receiver. The center (12 o'clock) position establishes the "default" bandwidth (for example, 2.4 kHz for SSB); clockwise rotation of this knob increases the bandwidth (out to a maximum of 4 kHz), while counter-clockwise rotation reduces the bandwidth.

When the NAR (Narrow) filter selection is engaged, the [WIDTH] knob is disabled.

The [SHIFT] knob may be used to re-center the passband response on the incoming signal, and you may find that the CONTOUR and IF Notch Filter may also help improve intelligibility and/or reduce interference. See also the discussions of the [CONTOUR] knob and [NOTCH] knob.

ADVICE:

When the [NAR] button has been pushed, the [WIDTH] knob no longer functions (except the CW mode). The IF SHIFT system is still fully operational, however.

FRONT PANEL CONTROLS & SWITCHES

⑤8 CONT Switch

This button turns the Main band (VFO-A) receiver's CONTOUR filter on and off. When the CONTOUR Filter is activated, the peak position of the CONTOUR Filter is depicted graphically in the display. Adjustment of the CONTOUR filter's center frequency is provided by the [CONTOUR] knob.

NOTE:

There are times, when you're trying to remove interference with a sharp DSP filter, that the remaining signal has a somewhat unnatural sound. This is caused by the cutting of some frequency components, leaving other components in excess. The CONTOUR filter allows you (especially) to roll off certain frequency components inside the remaining passband, but in a smooth manner that helps restore a natural sound and/or raise intelligibility.

⑤9 DNR Switch

This button turns the Main band (VFO-A) receiver's Digital Noise Reduction circuit on and off. When the Digital Noise Reduction is activated, the "DNR" icon appears in the display. Adjustment of the Noise Reduction level is provided by the [DNR] knob.

⑥0 CONTOUR ↔ DNR Knob

CONTOUR Knob

The inner [CONTOUR] knob selects the desired Main band (VFO-A) receiver's CONTOUR filter response. The CONTOUR filter is engaged via the [CONTOUR] button.

DNR Knob

The outer [DNR] knob selects the Main band (VFO-A) receiver's optimum Digital Noise Reduction response. The Noise Reduction circuit is engaged via the [DNR] button.

⑥1 RX Indicator/Switch

This is the button that turns the Sub (VFO-B) receiver On and Off. When this button is pressed to make the Sub (VFO-B) receiver active, the Green LED imbedded within the button will light up. Pressing the button again will disable this receiver, and the imbedded Green LED will turn off.

⑥2 TX Indicator/Switch

This is the button that turns the Sub (VFO-B) transmitter On and Off. When this button is pressed to transfer transmitter control to the Sub (VFO-B) frequency and mode, the Red LED imbedded within the button will light up. Pressing this button once more will transfer frequency/mode control back to the Main (VFO-A) side, and the Red LED imbedded within this button will turn off.

⑥3 SUB VFO-B Knob

Depending on the status of the [A/B] button located at the right bottom of the [SUB VFO-B] knob, the [SUB VFO-B] knob is used for functions associated with the Main (VFO-A) or Sub (VFO-B) frequency control registers.

⑥4 (VFO-A) BAND Switch

Pressing this button allows you to select the Main (VFO-A) operating band (Amateur bands) using the [SUB VFO-B] knob.

⑥5 (VFO-A) MHz Switch

Pressing this button allows you to tune the Main band (VFO-A) frequency down or up in 1 MHz increments, using the [SUB VFO-B] knob.

⑥6 GRP Switch

Pressing this button allows you to select the memory group using the [SUB VFO-B] knob.

⑥7 M CH Switch

Pressing this button allows you to select the memory channel using the [SUB VFO-B] knob.

⑥8 (VFO-B) BAND Switch

When the [A/B] button is pressed, and the Orange lamp to the right of the [SUB VFO-B] knob lights up, pressing this button allows you to select the Sub (VFO-B) operating band (Amateur bands) using the [SUB VFO-B] knob.

⑥9 (VFO-B) MHz Switch

When the [A/B] button is pressed, and the Orange lamp to the right of the [SUB VFO-B] knob lights up, pressing this button allows you to tune the Sub band (VFO-B) frequency down or up in 1 MHz increments, using the [SUB VFO-B] knob.

⑦0 FAST Switch

When the [A/B] button is pushed, and the Orange lamp to the right of the [SUB VFO-B] knob lights up, the [SUB VFO-B] knob will be controlling the Sub band (VFO-B) frequency; pressing the [FAST] button will increase the tuning rate by a factor of 10.

⑦1 A/B Switch

The [A/B] button determines whether the actions of the [SUB VFO-B] knob will be applied to the Main band (VFO-A) or the Sub band (VFO-B).

Pressing this button once causes the Orange lamp to the right of the [SUB VFO-B] knob to light up; in this case, rotation of the [SUB VFO-B] knob affects operation on the Sub band (VFO-B). Pressing the [A/B] button once more causes the Orange lamp to turn off; in this instance, rotation of the [SUB VFO-B] knob affects operations associated with the Main band (VFO-A).

DISPLAY INDICATIONS (LEFT SIDE & CENTER)

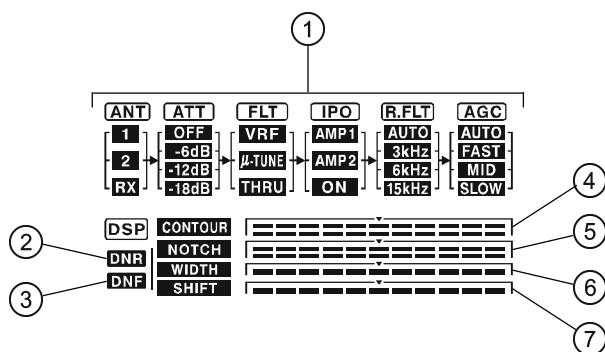

① Receiver Configuration Indicators

ANT (1, 2, RX):

Indicates the antenna selected for operation by the front panel [1/2] and [RX] antenna switches.

ATT (OFF, -6 dB, -12 dB, -18 dB):

Indicates the attenuation level selected for operation by the front panel [ATT] button.

FLT (VRF, μ-TUNE, THRU):

Indicates the RF filter selected for operation by the front panel [VRF] button.

ADVICE:

The μ-TUNE filter is an option. The “μ-TUNE” icon will not appear when the optional μ-TUNE unit is not connected.

IPO (AMP 1, AMP 2, ON):

Indicates the front end RF amplifier selected for operation by the front panel [IPO] button.

R.FLT

Indicates the 1st IF Roofing Filter selected: AUTO (mode-determined), 3 kHz, 6 kHz, or 15 kHz.

AGC (AUTO, FAST, MID, SLOW):

Indicates the AGC decay time selected for Main band (VFO-A) operation by the front panel [AGC] switch.

② DNR

This indicator appears whenever the Digital Noise Reduction feature is activated.

③ DNF

This indicator appears whenever the Digital Notch Filter is activated.

④ CONTOUR

The peak position of the CONTOUR Filter is depicted graphically here when the CONTOUR Filter is activated.

⑤ NOTCH

The null position of the IF Notch Filter is depicted graphically here when the IF Notch Filter is activated.

⑥ WIDTH

Indicates the bandwidth of the DSP IF filter.

⑦ SHIFT

Indicates the peak position of the DSP IF filter.

⑧ NB

This indicator appears when the Main band (VFO-A) receiver's (short duration) Noise Blanker is activated. This indicator will blink for three seconds, and thereafter appears continuously, when the Main band (VFO-A) receiver's longer-pulse Noise Blanker is activated.

⑨ NAR

This indicator appears whenever the Main band (VFO-A) receiver's narrow IF DSP filter is engaged.

⑩ PROC

This indicator appears whenever the DSP Speech Processor is activated.

⑪ MONI

This indicator appears whenever the transmit monitor circuit is activated.

⑫ KEYER

This indicator appears whenever the internal CW keyer is activated.

⑬ BK-IN

This indicator appears whenever CW break-in operation is activated.

⑭ TUNER

This indicator appears when the internal Automatic Antenna Tuner is activated.

⑮ HI SWR

This indicator appears if the directional coupler and microprocessor detect an abnormally high SWR condition (over 3.0:1) that cannot be resolved by the Automatic Antenna Tuner.

NOTE:

If this indicator appears, check to be sure that you have the correct antenna selected on the current operating band. If so, you will need to check the condition of the antenna, its coaxial cable, and/or the connectors on the cable so as to locate and correct the fault.

DISPLAY INDICATIONS (CENTER)

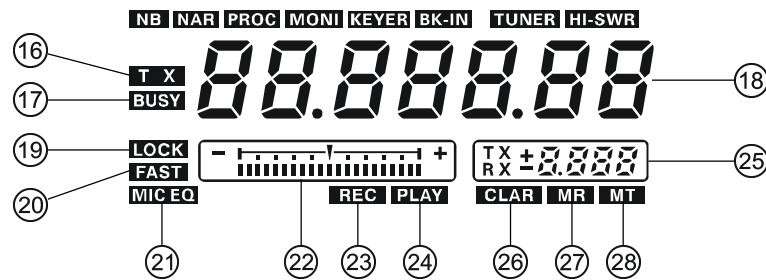

①⑥ TX

This indicator appears during transmission on the Main band (VFO-A) frequency.

①⑦ BUSY

This indicator appears whenever the Main band (VFO-A) receiver squelch is open. If this indicator is not showing, and reception seems to have been lost on the Main receiver for no apparent reason, check the position of the SQL knob and rotate it fully counter-clockwise to restore reception.

①⑧ Main (VFO-A) Frequency Display

This is the Main band (VFO-A) frequency display.

ADVICE:

- When setting the Menu items, the Menu item number and Menu group name will appear in this area during setup.
- When setting the CTCSS frequency for Encoding or Tone Squelch operation, the current tone information will appear in this area during setup.

①⑨ LOCK

This indicator appears when the Main Tuning Dial knob is locked.

②⑦ FAST

This indicator appears when the Main Tuning Dial knob's tuning rate is selected to fast.

②① MIC EQ

This indicator appears whenever the Three-Band Parametric Microphone Equalizer is activated via the Menu.

②② Tuning Offset Indicator

This is a tuning scale that, as configured from the factory, provides a visual CW tuning indication of the incoming signal's offset from your transceiver's CW carrier frequency, as programmed by the relative clarifier offset, or the peak position of the VRF/ μ -TUNE filter.

②③ REC

This indicator appears while the voice recorder is recording the receiver audio, and/or the memory is recording your CW or voice message.

②④ PLAY

This indicator appears while the voice recorder is playing back the recorded audio, and/or the memory is playing back the recorded CW or voice message.

②⑤ Multi-Display Window

This window displays either the Clarifier offset or Memory Channel Number.

ADVICE:

- During FM operation, the Repeater Shift will be indicated in this window. A Negative frequency shift will be indicated by “-” while a Positive frequency shift will be indicated by “+.”
- When setting the Menu items, the current setting will appear in this area.
- When setting the CTCSS frequency for Encoding or Tone Squelch operation, the current repeater shift direction will appear in this area.

②⑥ CLAR

This indicator appears whenever the Clarifier function is activated.

②⑦ MR

This indicator appears when the FT-2000 is in the Memory Recall mode.

②⑧ MT

This indicator appears when the FT-2000 is in the Memory Tune mode to indicate that the memory contents have been temporarily changed.

DISPLAY INDICATIONS (RIGHT SIDE)

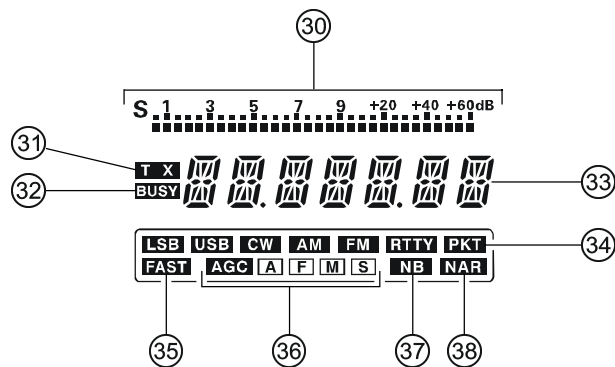

③① Sub (VFO-B) Receiver S-Meter

Displays the strength of signals received on the Sub band (VFO-B).

③② TX

This indicator appears during transmission on the Sub band (VFO-B) frequency.

③③ BUSY

This indicator appears whenever the Sub band (VFO-B) receiver squelch is open. If this indicator is not showing, and reception seems to have been lost on the Sub receiver for no apparent reason, check the position of the Sub [SQL] knob and rotate it fully counter-clockwise to restore reception.

③④ Sub (VFO-B) Frequency Display

This is the Sub band (VFO-B) frequency display.

ADVICE:

- When setting the Menu items, the Menu item name will appear in this area during setup.
- When setting the CTCSS frequency for Encoding or Tone Squelch operation, the current tone frequency will appear in this area during setup.
- When activating the CW Spot Tone, the current tone frequency will appear in this area.

③⑤ LSB, USB, CW, AM, FM, RTTY, PKT

Displays the currently-selected operating mode for the Sub (VFO-B) receiver.

③⑥ FAST

This indicator appears when the [SUB VFO-B] knob's tuning rate is selected to fast.

③⑦ AGC A, F, M, S

Displays the currently-selected AGC decay time for the Sub (VFO-B) receiver.

A: Auto, F: Fast, M: Medium, S: Slow

③⑧ NB

This indicator appears when the Sub (VFO-B) receiver's (short duration) Noise Blanker is activated. This indicator will blink for three seconds, and thereafter appears continuously, when the Sub (VFO-B) receiver's longer-pulse Noise Blanker is activated.

③⑨ NAR

This indicator appears whenever the optional Sub (VFO-B) receiver's narrow filter is selected.

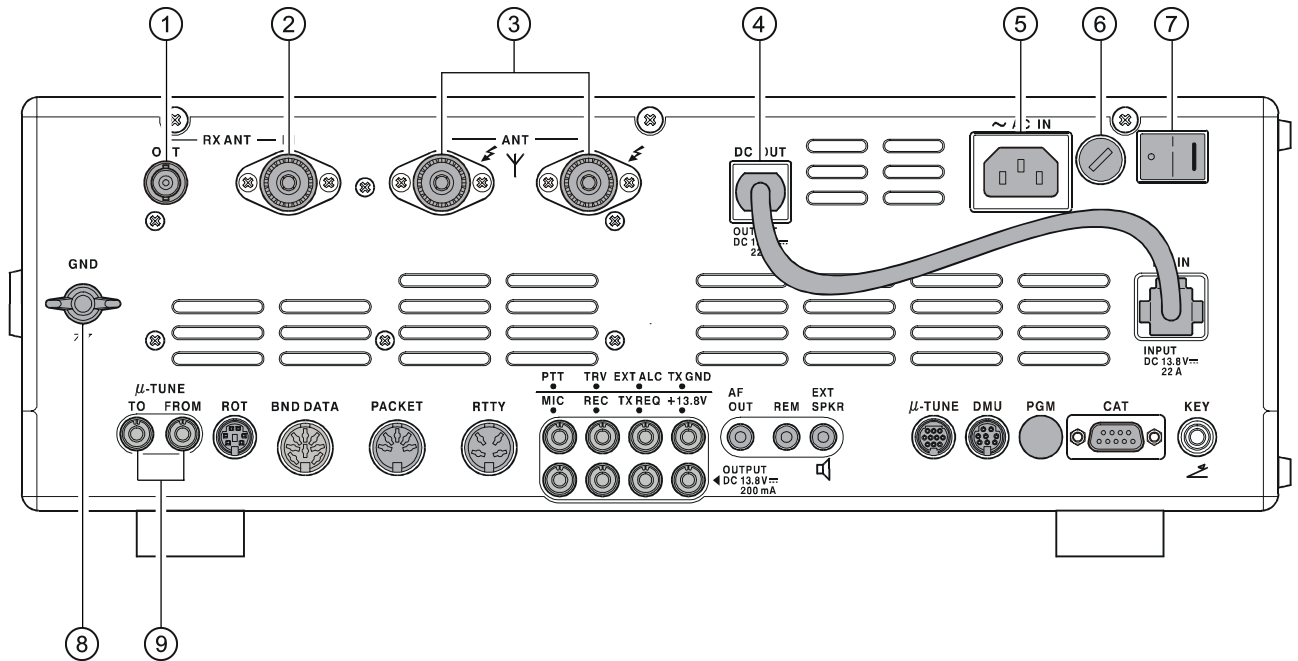

① RX ANT OUT Jack

This BNC jack provides output of the receiver signal lines from the Antenna jacks which are connected to “RX” side of the transceiver’s main T/R switching circuitry.

② RX ANT IN Jack

This type-M jack is for a separate receive-only antenna. An antenna connected here can be used when the [RX] antenna button on the front panel is pressed.

If you want to use some special kind of external bandpass filter or preamplifier, you may connect it between the RX ANT OUT and RX ANT IN jacks.

③ ANT 1/2 Jacks

Connect your main antenna(s) here, using a type-M (PL-259) plug and coaxial feedline for each. These antenna ports are always used for transmission, and also are used for reception unless a separate receive antenna is also used for the receiver. The internal antenna tuner affects only the antenna(s) connected here, and only during transmission.

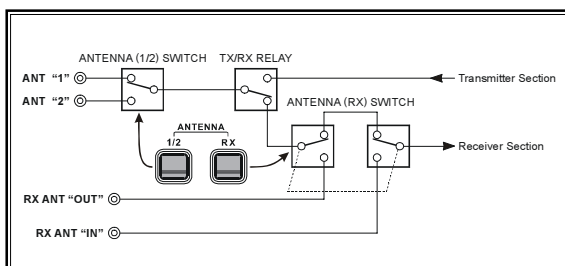

④ DC OUT

This is DC power output lead from the internal AC power supply. Connect this pigtail to the DC IN Jack of the transceiver.

⑤ ~AC IN Jack

Connect the supplied 3-wire AC line cord to this socket after ensuring that your AC mains voltage matches that on the label. See the Installation section for instructions on how to change the internal switching power supply AC mains voltage, if necessary.

⑥ FUSE

This holder requires a 10-A fuse. Always use the 10 Amp fuse, whether operating on 100 - 120 VAC or 200 - 240 VAC.

⑦ Main Power Switch

This is main power On (I)/Off (O) switch of the FT-2000. Always turn this switch on before turning on the front panel’s [POWER] button.

If this switch is not turned On, the front panel [POWER] switch will not function.

⑧ GND

Use this terminal to connect the transceiver to a good earth ground, for safety and optimum performance. Use a large diameter, short braided cable for making ground connections, and please refer to page 9 for other notes about proper grounding.

⑨ μ-TUNE Jacks

These jacks are used for signal input/output of the optional RF μTuning Kit.

REAR PANEL

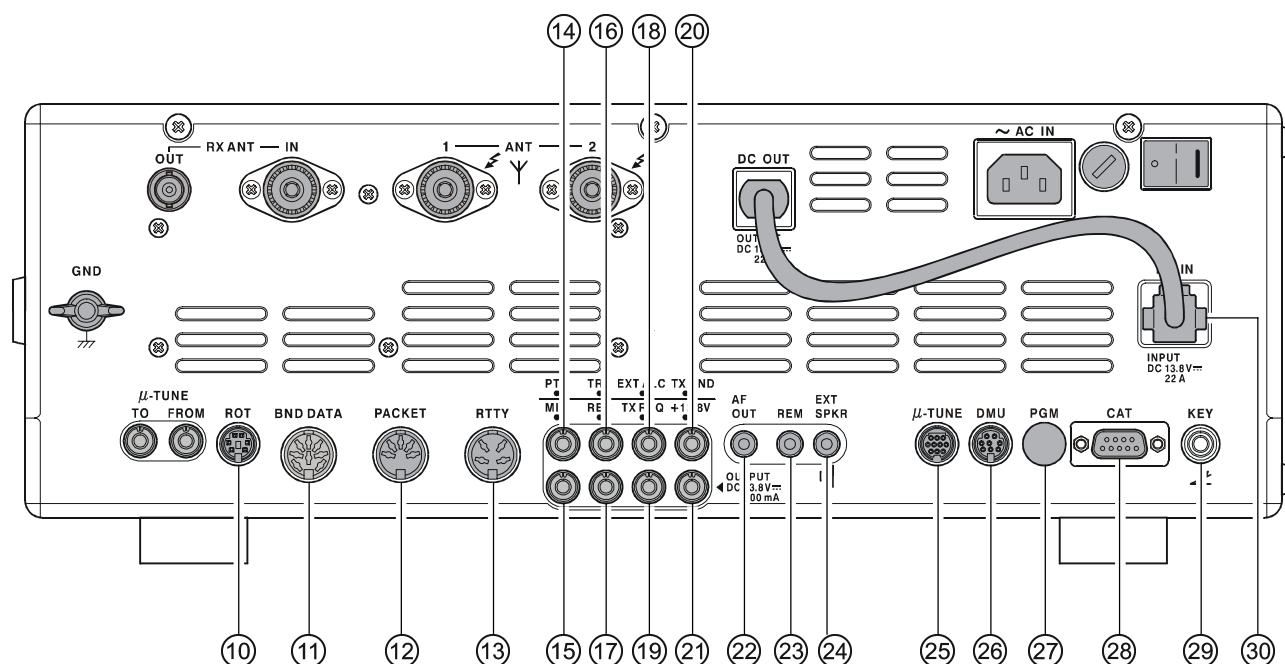

⑩ ROT (ROTATOR) Jack

This 5-pin MINI-DIN Jack accepts a cable connected to a YAESU **G-800DXA/-1000DXA/-2800DXA** Antenna Rotator (listed models are current as of early 2006). You may control the antenna azimuth rotation (and rotation speed) using the Function buttons on the front panel.

⑪ BND (BAND) DATA Jack

This 8-pin output jack provides band selection data which may be used for control of optional accessories such as the **VL-1000** Solid-state Linear Amplifier.

⑫ PACKET Jack

This 5-pin input/output jack provides receiver audio and squelch signals, and accepts transmit (AFSK) audio and PTT control, from an external Packet TNC. Pinout is shown on page 15. The receiver audio level at this jack is approximately 100 mVp-p (@600 Ohms).

⑬ RTTY Jack

This 4-pin input/output jack provides connections for an RTTY terminal unit. Pinout is shown on page 15. The receiver audio level at this jack is at a constant 100-mV (@600 Ohms) level. FSK keying at this jack is accomplished by a closure of the SHIFT line to ground by the terminal unit.

⑭ PTT Jack

This RCA input jack may be used to provide manual transmitter activation using a footswitch or other switching device. Its function is identical to the **[MOX]** button on the front panel. The same line is available at the **PACKET** and **RTTY** jacks for TNC control. Open-circuit voltage is +13.5 VDC, and closed-circuit current is 5 mA.

⑮ MIC (PATCH) Jack

This RCA input jack accepts transmitter audio - either AFSK or voice - for transmission. This line is mixed with the microphone audio input line, so the microphone should be disconnected if using this jack and mixing is not desired. The optimum impedance is 500 ~ 600 Ohms, and the nominal input level should be 5 mV.

⑯ TRV Jack

This RCA jack provides a low level RF output for use with a transverter. Maximum output is approximately -10 dBm (0.1 mW) at 50 Ohms.

⑰ REC Jack

This RCA jack provides low-level receiver audio output and transmit audio, for recording or external amplification. Peak signal level is 30 mVp-p at 10 kOhms.

⑱ EXT ALC Jack

This RCA input jack accepts negative-going external ALC (Automatic Level Control) voltage from a linear amplifier, to prevent over-excitation by the transceiver. Acceptable input voltage range is 0 to -4 VDC.

⑲ TX REQ Jack

When this RCA jack shorted to ground, it puts the **FT-2000** into the transmit mode, and sends out a steady CW carrier, for linear amplifier or manual antenna tuner adjustment.

⑳ TX GND Jack

This RCA jack's center pin is closed to ground while the transceiver's transmitter is engaged. It may be used for control of a peripheral device, most typically a linear amplifier. To enable this jack, please set Menu item "144 tGEn ETX-GND" to the "EnA" (Enable) selection.

The relay circuit of the **FT-2000** used for this jack is capable of switching AC voltage of 100 Volts at up to 300 mA, or DC voltages or 60 V at 200 mA or 30 V at up to 1 Amp.

㉑ +13.8 V Jack

This RCA output jack provides regulated, separately fused 13.8 VDC at up to 200 mA, to power an external device such as a packet TNC. Make sure your device does not require more current (if it does, use a separate power source).

㉒ AF OUT

This gold-plated 3-contact jack provides dual-channel low-level receiver output, for recording or external amplification. Peak signal level is 300 mVp-p at 10 k-Ohms. Main band (VFO-A) receiver audio is on the left channel (tip), and sub band (VFO-B) receiver audio is on the right channel (ring). A stereo amplifier or recorder is recommended, to record each receiver's audio separately when dual reception is enabled (audio from either receiver, or both, may be used via this jack). The front panel [AF GAIN] knobs do not affect the signals at this jack.

㉓ REM (REMOTE) Jack

By plugging in the optional **FH-2** Remote Control Keypad to this gold-plated jack, direct access to the **FT-2000** CPU is provided for control functions such as contest memory keying, plus frequency and function control.

㉔ EXT SPKR

This gold-plated two-contact output jack provides receiving audio from the Main (VFO-A) and Sub (VFO-B) receivers for an external loudspeaker or speakers, such as the **SP-2000**. Inserting a plug into this jack disables the internal loudspeaker. Impedance is 4 ~ 8 Ohms.

㉕ μ -TUNE Jack

This 10-pin MINI-DIN jack used for control of the optional RF μ Tuning Kit.

㉖ DMU Jack

This 8-pin MINI-DIN jack accepts a cable connected to an optional **DMU-2000** Data Management Unit.

㉗ PGM (PROGRAM) Jack

This covered 9-pin MINI-DIN jack is used at the factory. *Please do not connect any equipment to this jack.*

㉘ CAT Jack

This 9-pin serial DB-9 jack allows external computer control of the **FT-2000**. Connect a serial cable here and to the RS-232C COM port on your personal computer (no external interface is required).

㉙ KEY Jack

This 1/4-inch phone jack accepts a CW key or keyer paddle. A 2-contact plug cannot be used in this jack. Key-up voltage is +5 V, and key-down current is 1 mA. Plug wiring is shown on page 15, and this jack may be configured for keyer, "Bug," "straight key," or computer keying interface operation via Menu item "054 A1A R-TYPE."

㉚ DC IN Jack

This 4-pin connector requires a 13.8-volt supply capable of 22 amperes continuous duty. Typically, you will connect the DC OUT plug to this jack. For DC operation, use the optional DC Cable (P/N: T9023725) with a 25 A fuse installed.

BASIC OPERATION: RECEIVING ON AMATEUR BANDS

Before turning on main power, please verify the following items once more.

- Have you made all ground connections securely? See page 9 for details.
- Do you have your antenna(s) connected to the rear-panel Antenna jack(s)? See page 10 for details.
- Is your microphone (and/or key or paddle) connected? See pages 11 and 12 for details.
- If using a linear amplifier, have all interconnections been successfully completed? See pages 13 and 14 for details.
- Please rotate both [**AF GAIN**] controls to their fully counter-clockwise positions, to avoid a loud blast of audio when the transceiver turns on. See page 21 for details.
- Rotate the [**RF PWR**] control fully counter-clockwise, to set minimum power at first. See page 20 for details.
- If your AC mains power should suffer a significant fluctuation or interruption, we recommend that you go through a complete power-up cycle, in order to ensure that all circuits are properly initialized. To do this, be sure the front panel [**POWER**] switch is turned off, then set the rear-panel [**POWER**] switch to the “**○**” position. Now unplug the AC cable from the rear panel of the transceiver, and wait ten seconds before proceeding with the start-up procedure described below.

BASIC OPERATION: RECEIVING ON AMATEUR BANDS

Here is the typical start-up procedure for normal operation:

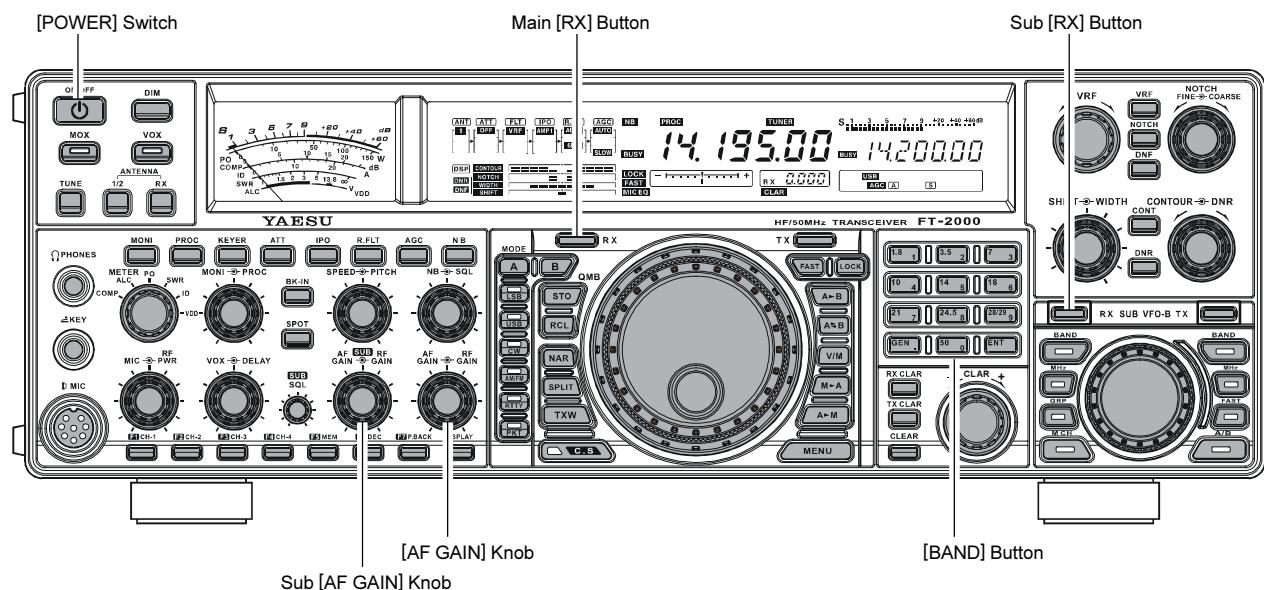

1. Plug the AC cable back in, and set the rear-panel [POWER] switch to "I."
2. Press and hold in the front-panel [POWER] switch for one second to turn the transceiver on.
3. The transceiver will start up on 7.000.00 MHz LSB, and normal operation may begin.

NOTE:

To turn power off, press and hold in the front panel [POWER] switch for one second.

4. Rotate the [AF GAIN] knob to set a comfortable audio level on incoming signals or noise. Clockwise rotation of the [AF GAIN] knob increases the volume level.

NOTE:

When using headphones, start by rotating the [AF GAIN] knob counter-clockwise, then bring the volume level up after you put the headphones on. This will minimize the chance of damage to your hearing caused by an unexpectedly-high audio level.

5. Press the Main [RX] button to engage the Main (VFO-A) receiver; the imbedded LED will glow Green.

ADVICE:

- If you press the Main [RX] button when the imbedded LED is already glowing Green, the LED will now blink on and off; this indicates that the Main (VFO-A) receiver is temporarily muted. Just press the Main [RX] button once more to restore Main (VFO-A) receiver operation.

- Press the Sub [RX] button to engage Dual Reception (using the Sub (VFO-B) receiver in addition to the Main (VFO-A) receiver). When you press the Sub [RX] button, its imbedded LED will glow green; pressing this button once more will turn off the Sub (VFO-B) receiver, and the imbedded LED will go dark. Use the Sub receiver's Sub [AF GAIN] knob to adjust the Sub (VFO-B) receiver volume level.

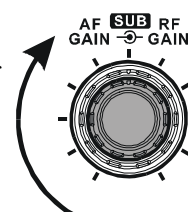
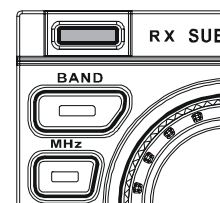

7. Press the [BAND] button corresponding to the Amateur band on which you wish to begin operation.

ADVICE:

- One-touch selection of each Amateur band between 1.8 and 50 MHz is provided.
- The FT-2000 utilizes a triple band-stack VFO selection technique, which permits you to store up to three favorite frequencies and modes onto each band's VFO register. For example, you may store one frequency each on 14 MHz CW, RTTY, and USB, then recall these VFOs by successive, momentary presses of the [14] MHz band button. Each Amateur band button may similarly have up to three frequency/mode settings applied.

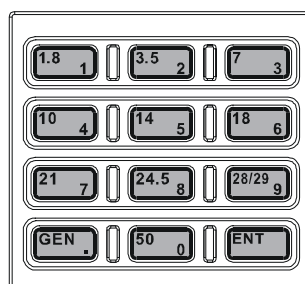

BASIC OPERATION: RECEIVING ON AMATEUR BANDS

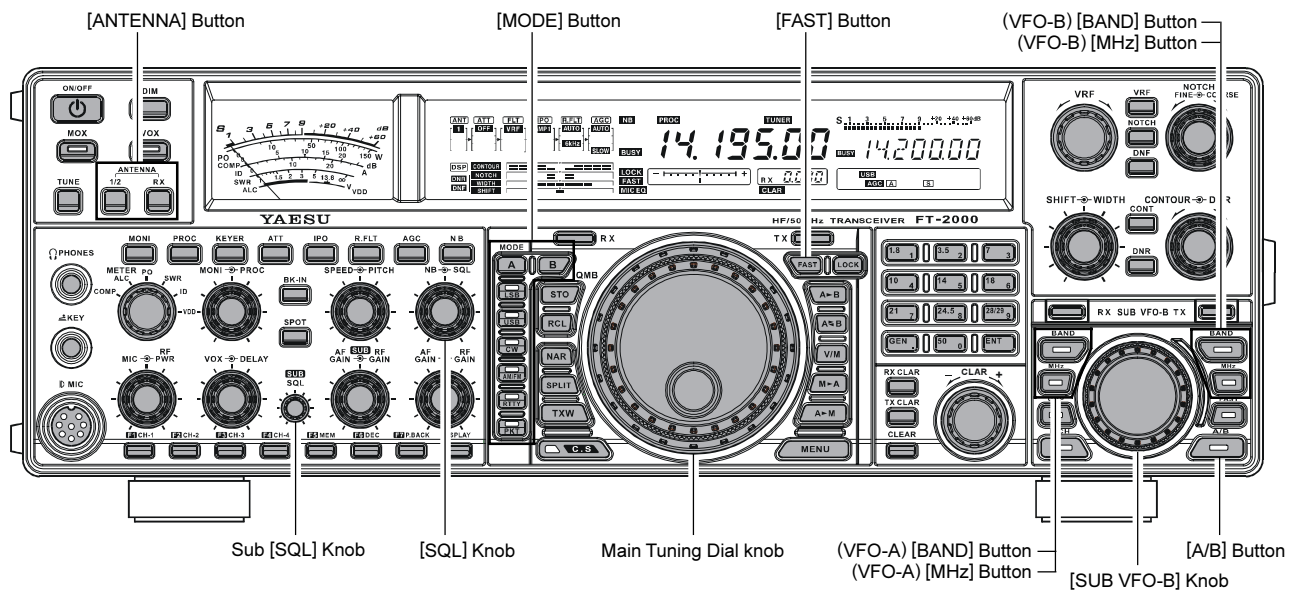

□ If you press the (VFO-A) **[BAND]** button, the **[SUB VFO-B]** knob may be used as a band selection knob. If you press the (VFO-A) **[MHz]** button, rotation of the **[SUB VFO-B]** knob allows frequency navigation in 1 MHz steps. Depending on the setting of the (VFO-A) **[BAND]**, (VFO-A) **[MHz]**, and **[A/B]** buttons, the function of the **[SUB VFO-B]** knob will change.

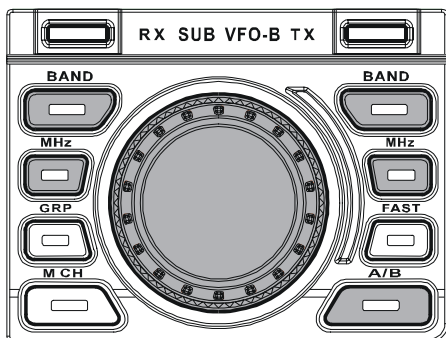

8. Press the **[ANTENNA 1/2]** button to select the appropriate antenna for the band in use; alternatively, if one is connected, you may also press the **[ANTENNA RX]** antenna selection button. Two TX/RX antennas may be connected, or one RX-only antenna.

ADVICE:

Once you have made your antenna selection, that antenna is “remembered” by the microprocessor in conjunction with the VFO register (frequency and mode) in use when you chose that particular antenna.

9. Press the appropriate **[MODE]** button to select the desired operating mode.

ADVICE:

- By convention in the Amateur bands, LSB is used on the 7 MHz and lower bands (with the exception of 60 meters), while USB is utilized on the 14 MHz and higher bands.
- When changing modes from SSB to CW, you will observe a frequency shift on the display. This shift represents the BFO offset between the “zero beat” frequency and the audible CW pitch (tone) you can hear (the pitch is programmed by the **[PITCH]** knob), even though the actual tone that you hear is not changing. If you do not want this frequency shift to appear when changing modes from (for example) USB to CW, use the Menu item “061 A1A FRQDISP,” described on page 118.

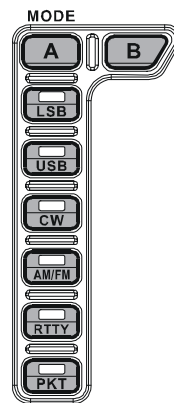

- When operating on the FM mode, rotate the **[SQL]** (Squelch) knob clockwise just to the point where the background noise is just silenced. This is the point of maximum sensitivity to weak signals. Excessive advancement of the **[SQL]** knob will degrade the ability of the receiver to detect weak signals. Adjustment of the Sub band (VFO-B) Squelch is accomplished using the Sub **[SQL]** knob.

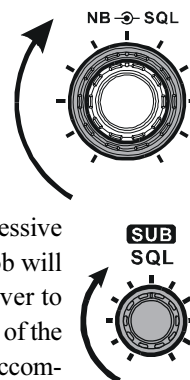

BASIC OPERATION: RECEIVING ON AMATEUR BANDS

10. Rotate the Main Tuning Dial knob to tune around the band, and begin normal operation.

ADVICE:

- Clockwise rotation of the Main Tuning Dial knob increases the operating frequency, one “step” of the synthesizer at a time; similarly, counter-clockwise rotation of the Main Tuning Dial knob will decrease the frequency.

Two steps, one “normal” and one “fast,” are available on each operating mode. Pressing the **[FAST]** button engages the “Fast” tuning selection.

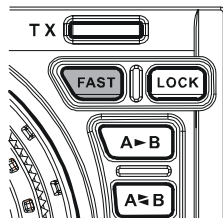

- It is possible to separate the frequency change over one dial rotation, only while operating solely on the CW mode, using the Menu items “116 tun DIALSTP,” and “117 tun CW FINE.” See page 123.

- If you want to navigate quickly, so as to effect rapid frequency change, there are several techniques available:

- Direct keyboard entry of the frequency (see page 49).
- Use the **[SUB VFO-B]** knob to tune in 1 MHz steps (see page 49).
- Use the microphone’s **[UP]/[DWN]** scanning keys, if your microphone is so equipped (see page 49).

MAIN TUNING DIAL KNOB TUNING RATE

OPERATING MODE	1 STEP	1 DIAL ROTATION
LSB, USB, CW, RTTY, PKT(LSB)	10Hz [100Hz]	10kHz [100kHz]
AM, FM, PKT(FM)	100Hz [1kHz]	100kHz [1MHz]

[] : **[FAST]** switch set to “ON”

BASIC OPERATION: RECEIVING ON AMATEUR BANDS

OPERATION ON 60-METER (5 MHz) BAND (U.S. VERSION ONLY)

The **FT-2000** includes the capability for transmission and reception on the five spot frequencies assigned to the Amateur Service in the United States. To operate on the 5 MHz band:

1. Press the **[V/M]** button once to enter the “Memory” mode (a memory channel number “USx” will appear on the Multi-Display Window in the display).
2. Press the **[M CH]** button. The LED imbedded in the button will glow red to signify that rotation of the **[SUB VFO-B]** knob will allow selection the memory channel.

ADVICE:

- If the memory channel selection seems not to be operating, check see if the orange lamp to the right of the **[SUB VFO-B]** knob is illuminated. If so, pressing the **[A/B]** button will cause the orange lamp to the right of the **[SUB VFO-B]** knob to go out. Now, press the **[M CH]** button to begin memory channel selection.
3. Memory channels “US1” through “US5” are pre-programmed, at the factory, with the permitted frequencies in the 5 MHz band, and the USB mode is automatically selected on these channels.
 4. To exit from 60-meter operation and return to the VFO mode, just press the **[V/M]** button.

NOTE:

The frequencies and operating mode for 5 MHz band operation are both fixed, and may not be changed.

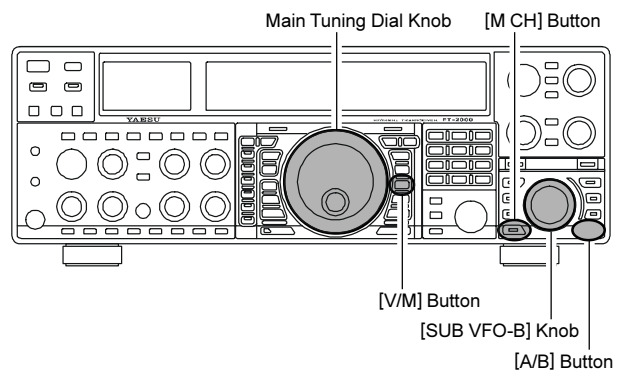

BASIC OPERATION: RECEIVING ON AMATEUR BANDS

CLAR (CLARIFIER) OPERATION ON MAIN (VFO-A)

The [TX CLAR], [RX CLAR], [CLEAR] buttons and [SUB VFO-B] knob are used to offset either the receive, transmit, or both frequencies from their settings on the Main band (VFO-A) frequency (the Clarifier does not affect the Sub band (VFO-B), however). The four small numbers on the Multi-Display Window show the current Clarifier offset. The Clarifier controls on the **FT-2000** are designed to allow you to preset an offset (up to ± 9.990 kHz) without actually retuning, and then to activate it via the Clarifier's [RX CLAR] and [TX CLAR] buttons. This feature is ideal for following a drifting station, or for setting small frequency offsets sometimes utilized in DX "Split" work.

Here is the technique for utilizing the Clarifier:

1. Press the [RX CLAR] button. In the Multi-Display Window, the "RX" notation will appear, and the programmed offset will be applied to the receive frequency.
2. Rotation of the [CLAR] knob will allow you to modify your initial offset on the fly. Offsets of up to ± 9.990 kHz may be set using the Clarifier.

To cancel Clarifier operation, press the [RX CLAR] button. The "RX" notation will disappear from the display.

ADVICE:

Turning the Clarifier Off simply cancels the application of the programmed offset from the receive and/or transmit frequencies. To clear out the programmed Clarifier offset altogether, and reset it to "zero," press the [CLEAR] button. The programmed offset is displayed in the small multi-channel window of the frequency display.

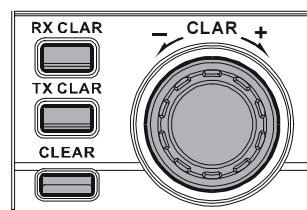
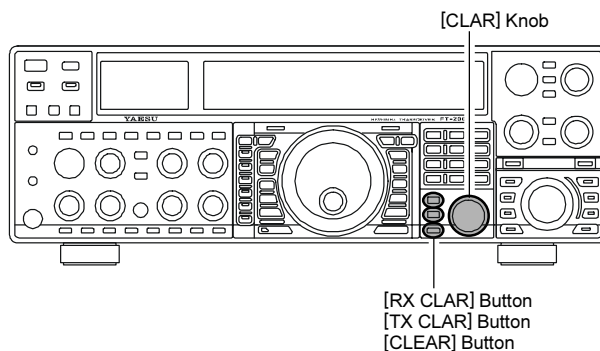

TXCLAR

Without changing the receive frequency, you may alternatively apply the Clarifier offset to the transmit frequency (typically, for "split" DX pile-ups). See page 75 for details.

The Tuning Offset Indicator provides a graphical representation of the Clarifier offset.

On CW, the Tuning Offset Indicator is used for CW Center Tuning, instead of Clarifier Offset, as the transceiver is configured at the factory. If you wish to change this, so that the Clarifier Offset is also displayed on CW, use the following procedure:

1. Press the [MENU] button to enter the Menu mode.
2. Rotate the Main Tuning Dial knob to select Menu item "D10 diSP BAR SEL."
3. Rotate the [SUB VFO-B] knob to select "CLAR (Clarifier)" (replacing the default "C-tn (CW TUNING)") selection).
4. Press and hold in the [MENU] button for two seconds to save the new setting and exit to normal operation.

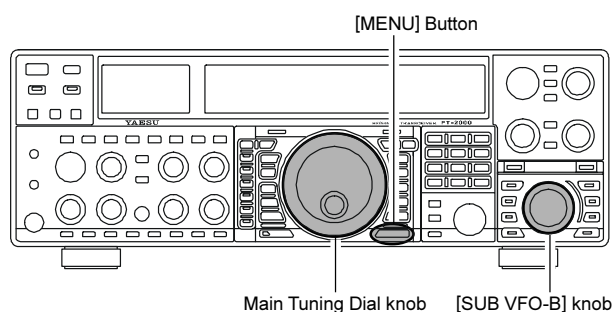
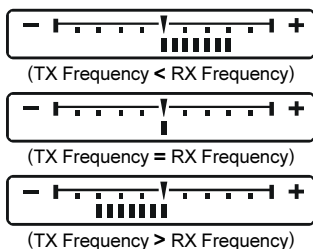

BASIC OPERATION: RECEIVING ON AMATEUR BANDS

LOCK

You may lock the setting of the Main Tuning Dial knob, to prevent accidental frequency change.

To lock out the Main Tuning Dial knob, just press the **[LOCK]** button that is located to the right of the Dial. To unlock the Dial setting, and restore normal tuning, just press the **[LOCK]** button once more.

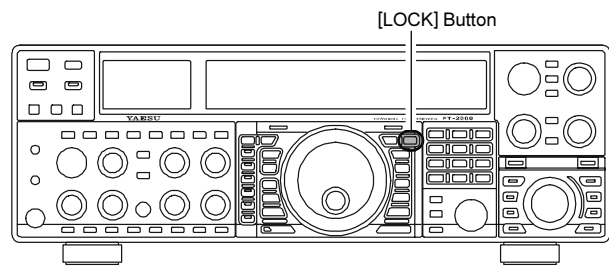
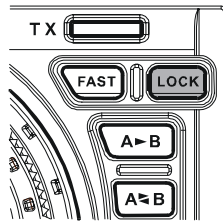

DIM

The illumination level of the analog meter and frequency display may be reduced, if you are using the transceiver in a dark environment where high brightness is not desired.

To reduce the illumination level, press the **[DIM]** button, located to the left of the analog meter. To restore full brightness, press the **[DIM]** button once more.

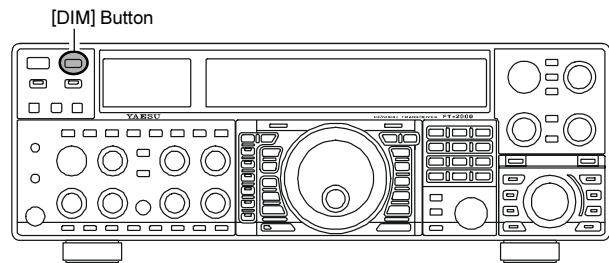
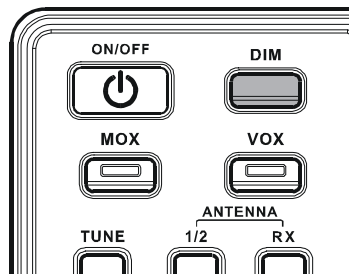

You may also customize the amount of brightness reduction engaged by the pressing of the **[DIM]** button, and may use different brightness levels for different front panel areas. Menu item "008 diSP DIM MTR" adjusts the brightness level of the analog meter; while menu item "009 diSP DIM VFD" sets the brightness levels of the frequency display (these settings are effective only when the **[DIM]** button is pressed).

CONVENIENCE FEATURES

DUAL RECEIVE

The **FT-2000** is capable of simultaneous reception on the *same amateur band*, using the Main (VFO-A) and Sub (VFO-B) receivers, in what is called the Dual Receive mode. Especially useful for DX work, here is the operating procedure for Dual Receive operation.

1. While receiving on the Main band (VFO-A), engage the Sub (VFO-B) receiver by pressing the Sub **[RX]** button, located to the upper left of the **[SUB VFO-B]** knob. You will now be receiving on the two frequencies shown on the frequency display.
2. Adjusting the volume:
To adjust the Main (VFO-A) audio level, rotate the Main **[AF GAIN]** knob. To adjust the Sub (VFO-B) audio level, rotate the Sub **[AF GAIN]** knob. In both cases, clockwise rotation of the knob will increase the volume level.
3. Press the **[B]** button. Within five seconds of pressing the **[B]** button, while the orange LED is blinking, you may now change the operating mode for the Sub (VFO-B) band by pressing the appropriate Mode selection button.
4. Having pressed the **[B]** button in the previous step, you may also press the **[BAND]** buttons to select the operating band on which you want to set up the Sub (VFO-B) receiver.
5. Rotate the Main Tuning Dial knob to adjust the Main (VFO-A) frequency, and rotate the **[SUB VFO-B]** knob to adjust the Sub (VFO-B) frequency.
6. To cancel Dual Receive operation, and receive just on the Main (VFO-A) receiver, press the Sub **[RX]** button; the imbedded green LED will go out, and monoband operation on the Main (VFO-A) receiver will resume.

NOTE:

Please remember that, while the **[B]** mode button is blinking (for five seconds), any mode or band changes will still be applied to the Sub band (VFO-B), whether or not Dual Receive is engaged.

QUICK POINT:

By convention in the Amateur bands, LSB is used on the 7 MHz and lower bands (with the exception of 60 meters), while USB is utilized on the 14 MHz and higher bands.

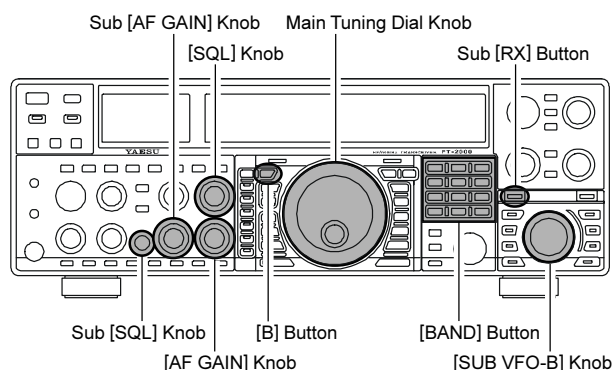

ADVICE:

- When operating in Dual Receive, the manner in which the audio is fed to the left and right sides of your headphones (Stereo, Monaural, or Mixed) may be configured using Menu item "089 rout HEADPHN" (see page 121).
- When changing modes from SSB to CW, you will observe a frequency shift on the display. This shift represents the BFO offset between the "zero beat" frequency and the audible CW pitch (tone) you can hear (the pitch is programmed by the **[PITCH]** knob), even though the actual tone that you hear is not changing. If you do not want this frequency shift to appear when changing modes from (for example) USB to CW, use the Menu item "061 A1A FRQDISP," described on page 118.
- When operating on the FM mode on the Sub band (VFO-B), rotate the Sub **[SQL]** knob clockwise just to the point where the background noise is just silenced. This is the point of maximum sensitivity to weak signals. Excessive advancement of the Sub **[SQL]** knob will degrade the ability of the receiver to detect weak signals. Adjustment of the Main band (VFO-A) Squelch is accomplished using the Main **[SQL]** knob.
- The frequency ranges of the various fixed bandpass filters are shown in the chart below. You may operate on Dual Receive with both receivers set within the same range, even if they are not on the same Amateur band (for example, the 14 and 18 MHz, or 21 and 24.9 MHz bands). Of course, a suitable multiband antenna is required.

RF BPF FREQUENCY DIVISION
0.03000 MHz ~ 0.49999 MHz
0.50000 MHz ~ 1.69999 MHz
1.70000 MHz ~ 2.49999 MHz
2.50000 MHz ~ 3.39999 MHz
3.40000 MHz ~ 4.69999 MHz
4.70000 MHz ~ 6.89999 MHz
6.90000 MHz ~ 9.89999 MHz
9.90000 MHz ~ 13.89999 MHz
13.90000 MHz ~ 20.89999 MHz
20.90000 MHz ~ 30.09999 MHz
30.10000 MHz ~ 44.99999 MHz
45.99999 MHz ~ 59.99999 MHz

DUAL RECEIVE

Using Headphones for Dual Receive

To take advantage of dual reception, you will want to connect stereo headphones to the **PHONES** jack. Like the **AF GAIN** control, headphone audio mixing can also be configured as desired from Menu item “089 rout HEADPHN.” Three audio mixing schemes are selectable as follows:

- SEP: Audio from the Main band (VFO-A) receiver is heard only in the left ear, and Sub band (VFO-B) receiver audio solely in the right ear.
- Con1: Audio from both Main band (VFO-A) and Sub band (VFO-B) receivers can be heard in both ears, but Sub band (VFO-B) audio is attenuated in the left ear and Main band (VFO-A) audio is attenuated in the right ear.
- Con2: Audio from both Main band (VFO-A) and Sub band (VFO-B) receivers are combined and heard equally in both ears “Monaural” mode).

Sideband Diversity Reception

Here you receive a single AM signal through the two receivers, each receiving the opposite sideband. Skywave-propagated signals often show phase distortion in this mode, but it gives you a view of the entire passband, from which you can then select the best sideband for listening (or for SWL Dx’ing, you may want to listen to both sidebands at the same time, to get the best copy). On groundwave signals, where the phase of the sidebands is likely to be the same, there is an interesting sense of depth to the signal.

To tune in a signal using this mode, you should have stereo headphones connected to the front panel **PHONES** jack.

- Set the Main band (VFO-A) to either LSB or USB mode, and tune for zero beat on the desired signal.
- Press the [**A▶B**] button to copy this mode and frequency into the Sub band (VFO-B), then press the mode button to select the opposite sideband for the Main band (VFO-A).
- If using headphones, set the headphone mixing scheme to the “Con1” mode via the Menu item “089 rout HEADPHN,” and activate dual reception.
- Adjust the [**AF GAIN**] knob(s) to balance the volume of the two receivers.
- If interference is present on one of the channels, you may have to turn its [**AF GAIN**] knob to suppress that channel (or press the green [**RX**] LED/button to disable the receiver with the sideband experiencing interference). Otherwise, try changing the headphone audio mixing scheme to “Con2” or “SEP” in the Menu item “089 rout HEADPHN,” for different effects (or try settings with similar effects on your external amplifier). Although you don’t get the “stereophonic” effect in the monaural mode, the two signals are still mixed, offering the potential for much better copy than in regular AM or even single-sideband ECSS modes.

CONVENIENCE FEATURES

DUAL RECEIVE

Bandwidth Diversity Reception

This mode involves receiving the same signal through two different bandpass filters. The frequency and mode of both the Main band (VFO-A) and Sub band (VFO-B) are the same. The Main band (VFO-A) can be set up for a wide bandpass, using the [WIDTH] knobs, and the Sub band (VFO-B) for a narrow bandpass, resulting in a spatial perception of the channel. Although any mode (except FM) can be used, CW offers the widest array of choices, and perhaps the most startling effects on crowded channels.

Stereo headphones or an external stereo speaker are recommended for this mode. To set up the transceiver for bandwidth diversity reception:

- Select the desired mode on the Main band (VFO-A).
- Tune to the signal of interest.
- Press the [A►B] button to copy this mode and frequency into the Sub band (VFO-B).
- If using headphones, set the headphone mixing scheme to the “Con1” mode via the Menu item “089 rout HEADPHN,” and activate dual reception.
- Adjust the [AF GAIN] knob(s) to balance the volume of the two receivers.
- Now try manipulating the [SHIFT] and [WIDTH] knobs to observe the interesting effects of bandwidth diversity.

P.BACK (AUDIO PLAYBACK) FROM MAIN (VFO-A) RECEIVER

Once engaged by the operator, the **FT-2000** begins the automatic recording of the last 15 seconds of incoming receiver audio on the Main band (VFO-A). This capability is especially useful for confirming a callsign that may have been difficult to copy due to noise or QRM, etc.

Recording

Press and hold in the **[F7(P.BACK)]** button for two seconds to initiate recording; the “**REC**” icon will appear in the display to confirm that recording is in progress. The recorder will store up to 15 seconds of the Main band (VFO-A) received audio, and will retain the most-recent 15 seconds of audio on a running basis.

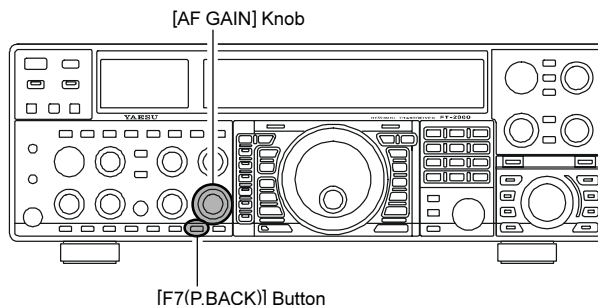
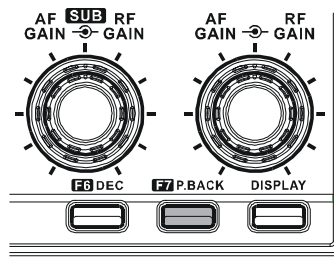

Pressing the **[F7(P.BACK)]** button once more will halt the recording, and the “**REC**” icon will go out.

NOTE:

When the transceiver is turned off, the contents of the recording memory will be erased!

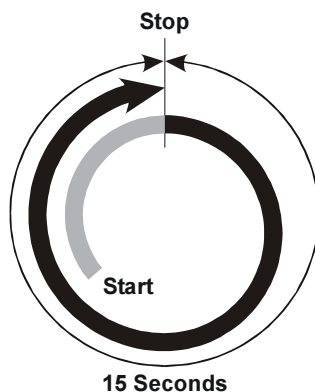

Playback

Press the **[F7(P.BACK)]** button *momentarily*, after recording has been halted, to begin playback of the recorded audio; the “**PLAY**” icon will appear in the display to confirm that playback is in progress. The last 15 seconds of audio will be heard in the speaker or headphones. If you do not intervene, the entire 15 seconds will be played back endlessly. To halt playback at any time, just press the **[F7(P.BACK)]** button momentarily again. The next time you press the **[F7(P.BACK)]** button, it will pick up the playback where you left off.

Advice

You may adjust the playback level of the recording by the main **[AF GAIN]** knob

P.BACK feature from the optional FH-2 Remote Control Keypad

The **[P/B]** key of the optional **FH-2** Remote Control Keypad can also serve as a remote-control recording/playback switch. Operation is described below.

Recording

Press and hold in the **FH-2's [P/B]** key for two seconds to initiate recording.

The “**REC**” icon will appear in the display to confirm that recording is in progress.

Press the **FH-2's [P/B]** key momentarily to halt recording; the “**REC**” icon will go out.

You may also press the front panel's **[F7(P.BACK)]** button (momentarily) to halt recording, as well.

When the transceiver is turned off, the contents of the recording memory will be erased.

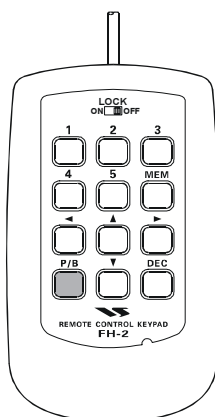

Playback

Press the **FH-2's [P/B]** key *momentarily*, after recording has been halted, to begin playback of the recorded audio; the “**PLAY**” icon will appear in the display to confirm that playback is in progress.. The last 15 seconds of audio will be heard in the speaker or headphones. If you do not intervene, the entire 15 seconds will be played back endlessly. To halt playback at any time, just press the **[P/B]** key momentarily again. The next time you press the **[P/B]** key, it will pick up the playback where you left off. You may also press the front panel's **[F7(P.BACK)]** button (momentarily) to play back the recorded audio, as well.

Advice

You may adjust the playback level of the recording by the main **[AF GAIN]** knob

CONVENIENCE FEATURES

“MY BANDS” OPERATION

When operating on an Amateur Band, it is possible to use the [BAND] buttons to engage the use of the [SUB VFO-B] knob for Amateur band selection. The “My Bands” feature allows you to select several Amateur bands, and make *only* those bands available for selection via the [SUB VFO-B] knob.

This feature can be *very* useful in a contest, where the 10/18/24 MHz band are not used, or if you do not have antennas for some bands.

“My Bands” Setup

1. Press the [MENU] button to engage the Menu mode.
2. Rotate the Main Tuning Dial knob to select Menu item “122 tun MY BAND.”
3. Rotate the [SUB VFO-B] knob to choose a band that you wish to *skip* (omit) from the band-selection loop (when using the [SUB VFO-B] knob for band selection). The available choices are 1.8/3.5/5/7/10/14/18/21/24/28/50/GE (General Band)/AU (Transverter).
4. Press the [ENT] button to set the omission command to ON. The “E” (Enable) notation at the right of the band notation will change to “d” (disable).
5. Repeat steps 3 and 4 to select/deselect as many bands as you like.

NOTE:

The “ON” command sets the selected band to be *skipped*, while the “OFF” command sets the selected band to be *included* in the band-selection list. Return the “d” notation to “E” to restore operation on a previously-deleted band.

6. Press and hold in the [MENU] button for two seconds to lock in the new configuration and exit to normal operation.

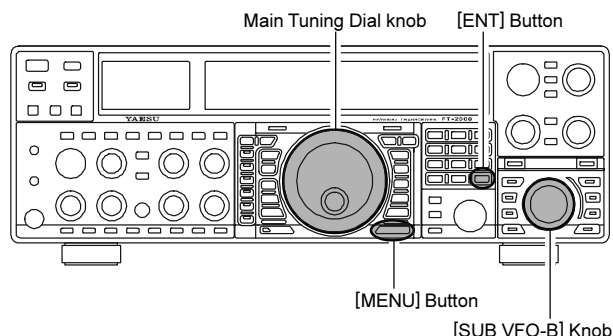

ADVICE:

The “My Band” feature affects both the Main (VFO-A) and Sub (VFO-B) bands.

“My Band” Operation

1. Press the (VFO-A) [BAND] button; the imbedded LED will glow Red, if you operate the “My Band” feature on the Main band (VFO-A).

ADVICE:

If the “My Band” feature on the Main band (VFO-A) seems not to be operating, check see if the orange lamp to the right of the [SUB VFO-B] knob is illuminated. If so, pressing the [A/B] key will cause the orange lamp to the right of the [SUB VFO-B] knob to go out. Now, press the (VFO-A) [BAND] button to begin “My Band” feature.

2. Press the (VFO-B) [BAND] button; the imbedded LED will glow Orange, if you operate the “My Band” feature on the Sub band (VFO-B).
3. Rotate the [SUB VFO-B] knob to choose the Amateur band on which you wish to operate. Only those Amateur bands that have not been skipped will appear as you scroll through the bands.

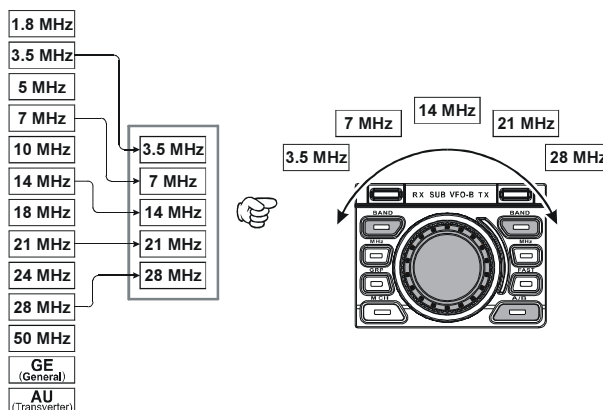
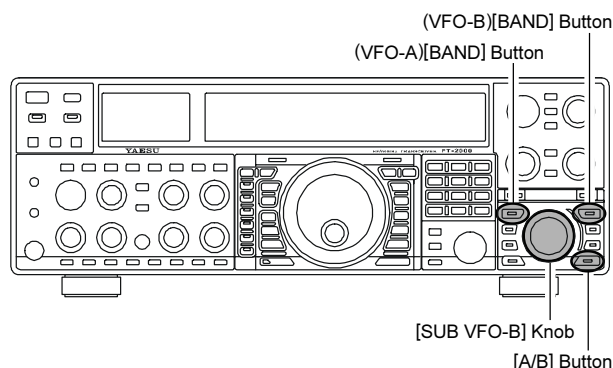

BAND STACK OPERATION

The **FT-2000** utilizes a triple band-stack VFO selection technique, that permits you to store up to three favorite frequencies and modes onto each band's VFO register. For example, you may store one frequency each on 14 MHz CW, RTTY, and USB, then recall these VFOs by successive, momentary presses of the **[14]** MHz band button. Each Amateur band key may similarly have up to three frequency/mode settings applied. Both the Main (VFO-A) and Sub (VFO-B) systems have their own, independent, band stacks.

A typical setup, for the 14 MHz band, might be arranged like this:

1. Program 14.025 MHz, CW Mode, then press the **[14]** MHz band button;
2. Program 14.080 MHz, RTTY Mode, then press the **[14]** MHz band button;
3. Program 14.195 MHz, SSB Mode, then press the **[14]** MHz band button.

With this configuration, successive momentary presses of the **[14]** MHz band button will allow you to toggle sequentially through these three VFOs.

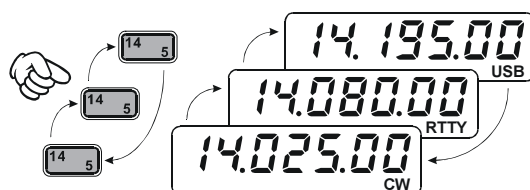
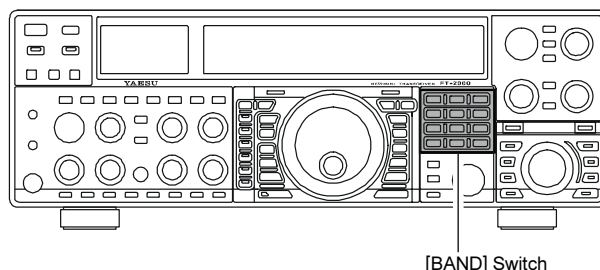

C.S (CUSTOM SWITCH)

An often-used Menu mode selection may be brought out to the front panel's **[C.S]** button.

C.S Setup

1. Press the **[MENU]** button to engage the Menu mode; the Menu list will appear on the display.
2. Rotate the Main Tuning Dial knob to select the Menu item you want to be able to access via the **[C.S]** button.
3. Press and hold in the **[C.S]** button for two seconds to lock in your selection.
4. Press and hold in the **[MENU]** button for two seconds to save the new configuration and exit to normal operation.

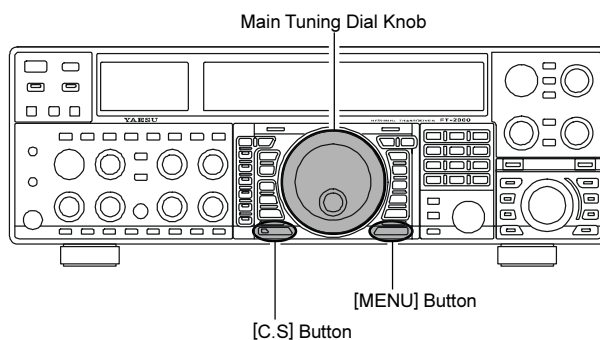

Menu Selection Recall via **[C.S]** button

Press the **[C.S]** button.

The programmed Menu item will appear on the display. You may now rotate the **[SUB VFO-B]** knob to change the setting of this menu item. Press the **[MENU]** button for two seconds, when you are done, to save the new configuration and exit to normal operation.

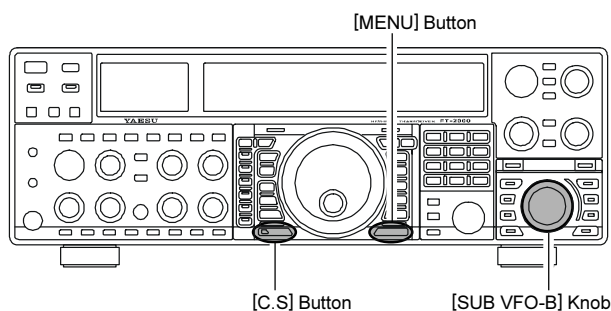

CONVENIENCE FEATURES

ROTATOR CONTROL FUNCTIONS

When using a YAESU model **G-800DXA**, **G-1000DXA**, or **G-2800DXA** rotator (not supplied), it is possible to control it from the front panel of the **FT-2000**.

- 1 Press and hold in the **[ENT]** button (one of the **[BAND]** button) for two seconds. The frequency display area will change over to the “Rotator Control” configuration.
- 2 Press either the **[F2(CH-2)]** button or the **[F3(CH-3)]** button to rotate the antenna. Pressing the **[F2(CH-2)]** button will cause rotation to the left (counter-clockwise), while pressing the **[F3(CH-3)]** button will cause rotation to the right (clockwise).
- 3 Press the **[F5(MEM)]** button or the **[F6(DEC)]** button to control the speed of rotation. Pressing the **[F5(MEM)]** button will cause slower rotation, while pressing the **[F6(DEC)]** button will speed up rotation. Usually, you will be using the “100%” setting.

When you are through exercising rotator control, press the **[ENT]** button momentarily. The frequency display will return to the main display field.

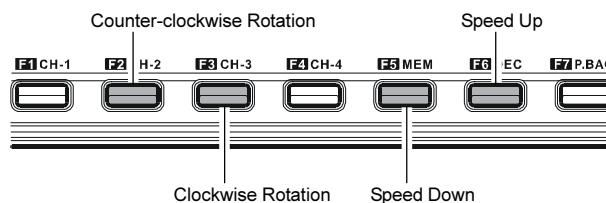
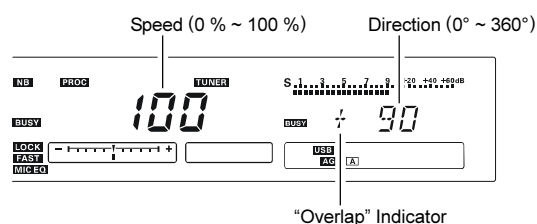
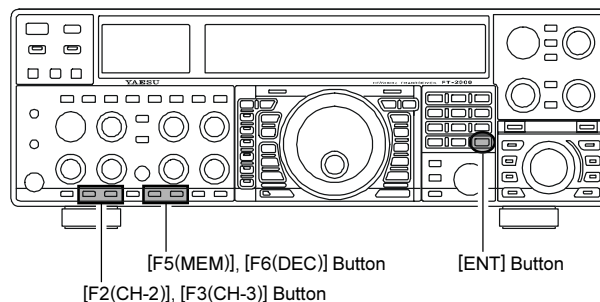

IMPORTANT NOTE

- ❑ Set to match the starting point of your rotator control indicator needle via the Menu item “012 diSP RTR STU.” The default setting is zero (north). If your controller starting point is south, the Menu item “012 diSP RTR STU” must be set to “180°.” If not set properly the **FT-2000** display will not show the correct direction.
- ❑ When the rotator control indicator needle does not indicate the precise antenna direction, adjusts the indicator needle precisely to the antenna direction via the Menu item “013 diSP RTR ADJ.”

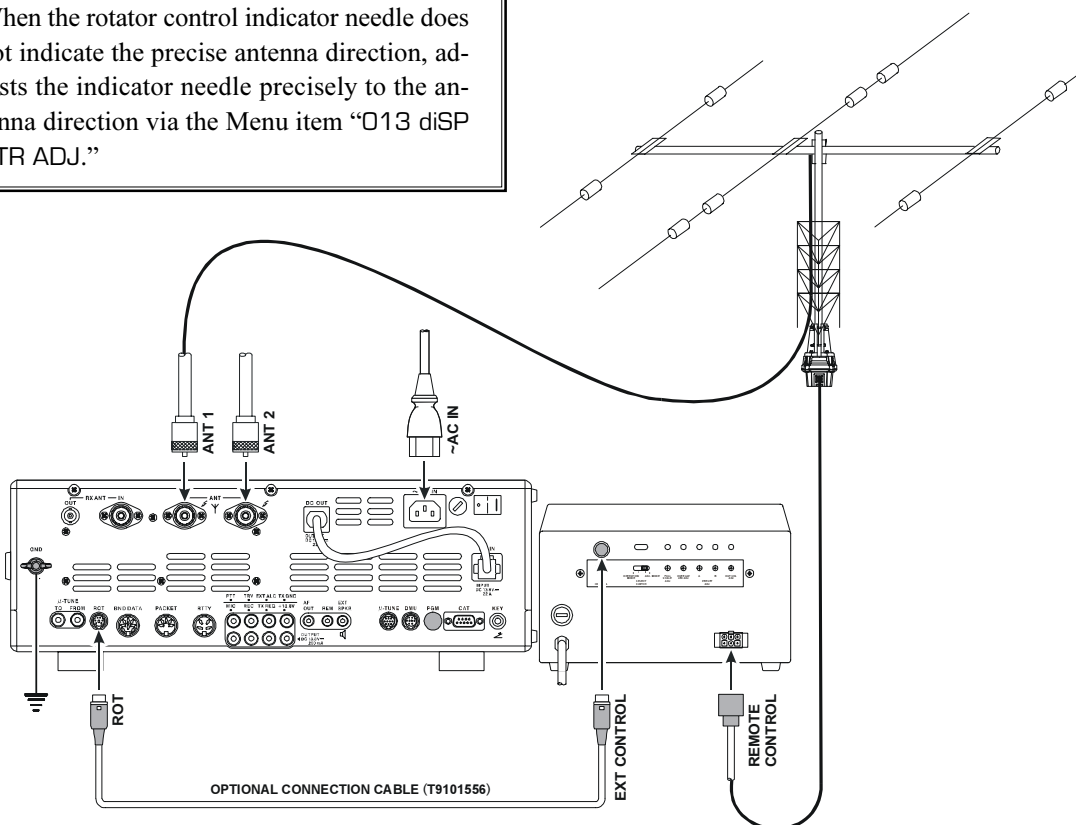

MORE FREQUENCY NAVIGATION TECHNIQUES

Keyboard Frequency Entry

You may enter operating frequencies, for either the Main (VFO-A) or Sub (VFO-B) bands, using the front panel band/frequency selection keys.

Example 1:

Enter 14.250.00 MHz into the Main band (VFO-A):

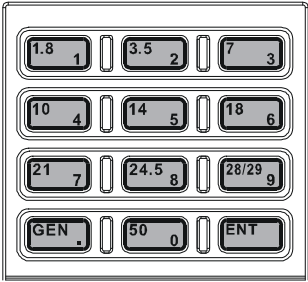
- Press the **[ENT]** button to engage the direct frequency entry process. Now, beginning with the “10 MHz” digit of the frequency (the leftmost digit), we will enter the required digits of the frequency.
 
- Press, in order, the digits of the operating frequency, using the **[BAND]** buttons (which have the frequency-entry digit or decimal point on the right side of the slash bar). In this example, enter **[1.8/1]** → **[10/4]** → **[GEN./.]** → **[3.5/2]** → **[14/5]** → **[50/0]** → **[50/0]** → **[50/0]** → **[50/0]**. The decimal point after the “MHz” portion of the frequency must be entered, but no decimal point is required after the “kHz” portion.
- Press the **[ENT]** button once more. A short “beep” will confirm that the frequency entry was successful, and the new operating frequency will appear on the Main (VFO-A) frequency display fields.

Example 2:

Enter 7.100.000 MHz into the Sub band (VFO-B):

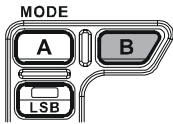
- Press the **[B]** button.
- Within five seconds (blinking the imbedded orange LED) of pressing the **[B]** button, press the **[ENT]** button to engage the direct frequency entry process. Now, beginning with the “10 MHz” digit of the frequency (the leftmost digit), we will enter the required digits of the frequency to be entered into the Sub band (VFO-B) register.
 
- Press, in order, the digits of the operating frequency, using the **[BAND]** buttons (which have the frequency-entry digit or decimal point on the right side of the slash bar). In this example, enter **[21/7]** → **[GEN./.]** → **[1.8/1]** → **[50/0]** → **[50/0]** → **[50/0]** → **[50/0]** → **[50/0]**.
- Press the **[ENT]** button once more. A short “beep” will confirm that the frequency entry was successful, and the new operating frequency will appear on the Sub (VFO-B) frequency display fields.

ADVICE:

If you attempt to enter a frequency outside the operating range of 30 kHz ~ 60 MHz, the microprocessor will ignore the attempt, and you will be returned to your previous operating frequency. If this happens, please try again, taking care not to repeat the error in the frequency entry process.

Using the **[SUB VFO-B]** knob

You may change the Main band (VFO-A) frequency in 1 MHz steps. If you press the (VFO-A) **[BAND]** button, the 1 MHz steps will be applied to the Main band (VFO-A) frequency. The imbedded LED in the (VFO-A) **[BAND]** button will glow Red in the latter case.

When tuning in 1 MHz steps, clockwise rotation of the **[SUB VFO-B]** knob will increase the frequency, while counter-clockwise rotation will decrease the frequency.

Using the UP/DOWN Switches of the Supplied MH-31B8 Hand Microphone

The **[UP]**/**[DWN]** switches on the supplied **MH-31B8** Hand Microphone may also be used for manually scanning upward or downward in frequency, respectively.

The microphone’s **[UP]**/**[DWN]** switches utilize the tuning steps of the Main Tuning Dial knob; moreover, when the microphone’s **[FAST]** key is pressed, the tuning rate increases by a factor of ten, in a manner similar to the effect of the transceiver’s front-panel **[FAST]** button.

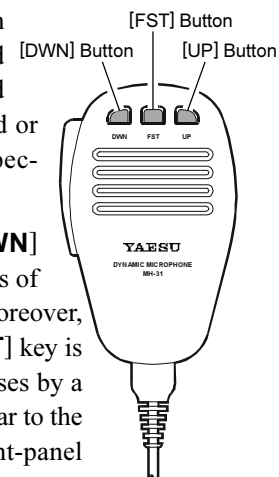

ADVICE:

In the AM and FM modes, you may independently set the tuning steps when using the **[UP]**/**[DWN]** switches. To set new tuning steps, use Menu items “119 tun AM STEP” and “120 tun FM STEP.”

CONVENIENCE FEATURES

RECEIVER OPERATION (FRONT END BLOCK DIAGRAM)

The **FT-2000** includes a wide range of special features to suppress the many types of interference that may be encountered on the HF bands. However, real world interference conditions are constantly changing, so optimum setting of the controls is somewhat of an art, requiring familiarity with the types of interference and the subtle effects of some of the controls. Therefore, the following information is provided as a general guideline for typical situations, and a starting point for your own experimentation.

The **FT-2000**'s interference-fighting circuitry begins in its "RF" stages, and continues throughout the entire receiver section. **FT-2000** allows configuration of the features described below. However, the Sub band (VFO-B) receiver does not have the DSP (Digital Signal Processor) features.

VRF (SEE PAGE 53)

On the 1.9 - 28 MHz Amateur bands, Yaesu's powerful VRF (Variable RF Filter) preselector circuit provides excellent suppression of out-of-band interference, with a passband much narrower than that provided by traditional fixed bandpass filters.

R. FLT (IF Roofing Filters) (SEE PAGE 54)

On the Main (VFO-A) receiver, three automatically-selected Roofing filters, in bandwidths of 15 kHz, 6 kHz, and 3 kHz, are provided in the 69 MHz First IF, right after the first mixer. These filters provide narrow-band selectivity to protect the following IF and DSP stages, and the filters' automatically-selected bandwidths may be manually changed by the operator, if desired, for special operating circumstances.

The Sub (VFO-B) receiver's 40 MHz IF includes a fixed Roofing filter, with a bandwidth of 15 kHz.

CONTOUR Filter (SEE PAGE 55)

The DSP Contour filter is a unique capability on the Main (VFO-A) receiver, providing either nulling or peaking of tunable segments of the receiver passband, so as to suppress interference or excessive frequency components on an incoming signal, or to peak those tunable frequency segments. The amount of nulling/peaking, and the bandwidth over which it is applied, are adjustable via the Menu.

IF SHIFT (SEE PAGE 56)

The passband center frequency response of the IF DSP filtering may be adjusted using this control.

IF WIDTH (SEE PAGE 57)

The width of the IF DSP filtering may be adjusted using this control.

IF NOTCH (SEE PAGE 58)

The IF Notch filter is a high-Q notch filter that can significantly reduce, if not eliminate, an interfering carrier. The Q (sharpness) of the filter may be adjusted using the Menu.

DNR (DIGITAL NOISE REDUCTION) (SEE PAGE 59)

The DSP's Digital Noise Reduction (DNR) feature utilizes sixteen different mathematical algorithms to analyze and suppress different noise profiles encountered on the HF/50 MHz bands. Choose the selection that provides the best noise suppression, which concurrently will allow the signal to rise up out of the noise.

DNF (DIGITAL NOTCH FILTER) (SEE PAGE 59)

When multiple interfering carriers are encountered during reception, the Digital Notch Filter can significantly reduce the level of these signals.

AGC (SEE PAGE 62)

The AGC system is highly adaptable to changing signal and fading characteristics, making reception possible under the most difficult conditions.

SLOPED AGC (SEE PAGE 63)

The Sloped AGC system on the Main (VFO-A) receiver, instead of clamping a fixed upper bound on audio output across a wide range of input signals, actually allows the audio output to rise, very gently, with ever-increasing signal strength. This capability allows you to separate signals, using your brain, according to signal strength in addition to slight frequency differences.

IF Filter Quality Adjustment (SEE PAGE 121)

The "Q" (quality factor) of the IF DSP filters may be adjusted using the Menu.

Variable IF Filter Shape Factor (SEE PAGE 121)

You may adjust the shape factor of the receiver IF DSP filters using the Menu.

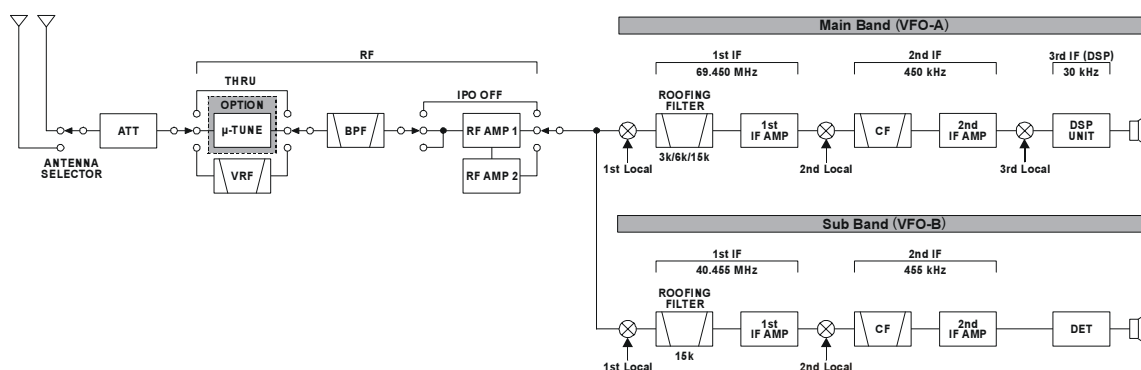

IPO (INTERCEPT POINT OPTIMIZATION)

The IPO feature allows the operator to optimize the characteristics of the receiver front end, depending on the current noise level and the strength of incoming signals.

Press the **[IPO]** button several times to set the desired characteristic of the receiver front end, per the chart below.

AMP1: Amplifies the incoming signal path using a low distortion RF preamplifier (gain: approx. 10 dB).

AMP2: Amplifies incoming signal path using a 2-stage low-distortion RF preamplifier (total gain: approx. 17 dB).

ON: Bypasses the RF preamplifier, yielding direct feed to the first mixer.

The selected receiver RF preamplifier will be indicated in the IPO column of the Receiver Configuration Indicator on the display.

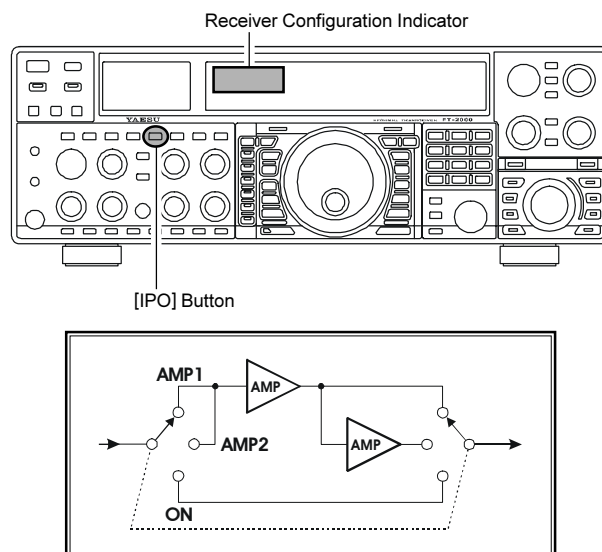
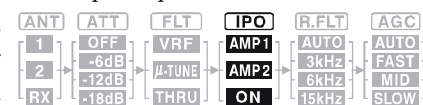

ADVICE:

On the 10 MHz and lower bands, it generally is not necessary to use any preamplifier at all; selecting the “ON” position described above will increase the strong-signal-handling capability of the receiver, and generally will result in more pleasant reception due to reduced noise. If you can hear band noise with the preamplifiers disengaged, then a preamplifier is generally not needed.

ATT

Even with the IPO function on, extremely strong local signals or high noise can still degrade reception. In such situations, you can use the **[ATT]** button to insert 6, 12, or 18-dB of RF attenuation in front of the RF amplifier.

1. Press the **[ATT]** button several times to set the desired attenuation level, per the chart below.

OFF: Attenuator is Off

-6 dB: The incoming signal power is reduced by 6 dB (Signal voltage reduced by 1/2)

-12 dB: The incoming signal power is reduced by 12 dB (Signal voltage reduced by 1/4)

-18 dB: The incoming signal power is reduced by 18 dB (Signal voltage reduced by 1/8)

The selected attenuation level will be indicated in the ATT column of the Receiver Configuration Indicator on the display.

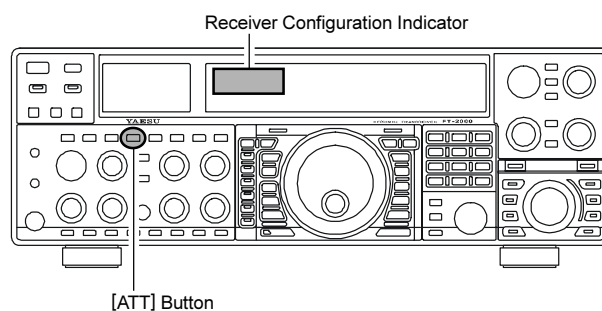
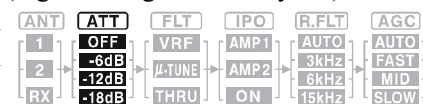

2. To restore full signal strength through the Attenuator circuit area, press the **[ATT]** button to restore the ATT display to the “OFF” position.

ADVICE:

- The Attenuator affects both the Main (VFO-A) and Sub (VFO-B) bands.
- If background noise causes the S-meter to deflect on clear frequencies, press the **[ATT]** button until the S-meter drops to about “S-1.” This setting optimizes the trade-offs between sensitivity, noise, and interference immunity. Also, once you have tuned in a station you want to work, you may want to reduce sensitivity further (or add more attenuation) by pressing the **[ATT]** button to a more setting. This reduces the strength of all signals (and noise) and can make reception more comfortable, important especially during long QSOs. When looking for weak signals on a quiet band, you will want maximum sensitivity, so the IPO should be disabled and the **[ATT]** button should be set to “OFF.” This situation is typical during quiet times on frequencies above 21 MHz, and when using a small or negative-gain receiving antenna on other bands.

CONVENIENCE FEATURES

RF GAIN (SSB/CW/AM MODES)

The RF Gain controls provide manual adjustment of the gain levels for the receiver RF and IF stages, to account for noise and/or signal strength conditions at the moment.

1. The Main [RF GAIN] knob should, initially, be rotated to the fully clockwise position. This is the point of maximum sensitivity, and counter-clockwise rotation will gradually reduce the system gain.
2. The Sub [RF GAIN] knob operates identically to the Main [RF GAIN] knob. The fully clockwise position of the Sub [RF GAIN] knob should always be utilized as a starting point for operation.

ADVICE:

- ❑ As the [RF GAIN] knob is rotated counterclockwise to reduce the gain, the S-meter reading will rise. This indicates that the AGC voltage being applied to the receiver is increasing (which causes a *reduction* in receiver gain).
- ❑ Rotating the [RF GAIN] knob control to the fully counter-clockwise position will essentially disable the receiver, as the gain will be greatly reduced. In this case, as well, the S-meter will appear to be “pegged” against the right edge of the analog S-meter scale.
- ❑ The Sub [RF GAIN] knob operates identically to the Main [RF GAIN] knob. The effects of counter-clockwise rotation of the Sub (VFO-B) receiver’s RF Gain control may be observed visually on the Sub band (VFO-B) S-meter.

QUICK POINT:

- ❑ Reception frequently can be optimized by rotating the [RF GAIN] knob slightly counter-clockwise to the point where the incoming noise level is just about the same as the “stationary” meter needle position as set by the adjustment of the [RF GAIN] knob. This setting ensures that excessive gain is not being utilized, without so much gain reduction that incoming signals cannot be heard.
- ❑ The RF Gain control, along with the IPO and Attenuator features, all affect the system receiver gain in different ways. As a first step in dealing with high noise or a crowded, high-level signal environment, the IPO generally should be the first feature engaged, if the frequency is low enough to allow the preamplifier to be bypassed. Thereafter, the RF Gain and Attenuator features may be employed to provide precise, delicate adjustment of the receiver gain so as to optimize performance fully.

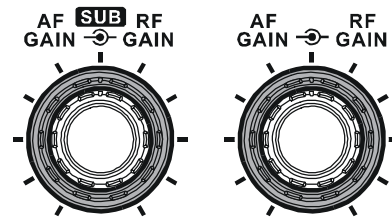
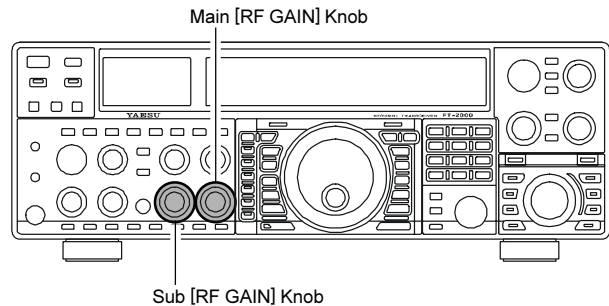

ADVANCED INTERFERENCE-SUPPRESSION FEATURES: RF FRONT END

The **FT-2000** includes an unmatched array of RF selectivity-enhancing features. Please study the material below carefully, so as to understand the various features completely.

USING THE VRF (VARIABLE RF FRONT-END FILTER)

The VRF system is a high-performance RF front-end preselector that has high Q factor and low insertion loss. VRF provides outstanding rejection of out-of-band signals, and can significantly improve reception in tough co-location operations such as a contest or DX-pedition. The **FT-2000**'s VRF system affects the 1.8 - 28 MHz amateur bands only.

1. Press the **[VRF]** button momentarily. The “**VRF**” icon will appear at the FLT column of the Receiver Configuration Indicator on the display, and the VRF system will be engaged, centered on your current Amateur band.
2. You may rotate the **[VRF]** knob to skew the position of the VRF system relative to your operating frequency. Because the VRF system is relatively broad, although still much narrower than the fixed bandpass filter, you may not hear much difference in the background noise or signal quality when you make minor adjustments. However, if you have receiving problems associated by a very strong signal, rotation of the **[VRF]** knob may help reduce the strength of the interfering station, allowing improved reception of the desired signal if overload was degrading reception.

ADVICE:

- You may observe the relative skew of the VRF system in the Tuning Offset Indicator on the display while turning the **[VRF]** knob.
 - After moving the passband of the VRF system manually, you may re-center it on the current Amateur band by pressing and holding in the **[VRF]** button for two seconds.
3. To switch VRF off, press the **[VRF]** button until the “**VRF**” icon shows “**THRU**” in the FLT column of the Receiver Configuration Indicator on the display; this confirms that the VRF circuit has been removed from the incoming received signal path.

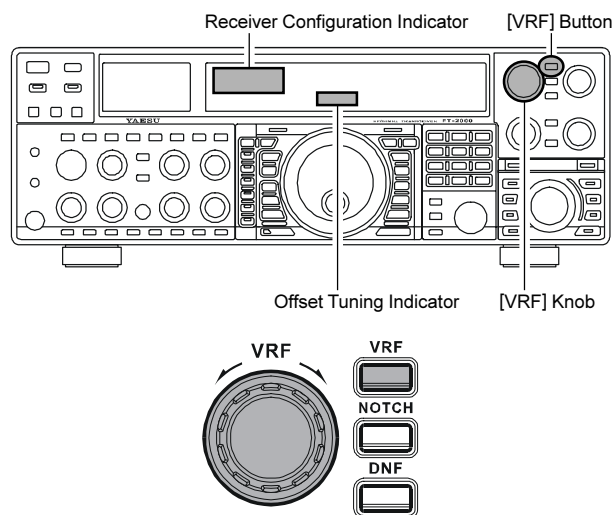

ADVICE:

- The VRF filter affects both the Main (VFO-A) and Sub (VFO-B) bands.
- The VRF Filter operational status will be memorized independently on each VFO in the VFO stack.

QUICK POINT:

The VRF filter, utilizing high-quality coils and capacitors that provide high Q, yields a passband that is approximately 20% to 30% the width of a traditional, fixed bandpass filter. As a result, significantly more “unwanted” signal rejection is provided. Within each Amateur band, the following adjustment steps are provided, if you wish to skew the response in a particular direction so as to enhance interference rejection even more. The actual “sound” of the signal you are listening to will remain unchanged, however.

AMATEUR BAND	VRF ADJUSTMENT STEPS
1.8 MHz	62 steps
3.5 MHz	62 steps
5 MHz	62 steps
7 MHz	62 steps
10 MHz	30 steps
14 MHz	30 steps
18 MHz	20 steps
21 MHz	20 steps
24.5 MHz	20 steps
28 MHz	20 steps

R.FLT (ROOFING FILTERS)

Narrow-band Roofing Filters of 15 kHz, 6 kHz, and 3 kHz bandwidths are provided in the first IF, right after the first mixer. These filters provide protection for the 2nd mixer, DSP, and other circuitry that follow and can dramatically improve reception on a very crowded band (during a contest, etc.). Typically, the AUTO selection mode is satisfactory for most operating situations, but in an extremely crowded phone band you may wish to select, for example, the 3 kHz roofing filter for SSB operation.

Press the **[R.FLT]** button to toggle the Roofing Filter selection.



AUTO → 15 kHz → 6 kHz → 3 kHz → AUTO

ADVICE:

- ❑ The Roofing filter selection affects the Main band (VFO-A) only. The Sub band's (VFO-B) Roofing filter is fixed at a bandwidth of 15 kHz.
- ❑ As you repeatedly press the **[R.FLT]** button, you will observe changes in the notation in the R.FLT column of the Receiver Configuration Indicator on the display, denoting the Roofing Filter currently in use.
- ❑ Typically, this selection will be set to "AUTO."
- ❑ The Roofing Filter selection will be memorized independently on each VFO in the VFO stack.

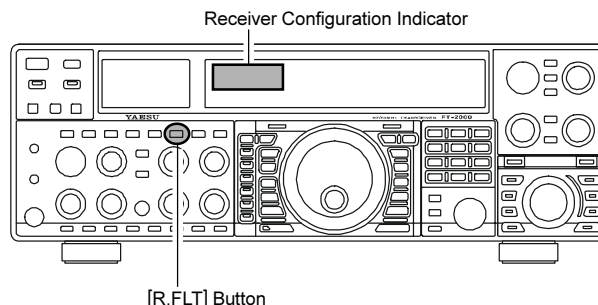
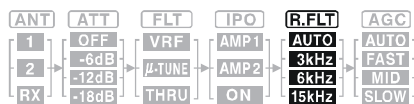

QUICK POINT:

- ❑ The "AUTO" selection of the Roofing Filter is based on the operating mode. However, you may override the automatic selection, if band conditions warrant a different (usually, a tighter) selection.
- ❑ The AUTO mode Roofing Filter selections are shown below:
 - AM/FM/FM-PKT: 15 kHz
 - LSB/USB/PKT: 6 kHz
 - CW/RTTY: 3 kHz
- ❑ When the Roofing filter mode is set to "AUTO" and the Noise Blanker is turned On, the Roofing Filter bandwidth will automatically be set to 15 kHz, as this setting provides the most effective noise blanking. However, you still may override the automatic setting, and select a more narrow Roofing Filter. Noise blanking may be compromised, however, with a tighter Roofing Filter in the line.

TERMINOLOGY:

A "Roofing Filter," as its name implies, places a "Roof" over the receiver's IF system bandwidth. This "Roof" protects the circuitry downstream from the first mixer from interference, just as a roof on a house protects the contents from rain and snow.

CONTOUR CONTROL OPERATION

The Contour filtering system provides a gentle perturbation of the IF filter passband, so as to suppress or enhance certain frequency components, thus enhancing the sound and/or readability of a received signal.

1. Press the **[CONTOUR]** button. The Contour notation will appear in the display to confirm that the Contour filter is engaged.
2. Rotate the **[CONTOUR]** knob to achieve the most natural-sounding audio reproduction on the incoming signal.
3. To cancel Contour tuning, press the **[CONTOUR]** button once more.

ADVICE:

- The Contour filter affects the Main band (VFO-A) only.
- You may observe the graphically-depicted peak position of the CONTOUR Filter in the CONTOUR indicator on the display.

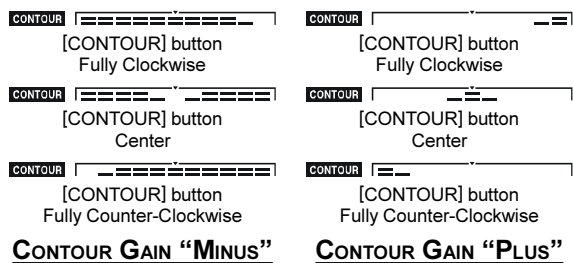

- The Contour filter's level (either nulling or peaking) may be adjusted using Menu item "090 rdSP CNTR LV." The factory default setting is for a null of "-15" (dB).
- The bandwidth over which the Contour filter effect is applied may be adjusted using Menu item "091 rdSP CNTR WL." The factory default setting is "10."
- When the optional **DMU-2000** Data Management Unit is connected, the Audio Scope (on the "Oscilloscope" page) is particularly useful when adjusting the Contour control. Not only can you see the effect of the null/peak of the Contour system, but you also can see the position of the null/peak with respect to frequency components of interest on the incoming signal. You may then observe (on the Audio Scope) the effect of the Contour control while listening to the effect on the signal, and this will help build your intuition on how best to use Contour tuning in the future.

QUICK POINT:

The steep slopes of the DSP filtering can, when adjusted aggressively, impart an unnatural sound to an incoming signal. Oftentimes, though, a narrow bandwidth is not the key to improving copy; the incoming signal itself may have undesirable or excessive frequency components, especially in the low-frequency range around 100-400 Hz. By judicious use of the Contour filter, the "shoulder" of the passband response may be altered, or components removed from within the passband, allowing the desired signal to rise above the background noise and interference in a manner not obtainable with other filtering systems.

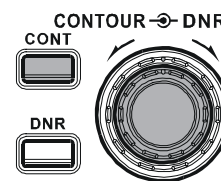
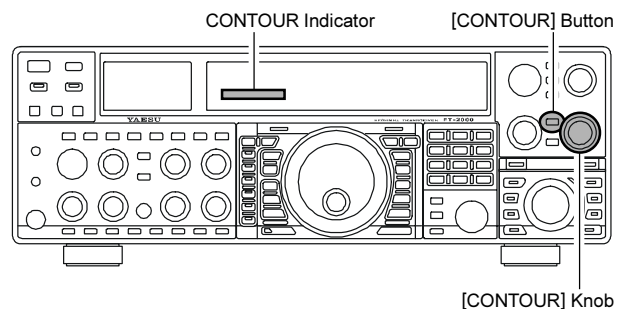

With reference to Figure "B," note the initial position (12 o'clock) of the **[CONTOUR]** knob when the **[CONTOUR]** button is pushed. You may observe the "indentation" in the receiver passband where the Contour filter is placing a low-Q "notch" (per the setting of Menu item "090," referenced above). Counter-clockwise rotation (to the left) of the **[CONTOUR]** knob causes the indentation to move toward a lower frequency within the passband, while clockwise rotation (to the right) causes the indentation to move toward a higher frequency within the passband. By removing interference or unwanted frequency components on the incoming signal, it is possible to make the desired signal rise out of the background noise/interference, enhancing intelligibility.

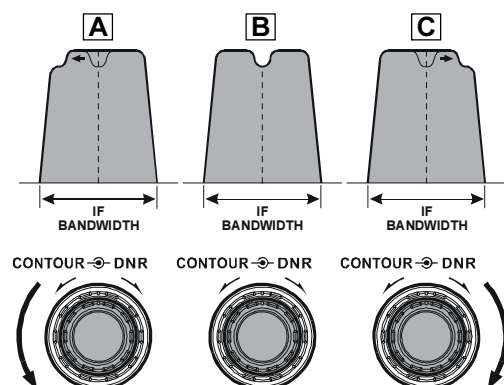

INTERFERENCE REJECTION (SIGNALS WITHIN 3 KHZ)

IF SHIFT OPERATION (SSB/CW/RTTY/PKT/AM MODES)

IF Shift allows you to vary the DSP filter passband higher or lower, without changing the pitch of the incoming signal, so as to reduce or eliminate interference. Because the carrier tuning frequency is not varied, there is no need to re-tune the operating frequency when eliminating the interference. The total passband tuning range for the IF Shift system is ± 1 kHz.

Rotate the [SHIFT] knob to the left or right to reduce the interference.

ADVICE:

- ❑ The [SHIFT] knob affects the Main band (VFO-A) only. However, you may shift the Sub band (VFO-B) filter passband via Menu items "042 S-iF LSB SET" through "049 S-iF PKT-USB."
- ❑ The position of the passband set by the IF Shift can be observed on the display.

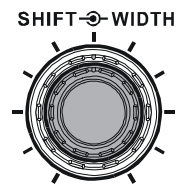
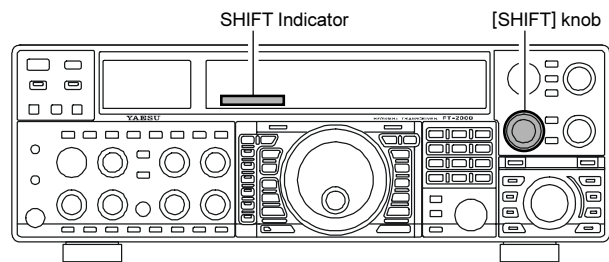

Referring to Figure "A," note the depiction of the IF DSP filter as the thick line, with the [SHIFT] knob in the 12 o'clock position. In Figure "B," an interfering signal has appeared inside the original passband. In Figure "C," you can see the effect of rotating the [SHIFT] knob so as to reduce the interference level by moving the filter passband so that the interference is outside of the passband.

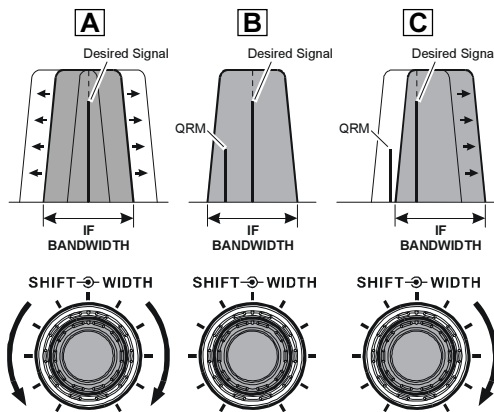

WIDTH (IF DSP BANDWIDTH) TUNING (SSB/CW/RTTY/PKT MODES)

The IF Width tuning system allows you to vary the width of the DSP IF passband, so as to eliminate interference. Moreover, the bandwidth may actually be *expanded* from its default setting, should you wish to enhance incoming signal fidelity when interference on the band is low.

Rotate the [WIDTH] knob to adjust the bandwidth. Counter-clockwise rotation reduces the bandwidth, while clockwise rotation increases the bandwidth.

ADVICE:

- The IF Width affects the Main band (VFO-A) only.
- The bandwidth of the IF can be observed on the display.

CAUTION:

When rotating the [WIDTH] control fully counter-clockwise, the transition between 50 Hz and 25 Hz bandwidth may be accompanied by a “ping” sound, depending on the amount of noise present. This is a normal condition, and you should turn down the volume, when wearing headphones, to minimize the amplitude of this momentary sound.

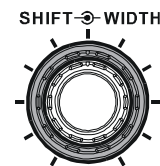
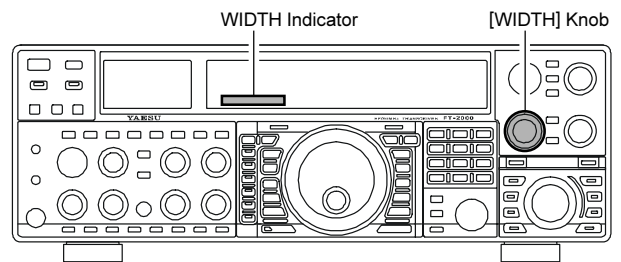

Referring to Figure B, you can see the default bandwidth with the [WIDTH] knob set to the 12 o'clock position.

By rotating the [WIDTH] knob to the left, the bandwidth will narrow (see Figure “A”), while rotation of the [WIDTH] knob to the right, as depicted in Figure “C,” will widen the bandwidth.

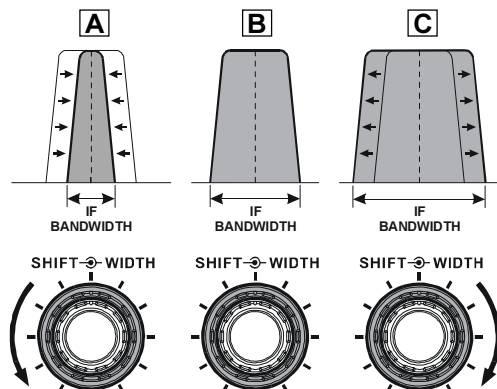

The default bandwidths*, and total bandwidth adjustment range, will vary according to the operating mode:

SSB Mode: 200 Hz ~ 4.0 kHz (2.4 kHz*)

CW Mode: 25 Hz ~ 2.4 kHz (2.4 kHz*)

RTTY/PKT Modes: 25 Hz ~ 2.4 kHz (500 Hz*)

*: bandwidth at 12 o'clock position of [WIDTH] knob.

Using IF Shift and Width Together

The IF Shift and Variable IF Width features together form a very effective interference-fighting filtering system.

For example, in Figure “A” you can see how interference has appeared both on the high and low sides of the desired signal. By rotating the [WIDTH] knob, as shown in Figure “B,” the interference from one side can be eliminated, and by re-positioning the [SHIFT] knob (Figure “C”), the interference on the opposite side can be removed, without re-introducing the interference previously eliminated in Figure “B.”

Advice: For best interference reduction, the Width and Shift features are the primary tools you should use. After narrowing the bandwidth (Width) and/or adjusting the center of the passband (Shift), the Contour control may also yield additional signal-enhancement benefits on the net residual bandwidth. What’s more, the IF Notch Filter (see the next section) may also be utilized, in conjunction with the three other filter systems, to significant advantage.

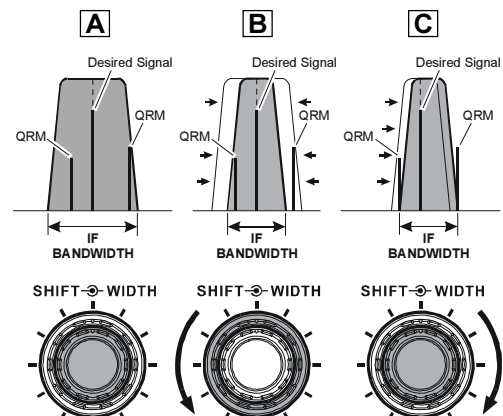

INTERFERENCE REJECTION (SIGNALS WITHIN 3 KHZ)

IF NOTCH FILTER OPERATION (SSB/CW/RTTY/PKT/AM MODES)

The IF Notch filter is a highly-effective system that allows you to slice out an interfering beat note or other carrier signal from inside the receiver passband.

1. Press the **[NOTCH]** button. The Notch characteristic will appear in the display to confirm that the Notch filter is engaged.
2. Initially, rough adjustment of the center frequency of the IF Notch Filter is adjusted using the outer **[COARSE]** knob; thereafter, fine tuning of the Notch frequency is adjusted using the inner **[FINE]** knob.
3. To switch the IF Notch filter off, press the **[NOTCH]** button once more. The Notch notation will turn off, confirming that the IF Notch filter is no longer operating.

ADVICE:

- The IF Notch filter affects the Main band (VFO-A) only.
- You may observe the graphically-depicted peak (maximum null) position of the IF Notch Filter in the NOTCH indicator on the display.
- The width of the IF Notch null may be adjusted using Menu item "092 rdSP NOTCH W." Both "Wide" and "Narrow" selections are available, with "Narrow" providing the least disruption of the "desired" signal.
- When the optional **DMU-2000** Data Management Unit is connected, the effect of the IF Notch filter may be observed on the Audio Scope (on the "Oscilloscope" page). The Notch will be observed as a "dip" in the noise platform observed. What's more, the "Waterfall" display may be used to observe the effect of the IF Notch filter, which will appear as a white area in the colored background area. The tuning rate for the IF Notch is somewhat slow while you adjust the **[FINE]** knob, so the use of the Waterfall display to confirm proper adjustment is highly recommended.

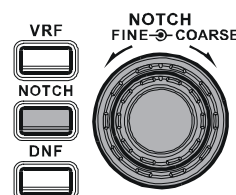
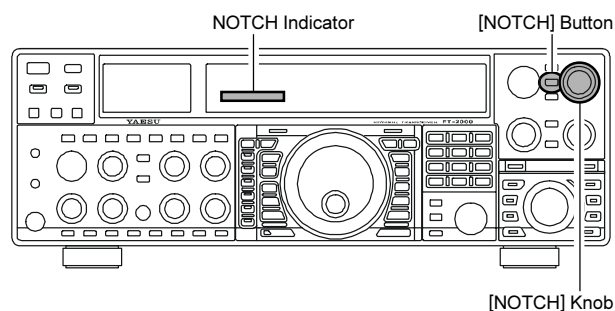

The performance of the IF Notch filter is shown in Figure "A," where the effect of rotation of the **[NOTCH]** knobs is depicted. In Figure "B," you can see the notching effect of the IF Notch filter as you rotate the **[NOTCH]** knobs to eliminate the incoming interference.

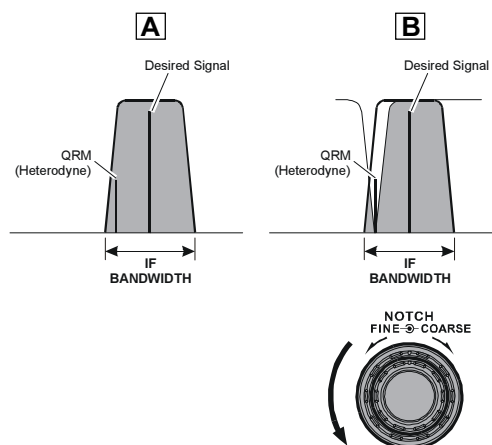

DIGITAL NOISE REDUCTION (DNR) OPERATION

The Digital Noise Reduction (DNR) system is designed to reduce the level of random noise found on the HF and 50 MHz bands, and it is especially effective during SSB operation. By rotating the [DNR] knob, any of sixteen different noise-reduction algorithms can be selected; each of these algorithms was created for dealing with a different noise profile, and you will want to experiment with the DNR system to find the best setting according to the noise currently being experienced.

1. Press the [DNR] button. The “**DNR**” icon will appear in the display, confirming that the DNR system is engaged.
2. Rotate the [DNR] knob to select the setting that most effectively reduces the noise level.
3. To disable the DNR system, press the [DNR] button once more. The “**DNR**” icon will turn off, confirming that the DNR system is not active.

ADVICE:

The Digital Noise Reduction affects the Main band (VFO-A) only.

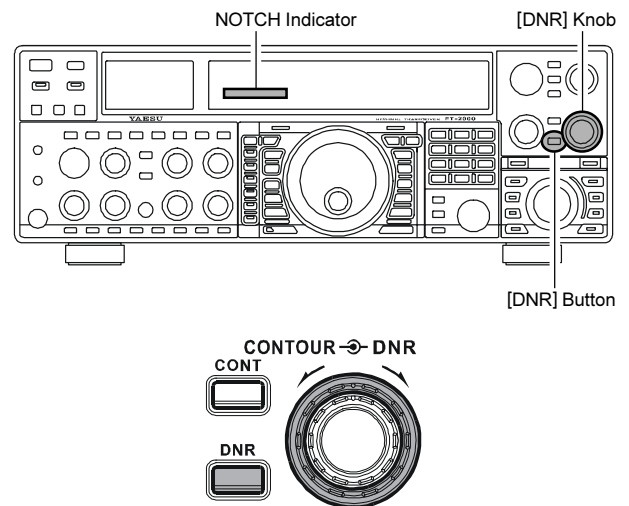

DIGITAL NOTCH FILTER (DNF) OPERATION

The Digital Notch Filter (DNF) is an effective beat-cancelling filter that can null out a number of interfering beat notes inside the receiver passband. Because this is an Auto-Notch feature, there is no adjustment knob associated with this filter.

ADVICE:

If a very strong interfering carrier is encountered, we recommend you first use the IF Notch filter, as it is the most effective notching tool in the receiver section.

1. Press the [DNF] button. The “**DNF**” icon will appear in the display, confirming that the DNF system is engaged. 
2. To cancel DNF operation, press the [DNF] button once more. The “**DNF**” icon will turn off, confirming that the Digital Notch Filter is no longer in operation.

ADVICE:

The Digital Notch Filter affects the Main (VFO-A) band only.

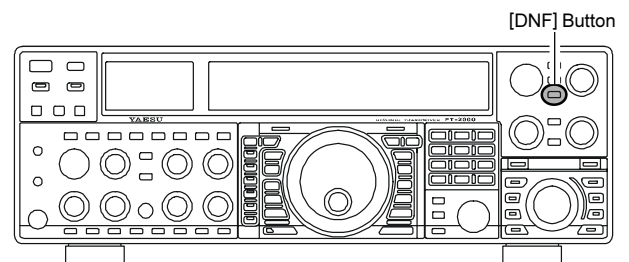

NARROW (NAR) ONE-TOUCH IF FILTER SELECTION

Main band (VFO-A) “One-Touch Narrow” Operation

Pressing the [NAR] button provides one-touch, mode-specific selection of a narrow IF DSP filter setting that does not depend on the setting of the [WIDTH] knob. Pressing the [NAR] button once more returns the bandwidth control to the Width/Shift system. The factory default bandwidths are:

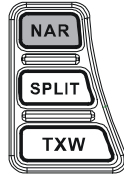

OPERATING MODE	[NAR] SWITCH	
	“ON”	“OFF”
SSB	1.8 kHz	※
CW	500 Hz	※
RTTY/PKT-L/PKT-U	300 Hz	※
PKT-FM	9 kHz	16 kHz
AM	6 kHz	9 kHz
FM (28/50 MHz Bands)	9 kHz	16 kHz

※: Depends on the [WIDTH] knob

ADVICE:

- ❑ When the narrow bandwidth is selected, the “NAR” icon will appear in the display and the bandwidth on the WIDTH indicator in the display will be reduced.
- ❑ The bandwidth applied when the [NAR] button is pressed may be adjusted using the Menu. This allows you to customize a quick-switch “Narrow” bandwidth matching your operating needs. The default values for each mode below are underlined.

SSB mode: Menu item “104 rdsP SSB NAR”
200/400/600/850/1100/1350/1500/1650/
1800/1950/2100/2250 Hz

CW mode: Menu item “095 rdsP CW NARR”
25/50/100/200/300/400/500/800/1200/1400/
1700/2000 Hz

PSK mode: Menu item “098 rdsP PSK NAR”
25/50/100/200/300/400 Hz

RTTY mode: Menu item “101 rdsP RTY NAR”
25/50/100/200/300/400 Hz

- ❑ When the [NAR] button has been pushed so as to engage the narrow filter, the [WIDTH] knob will be disabled, but IF Shift still is operational. For many applications, you may find that simple adjustment of the [WIDTH] knob, instead of engaging the Narrow filter, may be satisfactory for interference reduction.
- ❑ You may adjust the CW bandwidth using the [WIDTH] knob, even if the narrow filter is engaged. In this case, available bandwidth selections are 25 Hz ~ 2 kHz.
- ❑ When you press the [NAR] button in the FM mode, both the transmit and receive bandwidths are narrowed.

NOTE:

When the [NAR] button is pressed, the [WIDTH] knob no longer functions (except the CW mode).

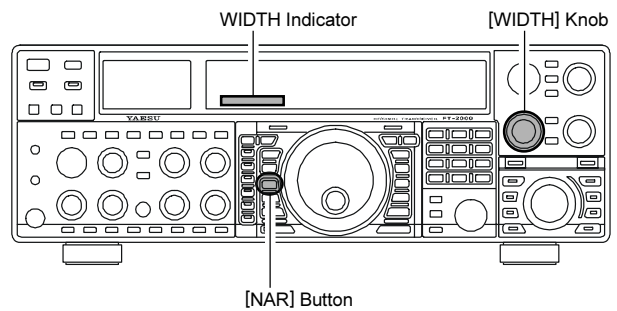

Sub band (VFO-B)

“One-Touch Narrow” Operation

1. Press the [B] button.
2. Within five seconds of pressing the [B] button (while the imbedded orange LED is blinking), press the [NAR] button to toggle the bandwidth between “wide” and “narrow.” When the narrow bandwidth is selected, the “NAR” icon will appear in the display.

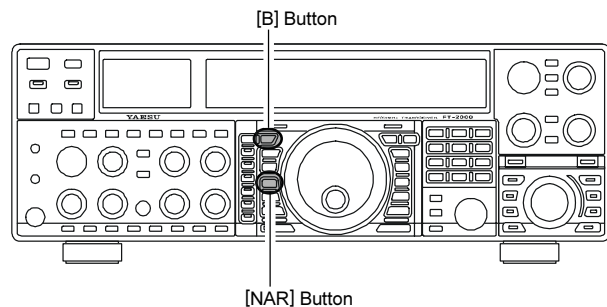

OPERATING MODE	[NAR] SWITCH	
	“ON”	“OFF”
SSB	1.1 kHz	2.25 kHz
CW	1.2 kHz (300 Hz/500 Hz)※	2.0 kHz
RTTY/PKT-L/PKT-U	1.2 kHz	1.2 kHz
PKT-FM	9 kHz	16 kHz
AM	6 kHz	9 kHz
FM (28/50 MHz bands)	9 kHz	16 kHz

※: Requires the optional CW Narrow Filter
300 Hz: YF-122CN, 500 Hz: YF-122C

IF NOISE BLANKER (NB) OPERATION

The **FT-2000** includes an effective IF Noise Blanker, which can significantly reduce noise caused by automotive ignition systems.

Main band (VFO-A) NB Operation

1. Press the **[NB]** button momentarily to reduce short-duration pulse noise such as from switching transients, automobile ignitions and power lines. The “**NB**” icon will appear in the display to confirm that the Narrow-NB is operating. Press and hold in the **[NB]** button for two seconds to reduce longer-duration man-made pulse noise. The “**NB**” icon will blink for five seconds, and thereafter will appear continuously, to confirm that the Wide-NB is operating.
2. Advance the **[NB]** knob to the point where the offending noise is best reduced or eliminated.
3. To end Noise Blanker operation, press the **[NB]** button once more. The “**NB**” icon will turn off, confirming that the Noise Blanker is no longer in operation.

ADVICE:

- When the Roofing filter mode is set to “AUTO” and the Noise Blanker is turned On, the Roofing Filter bandwidth will automatically be set to 15 kHz. The Roofing Filter may be changed to a narrower selection, as described previously, although Noise Blanker operation may be compromised somewhat when using a narrower Roofing Filter.
- When you change the Noise Blanker level on the Main (VFO-A) side, the Sub (VFO-B) band’s Noise Blanker level will automatically change to be the same as that for VFO-A, if the Sub (VFO-B) band’s Noise Blanker is engaged.

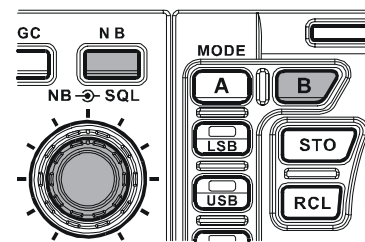
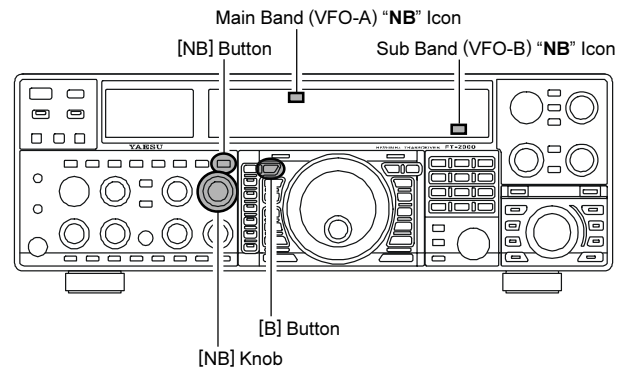

Sub band (VFO-B) NB Operation

1. Press the **[B]** button.
2. Within five seconds of pressing the **[B]** button (while the imbedded orange LED is blinking), press the **[NB]** button momentarily to reduce short-duration pulse noise such as from switching transients, automobile ignitions and power lines. The “**NB**” icon will appear in the display to confirm that the Narrow-NB is operating.
3. Within five seconds of pressing the **[B]** button (while the imbedded orange LED is blinking), press and hold in the **[NB]** button for two seconds to reduce longer-duration man-made pulse noise. The “**NB**” icon will blink for five seconds, then appear continuously, to confirm that the Wide-NB is operating.
4. To end Noise Blanker operation, press the **[B]** button, then press the **[NB]** button. The “**NB**” icon will turn off, confirming that the Noise Blanker is no longer in operation.

ADVICE:

When you change the Noise Blanker level on the Sub (VFO-B) side, the Main (VFO-A) band’s Noise Blanker level will automatically change to be the same as that for VFO-B, if the Main (VFO-A) band’s Noise Blanker is engaged.

TOOLS FOR COMFORTABLE AND EFFECTIVE RECEPTION

AGC (AUTOMATIC GAIN CONTROL)

The AGC system is designed to help compensate for fading and other propagation effects, with characteristics that can be of particular value on each operating mode. The basic objective of AGC is to maintain a constant audio output level once a certain minimum threshold of signal strength is achieved.

Main Band (VFO-A) AGC Selection

Press the **[AGC]** button repeatedly to select the desired receiver-recovery time constant. You will observe the AGC status notation in the AGC column of the Receiver Configuration Indicator on the display, denoting the AGC receiver-recovery time currently in use. For most operation, we recommend the “AUTO” mode. Additionally, you may disable the AGC by pressing and holding in the **[AGC]** button for two seconds.

Sub Band (VFO-B) AGC Selection

1. Press the **[B]** button.
2. Within five seconds of pressing the **[B]** button (while the imbedded orange LED is blinking), press the **[AGC]** button repeatedly to select the desired receiver-recovery time constant. You will observe the AGC notation below the Sub frequency on the display, denoting the Sub receiver’s current AGC receiver-recovery time. For most operation, we recommend the “AUTO” mode. Additionally, you may disable the AGC by pressing and holding in the **[AGC]** button for two seconds.

NOTE:

Pressing the **[AGC]** button allows selection of the desired receiver-recovery time constant. Normally, the “AUTO” selection is satisfactory for most situations, but in the event of operation on a crowded band where you wish to receive a weak signal, you may wish to change the setting (to FAST, for example). The “AUTO” mode selections are:

OPERATING MODE	AUTO AGC SELECTION
LSB	SLOW
USB	SLOW
CW	FAST
AM	FAST
FM	FAST
RTTY	SLOW
PKT (FM)	FAST
PKT (LSB)	SLOW

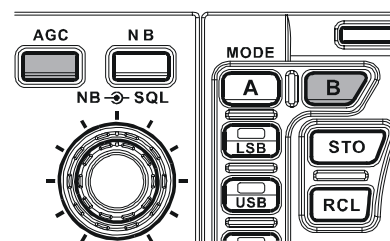
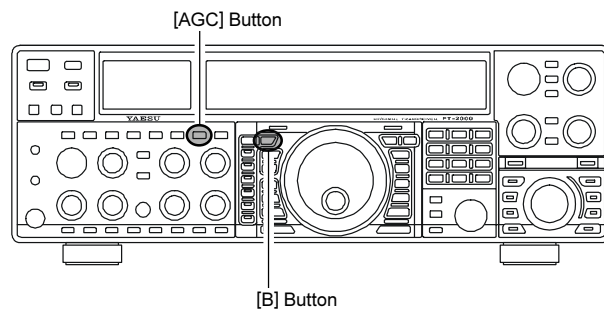

ADVICE:

If the AGC receiver-recovery time is set to “Off” by pressing and holding in the **[AGC]** button, the S-meter will no longer deflect. Additionally, you will likely encounter distortion on stronger signals, as the IF amplifiers and the following stages are probably being overloaded.

QUICK POINT

Several aspects of AGC performance may be configured via the Menu. However, because AGC can have such a profound impact on overall receiver performance, we generally do not recommend any changes to the AGC Menu selections until you are thoroughly familiar with the performance of the **FT-2000**.

TERMINOLOGY:

Automatic Gain Control, or AGC, is a circuit that senses the incoming signal strength, and then limits the gains of the RF and IF stages so as to keep the output audio volume at a more-or-less constant level. AGC also protects the RF, IF, Audio, and DSP stages from overload, as it limits the signal strength that is allowed to flow, irrespective of the input signal level.

TOOLS FOR COMFORTABLE AND EFFECTIVE RECEPTION

AGC (AUTOMATIC GAIN CONTROL)

SLOPED AGC Operation

In traditional AGC systems, the audio output from the transceiver becomes essentially fixed once the threshold for AGC action is reached (usually several dozen dB above the no-signal noise floor). The **FT-2000**, however, includes an innovative Sloped AGC system on the Main band (VFO-A) receiver, that allows the audio volume to rise and fall slightly according to signal strength. Although the rise/fall slope is not dramatic, it is sufficient to allow you to use your ear to discern and separate signals according to signal strength, not just audio frequency.

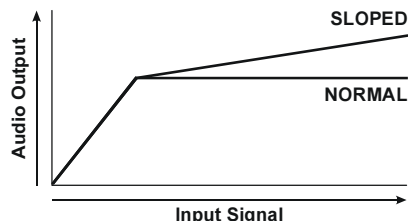

Using Sloped AGC

1. Press the **[MENU]** button momentarily to enter the Menu mode.
2. Use the Main Tuning Dial knob to select Menu item "088 rout AGC SLP."
3. Rotate the **[SUB VFO-B]** knob to change the setting to "SLP."
4. Press and hold in the **[MENU]** button for two seconds to save the new setting and exit to normal operation. You will now be using the Sloped AGC system.

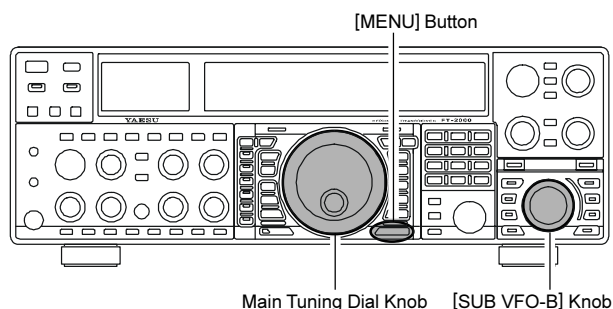

MUTE FEATURE (MAIN (VFO-A) BAND)

There may be occasions, during Dual Receive operation, when you want to silence the Main (VFO-A) receiver temporarily so as to concentrate on what's being received on the Sub (VFO-B) receiver. The Mute feature makes this simple to accomplish.

Press the Main **[RX]** LED/switch. The Main (VFO-A) receiver will be silenced, and the green LED in the **[RX]** switch will blink.

To restore reception on the Main (VFO-A) receiver, just press the blinking **[RX]** switch/LED once more.

ADVICE:

If you press the **[POWER]** switch momentarily while the transceiver is turned on, the transceiver's audio will be muted for three seconds.

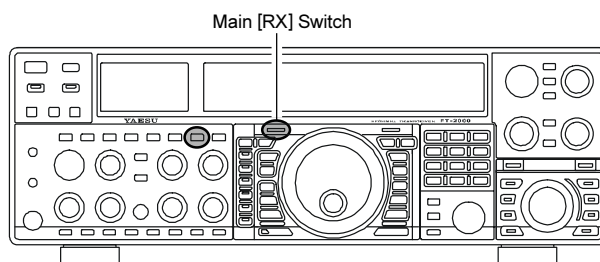

SSB/AM MODE TRANSMISSION

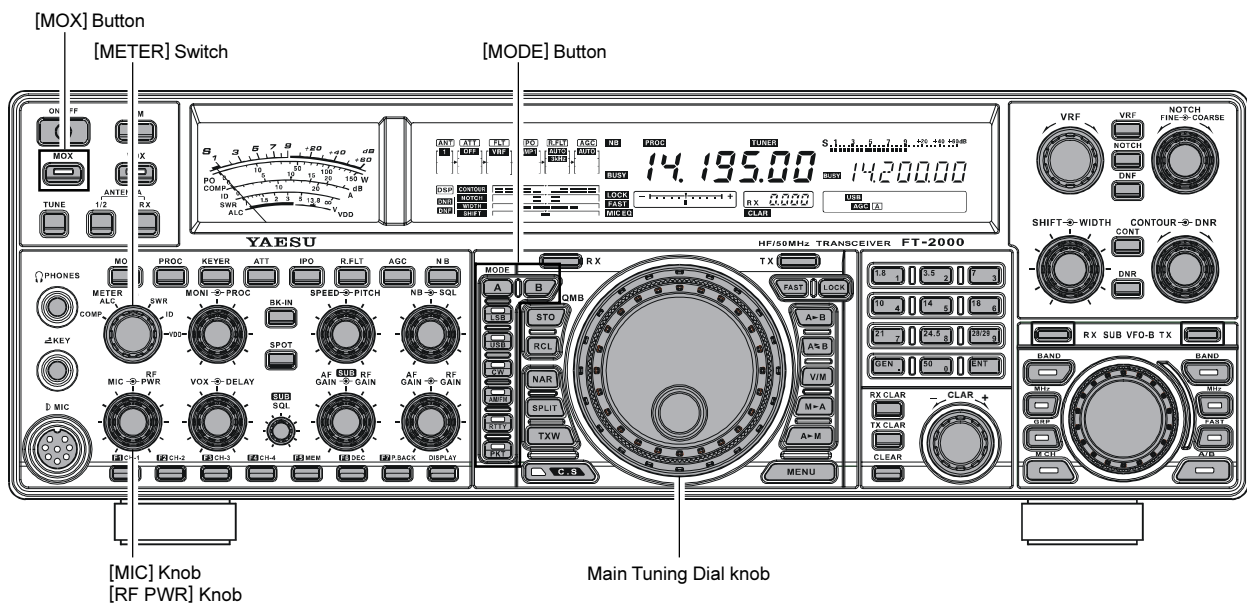

1. The operating mode is selected using the **[MODE]** buttons to the left of the Main Tuning Dial knob, and the VFO (A or B) to which the selection is applied is selected by the **[A]** or **[B]** button above the **[MODE]** buttons. Usually, the **[A]** button glows Red, signifying that the Main band (VFO-A) is being adjusted. Similarly, pressing the **[B]** button will cause its indicator to blink Orange for five seconds, signifying Sub band (VFO-B) adjustment. Therefore, press the **[A]** or **[B]** button to select the desired VFO, then press the **[LSB]** or **[USB]** button to select one of the SSB modes. For AM operation, press the **[AM/FM]** button repeatedly until the imbedded LED glows red.

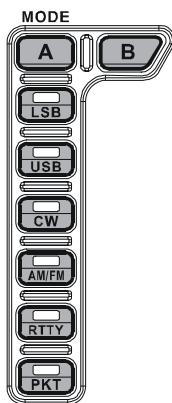

QUICK POINT:

- By convention, LSB is used in the 7 MHz and lower Amateur bands for SSB communication, and USB is used on the 14 MHz and higher bands (the 10 MHz band is used for CW and data modes only).
 - When the **[AM/FM]** button glows orange, it indicates that FM operation is engaged.
2. Rotate the Main Tuning Dial knob to adjust the operating frequency. Alternatively, you may use the **[UP]/[DWN]** scanning buttons on the **MH-31B8** Hand Microphone to sweep up or down the current band.

3. Press the microphone's **PTT** (Push To Talk) switch to begin transmission; speak into the microphone in a normal voice level.

ADVICE:

- The “**T X**” indicator will light up in the frequency display area, confirming that transmission is in progress.
- When transmitting in the AM mode, rotate the **[RF PWR]** knob so as to set a maximum (carrier) power output of 25 Watts.

4. In the SSB mode, adjust the microphone amplifier gain to match the microphone and your voice level, set the **[METER]** switch to the “ALC” position, close the **PTT** switch, speak into the microphone in a normal voice level, and adjust the **[MIC]** (gain) knob so that the ALC voltage (displayed on the right meter) stays within the ALC zone of the meter (up to 2/3 of full scale deflection) on voice peaks.

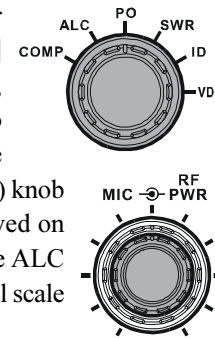

ADVICE:

The microphone gain of the AM mode has been programmed, at the factory, to a level that should be satisfactory for most situations. However, using Menu item “050 A3E MICGAIN,” you may set a different fixed value, or choose the “Ur” option, which then lets you use the front panel **[MIC]** knob to set the microphone gain in the AM mode. In this case, the **[MIC]** knob should not be advanced to the point where the ALC meter deflects. In many cases, the same setting as used on SSB will be satisfactory.

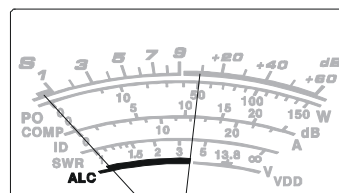

5. Release the **PTT** switch at the end of your transmission. The transceiver will return to the receive mode.

SSB/AM MODE TRANSMISSION

ADVICE:

- ❑ ALC meter deflection may be caused by excessive drive power, but also by reflected power detected in the antenna system. If the impedance presented to the transceiver is different from 50 Ohms, ALC meter action may be observed that is not related to the proper setting of the **[MIC]** (gain) knob. Therefore, we recommend that you make **[MIC]** knob adjustments into a dummy load or antenna system presenting an impedance very close to 50 Ohms.
- ❑ Rotate the **[RF PWR]** knob to set the desired power output. Clockwise rotation of the **[RF PWR]** knob will increase the power. The adjustment range is between 5 Watts and 100 Watts, and you should always use the minimum power necessary for maintaining reliable communications.
- ❑ The analog PO meter indicates the average power output level. SSB transmit average talk power is normally 10% to 50% of the peak power output. Voice characteristics, microphone qualities, parametric equalizer and compression settings affect actual talk power output.

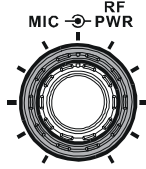

- ❑ When performing tests (such as the setup of the **[MIC]** or **[RF PWR]** knobs), be sure to check the frequency before transmitting, so as to avoid interference to others who may already be using the frequency.
- ❑ Four techniques for exercising Transmit/Receive control are provided on the **FT-2000**, and you may choose the technique(s) that best suit your operating needs:
 - Pressing the microphone's **PTT** switch will engage the transmitter.
 - The rear panel **PTT** jack may be connected to a foot switch or other manual switching device in order to engage the transmitter.
 - Pressing the front panel **[MOX]** button will lock the transmitter on. Press the **[MOX]** button again to return to receive.
 - The VOX (Voice Operated Xmit) circuit will engage the transmitter automatically when you speak into the microphone. For details of VOX operation, see page 74.

USING THE AUTOMATIC ANTENNA TUNER

The Automatic Antenna Tuner (hereinafter referred to as the “ATU”) built into each **FT-2000** is crafted to ensure a 50-Ohm load for the final amplifier stage of the transmitter. We recommend that the ATU be used whenever you operate on the **FT-2000**.

ADVICE:

- ❑ The ATU of the **FT-2000**, being located inside the station, only adjusts the impedance presented to the transceiver at the station end of your coaxial cable feedline. It does not “tune” the SWR at the antenna feedpoint itself. When designing and building your antenna system, we recommend that every effort be made to ensure a low SWR at the antenna feedpoint.
- ❑ The ATU of the **FT-2000** includes 100 memories for tuning data. Eleven of these memories are allocated, one per Amateur band, so that each band has at least one setting preset for use on that band. The remaining 89 memories are reserved for the 89 most-recent tuning points, for quick frequency change without the need to retune the ATU.
- ❑ The ATU in the **FT-2000** is designed to match impedances within the range of 16.5 Ohms to 150 Ohms, corresponding to an SWR of 3:1 or less on the HF amateur bands (6 m amateur band: 25 Ohms to 100 Ohms, corresponding to an SWR of 2:1 or less). Accordingly, simple non-resonant whip antennas, along with random-length wires and the “G5RV” antenna (on most bands) may not be within the impedance matching range of the ATU.

ATU OPERATION

1. Rotate the [RF PWR] knob fully clockwise (to the right).
2. Use the Main Tuning Dial knob to set the radio to the desired operating frequency within the Amateur band.
3. Press the [TUNE] button momentarily to place the ATU in the transmit line (no adjustment/tuning will occur yet). The “**TUNER**” icon will appear in the display.

QUICK POINT:

The momentary press of the [TUNE] button will turn the tuner on, and the microprocessor will automatically select the tuning point closest to the current operating frequency.

4. Press and hold in the [TUNE] button for two seconds to begin automatic tuning. The transmitter will be engaged, and the “**TUNER**” icon will blink while tuning is in progress. When the optimum tuning point has been reached, the radio will return to receive, and the “**TUNER**” icon will again glow steadily (instead of blinking).
5. While tuning around the band using the Main Tuning Dial knob, you will observe that the “**TUNER**” icon blinks momentarily every 10 kHz. This momentary blinking indicates that a new tuning window has been entered. If you want to save tuning data associated with this 10 kHz window, repeat step 4 (above) for each such window. On bands like 1.8 MHz where the impedance may change rapidly, the storage of a number of tuning points is recommended.
6. To disconnect the ATU from the transmit line, press the [TUNE] button momentarily. The “**TUNER**” icon will turn off, confirming that the ATU has been turned off. In the “Off” mode, the transceiver will be directly connected to the coaxial cable connected to your antenna, and will operate based on whatever impedance is present at the station end of the coax.

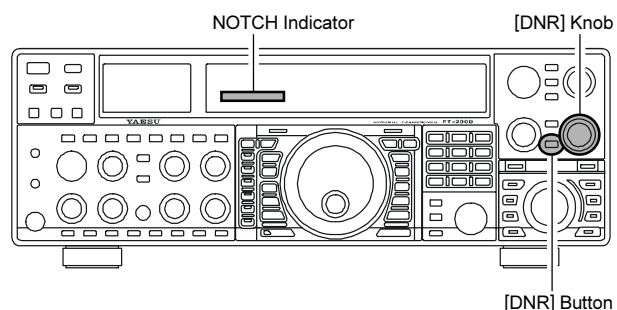

ADVICE:

The ATU circuit is located between the final amplifier and the rear-panel antenna jack; reception is not affected by the ATU.

QUICK POINT:

- ❑ As shipped from the factory, only one ATU alignment point is saved on each Amateur band. This was memorized during the final alignment and performance verification stages on the production line.
- ❑ The momentary flickering of the “**TUNER**” icon occurs whenever you cross over into a new 10 kHz ATU memory window.

NOTE:

Please check the operating frequency before beginning the tuning process, to be sure you are not interfering with others who may already be using the frequency.

TERMINOLOGY:

Antenna Tuner Memories: The microprocessor of the ATU makes a note of the positions of the tuning capacitors and the selected inductors, and stores the data for each 10 kHz window in which tuning has occurred. This eliminates the need to re-tune every time you return to a frequency on which you already have completed the tuning process.

USING THE AUTOMATIC ANTENNA TUNER

ABOUT ATU OPERATION

Figure 1 depicts a situation where normal tuning via the ATU has been successfully completed, and the tuning data has been stored in the ATU memory. The antenna system as seen by the transmitter is shown.

In Figure 2, the operator has changed frequency, and the “**HI-SWR**” icon has become appeared. The operator presses and holds in the [TUNE] button for two seconds to begin impedance matching using the ATU.

If a high SWR conditions exists (above 3:1), corrective action must be taken in the antenna system to bring the impedance closer to 50 Ohms. Besides the fact that the ATU will refuse to memorize settings on frequencies where the SWR exceeds 3:1, the high SWR may indicate a mechanical failure in the feed system, and such failures can lead to the generation of spurious signals causing TVI, etc.

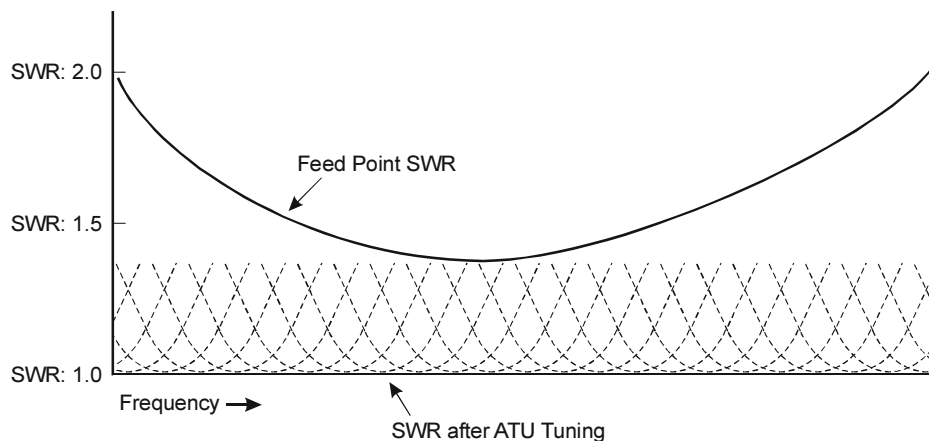

FIGURE 1

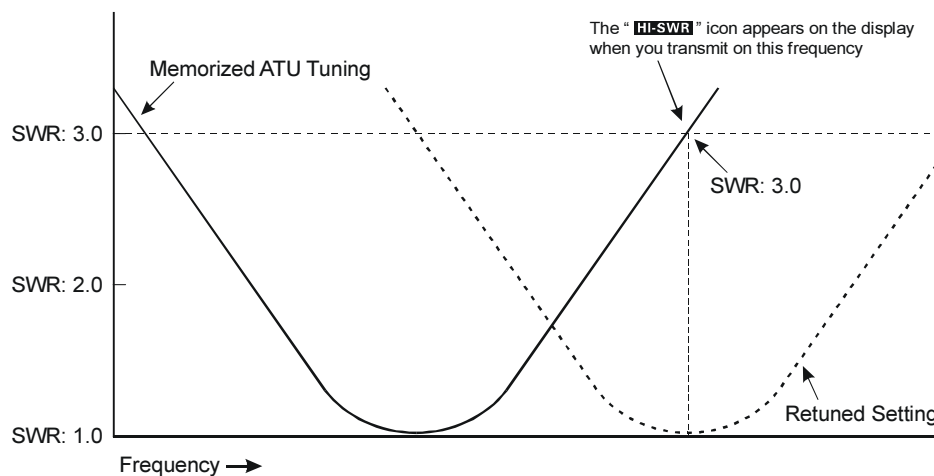

FIGURE 2

About ATU Memories

SWR (Post-tuning) Less than 1.5:1

The tuning settings are committed to the ATU memory.

SWR (Post-tuning) Greater than 1.5:1

Tuning data will not be retained in memory. If you return to the same frequency, the tuning process must be repeated.

SWR (Post-tuning) Greater than 3:1

The “**HI-SWR**” icon will light up, and tuning settings, if achieved, will not be memorized. Please investigate and resolve the high SWR condition before attempting further operation using this antenna.

USING THE AUTOMATIC ANTENNA TUNER

LITHIUM BATTERY REPLACEMENT

The memories for the ATU are backed up by a common Lithium backup battery (type CR2032 or equivalent). After two or more years of heavy use, you may notice that the tuner memories are not being maintained, and that you have to re-tune when returning to a frequency on which you had previously stored tuning data.

In this case, please replace the ATU Backup Battery using the following procedure:

1. Turn the front panel [POWER] switch “off,” then turn the rear panel’s [POWER] switch “off.”
2. Unplug the AC cable from the rear panel’s ~AC IN jack.
3. Referring to Figure 1, remove the three screws from each side of the transceiver and three screws from the top edge of the rear panel. Slide the top case toward the rear about 1/2 inch (1 cm), then remove the top case.
4. Turn the transceiver up side down.
5. Remove the seven screws affixing the bottom case, and then remove the bottom case (Figure 2).
6. Locate the Lithium battery on the left side of the Control Unit (Figure 3).
7. Turn the **BACKUP** switch “off.”
8. Follow the guidelines in Figure 4, and remove the old battery, replacing it with a new one of the identical type.
9. Connect the AC cable to the rear panel’s ~AC IN jack.
10. Turn the rear panel’s [POWER] switch “on,” then turn the front panel [POWER] switch “on.” Use extreme caution, as high voltages are present inside the transceiver!
11. Turn the **BACKUP** switch “on.”
12. Turn the front panel [POWER] switch “off,” then turn the rear panel’s [POWER] switch “off.”
13. Unplug the AC cable from the rear panel’s ~AC IN jack.
14. Replace bottom case and its seven screws removed in step 5, and then replace the top case and its nine screws removed in step 3.
15. The ATU Backup Battery replacement is now complete.

CAUTION:

Danger of explosion if battery is incorrectly replaced. Replace only with the same or equivalent type.

QUICK POINT:

When the ATU Backup Battery is replaced, all tuner memories will be erased, and new sets of tuning data will have to be stored.

NOTES:

- ❑ Use care in the handling and storage of the Lithium battery. It is small, and presents a choking hazard to small children; therefore keep such batteries out of the reach of children at all times. Do not dispose of Lithium batteries in fire, and do not attempt to re-charge them under any circumstances.
- ❑ When opening/closing the case, take care with your screwdriver not to short out internal components, or touch them in a way that will cause them to short out against other components.
- ❑ The exhaustion of the ATU backup battery of the **FT-2000** is a normal “wear and tear” situation, and the loss of the backup voltage is not a “defect” or other condition covered by the Limited Warranty on this product. Accordingly, if you do not feel capable of replacing the battery, and ask a service shop to do so on your behalf, a service fee may apply.

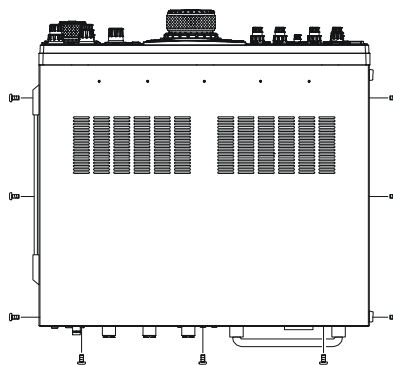

FIGURE 1

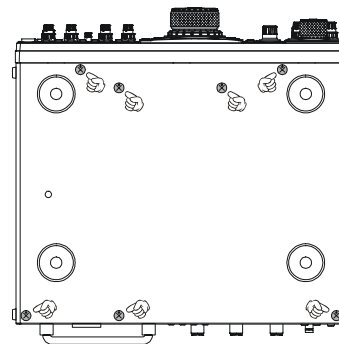

FIGURE 2

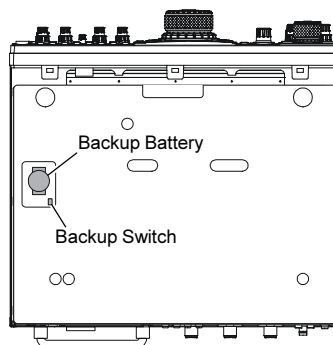

FIGURE 3

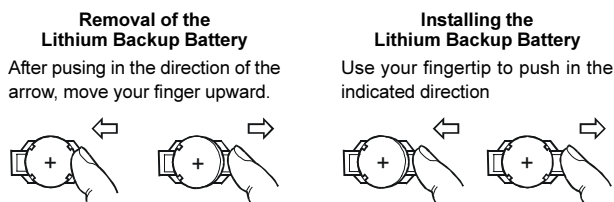

FIGURE 4

ENHANCING TRANSMIT SIGNAL QUALITY

USING THE SPEECH PROCESSOR (SSB/AM MODES)

The Speech Processor is designed to increase “talk power” by increasing the average power output via a sophisticated compression technique. The result is improved intelligibility when conditions are difficult.

1. Adjust the **[MIC]** (gain) knob for SSB use, as described on page 64.
2. Rotate the **[METER]** switch fully to the left, so as to select “**COMP**” (Compression).
3. Press the **[PROC]** button momentarily. The “**PROC**” icon will appear in the display, confirming that the Speech Processor is engaged.
4. Press the **PTT** switch on the microphone, and speak into the microphone in a normal voice level. Observe the deflection of the meter needle on the COMP meter scale.
5. Rotate the **[PROC]** knob so that the meter needle deflects to not more than “**10 dB**” on the COMP scale.
6. To switch the Speech Processor off, press the **[PROC]** button once more. The “**PROC**” icon will turn off, confirming that the Speech processor is turned off.

ADVICE:

- Excessive advancement of the **[PROC]** knob will result in a degradation of the transmitted signal’s signal-to-noise ratio, thereby reducing intelligibility at the other end of the circuit.
- The Transmit Monitor is very helpful way of verifying proper adjustment of the compression level. Pressing the **[MONI]** button then adjusting the **[MONI]** knob for a comfortable listening level while you are transmitting, you will be able to hear the difference in sound quality as you make adjustments.
- The **[RF PWR]** knob still controls the RF power output, whether or not the Speech Processor is engaged.
- When the optional **DMU-2000** Data Management Unit is connected, you may observe the effect of your compression level adjustments by viewing the wave-form on the “Oscilloscope” page.

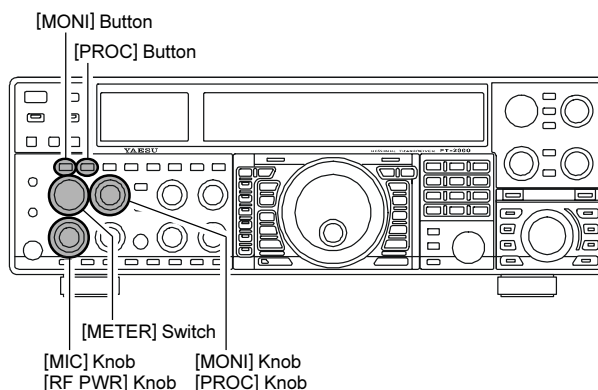

ENHANCING TRANSMIT SIGNAL QUALITY

ADJUSTING THE SSB TRANSMITTED BANDWIDTH (SSB MODE)

For transmission on SSB, a default bandwidth of 2.4 kHz is provided. This bandwidth provides reasonable fidelity along with good talk power, and is typical of the bandwidth used for decades during SSB transmission. However, the bandwidth may be varied by the operator, so as to provide different levels of fidelity or talk power, according to your preferences.

Here's how to adjust the transmitted bandwidth on SSB:

1. Press the **[MENU]** button to engage the Menu.
2. Rotate the Main Tuning Dial knob so as to select Menu item "083 A3J TX BPF."
3. Rotate the **[SUB VFO-B]** knob to select the desired bandwidth. The available selections are 3000/50-3000/100-2900/200-2800/300-2700/400-2600, and the default is 300-2700 Hz. A wider bandwidth will provide greater fidelity, while a narrow bandwidth will compress the available transmitter power into less spectrum, resulting in more "talk power" for DX pile-ups.
4. Press and hold in the **[MENU]** button for two seconds to save the new setting and exit to normal operation.

ADVICE:

- ❑ The Transmit Monitor is very helpful way of verifying the effects on fidelity of changing the bandwidth. Pressing the **[MONI]** button then adjusting the **[MONI]** knob for a comfortable listening level while you are transmitting, you will be able to hear the difference in sound quality as you make changes.
- ❑ When the optional **DMU-2000** Data Management Unit is connected, you may verify the effect of your adjustments of the transmitted bandwidth by observing the Audio Scope on the "Oscilloscope" page.

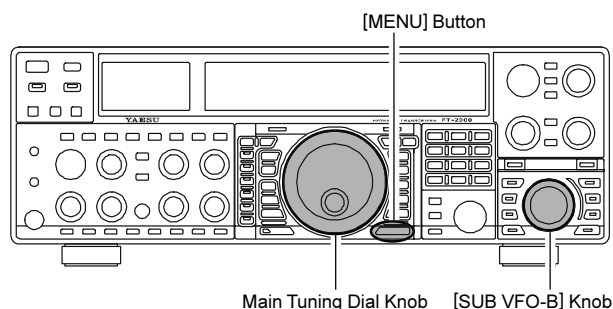

QUICK POINTS:

- ❑ The higher fidelity associated with wide bandwidth will be particularly enjoyable on the low bands, during local rag-chew QSOs.
- ❑ The "3000" setting is a special hi-fidelity setting, whereby the transmitted bandwidth is in excess of 3 kHz. This selection, in conjunction with judicious adjustment of the Parametric Microphone Equalizer (see next chapter) can provide truly outstanding fidelity and very natural-sounding audio.
- ❑ When using the wider bandwidth selections (especially "3000"), the apparent power output from the transmitter may seem lower. This is because the available power from the transmitter is being distributed over a wider bandwidth, and the power detection circuitry does not compensate for the effect of the bandwidth selection (it is calibrated in the default 2.4 kHz bandwidth).

ENHANCING TRANSMIT SIGNAL QUALITY

PARAMETRIC MICROPHONE EQUALIZER (SSB/AM MODES)

The **FT-2000** includes a unique Three-Band Parametric Microphone Equalizer, that provides precise, independent control over the low-, mid-, and treble-ranges in your voice wave-form. You may utilize one group of settings for when the speech processor is off, and an independent group of settings for when the speech processor is on.

QUICK POINTS:

The Parametric Equalizer is a unique technique for adjusting the signal quality. Because the three ranges may be adjusted so precisely, it is possible to craft a response that provides a more natural and pleasant sound than you have ever experienced before. Effective “talk power” can also be significantly enhanced.

The aspects of configuration that you may adjust on the Parametric Equalizer are:

Center Frequency: The center frequency of each of the three bands may be adjusted.

Gain: The amount of enhancement (or suppression) within each band may be adjusted.

Q: The bandwidth over which the equalization is applied may be adjusted.

1. Connect the microphone to the **MIC** jack.
2. Set the **[RF PWR]** knob to its minimum value, so as not to cause interference to other users during adjustment.

ADVICE:

- We recommend you consider connecting a dummy load to one of the Antenna jacks, and monitor your signal on a separate receiver, so as to prevent interference to other users.
- You will have the best chance of hearing the effects of adjustments if you wear headphones (connected to the monitor receiver) while monitoring your transmitted signal.

3. Press the **[MONI]** button, if you want to listen on the **FT-2000**'s internal monitor.
4. Press the **[MENU]** button momentarily. The Menu list will appear in the display.
5. Rotate the Main Tuning Dial knob to find the “EQ” Menu area, containing Menu items “123” through “131;” these parameters apply to the adjustment of the Parametric Microphone Equalizer when the speech processor is disabled. Menu items “132” through “140” apply to the adjustment of the Parametric Microphone Equalizer when the speech processor is engaged.
6. Rotate the **[SUB VFO-B]** knob to perform adjustments to a particular Menu item.
7. Close the **PTT** switch, and speak into the microphone while listening to the effects of the changes you are making (in step 6). Because the overall effect on the sound will change with each adjustment you make, you should make several passes through each adjustment area, to be sure that you are achieving the optimum setting.
8. When you have completed all adjustments, press and hold in the **[MENU]** button for two seconds to save the new settings and exit to normal operation. If you only press the **[MENU]** button momentarily to exit, any changes you performed will not be stored.

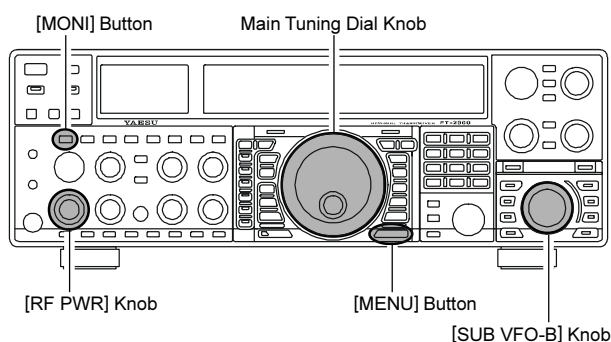

3-STAGE PARAMETRIC EQUALIZER ADJUSTMENTS (SPEECH PROCESSOR: “OFF”)

Center Frequency	“123 tAUd EQ1-FREQ”	“100” (Hz) ~ “700” (Hz)
	“126 tAUd EQ2-FREQ”	“700” (Hz) ~ “1500” (Hz)
	“129 tAUd EQ3-FREQ”	“1500” (Hz) ~ “3200” (Hz)
Parametric Gain	“124 tAUd EQ1-LVL”	(Low) “-10” (dB) ~ “+10” (dB)
	“127 tAUd EQ2-LVL”	(Mid) “-10” (dB) ~ “+10” (dB)
	“130 tAUd EQ3-LVL”	(High) “-10” (dB) ~ “+10” (dB)
Q (Bandwidth)	“125 tAUd EQ1-BW”	(Low) “1” ~ “10”
	“128 tAUd EQ2-BW”	(Mid) “1” ~ “10”
	“131 tAUd EQ3-BW”	(High) “1” ~ “10”

3-STAGE PARAMETRIC EQUALIZER ADJUSTMENTS (SPEECH PROCESSOR: “ON”)

Center Frequency	“132 tAUd PE1-FREQ”	“100” (Hz) ~ “700” (Hz)
	“135 tAUd PE2-FREQ”	“700” (Hz) ~ “1500” (Hz)
	“138 tAUd PE3-FREQ”	“1500” (Hz) ~ “3200” (Hz)
Parametric Gain	“133 tAUd PE1-LVL”	(Low) “-10” (dB) ~ “+10” (dB)
	“136 tAUd PE2-LVL”	(Mid) “-10” (dB) ~ “+10” (dB)
	“139 tAUd PE3-LVL”	(High) “-10” (dB) ~ “+10” (dB)
Q (Bandwidth)	“134 tAUd PE1-BW”	(Low) “1” ~ “10”
	“137 tAUd PE2-BW”	(Mid) “1” ~ “10”
	“140 tAUd PE3-BW”	(High) “1” ~ “10”

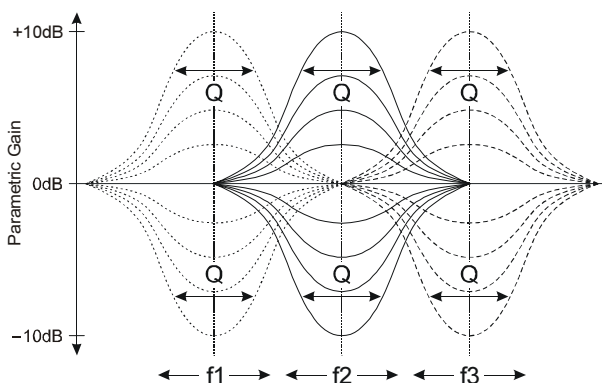

ADVICE:

To roll off excessive bass response in a wide-range studio microphone, try putting a 10 dB null at 100 Hz with a bandwidth of “1” or “2,” do about a 3 dB null centered on 800 Hz with a bandwidth of “3,” and then put an 8 dB peak centered on 2100 Hz with a bandwidth of “1.” These are starting recommendations; each microphone and user’s voice will be different, often requiring different settings.

TRANSMITTER CONVENIENCE FEATURES

VOICE MEMORY (SSB/AM/FM MODES)

You may utilize the Voice Memory capability of the **FT-2000** for repetitive messages. The Voice Memory system includes four memories capable of storing up to 20 seconds of voice audio each. The maximum that any memory can hold is 20 seconds.

Recording Your Own Voice in Memory

1. Select the LSB, USB, AM, or FM mode using the front panel **[MODE]** buttons.
2. Press the **[F5(MEM)]** button. A blinking **"REC"** icon will appear in the display.
3. Within five seconds of pressing the **[F5(MEM)]** button, press any of the buttons numbered **[F1(CH-1)]** through **[F4(CH-4)]** to select that memory storage register. If you do not press the **PTT** switch (see next step) within five seconds, the memory storage process will be cancelled.
4. Press the microphone's **PTT** switch momentarily, the **"REC"** icon will glow steadily, and recording will begin.
5. Speak into the microphone in a normal voice level to record the message (such as "CQ DX, CQ DX, this is W 6 Delta X-Ray Charlie, W 6 Delta X-Ray Charlie, Over"). Remember that the time limit for recording any message is 20 seconds.
6. Press the **[F5(MEM)]** button to terminate the message storage process.

Checking Your Recording

1. Be sure that the front panel **[MOX]** button is "Off" (the LED imbedded in the switch is must be off).
2. Press the **[F1(CH-1)]** ~ **[F4(CH-4)]** button (whichever one you just recorded in), and you will hear the contents of the voice memory you just recorded.

ADVICE:

You may adjust the playback level of the recording via Menu item "015 dUS RX LVL."

Transmitting the Recorded Message

1. Select the LSB, USB, AM, or FM mode using the front panel **[MODE]** buttons.
2. Press the front panel's **[BK-IN]** button.
3. Press the **[F1(CH-1)]** ~ **[F4(CH-4)]** button, depending on which memory register's message you wish to transmit. If you hit the key again during playback, the message will be terminated.

ADVICE:

You may adjust the transmit (audio) level of the recording via Menu item "016 dUS TX LVL."

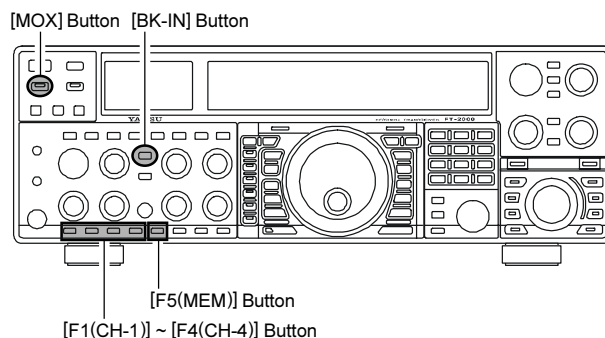

TRANSMITTER CONVENIENCE FEATURES

VOICE MEMORY (SSB/AM/FM MODES)

Voice Memory Operation from the optional FH-2 Remote Control Keypad

You may also utilize the Voice Memory capability of the **FT-2000** from the optional **FH-2** Remote Control Keypad which plugs into the rear panel's **REM** jack.

When using the **FH-2** Remote Control Keypad, you may record five memories with up to 20 seconds of voice audio each.

Recording Your Own Voice in Memory

1. Select the LSB, USB, AM, or FM mode using the front panel **[MODE]** selector buttons.
2. Press the **[MEM]** key on the **FH-2**.

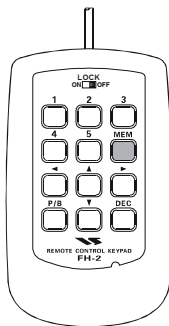

3. Press any of the **FH-2**'s keys numbered **[1]** through **[5]** to select that memory storage register. If you do not press the **PTT** key (see next step) within five seconds, the memory storage process will be cancelled.

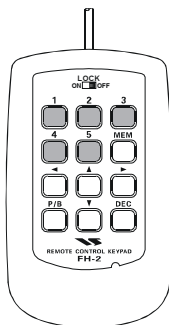

4. Press the microphone's **PTT** switch momentarily, the "**REC**" icon will glow steadily, and recording will begin.
5. Speak into the microphone in a normal voice level to record the message (such as "CQ DX, CQ DX, this is W 6 Delta X-Ray Charlie, W 6 Delta X-Ray Charlie, Over"). Remember that the time limit for recording any message is 20 seconds.
6. Press the **FH-2**'s **[MEM]** key to terminate the message storage process.

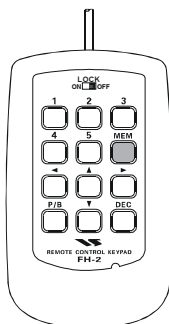

Checking Your Recording

1. Be sure that the front panel **[MOX]** button is "Off" (the LED imbedded in the button must be off).
2. Press the **FH-2**'s **[1]** ~ **[5]** key (whichever one you just recorded in), and you will hear the contents of the voice memory you just recorded.

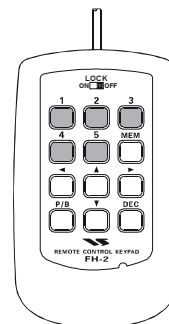

ADVICE:

You may adjust the playback level of the recording via Menu item "O15 dUS RX LVL."

Transmitting the Recorded Message

1. Select the LSB, USB, AM, or FM mode using the front panel **[MODE]** selector buttons.
2. Press the front panel's **[BK-IN]** button.
3. Press the **FH-2**'s **[1]** ~ **[5]** key, depending on which memory register's message you wish to transmit. If you hit the key again during playback, the message will be terminated.

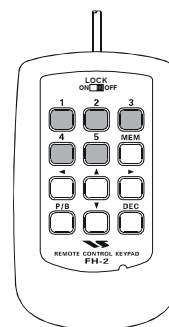

ADVICE:

You may adjust the transmit (audio) level of the recording via Menu item "O16 dUS TX LVL."

TRANSMITTER CONVENIENCE FEATURES

VOX (AUTOMATIC TX/RX SWITCHING USING VOICE CONTROL: SSB/AM/FM MODES)

Instead of using the microphone's **PTT** switch or the front panel **[MOX]** switch to activate the transmitter, the VOX (Voice Operated TX/RX Control) system provides hands-free, automatic activation of the transmitter, based on voice input into the microphone. Setup of the VOX system takes only a few seconds.

1. To start, set the **[VOX]** and **[DELAY]** knobs fully counter-clockwise (to the left).
2. Press the **[VOX]** button to engage VOX operation.
3. Speak into the microphone in a normal voice level, and rotate the **[VOX]** knob clockwise (to the right) until the point where your voice input activates the transmitter.

ADVICE:

- Do not advance the setting of the **[VOX]** knob too much, because to do so will make the transmitter respond to minor background noises in your station.
4. Now stop speaking, and note the amount of time it takes for the receiver to recover. If the hang time is too long or too short; rotate the **[DELAY]** knob, while speaking briefly into the microphone and then pausing, so as to set the desired hang time. Clockwise rotation of the **[DELAY]** control will increase the hang time.
 5. To exit from VOX operation, press the **[VOX]** button once more. We recommend doing this if you are going to leave your station, to prevent inadvertent activation of the VOX system by a ringing nearby telephone, speaker audio from a TV, etc.

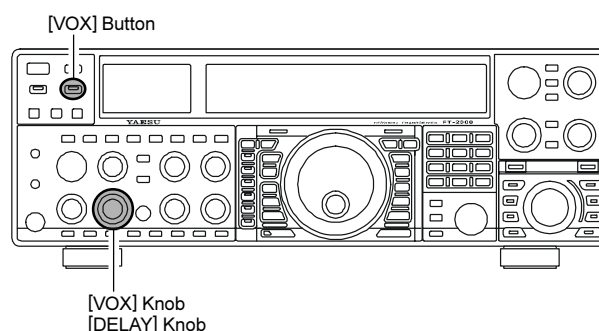

ADVICE:

- The Anti-Trip setting sets the negative feedback of receiver audio to the microphone, to prevent receiver audio from activating the transmitter (via the microphone) can be adjusted via Menu item "040 GEN ANTIVOX."
- VOX operation may be engaged on either Voice modes (SSB/AM/FM) and on AFSK-based Data modes. Use Menu item "137 tGen VOX SEL" (the selections are "niC (MIC)" and "dAtA (DATA)").

MONITOR (SSB/AM/FM MODES)

You may listen to the quality of your transmitted signal using the Monitor feature.

1. Press the **[MONI]** button. The "**[MONI]**" icon will appear in the display, indicating that the Monitor is turned on.
2. During transmission, rotate the **[MONI]** knob to adjust the audio level from the Monitor. Clockwise rotation of this knob will increase the volume level.
3. To switch the Monitor off again, press the **[MONI]** button once more. The "**[MONI]**" icon will turn off, confirming that the Monitor is now disengaged.

ADVICE:

- If you are using the speaker for monitoring, instead of headphones, excessive advancement of the **[MONI]** knob can cause feedback to occur. Additionally, this feedback can cause the VOX system to hang up in a loop, making it impossible to return to receive. Therefore, we recommend the use of headphones, if at all possible, or the minimum usable setting of the **[MONI]** knob, if the speaker must be used.
- Because the Monitor feature utilizes a sampling of the transmitter's IF signal, it can be very useful for checking the adjustment of the Speech Processor or Parametric Equalizer on SSB, and for checking the general signal quality on AM and FM.

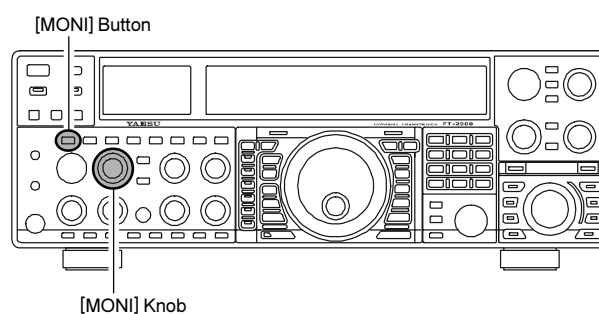

TRANSMITTER CONVENIENCE FEATURES

SPLIT OPERATION USING THE TX CLARIFIER (VFO-A OPERATION)

For split TX/RX operation in “casual” pile-ups, where the split is less than 10 kHz, the TX Clarifier (Offset Tuning) feature may be utilized.

1. Press the [TX CLAR] button.

The “TX” icon will appear in the Multi-Display Window in the display.



QUICK POINT:

The Clarifier is frequently used for receiver offset tuning. However, for DX pile-ups where the DX station is using a split of less than 10 kHz, the TX Clarifier function is usually the quickest way to set the transmitter to the desired offset frequency.

2. Rotate the [CLAR] knob to set the desired transmitter offset. A maximum split of ± 9.99 kHz may be set.
3. To exit from TX Clarifier operation, press the [TX CLAR] button once more. The “TX” icon will disappear from the Multi-Display Window.

ADVICE:

- ❑ To listen to the pile-up calling the DX station, so as to find the station currently being worked, you may press the [RX CLAR] button. Once you have zeroed in on the station calling the DX (use the SPOT function on CW for precise alignment of your frequency), you may then press the [RX CLAR] button again to cancel the RX Clarifier, and return to reception on the DX station’s frequency.
- ❑ Just as with receiver Clarifier operation, the amount of offset from the original VFO frequency will appear in the small display window.
- ❑ As with receiver Clarifier operation, when you turn the TX Clarifier off the last-used offset is not lost, and will be available if you turn the TX Clarifier back on. To clear the Clarifier offset, press the [CLEAR] button.

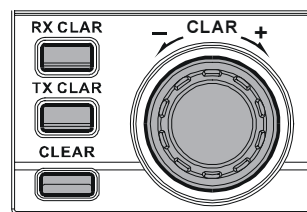
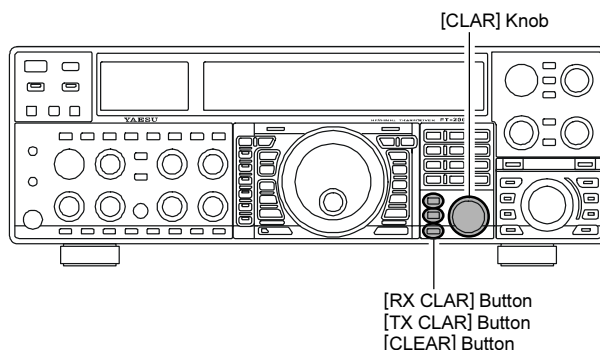

QUICK POINT:

When attempting to work a DX station on CW, in a split-frequency pile-up, remember that a large number of other stations may also be using Yaesu transceivers with capability similar to that of your **FT-2000**. On the DX side of the pile-up, everyone calling precisely on the same CW frequency will sound like a single tone! So you may have more success if you use the RX Clarifier to find a hole in the pile-up, instead of trying to zero-beat the last station worked by the DX station.

Clarifier Offset Bar Indicator

A visual depiction of the relative offset of the Clarifier may be displayed, using the Bar Indicator.

1. Press the [MENU] button; the Menu list will appear in the display.
2. Rotate the Main Tuning Dial knob to select Menu item “010 diSP BAR SEL.”
3. Rotate the [SUB VFO-B] knob to select “CLAR” from the available choices; the factory default is “C-tn.”
4. Press and hold in the [MENU] button for two seconds to save the new setting and exit to normal operation.



(TX Frequency < RX Frequency)



(TX Frequency = RX Frequency)



(TX Frequency > RX Frequency)

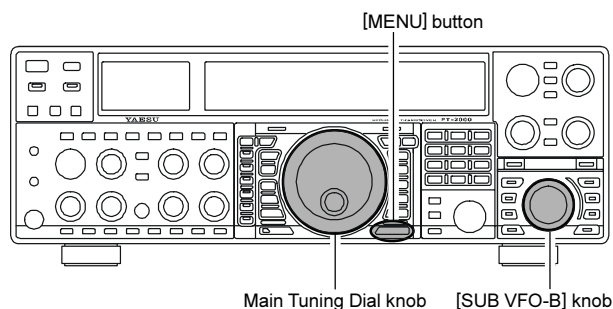

TRANSMITTER CONVENIENCE FEATURES

SPLIT-FREQUENCY OPERATION

A powerful capability of the **FT-2000** is its flexibility in Split Frequency operation, using the Main (VFO-A) and Sub (VFO-B) frequency registers. This makes the **FT-2000** especially useful for high-level DX-pedition use, as the Split operation capability is very advanced and easy to use.

1. Set the Main (VFO-A) frequency as desired.
2. Set the Sub (VFO-B) frequency.
3. Now press the **[SPLIT]** button. The front panel switch/LEDs will look like this:

Main (VFO-A)

[RX] switch “ON” (LED glows Green)

[TX] switch “OFF” (LED Off)

Sub (VFO-B)

[RX] switch “OFF” (LED Off)

[TX] switch “ON” (LED glows Red)

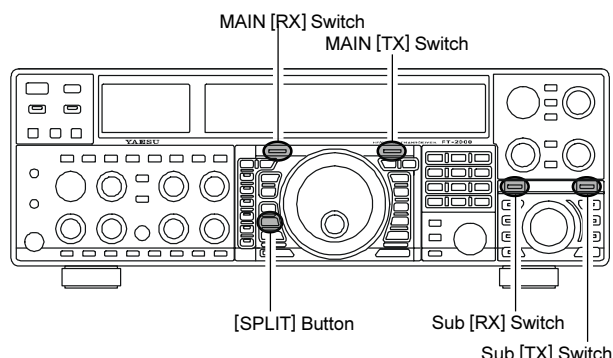
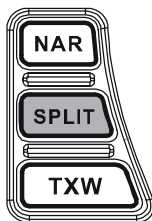

During Split operation, the Main (VFO-A) register will be used for reception, while the Sub (VFO-B) register will be used for transmission. If you press the **[SPLIT]** button once more, Split operation will be cancelled.

You may also press the Main **[TX]** switch located above and to the right of the Main Tuning Dial knob to return transmit frequency control to the Main (VFO-A) side, thereby cancelling Split operation.

ADVICE:

- ❑ During normal (non-split) VFO-A operation, you may simply press the Sub (VFO-B) **[TX]** switch (located above and to the right of the **[SUB VFO-B]** knob) to engage Split operation. The Sub **[TX]** indicator will glow Red when you press the switch.
- ❑ During Split operation, pressing the **[A↔B]** button will reverse the contents of the Main and Sub VFOs. Press the **[A↔B]** button once more to return to the original frequency alignment.
- ❑ During Split operation, if you press the **[RX]** switch above and to the right of the **[SUB VFO-B]** knob, you will engage Dual Receive operation, and now can listen to both sides of the DX pile-up, while transmitting on the Sub (VFO-B) frequency. This is very useful for maintaining the timing of your calls, while also monitoring both sides of the pile-up.
- ❑ During Split operation, you may also listen the TX frequency temporarily while pressing the **[TXW]** button (below and to the left of the Main Tuning Dial knob).
- ❑ It is possible to set different operating modes (for example, LSB and USB) on the two VFOs used during Split operation.
- ❑ During Split operation, it also is possible to set the Main and Sub VFOs to different Amateur bands. But remember that Dual Reception must be within the same band.

VFO Tracking Feature

In the default setting, the Main Band (VFO-A) frequency and Sub Band (VFO-B) frequency are changed individually using the Main Tuning Dial knob and the **[SUB VFO-B]** knob.

If you want to tune the Main Band (VFO-A) frequency and Sub Band (VFO-B) frequency together, the VFO Tracking feature is very useful.

Here is the procedure for activating the VFO Tracking feature:

1. Press the **[MENU]** button to engage the Menu mode.
2. Rotate the Main Tuning Dial knob to select Menu item “032 GEN TRACK.”
3. Rotate the **[SUB VFO-B]** knob to select the desired Tracking mode.
 - OFF: Disables the VFO Tracking feature.
 - bAND: When you change bands on the Main (VFO-A) side, the Sub (VFO-B) band’s VFO will automatically change to be the same as that of VFO-A.
 - FrEq: This function is the almost same as “bAND,” however, furthermore, the Sub band’s (VFO-B) frequency changes together with the Main Band’s (VFO-A) frequency when turning the Main Dial Tuning knob.
4. Press and hold in the **[MENU]** button for two seconds to lock in the new configuration and exit to normal operation.

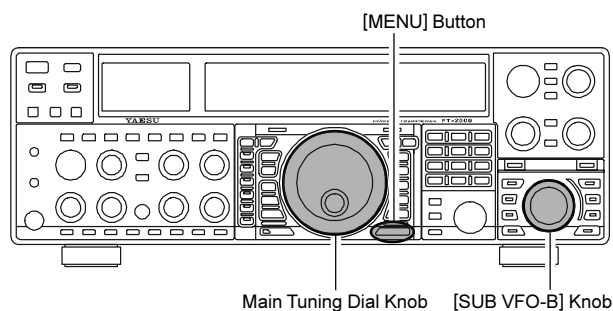

TRANSMITTER CONVENIENCE FEATURES

SPLIT-FREQUENCY OPERATION

Quick Split Operation

The Quick Split feature allows you to set a one-touch offset of +5 kHz to be applied to your radio's transmit frequency on the Sub (VFO-B), compared to the Main (VFO-A) frequency.

1. Start with regular transceiver operation on the Main (VFO-A) band.

MAIN (VFO-A)

[RX] switch "ON" (LED glows Green)

[TX] switch "ON" (LED glows Red)

SUB (VFO-B)

[RX] switch "OFF" (LED Off)

[TX] switch "OFF" (LED Off)

2. Press and hold in the [SPLIT] button for two seconds to engage the Quick Split feature, and apply a frequency 5 kHz above the Main (VFO-A) frequency to the Sub (VFO-B) frequency register. Press and hold in the [SPLIT] button for two seconds to increment the Main (VFO-A) frequency to +5 kHz.

The VFO configuration will then be:

MAIN (VFO-A)

[RX] switch "ON" (LED glows Green)

[TX] switch "OFF" (LED Off)

SUB (VFO-B)

[RX] switch "OFF" (LED Off)

[TX] switch "ON" (LED glows Red)

QUICK POINTS:

- The operating mode applied to the Sub (VFO-B) register will be the same as that in use on the Main (VFO-A) register.
- The offset of the Sub (VFO-B) from the Main VFO (VFO-A) is programmed via the Menu, and is set to +5 kHz at the factory. Other offsets may be selected, however, using the following procedure:

1. Press the [MENU] button to enter the Menu mode.
2. Rotate the Main Tuning Dial knob to select Menu item "031 gene Q SPLIT."
3. Rotate the [SUB VFO-B] knob to select the desired offset.
The available selections are -20kHz ~ +20kHz (factory default: +5 kHz).
4. When you have completed all adjustments, press and hold in the [MENU] button for two seconds to save the new setting and exit to normal operation. If you only press the [MENU] button momentarily to exit, any changes you performed will not be stored.

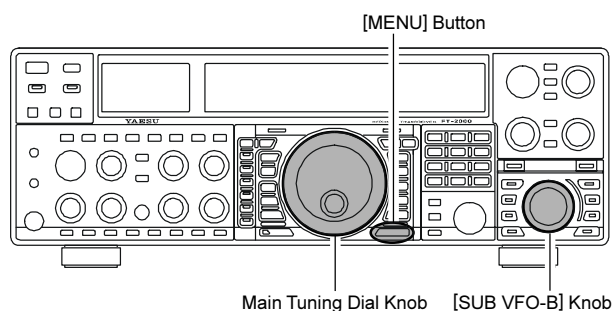
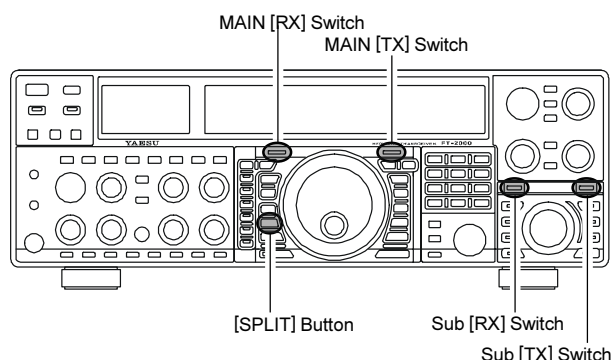
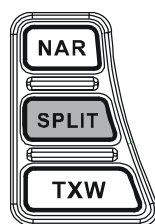

CW MODE OPERATION

The powerful CW operating capabilities of the **FT-2000** include operation using both an electronic keyer paddle and a “straight key” or emulation thereof, as is provided by a computer-based keying device.

SETUP FOR STRAIGHT KEY (AND STRAIGHT KEY EMULATION) OPERATION

Before starting, connect your key line(s) to the front and/or rear panel **KEY** jack(s), and be sure the **[KEYER]** button on the front panel is turned off for now.

1. Press the **[CW]** mode button to engage CW operation.

ADVICE:

- The operating mode is selected using the **[MODE]** buttons to the left of the Main Tuning Dial knob, and the VFO (A or B) to which the selection is applied is selected by the **[A]** or **[B]** button above the **[MODE]** buttons. Usually, the **[A]** button glow Red, signifying Main band (VFO-A) is being adjusted. Similarly, pressing the **[B]** button will cause its indicator to blink Orange for five seconds, signifying Sub band (VFO-B) adjustment. Therefore, press the **[A]** or **[B]** button to select the desired VFO, then press the **[CW]** button to select the CW mode.

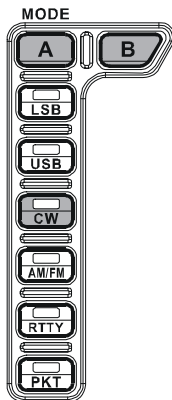

- If you press the **[CW]** button once more, after initially selecting CW, you will engage the “CW Reverse” mode (see page 82), whereby the “opposite” sideband injection is used, compared to the “normal” sideband. The CW LED will blink for three seconds if you select CW Reverse.
2. Rotate the Main Tuning Dial knob to select the desired operating frequency.
 3. Press the **[BK-IN]** button to engage automatic activation of the transmitter when you close the CW key. The “**[BK-IN]**” icon will appear in the display.



ADVICE:

- When you close your CW key, the transmitter will automatically be activated, and the CW carrier will be transmitted. When you release the key, transmission will cease after a brief delay; the delay time is user-programmable, per the discussion on page 83.
 - As shipped from the factory, the **FT-2000** TX/RX system for CW is configured for “Semi-break-in” operation. However, using Menu item “058 A1A BK-IN,” you may change this setup for full break-in (QSK) operation, whereby the switching is quick enough to hear incoming signals in the spaces between the dots and dashes of your transmission. This may prove very useful during contest and traffic-handling operations.
4. Operation using your CW key may now proceed.

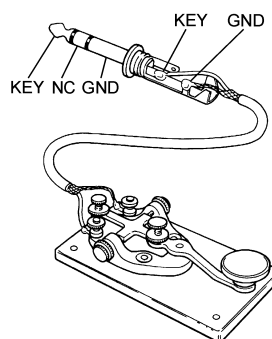
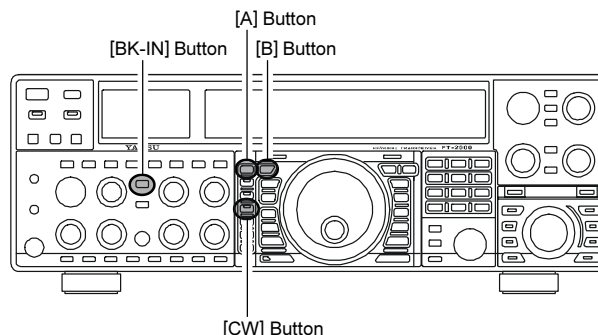

ADVICE:

- You can monitor your sending by pressing the **[MONI]** button, and adjusting the **[MONI]** knob for a comfortable listening level on the CW sidetone.
- If you set the **[VOX]** and **[BK-IN]** buttons to Off, you may practice your sending without having the signal go out over the air (sidetone only).
- If you reduce power using the **[RF PWR]** knob, the ALC meter reading will increase; this is normal and does not indicate any problem whatsoever (because increased ALC voltage is being used to lower the power).

TERMINOLOGY:

Semi-break-in

This is a pseudo-“VOX” mode used on CW, whereby the closure of the CW key will engage the transmitter, and release of the key will allow the receiver to recover after a short delay. No signals will be heard between the spaces between dots and dashes (unless the sending speed is extremely slow).

Full break-in

Full break-in (Also known as “Full QSK”) involves very fast switching between transmit and receive, such that incoming signals may be heard between the dots and dashes as you send them. This allows you to hear a station that suddenly starts transmitting on your frequency, while you are in the midst of a transmission.

USING THE BUILT-IN ELECTRONIC KEYS

Connect the cable from your keyer paddle to the front or rear panel **KEY** jack.

1. Press the **[CW]** mode button to engage CW operation.

ADVICE:

- The operating mode is selected using the **[MODE]** buttons to the left of the Main Tuning Dial knob, and the VFO (A or B) to which the selection is applied is selected by the **[A]** or **[B]** button above the **[MODE]** buttons. Usually, the **[A]** button glow Red, signifying Main band (VFO-A) is being adjusted. Similarly, pressing the **[B]** button will cause its indicator to blink Orange for five second, signifying Sub band (VFO-B) adjustment. Therefore, press the **[A]** or **[B]** button to select the desired VFO, then press the **[CW]** button to select the CW mode.
- If you press the **[CW]** button once more, after initially selecting CW, you will engage the “CW Reverse” mode (see page 82), whereby the “opposite” sideband injection is used, compared to the “normal” sideband. The CW LED will blink for three seconds if you select CW Reverse.

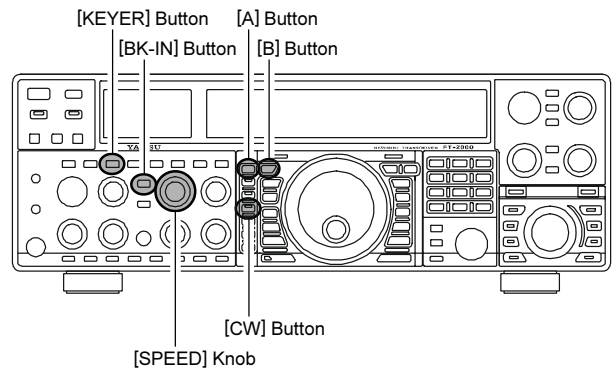
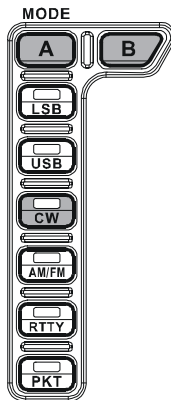

2. Rotate the Main Tuning Dial knob to select the desired operating frequency.

3. Press the **[KEYER]** button. The “**KEYER**” icon will appear in the display, confirming that the built-in Electronic Keyer is now active.



4. Rotate the **[SPEED]** knob to set the desired sending speed (4 ~ 60 WPM). Clockwise rotation of the **[SPEED]** knob will increase the keying speed.

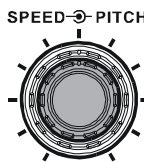

ADVICE:

- You may confirm the keying speed when turning the **[SPEED]** knob while pressing the **[KEYER]** button. The Sub (VFO-B) frequency display shows the keying speed.
- When you press either the “Dot” or “Dash” side of your paddle, the transmitter will automatically be activated.

5. If you press the **[BK-IN]** button, “semi-break-in” operation (discussed previously) will be engaged.



6. CW operation utilizing your paddle may now commence.

ADVICE:

When you utilize your keyer paddle, the transmitter will automatically be activated, and the CW characters (or a string of dots and dashes) will be transmitted. When you release the keyer paddle contacts, transmission will cease after a brief delay; the delay time is user-programmable, per the discussion on page 83.

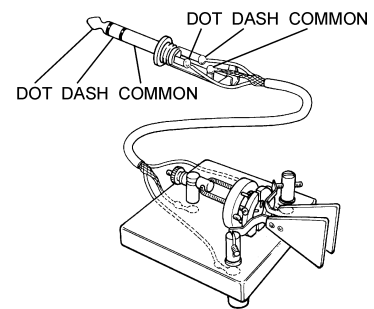

ADVICE:

If you reduce power using the **[RF PWR]** knob, the ALC meter reading will increase; this is normal and does not indicate any problem whatsoever (because increased ALC voltage is being used to lower the power).

Full Break-in (QSK) Operation

As shipped from the factory, the **FT-2000** TX/RX system for CW is configured for “Semi-break-in” operation. However, using Menu item “058 A1A BK-IN,” you may change this setup for full break-in (QSK) operation, whereby the switching is quick enough to hear incoming signals in the spaces between the dots and dashes of your transmission.

1. Press the **[MENU]** button to enter the Menu mode.
2. Rotate the Main Tuning Dial knob to select Menu item “058 A1A BK-IN.”
3. Rotate the **[SUB VFO-B]** knob to set this Menu item to “FULL.”
4. Press and hold in the **[MENU]** button for two seconds to save the new setting and exit.

CW MODE OPERATION

USING THE BUILT-IN ELECTRONIC KEYS

A number of interesting and useful features are available during Electronic Keyer operation.

Setting the Keyer Weight (Dot/Space:Dash) Ratio

The Menu may be used to adjust the Weight for the built-in Electronic Keyer. The default weighting is 3:1 (a dash is three times longer than a dot or space).

1. Press the **[MENU]** button to enter the Menu mode.
2. Rotate the Main Tuning Dial knob to select Menu item "060 A1A WEIGHT."
3. Rotate the **[SUB VFO-B]** knob to set the weight to the desired value. The available adjustment range is for a Dot/Space:Dash ratio of "2.5" ~ "4.5" (default value: "3.0").
4. When you are finished, press and hold in the **[MENU]** button for two seconds to save the new setting and exit to normal operation.

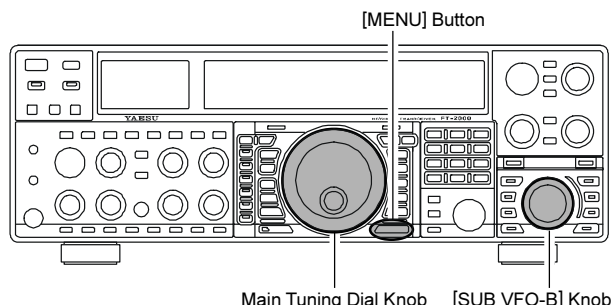

Selecting the Keyer Operating Mode

The configuration of the Electronic Keyer may be customized independently for the front and rear **KEY** jacks of the **FT-2000**. This permits utilization of Automatic Character Spacing (ACS), if desired, as well as the use of the electronic keyer via the front jack and a straight key or computer-driven keying line via the rear panel.

1. Press the **[MENU]** button to enter the Menu mode.
2. Rotate the Main Tuning Dial knob to select Menu item "052 A1A F-TYPE" (for the front **KEY** jack) or "054 A1A R-TYPE" (for the rear-panel's **KEY** jack).
3. Rotate the **[SUB VFO-B]** knob to set the keyer to the desired mode. The available selections are:
 - OFF: The built-in Electronic Keyer is turned off ("straight key" mode).
 - buG: Dots will be generated automatically by the keyer, but dashes must be sent manually.
 - ELE: Both dots and dashes will be generated automatically when you use your paddle.
 - ACS: Same as "ELE" except that the spacing between characters is precisely set by the keyer to be the same length as a dash (three dots in length)
4. When you are finished, press and hold in the **[MENU]** button for two seconds to save the new setting and exit to normal operation.

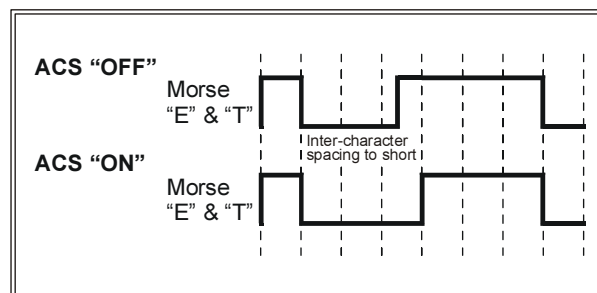
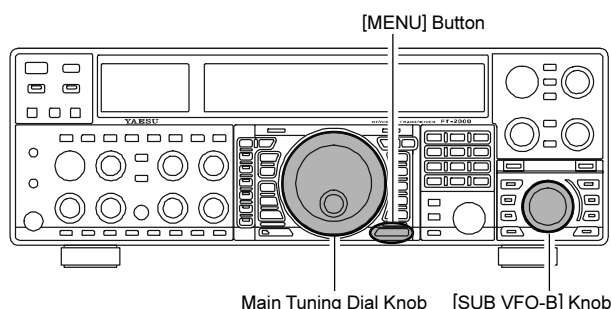

CW CONVENIENCE FEATURES

CW SPOTTING (ZERO-BEATING)

“Spotting” (zeroing in on another CW station) is a handy technique for ensuring that you and the other station are precisely on the same frequency.

For everyday operation, the (CW) [PITCH] knob allows you to set the center of the receiver passband, as well as the offset pitch of your CW carrier signal, to the tone pitch you prefer to listen to.

The Tuning Offset Indicator in the display may also be moved so you can adjust your receiver frequency to center the incoming station on the pitch corresponding to that of your transmitted signal.

Using the SPOT System

While pressing the front panel’s [SPOT] button, the Spot tone will be heard and the Sub (VFO-B) frequency display will show the Spot tone frequency. This tone corresponds to the pitch of your transmitted signal, and if you adjust the receiver frequency to match the pitch of the received CW signal to that of the Spot tone, your transmitted signal will be precisely matched to that of the other station.

Release the [SPOT] button to turn the Spot tone off.

ADVICE:

- ❑ In a tough DX pile-up, you may actually want to use the SPOT system to find a “gap” in the spread of calling stations, instead of zeroing in precisely on the last station being worked by the DX station. From the DX side, if a dozen or more operators (also using Yaesu’s SPOT system) all call precisely on the same frequency, their dots and dashes merge into a single, long tone that the DX station cannot decipher. In such situations, calling slightly higher or lower may get your call through.
- ❑ The Tuning Offset Indicator in the display may be utilized for CW frequency adjustment, as well. Its configuration is set via Menu item “010 diSP BAR SEL” at the factory, and the Tuning Offset Indicator is already set to the “CW TUNE” selection.

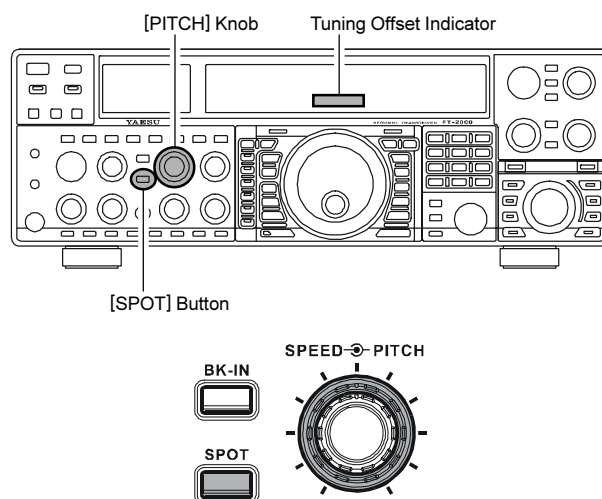
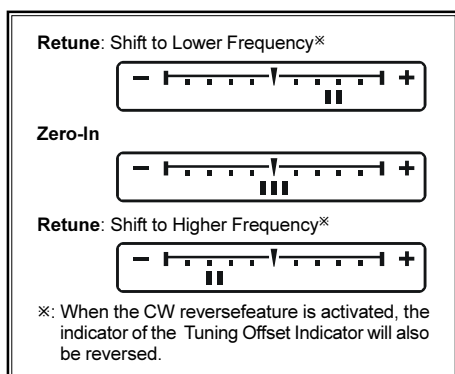

QUICK POINTS:

- ❑ The CW Spotting process utilizes the Spot tone or the Tuning Offset Indicator, with the actual offset pitch being set by the [PITCH] knob on the front panel. The offset pitch may be set to any frequency between 300 Hz and 1050 Hz, in 50 Hz steps, and you can either match tones audibly (using the [SPOT] button) or align the receiver frequency so that the central red LED on the Tuning Offset Indicator lights up. Note that there are 21 “dots” on the Tuning Offset Indicator, and depending on the resolution selected, the incoming CW signal may fall outside the visible range of the bar indicator, if you are not reasonably close to the proper alignment of tones.
- ❑ The displayed frequency, on CW, normally reflects the “zero beat” frequency of your offset carrier. That is, if you were to listen on USB on 14.100.00 MHz to a signal with a 700 Hz offset, the “zero beat” frequency of that CW carrier would be 14.000.70 MHz; the latter frequency is what the FT-2000 displays, by default. However, you can change the display to be identical to what you would see on SSB by using Menu item “061 A1A FRQDISP” and setting it to “dlr” instead of its default “OFSt” setting.

CW CONVENIENCE FEATURES

USING CW REVERSE

If you experience a difficult interference situation, where an interfering station cannot readily be eliminated, you may wish to try receiving using the opposite sideband. This may throw the interfering station's frequency in a direction that may lend itself more readily to rejection.

1. To start, let's use a typical example where you have set the CW mode (using the default "USB" injection) onto the Main (VFO-A) receiver.
2. Now be sure your mode selection is still set for the Main (VFO-A) register, and press the [CW] mode button once more. The "LSB" LED will blink for three seconds, indicating that the "LSB" injection side has now been selected.
3. When using Dual Receive, press the [B] button, then (within five seconds of pressing the [B] button) press the [CW] button to engage CW Reverse on the Sub (VFO-B) receiver, in exactly the same way as for the Main (VFO-A) receiver.
4. Press the [CW] mode button once more to return to the normal (USB) injection side and cancel CW Reverse operation (the "USB" LED will blink for three seconds).

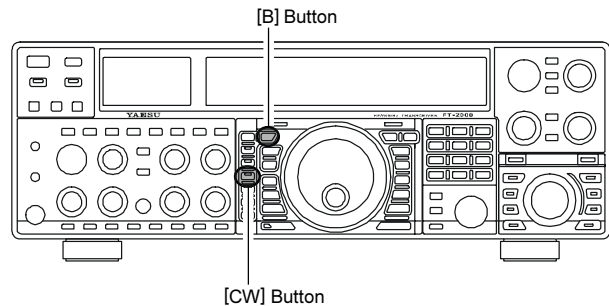
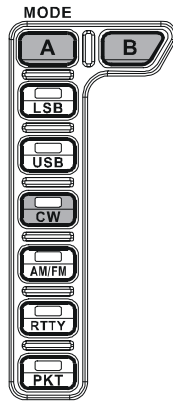

NOTES:

- When CW Reverse is engaged, the Tuning Offset Indicator action will concurrently be reversed as to its indication.
- When the incoming signal pitch tone is properly aligned, the central red marker lights up whether or not CW Reverse is engaged.

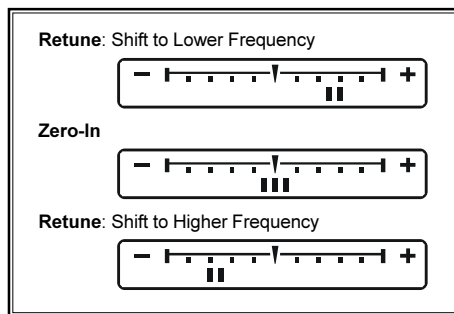

In the illustration, Figure A demonstrates the normal CW injection setup, using the USB side. In Figure B, CW Reverse has been engaged, so as to receive using LSB-side injection to eliminate interference.

The beneficial effect of switching sidebands can clearly be seen in this example.

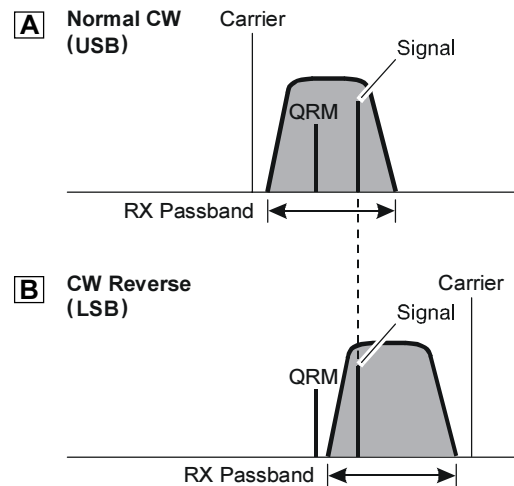

CW CONVENIENCE FEATURES

CW DELAY TIME SETTING

During semi-break-in (not QSK) operation, the hang time of the transmitter, after you have finished sending, may be adjusted to a comfortable value consistent with your sending speed. This is the functional equivalent to the “VOX Delay” adjustment used on voice modes, and the delay may be varied anywhere between 20 milli-seconds ([**DELAY**] knob set fully counter-clockwise) and 5 seconds (fully clockwise).

1. Press the [**BK-IN**] button to enable CW transmission (Menu item “058 A1A BK-IN” must be set to “SEni”).
2. Start sending, and adjust the [**DELAY**] knob so that the hang time is as you prefer for comfortable operation.

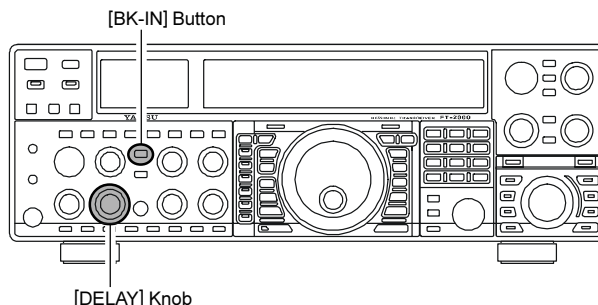

CW PITCH ADJUSTMENT

Rotation of the front panel's [**PITCH**] knob will allow adjustment of the center frequency of the receiver pass-band, as well as the pitch of your offset CW carrier, to the tone you prefer. The tone may be varied between 300 Hz and 1050 Hz, in 50 Hz steps.

ADVICE:

You may confirm the Spot tone frequency when turning the [**PITCH**] knob while pressing the [**SPOT**] button. Sub (VFO-B) frequency display will show the Spot tone frequency.

TERMINOLOGY:

CW Pitch: If you tuned to an exact “zero beat” on an incoming CW signal, you could not copy it (“Zero beat” implies a 0 Hz tone). Therefore, the receiver is offset several hundreds of Hz (typically), so as to allow your ear to detect the tone. The BFO offset associated with this tuning (that produces the comfortable audio tone) is called the CW Pitch.

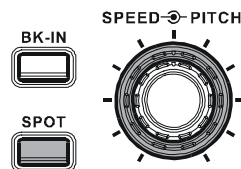
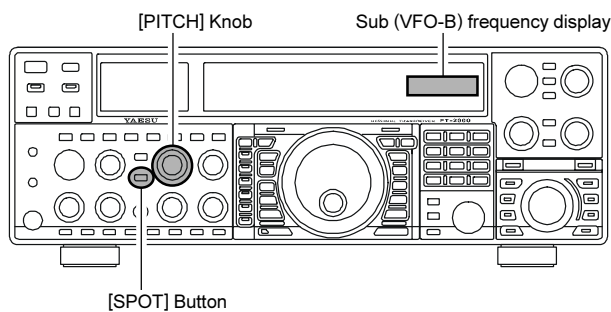

CW CONVENIENCE FEATURES

CONTEST MEMORY KEYS

The **FT-2000** is capable of the automatic sending of CW messages (as you might do in a contest). Two techniques for message storage are available: you may either send the desired message contents using your keyer paddle (“*Message Memory*”), or you may input the text characters using the Main Dial Tuning knob and **[SUB VFO-B]** knobs (“*Text Memory*”).

Message Memory

Five memory channels capable of retaining 50 characters total are provided (using the PARIS standard for characters and word length).

Example: CQ CQ CQ DE W6DXC K (19 characters)

--- · · · · · --- · · · · · --- · · · · · --- · · · · · --- · · · · ·
(C) (Q) (C) (Q) (C) (Q) (D) (E) (W) (6) (D) (X) (C) (K)

STORING A MESSAGE INTO MEMORY

1. Press the **[MENU]** button to enter the Menu mode.
2. Rotate the Main Tuning Dial knob to select the CW Memory Register into which you wish to store the message; for now, we are just selecting the message entry technique (Keyer entry).
020 tEy CW MEM1
021 tEy CW MEM2
022 tEy CW MEM3
023 tEy CW MEM4
024 tEy CW MEM5
3. Rotate the **[SUB VFO-B]** knob to set the selected Memory Register to “tyP2.” If you want to use your keyer paddle for message entry on all memories, set all five Menu items (#020 ~ 024) to “tyP2.”
4. Press and hold in the **[MENU]** button for two seconds to save the new settings and exit.

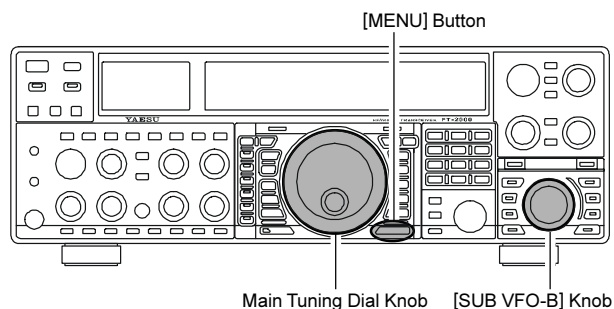

MESSAGE MEMORY PROGRAMMING (USING YOUR PADDLE)

1. Set the operating mode to CW.
2. Set the **[BK-IN]** button to Off.
3. Turn the internal Electronic Keyer On by pressing the **[KEYER]** button, if necessary.
4. Press the **[F5(MEM)]** button on the front panel.
5. Press the **[F1(CH1)] ~ [F4(CH-4)]** button to begin the memory storage process.
6. Send the desired message using your keyer paddle.
7. Press the **[F5(MEM)]** button once more at the end of your message. Up to 50 characters may be stored among the five memories.

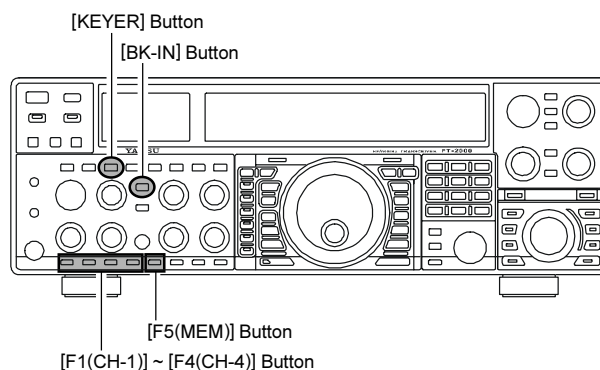

NOTE:

You must exercise care in sending to ensure that the spaces between letters and words are accurately done; if your timing is off, the spacing may not come out right in the stored message.

For ease in setting up the keyer memories, we recommend you set Menu item “051 A1A F-TYPE” and/or “053 A1A R-TYPE” to “ACS” (Automatic Character Spacing) while you are programming the keyer memories.

TERMINOLOGY:

PARIS Word Length: By convention in the Amateur industry (utilized by ARRL and others), the length of one “word” of CW is defined as the length of the Morse Code characters spelling the word “PARIS.” This character (dot/dash/space) length is used for the rigorous definition of code speed in “words per minute.”

CW CONVENIENCE FEATURES

CONTEST MEMORY KEYS

CHECKING THE CW MEMORY CONTENTS

1. Be sure that Break-in is still turned Off by the **[BK-IN]** button.
2. Press the **[MONI]** button to enable the CW monitor.
3. Press the **[F1(CH1)]** ~ **[F4(CH-4)]** button to check your work. You will hear the results in the sidetone, but no RF energy will be transmitted.

NOTE:

Adjust the monitor level using the **[MONI]** knob.

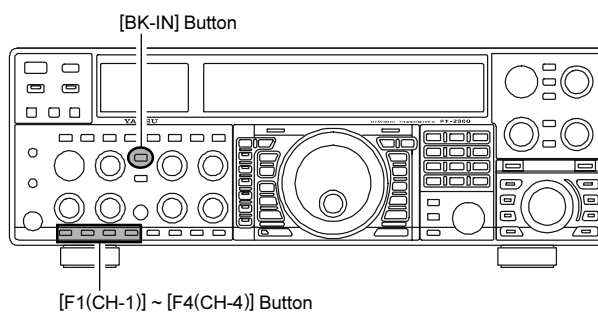

ON-THE-AIR CW MESSAGE PLAYBACK

1. Press the **[BK-IN]** button to enable transmission. Either Full- or Semi-break-in will be engaged, depending on the setting of Menu item "058 A1A BK-IN."
2. Press the **[F1(CH1)]** ~ **[F4(CH-4)]** button to transmit the programmed message.

NOTE:

If you subsequently decide to use the "Text Memory" technique for memory storage, please note that the contents of a message stored using keyer paddle input will not be transferred over when you select "Text Memory technique" on a particular memory register (the Menu Mode Setting is set to "tyP1").

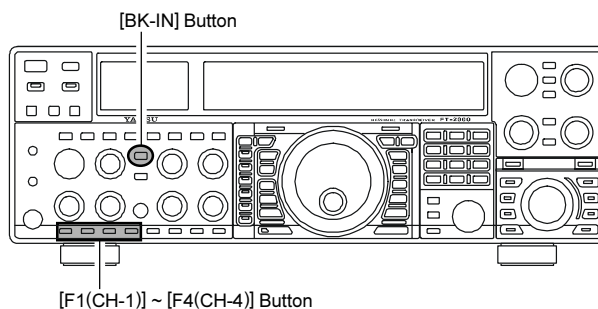

Transmitting in the Beacon Mode

It is possible to transmit, repetitively in a "Beacon" mode, any message programmed either via paddle input or via the "Text" input method. The time delay between message repeats may be set anywhere between 0 and 255 seconds via Menu item "017 tEy BEACON." If you do not wish the message to repeat in a "Beacon" mode, please set this Menu item to "off." Press the **[F1(CH1)]** ~ **[F4(CH-4)]** button, depending on the register into which the Beacon message is stored. Repetitive transmission of the Beacon message will begin. Press one of these keys once more to halt the Beacon transmissions.

CW CONVENIENCE FEATURES

CONTEST MEMORY KEYS

TEXT Memory

The four channels of CW message memory (up to 50 characters total) may also be programmed using a text-entry technique. This technique is somewhat slower than when you send the message directly from your keyer paddle, but accuracy of character spacing is ensured.

Example 1: CQ CQ CQ DE W6DXC K} (20 characters)

And we will utilize another powerful feature of the CW Memory Keyer, the sequential Contest Number (“Countup”) feature.

Example 2: 599 10 200 # K} (15 characters)

STORING A MESSAGE INTO MEMORY

1. Press the **[MENU]** button to enter the Menu mode.
2. Rotate the Main Tuning Dial knob to select the CW Memory Register into which you wish to store the message; for now, we are just selecting the message entry technique (Keyer entry).
020 tEy CW MEM1
021 tEy CW MEM2
022 tEy CW MEM3
023 tEy CW MEM4
024 tEy CW MEM5
3. Rotate the **[SUB VFO-B]** knob to set the selected Memory Register to “tyP1.” If you want to text message entry on all memories, set all five Menu items (#020 ~ 024) to “tyP1.”
4. Press and hold in the **[MENU]** button to save the new settings and exit.

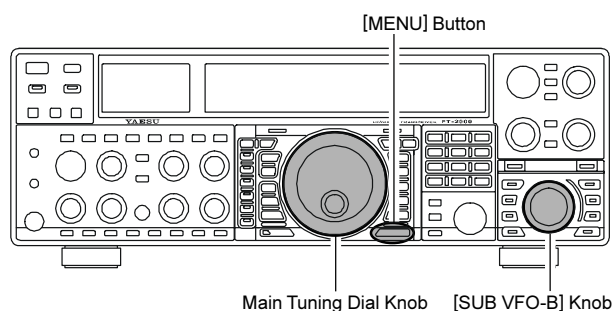

TEXT MESSAGE PROGRAMMING

1. Press the **[CW]** mode button to set the operating mode to CW.
2. Be sure that Break-in is Off by pressing the **[BK-IN]** button, if necessary.
3. Press the **[F5(MEM)]** button on the front panel.
4. Press the **[F1(CH1)]** ~ **[F4(CH-4)]** button to select the desired Message Memory Register into which you wish to program the text.
5. Use the Main Tuning Dial knob to set the cursor position and use the **[SUB VFO-B]** knob to choose the letter/number to be programmed in each slot of the memory. In the case of the second example above, the “#” character designates the slot where the Contest Number will appear.
6. When the message is complete, add the “}” character at the end to signify the termination of the message.
7. Press and hold in the **[F5(MEM)]** button for 2 seconds to exit, once all characters (including “}”) have been programmed.

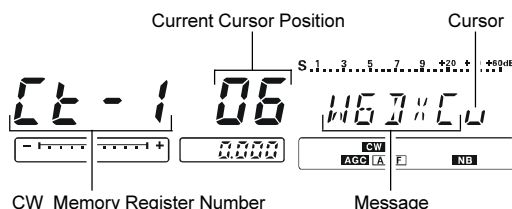
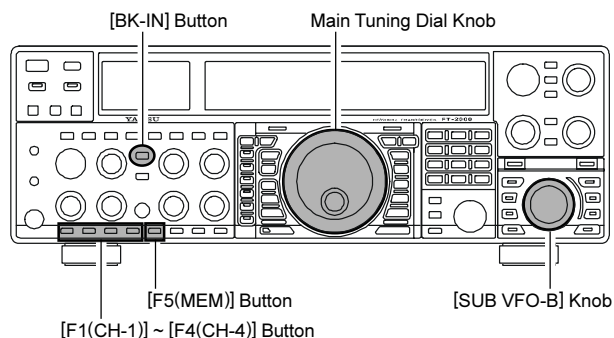

ADVICE:

Deleting Previously-stored Characters

Use the Main Tuning Dial knob to select the last correct letter in the message. Now rotate the **[SUB VFO-B]** knob to select the “}” character; everything after the “}” character will be deleted.

CW CONVENIENCE FEATURES

CONTEST MEMORY KEYS

CHECKING THE CW MEMORY CONTENTS

1. Be sure that Break-in is still turned Off by the **[BK-IN]** button.
2. Press the **[MONI]** button to enable the CW monitor.
3. Press the **[F1(CH1)] ~ [F4(CH-4)]** button to check your work. You will hear the results in the sidetone, but no RF energy will be transmitted.

NOTE:

Adjust the monitor level using the **[MONI]** knob.

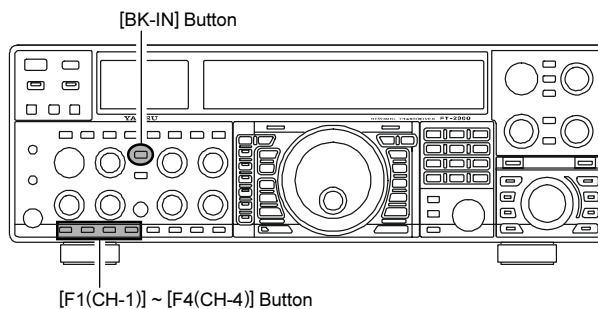

ON-THE-AIR CW MESSAGE PLAYBACK

1. Press the **[BK-IN]** button to enable transmission. Either Full- or Semi-break-in will be engaged, depending on the setting of Menu item "058 A1A BK-IN."
2. Press the **[F1(CH1)] ~ [F4(CH-4)]** button to transmit the programmed message.

NOTE:

If you subsequently decide to use the "Message Memory" technique for memory storage, please note that the contents of a message stored using text input will not be transferred over when you select "Message Memory technique" on a particular memory register (the Menu Mode Setting is set to "tyP2").

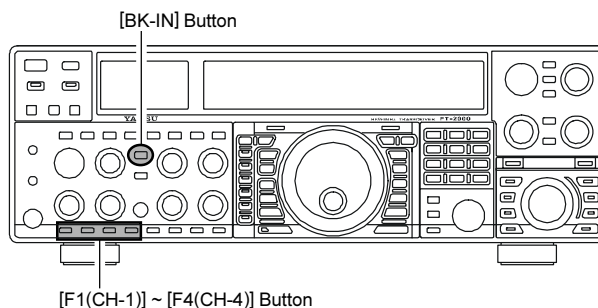

Contest Number Programming

Use this process if you are starting a contest, or if you somehow get out of sync with the proper number in the middle of a contest.

1. Press the **[MENU]** button to enter the Menu mode.
2. Rotate the Main Tuning Dial knob to select Menu item "019 tEy CONTEST."
3. Rotate the **[SUB VFO-B]** knob to set the Contest Number to the desired value.

Advice:

Press the **[CLEAR]** button (located below and to the left of the **[CLAR]** knob) to reset the Contest Number to "1."

4. Press and hold in the **[MENU]** button for two seconds to store the new number and exit to normal operation.

Decrementing the Contest Number

Use this process if the current contest number gets slightly ahead of the actual number you want to send (in case of a duplicate QSO, for example).

Press the **[F6(DEC)]** button on the front panel. The current Contest Number will be reduced by one. Press the **[F6(DEC)]** button as many times as necessary to reach the desired number. If you go too far, use the "Contest Number Programming" technique desired above.

TEXT	DISPLAY	CW CODE	TEXT	DISPLAY	CW CODE	TEXT	DISPLAY	CW CODE	TEXT	DISPLAY	CW CODE
!		SN	(KN	/		DN	@		@
"		AF)		KK	:		OS	[-
#		-	*		-	;		KR	\		AL
\$		SX	+		AR	<		-]		-
%		KA	,		MIM	=		BT	^		-
&		AS	-		DU	>		-	_		IQ
'		WG	.		AAA	?		IMI	}		-

CW CONVENIENCE FEATURES

CONTEST MEMORY KEYER (USING THE OPTIONAL FH-2 REMOTE CONTROL KEYPAD)

You may also utilize the CW message capability of the **FT-2000** from the optional **FH-2** Remote Control Keypad, which plugs into the rear panel's **REM** jack.

Message Memory

Five memory channels capable of retaining 50 characters total are provided (using the PARIS standard for characters and word length).

Example: CQ CQ CQ DE W6DXC K (19 characters)

STORING A MESSAGE INTO MEMORY

1. Press the **[MENU]** button to enter the Menu mode.
2. Rotate the Main Tuning Dial knob to select the CW Memory Register into which you wish to store the message; for now, we are just selecting the message entry technique (Keyer entry).
020 tEy CW MEM1
021 tEy CW MEM2
022 tEy CW MEM3
023 tEy CW MEM4
024 tEy CW MEM5
3. Rotate the **[SUB VFO-B]** knob to set the selected Memory Register to "tyP2." If you want to use your keyer paddle for message entry on all memories, set all five Menu items (#020 ~ 024) to "tyP2."
4. Press and hold in the **[MENU]** button to save the new settings and exit.

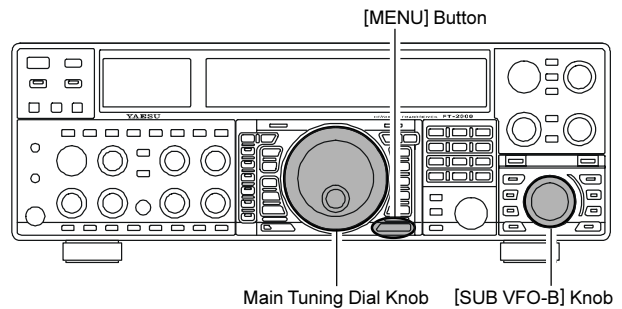

CW CONVENIENCE FEATURES

CONTEST MEMORY KEYS (USING THE OPTIONAL FH-2 REMOTE CONTROL KEYPAD)

MESSAGE MEMORY PROGRAMMING (USING YOUR PADDLE)

1. Set the operating mode to CW.
2. Set the [BK-IN] button to Off.
3. Turn the internal Electronic Keyer On by pressing the [KEYER] button, if necessary.
4. Press the FH-2's [MEM] key.

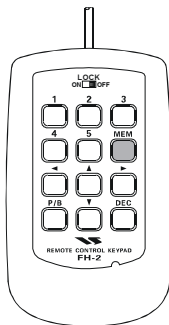

5. Press the [1] ~ [5] key on the FH-2 to begin the memory storage process.

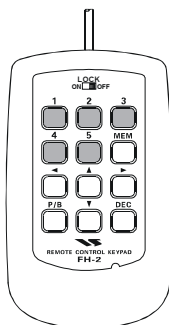

6. Send the desired message using your keyer paddle.
7. Press the [MEM] key on the FH-2 once more at the end of your message. Up to 50 characters may be stored among the five memories.

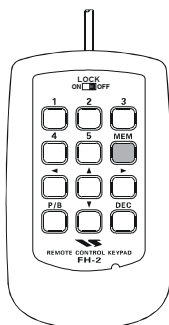

NOTE:

You must exercise care in sending to ensure that the spaces between letters and words are accurately done; if your timing is off, the spacing may not come out right in the stored message.

For ease in setting up the keyer memories, we recommend you set Menu item "052 A1A F-TYPE" and/or "054 A1A R-TYPE" to "ACS" (Automatic Character Spacing) while you are programming the keyer memories.

CHECKING THE CW MEMORY CONTENTS

1. Be sure that Break-in is still turned Off.
2. Press the [MONI] button to enable the CW monitor.
3. Press the FH-2's [1] ~ [5] key to check your work. You will hear the results in the sidetone, but no RF energy will be transmitted.

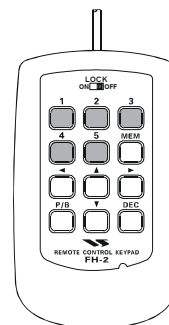

NOTE:

You may adjust the monitor level using the [MONI] knob.

ON-THE-AIR CW MESSAGE PLAYBACK

1. Press the [BK-IN] button to enable transmission. Either Full- or Semi-break-in will be engaged, depending on the setting of Menu item "058 A1A BK-IN."
2. Press the FH-2's [1] ~ [5] key to transmit the programmed message.

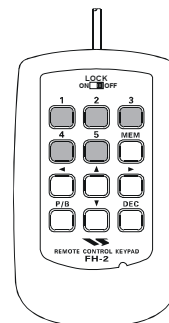

NOTE:

If you subsequently decide to use the "Text Memory" technique for memory storage, please note that the contents of a message stored using keyer paddle input will not be transferred over when you select "Text Memory technique" on a particular memory register (the Menu Mode Setting is set to "tyP1").

CW CONVENIENCE FEATURES

CONTEST MEMORY KEYS (USING THE OPTIONAL FH-2 REMOTE CONTROL KEYPAD)

TEXT Memory

The five channels of CW message memory (up to 50 characters total) may also be programmed using a text-entry technique. This technique is somewhat slower than when you send the message directly from your keyer paddle, but accuracy of character spacing is ensured.

Example 1: CQ CQ CQ DE W6DXC K} (20 characters)

And we will utilize another powerful feature of the CW Memory Keyer, the sequential Contest Number (“Countup”) feature.

Example 2: 599 10 200 # K} (15 characters)

TEXT MEMORY STORAGE

1. Press the **[MENU]** button to enter the Menu mode.
2. Rotate the Main Tuning Dial knob to select the CW Memory Register into which you wish to store the message; we are now selecting the message entry technique (Text entry).
020 tEy CW MEM1
021 tEy CW MEM2
022 tEy CW MEM3
023 tEy CW MEM4
024 tEy CW MEM5
3. Rotate the **[SUB VFO-B]** knob to set the selected Memory Register to “tyP1.”
4. Press and hold in the **[MENU]** button for two seconds to save the new settings and exit.

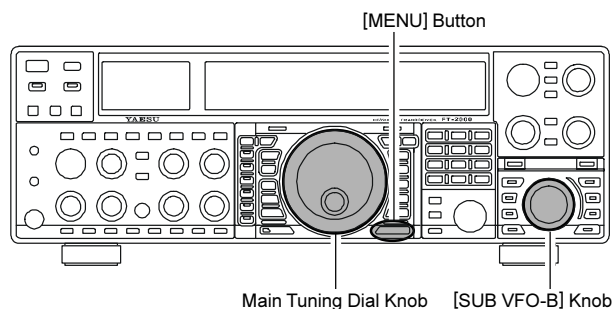

TEXT MESSAGE PROGRAMMING

1. Press the **[CW]** mode button to set the operating mode to CW.
2. Be sure that Break-in is Off by pressing the **[BK-IN]** button, if necessary.
3. Press the **FH-2**'s **[MEM]** key.
5. Use the **FH-2**'s **[◀]** and **[▶]** keys to set the cursor position and use the **[▲]** and **[▼]** keys to choose the letter/number to be programmed in each slot of the memory. In the case of the second example above, the “#” character designates the slot where the Contest Number will appear.

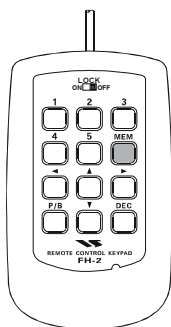

4. Press the **FH-2**'s **[1] ~ [5]** key to select the desired Message Memory Register into which you wish to program the text.

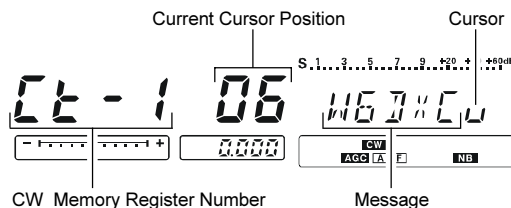
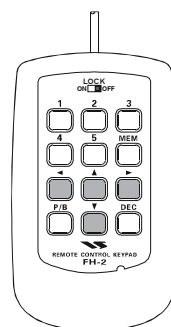
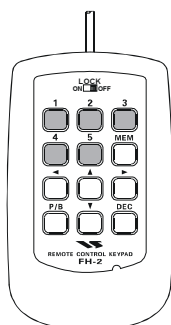

ADVICE:

You may also use the Main Tuning Dial knob and the **[SUB VFO-B]** knobs to program the message characters.

CW CONVENIENCE FEATURES

CONTEST MEMORY KEYS (USING THE OPTIONAL FH-2 REMOTE CONTROL KEYPAD)

- When the message is complete, add the “}” character at the end to signify the termination of the message.
- Press and hold in the FH-2’s [MEM] key for 2 seconds to exit, once all characters (including “}”) have been programmed.

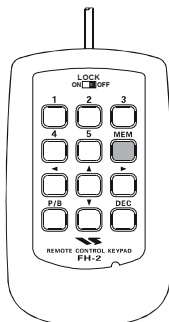

ADVICE:

Deleting Previously-stored Characters

Use the FH-2’s [◀] and [▶] keys or Main Tuning Dial knob to select the last correct letter in the message. Now use the [▲] and [▼] keys or [SUB VFO-B] knob to select the “}” character; everything after the “}” character will be deleted.

CHECKING THE CW MEMORY CONTENTS

- Be sure that Break-in is still turned Off.
- Press the [MONI] button to enable CW monitor.
- Press the FH-2’s [1] ~ [5] key to check your work. You will hear the results in the sidetone, but no RF energy will be transmitted.

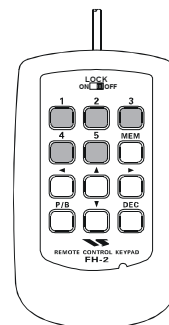

NOTE:

You may adjust the monitor level using the [MONI] knob.

ON-THE-AIR CW MESSAGE PLAYBACK

- Press the [BK-IN] button to enable transmission. Either Full- or Semi-break-in will be engaged, depending on the setting of Menu item “058 A1A BK-IN.”
- Press the FH-2’s [1] ~ [5] key to transmit the programmed message.

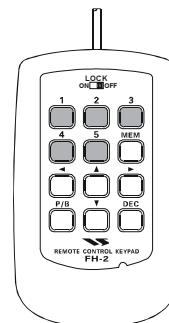

NOTE:

If you subsequently decide to use the “Message Memory” technique for memory storage, please note that the contents of a message stored using text input will not be transferred over when you select “Message Memory technique” on a particular memory register (the Menu Mode Setting is set to “tyP2”).

Decrementing the Contest Number

By pressing the FH-2’s [DEC] key momentarily, you may reduce the current Contest Number by one.

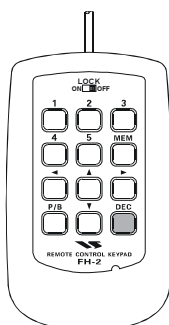

FM MODE OPERATION

BASIC OPERATION

1. Press the **[AM/FM]** button several times, until the imbedded LED glows orange, to select the FM operating mode.

QUICK POINT:

When the **[AM/FM]** button glows red, it indicates AM operation.

2. Rotate the Main Tuning Dial knob (in the case of Main (VFO-A) operation) to select the desired operating frequency. Pressing the microphone's **[UP]** or **[DWN]** button will cause frequency change in 5 kHz steps.
3. Press the microphone's **PTT** switch (or press the front panel **[MOX]** button) to transmit. Speak into the microphone in a normal voice level. Release the **PTT** or **[MOX]** switch to return to receive.
4. Adjustment of the microphone gain may be accomplished in two ways. At the factory, a default level has been programmed that should be satisfactory for most situations. However, using Menu item "072 F3E MICGAIN," you may set a different fixed value, or choose the "ur" option, which then lets you use the front panel **[MIC]** knob to set the microphone gain in the FM mode.

ADVICE:

- ❑ The Transmit Monitor is another helpful way of verifying proper adjustment of the FM MIC Gain. By pressing the **[MONI]** button then adjusting the **[MONI]** knob for a comfortable listening level while you are transmitting, you will be able to hear the difference in deviation as you make adjustments.
- ❑ FM is only used in the 28 MHz and 50 MHz Amateur bands covered in the **FT-2000**. Please do not use FM on any other bands.

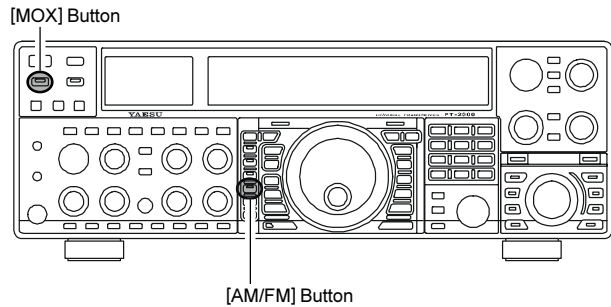
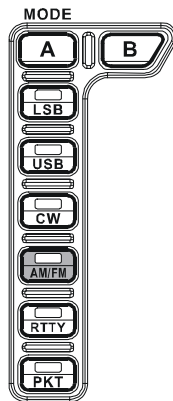

REPEATER OPERATION

The **FT-2000** may be utilized on 29 MHz and 50 MHz repeaters.

1. Rotate the Main Tuning Dial knob to the output frequency (downlink) from the repeater.
2. If CTCSS Tone operation is desired/needed, press and hold in the **[AM/FM]** button for two seconds to engage the CTCSS mode.
3. Rotate the Main Tuning Dial knob to select the desired CTCSS mode. If you just need to send the uplink encoding tone, select "tn." For encode/decode operation, choose "ts" instead. The available choices are "oFF" → "tn" → "ts" → "oFF."
4. Rotate the **[SUB VFO-B]** knob to select the desired CTCSS Tone to be used. A total of 50 standard CTCSS tones are provided (see the CTCSS Tone Chart).
5. Press the **[AM/FM]** Mode button to select the desired repeater shift direction. The selections are "S" → "+" → "-" → "S" where "S" represents "Simplex" operation (not used on a repeater).
6. Press and hold in the **[AM/FM]** button for two seconds to exit from the repeater setup mode.
7. Close the microphone's **PTT** switch (or press the **[MOX]** button) to begin transmission. You will observe that the frequency has shifted to correspond to the programming you set up in the previous steps. Speak into the microphone in a normal voice level, and release the **PTT** switch or **[MOX]** button to return to the receive mode.

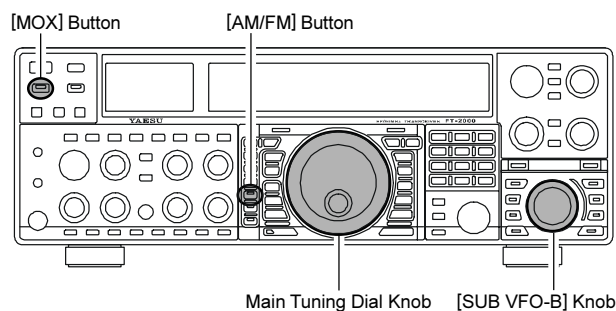

CTCSS Operation
 tn: Tone Encoder
 ts: Tone Squelch
 oFF: OFF

Repeater Shift Direction
 -: Minus Shift
 +: Plus Shift
 S: Simplex

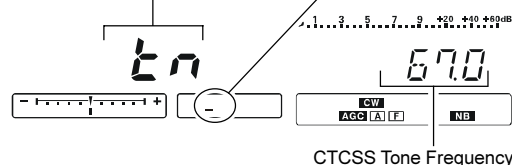

CTCSS TONE FREQUENCY (Hz)							
67.0	69.3	71.9	74.4	77.0	79.7	82.5	85.4
88.5	91.5	94.8	97.4	100.0	103.5	107.2	110.9
114.8	118.8	123.0	127.3	131.8	136.5	141.3	146.2
151.4	156.7	159.8	162.2	165.5	167.9	171.3	173.8
177.3	179.9	183.5	186.2	189.9	192.8	196.6	199.5
203.5	206.5	210.7	218.1	225.7	229.1	233.6	241.8
250.3	251.4	-	-	-	-	-	-

ADVICE:

The conventional repeater shift used on 29 MHz is 100 kHz, while on the 50 MHz band the shift may vary between 500 kHz and 1.7 MHz (or more). To program the proper repeater shift, use Menu items "073 F3E 28 RPT" (28 MHz) and "074 F3E 50 RPT" (50 MHz), as appropriate.

You may also use "Tone Squelch" whereby your receiver will be kept silent until an incoming signal bearing a matching CTCSS tone is received. Your receiver's squelch will then open in response to the reception of the required tone.

1. Rotate the Main tuning Dial to the output frequency (downlink) from the repeater.
2. Press and hold in the **[AM/FM]** button for two seconds to engage the CTCSS mode.
3. Rotate the Main Tuning Dial to choose "ts" from the available choices of "oFF" → "tn" → "ts" → "oFF."
4. Rotate the **[SUB VFO-B]** knob to select the desired CTCSS Tone to be used. A total of 50 standard CTCSS tones are provided (see the CTCSS Tone Chart).
5. Press and hold in the **[AM/FM]** button for two seconds. On the display, just below the "10 Hz" frequency digit, a small "d" will indicate that the Tone Decoder is engaged.

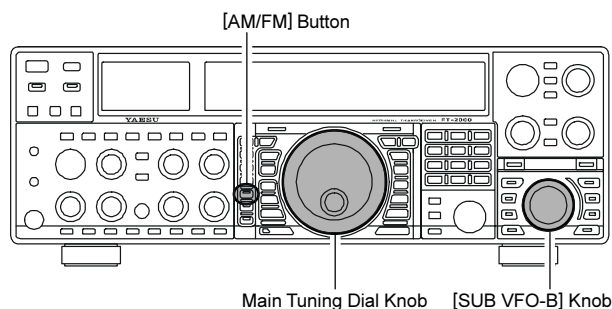

MEMORY OPERATION

CONVENIENT MEMORY FUNCTIONS

The **FT-2000** contains ninety-nine regular memories, labeled “01” through “99,” nine special programmed limit memory pairs, labeled “P-1L/1U” through “P-9L/9U,” and five QMB (Quick Memory Bank) memories, labeled “C-1” through “C-5.” Each stores various settings, not only the Main band’s (VFO-A) frequency and mode (See below). By default, the 99 regular memories are contained in one group; however, they can be arranged in up to six separate groups, if desired.

QUICK POINT:

The **FT-2000**’s memory channels store the following data (not just the operating frequency):

- Frequency
- Mode
- Clarifier status and its Offset Frequency
- ANT status
- ATT status
- IPO status
- VRF status
- Roofing filter status and its Bandwidth
- Noise Blanker status
- CONTOUR status and its Peak Frequency
- DSP Noise Reduction (DNR) status and its Reduction algorithm selection.
- DSP Notch filter (NOTCH) status
- NAR bandwidth status
- DSP Auto Notch filter (DNF) status
- Repeater Shift Direction and Shift Frequency
- CTCSS status and Tone Frequency

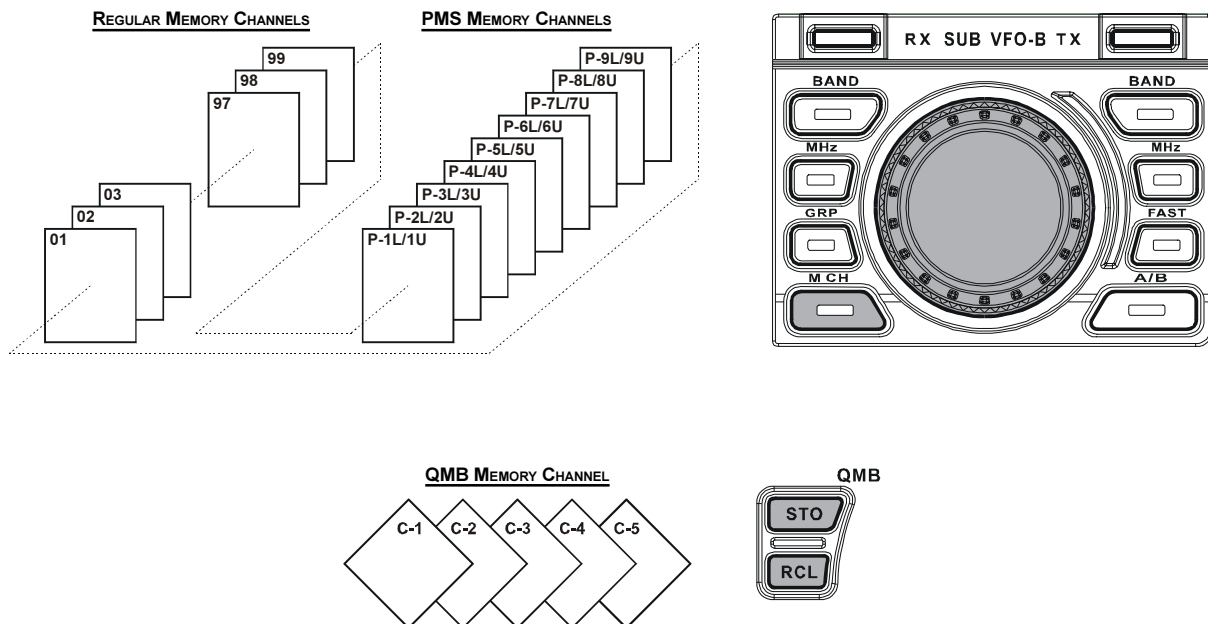

QMB (QUICK MEMORY BANK)

The Quick Memory Bank consists of five memories (labeled “C-1” through “C-5.”) independent from the regular and PMS memories. These can quickly store operating parameters for later recall.

QMB Channel Storage

1. Tune to the desired frequency on the Main (VFO-A) band.
2. Press the blue **[QMB(STO)]** button. The “beep” will confirm that the contents of the Main (VFO-A) band have been written to the currently-available QMB memory.

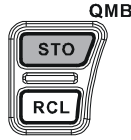

If you repeatedly press the **[QMB(STO)]** button, the QMB memories will be written in the following order:

C-2 → C-3 → C-4 → C-5 → C-1

Once all five QMB memories have data on them, previous data (starting with channel “C-1”) will be over-written on a first-in, first-out basis.

QMB Channel Recall

1. Press the **[QMB(RCL)]** button. The current QMB channel’s data will be shown on the Main (VFO-A) frequency display field and the QMB memory channel number will be shown in the Multi-Display Window.
2. Repeatedly pressing the **[QMB(RCL)]** button will toggle you through the QMB channels:
C-2 → C-3 → C-4 → C-5 → C-1
3. Press the **[V/M]** button to return to the VFO or Memory mode.

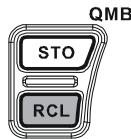

ADVICE:

Rotating the Main Tuning Dial knob, or changing the operating mode, will place the transceiver in the “Memory Tune” mode, which is a temporary “pseudo-VFO” method of tuning off of a stored memory channel. If you do not over-write the contents of the current memory channel, the original contents will not be disturbed by the initiation of Memory Tune operation.

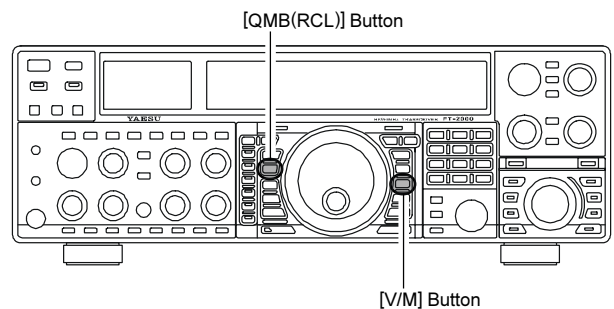
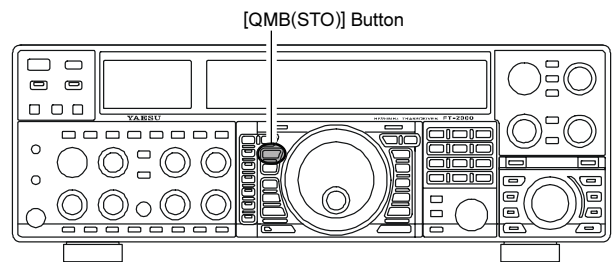

MEMORY OPERATION

STANDARD MEMORY OPERATION

The Standard Memory of the **FT-2000** allows storage and recall of up to 99 memories, each storing frequency, mode, and a wide variety of status information detailed previously. Memories may be grouped into as many as six Memory Groups, and additionally you get nine pairs of band-limit (PMS) memories along with five QMB (Quick Memory Bank) memories.

Memory Storage

1. Set the Main band (VFO-A) up with all frequency, mode, and status the way you want to have it stored.
2. Press the **[A▶M]** button momentarily (the current channel number will start blinking in the multi-panel window); the contents of the current memory channel will be shown on the Sub band (VFO-B) display field.
3. Rotate the **[SUB VFO-B]** knob to select the memory channel onto which you wish to store the data. If you have selected a channel on which data is already stored, that frequency will appear on the Sub band's (VFO-B) frequency display field.
4. Press and hold in the **[A▶M]** button for two seconds to store the frequency and other data into the selected memory channel. A double beep will confirm that you have held the **[A▶M]** button in long enough.

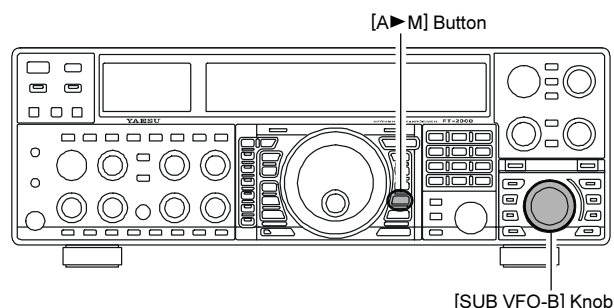

Memory Channel Recall

1. Press the **[V/M]** button, if necessary, to enter the Memory mode. A memory channel number will appear in the multi-panel window.
2. Press the **[M CH]** button. The Red LED inside the button will light up, indicating that you are ready to recall a memory channel.

ADVICE:

If the Red LED imbedded in the **[M CH]** button does not light up, check to be sure that the orange lamp to the right of the **[SUB VFO-B]** knob is not illuminated. If it is, press the **[A/B]** switch to make it go out, then press the **[M CH]** button again.

3. After pressing the **[M CH]** button, you may rotate the **[M CH]** knob to select the desired memory channel.

ADVICE:

To work within a particular Memory Group, press the **[GRP]** button (the imbedded LED will glow Red), then rotate the **[SUB VFO-B]** knob to select the desired Memory Group. Now press the **[M CH]** button (the imbedded LED will glow Red); you may now choose the memory channel within the selected Memory Group.

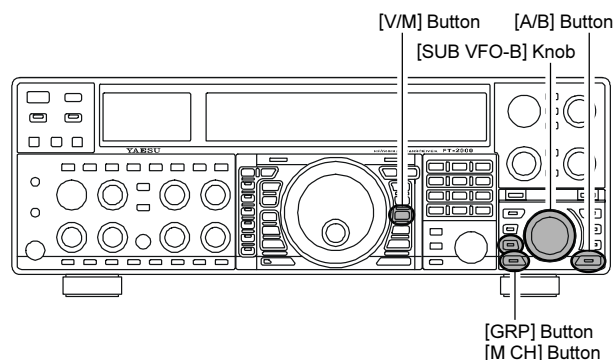

STANDARD MEMORY OPERATION

Checking a Memory Channel's Status

Before programming a channel into memory, you can check the current contents of that channel without the danger of overwriting the channel accidentally.

1. Press the **[A►M]** button momentarily.
The data stored in the currently-selected memory channel will be displayed in the Sub band (VFO-B) frequency field. However, since you are only checking the contents of the memory channel, your radio will not have moved to the memory channel's frequency.
2. Rotate the **[SUB VFO-B]** knob to select a different memory channel. To exit from the Memory Check mode, press the **[A►M]** button momentarily once more.

ADVICE:

- While the Memory Check function is engaged, the memory channel number will blink in the multi-panel window.
- While operating in the VFO mode, using Memory Check, you may store the current contents of the Main (VFO-A) register into the selected memory by pressing and holding in the **[A►M]** button for two seconds (until the double beep). Conversely, if you wish to write the contents of the current memory into the Main (VFO-A) register, press and hold in the **[M►A]** button for two seconds.

Erasing Memory Channel Data

1. Press the **[A►M]** button.
The data stored in the currently-selected memory channel will be displayed in the Sub (VFO-B) band frequency field.
2. Rotate the **[SUB VFO-B]** knob to select the memory channel that you would like to erase.
3. Press the **[LOCK]** button to erase the contents of the selected memory channel.

ADVICE:

- After erasure, only the memory channel number will remain; the frequency data will disappear from the display.
- If you make a mistake and wish to restore the memory's contents, just repeat steps (1) through (3) above.

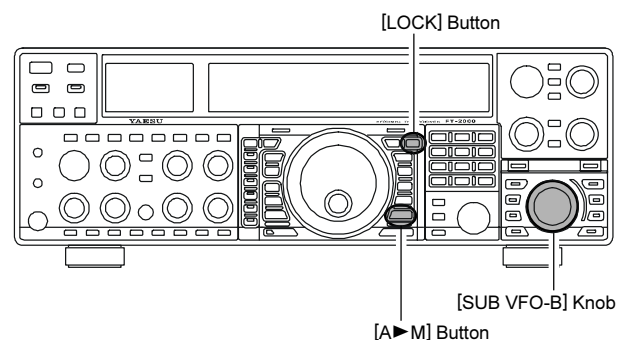
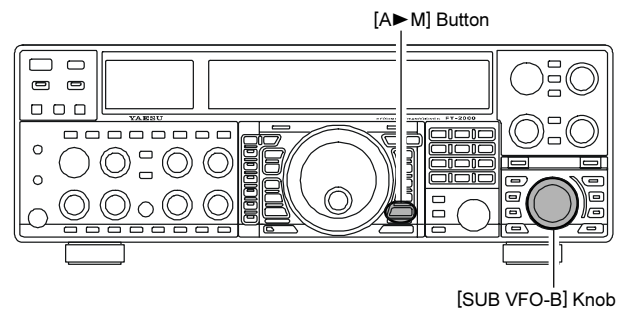

MEMORY OPERATION

STANDARD MEMORY OPERATION

Moving Memory Data to the Main Band (VFO-A)

You may transfer the contents of the currently-selected memory channel into the Main band (VFO-A) register, if you like.

1. Press the **[V/M]** button, as necessary, to go to the Memory mode. The memory channel number will appear in the multi-panel window.
2. Press the **[M CH]** button. The Red LED inside the switch will light up, indicating that you are ready to recall a memory channel.

ADVICE:

If the Red LED imbedded in the **[M CH]** button does not light up, check to be sure that the orange lamp to the right of the **[SUB VFO-B]** knob is not illuminated. If it is, press the **[A/B]** switch to make it go out, then press the **[M CH]** button again.

3. Rotate the **[SUB VFO-B]** knob to select the memory channel the contents of which you wish to transfer to the Main band (VFO-A).
4. Press and hold in the **[M▶A]** button for two seconds, until you hear the double beep. The data in the selected memory channel will now be transferred to the Main band (VFO-A).

ADVICE:

This transfer of data to the Main band (VFO-A) does not affect the original contents of the memory channel; this is a “copy” function that leaves the memory contents unchanged.

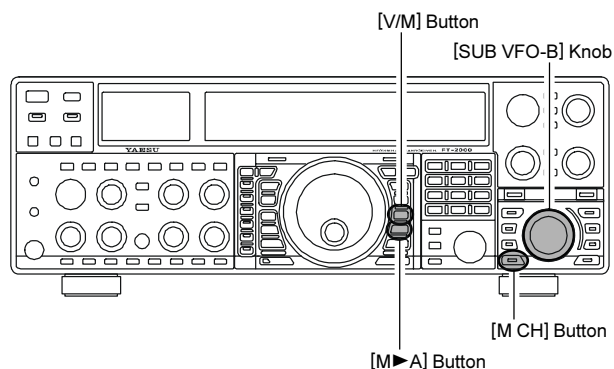

Memory Tune Operation

You may freely tune off of any memory channel in a “Memory Tune” mode that is similar to VFO operation. So long as you do not over-write the contents of the current memory, Memory Tune operation will not alter the contents of the memory channel.

1. Press the **[V/M]** button to recall any memory channel.
2. Rotate the Main Tuning Dial knob; you will now observe that the memory channel’s frequency is changing.

ADVICE:

- The “**MT**” icon will replace the “**MR**” icon in the multi-panel window, indicating you are in the “Memory Tune” mode.
 - During Memory Tune operation, you may change operating modes, and engage the Clarifier, if desired.
3. Press the **[V/M]** button momentarily to return to the originally-memorized frequency of the current memory channel. One more press of the **[V/M]** button will return you to VFO operation.

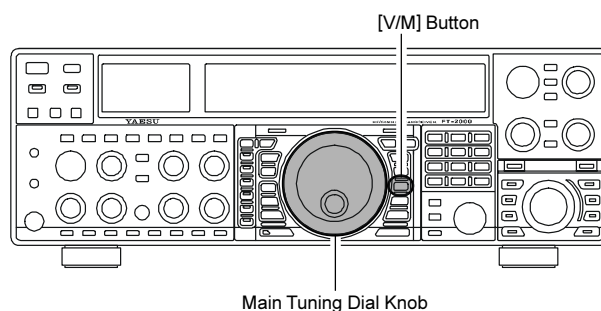

NOTE:

Computer software programs utilizing the CAT system interface port may presume that the transceiver is operating in the VFO mode for certain features like “band mapping” and/or frequency logging. Because the “Memory Tune” mode so closely resembles the VFO mode, be sure that you have the **FT-2000** operating in a control mode compatible with your software’s requirements. Use the VFO mode if you’re not sure.

MEMORY GROUPS

Memory channels may be grouped into as many as six convenient batches, for easy identification and selection. For example, you might want to set aside memory groups for AM BC stations, shortwave broadcast stations, contest frequencies, repeater frequencies, and PMS limits, or any other groupings you like.

Each memory group is capable of holding up to 22 memory channels (the Group size is fixed). When a memory channel is grouped, the channel numbers change to correspond to the chart below:

Memory Group Assignment

1. Press the **[MENU]** button to enter the Menu mode.
2. Rotate the Main Tuning Dial knob to select Menu item "030 GEN MEM GRP."
3. Rotate the **[SUB VFO-B]** knob to set this Menu item to "On" (the default setting is "OFF").
4. Press and hold in the **[MENU]** button for two seconds to save the new setting and exit. Operation will now be restricted to the six Memory Groups.

To cancel Memory Group operation, repeat steps (1) through (4) above, choosing "OFF" in step (3).

ADVICE

Note that for the PMS memory group, the PMS memories "P-1L" through "P-9U" will be so designated, so as to avoid confusion.

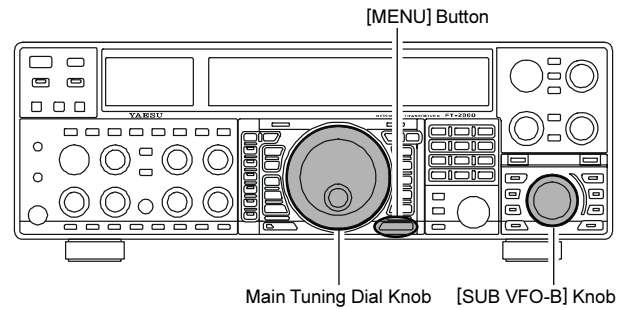

MEMORY CHANNEL NUMBER	
GROUP MEMORY "OFF"	GROUP MEMORY "ON"
01 ~ 19	1-01 ~ 1-19
20 ~ 39	2-01 ~ 2-20
40 ~ 59	3-01 ~ 3-20
60 ~ 79	4-01 ~ 4-20
80 ~ 99	5-01 ~ 5-20
P-1L/1U ~ P-9L/9U	P-1L/1U ~ P-9L/9U

Choosing the Desired Memory Group

You may recall memories just within a particular Memory Group, if desired.

1. Press the **[V/M]** button, if necessary, to enter the Memory mode.
2. Press the **[GRP]** button (below and to the left of the **[SUB VFO-B]** knob). The imbedded LED inside the switch will light up.
3. Rotate the **[SUB VFO-B]** knob to select the desired Memory Group.
4. Press the **[M CH]** button (just below the **[GRP]** button). The imbedded LED inside the switch will light up.
5. Rotate the **[SUB VFO-B]** knob to select the desired Memory Channel within the Selected Memory Group.

ADVICE:

- If the Red LED imbedded in the **[GRP]** and **[M CH]** buttons does not light up, check to be sure that the orange lamp to the right of the **[SUB VFO-B]** knob is not illuminated. If it is, press the **[A/B]** button to make it go out, then press the **[GRP]** or **[M CH]** button again.
- If no channels have been assigned to a particular Memory Group, you will not have access to that Group.

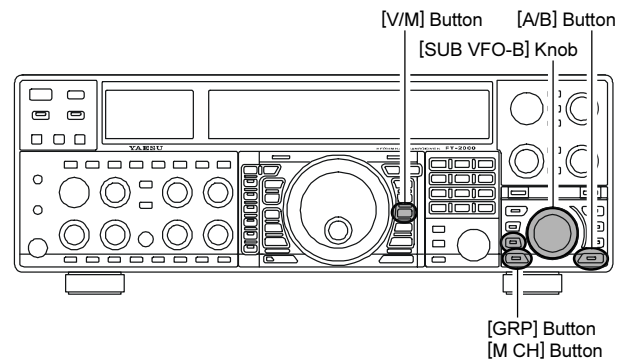

OPERATION ON ALASKA EMERGENCY FREQUENCY: 5167.5 kHz (U.S. VERSION ONLY)

Section 97.401(d) of the regulations governing amateur radio in the United States permit emergency amateur communications on the spot frequency of 5167.5 kHz by stations in (or within 92.6 km of) the state of Alaska. This frequency is only to be used when the immediate safety of human life and/or property are threatened, and is never to be used for routine communications.

The **FT-2000** includes the capability for transmission and reception on 5167.5 kHz under such emergency conditions via the Menu system. To activate this feature:

1. Press the **[MENU]** button to enter the Menu mode.
2. Rotate the Main Tuning Dial knob to select “147 tGEN EMERGENCY.”
3. Rotate the **[SUB VFO-B]** knob to select “EnA (Enable).”
4. Press and hold in the **[MENU]** button for 2 seconds to save the new setting and exit to normal operation. Emergency communication on this spot frequency is now possible.
5. Press the **[V/M]** button, as necessary, to enter the Memory mode. Press the **[M CH]** button, then rotate the **[SUB VFO-B]** knob to select the emergency channel (“EUS”), which is found between channels “P-9U” and “01.”

ADVICE:

If the Red LED imbedded in the **[M CH]** button does not light up, check to be sure that the orange lamp to the right of the **[SUB VFO-B]** knob is not illuminated. If it is, press the **[A/B]** switch to make it go out, then press the **[M CH]** button again.

NOTE:

- ❑ The receive-mode CLARIFIER functions normally while using this frequency, but variation of the transmit frequency is not possible. Activation of “147 tGEN EMERGENCY” does not enable any other out-of-amateur-band capability on the transceiver. The full specifications of the **FT-2000** are not necessarily guaranteed on this frequency, but power output and receiver sensitivity should be fully satisfactory for the purpose of emergency communication.
- ❑ If you wish to disable operation capability on the Alaska Emergency Frequency, repeat the above procedures, but set “147 tGEN EMERGENCY” to “diS” in step 3.
- ❑ In an emergency, note that a half-wave dipole cut for this frequency should be approximately 45’3” on each leg (90’6” total length). Emergency operation on 5167.5 kHz is shared with the Alaska-Fixed Service. This transceiver is not authorized for operation, under the FCC's Part 87, for aeronautical communications.

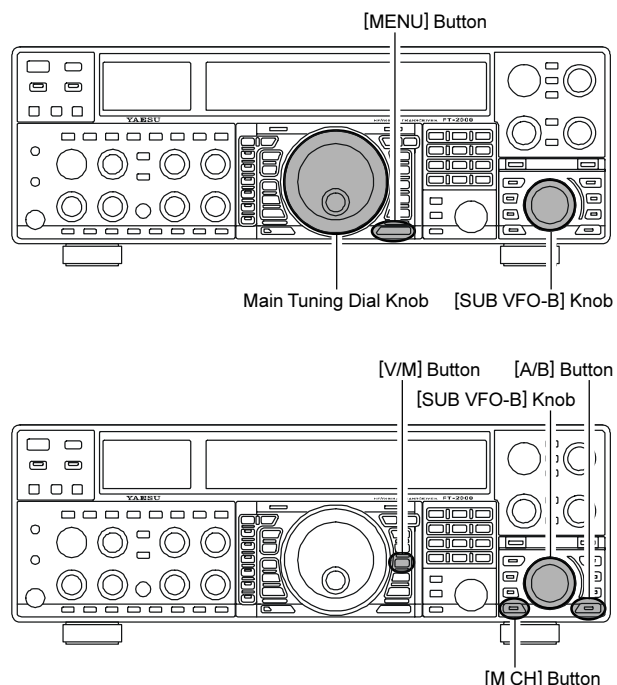

VFO AND MEMORY SCANNING

You may scan with the VFO or the memories of the **FT-2000**, and the radio will halt the scan on any station with a signal strong enough to open the receiver's squelch.

VFO SCANNING

1. Set the VFO to the frequency on which you would like to begin scanning.
2. Rotate the Main [SQL] knob so that the background noise is just silenced.

ADVICE:

Rotate the Sub [SQL] knob so that the background noise is just silenced, if you would like to begin scanning on the Sub band (VFO-B).

3. Press and hold in the microphone's [UP] or [DWN] key for 1/2 second to start scanning in the specified direction on the Main (VFO-A) band.

ADVICE:

If you would like to begin scanning on the Sub band (VFO-B), press the [B] button first, then (within five seconds of pressing the [B] button, while the orange imbedded LED is blinking), press and hold in the microphone's [UP] or [DWN] key for 1/2 second.

4. If the scanner halts on an incoming signal, the decimal point between the "MHz" and "kHz" digits of the frequency display will blink.

ADVICE:

- If the incoming signal disappears, scanning will resume in about five seconds.
- On the SSB/CW and SSB-based Data modes, the scanner will pause on a received signal, then will step across the signal very slowly, giving you time to stop the scan, if you like. In these modes on the VFO, the scanner does not stop, however.

5. To cancel the scanning, press the microphone's [UP] or [DWN] key momentarily.

ADVICE:

You may select the manner in which the scanner resumes while it has paused on a signal, using Menu item "039 GEN SCN RSM." The default "5Sec" setting will cause the scanner to resume scanning after five seconds; you may change it, however, to resume only after the carrier has dropped out, if you like See page 116.

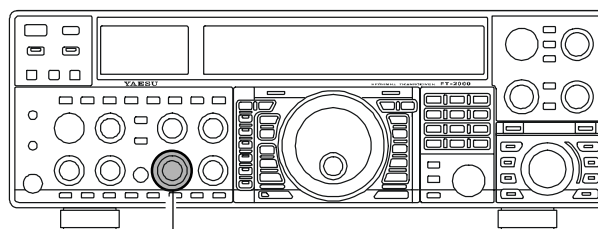

Main [SQL] Knob

MAIN BAND (VFO-A) SCANNING

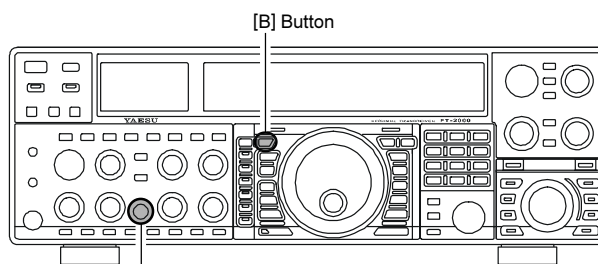

[B] Button

SUB [SQL] Knob

SUB BAND (VFO-B) SCANNING

VFO AND MEMORY SCANNING

MEMORY SCAN

1. Set the transceiver up in the memory mode by pressing the [V/M] button, if necessary.
2. Rotate the Main [SQL] knob so that the background noise is just silenced.
3. Press the [M CH] button momentarily.
When you press the [M CH] button, the Red LED imbedded within the switch should light up, indicating that you are ready to choose a channel into which to store the data.

ADVICE:

If the Red LED imbedded in the [M CH] button does not light up, check to be sure that the orange lamp to the right of the [SUB VFO-B] knob is not illuminated. If it is, press the [A/B] button to make it go out, then press the [M CH] button again.

4. Press and hold in the microphone's [UP] or [DWN] key for 1/2 second to start scanning in the specified direction.

ADVICE:

- ❑ If the scanner halts on an incoming signal, the decimal point between the "MHz" and "kHz" digits of the frequency display will blink.
- ❑ If the incoming signal disappears, scanning will resume in about five seconds.

5. To cancel the scanning, press the microphone's [UP] or [DWN] key momentarily.

ADVICE:

- ❑ During Memory Group operation, only the channels within the current Memory Group will be scanned.
- ❑ If the scan has paused on a signal, pressing the microphone's [UP] or [DWN] key will cause scanning to resume instantly.
- ❑ If you press the microphone's PTT switch during scanning, the scanner will halt at once. Pressing the PTT switch during scanning will not cause transmission, however.
- ❑ You may select the manner in which the scanner resumes while it has paused on a signal, using Menu item "039 GEN SCN RSM." The default "5Sec" setting will cause the scanner to resume scanning after five seconds; you may change it, however, to resume only after the carrier has dropped out, if you like See page 116.

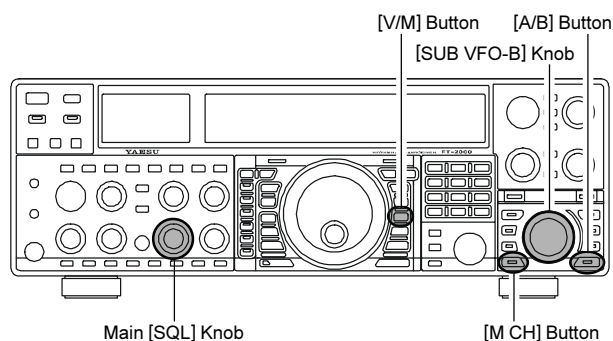

QUICK POINT:

If you have no interest in scanning, and wish to prohibit the microphone's [UP]/[DWN] keys from initiating scanning, you may disable scanning control from the microphone using Menu item "038 GEN MIC SCN" (set it to "Off").

PMS (PROGRAMMABLE MEMORY SCANNING)

To limit scanning (and manual tuning) within a particular frequency range, you can use the Programmable Memory Scanning (PMS) feature, which utilizes nine special-purpose memory pairs (“P-1L/P-1U” through “P-9L/P-9U”). The PMS feature is especially useful in helping you to observe any operating sub-band limits which apply to your Amateur license class.

1. Store the Lower and Upper tuning/scanning limit frequencies into the memory pair “P-1L” and “P-1U,” respectively, or any other “L/U” pair of memories in the special PMS memory area. See page 97 for details regarding memory storage.
2. Press the **[V/M]** button to enter the Memory mode.
3. Press the **[M CH]** button momentarily.

When you press the **[M CH]** button, the Red LED imbedded within the switch should light up, indicating that you are ready to choose a channel into which to store the data.

ADVICE:

If the Red LED imbedded in the **[M CH]** button does not light up, check to be sure that the orange lamp to the right of the **[SUB VFO-B]** knob is not illuminated. If it is, press the **[A/B]** button to make it go out, then press the **[M CH]** button again.

4. Rotate the **[SUB VFO-B]** knob to select memory channel “P-1L” or “P-1U.”
5. Rotate the Main **[SQL]** knob so that the background noise is just silenced.
6. Turn the Main Tuning Dial knob slightly (to activate memory tuning). Tuning and scanning are now limited to the range within the P-1L/P-1U limits until you press the **[V/M]** button to return to memory channel or Main band (VFO-A) operation.
7. Press and hold in the microphone’s **[UP]** or **[DWN]** key for 1/2 second to start scanning in the specified direction.

ADVICE:

- If the scanner halts on an incoming signal, the decimal point between the “MHz” and “kHz” digits of the frequency display will blink.
 - If the incoming signal disappears, scanning will resume in about five seconds.
 - On the SSB/CW and SSB-based Data modes, the scanner will pause on a received signal, then will step across the signal very slowly, giving you time to stop the scan, if you like. In these modes on the VFO, the scanner does not stop, however.
 - If the scan has paused on a signal, pressing the microphone’s **[UP]** or **[DWN]** key will cause scanning to resume instantly.
8. If you rotate the Main Tuning Dial knob in the opposite direction from the current scanning direction (in other words, you rotate the dial to the left when scanning toward a higher frequency), the direction of the scan will reverse.
 9. If you press the microphone’s **PTT** switch during scanning, the scanner will halt at once. Pressing the **PTT** switch during scanning will not cause transmission, however.

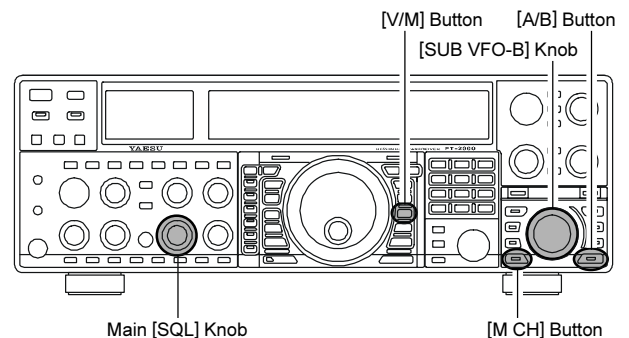

PACKET OPERATION

Packet operation is easily accomplished on the **FT-2000** by connecting your TNC (Terminal Node Controller) to the transceiver, per the illustration. “Packet” operation also applies to SSB-based AFSK data modes, such as PSK31, etc.

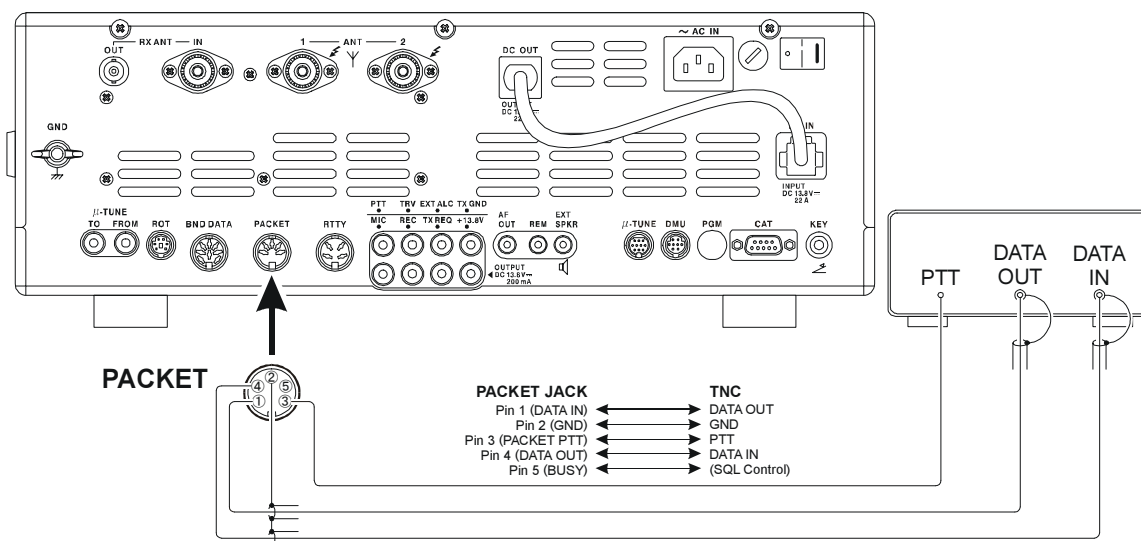

PACKET SETUP (INCLUDING SUBCARRIER FREQUENCY)

Before operation can commence, some basic setup procedures must be performed, using the Menu, to configure your radio for the data mode to be used.

MENU ITEM	AVAILABLE VALUES	MENU ITEM	AVAILABLE VALUES
064 dAtA DATA IN	dAtA (DATA) / PC (PC)	068 dAtA VOX DLY	30 ~ 3000 msec
065 dAtA DT GAIN	0 ~ 100	069 dAtA V GAIN	0 ~ 100
066 dAtA DT OUT	nAin (Main) / Sub (Sub)	070 dAtA PKTDISP	-3000 ~ +3000 Hz
067 dAtA OUT LVL	0 ~ 100	071 dAtA PKT SFT	-3000 ~ +3000 Hz

BASIC SETUP

1. Press the **[PKT]** button.

ADVICE:

- For HF operation, SSB-based Data operation is generally used. One press of the **[PKT]** button will engage Packet operation in the “LSB” mode (by default). Both the “PKT” and “LSB” LEDs will become illuminated.
 - If you need to do FM-based 1200-baud packet on the 29/50 MHz bands, press the **[PKT]** button repeatedly to illuminate the ‘PKT’ LED to orange, to engage the “PKT-FM” mode.
 - When both the “PKT” and “USB” LEDs are illuminated, the **FT-2000** has engaged Packet operation in the “USB” mode.
2. When the “transmit” command is received from the TNC, the transmitter of the **FT-2000** will automatically be engaged. Likewise, the command to return to receive will cause the radio to revert to the receive mode.

ADVICE:

- If you need to adjust the output level from the “DATA OUT” pin of the **PACKET** jack (pin 4) on the radio, please use Menu item “067 dAtA OUT LVL.” For the input level from the TNC, as applied to the DATA IN pin of the **PACKET** jack (pin 1), please do so at the TNC side.

- During Packet operation via the rear panel’s **PACKET** jack, the front panel **MIC** jack is cut off, so you won’t have a “live microphone” problem during data operation.

NOTE:

If you anticipate making data transmissions of longer than a few minutes, we recommend that you use the **[RF PWR]** knob to reduce the transmitter power to 1/3 ~ 1/2 of its normal maximum.

QUICK POINT:

PACKET Jack Specifications

- DATA IN (Pin 1)
 - Input Level: 50 mVp-p
 - Input Impedance: 10 k-Ohms
- DATA OUT (Pin 4)
 - Fixed level, does not respond to setting of **[AF GAIN]** or **[SQL]** knob.
 - Output Level: 100 mVp-p max.
 - Output Impedance: 10 k-Ohms

RTTY (RADIO TELETYPE) OPERATION

Most RTTY operation today is accomplished using a TNC or other computer-based system that utilizes AFSK tones. As such, the previous discussion on LSB-mode “Packet” operation will apply for Baudot operation, as well. For RTTY operation using a Terminal Unit (TU) or the “FSK” output from a TNC, please see the discussion below. See also the illustration for details regarding connection to your TU.

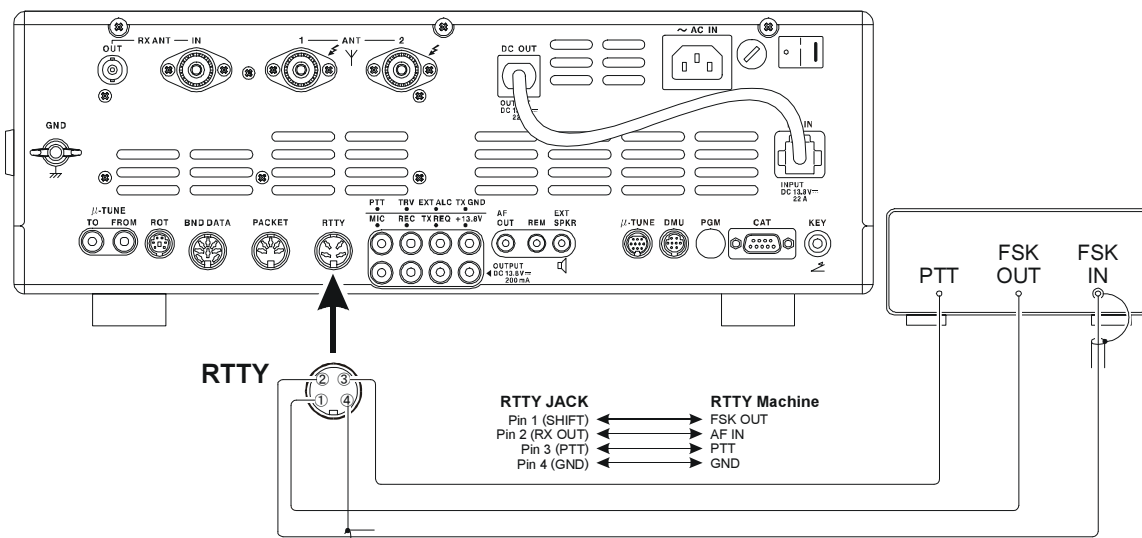

SETTING UP FOR RTTY OPERATION

Before commencing RTTY operation, please direct your attention to the setup steps shown in the chart to the right.

MENU ITEM	AVAILABLE VALUES
076 rty R PLRTY	nor (normal) / rEU (reverse)
077 rty T PLRTY	nor (normal) / rEU (reverse)
078 rty RTY OUT	nAin (Main) / Sub (Sub)
079 rty OUT LEL	0 ~ 100
080 rty SHIFT	170/200/425/850 Hz
081 rty TONE	1275/2125 Hz

BASIC SETUP

- Press the [RTTY] button to enter the RTTY mode. One press of the [RTTY] button will engage RTTY operation using “LSB” injection, which is generally used in the Amateur service. In this mode, both the “RTTY” and “LSB” LEDs will light up. To switch to USB-side injection in RTTY, press the [RTTY] button once more. Both the “RTTY” and “USB” LEDs will now be illuminated. Repeatedly pressing the [RTTY] button will toggle between LSB and USB injection on RTTY.
- When you begin typing on your TU or computer keyboard, the command to transmit should automatically be sent to the transceiver, causing it to enter the transmit mode.

NOTE:

If you anticipate making data transmissions of longer than a few minutes, we recommend that you use the [RF PWR] knob to reduce the transmitter power to 1/2 ~ 1/3 of its normal maximum.

ADVICE:

- There is no adjustment of the DATA input level (Pin 1 (“DATA IN”) of the RTTY jack) on the rear panel; please make any needed level adjustments at the TU side.

- The Mark/Space Shift utilized in most Amateur RTTY operation is 170 Hz. Other shifts may be configured, however, using Menu item “080 rty SHIFT.” The FT-2000 is set up for “high tone” operation (centered on 2125 Hz) by default, but you may configure it for low tone (1275 Hz) operation using Menu item “081 rty TONE.”
- You may find that you are unable to decode some RTTY stations, even if they are of sufficient signal strength. If this is observed, there may be a Mark/Space polarity problem between your station and the other station. If so, try setting Menu item “076 rty R PLRTY” to “rEU” (“Reverse”) to see if that permits copy. A separate Menu item permits reversal of your transmitter’s Mark/Space polarity: “077 rty T PLRTY.”

QUICK POINT:

In the FT-2000, “RTTY” is a mode defined as being an “FSK” mode, whereby the closing and opening of a keying line (to ground) causes the Mark/Space tones to alternate. The RTTY mode is not an AFSK based mode in this transceiver, and the AFSK output tones from a TNC will not cause Mark/Space shifting to occur. Use the “Packet” mode for AFSK-based Baudot and other data modes.

MISCELLANEOUS AFSK-BASED DATA MODES

The **FT-2000** may also be used for a host of other SSB-based Data modes. Please set up your system using the illustration as a guideline.

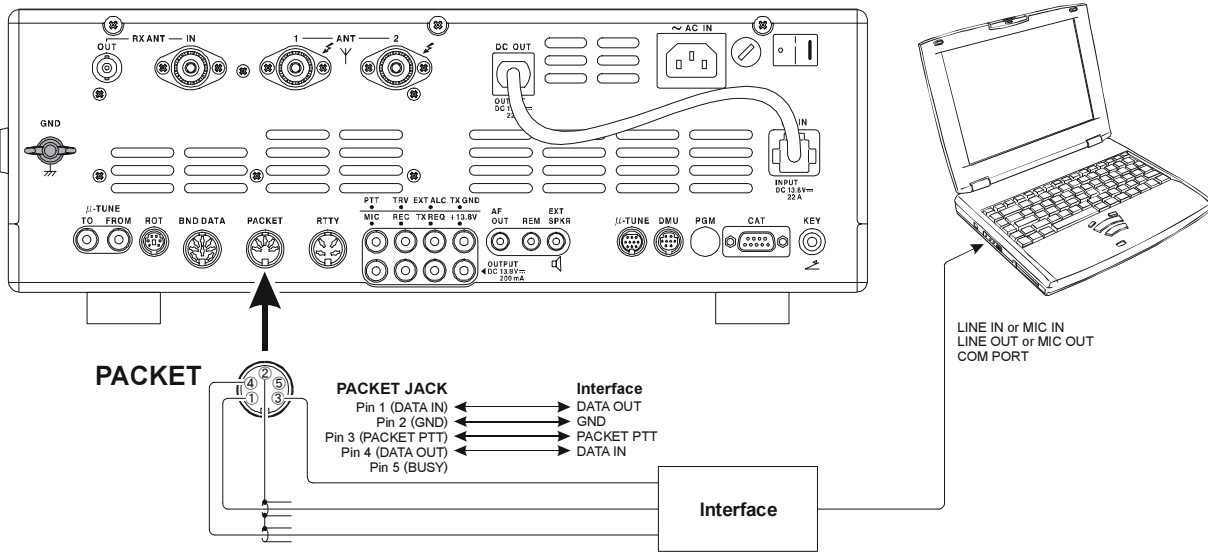

QUICK POINT:

When you have configured Menu item “146 tGEn VOX SEL” to “dAtA,” the transceiver will operate in a “VOX” mode, and it is not necessary to connect a **PTT** line. This makes for very convenient interfacing to computer Sound Cards, etc.

ABOUT THE TRANSVERTER OUTPUT TERMINAL

You may connect an after-market transverter to the rear panel's TRV (Transverter) jack. The output, at 28 MHz, is approximately -10 dBm (0.1 mW) at 50 Ohms.

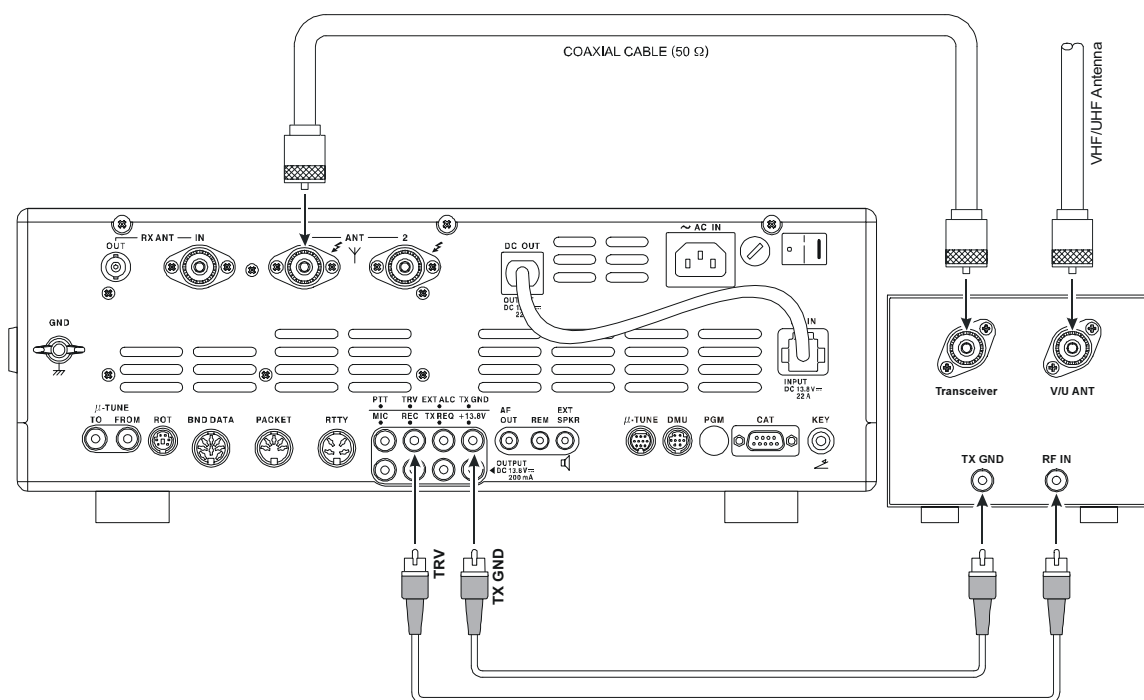

SETUP

1. Press the **[MENU]** button to enter the Menu mode.
2. Rotate the Main Tuning Dial knob to select Menu item "122 tun MY BAND."
3. Rotate the **[SUB VFO-B]** knob to find the Menu parameter "AU d" (this is the factory default setting).
4. Press the **[ENT]** button to change the parameter to "ON" (a "d" notation will replace the "E" notation).
5. Rotate the Main Tuning Dial knob to select Menu item "144 tGEn ETX-GND."
6. Rotate the **[SUB VFO-B]** knob to set this Menu item to "EnA" to enabling the rear panel's **TX GND** jack
7. Press and hold in the **[MENU]** button for at least two seconds to save the new setting and exit to normal operation.

OPERATION

1. Set up the frequency offset for transverter use, as described previously.
2. Rotate the Main Tuning Dial knob to set the desired operating frequency. Operation is basically unchanged from normal transceiver operation.

ADVICE:

When the "TRV" mode is turned on, power output will not be allowed to pass to the "ANT 1" or "ANT 2" main antenna jacks. So one of these may be connected to your transverter's "RX" jack. Just be certain to disconnect the transverter when returning to HF operation, as the selected Antenna jack will now be capable of passing RF power.

Setting the Transverter Frequency Offset

You may set up the frequency display so that it shows the actual band on which your transverter is operating (instead of the "IF" used by the transverter, which is the 28 MHz band on your **FT-2000**).

Example: Setting up the **FT-2000** display for use with a 144 MHz Transverter

1. Connect the 144 MHz transverter to the **FT-2000**.
2. Press the **[MENU]** button to enter the Menu mode.
3. Rotate the Main Tuning Dial knob to select Menu item "O34 GEnE TRV SET" is set to "44" (the factory default setting).
4. Rotate the **[SUB VFO-B]** knob so as to select "44" on the display.
5. Press and hold in the **[MENU]** button for at least two seconds to save the new setting and exit.

The "100 MHz" digit of the frequency is not displayed, so when you are operating on 2 meters and see "45 MHz" on the frequency readout, this indicates "145 MHz" instead.

Advice:

With the setup described above, tuning the operating range 28-29 MHz will correspond to an actual operating frequency of 144-145 MHz, with "44-45" being displayed on the front panel of the transceiver.

MENU MODE

The Menu system of the **FT-2000** provides extensive customization capability, so you can set up your transceiver just the way you want to operate it. The Menu items are grouped by general utilization category, and are numbered from “001 AGC FST DLY” to “147 tGEn EMRGNCY.”

USING THE MENU

1. Press the **[MENU]** button momentarily, to engage the Menu mode.

The Main (VFO-A) frequency display will show the Menu Number and Menu Group name, while the Sub (VFO-B) frequency display will show the Menu item; the Multi-Display window shows the current setting of the currently-selected Menu item.

2. Rotate the Main Tuning Dial knob to select the Menu item you wish to work on.
3. Rotate the **[SUB VFO-B]** knob to change the current setting of the selected Menu item.
4. When you have finished making your adjustments, press and hold in the **[MENU]** button for two seconds to save the new setting and exit to normal operation. If you only *momentarily* press the **[MENU]** button, the new settings will *not* be retained.

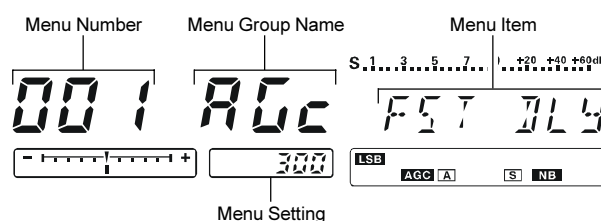
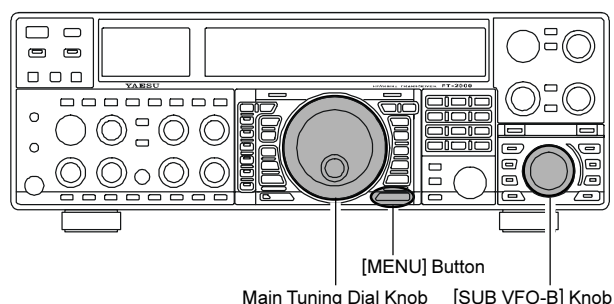

Menu Mode Reset

You may reset all the Menu settings to their original factory defaults, if desired.

1. Turn the front panel **[POWER]** switch off.
2. Press and hold in the **[MENU]** button, and while holding it in, press the **[POWER]** switch to turn the transceiver back on. Now release the **[MENU]** button.

MENU MODE

GROUP	No.	MENU FUNCTION	AVAILABLE VALUES	DEFAULT SETTING
AGC	001	AGc FST DLY	20 ~ 4000 msec (20 msec/step)	300 msec
AGC	002	AGc FST HLD	0 ~ 2000 msec (20 msec/step)	0 msec
AGC	003	AGc MID DLY	20 ~ 4000 msec (20 msec/step)	700 msec
AGC	004	AGc MID HLD	0 ~ 2000 msec (20 msec/step)	0 msec
AGC	005	AGc SLW DLY	20 ~ 4000 msec (20 msec/step)	2000 msec
AGC	006	AGc SLW HLD	0 ~ 2000 msec (20 msec/step)	0 msec
DISPLAY	007	diSP COLOR	bL1/bL2/bL3/ub1/ub2	bL1 ^{※1}
DISPLAY	008	diSP DIM MTR	0 ~ 15	7
DISPLAY	009	diSP DIM VFD	0 ~ 7	4
DISPLAY	010	diSP BAR SEL	CLAr/C-tn/u-tn	C-tn
DISPLAY	011	diSP PK HLD	OFF/0.5/1.0/2.0 sec	OFF
DISPLAY	012	diSP RTR STU	0/90/180/270 °	0 °
DISPLAY	013	diSP RTR ADJ	-30 ~ 0	0
DISPLAY	014	diSP QMB MKR	On/OFF	On ^{※1}
DVS	015	dUS RX LVL	0 ~ 100	50
DVS	016	dUS TX LVL	0 ~ 100	50
KEYER	017	tEy BEACON	OFF/1 ~ 255 sec	OFF
KEYER	018	tEy NUM STL	1290/AunO/Aunt/A2nO/A2nt/12nO/12nt	1290
KEYER	019	tEy CONTEST	1 ~ 9999	1
KEYER	020	tEy CW MEM1	tyP1/tyP2	tyP2
KEYER	021	tEy CW MEM2	tyP1/tyP2	tyP2
KEYER	022	tEy CW MEM3	tyP1/tyP2	tyP2
KEYER	023	tEy CW MEM4	tyP1/tyP2	tyP2
KEYER	024	tEy CW MEM5	tyP1/tyP2	tyP2 [※]
GENERAL	025	GEnE ANT SEL	bAnd/rEG	bAnd
GENERAL	026	GEnE BEP LVL	0 ~ 255	50
GENERAL	027	GEnE CAT BPS	4800/9600/192H(19200)/384H (38400) bps	4800 bps
GENERAL	028	GEnE CAT TOT	10/100/1000/3000 msec	10 msec
GENERAL	029	GEnE CAT RTS	On/OFF	On
GENERAL	030	GEnE MEM GRP	On/OFF	OFF
GENERAL	031	GEnE Q SPLIT	-20 ~ 0 ~ +20 kHz (1 kHz Step)	+5 kHz
GENERAL	032	GEnE TRACK	OFF/bAnd/FrEq	OFF
GENERAL	033	GEnE TX TOT	OFF/5/10/15/20/25/30 min	OFF
GENERAL	034	GEnE TRV SET	30 ~ 49 MHz	44 MHz
GENERAL	035	GEnE μT DIAL	StP1/ StP2/OFF	StP1
GENERAL	036	GEnE SNB LVL	nAin(MAIN)/0~100	nAin(MAIN)
GENERAL	037	GEnE SUB FIL	1200/300/500 Hz	1200 Hz
GENERAL	038	GEnE MIC SCN	On/OFF	On
GENERAL	039	GEnE SCN RSM	CAr/5Sec	5SEc
GENERAL	040	GEnE ANTIVOX	0 ~ 100	50
GENERAL	041	GEnE FRQ ADJ	-25 ~ 0 ~ +25	0
S IF SFT	042	S-iF LSB SFT	-1000 ~ +1000 Hz	0 Hz
S IF SFT	043	S-iF USB SFT	-1000 ~ +1000 Hz	0 Hz
S IF SFT	044	S-iF CWL SFT	-1000 ~ +1000 Hz	0 Hz
S IF SFT	045	S-iF CWU SFT	-1000 ~ +1000 Hz	0 Hz
S IF SFT	046	S-iF RTTY	-1000 ~ +1000 Hz	0 Hz
S IF SFT	047	S-iF RTTY-R	-1000 ~ +1000 Hz	0 Hz
S IF SFT	048	S-iF PKT-LSB	-1000 ~ +1000 Hz	0 Hz
S IF SFT	049	S-iF PKT-USB	-1000 ~ +1000 Hz	0 Hz
MODE-AM	050	A3E MICGAIN	Ur/0 ~ 100	30
MODE-AM	051	A3E MIC SEL	Frnt/dAtA/PC	Frnt
MODE-CW	052	A1A F-TYPE	OFF/buG/ELE/ACS	ELE
MODE-CW	053	A1A F-REV	nor/rEU	nor
MODE-CW	054	A1A R-TYPE	OFF/buG/ELE/ACS	ELE

※1: Requires optional **DMU-2000** Data Management Unit.

MENU MODE

GROUP	No. MENU FUNCTION	AVAILABLE VALUES	DEFAULT SETTING
MODE-CW	055 A1A R-REV	nor/rEU	nor
MODE-CW	056 A1A CW AUTO	OFF/50/On	OFF
MODE-CW	057 A1A BFO	USb/LSb/Auto	USb
MODE-CW	058 A1A BK-IN	SEni/FuLL	SEni
MODE-CW	059 A1A SHAPE	1/2/4/6 msec	4 msec
MODE-CW	060 A1A WEIGHT	(1:) 2.5 ~ 4.5	3.0
MODE-CW	061 A1A FRQDISP	dir/OFSt	OFSt
MODE-CW	062 A1A PC KYNG	EnA (Enable)/diS (Disable)	diS (Disable)
MODE-CW	063 A1A QSKTIME	15/20/25/30 msec	15 msec
MODE-DAT	064 dAtA DATA IN	dAtA/PC	dAtA
MODE-DAT	065 dAtA DT GAIN	0 ~ 100	50
MODE-DAT	066 dAtA DT OUT	nAin (Main)/Sub (Sub)	nAin (Main)
MODE-DAT	067 dAtA OUT LVL	0 ~ 100	50
MODE-DAT	068 dAtA VOX DLY	30 ~ 3000 msec	300 msec
MODE-DAT	069 dAtA V GAIN	0 ~ 100	50
MODE-DAT	070 dAtA PKTDISP	-3000 ~ +3000 Hz (10 Hz/step)	0 Hz
MODE-DAT	071 dAtA PKT SFT	-3000 ~ +3000 Hz (10 Hz/step)	1000 Hz
MODE-FM	072 F3E MICGAIN	Ur/0 ~ 100	50
MODE-FM	073 F3E MIC SEL	Frnt/dAtA/PC	Frnt
MODE-FM	074 F3E 28 RPT	0 ~ 1000 kHz (10 kHz/step)	100 kHz
MODE-FM	075 F3E 50 RPT	0 ~ 4000 kHz (10 kHz/step)	1000 kHz
MODE-RTY	076 rtty R PLRTY	nor/rEU	nor
MODE-RTY	077 rtty T PLRTY	nor/rEU	nor
MODE-RTY	078 rtty RTY OUT	nAin (Main)/Sub (Sub)	nAin (Main)
MODE-RTY	079 rtty OUT LEL	0 ~ 100	50
MODE-RTY	080 rtty SHIFT	170/200/425/850 Hz	170 Hz
MODE-RTY	081 rtty TONE	1275/2125 Hz	2125 Hz
MODE-SSB	082 J3E MIC SEL	Frnt/dAtA/PC	Frnt
MODE-SSB	083 J3E TX BPF	1-30/1-29/2-28/3-27/4-26/3000	3-27
MODE-SSB	084 J3E LSB CAR	-200 Hz ~ +200 Hz (10 Hz/step)	0 Hz
MODE-SSB	085 J3E USB CAR	-200 Hz ~ +200 Hz (10 Hz/step)	0 Hz
MODE-SSB	086 J3E SLSB CR	-200 Hz ~ +200 Hz (10 Hz/step)	0 Hz
MODE-SSB	087 J3E SUSB CR	-200 Hz ~ +200 Hz (10 Hz/step)	0 Hz
RX AUDIO	088 rout AGC SLP	nor/SLP	nor
RX AUDIO	089 rout HEADPHN	SEP/Con1/Con2	SEP
RX DSP	090 rdSP CNTR LV	-40 ~ +20 dB	-15 dB
RX DSP	091 rdSP CNTR WI	1 - 11	10
RX DSP	092 rdSP NOTCH W	nArr (Narrow)/uuid (Wide)	uuid (Wide)
RX DSP	093 rdSP CW SHAP	SOft/ShAP	ShAP
RX DSP	094 rdSP CW SLP	StP(STEEP)/nEd(MEDIUM)/GEnt(GENTLE)	nEd (MEDIUM)
RX DSP	095 rdSP CW NARR	25/50/100/200/300/400/500/800/1200/1400/ 1700/2000 Hz	500 Hz
RX DSP	096 rdSP PKT SHP	SOft/ShAP	ShAP
RX DSP	097 rdSP PKT SLP	StP(STEEP)/nEd(MEDIUM)/GEnt(GENTLE)	nEd (MEDIUM)
RX DSP	098 rdSP PKT NAR	25/50/100/200/300/400 Hz	300 Hz
RX DSP	099 rdSP RTY SHP	SOft/ShAP	ShAP
RX DSP	100 rdSP RTY SLP	StP(STEEP)/nEd(MEDIUM)/GEnt(GENTLE)	nEd (MEDIUM)
RX DSP	101 rdSP RTY NAR	25/50/100/200/300/400 Hz	300 Hz
RX DSP	102 rdSP SSB SHP	SOft/ShAP	ShAP
RX DSP	103 rdSP SSB SLP	StP(STEEP)/nEd(MEDIUM)/GEnt(GENTLE)	nEd (MEDIUM)
RX DSP	104 rdSP SSB NAR	200/400/600/850/1100/1350/1500/1650/1800/ 950/2100/2250 Hz	1800 Hz
SCOPE	105 SCP 1.8 FI	1.800 - 1.999 MHz (1 kHz/step)	1.800 MHz ^{×1}
SCOPE	106 SCP 3.5 FI	3.500 - 3.999 MHz (1 kHz/step)	3.500 MHz ^{×1}

×1: Requires optional **DMU-2000** Data Management Unit.

GROUP	No.	MENU FUNCTION	AVAILABLE VALUES	DEFAULT SETTING
SCOPE	107	SCP 5.0 FI	5.250 - 5.499 MHz (1 kHz/step)	5.250 MHz*1
SCOPE	108	SCP 7.0 FI	7.000 - 7.299 MHz (1 kHz/step)	7.000 MHz*1
SCOPE	109	SCP 10.1 FI	(1)0.100 - (1)0.149 MHz (1 kHz/step)	(1)0.100 MHz*1
SCOPE	110	SCP 14.0 FI	(1)4.000 - (1)4.349 MHz (1 kHz/step)	(1)4.000 MHz*1
SCOPE	111	SCP 18.0 FI	(1)8.000 - (1)8.199 MHz (1 kHz/step)	(1)8.068 MHz*1
SCOPE	112	SCP 21.0 FI	(2)1.000 - (2)1.449 MHz (1 kHz/step)	(2)1.000 MHz*1
SCOPE	113	SCP 24.8 FI	(2)4.800 - (2)4.989 MHz (1 kHz/step)	(2)4.890 MHz*1
SCOPE	114	SCP 28.0 FI	(2)8.000 - (2)9.699 MHz (1 kHz/step)	(2)8.000 MHz*1
SCOPE	115	SCP 50.0 FI	(5)0.000 - (5)3.999 MHz (1 kHz/step)	(5)0.000 MHz*1
TUNING	116	tun DIALSTEP	1 or 10 Hz	10 Hz
TUNING	117	tun CW FINE	EnA/diS	diS
TUNING	118	tun MHz SEL	1/0.1 MHz	1 MHz
TUNING	119	tun AM STEP	2.5/5/9/10/12.5 kHz	5 kHz
TUNING	120	tun FM STEP	5/6.25/10/12.5/25 kHz	5 kHz
TUNING	121	tun FM DIAL	10/100 Hz	100 Hz
TUNING	122	tun MY BAND	1.8 ~ 50/GE/AU	—
TX AUDIO	123	tAUd EQ1 FRQ	OFF/100 ~ 700 Hz (100 Hz/step)	OFF
TX AUDIO	124	tAUd EQ1 LVL	-10 ~ +10	+5
TX AUDIO	125	tAUd EQ1 BW	1 ~ 10	10
TX AUDIO	126	tAUd EQ2 FRQ	OFF/700 ~ 1500 Hz (100 Hz/step)	OFF
TX AUDIO	127	tAUd EQ2 LVL	-10 ~ +10	+5
TX AUDIO	128	tAUd EQ2 BW	1 ~ 10	10
TX AUDIO	129	tUAd EQ3 FRQ	OFF/1500 ~ 3200 Hz (100 Hz/step)	OFF
TX AUDIO	130	tUAd EQ3 LVL	-10 ~ +10	+5
TX AUDIO	131	tUAd EQ3 BW	1 ~ 10	10
TX AUDIO	132	tAUd PE1 FRQ	OFF/100 ~ 700 Hz (100 Hz/step)	200 Hz
TX AUDIO	133	tAUd PE1 LVL	-10 ~ +10	-10
TX AUDIO	134	tAUd PE1 BW	1 ~ 10	2
TX AUDIO	135	tAUd PE2 FRQ	OFF/700 ~ 1500 Hz (100 Hz/step)	800 Hz
TX AUDIO	136	tAUd PE2 LVL	-10 ~ +10	-3
TX AUDIO	137	tAUd PE2 BW	1 ~ 10	1
TX AUDIO	138	tUAd PE3 FRQ	OFF/1500 ~ 3200 Hz (100 Hz/step)	2100 Hz
TX AUDIO	139	tUAd PE3 LVL	-10 ~ +10	+6
TX AUDIO	140	tUAd PE3 BW	1 ~ 10	1
TX GNRL	141	tGEn BIAS	—	—*2
TX GNRL	142	tGEn MAX PWR	10/20/50/100 W	100 W
TX GNRL	143	tGEn PWRCTRL	ALL/Car	ALL
TX GNRL	144	tGEn ETX-GND	EnA(ENABLE)/diS(DISABLE)	diS(DISABLE)
TX GNRL	145	tGEn TUN PWR	10/20/50/100 W	100 W
TX GNRL	146	tGEn VOX SEL	nic/dAtA	nic
TX GNRL	147	tGEn EMRGNCY	EnA(ENABLE)/diS(DISABLE)	diS(DISABLE)

*1: Requires optional **DMU-2000** Data Management Unit.

*2: This Menu item does not work. Please do not change this setting.

MENU MODE

AGC GROUP

001 AGc FST DLY

Function: Sets the delay time for the AGC FAST mode of the Main band (VFO-A) receiver.

Available Values: 20 ~ 4000 msec (20 msec/step)

Default Setting: 300 msec

002 AGc FST HLD

Function: Sets the hang time of the AGC peak voltage for the AGC FAST mode of the Main band (VFO-A) receiver.

Available Values: 0 ~ 2000 msec (20 msec/step)

Default Setting: 0 msec

003 AGc MID DLY

Function: Sets the delay time for the AGC MID mode of the Main band (VFO-A) receiver.

Available Values: 20 ~ 4000 msec (20 msec/step)

Default Setting: 700 msec

004 AGc MID HLD

Function: Sets the hang time of the AGC peak voltage for the AGC MID mode of the Main band (VFO-A) receiver.

Available Values: 0 ~ 2000 msec (20 msec/step)

Default Setting: 0 msec

005 AGc SLW DLY

Function: Sets the delay time for the AGC SLOW mode of the Main band (VFO-A) receiver.

Available Values: 20 ~ 4000 msec (20 msec/step)

Default Setting: 2000 msec

006 AGc SLW HLD

Function: Sets the hang time of the AGC peak voltage for the AGC SLOW mode of the Main band (VFO-A) receiver.

Available Values: 0 ~ 2000 msec (20 msec/step)

Default Setting: 0 msec

DISPLAY GROUP

007 diSP COLOR

Function: Selects the Display color when the optional Data Management Unit (**DMU-2000**) is connected.

Available Values: bL1/bL2/bL3/ub1/ub2

bL1: COOL BLUE

bL2: CONTRAST BLUE

bL3: FLASH WHITE

ub1: CONTRAST UMBER

ub2: UMBER

Default Setting: bL1 (COOL BLUE)

ADVICE:

If the optional **DMU-2000** Data Management Unit is not connected, this adjustment has no effect.

008 diSP DIM MTR

Function: Setting of the meter brightness level when "DIM" is selected.

Available Values: 0 ~ 15

Default Setting: 4

009 diSP DIM VFD

Function: Setting of the frequency display brightness level when "DIM" is selected.

Available Values: 0 ~ 15

Default Setting: 8

010 diSP BAR SEL

Function: Selects one of three parameters to be viewed on the Tuning Offset Indicator.

Available Values: CLAr/C-tn/u-tn

Default Setting: C-tn

CLAr: Displays relative clarifier offset.

C-tn: Displays relative tuning offset between the incoming signal and transmitted frequency.

u-tn: Displays the peak position of the VRF or μ -TUNE filter.

NOTE:

The μ -TUNE filter is an option.

011 diSP PK HLD

Function: Selects the peak hold time of the Sub (VFO-B) receiver's S-meter.

Available Values: OFF/0.5/1.0/2.0 sec

Default Setting: OFF

012 diSP RTR STU

Function: Selects the starting point of your rotator controller's indicator needle.

Available Values: 0/90/180/270 °

Default Setting: 0 °

013 diSP RTR ADJ

Function: Adjusts the indicator needle precisely to the starting point set in menu item "012 diSP RTR STU."

Available Values: -30 ~ 0

Default Setting: 0

DISPLAY GROUP

014 diSP QMB MKR

Function: Enables/Disables the QMB Marker (White arrow “▽”) to display on the Spectrum Band Scope when the optional **DMU-2000** Data Management Unit is connected.

Available Values: On/OFF

Default Setting: On

ADVICE:

If the optional **DMU-2000** Data Management Unit is not connected, this adjustment has no effect.

DVS GROUP

015 dUS RX LVL

Function: Sets the audio output level from the voice memory.

Available Values: 0 ~ 100

Default: 50

016 dUS TX LVL

Function: Sets the microphone input level to the voice memory

Available Values: 0 ~ 100

Default: 50

KEYER GROUP

017 tEy BEACON

Function: Sets the interval time between repeats of the beacon message.

Available Values: OFF/1 ~ 255 sec

Default Setting: OFF

018 tEy NUM STL

Function: Selects the Contest Number “Cut” format for an imbedded contest number.

Available Values: 1290/AunO/Aunt/A2nO/A2nt/12nO/12nt

Default Setting: 1290

- 1290: Does not abbreviate the Contest Number
- AunO: Abbreviates to “A” for “One,” “U” for “Two,” “N” for “Nine,” and “O” for “Zero.”
- Aunt: Abbreviates to “A” for “One,” “U” for “Two,” “N” for “Nine,” and “T” for “Zero.”
- A2nO: Abbreviates to “A” for “One,” “N” for “Nine,” and “O” for “Zero.”
- A2nt: Abbreviates to “A” for “One,” “N” for “Nine,” and “T” for “Zero.”
- 12nO: Abbreviates to “N” for “Nine,” and “O” for “Zero.”
- 12nt: Abbreviates to “N” for “Nine,” and “T” for “Zero.”

019 tEy CONTEST

Function: Enters the initial contest number that will increment/decrement after sending during contest QSOs.

Available Values: 1 ~ 9999

Default Setting: 1

ADVICE:

Press the [CLEAR] button to reset the contest number to “1.”

020 tEy CW MEM1

Function: Permits entry of the CW message for message register 1.

Available Values: tyP1/tyP2

Default Setting: tyP2

- tyP1: You may enter the CW message from the front panel’s Function Keys.
- tyP2: You may enter the CW message from the CW keyer.

021 tEy CW MEM2

Function: Permits entry of the CW message for message register 2.

Available Values: tyP1/tyP2

Default Setting: tyP2

- tyP1: You may enter the CW message from the front panel’s Function Keys.
- tyP2: You may enter the CW message from the CW keyer.

KEYER GROUP

022 tEy CW MEM3

Function: Permits entry of the CW message for message register 3.

Available Values: tyP1/tyP2

Default Setting: tyP2

tyP1: You may enter the CW message from the front panel's Function Keys.

tyP2: You may enter the CW message from the CW keyer.

023 tEy CW MEM4

Function: Permits entry of the CW message for message register 4.

Available Values: tyP1/tyP2

Default Setting: tyP2

tyP1: You may enter the CW message from the front panel's Function Keys.

tyP2: You may enter the CW message from the CW keyer.

024 tEy CW MEM5

Function: Permits entry of the CW message for message register 5.

Available Values: tyP1/tyP2

Default Setting: tyP2

tyP1: You may enter the CW message from the front panel's Function Keys.

tyP2: You may enter the CW message from the CW keyer.

ADVICE:

If the optional **FH-2** Remote Control Keypad is not connected, this adjustment has no effect.

GENERAL GROUP

025 GEnE ANT SEL

Function: Sets the method of antenna selection.

Available Values: bAnd/rEG

Default Setting: bAnd

bAnd: The antenna is selected in accordance with the operating band.

rEG: The antenna is selected in accordance with the band stack (different antennas may be utilized on the same band, if so selected in the band stack).

026 GEnE BEP LVL

Function: Sets the beep level.

Available Values: 0 ~ 255

Default Setting: 50

027 GEnE CAT BPS

Function: Sets the transceiver's computer-interface circuitry for the CAT baud rate to be used.

Available Values: 4800/9600/192H(19200)/384H(38400) bps

Default Setting: 4800 bps

028 GEnE CAT TOT

Function: Sets the Time-Out Timer countdown time for a CAT command input.

Available Values: 10/100/1000/3000 msec

Default Setting: 10 msec

The Time-Out Timer shuts off the CAT data input after the continuous transmission of the programmed time.

029 GEnE CAT RTS

Function: Enables/Disables the RTS port of the CAT jack.

Available Values: On/OFF

Default Setting: On

030 GEnE MEM GRP

Function: Enables/Disables Memory Group Operation.

Available Values: On/OFF

Default Setting: OFF

031 GEnE Q SPLIT

Function: Selects the tuning offset for the Quick Split feature.

Available Values: -20 ~ 0 ~ +20 kHz (1 kHz Step)

Default Setting: +5 kHz

GENERAL GROUP

032 GEN E TRACK

Function: Sets the VFO Tracking feature.

Available Values: OFF/bAND/FrEq

Default Setting: OFF

- OFF: Disables the VFO Tracking feature.
- bAND: When you change bands on the Main (VFO-A) side, the Sub (VFO-B) band's VFO will automatically change to be the same as that of VFO-A.
- FrEq: This function is the almost same as "bAND," however, furthermore, the Sub band's (VFO-B) frequency changes together with the Main Band's (VFO-A) frequency when turning the Main Dial Tuning knob.

033 GEN E TX TOT

Function: Sets the Time-Out Timer countdown time.

Available Values: OFF/5/10/15/20/25/30 min

Default Setting: OFF

The Time-Out Timer shuts off the transmitter after continuous transmission of the programmed time.

034 GEN E TRV SET

Function: Sets the 10's and 1's of the MHz digits display for operation with a transverter.

Available Values: 30 ~ 49 MHz

Default Setting: 44 MHz

The default setting would be used with a 144 MHz transverter. If you connect a 430 MHz transverter to the radio, set this menu to "30" (the "100 MHz" digits are hidden on this radio).

035 GEN E μ T DIAL

Function: Selects the μ -TUNE mode.

Available Values: StP1/ StP2/OFF

Default Setting: StP1

- StP-1: Activates the μ -TUNE system using "COARSE" steps of the [VRF] knob (2 steps/click) on the 7 MHz and lower amateur bands. On the 10/14 MHz bands, "FINE" [VRF] knob steps (1 step/click) will be used.
- StP2: Activates the μ -TUNE system using "FINE" steps of the [VRF] knob (1 step/click) on the 14 MHz and lower amateur bands on the Main band (VFO-A).
- OFF: Disables the μ -TUNE system. Activates the VRF feature on the 14 MHz and lower amateur bands on the main band (VFO-A).

ADVICE:

If the optional RF μ Tuning Kit is not connected, this adjustment has no effect.

036 GEN E SNB LVL

Function: Adjusts the Sub band (VFO-B) receiver's IF Noise Blanker level, when the Noise Blanker is engaged.

Available Values: nAin(MAIN)/0~100

Default Setting: nAin(MAIN)

When this menu is set to "nAin(MAIN)," you may adjust the Noise Blanker level using the front panel's [NB] knob.

037 GEN E SUB FIL

Function: Defines the Sub band (VFO-B) receiver's CW narrow filter.

Available Values: 1200/300/500 Hz

Default Setting: 1200 Hz

ADVICE:

This Menu item tells the microprocessor which (if any) optional filter has been installed.

038 GEN E MIC SCN

Function: Enables/disables scanning access via the microphone's [UP]/[DWN] keys.

Available Values: On/OFF

Default Setting: On

039 GEN E SCN RSM

Function: Selects the Scan Resume mode.

Available Values: CAr/5SEc

Default Setting: 5SEc

- CAr: The scanner will hold until the signal disappears, then will resume after one second.
- 5SEc: The scanner will hold for five seconds, then resume whether or not the other station is still transmitting.

040 GEN E ANTIVOX

Function: Adjusts the Anti-VOX Trip Gain which is the level of negative feedback of receiver audio to the microphone, to prevent receiver audio from activating the transmitter (via the microphone) during VOX operation.

Available Values: 0 ~ 100

Default Setting: 50

041 GEN E FRQ ADJ

Function: Adjusts the reference oscillator.

Available Values: -25 ~ 0 ~ +25

Default Setting: 0

Connect a 50-Ohm dummy load and frequency counter to the antenna jack; adjust the [SUB VFO-B] knob so that the frequency counter reading is same as the VFO frequency while pressing the PTT switch.

ADVICE:

Do not perform this Menu item unless you have a high-performance frequency counter. Perform this Menu item after aging the transceiver and frequency counter sufficiently (at least 30 minutes).

MENU MODE

S IF SFT (SUB BAND IF SHIFT) GROUP

042 S-iF LSB SFT

Function: Sets the center frequency of the Sub band (VFO-B) receiver's IF filter in the LSB mode.

Available Values: -1000 ~ +1000 Hz

Default Setting: 0 Hz

043 S-iF USB SFT

Function: Sets the center frequency of the Sub band (VFO-B) receiver's IF filter in the USB mode.

Available Values: -1000 ~ +1000 Hz

Default Setting: 0 Hz

044 S-iF CWL SFT

Function: Sets the center frequency of the Sub band (VFO-B) receiver's IF filter in the CW (LSB) mode.

Available Values: -1000 ~ +1000 Hz

Default Setting: 0 Hz

045 S-iF CWU SFT

Function: Sets the center frequency of the Sub band (VFO-B) receiver's IF filter in the CW (USB) mode.

Available Values: -1000 ~ +1000 Hz

Default Setting: 0 Hz

046 S-iF RTTY

Function: Sets the center frequency of the Sub band (VFO-B) receiver's IF filter in the RTTY mode.

Available Values: -1000 ~ +1000 Hz

Default Setting: 0 Hz

047 S-iF RTTY-R

Function: Sets the center frequency of the Sub band (VFO-B) receiver's IF filter in the RTTY reverse mode.

Available Values: -1000 ~ +1000 Hz

Default Setting: 0 Hz

048 S-iF PKT-LSB

Function: Sets the center frequency of the Sub band (VFO-B) receiver's IF filter in the Packet (LSB) mode.

Available Values: -1000 ~ +1000 Hz

Default Setting: 0 Hz

049 S-iF PKT-USB

Function: Sets the center frequency of the Sub band (VFO-B) receiver's IF filter in the Packet (USB) mode.

Available Values: -1000 ~ +1000 Hz

Default Setting: 0 Hz

MODE-AM GROUP

050 A3E MICGAIN

Function: Sets the microphone gain for the AM mode.

Available Values: Ur/0 ~ 100

Default Setting: 30

When this menu is set to "Ur," you may adjust the microphone gain using the front panel's [MIC] knob.

051 A3E MIC SEL

Function: Selects the microphone to be used on the AM mode.

Available Values: Frnt/dAtA/PC

Default Setting: Frnt

Frnt: Selects the microphone connected to the front panel's **MIC** jack while using the AM mode.

dAtA: Selects the microphone connected to pin 1 of the **PACKET** Jack while using the AM mode.

PC: This parameter is for future expansion of this transceiver's capabilities, but at this time is not supported.

MODE-CW GROUP

052 A1A F-TYPE

Function: Selects the desired keyer operation mode for the device connected to the front panel's **KEY** jack.

Available Values: OFF/buG/ELE/ACS

Default Setting: ELE

OFF: Disables the front panel's keyer ("straight key" mode for use with external keyer or computer-driven keying interface).

buG: Mechanical "bug" keyer emulation. One paddle produces "dits" automatically, while the other paddle manually produces "dahs."

ELE: Iambic keyer with ACS (Automatic Character Spacing) disabled.

ACS: Iambic keyer with ACS (Automatic Character Spacing) enabled.

053 A1A F-REV

Function: Selects the keyer paddle's wiring configuration for the **KEY** jack on the front panel.

Available Values: nor/rEU

Default Setting: nor

nor: Tip = Dot, Ring = Dash, Shaft = Ground

rEU: Tip = Dash, Ring = Dot, Shaft = Ground

054 A1A R-TYPE

Function: Selects the desired keyer operation mode for the device connected to the rear panel's **KEY** jack.

Available Values: OFF/buG/ELE/ACS

Default Setting: ELE

OFF: Disables the rear panel's keyer ("straight key" mode for use with external keyer or computer-driven keying interface).

buG: Mechanical "bug" keyer emulation. One paddle produces "dits" automatically, while the other paddle manually produces "dahs."

ELE: Iambic keyer with ACS (Automatic Character Spacing) disabled.

ACS: Iambic keyer with ACS (Automatic Character Spacing) enabled.

055 A1A R-REV

Function: Selects the keyer paddle's wiring configuration for the **KEY** jack on the rear panel.

Available Values: nor/rEU

Default Setting: nor

nor: Tip = Dot, Ring = Dash, Shaft = Ground

rEU: Tip = Dash, Ring = Dot, Shaft = Ground

056 A1A CW AUTO

Function: Enables/disables CW keying while operating on SSB.

Available Values: OFF/50/On

Default Setting: OFF

OFF: Disables CW keying while operating on SSB.

50: Enables CW keying only while operating SSB on 50 MHz (but not HF).

On: Enables CW keying while operating on SSB (all TX bands).

NOTE:

This feature allows you to move someone from SSB to CW without having to change modes on the front panel.

057 A1A BFO

Function: Sets the CW carrier oscillator injection side for the CW mode.

Available Values: USb/LSb/Auto

Default Setting: USb

USb: Injects the CW carrier oscillator on the USB side.

LSb: Injects the CW carrier oscillator on the LSB side.

Auto: Injects the CW carrier oscillator on the LSB side while operating on the 7 MHz band and below, and the USB side while operating on the 10 MHz band and up.

058 A1A BK-IN

Function: Sets the CW "break-in" mode.

Available Values: SEni/FuLL

Default Setting: SEni

SEni (SEMI): The transceiver will operate in the semi break-in mode. The delay (receiver recovery) time is set by the front panel's [DELAY] knob.

FuLL: The transceiver will operate in the full break-in (QSK) mode.

059 A1A SHAPE

Function: Selects the CW carrier wave-form shape (rise/fall times).

Available Values: 1/2/4/6 msec

Default Setting: 4 msec

060 A1A WEIGHT

Function: Sets the Dot:Dash ratio for the built-in electronic keyer.

Available Values: (1:) 2.5 ~ 4.5

Default Setting: 3.0

MODE-CW GROUP

061 A1A FRQDISP

Function: Selects the frequency Display Format for the CW mode.

Available Values: dir/OFSt

Default Setting: OFSt

dir (Direct Frequency): Displays the receiver carrier frequency, without any offset added. When changing modes between SSB and CW, the frequency display remains constant.

OFSt (Pitch Offset): This frequency display reflects the added BFO offset.

062 A1A PC KYNG

Function: Enables/disables CW keying from the “DATA IN” terminal on the rear panel’s **PACKET** jack while operating on the CW mode.

Available Values: EnA (Enable)/diS (Disable)

Default Setting: diS (Disable)

063 A1A QSKTIME

Function: Selects the time delay between when the **PTT** is keyed and the carrier is transmitted during QSK operation when using the internal keyer.

Available Values: 15/20/25/30 msec

Default Setting: 15 msec

MODE-DAT GROUP

064 dAtA DATA IN

Function: Selects the data input path to be used on the PKT mode.

Available Values: dAtA/PC

Default Setting: dAtA

dAtA: Uses the data input line connected to pin 1 of the **PACKET** jack while using the PKT mode.

PC: This parameter is for future expansion of this transceiver’s capabilities, but at this time is not supported.

065 dAtA DT GAIN

Function: Sets the data input level from the TNC to the AFSK modulator.

Available Values: 0 ~ 100

Default Setting: 50

066 dAtA DT OUT

Function: Selects the receiver to be connected to the data output port (pin 4) of the **PACKET** jack.

Available Values: nAin (Main)/Sub (Sub)

Default Setting: nAin (Main)

067 dAtA OUT LVL

Function: Sets the AFSK data output level at the output port (pin 4) of the **PACKET** jack.

Available Values: 0 ~ 100

Default Setting: 50

068 dAtA VOX DLY

Function: Adjusts the “VOX” delay (receiver recovery) time on the PKT mode.

Available Values: 30 ~ 3000 msec

Default Setting: 300 msec

069 dAtA V GAIN

Function: Adjusts the “VOX” gain on the PKT mode.

Available Values: 0 ~ 100

Default Setting: 50

070 dAtA PKTDISP

Function: Sets the packet frequency display offset.

Available: -3000 ~ +3000 Hz (10 Hz/step)

Default: 0 Hz

071 dAtA PKT SFT

Function: Sets the carrier point during the SSB packet operation.

Available: -3000 ~ +3000 Hz (10 Hz/step)

Default: 1000 Hz (typical center frequency for PSK31, etc.)

MODE-FM GROUP

072 F3E MICGAIN

Function: Sets the microphone gain for the FM mode.

Available Values: Ur/0 ~ 100

Default Setting: 50

When this menu is set to “Ur,” you may adjust the microphone gain using the front panel’s [MIC] knob.

073 F3E MIC SEL

Function: Selects the microphone to be used on the FM mode.

Available Values: Frnt/dAtA/PC

Default Setting: Frnt

Frnt (FRONT): Selects the microphone connected to the front panel’s MIC jack while using the FM mode.

dAtA: Selects the microphone connected to pin 1 of the PACKET Jack while using the FM mode.

PC: This parameter is for future expansion of this transceiver’s capabilities, but at this time is not supported.

074 F3E 28 RPT

Function: Sets the magnitude of the repeater shift on the 28 MHz band.

Available Values: 0 ~ 1000 kHz (10 kHz/step)

Default Setting: 100 kHz

075 F3E 50 RPT

Function: Sets the magnitude of the repeater shift on the 50 MHz band.

Available Values: 0 ~ 4000 kHz (10 kHz/step)

Default Setting: 1000 kHz

MODE-RTY GROUP

076 rtty R PLRTY

Function: Selects normal or reverse Mark/Space polarity for RTTY receive operation.

Available Values: nor/rEU

Default Setting: nor

077 rtty T PLRTY

Function: Selects normal or reverse Mark/Space polarity for RTTY transmit operation.

Available Values: nor/rEU

Default Setting: nor

078 rtty RTY OUT

Function: Selects the receiver to be connected to the data output port (pin 1) of the RTTY jack.

Available Values: nAin (Main)/Sub (Sub)

Default Setting: nAin (Main)

079 rtty OUT LEL

Function: Sets the FSK RTTY data output level at the output port (pin 1) of the RTTY jack.

Available Values: 0 ~ 100

Default Setting: 50

080 rtty SHIFT

Function: Selects the frequency shift for FSK RTTY operation.

Available Values: 170/200/425/850 Hz

Default Setting: 170 Hz

081 rtty TONE

Function: Selects the Mark tone for RTTY operation.

Available Values: 1275/2125 Hz

Default Setting: 2125 Hz

MENU MODE

MODE-SSB GROUP

082 J3E MIC SEL

Function: Selects the microphone to be used on the SSB modes (LSB and USB).

Available Values: Frnt/dAtA/PC

Default Setting: Frnt

Frnt (FRONT): Selects the microphone connected to the front panel's **MIC** jack while using the SSB modes.

dAtA: Selects the microphone connected to pin 1 of the **PACKET** Jack while using the SSB modes.

PC: This parameter is for future expansion of this transceiver's capabilities, but at this time is not supported.

083 J3E TX BPF

Function: Selects the audio passband of the DSP modulator on the SSB mode.

Available Values: 1-30/1-29/2-28/3-27/4-26/3000

1-30: 50-3000(Hz)

1-29: 100-2900(Hz)

2-28: 200-2800(Hz)

3-27: 300-2700(Hz)

4-26: 400-2600(Hz)

3000: 3000WB

Default Setting: 3-27 (300-2700 Hz)

NOTE:

The apparent power output, when using the widest bandwidths, may seem lower. This is normal, and it occurs because the available transmitter power is distributed over a wider bandwidth. The greatest compression of power output, conversely, occurs when using the "4-26" setting (400-2600 Hz), and this setting is highly recommended for contest or DX pile-up work.

084 J3E LSB CAR

Function: Adjusts the receiver carrier point for the Main band's (VFO-A) LSB mode.

Available Values: -200 Hz ~ +200 Hz (10 Hz steps)

Default Setting: 0 Hz

085 J3E USB CAR

Function: Adjusts the receiver carrier point for Main band's (VFO-A) USB mode.

Available Values: -200 Hz ~ +200 Hz (10 Hz/step)

Default Setting: 0 Hz

086 J3E SLSB CR

Function: Adjusts the receiver carrier point for the Sub band's (VFO-B) LSB mode.

Available Values: -200 Hz ~ +200 Hz (10 Hz/step)

Default Setting: 0 Hz

087 J3E SUSB CR

Function: Adjusts the receiver carrier point for Sub band's (VFO-B) USB mode.

Available Values: -200 Hz ~ +200 Hz (10 Hz/step)

Default Setting: 0 Hz

RX AUDIO GROUP

088 rout AGC SLP

Function: Selects the gain curve of the AGC amplifier.

Available Values: nor/SLP

Default Setting: nor

nor (NORMAL): The AGC output level will follow a linear response to the antenna input level, while AGC is activated.

SLP (SLOPED): The AGC output level will increase at 1/10 the rate of the antenna input level, while AGC is activated.

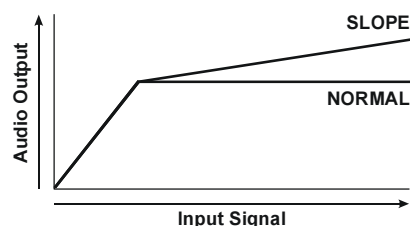

089 rout HEADPHN

Function: Selects one of three audio mixing modes when using headphones during Dual Receive operation.

Available Values: SEP/Con1/Con2

Default Setting: SEP

SEP (SEPARATE): Audio from the Main (VFO-A) receiver is heard only in the left ear, and Sub (VFO-B) receiver audio solely in the right ear.

Con1 (COMBINE 1): Audio from both Main (VFO-A) and Sub (VFO-B) receivers can be heard in both ears, but Sub (VFO-B) audio is attenuated in the left ear and Main (VFO-A) audio is attenuated in the right ear.

Con2 (COMBINE 2): Audio from both Main (VFO-A) and Sub (VFO-B) receivers is combined and heard equally in both ears.

RX DSP GROUP

090 rdSP CNTR LV

Function: Adjusts the parametric equalizer gain of the Contour filter.

Available Values: -40 ~ +20 dB

Default Setting: -15 dB

091 rdSP CNTR WI

Function: Adjusts the Q-factor of the Contour filter.

Available Values: 1 - 11

Default Setting: 10

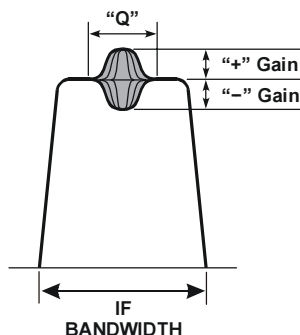

CONTOUR "GAIN" AND "Q"

092 rdSP NOTCH W

Function: Selects the bandwidth of the DSP NOTCH filter

Available Values: nArr (Narrow)/uuid (Wide)

Default Setting: uuid (Wide)

093 rdSP CW SHAP

Function: Selects the passband characteristics of the DSP filter for the CW mode.

Available Values: SOFt/ShAP

Default Setting: ShAP

SOFt (SOFT): Primary importance is attached to the amplitude of the filter factor.

ShAP (SHARP): Primary importance is attached to the phase of the filter factor.

094 rdSP CW SLP

Function: Selects the shape factor of the DSP filter for the CW mode.

Available Values: StP(STEEP)/nEd(MEDIUM)/GEnt(GENTLE)

Default Setting: nEd (MEDIUM)

095 rdSP CW NARR

Function: Selects the passband of the DSP filter for the CW "Narrow" mode.

Available Values: 25/50/100/200/300/400/500/800/1200/1400/1700/2000 Hz

Default Setting: 500 Hz

096 rdSP PKT SHP

Function: Selects the passband characteristics of the DSP filter for the PKT mode.

Available Values: SOFt/ShAP

Default Setting: ShAP

SOFt (SOFT): Primary importance is attached to the amplitude of the filter factor.

ShAP (SHARP): Primary importance is attached to the phase of the filter factor.

097 rdSP PKT SLP

Function: Selects the shape factor of the DSP filter for the PKT mode.

Available Values: StP(STEEP)/nEd(MEDIUM)/GEnt(GENTLE)

Default Setting: nEd (MEDIUM)

098 rdSP PKT NAR

Function: Selects the passband of the DSP filter for the PKT "Narrow" mode.

Available Values: 25/50/100/200/300/400 Hz

Default Setting: 300 Hz

099 rdSP RTY SHP

Function: Selects the passband characteristics of the DSP filter for the RTTY mode.

Available Values: SOFt/ShAP

Default Setting: ShAP

SOFt (SOFT): Primary importance is attached to the amplitude of the filter factor.

ShAP (SHARP): Primary importance is attached to the phase of the filter factor.

100 rdSP RTY SLP

Function: Selects the shape factor of the DSP filter for the RTTY mode.

Available Values: StP(STEEP)/nEd(MEDIUM)/GEnt(GENTLE)

Default Setting: nEd (MEDIUM)

101 rdSP RTY NAR

Function: Selects the passband of the DSP filter for the RTTY "Narrow" mode.

Available Values: 25/50/100/200/300/400 Hz

Default Setting: 300 Hz

MENU MODE

RX DSP GROUP

102 rdSP SSB SHP

Function: Selects the passband characteristics of the DSP filter for the SSB modes (LSB and USB).

Available Values: SOFt/ShAP

Default Setting: ShAP

SOFt (SOFT): Primary importance is attached to the amplitude of the filter factor.

ShAP (SHARP): Primary importance is attached to the phase of the filter factor.

103 rdSP SSB SLP

Function: Selects the shape factor of the DSP filter for the SSB modes (LSB and USB).

Available Values: StP(STEEP)/nEd(MEDIUM)/GEnt(GENTLE)

Default Setting: nEd (MEDIUM)

104 rdSP SSB NAR

Function: Selects the passband of the DSP filter for the "Narrow" SSB mode.

Available Values: 200/400/600/850/1100/1350/1500/1650/1800/1950/2100/2250 Hz

Default Setting: 1800 Hz

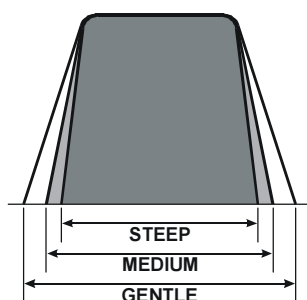

DSP FILTER PASSBAND

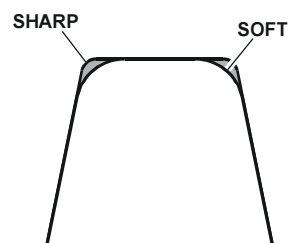

DSP FILTER SHAPE

SCOPE GROUP

ADVICE:

This group's adjustment has no effect, if the optional DMU-2000 Data Management Unit is not connected.

105 SCP 1.8 FI

Function: Selects the scan start frequency of the FIX mode Spectrum Scope while monitoring on the 160 m amateur band.

Available Values: 1.800 - 1.999 MHz (1 kHz/step)

Default Setting: 1.800 MHz

106 SCP 3.5 FI

Function: Selects the scan start frequency of the FIX mode Spectrum Scope while monitoring on the 80 m amateur band.

Available Values: 3.500 - 3.999 MHz (1 kHz/step)

Default Setting: 3.500 MHz

107 SCP 5.0 FI

Function: Selects the scan start frequency of the FIX mode Spectrum Scope while monitoring on the 60 m amateur band.

Available Values: 5.250 - 5.499 MHz (1 kHz/step)

Default Setting: 5.250 MHz

108 SCP 7.0 FI

Function: Selects the scan start frequency of the FIX mode Spectrum Scope while monitoring on the 40 m amateur band.

Available Values: 7.000 - 7.299 MHz (1 kHz/step)

Default Setting: 7.000 MHz

109 SCP 10.1 FI

Function: Selects the scan start frequency of the FIX mode Spectrum Scope while monitoring on the 30 m amateur band.

Available Values: (1)0.100 - (1)0.149 MHz (1 kHz steps)

Default Setting: (1)0.100 MHz

SCOPE GROUP

110 SCP 14.0 FI

Function: Selects the scan start frequency of the FIX mode Spectrum Scope while monitoring on the 20 m amateur band.

Available Values: (1)4.000 - (1)4.349 MHz (1 kHz/step)

Default Setting: (1)4.000 MHz

111 SCP 18.0 FI

Function: Selects the scan start frequency of the FIX mode Spectrum Scope while monitoring on the 17 m amateur band.

Available Values: (1)8.000 - (1)8.199 MHz (1 kHz/step)

Default Setting: (1)8.068 MHz

112 SCP 21.0 FI

Function: Selects the scan start frequency of the FIX mode Spectrum Scope while monitoring on the 15 m amateur band.

Available Values: (2)1.000 - (2)1.449 MHz (1 kHz/step)

Default Setting: (2)1.000 MHz

113 SCP 24.8 FI

Function: Selects the scan start frequency of the FIX mode Spectrum Scope while monitoring on the 12 m amateur band.

Available Values: (2)4.800 - (2)4.989 MHz (1 kHz/step)

Default Setting: (2)4.890 MHz

114 SCP 28.0 FI

Function: Selects the scan start frequency of the FIX mode Spectrum Scope while monitoring on the 10 m amateur band.

Available Values: (2)8.000 - (2)9.699 MHz (1 kHz/step)

Default Setting: (2)8.000 MHz

115 SCP 50.0 FI

Function: Selects the scan start frequency of the FIX mode Spectrum Scope while monitoring on the 6 m amateur band.

Available Values: (5)0.000 - (5)3.999 MHz (1 kHz/step)

Default Setting: (5)0.000 MHz

TUNING GROUP

116 tun DIALSTEP

Function: Setting of the Main Tuning Dial knob's tuning speed on the SSB, CW, and AM modes.

Available Values: 1 or 10 Hz

Default Setting: 10 Hz

117 tun CW FINE

Function: Enabling/disabling of the "Fine" tuning speed in the CW mode.

Available Values: EnA (ENABLE) / diS (DISABLE)

Default Setting: diS (DISABLE)

EnA (ENABLE): Tuning in 1 Hz steps on the CW mode.

diS (DISABLE): Tuning according to the steps determined via menu item "116 tun DIALSTEP."

118 tun MHz SEL

Function: Selects the tuning steps for the [SUB VFO-B] knob when the [MHz] button is pressed.

Available Values: 1/0.1 MHz

Default Setting: 1 MHz

119 tun AM STEP

Function: Selects the tuning steps for the microphone's [UP]/[DWN] keys in the AM mode.

Available Values: 2.5/5/9/10/12.5 kHz

Default Setting: 5 kHz

120 tun FM STEP

Function: Selects the tuning steps for the microphone's [UP]/[DWN] keys in the FM mode.

Available Values: 5/6.25/10/12.5/25 kHz

Default Setting: 5 kHz

121 tun FM DIAL

Function: Setting of the Main Tuning Dial knob's tuning speed in the FM mode.

Available Values: 10/100 Hz per step

Default Setting: 100 Hz per step

122 tun MY BAND

Function: Programs a band to be skipped while selecting bands using the [SUB VFO-B] knob.

Available Values: 1.8 ~ 50/GE/AU

Default Setting: —

To program the band to be skipped, rotate the [SUB VFO-B] knob to recall the band to be skipped while selecting bands via the [SUB VFO-B] knob, then press the [ENT] button to change this setting to "ON" (a "d" notation will replace the "E" notation). Repeat the same procedures to cancel the setting (skipped "Off": "d" notation appears).

TX AUDIO GROUP

123 tAUd EQ1 FRQ

Function: Selects the center frequency of the lower range for the parametric microphone equalizer.

Available Values: OFF/100 ~ 700 Hz (100 Hz/step)

Default Setting: OFF

OFF: The equalizer gain and Q-factor are set to factory defaults (flat).

100 ~ 700: Center frequencies of 100 Hz ~ 700 Hz. You may adjust the equalizer gain and Q-factor at this selected audio frequency via menu items “124 tAUd EQ1 LVL” and “125 tAUd EQ1 BW.”

124 tAUd EQ1 LVL

Function: Adjusts the equalizer gain of the low range of the parametric microphone equalizer.

Available Values: -10 ~ +10

Default Setting: +5

125 tAUd EQ1 BW

Function: Adjusts the Q-factor of the low range of the parametric microphone equalizer.

Available Values: 1 ~ 10

Default Setting: 10

126 tAUd EQ2 FRQ

Function: Selects the center frequency of the middle range for the parametric microphone equalizer.

Available Values: OFF/700 ~ 1500 Hz (100 Hz/step)

Default Setting: OFF

OFF: The equalizer gain and Q-factor are set to factory defaults (flat).

700 ~ 1500: Center frequencies of 700 Hz ~ 1500 Hz. You may adjust the equalizer gain and Q-factor at this selected audio frequency via menu items “127 tAUd EQ2 LVL” and “128 EQ2 BW.”

127 tAUd EQ2 LVL

Function: Adjusts the equalizer gain of the middle range of the parametric microphone equalizer.

Available Values: -10 ~ +10

Default Setting: +5

128 tAUd EQ2 BW

Function: Adjusts the Q-factor of the middle range of the parametric microphone equalizer.

Available Values: 1 ~ 10

Default Setting: 10

129 tUAd EQ3 FRQ

Function: Selects the center frequency of the high range for the parametric microphone equalizer.

Available Values: OFF/1500 ~ 3200 Hz (100 Hz/step)

Default Setting: OFF

OFF: The equalizer gain and Q-factor are set to factory defaults (flat).

1500 ~ 3200: Center frequencies of 1500 Hz ~ 3200 Hz. You may adjust the equalizer gain and Q-factor in this selected audio frequency via menu items “130 tUAd EQ3 LVL” and “131 tUAd EQ3 BW.”

130 tUAd EQ3 LVL

Function: Adjusts the equalizer gain of the high range of the parametric microphone equalizer.

Available Values: -10 ~ +10

Default Setting: +5

131 tUAd EQ3 BW

Function: Adjusts the Q-factor of the high range of the parametric microphone equalizer.

Available Values: 1 ~ 10

Default Setting: 10

132 tAUd PE1 FRQ

Function: Selects the center frequency of the lower range for the parametric microphone equalizer when the speech processor is activated.

Available Values: OFF/100 ~ 700 Hz (100 Hz/step)

Default Setting: 200 Hz

OFF: The equalizer gain and Q-factor are set to factory defaults (flat).

100 ~ 700: Center frequencies of 100 Hz ~ 700 Hz. You may adjust the equalizer gain and Q-factor at this selected audio frequency via menu items “133 tAUd PE1 LVL” and “134 tAUd PE1 BW.”

133 tAUd PE1 LVL

Function: Adjusts the equalizer gain of the low range of the parametric microphone equalizer when the speech processor is activated.

Available Values: -10 ~ +10

Default Setting: -10

134 tAUd PE1 BW

Function: Adjusts the Q-factor of the low range of the parametric microphone equalizer when the speech processor is activated.

Available Values: 1 ~ 10

Default Setting: 2

TX AUDIO GROUP

135 tAUd PE2 FRQ

Function: Selects the center frequency of the middle range for the parametric microphone equalizer when the speech processor is activated.

Available Values: OFF/700 ~ 1500 Hz (100 Hz/step)

Default Setting: 800 Hz

OFF: The equalizer gain and Q-factor are set to factory defaults (flat).

700 ~ 1500: Center frequencies of 700 Hz ~ 1500 Hz. You may adjust the equalizer gain and Q-factor at this selected audio frequency via menu items “136 tAUd PE2 LVL” and “137 PE2 BW.”

136 tAUd PE2 LVL

Function: Adjusts the equalizer gain of the middle range of the parametric microphone equalizer when the speech processor is activated.

Available Values: -10 ~ +10

Default Setting: -3

137 tAUd PE2 BW

Function: Adjusts the Q-factor of the middle range of the parametric microphone equalizer when the speech processor is activated.

Available Values: 1 ~ 10

Default Setting: 1

138 tUAd PE3 FRQ

Function: Selects the center frequency of the high range for the parametric microphone equalizer when the speech processor is activated.

Available Values: OFF/1500 ~ 3200 Hz (100 Hz/step)

Default Setting: 2100 Hz

OFF: The equalizer gain and Q-factor are set to factory defaults (flat).

1500 ~ 3200: Center frequencies of 1500 Hz ~ 3200 Hz. You may adjust the equalizer gain and Q-factor in this selected audio frequency via menu items “139 tUAd PE3 LVL” and “140 tUAd PE3 BW.”

139 tUAd PE3 LVL

Function: Adjusts the equalizer gain of the high range of the parametric microphone equalizer when the speech processor is activated.

Available Values: -10 ~ +10

Default Setting: +6

140 tUAd PE3 BW

Function: Adjusts the Q-factor of the high range of the parametric microphone equalizer when the speech processor is activated.

Available Values: 1 ~ 10

Default Setting: 1

TX GNRL GROUP

141 tGEn BIAS

This Menu item does not work. Please do not change this setting.

142 tGEn MAX PWR

Function: Selects a maximum output power limit.

Available Values: 10/20/50/100 W

Default Setting: 100 W

143 tGEn PWRCTRL

Function: Configures the [RF PWR] knob.

Available Values: ALL/CAR

Default Setting: ALL

ALL: The [RF PWR] knob is enabled on all modes.

CAR: The [RF PWR] knob is enabled in all modes except SSB. In this configuration, the SSB output power will be set to maximum, regardless of the [RF PWR] knob's position.

144 tGEn ETX-GND

Function: Enables/Disables the TX GND jack on the rear panel.

Available Values: EnA(ENABLE)/diS(DISABLE)

Default Setting: diS(DISABLE)

145 tGEn TUN PWR

Function: Selects a maximum output power limit for driving the input circuit of an external linear RF amplifier while tuning (while using the Remote Control function of the linear RF amplifier).

Available Values: 10/20/50/100 W

Default Setting: 100 W

146 tGEn VOX SEL

Function: Selects the audio input source for triggering TX during VOX operation.

Available Values: nic/dAtA

Default Setting: nic

nic(MIC): The VOX function will be activated by microphone audio input.

dAtA(DATA): The VOX function will be activated by data audio input.

147 tGEn EMRGNCY

Function: Enables Tx/Rx operation on the Alaska Emergency Channel, 5167.5 kHz.

Available Values: EnA(ENABLE)/diS(DISABLE)

Default Setting: diS(DISABLE)

When this Menu Item is set to “EnA(ENABLE),” the spot frequency of 5167.5 kHz will be enabled. The Alaska Emergency Channel will be found between the Memory channels “P-1” and “01 (or 1-01).”

IMPORTANT:

The use of this frequency is restricted to stations operating in or near Alaska, and only for emergency purposes (never for routine operations). See §97.401(c) of the FCC's regulations for details.

SPECIFICATIONS

General

Rx Frequency Range:	30 kHz - 60 MHz (operating) 160 - 6 m (specified performance, Amateur bands only)
Tx Frequency Ranges:	160 - 6 m (Amateur bands only)
Frequency Stability:	±0.5 ppm (after 1 minute @+77 °F [+25 °C]) ±1.0 ppm (after 1 minute @+14 °F ~ +122 °F [-10 °C ~ +50 °C])
Operating Temperature Range:	14 °F ~ +122 °F (-10 °C ~ +50 °C)
Emission Modes:	A1A (CW), A3E (AM), J3E (LSB, USB), F3E (FM), F1B (RTTY), F1D (PACKET), F2D (PACKET)
Frequency Steps:	1/10 Hz (SSB,CW, & AM), 100 Hz (FM)
Antenna Impedance:	50 Ohms, unbalanced 16.7 - 150 Ohms, unbalanced (Tuner ON, 160 - 10 m Amateur bands) 25 - 100 Ohms, unbalanced (Tuner ON, 6 m Amateur band)
Power Consumption: (@117 VAC)	Rx (no signal) 70 VA Rx (signal present) 80 VA Tx (100 W) 450 VA
Supply Voltage:	AC: 90 VAC - 132 VAC or 180 VAC- 264 VAC DC: DC 13.8 V ± 10%
Dimensions (WxHxD):	16.1" x 5.3" x 13.8" (410 x 135 x 350 mm)
Weight (approx.):	32 lbs (14.5 kg)

Transmitter

Power Output:	5 - 100 watts (2 - 25 watts AM carrier)
Modulation Types:	J3E (SSB): Balanced, A3E (AM): Low-Level (Early Stage), F3E (FM): Variable Reactance
Maximum FM Deviation:	±5.0 kHz/±2.5 kHz
Harmonic Radiation:	Better than -60 dB (160 - 10m Amateur bands) Better than -70 dB (6m Amateur band)
SSB Carrier Suppression:	At least 60 dB below peak output
Undesired Sideband Suppression:	At least 60 dB below peak output
Audio Response (SSB):	Not more than -6 dB from 300 to 2700 Hz
3rd-order IMD:	-31 dB @14 MHz 100 watts PEP
Microphone Impedance:	600 Ohms (200 to 10 kOhms)

Receiver

Circuit Type:	Main (VFO-A); Triple-conversion superheterodyne Sub (VFO-B); Double-conversion superheterodyne																														
Intermediate Frequencies:	Main (VFO-A); 69.450 MHz/450 kHz/30 kHz (24 kHz for AM/FM), Sub (VFO-B); 40.455 MHz/455 kHz																														
Sensitivity (RF AMP 2 "ON"):	SSB (2.4 kHz, 10 dB S+N/N) 6 μ V (0.1 - 1.8 MHz) 0.2 μ V (1.8 - 30 MHz) 0.125 μ V (50 - 54 MHz) AM (6 kHz, 10 dB S+N/N, 30 % modulation @400 Hz) 3.2 μ V (0.1 - 1.8 MHz) 2 μ V (1.8 - 30 MHz) 1 μ V (50 - 54 MHz) FM (BW: 15 kHz, 12 dB SINAD) 0.5 μ V (28 - 30 MHz) 0.35 μ V (50 - 54 MHz) There is no specification in frequency ranges not listed.																														
Squelch Sensitivity: (RF AMP 2 "ON")	SSB/CW/AM 2 μ V (0.1 - 30 MHz) 2 μ V (50 - 54 MHz) FM 1 μ V (28 - 30 MHz) 1 μ V (50 - 54 MHz) There is no specification in frequency ranges not listed.																														
Selectivity (-6/-60 dB):	Main (VFO-A) <table><tr><td>Mode</td><td>-6 dB</td><td>-60 dB</td></tr><tr><td>CW/RTTY/PKT</td><td>0.5 kHz or better</td><td>750 Hz or less</td></tr><tr><td>SSB</td><td>2.4 kHz or better</td><td>3.6 kHz or less</td></tr><tr><td>AM</td><td>6 kHz or better</td><td>15 kHz or less</td></tr><tr><td>FM</td><td>15 kHz or better</td><td>25 kHz or less</td></tr></table> (WIDTH: Center, VRF: OFF) Sub (VFO-B) <table><tr><td>Mode</td><td>-6 dB</td><td>-60 dB</td></tr><tr><td>CW/RTTY/PKT</td><td>1.1 kHz or better</td><td>3.0 kHz or less</td></tr><tr><td>SSB</td><td>2.2 kHz or better</td><td>4.5 kHz or less</td></tr><tr><td>AM</td><td>6 kHz or better</td><td>25 kHz or less</td></tr><tr><td>FM</td><td>12 kHz or better</td><td>30 kHz or less</td></tr></table>	Mode	-6 dB	-60 dB	CW/RTTY/PKT	0.5 kHz or better	750 Hz or less	SSB	2.4 kHz or better	3.6 kHz or less	AM	6 kHz or better	15 kHz or less	FM	15 kHz or better	25 kHz or less	Mode	-6 dB	-60 dB	CW/RTTY/PKT	1.1 kHz or better	3.0 kHz or less	SSB	2.2 kHz or better	4.5 kHz or less	AM	6 kHz or better	25 kHz or less	FM	12 kHz or better	30 kHz or less
Mode	-6 dB	-60 dB																													
CW/RTTY/PKT	0.5 kHz or better	750 Hz or less																													
SSB	2.4 kHz or better	3.6 kHz or less																													
AM	6 kHz or better	15 kHz or less																													
FM	15 kHz or better	25 kHz or less																													
Mode	-6 dB	-60 dB																													
CW/RTTY/PKT	1.1 kHz or better	3.0 kHz or less																													
SSB	2.2 kHz or better	4.5 kHz or less																													
AM	6 kHz or better	25 kHz or less																													
FM	12 kHz or better	30 kHz or less																													
Image Rejection:	70 dB or better (160 - 10m Amateur bands) 60 dB or better (6m Amateur band)																														
Maximum Audio Output:	2.5 W into 4 Ohms with 10% THD																														
Audio Output Impedance:	4 to 8 Ohms (4 Ohms: nominal)																														
Conducted Radiation:	Less than 4000 μ W																														

Specifications are subject to change, in the interest of technical improvement, without notice or obligation, and are guaranteed only within the amateur bands.

INSTALLATION OF THE OPTIONAL FILTER (YF-122C OR YF-122CN)

1. Turn the front panel **[POWER]** switch “off,” then turn the rear panel’s **[POWER]** switch “off.”
2. Disconnect the all cables from the transceiver.
3. Referring to Figure 1, remove the three screws from each side of the transceiver, and three screws from the top edge of the rear panel. Slide the top cover toward the rear about 1/2 inch (1 cm), then remove the top cover.
4. Refer to Figure 2 for the mounting location for the optional filter. Position the filter so that its connectors are aligned with the mounting pins on the board, and push it into place.
5. Replace the top cover and its nine screws.
6. Filter installation is now complete. Now you must enable the newly-installed filter, using the Menu.
7. Connect the AC cable to the **~AC IN** jack.
8. Turns the rear panel’s **[POWER]** switch “on,” then turn the front panel **[POWER]** switch “on.”
9. Press the **[MENU]** button momentarily to engage the Menu mode.
10. Rotate the Main Tuning Dial knob to select the Menu item “O37 GEnE SUB FIL.”
11. Rotate the **[SUB VFO-B]** knob to choose the selection appropriate for the filter you have just installed (“300” for **YF-122CN**, “500” for **YF-122C**).
12. Press and hold in the **[MENU]** button for two seconds to save the new setting and exit to normal operation.

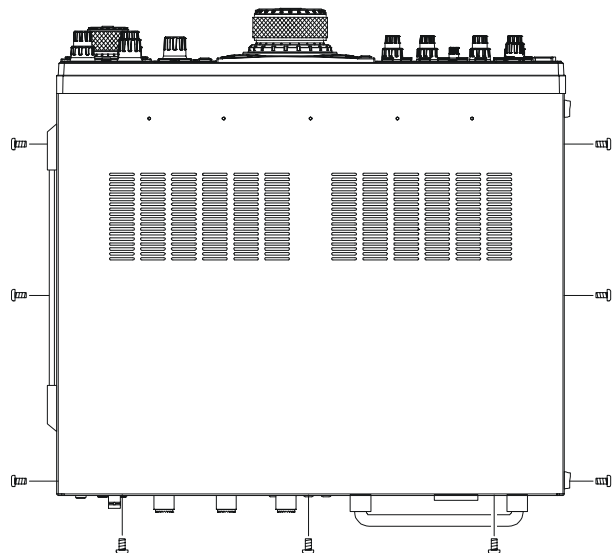

FIGURE 1

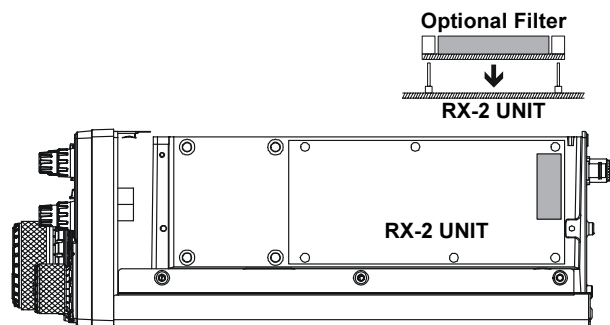

FIGURE 2

This equipment has been tested and found to comply with the limits for a Class B digital device, pursuant to Part 15 of the FCC Rules. These limits are designed to provide reasonable protection against harmful interference in a residential installation. This equipment generates, uses and can radiate radio frequency energy and, if not installed and used in accordance with the instructions, may cause harmful interference to radio communications. However, there is no guarantee that interference will not occur in a particular installation.

If this equipment does cause harmful interference to radio or television reception, which can be determined by turning the equipment off and on, the user is encouraged to try to correct the interference by one or more of the following measures:

- Reorient or relocate the receiving antenna.
- Increase the separation between the equipment and receiver.
- Connect the equipment into an outlet on a circuit different from that to which the receiver is connected.
- Consult the dealer or an experienced radio/TV technician for help.

1. Changes or modifications to this device not expressly approved by VERTEX STANDARD could void the user's authorization to operate this device.
2. This device complies with part 15 of the FCC Rules. Operation is subject to the following two conditions; (1) this device may not cause harmful interference, and (2) this device must accept any interference including interference that may cause undesired operation.
3. The scanning receiver in this equipment is incapable of tuning, or readily being altered, by the User to operate within the frequency bands allocated to the Domestic public Cellular Telecommunications Service in Part 22.

DECLARATION BY MANUFACTURER

The scanner receiver is not a digital scanner and is incapable of being converted or modified a digital scanner receiver by any user.

WARNING: MODIFICATION OF THIS DEVICE TO RECEIVE CELLULAR RADIOTELEPHONE SERVICE SIGNALS IS PROHIBITED UNDER FCC RULES AND FEDERAL LAW.



Copyright 2006
VERTEX STANDARD CO., LTD.
All rights reserved

No portion of this manual
may be reproduced without
the permission of
VERTEX STANDARD CO., LTD.

Printed in Japan

