

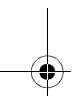

Contents

- Register your Vertu phone 3
- Vertu package contents 3
- Reference manual 3
- Networks 3
- Conventions used in this guide 3
- Glossary 4
- Safety points 4
- Vertu phone layout - front 5
- Vertu phone layout - back 5
- Inserting the battery and SIM card 6
- Using your Vertu phone 8
- Protecting your Vertu phone 10
- The main menu 11
- Personalising your Vertu phone 14
- Quick access to useful features 15

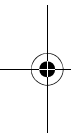

VERTU

- Camera 16
- Music player 17
- Media memory 17
- Stopwatch 17
- Fortress 18
- 3G UMTS 18
- WorldMate® 18
- Vertu Concierge 20
- Accessories 21
- CD-ROM 23
- Care and maintenance 24
- Safety information 25
- Specifications 27
- Warranty 27
- SAR Notice – RM-267V 31
- Declaration of conformity 32

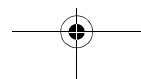
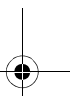
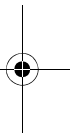

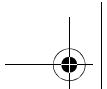

Notices 32

Export controls 32

FCC/Industry Canada notice 32

EU recycling notice 32

Vertu Concierge

Terms & Conditions 33

VERTU

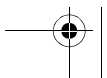
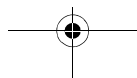
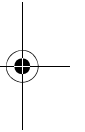
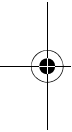

Register your Vertu phone

Vertu aims to provide you with the very best service possible.

To enable us to do this, please register your Vertu phone by visiting www.verturegistration.com or by calling Vertu Concierge using the dedicated key on the side of your phone.

Vertu package contents

- 1 Vertu Ascent Ti phone
- 1 Documentation pack
- 1 CD-ROM
- 1 Back cover release key
- 1 Battery
- 1 Wall charger
- 1 Data cable
- 1 Microfibre polishing cloth

The package contents may vary slightly in accordance with regional regulations.

Reference manual

Throughout this guide we mention the Reference Manual which contains additional information about your Vertu phone's functionality. There is an electronic copy on the CD-ROM supplied with your Vertu phone but if you do not have access to a compatible computer, please contact Vertu Concierge for a printed copy.

The Reference Manual is available in several languages, but we apologise if it is not be available in your language.

Networks

To use your Vertu phone you must subscribe to a service from a wireless service provider. Your service provider will be able to tell you about the services that are available and the charges that apply.

This quad-band wireless phone is approved for use on GSM 850/900/1800/1900 networks and 3G UMTS 2100 network.

Conventions used in this guide

Menu Represents text that appears on your Vertu phone's display, for example, "From the stand-by display, press **Menu**".

SEND Represents a Vertu phone key, for example, "Press the **SEND** key to make the call".



Important information relating to safety.



Represents useful information or a quick way to access or operate a feature.



Represents points to be aware of when using your Vertu phone.



Glossary

Joystick	Central navigation device
Number keys	The keys that are used to enter text or numbers.
Default	Initial product setting as supplied by Vertu when the phone leaves our workshop.
SIM card	Subscriber Identity Module. This is a small card supplied by your service provider to insert into your Vertu phone for a network connection.
Service provider	The provider of your SIM card and all associated network services.
Network service	A feature which is made available at the discretion of your service provider.
Stand-by display	The display that appears when your Vertu phone is switched on, with Menu displayed at the bottom.
PIN number	A Personal Identification Number that allows only authorised access to your Vertu phone and SIM card. We strongly recommend that you set these up when you receive your new Vertu phone and SIM card.

Safety points

 **Read these simple guidelines. Not following them may be dangerous or illegal. Read the complete user guide for further information.**

For full safety instructions refer to "Safety information" on page 25.

-  **SWITCH ON SAFELY**
Do not switch the phone on when wireless phone use is prohibited or when it may cause interference or danger.
-  **ROAD SAFETY COMES FIRST**
Obey all local laws. Always keep your hands free to operate the vehicle while driving. Your first consideration while driving should be road safety.

-  **INTERFERENCE**
All wireless phones may be susceptible to interference which could affect performance.
-  **SWITCH OFF IN HOSPITALS**
Follow any restrictions. Switch off near medical equipment.
-  **SWITCH OFF IN AIRCRAFT**
Follow any restrictions. Wireless devices can cause interference in aircraft.
-  **SWITCH OFF WHEN REFUELLING**
Do not use at a refuelling point. Do not use near fuel or chemicals.
-  **SWITCH OFF NEAR BLASTING**
Follow any restrictions. Do not use where blasting is in progress.
-  **USE SENSIBLY**
Use only in normal position. Do not touch the antenna unnecessarily.
-  **QUALIFIED SERVICE**
Only qualified personnel may repair this phone.
-  **ACCESSORIES AND BATTERIES**
Use only approved accessories and batteries. Do not connect incompatible products.
-  **WATER RESISTANCE**
Your Vertu phone is not water resistant. Keep it dry.
-  **BACK-UP COPIES**
Remember to make back-up copies or keep a written record of any important information stored in your phone.
-  **CONNECTING TO OTHER DEVICES**
When connecting to any other device, read its user guide for detailed safety instructions. Do not connect incompatible devices.
-  **EMERGENCY CALLS**
Ensure the phone is switched on and in service. Press the **END** key as many times as needed to clear the display and return to the stand-by display. Enter the emergency number, then press the **SEND** key. Give your location. Do not end the call until given permission to do so.

Vertu phone layout - front

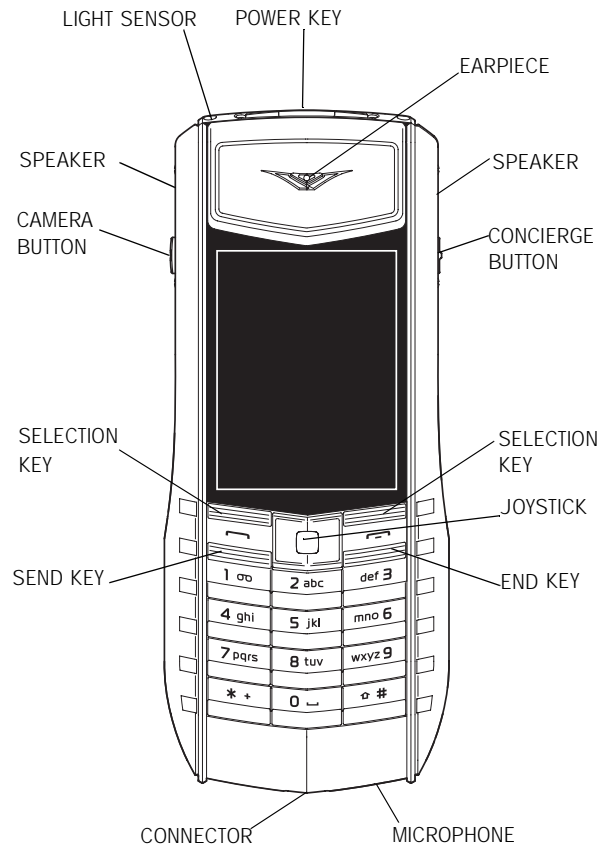

VERTU

Vertu phone layout - back

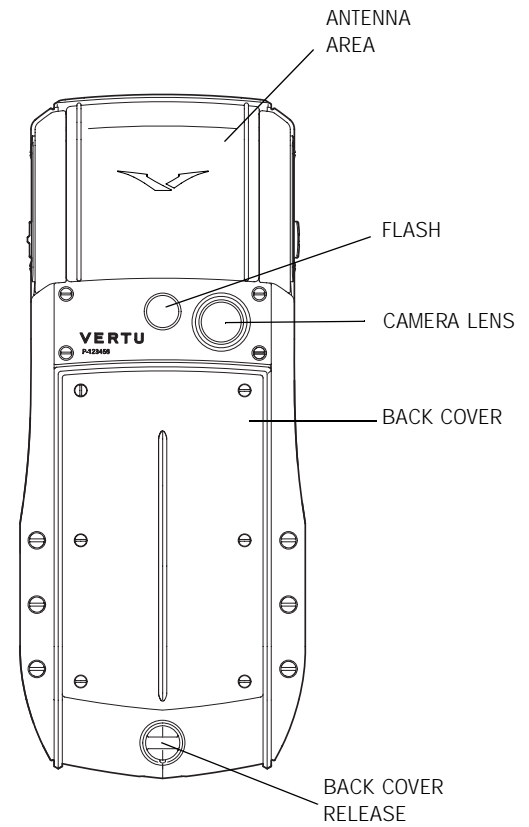

Inserting the battery and SIM card

The SIM card and its contacts are easily damaged.

Be careful when handling, inserting or removing the SIM card.



Keep SIM cards and the back cover release key out of the reach of small children.

Always switch the phone off and disconnect the charger before removing the battery.

Removing the back cover

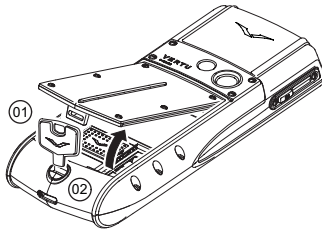

With the back of your Vertu phone facing you, position the back cover release key (01) into the slot of the locking screw (02).

Turn the locking screw (02) a quarter of a turn anticlockwise, and gently lift off the back cover as shown.

Inserting the SIM card

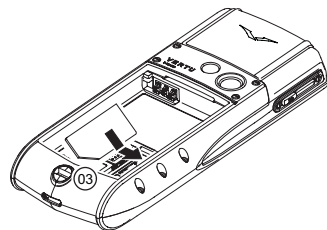

Insert the SIM card into the SIM card compartment, ensuring that the bevelled corner (03) is located bottom right and the gold contact area is facing downwards.

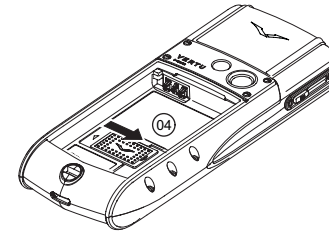

Slide the locking mechanism (04) over the SIM card to hold it in place.

Inserting the battery

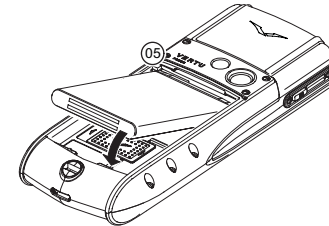

Position the battery so that the contacts align with the contacts in the battery compartment (05).

Ensure that the battery and SIM card are seated correctly before replacing the back cover.

Replacing the back cover

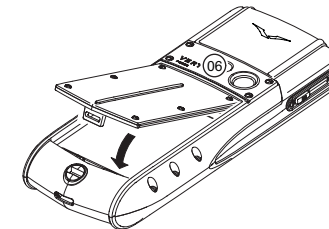

To replace the back cover, locate the internal clip (06) first.

Lower the back cover into position until it clicks into place. The cover should close tightly using only light pressure.

Display icons and indicators

The display shows the current status of your Vertu phone.



The GSM signal strength indicator appears at the top left of the display. If you are using a 3G UMTS connection you will see the 3G UMTS signal strength indicator.



This picture shows a strong signal.



This picture shows that the signal strength is weak. To obtain a stronger signal move to an area clear of obstructions that may block the signal.



The battery charge indicator appears at the top right of the display.



This picture shows a fully charged battery.



This picture shows that the battery charge level is low and you need to recharge your Vertu phone soon.

Status icons are displayed below the battery charge and signal strength indicators. The most commonly displayed icons are:



You have received one or more text messages.



You have missed a call.



You have a voice message waiting (may not be shown on all networks).



The **Flight** profile is selected. Alternative icons are displayed for other profiles.



Audible alerts are disabled. There is no ringing tone when you receive a call.



The keypad is locked.



An alarm is set.



Bluetooth is switched on.



A 3G UMTS connection is active.



A GPRS connection is active.

For more icons and their meanings please see the Reference Manual.

Using your Vertu phone

To help you start using your Vertu phone as quickly as possible, please read the following information carefully.

Switching your Vertu phone on and off

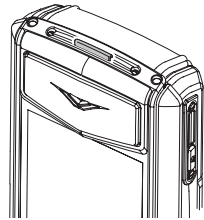

Press and hold the **POWER** key to switch your Vertu phone on or off.

The battery may not be fully charged when you first receive your Vertu phone. If a **Battery low** message is displayed when you first switch on your Vertu phone please see "Charging the battery" on page 21 for more information.

The joystick

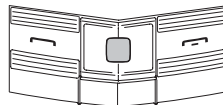

The **JOYSTICK** enables you to move the cursor around the display in any direction.

Selection keys

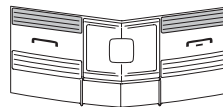

The **SELECTION** keys enable you to select the options displayed at the bottom of the display, directly above the keys.

Virtual keys

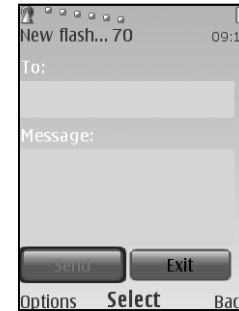

Virtual keys appear on some screens, for example messaging screens. Use the **JOYSTICK** to move between the virtual keys and to select the highlighted key.

Setting the time and date

When you first switch on your Vertu phone you will be prompted to enter your time and date settings if they are not already set up.

Enter the time using the **JOYSTICK** and **NUMBER** keys. Press **OK** to confirm the time. Enter the date using the using the **JOYSTICK** and **NUMBER** keys. Press **OK** to confirm the date.

 *If the battery is removed from your Vertu phone for longer than an hour, you may need to reset the time and date.*

Making a call



Check that you are in a strong signal area and the battery is charged.

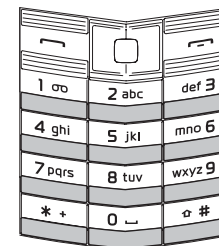

Use the **NUMBER** keys to enter the telephone number you want to call.

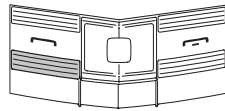

Press the SEND key to begin your call.



*When calling international numbers, press the * + key twice to display a + sign.*

Answering a call

When you receive an incoming call, a ringing tone is played and a call message is displayed. Your Vertu phone will also vibrate if you have set a vibrating alert.

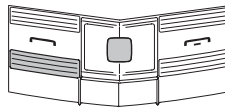

Press the SEND key to answer an incoming call or press the JOYSTICK when you see **Answer** on the screen.

Adjusting listening volume

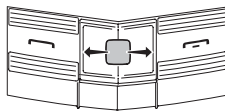

To change the earpiece volume while you are in a call, move the JOYSTICK left or right.



*While in a call, you can use the speaker phone for a hands-free call. Use the SELECTION keys to press **Loudsp.** to switch to speaker phone.*

Ending or rejecting calls

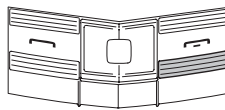

Press the END key to end a call or reject an incoming call.

Sending a text message

- > Using the JOYSTICK go to:
Menu » Messages » Create message » Message
- > Enter the recipient's number.
- > Scroll to the message field.
- > Enter the message.
- > Scroll down and press the SEND virtual key.



While composing a message:

*Short press on the * key shows symbols*

Long press on the # key changes language

Short press on the # key toggles between upper/lower case.

Making an emergency call



Your Vertu phone, like any wireless phone, operates using radio signals, wireless and landline networks as well as user-programmed functions. Because of this, connections in all conditions cannot be guaranteed. Therefore, you should never rely solely upon any wireless phone for essential communications, for example medical emergencies.

- > If the phone is not on, switch it on. Some networks require that a valid SIM card is properly inserted in the phone.
- > Press the END key as many times as necessary to return to the stand-by display.
- > Enter the emergency number, for example 000, 08, 110, 112, 118, 119, 911, *911, 999, *999 or other official emergency number.
- > Press the SEND key.



Emergency numbers vary by location and those listed above may not be supported by your current network.

If certain features are in use, you may first need to turn those features off before you can make an emergency call. For more information consult the Reference Manual or your local service provider.

When making an emergency call, remember to give all the necessary information as accurately as possible.

Remember that your phone may be the only means of communication at the scene of an accident – do not end the call until given permission to do so.

Protecting your Vertu phone

 Enter *#06# from the stand-by display to find the IMEI serial number. Make a note of your IMEI serial number and keep it in a safe place.

Locking the keypad

You can lock the keypad on your Vertu phone to prevent accidentally dialling any numbers.

From the stand-by display, press **Menu** followed by the * + SPECIAL FUNCTION key (at the bottom left of the keypad) within two seconds. A confirmation message is displayed.

When the keypad is locked, a key icon appears below the signal strength indicator.

 You can still make calls to the emergency numbers when the keypad is locked.

When you receive an incoming call the keypad lock is automatically suspended. When the call is ended, the keypad returns to the locked state.

Unlocking the keypad

Press **Unlock** followed by the * + SPECIAL FUNCTION key within two seconds. A confirmation message is displayed.

Setting a PIN code

We recommend that you use a PIN code to prevent unauthorised use of your Vertu phone and SIM card.

- > Using the JOYSTICK go to:
Menu » Settings » Security » PIN code request
- > Select **On**

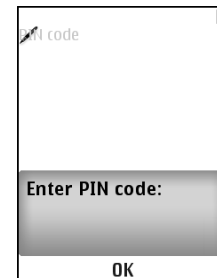

If you have set a PIN code, the next time you switch on your Vertu phone you will see this screen asking you to enter your PIN code.

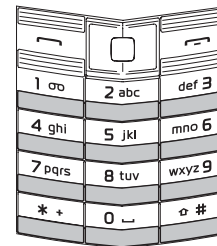

Use the **NUMBER** keys to enter your PIN code.

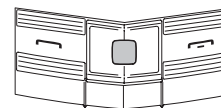

Press **OK**

The main menu

The main menu displays all the top level menu categories, from which you can access all the functions of your Vertu phone. Please see the Reference Manual for more information on these functions.

 *The JOYSTICK is programmed with some popular menu options. When your Vertu phone leaves our workshop the options are:*

Up - Calculator

Down - Worldmate®

Left - Create message

Right - Calendar

To change these to your favourite menu options go to Menu » Settings » My shortcuts

Opening the menu

From the stand-by display, press the JOYSTICK to open the **Menu** and display the main categories.

Use the JOYSTICK to highlight the desired menu.

Press the JOYSTICK to open the menu and view the options.

Navigating through the menus

When navigating through the menus, press **Back** or **Exit** to return to the previous menu without saving changes.

Press the END key to return to the stand-by display from any menu without saving changes.

You can also use voice commands to activate menu functions on your Vertu phone. Please see "Voice dialling" on page 16 for more information.

Changing how the menu is displayed

- > Using the JOYSTICK go to:
Menu » Options » Main menu view
- > Select one of the following options:
 - > **List** to display the main menu icons one at a time.
 - > **Grid** to display all the main menu icons on one screen. You can move the icons around the grid to have the options you use the most in your favourite positions.
 - > **Tab** to display the main menu icons along the top of the screen and the menu options below.

Messages



- > Create message
- > Inbox
- > E-mail mailbox
- > Drafts
- > Outbox
- > Sent items
- > Saved items
- > Delivery reports
- > WV chat
- > Voice messages
- > Info messages
- > Serv. commands
- > Delete messages
- > Message settings

The **Messages** menu enables you to write, send, receive and read messages.

Your Vertu phone supports:

- > text messages
- > multimedia messages
- > flash messages
- > voice messages
- > e-mail messages
- > instant messages.

Contacts



- > Names
- > Sync all
- > Settings
- > Groups
- > Speed dials
- > Info numbers
- > Service numbers
- > My numbers
- > Del. all contacts
- > Move contacts
- > Copy contacts

The **Contacts** menu enables you to add and delete contact numbers, select whether to store them on the phone or SIM memory, and set up speed dialling.

Info numbers, **Service numbers** and **My numbers** are only displayed if the services are supported by your service provider.

Call history



- > Call log
- > Missed calls
- > Received calls
- > Dialed numbers
- > Msg. recipients
- > Clear log lists
- > Call duration
- > Data counter
- > Data timer
- > Message log
- > Data transfer

The **Call history** menu enables you to view information about voice and data calls that you have made, received and missed.

You can also view information about messages received and sent, and the amount of data received and sent while web browsing.



Settings



- > Profiles
- > Themes
- > Tones
- > Display
- > Date and time
- > My shortcuts
- > Connectivity
- > Call
- > Phone
- > Enhancements
- > Configuration
- > Security
- > Factory reset

The **Settings** menu enables you to change the way your Vertu phone is configured.

This covers a wide range of features from changing the stand-by display background to setting up access points for network connectivity.

We recommend that you protect your Vertu phone and SIM card from unauthorised use by protecting them with passwords using the **Security** option.

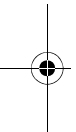

Gallery



- > Media
- > Themes
- > Graphics
- > Tones

The **Gallery** menu contains all your music and picture files, both preloaded and downloaded.

To play any file, select it and press **Open** on the JOYSTICK.

VERTU

Additions



- > Camera
- > Video
- > Music player
- > Voice recorder
- > Equaliser
- > Stereo widening
- > Applications
- > Web

The **Additions** menu contains the camera, video, music player, games and the web browser.

Organiser



- > Calendar
- > To-do list
- > Notes
- > Calculator

The **Organiser** menu enables you to view your calendar, set reminders for forthcoming events or dates, add notes, and create a to-do list. The organiser also contains a calculator.

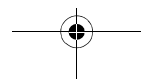

Time



- > Alarm clock
- > Timer
- > Stopwatch
- > Date and time

The **Time** menu contains an alarm clock, a countdown timer and a stopwatch.

You can also set the date and time on this menu.

Fortress



- > Server sync

Fortress enables you to wirelessly save the important personal information on your Vertu phone to a secure storage facility.

SIM services



The **SIM services** menu enables you to view confirmation messages sent between your Vertu phone and the network. You can access this menu only if it is supported by your SIM card.

For availability and information on using SIM card services, contact your service provider.

Accessing this service may involve sending messages or making a phone call for which you may be charged.

Personalising your Vertu phone

Go to shortcuts

You can use the **Go to** shortcuts to bypass the main menu and give you quick access to the menu options that you use most often.



*For example, you can disable 3G UMTS from the **Go to** menu to maximise battery performance. To do this, press the **Go to SELECTION key » Network mode » GSM***

Using shortcuts

- > From the stand-by display, press the **Go to SELECTION key**.
- > Use the **JOYSTICK** to select the desired shortcut.

Creating shortcuts

To customise the options available on the **Go to** list, display the list as above and select **Options » Select options**. Pick the options that you want to display on the **Go to** list.

You can also set up the **JOYSTICK** to access shortcuts. For more information please see the Reference Manual.

Backgrounds

Your Vertu phone comes with a number of images to use as display backgrounds.

Changing the background

- > Select **Menu » Settings » Themes » Select theme**.
- > Open the themes gallery and select a background from those available.
- > Select **Apply** to change the background.

Profiles

Your Vertu phone has several different profiles that enable you to change the ringing tone, ringing volume and vibrating alert all at once. Profiles can be timed, for example you can set the **Silent** profile while you attend a meeting and, if you have set it, the **General** profile will resume after the meeting.

Flight mode

Flight mode allows you to deactivate all radio frequency functions but still have access to offline games, the calendar and phone numbers.

- > Select **Menu** » **Settings** » **Profiles** » **Flight**

Use flight mode in radio sensitive environments for example on board aircraft or in hospitals.

 *To make an emergency call in flight mode, make the call as normal and answer **Yes** when asked **Exit flight profile?***

To deactivate flight mode, select any other profile.

 *To change profiles quickly, briefly press the **POWER** key. Long press on the **#** key toggles between **Silent** and **General** profiles.*

Ringing tones

Your Vertu phone comes with various special ringing tones. You can also download ringing tones in AAC, MP3 and MIDI formats.

Changing the ringing tone

- > Select **Menu** » **Settings** » **Profiles** » <Your profile> » **Personalise**
- > Scroll slowly through the ringing tones list. When you hear a ringing tone that you would like to use, press **Select**.

Quick access to useful features

Setting an alarm

Your Vertu phone has a useful alarm clock function.

- > Select **Menu** » **Time** » **Alarm clock**.

When you turn the alarm on, you can set the time, alarm tone, snooze and repeat functions.

When there is an alarm set, you will see the alarm clock icon on the stand-by display.

 *If the phone is switched off, it will switch itself on at the alarm time. Please remember this if you are in a restricted area.*

Bluetooth

Bluetooth technology enables you to easily share images and video clips, and take advantage of wireless connectivity by using a compatible Bluetooth headset. You first need to pair with the other device which should be within 10m of your Vertu phone.

The Bluetooth menu is located in **Menu** » **Settings** » **Connectivity**.

Using the options on these menus you can turn Bluetooth on, make your phone discoverable, search for active devices and pair your phone with other Bluetooth devices, for example your Bluetooth headset.

 *Switch off Bluetooth if it's not being used, to maximise battery performance. If Bluetooth is On, but your Vertu phone is not paired, Bluetooth may switch itself off after a few minutes.*

Adding a contact

To quickly add a new contact, enter the number on the stand-by display and then press the **JOYSTICK**. Enter the contact name and **Save** the contact.

Voice dialling

Your Vertu phone can access menu options and dial contacts using voice commands.

- › Press and hold the right SELECTION key on the stand-by display.
- › Say clearly the name of the contact or menu option you want to access.
- › Select the option you require from the displayed list. If you don't make a selection within 5 seconds, the option at the top of the list will be automatically selected.

Browsing the Web

 Only download and use files from sources that offer adequate security and protection against harmful software.

You can access mobile Internet services with the Web browser on your Vertu phone. You can view pages that use wireless markup language (WML) or extensible hypertext markup language (XHTML).

Depending on which service provider you use, your Vertu phone might already have Internet settings installed so you might be able to browse the Internet straight away. If you cannot connect to the Internet, please contact Vertu Concierge or visit www.vertu.com and download your settings.

To open the Web browser select **Menu » Additions » Web**.

 Long press on the 0 key opens your default web page.

Quick tips

 Enter ***#100#** and press the SEND key to display your phone number (may not be relevant for all service providers).

Enter ***#0000#** from the stand-by display to show the software version.

Long press on the 1 key calls your voice mail box.

VERTU

Camera

Your Vertu phone incorporates a 3 Megapixel camera with autofocus and integral LED flash. There is a powerful 8x digital zoom which together with the 16 million colour QVGA screen produces crisp, high quality images.

Your Vertu phone supports an image capture resolution of 2048 x 1536 pixels. Pictures are saved in jpg format and video clips are saved in 3gp format. Available recording time depends on the video clip length and quality settings.

You can take photos and record video clips with the camera and send them by message to your friends, or save them in the memory, from where they can be transferred to your computer.

For more information on the camera functions please see the Reference Manual.

Taking photos

1. To start the camera, give a short press on the CAMERA button on the side of your Vertu phone or use the JOYSTICK to go to **Menu » Additions » Camera**.
2. To zoom in and out move the JOYSTICK up or down.
3. To autofocus, press and hold the CAMERA button and a white frame appears on the display. When the white frame turns green the object is in focus.
4. To take the photo release the CAMERA button or use the JOYSTICK to select **Capture**.

Taking videos

1. To start the camera give a short press on the CAMERA button on the side of your Vertu phone or use the JOYSTICK to go to: **Menu » Additions » Video**.
2. To zoom in and out move the JOYSTICK up or down.
3. To record a video use the JOYSTICK to select **Record** or press and hold the CAMERA button. To pause the recording, select **Pause**; to resume the recording, select **Continue**. To stop the recording, select **Stop**.

Music player

Your Vertu phone includes a music player for listening to music tracks, recordings or other MP3, MP4, AAC, eAAC+ or Windows Media Player sound files that you have transferred to your Vertu phone using the File Manager in Vertu PC Suite.

To open the music player scroll to **Menu » Additions » Music player**.

Music files that you transfer to your Vertu phone are automatically added to the list of songs in the music player.



Long press on the END key stops the music player.

Media memory

Your Vertu phone has 4GB internal memory (which we refer to as media memory). You can store thousands of high quality images.

We recommend that you store photos, videos and music files on the media memory. To do this you need to press the left SELECTION key when the camera is switched on and then scroll to **Settings » Image/ video storage » Other folder » Media**.

When the media memory is full a message is displayed. Delete some files from the media memory before continuing.

VERTU

Stopwatch



The Vertu stopwatch function enables you to measure time, take intermediate times or take lap times in 1/10 of a second intervals.

Starting the stopwatch

Using the JOYSTICK go to **Menu » Time » Stopwatch**. To start the stopwatch, press the START-STOP button (CAMERA button or NUMBER 4 key) on the left side of your Vertu phone. To stop the stopwatch press the START-STOP button again.

Resetting the stopwatch

When you have finished timing, press the RESET button (CONCIERGE button or NUMBER 6 key) to return the second hand to the starting position.

Select **Options** to view the Stopwatch menu and select Split timing or Lap timing.

Split timing

Split timing enables you to take intermediate times while you are timing. Press the SPLIT button (CONCIERGE button or NUMBER 6 key) every time you want to take an intermediate time. The second hand continues moving and the split times are displayed at the top of the screen. To stop the stopwatch press the START-STOP button (CAMERA button or NUMBER 4 key) again. You can save, view and delete the split times.

Lap timing

Lap timing enables you to measure lap times. Press the START-STOP button (CAMERA button or NUMBER 4 key) to start the stopwatch. To finish timing press the START-STOP button again. You can save, view and delete the lap times.

Fortress

Fortress is a Vertu product that enables you to wirelessly transmit important information from your Vertu phone to a high security data storage facility. Your service provider will charge you for the amount of data transferred by GPRS or 3G UMTS, so please check their tariff first. You can back up all contact information, calendar notes and tasks in this way.

When you register your Vertu phone at www.verturegistration.com, you can complete the Fortress registration details and we will send you the necessary settings.

When you have synchronised your data with the secure server, you can update it from our website and, if necessary, transfer it to another phone you have registered.

3G UMTS

Your Vertu phone is not automatically enabled for 3G UMTS. If you want to use 3G UMTS for faster downloads or when roaming in Japan, you need to enable 3G UMTS from the **Go to** menu. To do this, press the **Go to SELECTION key » Network mode » UMTS**

VERTU

WorldMate®

The travel application WorldMate® provides access to the following information:

- > *Clocks for multiple cities worldwide, including time zone management and international daylight saving time.*
- > *Global weather conditions, forecasts and updates for over 250 cities worldwide.*
- > *World map with day and night display and interactive city locators.*
- > *Currency conversion with online access to exchange rates for more than 160 currencies worldwide.*
- > *Real-time flight information including delays, gate and terminal information for over 75 of the world's leading airlines.*

In order to download the latest flight, currency and weather information, you must be subscribed to the Travel application service. You must also have valid Internet settings on your Vertu phone and there must be GPRS network coverage in your current location.

Depending on which service provider you use, your Vertu phone might already have Internet settings installed. If you cannot connect to the Internet, please contact Vertu Concierge or visit www.vertu.com and download your settings.

If you travel to a region covered by a different network operator, and you are unable to download the latest flight, currency and weather information, you need to select a network operator that has a GPRS roaming agreement with your home network.

To do this select **Menu » Settings » Phone » Operator selection » Manual**.

Your Vertu phone will display all the locally available networks. Select one and reopen the Travel application.



For information on configuring the Travel application, GPRS coverage and roaming agreements, please contact Vertu Concierge.



Not all network operators have GPRS roaming agreements with other network operators.

Navigating the screens

Use the JOYSTICK to move between screens and also move between fields on a screen.

Updating flight, weather and currency information

Press the **Options** SELECTION key to display a menu.

Select the **Update ...** option to open a GPRS connection and download latest information to your Vertu phone.

Changing settings

Press the **Options** SELECTION key to update settings, change city, and change settings.

Settings include time format, date format, temperature scale and the space character (decimal point).

Clocks

This screen displays the time at three different locations. You can set one clock to display the time in your home city, and the other clocks to display the time in any other two cities. Press the **Options** SELECTION key to select a new city.

Weather

This screen displays five-day weather forecasts. If the weather information is no longer current and you want to update it, press the **Options** SELECTION key and select **Update weather**.

World map

This screen displays a map of the world, showing which regions are in day and night. You can select a city from the list and view its location and current time. Press the **Options** SELECTION key to select a new city.

Currency

This screen displays three different currencies and enables you to convert sums of money between them. Press the **Options** SELECTION key to select a new currency.

Currency rates fluctuate daily. To obtain current currency rates, press the **Options** SELECTION key and select **Update rates**.

Flight status

This screen enables you to search for the latest flight information for over 75 leading airlines. You can see current information on schedules, gates, terminals, delays and aircraft type.

Select an **Airline**, **Flight number** and **Date**, and then press **Get flight status**.

Queries you have previously made are stored for reuse in the **Recent Queries** list.

WorldMate® is provided by MobiMate®.

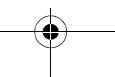
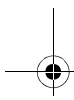
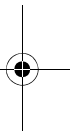
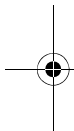

Vertu Concierge

Vertu Concierge is an exclusive service for people who believe that quality matters. Our aim is to bring you only the very best, whether it be music, art, travel or food.

Vertu Concierge provides you with a highly personalised range of services including:

- > *Lifestyle services such as restaurant recommendations and reservations, travel assistance, and tickets for theatre shows, concerts or sporting events.*
- > *Solving everyday practical problems such as finding a reputable plumber or tracking down a gift.*
- > *Assistance with using your Vertu phone.*

When you connect to Vertu Concierge, you can speak directly to a team of Lifestyle Managers who are available 24 hours a day, 7 days a week to offer personalised assistance.

Calling Vertu Concierge

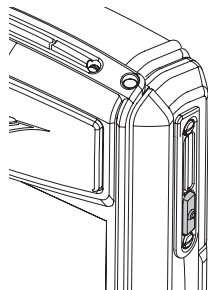

The CONCIERGE key is located on the right side of your Vertu phone as shown in this illustration.



Press the CONCIERGE key to display the Concierge screen.

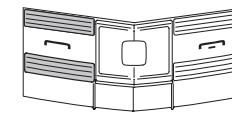

Press **Call** or the **SEND** key to call Vertu Concierge.

If you are unable to reach Vertu Concierge using the CONCIERGE key, call +448707375535.

Accessories

The following accessories are provided with your Vertu phone:

- > *Wall charger*
- > *Battery*
- > *Data cable.*

For more information about accessories approved for use with your Vertu phone, please contact Vertu Concierge or refer to www.vertu.com.



Keep all parts out of reach of small children.

Use only batteries, chargers and accessories approved by Vertu for use with this particular phone model. The use of any other types may invalidate any approval or warranty applying to the phone and may be dangerous.

To optimise the performance and lifetime of your accessories, and protect your warranty coverage, observe the following handling and usage precautions:

- > *Keep dry. Precipitation, humidity and all types of liquids or moisture can contain minerals that will corrode electronic circuits.*
- > *Do not use or store in dirty or dusty areas.*
- > *Do not attempt to open.*
- > *Do not drop, knock or shake. Rough handling can break fine mechanics.*
- > *Do not store in hot areas. High temperatures can shorten the life of electronic devices and damage batteries.*
- > *Do not store in cold areas.*
- > *Do not use harsh chemicals, cleaning solvents or strong detergents to clean.*
- > *Do not paint.*

Wall charger

The wall charger supplied with your Vertu phone should be appropriate for your region. However, you should always check that the electrical rating of the AC outlet is appropriate for the charger before you attempt to plug it in.



Never attempt to use a damaged charger. Contact Vertu Concierge to obtain a replacement.

Charging the battery

The battery for your Vertu phone is rechargeable and requires charging at regular intervals.



Only use the approved charger and battery designed specifically for your Vertu phone.

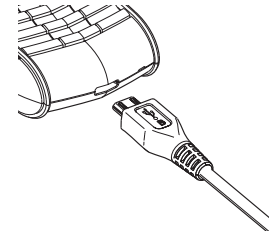

Insert the charger connector into the bottom of your Vertu phone as shown. Please ensure that the connector is inserted correctly, with the connector symbol uppermost.

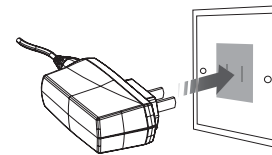

Connect the charger body to a powered AC outlet.

After a few seconds, the battery indicator animates and a confirmation message is displayed if your Vertu phone is switched on.



If the battery is fully discharged you may need to recondition it by charging it. Although the charging indicator appears on the display after a few seconds, it may take from several minutes to an hour before you can make a call.

The charging time will vary with different power sources and we recommend the Vertu wall charger should always be used.

Always charge the battery until it is fully charged. When the battery is fully charged, the battery charge indicator stops animating and, if your Vertu phone is switched on, a **Battery full** confirmation message is briefly displayed.

If your Vertu phone is not charging, try the following:

- › Disconnect the charger from the AC outlet.
- › Check that the electrical rating of the AC outlet is compatible with your charger.
- › Verify that the AC outlet has power and that it is switched on. For example, in many hotel rooms, AC outlets are used for lighting and may be switched on and off from remote locations in the room.
- › Wait for at least 10 seconds and then reconnect the charger to the AC outlet.
- › Use another nearby AC outlet that you know is providing power.
- › If charging still fails, contact Vertu Concierge for further advice.

Battery



Never dispose of batteries in a fire.

Always dispose of batteries according to local regulations. Please recycle when possible. Do not dispose of batteries as household waste.

The full performance of a new battery is achieved only after two or three complete charge and discharge cycles. The battery can be charged and discharged hundreds of times but it will eventually wear out. If you notice that the talk and stand-by times are much shorter than normal, you may need a new battery. Contact Vertu Concierge to obtain a Vertu approved battery.

VERTU

Maximising battery performance

Certain functions in your Vertu phone can be switched off if not in use, to help maximise your battery performance. Examples of these are Bluetooth, 3G UMTS and the Stopwatch.

Charging and discharging

Unplug the charger from the AC outlet and your Vertu phone when not in use. Do not leave your Vertu phone connected to a charger. The battery does not have to be completely discharged before you can recharge it. Continuously charging the battery may shorten its lifetime. If left unused, a fully charged battery will lose its charge over time. Temperature extremes can affect the ability of your battery to charge.

Battery care and safety

Use the battery only for its intended purpose. Never use any charger or battery that is damaged.

Do not short-circuit the battery. Accidental short-circuiting can occur when a metallic object such as a coin, clip, or pen causes direct connection of the positive (+) and negative (-) terminals of the battery (the metal strips on the battery). This might happen, for example, when you carry a spare battery in your pocket, purse or bag. Short-circuiting the terminals may damage the battery and the connecting object.

Leaving the battery in hot or cold places, such as in a closed car in summer or winter conditions, will reduce the capacity and lifetime of the battery. Always try to keep the battery between 15°C and 25°C (59°F and 77°F). If your battery is very hot or extremely cold, your Vertu phone may not work temporarily, even if the battery is fully charged. Battery performance is particularly limited in temperatures well below freezing.

Data cable

The micro-USB data cable transfers data between your Vertu phone and a compatible computer, for example when you are using Vertu PC Suite, and between your Vertu phone and a compatible printer supporting PictBridge.

 **When using the data cable, battery charging time will vary depending on your computer configuration.**

Attaching the data cable to the phone connector

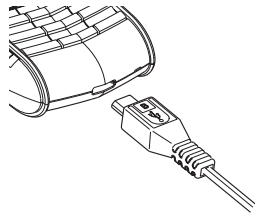

Carefully insert the micro-USB end of the data cable into the phone connector. Make sure the side showing the design is facing up.

Attaching the data cable to the computer

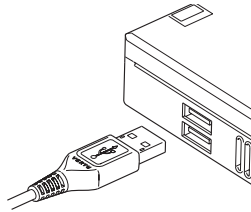

Insert the USB end of the data cable into the computer's USB connector.

CD-ROM

The CD-ROM provided with your Vertu phone contains the following items:

- > *Vertu PC Suite (for PC only)*
- > *iSync plug-in (for Macintosh only)*
- > *An electronic version of the Reference Manual*
- > *Link to set up your Vertu phone for MMS, browsing and e-mail*
- > *A link to register your Vertu phone.*

Minimum specifications

The Vertu CD-ROM works on a compatible computer with a CD-ROM drive, with Microsoft® Windows® 2000, Microsoft® Windows® XP or Microsoft® Vista® installed. You need at least 250 MB of free disk space and administrator rights to the PC.

The Vertu CD-ROM works on a Macintosh computer with Mac OS X 10.4.6 (or later) and iSync 2.3 (or later). You need administrator rights to the Macintosh.

Connecting to a computer

To connect your Vertu phone to a computer you need either a Vertu USB data cable or Bluetooth wireless technology equipment and software.

Vertu PC Suite

Vertu PC Suite includes the following applications to extend the functionality of your Vertu phone:

- > *Backup*
- > *Synchronise*
- > *Connect to the Internet*
- > *Install applications*
- > *File manager*
- > *Contacts*
- > *Messages*
- > *Image store*
- > *Multimedia player*

Installing Vertu PC Suite

- > Insert your Vertu CD-ROM into the PC's CD-ROM drive.
- > Click on the **INSTALL NOW** button.
- > Follow the on-screen instructions to complete the installation.

Installing the iSync plug-in

- > Insert your Vertu CD-ROM into the Macintosh's CD-ROM drive.
- > On the desktop, double-click the VERTU icon.
- > When the finder window opens, double-click the Vertu.osx icon.
- > Click on the **INSTALL NOW** button.
- > Follow the on-screen instructions to complete the installation.

Viewing the electronic Reference Manual

- > Start the CD-ROM as described above.
- > Click on the **LAUNCH PDF** button.

VERTU

Setting up MMS, browsing and e-mail

- > Start the CD-ROM as described above.
- > Click on the **ORDER SETTINGS** button.
- > Your computer must be connected to the Internet to set up MMS, browsing and e-mail.

Registering your Vertu phone

- > Start the CD-ROM as described above.
- > Click on the **REGISTER PHONE** button.
- > Your computer must be connected to the Internet to register your Vertu phone.

Care and maintenance

Your Vertu products have been crafted from some of the finest materials and care should be taken to keep them in good condition.

 **Damage caused to your Vertu phone by failing to observe these care instructions is not covered by the warranty.**

Ceramics and sapphire

Ceramics and sapphire are very hard materials but are also brittle and can be scratched by harder materials or objects. They can also be damaged if dropped.

Avoid the following:

- > *Contact with other hard materials such as diamond jewellery, nail files, abrasives, and mineral crystals.*
- > *Dropping or knocking the product on hard surfaces.*
- > *Repeated rubbing against hard surfaces.*

Leather

All Vertu leather products are made by expert craftsmen. Each leather hide is unique and has natural markings which should be considered part of the individuality of fine leather. All leather can be damaged and should be treated with care.

Avoid the following:

- > *Exposure to water and high humidity.*
- > *Dropping, rubbing or knocking on hard surfaces.*
- > *Exposure to extreme temperatures.*
- > *Contact with oily substances, make-up and solvents.*

Metal

Vertu metals are finished to a high standard and care needs to be taken to maintain their appearance.

Avoid the following:

- > *Contact with chemicals such as solvents, alkaline and acid solutions, cola-based drinks and exposure to salt water. Wipe with a clean, soft cloth as soon as possible if contact occurs.*
- > *Contact with sharp objects.*
- > *Dropping or knocking against hard surfaces.*
- > *Metal polishes.*

Safety information

Traffic safety

Do not use a hand-held telephone while driving a vehicle. If using a hand-held phone, park the vehicle before using the phone in any way. Do not place the phone on the passenger seat or where it can break loose in a collision or sudden stop.

Operating environment

Remember to follow any special regulations in force in any area and always switch off your phone whenever it is forbidden to use it, or when it may cause interference or danger.

As with other mobile radio transmitting equipment, users are advised that for the satisfactory operation of the equipment and for the safety of personnel, it is recommended that the equipment should only be used in the normal operating position. When the phone is on and being worn on the body, always use an approved carrying case.

Use only the supplied or approved parts. Unauthorised antennas, modifications or attachments could damage the phone and may violate regulations governing radio devices.

Electronic devices

Most modern electronic equipment is shielded from radio frequency (RF) signals. However, certain electronic equipment may not be shielded against the RF signals from your wireless phone.

Pacemakers

Pacemaker manufacturers recommend that a minimum separation of 15 cm (6 inches) be maintained between a hand-held wireless phone and a pacemaker to avoid potential interference with the pacemaker. These recommendations are consistent with the independent research by and recommendations of Wireless Technology Research.

Persons with pacemakers:

- > *Should always keep the phone more than 15 cm (6 inches) from their pacemaker when the phone is switched on;*
- > *Should not carry the phone in a breast pocket;*
- > *Should use the ear opposite the pacemaker to minimize the potential for interference.*

If you have any reason to suspect that interference is taking place, switch off your phone immediately.

Hearing aids

Some wireless phones may interfere with some hearing aids. In the event of such interference, consult your service provider.

Other medical devices

Operation of any radio transmitting equipment, including wireless phones, may interfere with the functionality of inadequately protected medical devices.

Switch off your phone in health care facilities when any regulations posted in these areas instruct you to do so.

Vehicles

RF signals may affect improperly installed or inadequately shielded electronic systems in motor vehicles (e.g. electronic fuel injection systems, electronic anti-skid (anti-lock) braking systems, electronic speed control systems, air bag systems).

Check with the manufacturer or its representative regarding your vehicle. You should also consult the manufacturer of any equipment that has been added to your vehicle.

Do not store or carry flammable liquids, gases or explosive materials in the same compartment as the phone, its parts or accessories.

For vehicles equipped with an air bag, remember that an air bag inflates with great force. Do not place objects, including both installed or portable wireless equipment in the area over the air bag or in the air bag deployment area.

Aircraft

Switch off your phone before boarding an aircraft. The use of wireless telephones in an aircraft may be dangerous to the operation of the aircraft, disrupt the wireless telephone network and may be illegal. In the United States, FCC regulations currently prohibit using your Vertu phone while in the air.

Failure to observe these instructions may lead to suspension or denial of telephone services to the offender, or legal action or both.

VERTU

Potentially explosive atmospheres

Switch off your phone when in any area with a potentially explosive atmosphere and obey all signs and instructions. Sparks in such areas could cause an explosion or fire resulting in bodily injury or even death.

You are advised to switch off the phone when at a refuelling point or service station. Observe restrictions on the use of radio equipment in fuel depots (fuel storage and distribution areas), chemical plants or where blasting operations are in progress.

Areas with a potentially explosive atmosphere are often but not always clearly marked. They include below deck on boats; chemical transfer or storage facilities; vehicles using liquified petroleum gas (such as propane or butane); areas where the air contains chemicals or particles, such as grain, dust or metal powders; and any other area where you would normally be advised to turn off your vehicle engine.

Water resistance



Your Vertu phone is not water resistant. Keep it dry.

If your Vertu phone is accidentally splashed with water, ensure you dry it completely before removing the back cover. Remove the battery and leave all parts to dry naturally. Do not apply heat.

Never charge your Vertu phone when the connector at the bottom of the phone is damp or wet.

Chargers must only be used in dry conditions. They should never be used when damp or wet.



Make sure the interior of your Vertu phone and the back cover seals are dry, clean, and free of any foreign objects before you replace the back cover.

Antenna area

Avoid touching the antenna area (see shaded area below) of your Vertu phone unnecessarily when the phone is switched on. Contact with the antenna area affects call quality and may cause the phone to operate at a higher power level than otherwise needed.

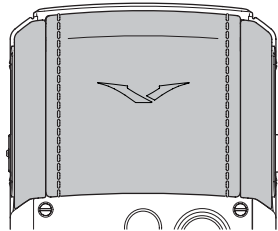

Avoid contact with the antenna area during a call to optimise the antenna performance and the talk time of your Vertu phone.

Specifications

Volume	82 cc
Weight	161 g
Length	117 mm
Width	49 mm
Thickness	18 mm

BL-5CV Li-ion battery

Talk time	up to tbc
Stand-by time	up to tbc

Warranty

Vertu two-year limited international warranty for cellular phone

THIS LIMITED WARRANTY SHALL NEITHER EXCLUDE NOR LIMIT (I) ANY MANDATORY STATUTORY RIGHTS OF THE CLIENT OR (II) ANY OF THE CLIENT'S RIGHTS AGAINST THE SELLER/DEALER OF THE PRODUCT.

VERTU warrants that this cellular phone ("Product") is free from defects in material and workmanship according to the following terms and conditions:

1. The Limited Warranty for the Product extends for TWO (2) years beginning on the date of original purchase or delivery of the Product, whichever is the later. In case of a change of owner/user, such warranty period shall continue for the remaining part of the two (2) year period.
2. During the period of the Limited Warranty, Vertu will repair, modify or replace, at Vertu's sole option, any defective parts, or any parts that will not properly operate for their intended use with new or refurbished replacement items if such repair or replacement is needed because of product malfunction or failure during normal usage. No charge will be made to the Owner for the repair or replacement of any such parts. Vertu will also pay for the labour charges incurred by Vertu in repairing or replacing the defective parts. The repaired Product will be warranted for the balance of the original warranty period. This Limited Warranty does not cover damage to or defects in (other than manufacturing defects) appearance, cosmetic, decorative or structural items and any non-operative parts. Vertu's limit of liability under the Limited Warranty shall be the price paid by the Owner for the Product less a reasonable amount for usage. These remedies are the Owner's exclusive remedies for breach of this Limited Warranty.
3. Upon request from Vertu, the Owner must prove the date of the original purchase or delivery of the Product by producing a legible and non-modified original certificate of authenticity which clearly indicates the name and address of an authorised retailer, the date and place of purchase/delivery, the product type and the IMEI or serial number of the Product, a bill of sale or a dated receipt which contains the same information.
4. Vertu shall bear the cost of shipping the Product to the location from which the Owner handed over the Product to Vertu (or its representatives) after the completion of service under this Limited Warranty.
5. The Owner shall have no coverage or benefits under this Limited Warranty if any of the following conditions are applicable:

- a) The Product has been subject to abnormal use, abnormal conditions, improper storage, exposure to moisture or dampness, spillage of food or liquid, exposure to chemical agents, unauthorised modifications, unauthorised connections, unauthorised repair, rough handling, misuse, neglect, abuse, accident, alteration, improper installation, or other acts which are not the fault of Vertu, including without limitation damage caused by shipping, dropping the Product, deterioration of consumable parts (whose limited warranty is set forth below), such as batteries which by their nature have a limited lifecycle, and breakage or damage to antennas.
 - b) The Product has been damaged from external causes such as collision with an object, or from fire, flooding, sand, dirt, windstorm, lightning, earthquake or damage from exposure to thermal, environmental or weather conditions, an Act of God, or battery leakage, theft, blown fuse, or improper use of any electrical source, damage caused by computer or internet viruses, bugs, worms, Trojan Horses, cancel bots or damage caused by the connection to other products not recommended for interconnection by Vertu.
 - c) Vertu was not advised by the Owner in writing of the alleged defect or malfunction of the Product within thirty (30) days after the expiration of the applicable warranty period.
 - d) The Product was not returned to Vertu or its authorised retailer within thirty (30) days after the appearance of the defect within the warranty period.
 - e) The Product serial number plate or the accessory data code has been removed, defaced, altered or is illegible.
 - f) The defect or damage was caused by the defective function of the cellular network system or by inadequate signal reception by the external antenna.
 - g) The defect was caused by the Product being used with or connected to an accessory not manufactured and supplied by Vertu or used other than for its intended use.
 - h) The battery was short-circuited or the seals of the battery enclosure or cells are broken or show evidence of tampering or the battery was used in equipment other than that for which it has been specified.
 - i) The Product software needs to be updated due to changes in cellular network parameters.
 - j) The defect or damage was as a result of general wear and tear incurred in normal usage of the Product.
6. If a problem develops during the period of the Limited Warranty, the following procedure will apply:
- a) The Owner shall return the Product to the place of purchase for repair or replacement processing or if this is not convenient because of distance (more than 50 miles/80 km) or for other good cause, the Owner may contact Vertu Concierge.
 - b) The Owner shall bear the costs of transporting the Product to the relevant Vertu service location, with transport and insurance charges prepaid.
 - c) Subject to Clause 6(e), the Owner will be billed for any parts or labour charges not covered by this Limited Warranty.
 - d) Vertu will repair or authorise the repair of the Product under the Limited Warranty within 30 days after receipt of the Product by Vertu or a Vertu authorised service centre, or within an extended period as may be notified by Vertu to Owner due to the nature of the repair ("Timeframe"). If Vertu cannot repair within the Timeframe, or after a reasonable number of attempts to repair the same defect, Vertu at its sole option, will provide a replacement Product or refund the purchase price of the Product less a reasonable amount for usage.
 - e) If the Product is returned to Vertu during the period of the Limited Warranty, but the problem with the Product is not covered under the terms and conditions of this Limited Warranty, the Owner will be notified and given an estimate of the charges the Owner must pay to have the Product repaired, with all shipping charges billed to the Owner. If the estimate is refused, the Product will be returned freight collect. If the Product is returned to Vertu after the expiration of the warranty period, Vertu's normal service policies shall apply and the Owner will be responsible for all shipping charges.
7. TO THE FULLEST EXTENT PERMITTED BY LAW, THE WARRANTIES AND CONDITIONS STATED IN THIS LIMITED WARRANTY ARE IN

- LIEU OF ALL OTHER CONDITIONS, WARRANTIES OR OTHER TERMS CONCERNING THE SUPPLY OR PURPORTED SUPPLY OF, OR FAILURE TO SUPPLY OR DELAY IN SUPPLYING THE PRODUCT WHICH MIGHT, BUT FOR THE AFFECT OF THIS CLAUSE 7, HAVE EFFECT BETWEEN VERTU AND THE CLIENT OR WOULD OTHERWISE BE IMPLIED OR INCORPORATED INTO THIS LIMITED WARRANTY OR ANY COLLATERAL CONTRACT, WHETHER BY STATUTE, COMMON LAW OR OTHERWISE, ALL OF WHICH ARE HEREBY EXCLUDED (INCLUDING WITHOUT LIMITATION, THE IMPLIED CONDITIONS, WARRANTIES OR OTHER TERMS AS TO SATISFACTORY QUALITY OR FITNESS FOR PURPOSE).
8. VERTU SHALL NOT BE LIABLE FOR LOSS OR DAMAGE, WHETHER SPECIAL, INDIRECT, INCIDENTAL OR CONSEQUENTIAL, INCLUDING BUT NOT LIMITED TO ANY OF THE FOLLOWING LOSSES OR DAMAGE (WHETHER SUCH LOSSES OR DAMAGE WERE FORESEEN, FORESEEABLE, KNOWN OR OTHERWISE):
- a) LOSS OF ACTUAL OR ANTICIPATED BENEFITS OR PROFITS.
 - b) LOSS OF ACTUAL OR ANTICIPATED SAVINGS.
 - c) PUNITIVE, SPECIAL OR CONSEQUENTIAL DAMAGES.
 - d) THIRD PARTY CLAIMS.
 - e) LOSS OF USE OF THE PRODUCT OR ANY ASSOCIATED EQUIPMENT OR FACILITIES.
 - f) DOWNTIME OR LOSS OF BUSINESS.
 - g) LOSS OF OPPORTUNITY.
 - h) LOSS OF GOODWILL.
 - i) LOSS OF REPUTATION.
 - j) LOSS OF OR DAMAGE TO OR CORRUPTION OF DATA.
9. Vertu does not warrant uninterrupted or error free internet or data connections.
10. Vertu shall not be liable for any delay in rendering service under the Limited Warranty, or loss of use during the period that the Product is being repaired.
11. Vertu's total liability in contract, tort (including negligence or breach of statutory duty), misrepresentation or otherwise, arising in connection with the sale of the Product shall be the price paid by the Owner for the Product less a reasonable amount for usage.
12. The invalidity or unenforceability of any term or any part of any term of, or any right arising pursuant to, this Limited Warranty shall not affect the validity or enforceability of any other terms or rights or the remainder of any such term or right, which shall continue in full force and effect except for any such invalid or unenforceable provision or part thereof.

13. Vertu neither assumes nor authorises any authorised service centre or any other person or entity to assume for it any other obligation or liability beyond that which is expressly provided for in this Limited Warranty, including the provider or seller of any extended warranty or service agreement. Any change or amendment to this Limited Warranty requires Vertu's prior written consent.
14. This Limited Warranty represents the whole agreement between the parties relating to the subject matter hereof.
15. This Limited Warranty allocates the risk of failure of the Product between the Owner and Vertu. The allocation is recognised by the Owner and is reflected in the purchase price of the Product.
16. Any action or lawsuit for breach of warranty must be commenced within thirty (30) months following delivery of the Product.
17. All warranty information, product features and specifications are subject to change without notice.
18. Questions concerning this Limited Warranty may be directed to Vertu at the following addresses.

If contacting us from Europe, Middle East and Africa:

Vertu
Beacon Hill Road
Church Crookham
Hampshire
GU52 8DY
United Kingdom

If calling us from the Americas:

+1 914 368 0432

If contacting us from Asia Pacific:

Vertu
391B Orchard Road
#24-02/05, Ngee Ann City, Tower B
Singapore 238874

Vertu operates a policy of continuous development. Vertu reserves the right to make changes and improvements to any of the products described in this document without prior notice.

Vertu one-year limited international warranty for accessories

THIS LIMITED WARRANTY SHALL NEITHER EXCLUDE NOR LIMIT (I) ANY MANDATORY STATUTORY RIGHTS OF THE OWNER OR (II) ANY OF THE OWNER'S RIGHTS AGAINST THE SELLER/DEALER OF THE PRODUCT.

Vertu ("Vertu") warrants that this accessory product ("Product") is free from defects in material and workmanship, according to the following terms and conditions:

1. The Limited Warranty for the Product extends for ONE (1) year beginning on the date of original purchase or delivery of the Product whichever is the later. In case of a change of owner/user ("Owner"), such warranty period shall continue for the remaining part of the one (1) year period.
2. During the period of the Limited Warranty, Vertu will repair, modify or replace, at Vertu's sole option, any defective parts, or any parts that will not properly operate for their intended use with new or refurbished replacement items if such repair or replacement is needed because of product malfunction or failure during normal usage. No charge will be made to the Owner for the repair or replacement of any such parts. Vertu will also pay for the labour charges incurred by Vertu in repairing or replacing the defective parts. The repaired Product will be warranted for the balance of the original warranty period. This Limited Warranty does not cover damage to or defects in (other than manufacturing defects) appearance, cosmetic, decorative or structural items and any non-operative parts. Vertu's limit of liability under the Limited Warranty shall be the price paid by the Owner for the Product when the Owner purchased the Product as a stand alone product or, in the event that the Owner received the Product when purchasing a Vertu cellular phone, the then current sale price for the Product, in both cases less a reasonable amount for usage. These remedies are the Owner's exclusive remedies for breach of this Limited Warranty.
3. Upon request from Vertu, the Owner must prove the date of the original purchase or delivery of the Product by producing a legible and non-modified original warranty card which clearly indicates the name and address of an authorised retailer, the date and place of purchase/delivery, the product type and the IMEI or serial number of the Product, a bill of sale or a dated receipt which contains the same information.
4. Vertu shall bear the cost of shipping the Product to the location from which the Owner handed over the Product to Vertu (or its representatives) after the completion of service under this Limited Warranty.

5. The Owner shall have no coverage or benefits under this Limited Warranty if any of the following conditions are applicable:
- The Product has been subject to abnormal use, abnormal conditions, improper storage, spillage of liquid, misuse, neglect, exposure to cleaning agents not recommended, or other acts which are not the fault of Vertu, unauthorised repair, accident, alteration or other acts which are not the fault of Vertu.
 - Vertu was not advised by the Owner in writing of the alleged defect or malfunction of the Product within thirty (30) days after the expiration of the applicable warranty period; or
 - The Product was not returned to Vertu or its authorised retailer within thirty (30) days after the appearance of the defect within the warranty period.
 - The defect or damage was as a result of general wear and tear incurred in normal usage of the Product.
 - The Product is used with a product different to the one with which the Product was supplied with by Vertu, or the Product is used with any product whose use with the Product has not been expressly authorised by Vertu.
6. If a problem develops during the period of the Limited Warranty, the following procedure will apply:
- The Owner shall return the Product to the place of purchase for repair or replacement processing or if this is not convenient because of distance (more than 50 miles/80 km) or for other good cause, the Owner may contact Vertu Concierge.
 - The Owner shall bear the costs of transporting the Product to the relevant Vertu service location, with transport and insurance charges prepaid.
 - Subject to clause 6(e), the Owner will be billed for any parts or labour charges not covered by this Limited Warranty.
 - Vertu will repair or authorise the repair of the Product under the Limited Warranty within 30 days of receipt of the Product by Vertu or a Vertu authorised service centre, or within an extended period as may be notified by Vertu to Owner due to the nature of the repair ("Timeframe"). If Vertu cannot repair within the Timeframe, or after a reasonable number of attempts to repair the same defect, Vertu at its sole option, will provide a replacement Product or refund the purchase price of the Product less a reasonable amount for usage.
 - If the Product is returned to the Vertu during the period of the Limited Warranty, but the problem with the Product is not covered under the terms and conditions of this Limited Warranty, the Owner will be notified and given an estimate of the charges the Owner must pay to have the Product repaired, with all shipping charges billed to the Owner. If the estimate is refused, the Product will be returned freight collect. If the Product is returned to Vertu after the expiration of the warranty period, Vertu's normal service policies shall apply and the Owner will be responsible for all shipping charges.
7. TO THE FULLEST EXTENT PERMITTED BY LAW, THE WARRANTIES AND CONDITIONS STATED IN THIS LIMITED WARRANTY ARE IN LIEU OF ALL OTHER CONDITIONS, WARRANTIES OR OTHER TERMS CONCERNING THE SUPPLY OR PURPORTED SUPPLY OF, OR FAILURE TO SUPPLY OR DELAY IN SUPPLYING THE PRODUCT WHICH MIGHT, BUT FOR THE AFFECT OF THIS CLAUSE 7, HAVE EFFECT BETWEEN VERTU AND THE OWNER OR WOULD OTHERWISE BE IMPLIED OR INCORPORATED INTO THIS LIMITED WARRANTY OR ANY COLLATERAL CONTRACT, WHETHER BY STATUTE, COMMON LAW OR OTHERWISE, ALL OF WHICH ARE HEREBY EXCLUDED (INCLUDING WITHOUT LIMITATION, THE

IMPLIED CONDITIONS, WARRANTIES OR OTHER TERMS AS TO SATISFACTORY QUALITY OR FITNESS FOR PURPOSE).

8. VERTU SHALL NOT BE LIABLE FOR LOSS OR DAMAGE, WHETHER SPECIAL, INDIRECT, INCIDENTAL OR CONSEQUENTIAL, INCLUDING BUT NOT LIMITED TO ANY OF THE FOLLOWING LOSSES OR DAMAGE (WHETHER SUCH LOSSES OR DAMAGE WERE FORESEEN, FORESEEABLE, KNOWN OR OTHERWISE):
- LOSS OF ACTUAL OR ANTICIPATED BENEFITS OR PROFITS
 - LOSS OF ACTUAL OR ANTICIPATED SAVINGS
 - PUNITIVE, SPECIAL OR CONSEQUENTIAL DAMAGES.
 - THIRD PARTY CLAIMS
 - LOSS OF USE OF THE PRODUCT OR ANY ASSOCIATED EQUIPMENT OR FACILITIES
 - DOWNTIME OR LOSS OF BUSINESS
 - LOSS OF OPPORTUNITY
 - LOSS OF GOODWILL
 - LOSS OF REPUTATION
 - LOSS OF OR DAMAGE TO OR CORRUPTION OF DATA.
9. Vertu shall not be liable for any delay in rendering service under the Limited Warranty, or loss of use during the period that the Product is being repaired.
10. Vertu's total liability in contract, tort (including negligence or breach of statutory duty), misrepresentation or otherwise, arising in connection with the sale of the Product shall be the price paid by the Owner for the Product less a reasonable amount for usage.
11. The invalidity or unenforceability of any term or any part of any term of, or any right arising pursuant to, this Limited Warranty shall not affect the validity or enforceability of any other terms or rights or the remainder of any such term or right, which shall continue in full force and effect except for any such invalid or unenforceable provision or part thereof.
12. Vertu neither assumes nor authorises any authorised service centre or any other person or entity to assume for it any other obligation or liability beyond that which is expressly provided for in this Limited Warranty including the provider or seller of any extended warranty or service agreement. Any change or amendment to this Limited Warranty requires Vertu's prior written consent.
13. This Limited Warranty represents the whole agreement between the parties relating to the subject matter hereof.
14. This Limited Warranty allocates the risk of failure of the Product between the Owner and Vertu. The allocation is recognised by the Owner and is reflected in the purchase price of the Product.



VERTU

- 15. Any action or lawsuit for breach of warranty must be commenced within eighteen (18) months following delivery of the Product.
- 16. All warranty information, product features and specifications are subject to change without notice.
- 17. Questions concerning this Limited Warranty may be directed to Vertu at the following addresses.

If contacting us from Europe, Middle East and Africa:

Vertu
 Beacon Hill Road
 Church Crookham
 Hampshire
 GU52 8DY
 United Kingdom

If calling us from the Americas:

+1 914 368 0432

If contacting us from Asia Pacific:

Vertu
 391B Orchard Road
 #24-02/05, Ngee Ann City, Tower B
 Singapore 238874

Vertu operates a policy of continuous development. Vertu reserves the right to make changes and improvements to any of the products described in this document without prior notice.

SAR Notice – RM-267V

YOUR VERTU PHONE (Model: Ascent Ti, Type: RM-267V, FCC ID: P7QRM-267V) MEETS GUIDELINES FOR EXPOSURE TO RADIO WAVES.

Your Vertu phone is a radio transmitter and receiver. It is designed not to exceed the limits for exposure to radio waves recommended by international guidelines. These guidelines were developed by the independent scientific organization ICNIRP and include safety margins designed to assure the protection of all persons, regardless of age and health.

The exposure guidelines for mobile devices employ a unit of measurement known as the Specific Absorption Rate or SAR. The SAR limit stated in the ICNIRP guidelines is 2.0 watts/kilogram (W/kg) averaged over ten grams of tissue. Tests for SAR are conducted using standard operating positions with the phone transmitting at its highest certified power level in all tested frequency bands. The actual SAR level of an operating phone can be below the maximum value because the phone is designed to use only the power required to reach the network. That amount changes depending on a number of factors such as how close you are to a network base station. The highest SAR value under the ICNIRP guidelines for use of the phone at the ear is 0.57 W/kg.

This phone meets RF exposure guidelines when used either in the normal use position against the ear or when positioned at least 2.2 cm (7/8 inch) away from the body. When a carry case, belt clip or holster is used for body-worn operation, it should not contain metal and should position the phone the above-stated distance from your body.

In order to transmit data files or messages, this phone model requires a good quality connection to the network. In some cases, transmission of data files or messages may be delayed until such a connection is available. Ensure the above separation distance instructions are followed until the transmission is completed.

Use of phone accessories and enhancements may result in different SAR values. SAR values may vary depending on national reporting and testing requirements and the network band. Additional SAR information may be provided under product information at www.vertu.com.

Your phone is also designed to meet the requirements for exposure to radio waves established by the Federal Communications Commission (USA) and Industry Canada. These requirements set a SAR limit of 1.6 W/kg averaged over one gram of tissue. The highest SAR value reported under this standard during product certification for use at the ear is 0.54 W/kg and when properly worn on the body is 0.86 W/kg.

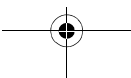

Declaration of conformity

We, Vertu declare under our sole responsibility that the product, Model: Ascent Ti, Type: RM-267V is in conformity with the provision of the following Council Directive: 1999/5/EC.

A copy of the Declaration of Conformity can be found at <http://www.vertu.com>

CE0168

Notices

Copyright © Vertu 2007. All rights reserved.

Reproduction, transfer, distribution or storage of part or all of the contents in this document in any form without the prior written permission of Vertu is prohibited. Vertu operates a policy of continuous development. Vertu reserves the right to make changes and improvements to any of the products described in this document without prior notice.

Under no circumstances shall Vertu be responsible for any loss of data or income or any special, incidental, consequential or indirect damages howsoever caused.

The contents of this document are provided "as is". Except as required by applicable law, no warranties of any kind, either expressed or implied, including, but not limited to, the implied warranties of merchantability and fitness for a particular purpose, are made in relation to the accuracy, reliability or contents of this document. Vertu reserves the right to revise this document or withdraw it at any time without prior notice. The availability of particular products may vary by region. Please check with Vertu Concierge.

Vertu and the V logo are registered trademarks or trademarks. Other product and company names mentioned herein may be trademarks or registered trademarks of their respective owners.

Includes RSA BSAFE cryptographic or security protocol software from RSA Security.

Bluetooth is a registered trademark of Bluetooth SIG, Inc.

Export controls

Your Vertu phone may contain commodities, technology, or software exported from the United States in accordance with the Export Administration regulations. Diversion contrary to U.S. law is prohibited.

FCC/Industry Canada notice

Your Vertu phone may cause TV or radio interference (for example, when using a telephone in close proximity to receiving equipment). The FCC or Industry Canada can require you to stop using your phone if such interference cannot be eliminated. If you require assistance, contact Vertu Concierge. This device complies with Part 15 of the FCC rules. Operation is subject to the following two conditions: (1) this device may not cause harmful interference, and (2) this device must accept any interference received, including interference that may cause undesired operation.

Note: Vertu is not responsible for any radio or TV interference caused by unauthorized modifications to this equipment. Such modifications could void your authority to operate the equipment.

EU recycling notice

Vertu will comply with European Community requirements for the recycling of Waste Electrical & Electronic Equipment (WEEE).

This compliance is indicated by the addition of the following symbol to Vertu's products where appropriate.



The symbol indicates that the product was put onto the market after the WEEE legislation was implemented and that the consumer should not dispose of the item in normal household waste, but that it should be appropriately recycled.

Should you wish Vertu to recycle your product at the end of its life, please either return it to the point from which you purchased your product (if known) or return it to Vertu's headquarters.

Alternatively, should you purchase a replacement product from another supplier, the new supplier is obligated to take back the product that is being replaced and recycle it appropriately.

Background information on the European WEEE directive is available from www.europa.eu.int/

Vertu Concierge Terms & Conditions

1. Vertu Concierge

As a registered member of Vertu Concierge ("VC") provided by Vertu and its associated companies ("Vertu"), you ("you") agree to abide by these Terms and Conditions (the "Terms and Conditions"), and when ordering anything through VC from a supplier of products and services (a "Supplier") you agree that the Terms and Conditions shall apply to your order.

2. Membership Information

You are obliged to provide correct details when you register for membership of VC and your failure to do so may invalidate your membership and any subsequent transaction. Your responsibility to provide accurate information is a continuing obligation and you must notify Vertu in the event that any information provided by you in the course of registration changes.

3. Subscription

Initial and ongoing subscription fees, if applicable, are due at the time of initial subscription and annually thereafter (the "Renewal Date") unless you notify Vertu of your intention not to renew. Payment must be made annually in advance and may be made using any major credit/debit and charge cards. Any subscription fee is non refundable, however, Vertu may at its sole discretion elect to refund any subscription fee in whole or in part depending on the circumstances relating to the cancellation of any subscription. You authorize Vertu to deduct renewal subscription fees from your credit card up to 28 days prior to your Renewal Date. If Vertu does not hold your payment details you will be contacted directly to renew your subscription. Subscription fee rates will be notified to you from time to time and the subscription fee payable will be the subscription fee in force at the time of the Renewal Date.

You agree that you will only use your VC membership for the purposes for which it is issued.

4. VC Services

As a member of VC, you are entitled to all of the products and services as advised by us from time to time as approved by the relevant product/service Supplier.

5. Services Subject to Change

As a member, note that:

- > *Services are subject to availability and may change from time to time;*
- > *Suppliers may change from time to time;*
- > *Suppliers may impose their own terms and conditions and you are required to comply with these at all times.*

6. Payment for Services

Please note that some Suppliers may charge you a deposit, entry fee or other sum for the services they provide. You will be solely liable for payment of any such sums. At your request Vertu will authorise Suppliers to debit your nominated credit/debit or charge card in order for you to take advantage of their services.

7. Availability of Services

Vertu aims to ensure that the services remain available at all times and will use reasonable endeavours to ensure that you receive the most from your membership. If any of the services become unavailable, we will do all we can to ensure that prior commitments are honoured to the fullest extent possible, but shall not be responsible for any actions of Suppliers outside Vertu's reasonable control. From time to time the procurement or provision of certain services may incur a VC handling charge of which you will be notified - in these cases you hereby authorise Vertu to debit your nominated credit/debit or charge card with any such handling charges. Unless otherwise agreed by the Supplier, you shall not be entitled to cancel any services requested where, on your instructions, performance has already begun.

8. Right of Withdrawal

Vertu reserves the right to withdraw any service that may be offered and/or to refuse to supply any service requested.

9. Requests

If Vertu is unable to deal with any request, it will inform you as soon as reasonably practicable.

10. Dealing with VC Suppliers

Suppliers are responsible for providing you with the goods and services you select. Vertu will assist you in any way it can in all of your dealings with Suppliers.

11. Personal Membership

VC membership is personal to the registered Vertu phone user. You are responsible for ensuring that no one (other than your personal assistant, where applicable) uses your membership to access membership services and benefits.

12. Cancellation of Membership

Vertu reserves the absolute right to cancel or suspend your membership (at its sole discretion) for any reason whatsoever. If Vertu cancels your membership it shall refund the balance of the annual subscription fee, if any, on a time apportionment basis in respect of the unexplored period to which the annual subscription fee applies.

13. Changes to Terms and Conditions

Vertu may vary these Terms and Conditions from time to time. Vertu will notify you of any changes in a timely manner. Notification will be by some or all of the following media:

- > *newsletter;*
- > *mail;*
- > *e-mail or other personal delivery service.*

14. Payment Details

If we do not have your credit/debit or charge card details we may not be able to provide or procure those benefits, goods or services that require payment.

You may only make transactions using VC during your period of membership. When ordering a product or service you will be required to provide your credit/debit or charge card details. You undertake that all details you provide to us for the purpose of booking, ordering or purchasing goods or services are correct, that the credit/debit or charge card you are using is your own and that there are sufficient funds to cover the cost of the product or the service.

15. Supply of Details

Vertu may pass on your credit/debit or charge card and any other essential booking details to its agents, employees, subcontractors and Suppliers, and you consent to us passing on such details to deal with your orders. You must inform Vertu as soon as possible of any changes to the details supplied by you.

16. Payments Due

The purchase price of all products and services obtained through VC is due for payment on acceptance of your order by Vertu and/or a Supplier, as applicable.

17. Delivery

By placing your order for a product or service through VC you agree that the time taken for delivery or performance shall be as stipulated when the purchase is made. We want you to get your order as soon as possible. If delivery or performance will take longer than the time set out (or the product or services are unavailable), the Supplier (or Vertu acting for the Supplier) will notify you of this at the earliest opportunity and you will have the unequivocal right to withdraw your order and receive a full refund.

18. Limited Warranty

Vertu warrants to you that Vertu shall use its reasonable endeavours to provide the VC services with reasonable care and skill and, as far as reasonably possible, in accordance with your request and instructions from time to time. Where Vertu supplies you with any goods or services supplied by a third party, then Vertu is acting as your agent in sourcing the goods or services. Vertu will use reasonable care in selecting the Supplier and ensuring the order is placed in accordance with your wishes. For the avoidance of doubt, Vertu does not and will not provide any representations or recommendations in relation to any of the information and suggestions comprised within the VC services. You are deemed to be responsible for, and shall use your own skill and judgement as to, the quality, value and suitability of such information and suggestions in relation to deciding whether to enter into any contract with any third party for the supply of services or sale of goods.

19. Vertu as Agent

Your contract for the purchase of products or services is made with the relevant Supplier only. Vertu acts as an agent for the Supplier and, unless expressly provided otherwise, all your rights and remedies are against the Supplier.

20. Disclaimers

Vertu will not be responsible for products and services offered by Vertu as agents for the Suppliers or for any aspect of the relationship between you and any particular Supplier. Vertu will however do everything it reasonably can to assist you in any dealings you have with the Supplier.

You agree that any contract entered into by you with any of the Suppliers is an independent contract. Vertu hereby disclaims any and all liability for any act or omission of any Supplier or any loss incurred by you as a result of any act or omission of a Supplier whether or not arranged through VC.

21. Limitation of Liability

Vertu accepts no liability for any losses or claims arising from any inability to contact VC or any failure to complete a transaction.

Save in respect of death and personal injury caused by the negligence of Vertu or as expressly provided for in these Terms and Conditions, Vertu shall not be liable for any loss, cost, expense or damage of any nature whatever (whether direct or indirect) resulting from the provision of the

Services or your reliance upon the information and suggestions provided by Vertu hereunder and the resulting supply of goods and services to you by any third party.

Vertu shall have no liability to you for any loss, damage, costs, expenses or other claims for compensation arising from requests or instructions supplied by you which are incomplete, incorrect or inaccurate or arising from their late arrival or non-arrival, or any other fault of you.

Vertu shall not be liable to you or be deemed to be in breach of these Terms and Conditions by reason of any delay in performing, or any failure to perform, any of Vertu's obligations in relation to the VC services, if the delay or failure was due to any cause beyond Vertu's reasonable control.

Except in respect of death and personal injury caused by the negligence of Vertu and subject to the provisions of these Terms and Conditions, Vertu's maximum liability to you for breach of any of its obligations hereunder shall be limited to the value of the annual subscription fee, if any, and the relevant charge for the VC services to be provided.

The limitations of liabilities set out herein apply only to the maximum extent permitted by law.

22. Governing Law and Arbitration of Disputes

Any and all claims, except claims for monies due to Vertu, arising out of or relating to the use of VC must be commenced within one (1) year after the date either you or Vertu knew or should have known of the facts giving rise to such claim, after which such actions shall be barred. If acceptance of your membership request or a particular service request takes place within Europe, Middle East or Africa, the governing law shall be English law. All disputes arising out of or in connection with these Terms and Conditions shall be finally settled under the Rules of Arbitration of the International Chamber of Commerce by one arbitrator appointed in accordance with the said Rules. The arbitration proceedings shall be conducted in London, England in the English language. The arbitration decision shall be final and binding. Provided that the parties shall have the right to take proceedings in any other jurisdiction for the purposes of enforcing a judgment or order obtained from the courts of England and Wales.

If acceptance of your membership request or a particular service request takes place within Asia Pacific, the governing law of these Terms and Conditions shall be Singapore law. All disputes arising from or connected to these Terms and Conditions shall be settled finally and exclusively in Singapore under the Rules of the Singapore International Arbitration Centre (SIAC Rules). The arbitration shall be conducted in English in Singapore. The award shall be final and binding on both parties. Provided that the parties shall have the right to take proceedings in any other jurisdiction for the purposes of enforcing the arbitral award.

If acceptance of your membership request or a particular service request takes place within the Americas region, all disputes and matters relating to arbitration shall be governed by the Federal Arbitration Act (9 U.S.C. §§1 et. seq.). Except to the extent governed by applicable U.S. federal law, any transactions with VC and its Suppliers shall be governed by the laws of the State of Texas, excluding its conflict of law rules. Any and all claims, except claims for monies due to Vertu, arising out of or relating to your membership and use of VC shall be barred unless an action or legal proceeding is commenced within eighteen (18) months after the date you or Vertu knew or should have known of the facts giving rise to such claim. Any dispute relating in any way to your membership and use of VC and any orders placed through VC, shall be submitted (together with any counterclaims and disputes under or in connection with other transactions and/or agreements between you and Vertu) to final and binding, confidential arbitration to the Dallas, Texas office of the American Arbitration Association (the "AAA"), with such arbitration to be held in Dallas County, Texas, except that, to the extent you have in any manner violated or threatened to violate any Vertu or Vertu affiliates' or licensors' intellectual property rights, Vertu may seek injunctive or other appropriate relief in any state or federal court in the state of Texas or, at Vertu's option, any other appropriate state or country, and you consent to exclusive jurisdiction and venue of such court. Arbitration under these Terms and Conditions shall be conducted under the then prevailing Wireless Industry Arbitration Rules of the AAA (except as such rules may be modified by the terms of these Terms and Conditions),

unless otherwise agreed in writing by the parties and shall be heard by a single arbitrator. Subject to any terms contained in these Terms and Conditions limiting or excluding damages, the arbitrator may award any relief that the arbitrator deems proper, including without limitation equitable relief, provided that no award of exemplary, special, consequential or punitive damages shall be permitted. The prevailing party, as determined by the arbitrator, shall pay the AAA arbitration fees and the arbitrator's fees and expenses, as applicable. The arbitrator's award shall be binding and may be entered as a judgment and enforceable in any court of competent jurisdiction. To the fullest extent permitted by applicable law, the arbitration shall be conducted on an individual, not a class-wide basis, and no arbitration under these Terms and Conditions shall be consolidated with or joined to an arbitration involving any other person or entity, whether through class arbitration proceedings or otherwise, without the prior written consent of you and Vertu.

23. Force Majeure

Vertu shall not be liable for loss or damage caused by any delay or failure to perform its obligations under these Terms and Conditions caused by failure of any machine, system of authorization, data processing or communications system, transmission link, strikes, lockouts, riots, war, fire, acts of God, accidents, material or transportation shortages, governmental restrictions or injunctions, or denial of import or export licenses, or compliance with any law, regulation or order, or due to any other circumstances or causes that have the effect of frustrating performance of these Terms and Conditions, or any other cause beyond the control of Vertu.

24. General Provisions

Headings - The headings of each of these Terms and Conditions are for convenience of reference only and shall not form part of these Terms and Conditions. Such headings shall be ignored in the interpretation or construction of any of these Terms and Conditions.

Severability - If any provision or provisions of these Terms and Conditions shall be held to be invalid, illegal or unenforceable, such provision shall be enforced to the fullest extent permitted by applicable law, and the validity, legality and enforceability of the remaining provisions shall not in any way be affected or impaired thereby.

No Waiver - Vertu's failure to insist on performance of any term or condition contained in these Terms and Conditions, or failure to exercise any of Vertu's rights hereunder, shall not constitute a waiver of any of Vertu's rights or remedies under these Terms and Conditions.

Entire Agreement - These Terms and Conditions constitute Vertu's and your complete and final statement of the parties' agreements and understandings relating to the subject matter of these Terms and Conditions, and supersedes any related prior agreements, understandings and discussions, oral or written.

Notices - Each party (i.e. you or Vertu) may send notices or communications to the other by personal delivery, e-mail, regular mail or fax. Notices or communications must be sent to the latest contact details specified by the receiving party. Notices and communications will be considered received by the addressee (as applicable): (1) If by courier or other mode of personal delivery, on the date of personal delivery to such addressee's address as last specified by that addressee before dispatch; or (2) if by posting, 5 working days after the date of registered posting (by airmail, delivery receipt requested) to the addressee's address last specified by the addressee before posting; or (3) if by facsimile, contemporaneously with facsimile transmission to the facsimile number last specified by the addressee before transmission, with delivery being evidenced by an appropriate successful transmission contact report. E-mail communications shall be considered received by the addressee on the earlier of (1) the earliest time at which the e-mail is accessible by the addressee; (2) receipt by the sender of a delivery receipt message indicating successful delivery to the intended addressee's e-mail address, or (3) the expiry of 48 hours from the sending of the e-mail; provided that if at any point the sender receives notification that the e-mail has not been successfully transmitted to an

addressee then the e-mail shall not be deemed to have been received by that addressee. Order cancellations by you via e-mail shall only be effective upon express acceptance thereof by Vertu.

Telephone - Vertu may at its option accept orders and acknowledge, accept or effect other communications by telephone. Telephone communications by Vertu shall be as effective as written communications.

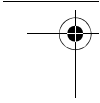

VERTU

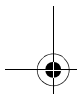
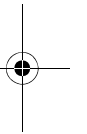
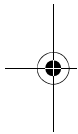
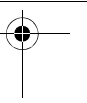

Part number:

June 2007

