

VERTU

CONSTELLATION

Contents

Safety.....6

Introduction7

Overview.....	7
Help and support	7
Use the user guide in your phone	7
Care of your phone	8
Keys and parts.....	9

Get started 12

Package contents	12
Insert or remove the SIM card.....	12
Lock or unlock the keys and screen...	14
Charging	14
Set up your phone.....	17
Transfer content from your old phone	18
Touchscreen actions	19
Change the volume of a call, song, or video.....	21
Antenna locations	21
Attach a lanyard.....	22
Headset.....	22
Switch the phone on or off	23
If your phone stops responding.....	23

Vertu services..... 24

Vertu City Brief.....	24
Vertu Select	24
Vertu Concierge.....	24
Contact Vertu Concierge	25
Contact Vertu Technical Support.....	25
Vertu Fortress	26
Remote Assist	26
Vertu Concierge Live	26

Home screen..... 27

Interactive home screen elements	27
Menu key and soft keys	29
Clock	30

Use the calendar.....	33
Modify the home screen	34
Write text	37
Display indicators	42
Set the notification light to blink for missed calls or messages.....	43
Flashlight	43
Use your phone offline	43
Search in your phone and on the internet	44

Personalisation..... 45

Profiles.....	45
---------------	----

Calls..... 47

Call a phone number.....	47
Search for a contact.....	47
Call a contact	47
Reject a call	48
Mute a call	48
Answer a waiting call	48
Make a conference call	49
Call the numbers you use the most.....	49
Make calls over the internet	50
Call the last dialled number.....	51
Record a phone conversation	51
Turn to silence	51
View your missed calls.....	52
Call your voice mailbox	52
Divert calls to your voice mailbox or another phone number	52
Prevent the making or receipt of calls	53
Allow calls only to certain numbers	53

Contacts..... 55

About Contacts	55
Save phone numbers and mail addresses.....	55
Save a number from a received call or message.....	55

Contact your most important people quickly	56	Use separate calendars for work and free time.....	71
Add a picture for a contact	56	Add the location to a calendar entry... ..	71
Set a ringing tone for a specific contact.....	56	Connectivity	73
Send your contact information using My Card.....	57	Define how your phone connects to the internet.....	73
Create a contact group	57	Wireless LAN.....	73
Send a message to a group of people	57	Bluetooth	74
Copy contacts from the SIM card to your phone.....	58	USB data cable.....	77
Office Communicator.....	58	Store your files on a remote drive	78
Messaging	60	Close a network connection.....	78
About Messaging.....	60	Internet	80
Send a message.....	60	About the web browser	80
Send a message to a contact.....	60	Browse the web	80
Send an audio message	61	Add a bookmark	80
Receive messages	61	Subscribe to a web feed	81
View a conversation.....	62	Add a web feed to your home screen	81
Listen to a text message	62	Access your company intranet.....	82
Change language	63	Social networks	83
Mail	64	About Social	83
About Mail.....	64	See your friends' status updates in one view	83
Set up a mailbox	64	Post your status to social networking services	84
Set up a Mail for Exchange mailbox... ..	65	Link your online friends to their contact information	84
Synchronise your mailbox.....	66	See your friends' status updates on the home screen	84
Read mail	66	Upload a picture or video to a service	84
Send a mail.....	67	Contact a friend from a social networking service.....	85
Open mail from a home screen	67	Add an event to your device calendar	85
Calendar	69	Camera	86
About the calendar.....	69	About the camera	86
Browse your calendar entries in different views.....	69	Take a picture	86
Add a task to your to-do list.....	69		
Add a calendar entry.....	69		
Send a meeting request.....	70		
Remember a birthday	71		

Save location information to your pictures and videos.....	87	Keep your phone software and applications up to date.....	114
Picture and video tips	87	Vertu Fortress	115
Record a video	88	Manage files	116
Send a picture.....	88	Increase available memory so you can add more content.....	117
Your pictures and videos	89	Manage applications.....	118
About Photos	89	Synchronise content	118
View pictures and videos	89	Copy contacts or pictures between phones.....	119
Edit the pictures you have taken	90	Protect your phone	120
Video editor	90	Install PC Suite on your PC	120
Print a picture you have taken	91		
Videos and TV.....	92	Accessories	121
Videos	92	Charge the battery	121
Music and audio	93	About Vertu Portable Power DC-15V	122
Music player	93	Use Vertu Portable Power DC-15V ..	122
Protected content	95	Use the vehicle charger	123
Record sounds	95	Use the data cable	124
FM radio	96	Wired stereo headset.....	125
Maps	98	Common accessory settings.....	125
Maps overview.....	98	Troubleshooting	127
My position	98	If your phone stops responding.....	127
Find places	102	Restore original settings	127
Favourites	103	What to do when the memory is full?	127
Drive and Walk	105	Message indicator blinking	127
Give feedback on Maps	109	A contact appears twice in the contacts list.....	128
Office	111	Unreadable characters while browsing the web.....	128
Quickoffice.....	111	Remove all content and restore settings	128
Read PDF documents	111	Examine your phone's compliance label.....	128
Make a calculation	111	Specifications	131
Write notes	112	Protect the environment.....	133
Translate words from one language to another	112	Save energy.....	133
Open or create zip files	113	Recycle.....	133
Phone management.....	114		

Product and safety information.. 134

Index..... 141

Safety

Read these simple guidelines. Not following them may be dangerous or illegal. For further information, read the complete user guide.

SWITCH OFF IN RESTRICTED AREAS



Switch the device off when mobile phone use is not allowed or when it may cause interference or danger, for example, in aircraft, in hospitals or near medical equipment, fuel, chemicals, or blasting areas. Obey all instructions in restricted areas.

ROAD SAFETY COMES FIRST



Obey all local laws. Always keep your hands free to operate the vehicle while driving. Your first consideration while driving should be road safety.

INTERFERENCE



All wireless devices may be susceptible to interference, which could affect performance.

QUALIFIED SERVICE



Only qualified personnel may install or repair this product.

KEEP YOUR DEVICE DRY



Your device is not water-resistant. Keep it dry.

PROTECT YOUR HEARING



Listen to a headset at a moderate level, and do not hold the device near your ear when the loudspeaker is in use.

Introduction

Overview

This user guide is intended to provide you with full details on how to use the prominent features on your Vertu Constellation.

When you set up the phone, it is recommended that you register, because you then have access to the full range of Vertu's personalised services, and to the full range of home screens, including Vertu Select and Vertu City Brief.

The pictures used in this user guide are provided for illustration purposes only. They may differ from those on your actual version of the Vertu Constellation.



Tip: To access Vertu services, select **Menu > Vertu**.

Help and support

To find out more about using your Vertu Constellation:

- Contact Vertu Technical Support using the Concierge key.

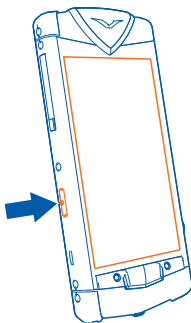

- Refer to the user guide on your phone or to the full reference manual on the Vertu website.
- Use the setup wizards available on your Vertu Constellation that can help you with registration and mail account creation. Select **Menu > Vertu > Sett. wizard**.

Use the user guide in your phone

Select **Menu > Office > Tools > User guide**.

Open the user guide from an application

Select **Options > User guide**. This is not available for every application.

Search the user guide

When the user guide is open, select **Options > Search**, and enter a letter or a word in the search field.

Switch between the user guide and an application

Press and hold the menu key to display the list of open applications (including the user guide), swipe left or right, and select the desired application.



Tip: To scroll up and down an open topic, slide your finger quickly up or down the screen, and then release it. The content of the screen scrolls with the speed and direction it had at the moment of release. To stop scrolling, simply tap the screen.

At the end of each topic, there are links to related topics where relevant.

Care of your phone

If your Vertu Constellation, or any of the accessories, are not working as they should, contact your Vertu dealer.

General care

- Always use your Vertu Constellation in the documented manner. Incorrect usage may affect performance.
- Do not attempt to open or disassemble your Vertu Constellation. The only part you ever need to open is the SIM door. Your Vertu Constellation should only be serviced by Vertu authorised personnel.
- Do not mishandle or abuse your Vertu Constellation.
- Use only Vertu approved accessories.
- The supplied chargers are only intended for use with your Vertu Constellation. Do not use them with any other device, as this could result in permanent damage to the phone, battery, or charger.
- Keep your Vertu Constellation and all parts and accessories out of the reach of small children and pets.
- Do not allow your Vertu Constellation or accessories to come into contact with liquids or moisture, or dust and dirt.
- Do not expose your Vertu Constellation to extreme temperatures, as these may cause the battery to stop working temporarily. Performance is particularly limited in temperatures well below freezing.
- Do not apply paint or other similar substances to your Vertu Constellation.

- Only use a soft, clean cloth to clean your Vertu Constellation. Do not use chemicals, detergents, abrasive substances, or any liquids. Use a cotton swab to clean the camera lens.

Interference

- If interference affects the performance of your Vertu Constellation, move away from the source of the interference.

Battery

- Your Vertu Constellation has an internal, non-removable battery. Do not attempt to take it out of the phone. You should not leave it connected to the charger and power source for longer than is necessary.

Materials

Your Vertu Constellation has been crafted from some of the finest materials, and care needs to be taken to keep it in good condition.

- Do not drop, knock, or rub your Vertu Constellation on or against hard surfaces.
- Ceramics and sapphire are very hard materials, but are also brittle and can be scratched by harder materials or objects. They can also be damaged if dropped. Therefore, avoid contact with hard materials such as diamond jewellery, nail files, abrasives, and mineral crystals.
- All leather can be damaged and should be treated with care. Therefore, avoid exposing your Vertu Constellation to extreme temperatures or water and high humidity, and avoid contact with oily substances, make-up, and solvents.
- Vertu metals are finished to a high standard, and care needs to be taken to maintain their appearance. Therefore, you should avoid contact with sharp objects, metal polishes, and chemicals such as solvents, alkaline and acid solutions, cola-based drinks, and salt water. If contact occurs, wipe the surface with a clean, soft cloth as soon as possible.

Keys and parts

Top

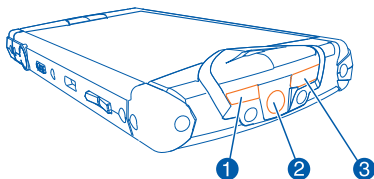

- 1 Power key

- 2 AV connector
- 3 Ambient light sensor

Front

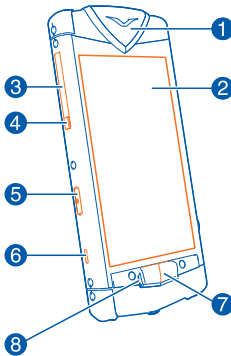

- 1 Pillow
- 2 Display
- 3 SIM door
- 4 SIM door hinge
- 5 Concierge key
- 6 Lanyard hook
- 7 Menu key
- 8 Notification light

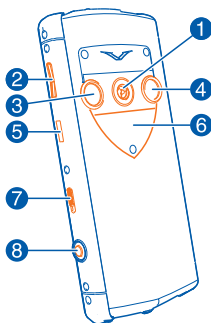
Back

- 1 Loudspeaker
- 2 Volume keys
- 3 Camera lens
- 4 Camera flash
- 5 Micro-USB connector
- 6 Backplate showing the Vertu serial number
- 7 Key lock switch
- 8 Camera key

Get started

Package contents

- Vertu Constellation phone
- Leather phone pouch
- Wired stereo headset
- Wall charger (AC-31) with regional plugs
- Vertu Portable Power (DC-15V)
- Vertu vehicle charger (DC-7V)
- Micro-USB cable x 2
- AV cable
- Polishing cloth
- User collateral

The package contents may vary slightly in accordance with the materials used in your particular phone and with regional regulations.

Insert or remove the SIM card



Important: Do not use a mini-UICC SIM card, also known as a micro-SIM card, a micro-SIM card with an adapter, or a SIM card that has a mini-UICC cutout (see figure) in this device. A micro SIM card is smaller than the standard SIM card. This device does not support the use of micro-SIM cards and use of incompatible SIM cards may damage the card or the device, and may corrupt data stored on the card.



Follow the instructions carefully, to avoid damaging the SIM card or your Vertu Constellation.

Do not attach any stickers to your SIM card.

Insert the SIM card

- 1 Switch the device off.
- 2 Pull the SIM door outwards from the top of the phone.



Tip: You might want to use your fingernail to do this.

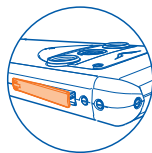

- 3 Fully extend the door.

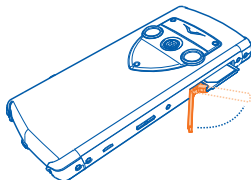

- 4 The SIM drawer automatically slides part way out of the phone. Remove the SIM drawer.

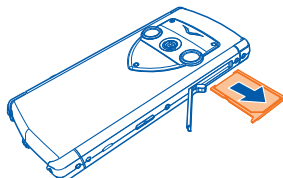

- 5 Insert the SIM card, with the contact area facing up (when the phone is looked at from the back), into the exposed recess of the SIM drawer. Align the card with the slanted corners of the recess.

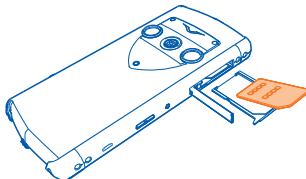

- 6 Fully re-insert the drawer, and close the door.



Tip: If you need to activate and set a PIN code (4-8 digits) for the SIM card, select **Menu > Settings and Phone > Phone management > Security settings > Phone and SIM card**.

Lock or unlock the keys and screen

To avoid accidentally making a call, you can lock the keys and screen of your phone. Slide the key lock switch.

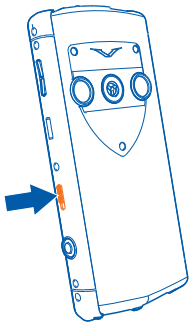

 **Tip:** Alternatively, you can press the power key, and select **Lock screen and keys** or **Unlock**.

Set the keys and screen to lock automatically

- 1 Select **Menu > Settings** and **Phone > Display > Screen/keylock time-out**.
- 2 Define the length of time after which the keys and screen are locked automatically.

Charging

Charge the battery

Your battery has been partially charged at the factory, but you may need to recharge it before you can switch on your phone for the first time. If you use the wall charger, the phone will take about an hour and a half to charge from new.

If the phone indicates a low charge, do the following:

- 1 Connect the supplied wall charger to the wall outlet, and then to the micro-USB connector on your Vertu Constellation.

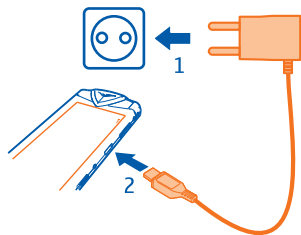

- 2 When the battery is full, disconnect the charger from the phone, and then from the wall outlet.

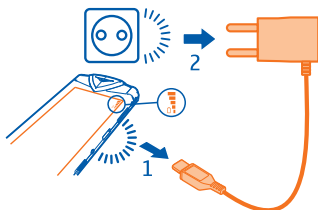

You do not need to charge the battery for a specific length of time. However, if you use the wall charger with a phone that has a low charge, it may take up to two hours for it to charge fully.

You can use the phone while it is charging.

If the battery is completely discharged, it may take several minutes before the charging indicator is displayed or before any calls can be made.



Tip: You can also charge your Vertu Constellation using the Vertu Portable Power and the Vertu vehicle charger, supplied in the sales box.

Charge the battery over USB

You can use the USB cable to connect your Vertu Constellation to your computer.

You can use your phone while it is charging. For example, if it is connected to your computer, you can synchronise your phone.

Charging over USB can take longer to start and you may not be able to use the device immediately.

Do not use a non-powered USB hub.

Your device charges more quickly when connected to the wall charger.

Prolong battery life

There are steps you can take to reduce the power consumption of your phone.

- Always charge the battery fully.
- Activate power saving mode.

Activate power saving mode

Press the power key, and select **Activate power saving**. To deactivate power saving mode, press the power key, and select **Deactivate power saving**.

Close the applications you are not using

Press and hold the menu key, swipe until the desired application is displayed, and select .

Sounds, themes, and effects

- Mute unnecessary tones, such as key tones.
- Use wired headphones, rather than the loudspeaker.
- Change the length of the time-out period after which the device display switches off.

Set the length of the time-out period

Select **Menu > Settings** and **Phone > Display > Light time-out**.

Network use

- If you are listening to music or otherwise using your device, but do not want to make or receive calls, activate the **Offline** profile.
- Set your phone to check for new mail less frequently.
- Use a WLAN connection to connect to the internet, rather than a packet data (GPRS or 3G) connection.

Set your device to use only the GSM network

Select **Menu > Settings** and **Connectivity > Network > Network mode > GSM**.

Deactivate Bluetooth when not needed

Select **Menu > Settings** and **Connectivity > Bluetooth > Bluetooth > Off**.

Stop your device scanning for available WLANs

Select **Menu > Settings** and **Connectivity > WLAN > Options > Settings > Show WLAN availability > Never**.

Establish a packet data (3G or GPRS) connection only when needed

Select **Menu > Settings** and **Connectivity > Admin. settings > Packet data > Packet data connection > When needed**.

Set up your phone

About registration

Vertu aims to provide you with the very best service possible. To enable us to do this, you are strongly advised to register your Vertu Constellation. Once you do this, you get:

- Full access to Vertu's range of personalised services, including Vertu Concierge and Vertu Technical Support.
- Additional home screens, including Vertu Select, that offers content individually tailored to your passions, and Vertu City Brief, that changes as you travel.
- An @vertu.me mail account that you can access at mail.vertu.me.
- Access to Vertu Fortress.



Tip: To view the personalised services to which you have access following registration, select **Menu > Vertu**. You also then have access to options that allow you to rerun the registration application and the setup wizard at any time.

Register your Vertu phone

Normally your Vertu Constellation is registered during the setup process, but you can also register later using any of the following methods:

- Select **Menu > Vertu** and **Registration**.
- Select Call Concierge using the dedicated key.
- Register at www.vertu.me.
- Select any of the Vertu-specific services on the phone.

Set up your phone

- 1 Before you switch on your Vertu Constellation, make sure that you have inserted a valid, active SIM card, and are in a location with cellular data connectivity.
- 2 Start up your Vertu Constellation, and launch the setup wizard.
- 3 The setup wizard takes you through the registration process. Once you have entered your details and accepted the terms and conditions, the Vertu services are automatically activated.

If you decline the terms and conditions, you can still use the phone, but the Vertu services are deactivated.

If you are already a registered customer, enter your username and password.

- 4 Provided that you registered, you are automatically taken through mail setup. An @vertu.me mail account is created for you.

Mail setup

The final part of setup allows you to create mailboxes from a list of mail service providers, including @vertu.me if you have registered.

Select a mail service provider, and enter the requested details. The first mailbox is automatically displayed in the Mail widget on the home screen to the immediate right of the default home screen. This widget gives you quick access to the most recent unread mail. To go to the inbox, select the title bar.

For each subsequent mailbox that you create, you need to add a Mail widget for it on the home screen of your choice.



Tip: To add a new mailbox into an existing Mail widget, select  on the top right of the widget. Select **Create new mailbox**, and follow the displayed instructions. The new mailbox replaces the previous mailbox inside the widget.

Your Vertu Constellation has full compatibility with Microsoft Exchange Server, allowing you to configure one of your mail accounts as a Mail for Exchange mailbox. This gives you mobile access to the mail, calendar, contacts, and tasks on the account, with the option to keep content fully synchronised.

You are asked during mail setup whether you want your corporate account to be used as your Mail for Exchange mailbox. If you decide against this, a list of alternative mail providers is displayed. If you select Vertu Mail from this list, your @vertu.me account is used as your Mail for Exchange mailbox. Alternatively, you can select another compatible provider from the list and then select Mail for Exchange (instead of POP/IMAP) when setting up the mailbox.

You can add further mailboxes as required. For each subsequent mailbox that you create, you need to add a mail widget to the customisable home screen of your choice.

Setup wizard

If you wish to change your registration details, or modify any of the settings on your Vertu Constellation, you can run the setup wizard again.

To access the setup wizard, select **Menu > Vertu > Sett. wizard**.

Transfer content from your old phone

You can use the Phone switch application to copy contacts, calendar entries, and pictures from your previous compatible phone to your Vertu Constellation.

Select **Menu > Settings and Connectivity > Data transfer > Phone switch**.

You can also use PC Suite to transfer pictures, sound clips, and other media files, as follows:

- 1 Transfer the required content from your old phone to your PC or Mac using a USB connection.

- 2 Install **PC Suite** on your PC or Mac.
- 3 Make sure that **PC Suite** locates the required content on your PC or Mac.
- 4 Select **Menu > Settings and Connectivity > USB > PC Suite**.
- 5 Transfer the files from **PC Suite** on your PC or Mac to your Vertu Constellation.
You can use a USB connection or Bluetooth.

You can also transfer files in the opposite direction when you want to back up the new files that you create on your Vertu Constellation.

If you do not want to use PC Suite to transfer files to and from your PC, and would rather do it manually, use Mass storage mode. Your Vertu Constellation is then seen as an external drive on the PC or Mac.

When Mass storage mode is selected, you are not able to see or run applications that you have installed on the internal memory card.

Touchscreen actions

To interact with the user interface, tap or tap and hold the touchscreen.

Open an application or other screen element

Tap the application or element.

Access functions quickly

Tap and hold the item. A pop-up menu with available options opens. For example, to send a picture or delete an alarm, tap and hold the picture or alarm, and from the pop-up menu, select the appropriate option.



Drag an item

Tap and hold the item, and slide your finger across the screen. The item follows your finger.



You can drag items on the home screen or in the main menu, when you have activated editing mode.

Swipe

Place a finger on the screen, and steadily slide your finger in the desired direction.



For example, when you are viewing a picture, to view the next picture, swipe left.

Scroll in a list or menu

Place your finger on the screen, slide it quickly up or down the screen, and then lift your finger. The content of the screen scrolls with the speed and direction it had at the moment of release. To select an item from a scrolling list and to stop the movement, tap the item.



Zoom in

Place two fingers on an item, such as a picture or web page, and slide your fingers apart.

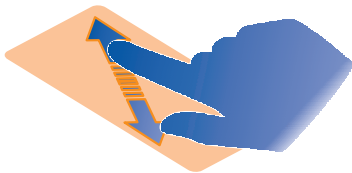

Zoom out

Place two fingers on the item, and slide your fingers together.

 **Tip:** You can also tap the item twice to zoom in and out from the default zoom setting.



Change the volume of a call, song, or video

Use the volume keys.

You can adjust the volume during a call or when an application is active.

The built-in loudspeaker allows you to speak and listen from a short distance without having to hold the phone to your ear.

Activate or deactivate the loudspeaker during a call

Select  or .

Antenna locations

Avoid touching the antenna area while the antenna is in use. Contact with antennas affects the communication quality and may reduce battery life due to higher power level during operation.

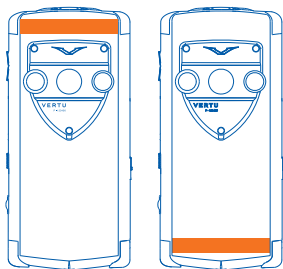

The antenna area is highlighted.

Attach a lanyard

A lanyard is an accessory that is available separately.

Pull out the lanyard hook from the side of the phone using your fingernail, and thread the lanyard through the hook.

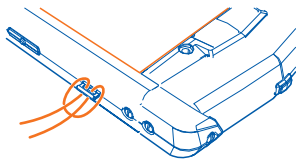

Headset

You can connect a compatible headset or compatible headphones to your phone.

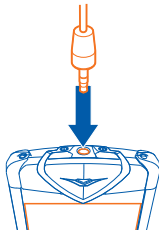

Switch the phone on or off

Switch on

Press and hold the power key until the phone vibrates.

Switch off

Press and hold the power key.

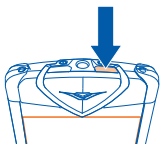

If your phone stops responding

Press and hold down the power key for about 8 seconds, until the phone vibrates and switches off.

Switch the phone back on if necessary.

No content, such as contacts or messages, is deleted.

Vertu services

Vertu City Brief

Vertu City Brief is made up of a series of independently written and uniquely sourced guides to more than 200 key cities around the world. It is available in a variety of languages, including English, Italian, German, French, Russian, Japanese, Chinese and Arabic.

Vertu City Brief is available on your Vertu Constellation as an additional home screen, once you have registered the phone.

The City Brief notification widget is activated on the default home screen to let you know whenever a new City Brief is available for the location to which you have travelled.

The content of the Vertu City Brief home screen changes as you travel, with the relevant guide being presented to you when you arrive at a particular destination, offering suggestions on where to eat, drink and visit during your stay.

Vertu City Brief is integrated with Vertu Concierge, so you can make phone or mail bookings through Concierge when you see things that are of interest.

Vertu City Brief is updated regularly, so you can always be confident the information is accurate and relevant. New destinations are added on a regular basis.



Tip: To deactivate Vertu City Brief, select **Menu > Settings and Vertu Settings**.

Vertu Select

Vertu Select delivers original articles selected to inspire, inform, and entertain you, based on your region, preferences, and passions.

Written by selected experts, Vertu Select is available on your Vertu Constellation as an additional home screen, once you have registered your Vertu Constellation. The content is often linked to exclusive offers accessed through Vertu Concierge.



Tip: To deactivate Vertu Select, select **Menu > Settings and Vertu Settings**.

Vertu Concierge

Concierge is a lifestyle assistance service, available globally 24/7 in your preferred language.

Your Vertu Constellation comes with 12 months complimentary access to this service, once you have registered your phone.

Concierge provides you with access to Vertu Technical Support, which is also available 24/7.

Your Concierge experience begins with a personalised call, designed to:

- Introduce you to the service.
- Understand your needs.
- Record your preferences.

This makes sure that your relationship with Concierge is a rich and rewarding one, satisfying your needs, and providing you with unique opportunities.



Tip: Concierge Live allows you to monitor the progress of your Concierge tasks.

Contact Vertu Concierge

- 1 Press the Concierge key on the left side of your phone.

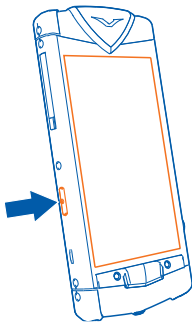

- 2 Select **Call Concierge** or **Email Concierge**.



Tip: If you are unable to contact Vertu Concierge using your dedicated button, please call Vertu Technical Support for assistance in resolving this.

Contact Vertu Technical Support

Should you require technical help using your Vertu Constellation, contact Vertu Technical Support using the Concierge key. Vertu Technical Support is available 24 hours a day, 7 days a week.

- 1 Press the Concierge key.
- 2 Select **Call Technical Support**.



Tip: If you are unable to contact Technical Support using the Concierge key, call +441252867500. For local numbers, go to www.vertu.com.

Vertu Fortress

Your Vertu Constellation comes with 12 months complimentary use of the Vertu Fortress synchronisation service. This backs up the photos and videos on your phone. The media files are encrypted during transmission using HTTPS (Hypertext Transfer Protocol Secure). Data is stored using the 256-bit AES (Advanced Encryption Standard).

The data is synchronised with a cloud-based server. You can view the data on the Web portal at www.vertu.me.

Vertu Fortress is set to synchronise manually by default, but it can also be set to synchronise automatically.

Remote Assist

Provided that Vertu has your consent, the Remote Assist service enables Vertu's Technical Support team to access your Vertu Constellation remotely.

The service is intended to assist you if you have problems setting up or using your phone.

Please contact Technical Support if you wish to use the service.

Vertu Concierge Live

Vertu Concierge Live allows you to monitor the status of your current requests with Concierge. You can also call Concierge direct from the Concierge Live screen.

To find out the status of your Concierge requests, press the **Concierge** key, and select **Concierge Live**.

Home screen

Interactive home screen elements

About the default home screen

The default home screen acts as a gateway to the functions on your Vertu Constellation:

- Additional home screens – two to the left of the default view that are dedicated to Vertu Select and Vertu City Brief, and two to the right that provide access to the initial mailbox and the application quick launch widget. The two screens to the right of the default home screen are fully customisable so that you can add the applications and shortcuts that you use the most. You can also add a sixth, blank, home screen that is fully customisable.

When you are travelling, and wish to avoid roaming charges, to deactivate Vertu Select or Vertu City Brief, select **Menu > Settings and Vertu Settings**.

- The three most commonly used profiles – Silent, Offline, and General. To change the profile, select the profile icon in the top left of the default view, and select a different profile.
- Connectivity and WLANs in the top right of the screen.
- Four shortcuts at the bottom of the screen that give you access to Contacts, Calendar, Messaging, and Web.
- Instant notifications of new mail, messages, and missed calls.

The default home screen has an interactive clock that automatically detects your current time and availability, and provides access to your alarms and appointments. If you are away from your regular time zone, the time at home is also shown on the clock face, in digital format. Your current appointments are indicated by the arcs around the clock, and your current alarms are indicated by red markers.



Tip: When you select a quadrant on the clock that contains one or more appointments, the appointments are displayed in a pop-up window. Select the required appointment to access the calendar.

The menu key for the selection of other functions is situated centrally just below the display.

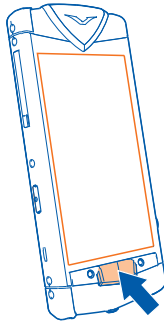

To access the options relevant to your current screen, select **Options**.

To open the dialler, select **Call**.

Switch between home screens

Swipe left or right.



● ● ● ● ● indicates your current home screen. Press the dots to return to the default home screen.

Switch between open applications

You can see which applications and tasks are open in the background, and switch between them.

Press and hold the menu key to open the task switcher, swipe left or right, and select the desired application.

Applications running in the background increase the demand on battery power and use memory. To close an application that you are not using, select .



Tip: To close all open applications, select and hold the task switcher, and from the pop-up menu, select **Close all**.

Notifications

There are a number of means by which your Vertu Constellation notifies you of missed events.

Notification pane — This is displayed when you select the area in the top right hand corner of the screen. It displays events such as available WLANs, missed calls, and new messages.

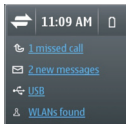

Notification pop-up — A Notification pop-up is displayed on the home screen to show missed calls, messages, voice mail, and calendar events.

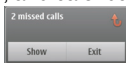

Notification widget — You can add a Notification widget to one of your home screen views. This displays your missed events.

If you add the Notification widget to your home screen, the Notification pop-up is no longer displayed.

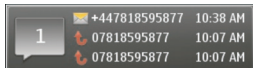

Notification light — This light on the left of the menu key flashes blue when you have a missed call or a new message. To define the events for which the light flashes, select **Menu > Settings** and **Phone > Notification lights > Notification light**.

The notification light flashes red when your battery needs recharging. The light flashes green when the battery is charging, and turns a steady green once charging is complete.



Tip: You can set the notification light to become a breathing light when the phone is not being used. Select **Menu > Settings** and **Phone > Notification lights > Standby breathing light > On**.

Menu key and soft keys

The menu key is the physical key situated centrally just below the display.

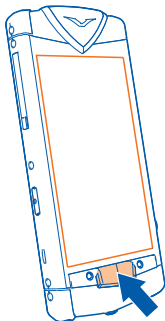

Press the menu key to access the main menu, or to return to the home screen from an application.

Press and hold the menu key to view which applications are open.

There are two context-sensitive soft keys located above the menu key. They display context options relating only to the current screen. Select the relevant soft key to open a menu or perform an action.

 **Tip:** ● ● ● ● ● ● above the Menu key indicates the number of home screens, up to a maximum of six. The highlighted dot indicates the current home screen. Press the dots to return to the default home screen.

Clock

Analogue and digital clock

The clock, displayed on the default home screen, does the following:

- Displays time and date in either analogue or digital format.
- Displays alarms set for the next 12 hours (analogue display only).
- Displays free and busy periods taken from the Calendar, around the clock bezel (analogue display only).
- Maintains time using the automatic time feature.
- Displays the local time or, if you are roaming, displays both the local time and the time in your home location.

Work with the clock as follows:

- To set an alarm, tap the centre of the clock.
- To display an appointment preview pop-up, tap the appropriate quadrant of the clock. Tap the pop-up to open the appointment.

- To remove the appointment pop-up, tap the screen again.

Switch between analogue and digital display

- 1 On the default home screen, select the clock.
- 2 In the Clock panel, tap the image of the clock to toggle the display between digital and analogue format.
- 3 Select **Exit** to return to the default home screen, which now shows the clock in the selected format.

View calendar appointments

The calendar entries for each day are indicated by arcs around the edges of the analogue clock on the default home screen.

To view or amend the entries, tap the relevant quadrant on the clock, and then tap the individual entries on the resultant pop-up.

Set an alarm

Alarms are set from the clock. Alarms can be repeated daily, weekly, or on workdays, or not repeated. A number of alarms can be set.

On the default home screen, select the centre of the clock.

Once an alarm has been set, it is indicated by a red marker on the analogue clock.

- 1 Select **New alarm**, and set the time for the alarm.
- 2 Change the description for the alarm if appropriate, and set the alarm to be repeated, if required.
- 3 Select **Done**.

Change an alarm

Select the alarm, and modify the settings as required.

Activate or deactivate an alarm

Select and hold the alarm, and from the pop-up menu, select the appropriate option. This applies only to repeat alarms.

Delete an alarm

Select and hold the alarm, and from the pop-up menu, select **Delete alarm**.

Snooze an alarm

When an alarm sounds, you can snooze the alarm. This pauses the alarm for a defined length of time.

When the alarm sounds, select **Snooze**.

Set the length of the snooze time

- 1 On the home screen, select the clock.

- 2 Select **Options** > **Settings** > **Alarm snooze time**, and set the length of time.



Tip: You can snooze alarms also by turning your phone face down.

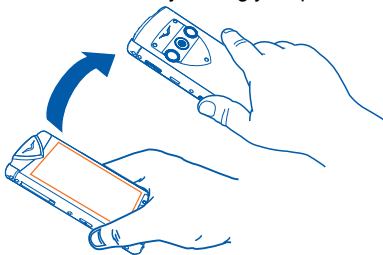

Activate turning control for snoozing

Select **Menu** > **Settings** and **Phone** > **Sensor settings** > **Silence alarms** > **On**.

Select an alarm tone

You can select a tone that applies to all alarms.

On the default home screen, select the centre of the clock.

- 1 Select **Options** > **Settings**.
- 2 Select **Clock alarm tone** and a tone.
- 3 Select **Back** > **Exit**.

World clock

The world clock allows you to see the times at different locations around the world.

View the world clock

- 1 On the default home screen, select the clock and the Clock panel displays.
- 2 Open the World clock tab, and the times at any selected locations are displayed in digital format.

Add a specific location to the world clock

- 1 With the World clock open, select **Options** > **Add location**.
- 2 Move through the list and select the location, which is displayed along with the current time at that location.

Edit locations

Change the picture associated with a location

Select and hold the location, and from the pop-up menu, select **Change image**.

Set a location as the current location

Select and hold the location, and from the pop-up menu, select **Set as current location**.

Remove a location

Select and hold the location, and from the pop-up menu, select **Remove**.

Automatic time

With the Automatic time feature, you do not need to set the time or date manually when you travel to another time zone, provided that the SIM card remains present in the phone.

When activated, the feature sets the system clock to the local coordinated universal time (UTC) value. The GMT offsets from this value are applied automatically. Also, two clocks are displayed on the default home screen when you travel away from your home location time zone:

- The main clock detects your current time.
- The clock towards the bottom of the display displays the time at your home location, in digital format.

When you return to your home location, the clock switches back to the single display, showing only the current time.

Activate Automatic time

Select **Menu > Settings** and **Phone > Time and date > Automatic time update > On**.



Tip: To set the time when Automatic time is deactivated, select **Menu > Settings** and **Phone > Time and date > Time**, and set the time.

Use the calendar

Select **Menu > Calendar**.

You can do the following:

- Synchronise your phone calendar with the Mail for Exchange account of your choice (you first need to set up the corresponding Mail for Exchange mailbox on the phone).
- Track your appointments.
- Add reminders for significant dates.
- Keep your to-do list up to date.

Add a new appointment

1 Select **Options > New entry**.

- 2 Select the calendar to which the entry is to be saved.
- 3 Select the entry type:
 - **Meeting request** (provided that you have synchronised with Mail for Exchange)
 - **Meeting** (for important appointments)
 - **Anniversary** (for entries that are repeated annually)
 - **To-do note**
- 4 The remainder of the fields are determined by the type of entry specified in the previous step. Complete as required, and select **Done**.



Tip: You can browse your calendar entries in different views. To check all the entries for a particular week or month at a glance, select **Options > Change view**. A calendar's colour code allows you to pick out its entries in any view.

In the Calendar application, you can create separate calendars to better manage your appointments. You can, for example, use separate calendars for work and leisure.

Add a new calendar

- 1 Select **Options > Manage calendars**.
- 2 Select **Options > Create new calendar**.
- 3 Enter a name and colour for the calendar, and define if you want to display or hide the calendar. When a calendar is hidden, the calendar entries and reminders are not displayed in the different calendar views.
- 4 Select **Done**.



Tip: To display, hide, or delete a calendar, select **Options > Manage calendars**, select and hold the calendar, and from the pop-up menu, select the appropriate option.

Modify the home screen

Personalise a home screen

You can use stand-alone mini-applications called widgets to provide quick and easy access to your most frequently used applications.

You can add widgets directly to any of the customisable home screens.

Rearrange the items on the current home screen

- 1 On the current home screen, select **Options > Edit Home screen**. The **+** icon above the menu key indicates that Edit mode is active.
- 2 To rearrange the widgets, drag and drop them as required.



- 3 Select **Done**.

Work with widgets

Add a widget to a home screen

- 1 Move to the customisable home screen to which the widget is to be added.
- 2 Select **Options > Edit Home screen**. The + icon above the menu key indicates that Edit mode is active.
- 3 To add a widget, select the + icon.
- 4 Select the required widget, which is added to the screen. If there is not enough room, you are asked to remove some existing widgets.
To add an application from Ovi Store, select the Store icon directly above the menu key.
All added applications appear in the application quick launch widget on the second home screen to the right of the default home screen. Within this application, there are tabs for the most recently used and the most recently installed applications.
- 5 Select **Done**.

 **Tip:** To add your most frequently used contacts to one of the customisable home screens, add the Favourites widget. Swipe left or right to access any contacts that are not immediately visible in the widget.

Remove a widget

- 1 Make sure that Edit mode is active.
- 2 Select the widget, and from the pop-up menu, select **Remove**.

Add a row of application shortcuts to a home screen

- 1 Move to the customisable home screen to which the widget is to be added.
- 2 Select **Options > Edit Home screen**. The + icon above the menu key indicates that Edit mode is active.
- 3 To add a widget, select the + icon.

- 4 Select the Shortcuts widget, which is added to the screen. If there is not enough room, you are asked to remove some existing widgets. A single row of four shortcuts appears on the screen.
- 5 Select the widget and, from the pop-up menu, select **Settings**.
- 6 For the required shortcut, select **Manage**, and define whether the shortcut is to a Application or Bookmark.
- 7 Select the required application or bookmark.
- 8 Repeat the previous step to customise further shortcuts.
- 9 Once you have customised all the required shortcuts, select **Done**.

Add or remove a home screen

You can have a maximum of six home screens at any one time. If you have all six screens, you need to remove one screen before adding another.

All home screens other than the default home screen, Vertu City Brief, and Vertu Select, are fully customisable, and as such, can be removed.

Add a customisable home screen

Select **Options** > **New Home screen** > **Done**.

Remove the current customisable home screen

Select **Options** > **Delete Home screen**, and when prompted, select **Yes**.

If you remove a home screen, all the widgets on it are also removed. However, the underlying mail accounts, calendar, and other widgets, will remain on the phone, so that you can add them to other customisable home screens.

Add your important contacts to the home screen

You can use the **Favourites** widget to add your most frequently used contacts to one of the customisable home screens, so you can quickly call or send messages to them. Swipe left or right to access any contacts that are not immediately visible in the widget. The contacts need to be stored in your phone memory.

- 1 Add the **Favourites** widget to the customisable home screen of your choice.
- 2 Select the widget, followed by a contact.
- 3 Select **OK**.

Call or send a message to a contact

- 1 In the widget, select the contact.
- 2 Select **Voice call** or **Message**.

Remove a contact from the home screen

- 1 In the widget, select **Remove** and the contact to remove.

2 Select **OK**.

The contact is deleted from the widget, but remains in your contacts list.



Write text

Enter text using Swype™

The Swype keyboard is displayed by default whenever typed input is required. It is displayed in your country's native text input format, for example, QWERTY, in both portrait and landscape modes.

With Swype, you can enter text quickly and easily, using a single, continuous finger movement across the keyboard. Simply hold a finger down and slide it through the letters of each word.

If you do not want to use the Swype movement to enter words, you can still enter text by tapping the letters on the keyboard.

 **Tip:** Before you start using Swype, select **Menu > Settings** and **Phone > Swype**. You can then modify, as required, the settings for writing language and predictive text input before you start entering text. On the Swype keyboard, to access the same settings, select .



- 1 Close key - Close the keyboard, entering what you have typed.
- 2 Arrow keys - Move the cursor left or right.
- 3 Options key - Cut, copy, or paste text, insert symbols and emoticons, modify text input settings, and access the Swype user guide.
- 4 Shift and caps lock key - To enter an upper case character when writing in lower case, or vice versa, select the key, and then select the desired character. To activate caps lock, select the key twice.
Alternatively, slide from the letter to be capitalised, to a position off the top of the keyboard, and then continue entering the rest of the word.
- 5 Swype key - Displays alternatives to the word nearest the cursor.
Press and hold the key for tips and instructions on using Swype.
- 6 Character format key - Switch between numeric and text input formats.

- 7 Space bar - Swype automatically inserts spaces for you, but you can use this key to insert additional spaces.
- 8 Enter key - Move the cursor to the next row or text input field. Additional functions are based on the current context. For example, in the web address field of the web browser, it acts as the Go icon.
- 9 Backspace key - Deletes a character.

Change language

Press and hold **Q**, and select the language.

Add an accent to a character

Slide your finger through all the letters for the word in the appropriate language, without concern for the accents. Usually, Swype recognises the word and correctly accents the letters.

Repeat a letter

Make a small circle on the letter that you want to repeat.

Swype and the Swype logos are trademarks of Swype, Inc. © 2009-2011 Swype, Inc. All rights reserved.

Enter text with the virtual keyboard

Use the standard keyboard

This keyboard is displayed when Swype is deactivated. To enter text, tap the letters on the keyboard.

- 1 To deactivate Swype, select  > **Settings** > **Swype Input Method** > **No**.
- 2 Restart the phone.

The keyboard is displayed in your country's native text input format, for example, QWERTY, in both portrait and landscape modes.

 **Tip:** You may find it easier to use this keyboard in landscape mode.

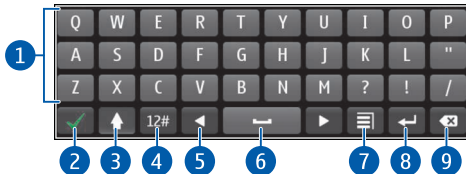

- 1 Virtual keyboard
- 2 Close key - Close the keyboard, entering what you have typed.

- 3 Shift and caps lock key - To enter an upper case character when writing in lower case, or vice versa, select the key before entering the character. To activate caps lock mode, select the key twice.
- 4 Character format key - Switch between numeric and text input formats.
- 5 Arrow keys - Move the cursor left or right.
- 6 Space bar - Insert a space.
- 7 Options key - Cut, copy, or paste text, insert symbols and emoticons, and modify text input settings.
- 8 Enter key - Move the cursor to the next row or text input field. Additional functions are based on the current context. For example, in the web address field of the web browser, it acts as the Go icon.
- 9 Backspace key - Delete a character.

Add an accent to a character

Select and hold the character.

Activate predictive text input with the virtual keyboard

Predictive text input is based on a built-in dictionary to which you can add new words. It is not available in all languages, and is deactivated by default.

When predictive text input is activated, start writing a word, and your phone suggests possible words as you write. When the correct word is displayed, select the word. If the word is not in the dictionary, the phone suggests an alternative word from the dictionary. To add the new word to the dictionary, select the word you have written.

Predictive text input only applies to text that you enter by tapping the keys. When you use Swype, and there is any doubt over a word, you are automatically offered alternatives from the dictionary for the selected language.

Activate or deactivate predictive text input with the Swype keyboard

Select  > **Settings** > **Word prediction** > **Word suggestion** > **Yes** or **No**.

To return to the keyboard, select **Back**.

Activate or deactivate predictive text input with the standard keyboard

Select  > **Input options** > **Activate prediction** or **Deactivate prediction**.

Modify the text input settings for the Swype keyboard

Select  > **Settings**.

Modify the text input settings for the standard keyboard

Select  > **Input options** > **Settings**.

Enter text with the virtual keypad

Use the virtual keypad

If you prefer to use the alphanumeric keypad when writing in portrait mode, you can switch from the virtual keyboard to the virtual keypad.

- 1 Select a text input field.
- 2 Select  > **Alphanumeric keypad**.

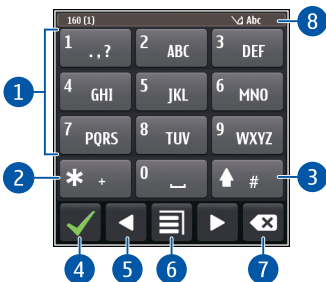

- 1 Number keys
- 2 * - Enter a special character, or when predictive text input mode is activated and the word underlined, cycle through the word candidates.
- 3 Shift key - Change the character case. To activate or deactivate predictive text input mode, quickly select the key twice. To switch between the letter and number modes, select and hold the key.
- 4 Close key - Close the virtual keypad.
- 5 Arrow keys - Move the cursor left or right.
- 6 Input menu - Activate predictive text input, change the writing language, or switch to the virtual keyboard.
- 7 Backspace key - Delete a character.
- 8 Text input indicator (if available) - Indicates the character case, and if letter or number mode or predictive text input mode is activated.

Activate traditional text input with the virtual keypad

Quickly select # twice.

Enter a character

- 1 Select a number key (1-9) repeatedly, until the desired character is displayed. There are more characters available than are visible on the key.

-
- 2 If the next letter is located on the same key, wait until the cursor is displayed or move the cursor forward, and select the key again.

Insert a space

Select **0**.

Move the cursor to the next line

Quickly select **0** three times.

Activate predictive text input with the virtual keypad

Predictive text input is not available for all languages.

- 1 Select  > **Activate predictive text**.
- 2 To write the desired word, use the keys 2-9. Select each key once for each letter. The word suggestion changes after each key selection.
- 3 If the word is not correct, select * repeatedly, until the correct match is displayed. If the word is not in the dictionary, select **Spell**, and enter the word using traditional text input mode, and select **OK**.
If ? is displayed after the word, the word is not in the dictionary. To add a word to the dictionary, select *, enter the word using traditional text input mode, and select **OK**.
- 4 To insert a space, select **0**. To insert a common punctuation mark, select **1**, and then select * repeatedly, until the correct punctuation mark is displayed.
- 5 Start writing the next word.

Deactivate predictive text input

Quickly select # twice.

Define the writing language

If you are using the Swype keyboard, press and hold **Q** to change the writing language. Otherwise, proceed in accordance with the steps below.

Change the language prior to using the standard keyboard

Select **Menu** > **Settings** and **Phone** > **Touch input** > **Writing language**.





Change the language while you are using the standard keyboard

Select  > **Input options** > **Writing language** or  > **Writing language**.



The available options may vary.

Display indicators



General indicators

-  The touchscreen and keys are locked.
-  The phone alerts silently for incoming calls or messages.
-  An alarm is set.
-  You have a missed calendar event.

















Call indicators

-  Someone has tried to call you.
-  Incoming calls are diverted to another number (network service).
-  Your phone is ready for an internet call.



Messaging indicators







-  You have unread messages. If the indicator is blinking, your Inbox folder may be full.
-  You have received new mail.
-  Messages are waiting to be sent in the Outbox folder.

Network indicators

-  Your phone is connected to a GSM network (network service).
-  Your phone is connected to a 3G network (network service).
-  A GPRS data connection (network service) is open.  indicates that the connection is on hold and  that a connection is opening or closing.
-  An EGPRS data connection (network service) is open.  indicates that the connection is on hold and  that a connection is being established.
-  A 3G data connection (network service) is open.  indicates that the connection is on hold and  that a connection is being established.
-  An HSPA data connection (network service) is open.  indicates that the connection is on hold and  that a connection is being established.
-  A WLAN connection is available.  indicates that the connection is encrypted and  that the connection is not encrypted.

Connectivity indicators

-  Bluetooth is active.  indicates that your phone is sending data. If the indicator is blinking, your phone is trying to connect to another device.

-  A USB cable is connected to your phone.
-  GPS is active.
-  The phone is synchronising.
-  A compatible headset is connected to your phone.
-  A compatible TV-out cable is connected to your phone.
-  A compatible text phone is connected to your phone.

Set the notification light to blink for missed calls or messages

When the phone notification light blinks, you have missed a call or a message has arrived.

Select **Menu > Settings** and **Phone > Notification lights > Notification light**.

Flashlight

The camera flash can be used as a flashlight. To switch the flashlight on or off, slide and hold the key lock switch for two seconds.

The flashlight can only be used when you are on the home screen. You can switch the flashlight on also when you are on the home screen and the keys and screen or the device is locked.

Do not shine the flashlight in anyone's eyes.

Use your phone offline

In places where you do not want to make or receive calls, you may still access your calendar, contacts list, and offline games if you activate the offline profile. Switch the phone off when mobile phone use is not allowed or when it may cause interference or danger.

On the home screen, select the profile and **Offline**.

When the offline profile is activated, your connection to the cellular network is closed. All radio frequency signals between the phone and the cellular network are prevented. If you try to send a message, it is placed in the Outbox folder, and is sent only when another profile is activated.

You can also use your phone without a SIM card. Switch the phone off, and remove the SIM card. When you switch back on, the offline profile is activated.

 **Important:** In the offline profile you cannot make or receive any calls, or use other features that require cellular network coverage. You may be able to call the official emergency number programmed into your device. To make calls, you must first change to another profile.

When the offline profile is activated, you can still connect to a WLAN to, for example, read your mail or browse the internet. You can also use Bluetooth.

Remember to comply with any applicable safety requirements.

Search in your phone and on the internet

You can search for items, such as messages, pictures, files, music, or videos, that are stored on your phone, and you can also search on the internet.

- 1 Select **Menu > Office > Search**.
- 2 Start entering a search word, and select from the proposed matches.
- 3 To search on the internet, select the internet search link at the end of the search results, and make sure that you have an active internet connection.

If this is your first internet search, you are asked for your default search engine from the list appropriate to your home location.

Personalisation

Profiles

About profiles

▶ Select **Menu** > **Settings** and **Profiles**.

Your Vertu Constellation has a number of profiles that you can activate and personalise for different events and environments. The most commonly used profiles, **General**, **Silent**, and **Offline**, are shown on the default home screen.

You can also add your own profiles.

You can personalise each of the profiles in the following ways:

- Change the ringtones and message alert tones.
- Change the volume of ringtones and key tones.
- Mute key tones and warning tones.
- Activate vibrating alerts.
- Set the phone to say the name of the contact who is calling.

Personalise your tones

You can personalise your phone tones for each profile.

Select **Menu** > **Settings** > **Profiles**.

- 1 Select the desired profile.
- 2 Select **Personalise** and the desired option.

Silence your phone

When the Silent profile is activated, all ringtones and alert tones are muted.

On the default home screen, next to the clock, select the current profile, and then select **Silent**.

Change the profile

You can quickly change the active profile in your Vertu Constellation.

With the clock displaying on the home screen, select the icon at the top left of the clock, and then a **Profile name**.

Create a new profile

How can you make your phone meet your needs at work or college or home? You can create new profiles for different situations, and give them appropriate names.

- 1 Select **Menu** > **Settings** > **Profiles** and **Options** > **Create new**.
- 2 Define your profile settings, and select **Profile name**.

3 Enter a name for the profile.

Calls

Call a phone number

- 1 On the home screen, select **Call** to open the dialler, and enter the phone number.
To enter the + character, used for international calls, select * twice.
- 2 To make the call, press the call key.
- 3 To end the call, press the end key.



Tip: To call a contact, on the home screen, select **Call**, and start entering the contact's name.

Search for a contact

You can search for a contact you have saved in the contacts list.

On the home screen, select **Call**, and start entering the contact's first or second name. You can also search by company name.

When entering the characters, select each number key once for each letter. For example, to search for Vertu, enter **8, 3, 7, 8, and 8**.



Call a found contact

Select the contact.

Send a message to a found contact

Select and hold the contact, and in the contact card, select **Message**.

Activate or deactivate contact search

In the Dialler, select **Options > Contact search > On** or **Off**.

Call a contact

Select **Menu > Contacts**.

- 1 To search for a contact, enter the first letters or characters of the first or second name in the search field.
- 2 Select the contact.
- 3 In the contact card, select **Voice call**.
- 4 If the contact has more than one phone number, select the desired number.

Reject a call

When a call arrives, select .

To send a message explaining why you cannot answer the call, proceed as below.

Send the reject call text message

- 1 When a call arrives, select **Send msg.**, and edit the message.
- 2 To send the message, select .
- 3 Reject the call.

Edit the standard reject call text message

Select **Menu > Settings** and **Calling > Call > Message text**, and write the message.

 **Tip:** You can automatically divert rejected calls to your voice mailbox or another phone number (network service). Select **Menu > Settings** and **Calling > Call divert > Voice calls > If busy > Activate > To voice mailbox** or **To other number**.

Mute a call

You can mute the microphone in your device during a call.

Select the mute icon .

The menu key light changes from white to red flashing when the microphone is muted.

Answer a waiting call

You can answer a call when you have another call in progress. Call waiting is a network service.

Press the call key. The first call is put on hold.

Activate, deactivate, or check the status of the service

Select **Menu > Settings** and **Calling > Call > Call waiting > Activate, Deactivate, or Check status**.

Swap between an active call and a call on hold

Select **Options > Swap**.

Connect the call on hold to the active call

Select **Options** > **Transfer**. You disconnect yourself from the calls.

End an active call

Press the end key.

End both calls

Select **Options** > **End all calls**.

Make a conference call

Your phone supports conference calls between a maximum of six participants, including yourself.

Conference calls are a network service. For details, contact your service provider.



Video conference calls are not supported.

- 1 Make a call to the first participant.
- 2 To make a call to another participant, select **Options** > **New call**. The first call is put on hold.
- 3 When the new call is answered, to add the first participant to the conference call, select .

Add a new participant to a conference call

Make a call to another participant, and add the new call to the conference call.

Have a private conversation with a conference call participant

- 1 Select .
- 2 Go to the participant, and select . The conference call is put on hold on your phone. The other participants continue the conference call.
- 3 To return to the conference call, select .

Drop a participant from a conference call

Select , go to the participant, and select .

End an active conference call

Press the end key.

Call the numbers you use the most

You can quickly call your friends and family when you assign your most-used phone numbers to the number keys of your phone.

Select **Menu** > **Settings** and **Calling** > **Speed dialling**.

Assign a phone number to a number key

- 1 Select the number key to which you want to assign the phone number.
1 is reserved for the voice mailbox.
- 2 Select the phone number from your contacts list.

Remove or change a phone number assigned to a number key

Select and hold the assigned key, and from the pop-up menu, select **Remove** or **Change**.

Make a call

On the home screen, select **Call** to open the dialler, and select and hold the assigned number key.

Make calls over the internet

About internet calls

With the internet call network service, you can make and receive calls over the internet. Internet call services may support calls between computers, between mobile phones, and between a VoIP phone and a traditional telephone.

Some internet call service providers allow free internet calls. For availability and connectivity costs, contact your internet call service provider.

To make or receive an internet call, you must be in the service area of a WLAN or have a packet data connection in a 3G network, and be signed in to an internet call service.

Install an internet call service

- 1 Download an installation widget for the internet call service.
- 2 To start the installation, select the installation widget.
- 3 Follow the displayed instructions.

When an internet call service has been installed, a tab for the service is displayed in the contacts list.

Make an internet call

When you are signed into a internet call service, you can make a call from the friends list or the contacts list.

Select **Menu** > **Contacts**.

Call a contact in the friends list

- 1 Open the internet call service tab, and sign in to a internet call service.
- 2 Select a contact from the friends list, and select **Internet call**.

Make an internet call to a phone number

- 1 To open the dialler, on the home screen, select , and enter the number.
- 2 Select **Options** > **Call** > **Internet call**.



Call the last dialled number

The call log displays information about the calls you have made and received. This makes it easy to call someone again if they are not answering. Simply access the call log and quickly retrieve the number.

In the home screen, select **Call** to open the dialler, and select . To call the last dialled number, select the number from the list.

Record a phone conversation

With the Recorder application, you can record phone conversations.

- 1 During an active voice call, select **Menu** > **Media** > **Recorder**.
- 2 To start recording, select .
- 3 To stop recording, select . The sound clip is automatically saved to the Sound files folder in the File manager application.

Both parties hear a tone at regular intervals during the recording.

Turn to silence

If your device rings in a situation where you do not want to be disturbed, you can turn the device to silence the ringtone.

Activate the turn to silence feature

Select **Menu** > **Settings** and **Phone** > **Sensor settings** > **Silence calls** > **On**.

When your device rings, turn your device display down.

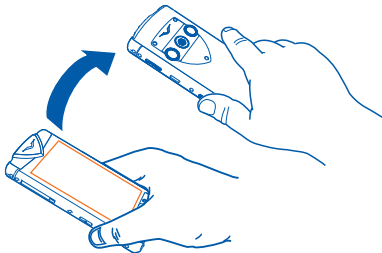



View your missed calls

On the home screen, you can see when you have missed calls. To view the phone number, select **Show**. The caller's name is displayed if stored in the contacts list.

Missed and received calls are logged only if supported by the network, and the phone is switched on and within the network service area.

Call back the contact or number

Select the contact or number.

To view the missed calls list, on the home screen, select **Call** to open the dialler, select , and open the missed calls tab .

Call your voice mailbox

You can divert your incoming calls to your voice mailbox (network service). People can leave you a message, for example, when you have not answered the call.

In the home screen, select **Call** to open the dialler, and select and hold 1.

Change the phone number of your voice mailbox

- 1 Select **Menu > Settings and Calling > Call mailbox**.
- 2 Select and hold a mailbox, and from the pop-up menu, select **Change number**.
- 3 Enter the number (obtained from your network service provider), and select **OK**.

Divert calls to your voice mailbox or another phone number

If you cannot answer your calls, you can divert incoming calls to your voice mailbox or another phone number.

Select **Menu > Settings and Calling > Call divert > Voice calls**.

Call divert is a network service. For details, contact your service provider.

Divert all voice calls to your voice mailbox

Select **All voice calls > Activate > To voice mailbox**.

Divert all voice calls to another phone number

- 1 Select **All voice calls > Activate > To other number**.
 - 2 Enter the number, or select **Find** to use a number saved in your contacts list.
- Several diverting options, such as **If busy** and **If not answered** can be active at the same time.

On the home screen,  indicates that all calls are diverted.

Call barring and call diverting cannot be active at the same time.

Prevent the making or receipt of calls

Sometimes you may want to restrict the calls that can be made or received with your phone. With call barring (network service), you can, for example, restrict all outgoing international calls or incoming calls when you are abroad.

Select **Menu > Settings and Calling > Call barring**.

To modify the settings, you need the barring password from your service provider.

Prevent the making of calls

- 1 If an internet call service is installed, select **Mobile call barring**.
- 2 To prevent making any calls or international calls, select **Outgoing calls** or **International calls**. To prevent making international calls, but allow calls to your home country, select **International calls except to home country**.
- 3 Select **Activate**. Call barring affects all calls originating from your Vertu phone. All or some of the outgoing call barring features may not be available, depending on your SIM card or service provider.

Prevent the receipt of calls

- 1 If an internet call service is installed, select **Mobile call barring**.
- 2 To prevent receiving any calls or international calls when you are abroad, select **Incoming calls** or **Incoming calls when roaming**.
- 3 Select **Activate**. The available options may vary, depending on your SIM card.

Prevent anonymous internet calls

Select **Internet call barring > Anonymous call barring > On**.

Allow calls only to certain numbers

With the fixed dialling service, you can restrict calls, and only allow calls to certain phone numbers. For example, you can allow your children to call only family members or other key numbers.

Select **Menu > Contacts and Options > SIM numbers > Fixed dial contacts**.

Not all SIM cards support the fixed dialling service. You need your PIN2 code from your service provider.

Activate fixed dialling

Select **Options > Activate fixed dialling**. Enter the PIN2 code.

Select the people to whom calls are allowed

- 1 Select **Options > New SIM contact**.
- 2 Enter the PIN2 code.

- 3 Enter the contact name and phone number to which calls are allowed, and select **Done**. To add a contact from the contacts list to the fixed dialling list, select **Add from Contacts** and a contact.

To send a text message to a SIM contact while the fixed dialling service is active, you need to add the text message centre number to the fixed dialling list.

Contacts

About Contacts

 Select **Menu > Contacts**.

With Contacts, you can save and organise your friends' phone numbers, addresses, and other contact information.

Save phone numbers and mail addresses

You can save your friends' phone numbers, mail addresses, and other information to your contacts list.

Select **Menu > Contacts**.

Add a contact to the contacts list

- 1 Select **Options > New contact**.
- 2 Select a field, and enter the details.

Edit contact information

- 1 Select a contact.
- 2 Open the contact card tab .
- 3 Select a contact detail.

Add details about a contact

Select a contact and **Options > Edit > Options > Add detail**.

Save a number from a received call or message

When you receive a call or a message from a person whose phone number is not yet saved in the contacts list, you can save the number in a new or existing contact list entry.

Save a number from a received call

- 1 Select **Menu > Office > Tools > Log**.
- 2 Select **Recent calls > Received calls**.
- 3 Select and hold a phone number, and from the pop-up menu, select **Save to Contacts**.
- 4 Select whether you want to create a new contact list entry or update an existing one.

Save a number or mail address from a received message

- 1 Select **Menu > Messaging**.
- 2 Select **Inbox** and a message.
- 3 Select the phone number and **Save to Contacts**.
- 4 Select whether you want to create a new contact list entry or update an existing one.

Contact your most important people quickly

You can set your most important contacts as favourites. Your favourites are at the top of the contacts list, so you can contact them quickly.

Select **Menu > Contacts**.

Set a contact as a favourite

Select and hold a contact, and from the pop-up menu, select **Add to favourites**.

Remove a contact from favourites

Select and hold a contact, and from the pop-up menu, select **Remove from favourites**. The contact is not deleted from your standard contacts list.

Add a picture for a contact

Want to see quickly who is calling you? Add a picture for a specific contact.

Select **Menu > Contacts** and a contact.

- 1 Select the icon next to the contact's name, and from the pop-up menu, select **Add image**.
- 2 Select a picture from Photos.

Change or remove a picture

Select and hold the picture, and from the pop-up menu, select **Change image** or **Remove image**.

The contacts must be stored in your phone memory. To check which memory is in use, select **Options > Settings > Contacts to display**.

Set a ringing tone for a specific contact

Want to be able to hear that a particular person is calling you? You can set a ringing tone specifically for that person.

Select **Menu > Contacts**.

Set a ringing tone for a contact

- 1 Select a contact and **Options > Edit**.
- 2 Select the Ringtone field and a ringing tone.

Set a ringing tone for a contact group

- 1 Open the Groups tab.
- 2 Select and hold the title of a group, and from the pop-up menu, select **Ringtone**.
- 3 Select a ringing tone from the list.

The ringing tone only applies to the members of the group at the time that the ringing tone is set.

Send your contact information using My Card

My card is your electronic business card. With My card, you can send your contact information to others.

Select **Menu > Contacts**.

Send your contact information as a business card

Select and hold **My card**, and from the pop-up menu, select **Send as business card**.

Edit your contact information in My Card

Select **My card**, and the detail to edit.

Create a contact group

When you have created contact groups, you can send a message to several people at the same time. For example, you can assign the members of your family to one group.

Select **Menu > Contacts**.

- 1 Open the Groups tab.
- 2 Select **Options > New group**.
- 3 Enter a name for the group, and select **OK**.
- 4 Select the group and **Options > Add members**.
- 5 To mark the contacts you want to add to the group, select them.

Send a message to a group of people

Would you like to send a message to all your family members quickly? If you have assigned them to a group, you can send a message to all of them at the same time.

Select **Menu > Contacts**.

- 1 Open the Groups tab.
- 2 Select and hold a group title, and from the pop-up menu, select **Create message**.

Copy contacts from the SIM card to your phone

If you have contacts stored on your SIM card, you can copy them to your phone. You can add more details to contacts that are stored on your phone, such as alternative phone numbers, addresses, or a picture.

Select **Menu > Contacts**.

Select **Options > SIM numbers > Copy all to phone**.



Tip: If you now have a contact twice in your contacts list, select **Options > Settings > Contacts to display**, and clear the **SIM memory** check box.

Office Communicator

Set up Office Communicator

With the Office Communicator application, you synchronise with the Communicator contacts on your PC, so that you can communicate with your colleagues around the world and see their availability.

- 1 Select **Menu > Office and Communicator**.
- 2 Select **Options > Settings**.
- 3 Enter your username and password.
- 4 Enter the web address of the Communicator Web Access server, and define whether you want to connect using the Internet or the Wireless Application Protocol (WAP) service.

If synchronisation is successful using the settings you provided, you are automatically signed in, and your Communicator contacts are synchronised with your PC.

Using the service or downloading content may cause transfer of large amounts of data, which may result in data traffic costs.

Some services may not be available in all countries, and may be provided only in selected languages. The services may be network dependent. For more information, contact your network service provider.

Use Office Communicator

Select **Menu > Office and Communicator**.

Log in to Office Communicator

Log in where indicated. Your settings are validated, and your Communicator contacts are resynchronised.

If you are new to Communicator, select **Options > Help**.

Communicate with a contact

- 1 Select a contact, and select whether you want to send an instant message or a mail to the contact.
- 2 Write and send your message.

Add a contact

- 1 From within a conversation, select **Options > Invite someone**.
- 2 Enter your search word, and select from the proposed matches.

Change your availability

- 1 Select the down arrow next to your name at the top of the Communicator contacts list.
- 2 Select your current availability, for example, **Busy** to indicate that you are in a meeting. Your contact colour changes accordingly.

Messaging

About Messaging

Select **Menu** > **Messaging**.

Messaging requires network support.





Tip: To send a message to a known contact, on the default home screen, select , select and hold the contact, and select **Send message**.

You can send and receive various kinds of messages:

- Text messages
- Audio messages
- Multimedia messages that contain pictures and videos
- Group messages

Send a message

Select **Menu** > **Messaging**.

- 1 Select **New message**.
- 2 To select recipients from the contacts list, select the **To** title. To enter the recipient's phone number manually, enter the number in the **To** field.
- 3 To add an attachment, for example a picture, video, or sound clip, select .
- 4 Select .

Sending a message with an attachment may be more expensive than sending a normal text message. For more information, contact your service provider.

You can send text messages that are longer than the character limit for a single message. Longer messages are sent as two or more messages. Your service provider may charge accordingly.

Characters with accents, other marks, or some language options, take more space, limiting the number of characters that can be sent in a single message.

If the item you insert in a multimedia message is too large for the network, the device may automatically reduce the size.

Only compatible devices can receive and display multimedia messages. Messages may look different in different devices.

Send a message to a contact



Select **Menu** > **Contacts**.

- 1 To search for a contact, enter the first letters or characters of the first or second name in the search field.
- 2 Select the contact.
- 3 In the contact card, select **Message**.
- 4 If the contact has more than one phone number, select and hold **Message**, and select the desired number.

Send an audio message

You can record a sound clip and send it as an audio message.

Select **Menu > Messaging**.

- 1 Select **Options > Create message > Audio message**.
- 2 To record the message, select .
- 3 To select the recipient from the contacts list, select the **To** title. To enter the recipient's phone number manually, enter the number in the **To** field.
- 4 Select .

Receive messages

When you receive a message, you can open it directly from the home screen. Later, you can find the message in the Conversations folder or in the Inbox folder in Messaging.

Select **Menu > Messaging**.

When you receive a message,  and **1 new message** are displayed in the home screen. To open the message, select **Show**. By default, the message is opened in the Conversations view.

Reply to a received message in the Conversations view

Select the text input field at the bottom of the display, write a message, and select .

Open a message in the Inbox folder

Select **Inbox** and a message.

Reply to a received message in the Inbox view

Open a message, and select .

Forward a message in the Inbox view

Open a message, and select .

Save a received multimedia item

Select and hold the item, and from the pop-up menu, select **Save**. The item can be viewed in the corresponding application. For example, to view saved pictures, open Photos.

View a conversation

You can see the messages you have sent to and received from a particular contact from a single view, and continue the conversation from that view.

Select **Menu > Messaging**.

Select **Conversations** and a contact. All messages sent to and received from that contact are displayed.

Reply to a message in a conversation

- 1 Open the conversation.
- 2 Select the text input field at the bottom of the display, and write a message.
- 3 To add attachments or more recipients, select **Options > Add**.
- 4 To send the message, select .

When you send a new message, it is added to the current conversation. If no conversation exists, a new conversation is started.

When you open a received message from the home screen, by default, the message opens in the Conversations view. If you want messages to open in the Inbox view, select **Options > Message view > Inbox**.

Listen to a text message

You can set your phone to read your text messages aloud.

- 1 Select **Menu > Messaging**.
 - 2 Select **Inbox**.
 - 3 Select and hold a message, and from the pop-up menu, select **Listen**.
- Select **Menu > Office > Msg. reader**.

Change the language

Select **Language** and a language.

Download an additional language

Select **Options > Download languages**.

Change the voice

Select . To preview a voice, select and hold the voice, and select **Play voice**.

Change language

You can change the phone language and the language in which you write your messages and mails. You can also activate predictive text input.

Select **Menu > Settings** and **Phone > Language**.

Change the phone language

Select **Phone language**.

Change the writing language

Select **Writing language**.

Activate predictive text input

Select **Predictive text** and the appropriate option.



Tip: Swype has its own settings, which you select using **Settings > Phone** and then **Swype**. You can then amend, as required, the settings for language and word prediction.

The word prediction setting only applies to text that you enter by tapping the keys rather than swiping through the letters.

Mail

About Mail

Select **Menu > Mail**.

If you are a registered customer, you have been supplied with an @vertu.me mail account.

Your Vertu Constellation allows you to configure one of your mail accounts as a Mail for Exchange mailbox. This gives you mobile access to the mail, calendar, contacts, and tasks on the account, with the option to keep content fully synchronised.

You are asked during mail setup whether you want your corporate account to be used as your Mail for Exchange mailbox. If you decline, a list of alternative mail providers is displayed. If you select Vertu Mail from this list, your @vertu.me account is used as your Mail for Exchange mailbox. Alternatively, you can select another compatible provider from the list and then select the **Mail for Exchange** option (instead of POP/IMAP) when setting up the mailbox.

Once security is applied to the Mail for Exchange mailbox, you are prompted to enter a lock code, which you should memorise.

Once you have created a mailbox at initial setup for the account of your choice, the unread mail is automatically displayed in a Vertu mail widget on the home screen to the right of the default home screen. Tap the title bar of the widget to go to the inbox.

You can add further mailboxes as required. For each subsequent mailbox that you create, you need to add a Vertu mail widget to the customisable home screen of your choice.



Tip: Mail contains interactive elements. For example, select and hold a mail to view a pop-up menu allowing you to delete or mark the mail, or move it to another folder.

Set up a mailbox

You can have several active mailboxes on your Vertu Constellation, from a variety of mail service providers. However, you can only have one Mail for Exchange mailbox.

Select **Menu > Mail**.

Add a mailbox

- 1 Select **New mailbox > Start**.
- 2 Select your mail service provider.
- 3 Enter your mail address and password, and any other information requested.
Once the details have been successfully validated, the mailbox opens.

For each mailbox that you create, you will need to add a mail widget for it on the customisable home screen of your choice. To open your mailbox quickly, select the widget title bar.

Remove a mailbox

- 1 Select **Options > Delete mailbox** and the mailbox to remove.
- 2 When prompted, confirm the removal.
- 3 If required, remove the mail widget from the home screen.

You can view the contents of folders within mailboxes, but this varies depending on the mailbox type.

View your Mail for Exchange folders

- 1 With the account open, select **Inbox**. The list of your mail accounts and mail folders is displayed.
- 2 Select **Folders**. The list of all folders in your Mail for Exchange account is displayed.
- 3 Select a folder. The account synchronises and downloads the mails in that folder.

View your IMAP mail account folders

- 1 With the account open, select **Options > Settings** and the mail service provider.
- 2 Select **Sync content > Folder subscriptions**, and mark the folders to be synchronised.
- 3 Close Settings, and return to the mailbox.
- 4 Select **Inbox > Folders**.

Set up a Mail for Exchange mailbox

You can configure one of your mail accounts as a Mail for Exchange mailbox, giving you mobile access to the mail, calendar, contacts, and tasks on the account, with the option to keep content fully synchronised.

The following procedure only applies if you did not set up either your corporate account or your @vertu.me mail account as your Microsoft for Exchange mailbox during mail setup.

- 1 Select **Menu > Mail**.
- 2 Select **New mailbox > Start**.
- 3 Select the required provider from the displayed list. The provider's mail account must be compatible with Microsoft Exchange.
- 4 Select **Mail for Exchange** (instead of POP/IMAP).
- 5 Enter your mail address, password, username, and domain, and select **Next**.

- 6 Select **OK** once you have read the recommendation about synchronising contacts on one account only. Select the feature or features that you want to synchronise, and select **Next**.
- 7 If you want to keep your existing contacts on your phone, select **Keep on phone**. If you want to delete your existing contacts, select **Delete from phone**.
- 8 Once the details have been successfully validated, the mailbox is created.
As part of your PIM security, you are prompted to enter a lock code, which you will also need to enter whenever you switch on or wake up the phone.
- 9 If you wish to display the mailbox in a widget, add a Mail widget for it to the customisable home screen of your choice, and select the Mail for Exchange mailbox when prompted following creation of the widget.

Synchronise your mailbox

Select **Menu > Mail**.

Set the mailbox to synchronise automatically

- 1 Select **Settings**.
- 2 Select the mailbox to synchronise.
- 3 Specify the content to be synchronised, and how often it is to be synchronised.
- 4 If the mailbox selected is **Mail for Exchange**, select **Personal info. manager**.
These settings determine how your mail, calendar, contacts, and tasks are synchronised.

Synchronise manually

Select the mailbox to synchronise and **Options > Send and receive**.

If the mailbox selected is your Microsoft for Exchange mailbox, your mail, calendar, contacts, and tasks are synchronised in accordance with your Personal info. manager settings. If any other sort of mailbox is selected, just your mail is synchronised.

Read mail

You can use your phone to read and reply to mail.

Select **Menu > Mail**.

Read a mail

Select the mail.



Tip: To zoom in or out, place two fingers on the screen, and slide them together or apart.

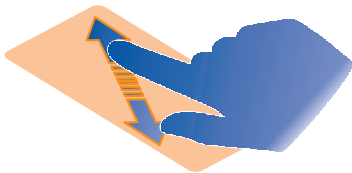

Open or save an attachment

Select the attachment and the appropriate option. If there is more than one attachment, you can save them all at once.

Reply to a mail

Select **Options** > **Reply**.

Forward a mail

Select **Options** > **Forward**.



Tip: If there is a web address in a mail and you would like to open the address in the phone browser, select the address.





Tip: To open the next or previous mail, use the arrow icons.

Send a mail

You can write and send mail, and attach files to your mail.

Select **Menu** > **Mail**.

- 1 Select .
- 2 To add a recipient from your contacts list, select the To, Cc, or Bcc icon. To enter a mail address manually, select the To, Cc, or Bcc field.
- 3 To add an attachment to the mail, select .
- 4 To send the mail, select .

Open mail from a home screen

Once a mailbox has been added to the Vertu mail widget, you have immediate access to your latest unread mail.

A default Vertu mail widget is created for you on the home screen to the right of the default home screen. The first mailbox that you create during mail setup is automatically added to this widget.

The procedure below applies if you are adding a mail widget following creation of your initial mailbox.

Add a mailbox to a mail widget

- 1 Add the Vertu mail widget to the required, customisable home screen.
- 2 Select from the existing mailboxes that you have created, or create a new mailbox.
- 3 If you selected an existing mailbox, go straight to the next step. If you opted to create a new mailbox, you are taken through the mail wizard and asked to enter the appropriate mail address and password.
- 4 The mailbox is associated with the widget. To go to the inbox, select the title bar.



Tip: To switch between mailboxes in the widget, select  on the top right.

Remove a mail widget from the view

- 1 Make sure Edit mode is active.
- 2 Select the widget, and from the pop-up menu, select **Remove**.



Tip: Removing a widget does not remove the associated mailbox. To remove a mailbox, select **Menu > Mail**, select and hold the mailbox, and select **Delete mailbox**.

Calendar

About the calendar

 Select **Menu > Calendar**.

With your device calendar, you can do the following:

- Keep your schedules organised
- Add reminders for anniversaries and other important dates
- Keep your to-do list up to date

You can have separate calendars for free time and work.

Browse your calendar entries in different views

You can browse your calendar entries in different views.

Select the Calendar shortcut on the default home screen.



- 1 Select the date.
- 2 Select **Options > Change view** and the desired view (**Day**, **Week**, or **Month**).
- 3 Swipe left or right to move to the required day, week, or month.

 **Tip:** To increase or decrease the size of the viewable area, place two fingers on the screen, and slide them apart or together.

Add a task to your to-do list

You can add tasks (to-do notes) to your calendar, which can be about any subject that is important to you. For example, if you have a particular deadline, set a reminder.

On the home screen, select the date.

- 1 Select (**Tap to create entry**), or if there are existing entries, tap the area below an entry.
- 2 Select the entry type field , and select **To-do note** as the entry type.
- 3 Fill in the fields.
- 4 To add a reminder for the task, select .
- 5 Select **Done**.

Add a calendar entry

Save your important appointments to your calendar as calendar entries.

Select the Calendar shortcut on the default home screen.

- 1 Select the date.

- 2 Select (**Tap to create entry**), or if there are existing entries, tap the area below an entry.
- 3 Fill in the fields.
- 4 To repeat the calendar entry at regular intervals, select  and the time interval. Select **Repeat until**, and enter the end date.
- 5 Select **Done**.

 **Tip:** You can also add a calendar entry in the day view. Select and hold the starting time, and drag the arrows to set the duration.

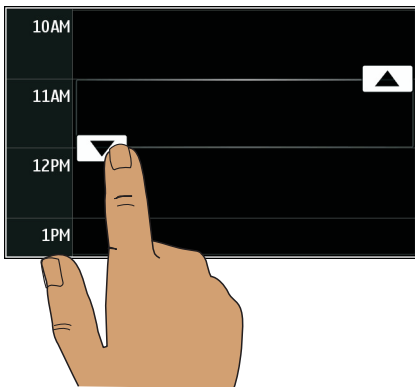

Send a meeting request

You can create meeting requests, and send them to the participants.

Before you can create and send a new meeting request, you need to have set up a mailbox.

Select the Calendar shortcut on the default home screen.

- 1 Select and hold a calendar entry, and from the pop-up menu, select **Send > Via mail**.
- 2 Add the meeting participants as recipients of the request mail.
- 3 To send the request, select .

Remember a birthday

You can add reminders for birthdays, anniversaries, and other annual events. The reminders are repeated annually.

Select the Calendar shortcut on the default home screen.

- 1 Select the date.
- 2 Select **(Tap to create entry)**, or if there are existing entries, tap the area below an entry.
- 3 Select **Meeting > Anniversary** as the entry type.
- 4 Fill in the fields, and select **Done**.

Use separate calendars for work and free time

You can have more than one calendar. Create one for work and another for your free time.

Select the Calendar shortcut on the default home screen.

Create a new calendar

- 1 Select **Options > Manage calendars**.
- 2 Select **Options > Create new calendar**.
- 3 Enter a name, and set a colour code for the calendar.
- 4 Define the visibility for the calendar. When a calendar is hidden, the calendar entries and reminders are not displayed in different calendar views or on the home screen.
- 5 Select **Done**.

Modify the settings for a calendar

- 1 Select **Options > Manage calendars** and the desired calendar.
- 2 Change the name, colour, and visibility.
- 3 Select **Done**.

Add an entry to a particular calendar

- 1 When adding a calendar entry, select  and the calendar.
- 2 Select **Done**.

Colour codes indicate the calendars to which respective entries belong.

Add the location to a calendar entry

If you have an appointment in a place you have never visited, you can add the location information to your calendar entry.

Select the Calendar shortcut on the default home screen.

- 1 Select **(Tap to create entry)**, or if there are existing entries, tap the area below an entry.
- 2 Select  **Add location**, and select the location using the Maps application. You can also manually enter the location in the text field.
- 3 Select **Done**.

Connectivity

Define how your phone connects to the internet

Your phone automatically checks for and connects to an available known network when a network connection is needed. Selection is based on the connection settings, unless there are application-specific settings applied.

Select **Menu > Settings and Connectivity > Settings**.

Automatically switch to a known WLAN connection when available

Select **Switch to WLAN > Known WLANs only**.

You can also connect to WLANs manually using the WLAN wizard application.

Automatically use a packet data connection when in your home network

Select **Data use in home country > On**.

Use a packet data connection when outside your home network

Select **Data use when abroad > On**.

Opening connections when abroad can raise data transfer costs substantially.

If you select **Off** for the packet data connection either when in the home network or when abroad, you can only connect to the network through a WLAN.

Change access point priority for the internet connection

- 1 Select **Destinations > Internet**.
- 2 Select and hold an access point, and from the pop-up menu, select **Change priority**.
- 3 Tap the position in the list to move the access point to.



Example: If a WLAN access point is ranked above a packet data access point in the list, the phone always tries to connect to the WLAN access point first, only connecting to the packet data access point if the WLAN is not available.

Create a new access point

Select **Options > New access point**.

Wireless LAN

About WLAN connections

 Select **Menu > Settings and Connectivity > WLAN**.

The WLAN wizard application helps you connect to a wireless local area network (WLAN) and manage your WLAN connections.



Important: Use encryption to increase the security of your WLAN connection. Using encryption reduces the risk of others accessing your data.



Note: Using WLAN may be restricted in some countries. For example, in France, you are only allowed to use WLAN indoors. For more information, contact your local authorities.

Connect to a WLAN at home

To help save data costs, connect to your home WLAN when you are at home and want to browse the web on your phone.

- 1 Select **Menu > Settings and Connectivity > WLAN**.
- 2 Select and hold your home WLAN, and from the pop-up menu, select **Start web browsing**.

If your home WLAN is secured, enter the passcode. If your home WLAN is hidden, select **Other (hidden netw.)**, and enter the network name (service set identifier, SSID).

Close the WLAN connection

Select and hold the connection, and from the pop-up menu, select **Disconnect WLAN**.

Connect to a WLAN on the move

Connecting to a WLAN is a handy way of accessing the internet when not at home. Connect to public WLANs in public places, such as a library or internet café.

- 1 Select **Menu > Settings and Connectivity > WLAN**.
- 2 Select and hold the desired WLAN connection, and from the pop-up menu, select **Start web browsing**.

Bluetooth

About Bluetooth connectivity



Select **Menu > Settings and Connectivity > Bluetooth**.

With Bluetooth connectivity, you can make a wireless connection to other compatible devices, such as phones, computers, headsets, and car kits.

You can use the connection to send items from your phone, transfer files from your compatible PC, and print files with a compatible printer.

Since devices with Bluetooth wireless technology communicate using radio waves, they do not need to be in direct line-of-sight. However, they must be within 10 metres

(33 feet) of each other, although the connection may be subject to interference from obstructions such as walls or from other electronic devices.

When the phone is locked, only connections to authorised devices are possible.

Connect to a wireless headset

With a wireless headset you can answer a call even if your phone is not directly at hand, and you can have your hands free, for example, to continue working at your computer during a call. Wireless headsets are available separately.

- 1 Select **Menu > Settings and Connectivity > Bluetooth > On**.
- 2 Switch the headset on.
- 3 To pair your phone and the headset, open the **Paired devices** tab.
- 4 Select the headset.
If the headset is not displayed in the list, to search for it, select **Options > New paired device**.
- 5 You may need to enter a passcode. For details, see the user guide of the headset.

Send a picture or other content to another device using Bluetooth

You can use Bluetooth to send pictures, videos, business cards, calendar entries, and other content to your friend's compatible devices and to your computer.

You can have several Bluetooth connections active at a time. For example, if you are connected to a compatible headset, you can also send files to another compatible device at the same time.

- 1 Select and hold the item, for example, a picture. From the pop-up menu, select **Send > Via Bluetooth**.
- 2 Select the device to connect to. If the desired device is not displayed, to search for it, select **More devices**. When searching, Bluetooth devices within range are displayed.
- 3 If the other device requires a passcode, enter the passcode. The passcode, which you can define yourself, must be entered in both devices. The passcode in some devices is fixed. For details, see the user guide of the device.
The passcode is valid only for the current connection.
- 4 If you connect to a device frequently, to set it as authorised, accept the authorisation query **Authorise device to make connections automatically?** when pairing.
When a device is authorised, you do not have to enter the passcode every time.

Connect to a car kit using remote SIM mode

With remote SIM mode, a compatible car kit can use the SIM card of your phone. Select **Menu > Settings and Connectivity > Bluetooth**.

Before remote SIM mode can be activated, your phone and accessory must be paired. Initiate the pairing from the car kit accessory.

- 1 To activate Bluetooth, select **Bluetooth > On**.
- 2 To activate remote SIM mode in your phone, select **Remote SIM mode > On**.
- 3 Activate Bluetooth in the car kit accessory.

When remote SIM mode is activated, **Remote SIM mode** is displayed in the home screen. The connection to the wireless network is closed, and you cannot use SIM card services or features that require cellular network coverage.

To make or receive calls when in remote SIM mode, you need to have a compatible accessory, such as a car kit, connected to your device.

Your device will only allow emergency calls in this mode.

Deactivate remote SIM mode

Press the power key, and select **Exit remote SIM mode**.

Block a device

You can prevent devices from creating a Bluetooth connection to your phone.

Select **Menu > Settings** and **Connectivity > Bluetooth**.

Open the Paired devices tab, select and hold the device you want to block, and from the pop-up menu, select **Block**.

Remove a device from the blocked devices list

Open the Blocked devices tab, select and hold the device you want to remove from the list, and from the pop-up menu, select **Delete**.

If you reject a pairing request from another device, you are asked if you want to add the device to the list of blocked devices.

Protect your phone

When Bluetooth is activated in your phone, you can control who can find and connect to your phone.

Select **Menu > Settings** and **Connectivity > Bluetooth**.

Prevent others from detecting your phone

Select **My phone's visibility > Hidden**.

When your phone is hidden, others cannot detect it. However, paired devices can still connect to your phone.

Deactivate Bluetooth

Select **Bluetooth > Off**.

Do not pair with or accept connection requests from an unknown device. This helps to protect your phone from harmful content.

USB data cable

Copy a picture or other content between your phone and a computer

You can use a USB data cable to copy pictures and other content between your phone and a computer.

- 1 To make sure that Media transfer is set as the USB mode, select **Menu > Settings and Connectivity > USB > Media transfer**.
- 2 Use a compatible USB  data cable to connect your phone to a computer.
The phone is displayed as a portable device on your computer. If Media transfer mode does not work on your computer, use Mass storage mode instead.
- 3 Use the file manager of the computer to copy the content.

Change the USB mode

For the best results when copying content or synchronising your phone with your computer, activate the appropriate USB mode when using a USB data cable to connect to various devices.

Select **Menu > Settings and Connectivity > USB** and from the following:

PC Suite — Connect your phone to a compatible computer that has PC Suite installed. In this mode, you can synchronise your phone with PC Suite and use other PC Suite features.

This mode is activated automatically when you open the PC Suite application.

Mass storage — Connect your phone to a compatible computer that does not have PC Suite installed. Your phone is recognised as a USB flash memory. You can also connect your phone to other devices, such as a home or car stereo, to which you can connect a USB drive.

While connected to a computer in this mode, you may not be able to use some of the phone applications.

The mass memory in your phone cannot be accessed by the other device.

Media transfer — Connect your phone to a compatible computer that does not have PC Suite installed. Music protected by digital rights management (DRM) must be transferred in this mode. Some home entertainment systems and printers can also be used in this mode.

Conn. PC to net — Connect your phone to a compatible computer, and use the phone as a wireless modem. The computer connects to the internet automatically.



Tip: When the USB cable is connected, you can change the USB mode in most views. In the top right corner, select .

Attach an external memory device

Connect a memory stick

- 1 You need a memory stick with a micro-USB connection.
- 2 Insert the memory stick into the micro-USB connector on the Vertu Constellation. It appears as an additional drive on your phone screen.

Store your files on a remote drive

If you want to back up your data or save space on your phone, you can use a remote drive for storing and managing your files.

Select **Menu > Settings and Connectivity > Remote drives**.

You may receive the remote drive settings as a configuration message from your service provider. Open the message, and save the settings.

The service may be chargeable. For information on availability and possible costs, contact your service provider.

Connect to a remote drive

Select and hold the remote drive, and from the pop-up menu, select **Connect**.

Add a new remote drive

- 1 Select **Options > New drive**.
- 2 Enter the name of the remote drive.
- 3 Enter the web address of the remote drive, including the port number.
- 4 To select the access point to use to connect to the remote drive, select **Access point > User defined**. If you select **Ask when needed**, you are prompted for the destination or access point every time the application connects to the network.
- 5 Enter your user name and password, if required by the remote drive service.

Modify the settings of an existing remote drive

Select **Remote drives** and the desired drive.



Use the **File manager** application to access your remote drives and manage stored files.

Close a network connection

If several applications are using an internet connection, you can use the Connection manager application to close some or all network connections.

Select **Menu > Settings** and **Connectivity > Connection manager**.



Select and hold the connection, and from the pop-up menu, select **Disconnect**.

In the active data connections view, you can see your current network connections.  indicates a packet data connection, and  indicates a wireless local area network (WLAN) connection.

View details for a connection

Select and hold the connection, and from the pop-up menu, select **Details**.

Details, such as the amount of transferred data and connection duration, are displayed.

 **Tip:** In most views, to open the Connection manager application, select the notification area in the top right corner and  **> Connection manager**.

Internet

About the web browser

 Select **Menu** > **Web**.

Catch up on the news and visit your favourite websites. You can use your device web browser to view web pages on the internet.

To browse the web, you must have an internet access point configured on your device and be connected to a network.

Browse the web

Select **Menu** > **Web**.

 **Tip:** If you do not have a flat-rate data plan from your service provider, to save data costs in your phone bill, you can use a WLAN to connect to the internet.

Go to a website

Select the web address bar, enter a web address, and select .

 **Tip:** To search the internet, select the web address bar, enter the search word, and select the link below the web address bar.

Zoom in or out

Place two fingers on the screen, and slide your fingers together or apart.

A cache is a memory location that is used to store data temporarily. If you have, or have tried to, access confidential information or a secure service, requiring passwords, clear the cache after each use.



Empty the cache

Select  >  > **Privacy** > **Clear privacy data** > **Cache**.

Add a bookmark

If you visit the same websites all the time, add them to your Bookmarks view, so you can easily access them.

Select **Menu** > **Web**.

While browsing, select  > .

Go to a bookmarked website while browsing

Select  >  and a bookmark.



Subscribe to a web feed

Using web feeds, also known as RSS feeds or media feeds, you no longer have to visit your favourite websites regularly to find out what is going on. Instead, you can subscribe to web feeds, and get links to the latest content automatically.

Select **Menu > Web**.

Web feeds are usually indicated by .

Go to a blog or web page that contains a web feed

Select  >  and the desired feed. The web feed is added to the widget catalogue.

Access registered feeds

Select  >  > **Web feeds** and a feed.

Edit, refresh, delete, or send a web feed

Select and hold the feed, and from the pop-up menu, select the appropriate option.

Add a new feed by entering the web address

In the Web feeds page, select **Options > New feed**, and enter the details.

Update all web feeds

Select .

Set a web feed to automatically update

Select and hold a feed, and from the pop-up menu, select **Edit > Automatic updates**.



When using web feeds, it is recommended that roaming is deactivated when outside your home network. Charges for these feeds may be imposed by the network operator which can vary considerably depending on the operator. Select **Menu > Settings and Connectivity > Settings > Data use when abroad**, and select the appropriate option.

Add a web feed to your home screen

You can add web feeds to any of the customisable home screens for quick viewing. Once you have selected a feed from a web site, it is added directly to your Web feeds page.

- 1 Move to the home screen to which you want to add the web feed, and activate Edit mode.
- 2 Select the + icon to display the available widgets, including the web feeds.
- 3 Select the required web feed.



Tip: You can view all your web feeds from the web browser. Select **Menu > Web** and   **Web feeds**, and select a feed.

Access your company intranet

 You can use your phone to connect to your company intranet.

Select **Menu > Office > Intranet**.

- 1 Select **Options > Settings**. For the relevant settings, contact your system administrator. You must also define a VPN access point.
- 2 Connect to the intranet.



Tip: If you have several intranet destinations, for example, partner extranets, defined in Connection settings, to define which intranet to browse, select **Manual connection**.

Social networks

About Social



Select **Menu > Applications > Social**, and sign in to the social networking services that you use.

To enhance your social networking experience, get Ovi Social. When signed in to social networking services through Social, you can do the following:

- See your friends' status updates from multiple services in one view
- Post your own status update to multiple services at the same time
- Instantly share pictures you take with the camera
- Share videos with your friends
- Link your online friends' profiles to their contact information in your phone
- Add events from the service calendar to your phone calendar

Only those features that are supported by the social networking service are available. Using social networking services requires network support. This may involve the transmission of large amounts of data and related data traffic costs. For information about data transmission charges, contact your service provider.

The social networking services are third-party services and not provided by Vertu. Check the privacy settings of the social networking service you are using as you may share information with a large group of people. The terms of use of the social networking service apply to sharing information on that service. Familiarise yourself with the terms of use and the privacy practices of that service.

See your friends' status updates in one view

When you are signed in to social networking services through the Social application, you can see your friends' status updates from all those services in a single view. You do not have to switch between different applications to see what everyone is up to.

Select **Menu > Applications > Social**.

- 1 Select a service, and sign in.
- 2 Select **Add social network**.
- 3 Select another service, and sign in.
- 4 Select **All Activity**.

All the feeds from the services you have added are automatically included in the view.

Post your status to social networking services

With the Social application, you can post your status update to social networking services.

Select **Menu > Applications > Social**.

Write your status update in the text field.

Link your online friends to their contact information

You can link your online friends' profiles from social networking services to their contact information in your phone. After linking, you can view their contact information directly from the Social application, and see their latest status updates in your contacts list.

Select **Menu > Applications > Social**.

- 1 Select an online friend's profile picture.
- 2 From the pop-up menu, select **Add profile to contact**.
- 3 From your contacts list, select the contact to which to link the profile.

See your friends' status updates on the home screen

When you sign in to social networking services through Ovi by Nokia, you can see your online friends' status updates directly on the home screen.

Browse updates on the home screen

When you are signed into a service, you can see updates in the Social widget.

Open the Social application from the home screen

Select the Social widget. If you are signed in, the status updates view opens. If you are not signed in, the sign-in view opens.

Upload a picture or video to a service

Use the Social application to upload pictures and videos to social networking services.

Select **Menu > Applications > Social**.

- 1 Select .
- 2 Select whether to upload a picture or a video.
- 3 To mark the items to upload, select the items.
The maximum file size is 4 MB for pictures and 10 MB for videos.
- 4 If uploading a single picture, you can add a caption and a tag with a comment to a particular section of the picture.
To upload a video, the feature needs to be supported by the social networking service, and you need to use a WLAN connection.

Take a picture and upload it

- 1 Select .
- 2 Select the option for uploading a picture from the camera.
- 3 Take a picture.
- 4 Add a caption and a tag with a comment to a particular section of the picture.

Contact a friend from a social networking service

When commenting your friend's status is not enough, you can call or send a message to the friend.

Select **Menu > Applications > Social**.

- 1 Select a friend's profile picture.
- 2 From the pop-up menu, select **View contact info**.
- 3 Select a communication method.

This feature is available if you have linked your online friends to their contact information in your phone.

The available communication methods vary. To call or send a text message to a friend, the feature needs to be supported by the service.

Add an event to your device calendar

When responding to invitations to events in a social networking service, you can add the events to your device calendar, so you can view upcoming events even if you are not online.

Select **Menu > Applications > Social** and a service, and sign in.

- 1 Select an invitation to an event.
- 2 Add the event to your device calendar.

This feature is available only if supported by the service.

Camera

About the camera

 Select **Menu > Media > Camera**.

 **Tip:** To activate the camera, you can also press the camera key.

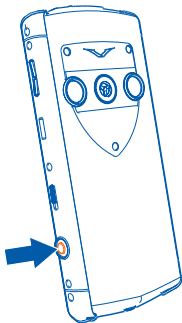

You can use your Vertu Constellation to take pictures or record videos. You can then view or edit the pictures and videos, share them on the internet, or send them to compatible devices.

Take a picture

 Select **Menu > Media > Camera**.

Your phone camera has the full focus feature. With this feature, you can take pictures where objects both in the foreground and background are in focus.

- 1 To activate the face tracking feature, select **○○○ > Face detect..** The face tracker detects and draws rectangles around faces, even when they are moving.
- 2 Press the camera key. Do not move the phone before the picture is saved and the final picture displayed.

Pictures and videos are automatically saved to the internal, fixed memory.



Save location information to your pictures and videos

You can set your phone to record the location of a particular picture or video automatically.

Select **Menu > Media > Camera**.

Activate the location recording feature

Select **Options > Settings > Save location info > Yes**.

It may take several minutes to obtain the coordinates of your location. The availability and quality of GPS signals may be affected by your location, buildings, natural obstacles, and weather conditions.

Location information indicators:

✖ — Location information is unavailable. Location information may not be saved to pictures or videos.

📍 — Location information is available. Location information is saved to pictures or videos.

Location information can be attached to an image or a video clip if location coordinates can be determined via network and GPS. If you share an image or a video clip which has location information attached, the location information may be visible to others that view the image or the video clip. You can deactivate geotagging in the camera settings.

Picture and video tips

Press the camera key.

When taking a picture:

- Use both hands to keep the camera steady.
- When you zoom in, the image quality may decrease.
- The camera activates battery saving mode after about a minute of inactivity. To activate the camera again, press the camera key briefly.
- You can set the user defined scene to be used as the default scene every time you open the camera. Select **Scene mode > User defined > Edit**.

Modify the settings, and select **Set as default scene mode > Yes**.

Keep a safe distance when using the flash. Do not use the flash on people or animals at close range. Do not cover the flash while taking a picture.

When recording a video:

- For best results, close any open applications before recording.

Record a video

Besides taking pictures with your phone, you can also capture your special moments as videos.

Press the camera key.

- 1 To switch from image mode to video mode, if necessary, select .
- 2 To start recording, press the camera key. A red record icon is displayed.
- 3 To pause recording, select **Pause**. If you pause recording and do not press any key within five minutes, the recording stops.
To zoom in or out, use the volume keys.
- 4 To stop recording, press the camera key. The video is automatically saved in Photos.



Tip: You can send your video in a multimedia message. To limit the video size for sending, before recording, select **Options > Settings > Video quality**, and drag the slider to **Basic**.

Send a picture

You can send pictures to your friends in a multimedia or mail message, or using Bluetooth.

Select **Menu > Media > Camera**.

- 1 To make sure the Show captured image option is activated, select **Options > Settings > Show captured image > Yes**.
- 2 Take a picture.
- 3 Select **Options > Send** and the desired sending method.

Your pictures and videos

About Photos

 Select **Menu > Media > Photos**.

You can watch the videos you have recorded, or browse through the pictures you have taken.

You can also view the pictures and videos on a compatible TV.

To manage your media files more effectively, add tags to the files, or organise them into albums.

View pictures and videos

Select **Menu > Media > Photos**.

Browse pictures

Swipe up or down.

View a picture

Select the picture.

View a picture in full screen mode

Select the picture, and turn your phone to landscape mode.

Zoom a picture

Place two fingers on the screen, and to zoom in, slide your fingers apart. To zoom out, slide your fingers together.



Tip: To quickly zoom in or zoom back out, tap the screen twice.

View pictures as a slide show

Select a picture and **Options > Slide show > Play**. The slide show starts from the selected picture.

You can view all your pictures and videos, or your pictures and videos grouped by album or tag.

Switch the view

Select  and a view.

Play a video

Select a video. Videos are marked with .

Pictures and videos can also be sent to you from a compatible phone or device. You can view a received picture or video directly in **Photos**.

Edit the pictures you have taken

 With Photo editor, you can add effects, text, clip art, or frames to your pictures.

Select **Menu > Media > Photo editor** and a picture.

- 1 To insert effects, select the desired option from the extended toolbar.
- 2 To save the edited picture, select **Options > Save**. The edited picture does not replace the original picture.

To later view your edited pictures, select **Menu > Media > Photos**.

Video editor

About Video Editor

With Video editor, you can combine pictures and videos with sounds, effects, and text, and easily turn them into short movies or slideshows.

 Select **Menu > Media > Video Editor**.

The following codecs and file formats are supported: MPEG-4, H.263, H.263 BL, WMV, JPEG, PNG, BMP, GIF, MP3, AAC/AAC+/eAAC+, WAV, and AMR-NB/AMR-WB.

Save the sound files that you want to use in a movie to the **Sound files** folder on your device.

You cannot add a DRM protected sound file to a movie.

Create a movie

You can easily create short movies from videos and pictures.

Select **Menu > Media > Video Editor**.

- 1 Select **Easily create a video from your photos and video clips**.
- 2 To add videos and pictures to your movie, select **Select media**. To view the files you have selected, swipe right or left.
- 3 To add transitions between videos and pictures, select **+**.

- 4 To activate editing mode, select a video or picture. In editing mode, you can cut the length of the video or define how long a picture is displayed.
- 5 Select the sounds to play in the background.
- 6 To add text or subtitles to your movie, select **Add text**.
- 7 Save your movie.

Create a slideshow

The Video Editor application contains templates for different occasions. You can use them to create slideshows of events, such as anniversaries or parties.

Select **Menu > Media > Video Editor**.



- 1 Select **Make a stylish slideshow from your photos**.
- 2 Select a template to use for the slideshow. When you select a template, a preview is displayed.
- 3 Select the pictures to use.
- 4 Select the sounds to play in the background.
- 5 Add a title.
- 6 Preview and save your slideshow.

Print a picture you have taken

You can print your pictures directly using a compatible printer.

- 1 Use a compatible USB data cable to connect your device to a printer in Media transfer mode.
- 2 Select the picture to print.
- 3 Select **Options > Print**.
- 4 To use the USB connection to print, select **Print > Via USB**.
- 5 To print the picture, select **Options > Print**.

 **Tip:** You can also use a Bluetooth printer. Select **Print > Via Bluetooth**. Change the selected printer to Bluetooth, and follow the displayed instructions.

 **Tip:** When the USB cable is connected, you can change the USB mode. In the top right corner of the browsing view, select  **> USB**.

Videos and TV

Videos

About Videos

 With the Videos application, you can watch videos on your device.

Using a packet data access point to download a video may involve the transmission of large amounts of data through your service provider's network. For information about data transmission charges, contact your service provider.

Play a video

Select **Menu > Media > Videos**.

Select the video.

Use the video player controls

Tap the screen.

View pictures and videos on a TV

To view your pictures and videos on a TV, you need to use the supplied AV cable CA-163V to connect your phone to the TV.

- 1 Connect the AV cable to the video input of a compatible TV. The colours of the plugs must match the colours of the sockets.
- 2 Connect the other end of the AV cable to the AV connector of your Vertu Constellation. You may need to select **TV-Out cable** as the USB mode.
- 3 Browse for the file you want to view.

You may need to modify the TV-out settings and aspect ratio. To do this, select **Menu > Settings** and **Phone > Accessories > TV-Out**.

The display from your Vertu Constellation, as well as any sound, is now played through the connected device.

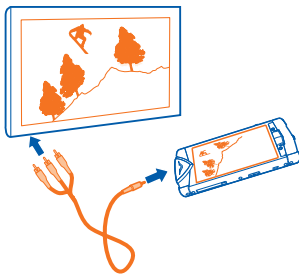

Music and audio

Music player

About the music player

🎵 Select **Menu** > **Media** > **Music player**.

You can listen to music and podcasts while on the move.

Warning: Excessive sound pressure from earphones and headphones can cause hearing loss.

Play music

Select **Menu** > **Media** > **Music player**.

- 1 Select **Options** and the desired view. You can browse songs by song or album. In the album view, to browse the album covers, turn your device so it is horizontal, and swipe left or right.





- 2 Select a song or album.

💡 **Tip:** To listen to the songs in a random order, select .

Pause and resume playback

To pause playback, select ; to resume, select .

Fast-forward or rewind a song

Select and hold  or .

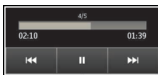

💡 **Tip:** When listening to music, you can return to the home screen, leaving Music player application playing in the background.

Create a playlist

If you want to listen to different music for different moods, you can sort your music into playlists, thus creating selections of songs to play in a specific order.

Select **Menu > Media > Music player**.

- 1 Select **Options > Playlists**.
- 2 Select **Options > New playlist**.
- 3 Enter a name for the playlist, and select **OK**.
- 4 Select the songs to add to the playlist, in the order you want them to play.

Add a song to a playlist

Select and hold the song, and from the pop-up menu, select **Add to playlist**.

Remove a song from playlist

In the playlist view, select and hold the song, and from the pop-up menu, select **Remove**.

This does not delete the song from the device; it only removes it from the playlist.

Play a playlist

Select **Options > Playlists** and the playlist.

 **Tip:** Music player automatically creates a playlist for the most played songs, recently played songs, and recently added songs.

Copy music from your PC

You can copy music files quickly and easily from your PC to your Vertu Constellation.

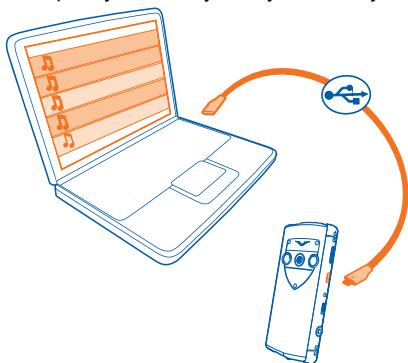

- 1 Use a compatible USB data cable to connect your phone to your computer.
- 2 On your phone, select the notification area in the top right corner, and select  > **USB > Mass storage.**
- 3 On your computer, use your computer's file browser to locate the folder showing the files on your phone.
- 4 Copy the music files from your computer to the folder within your Vertu Constellation called **Music.**
- 5 Disconnect the USB cable from your Vertu Constellation, and select **Menu > Media > Music player** and **Options > Refresh library.**

Some music files can be protected by digital rights management (DRM) and cannot be played on more than one phone.

Protected content

Digital rights management (DRM) protected content, such as pictures, videos, or music, comes with an associated licence that defines your rights to use the content. You can view the details and status of the licences, and reactivate and remove licences.

Manage digital rights licences

Select **Menu > Settings > Phone > Phone management > Security settings > Protected content.**

Record sounds

You can use your device recorder to record sounds from nature, such as birds singing, as well as voice memos. You can send the recorded sound clips to your friends.

Select **Menu > Media > Recorder.**

Record a sound clip

Select .

Stop recording

Select . The sound clip is automatically saved to the Sound files folder in the File manager application.

Send a recorded sound clip as an audio message

Select **Options > Send.**

FM radio

About FM radio

 Select **Menu > Media > Radio**.

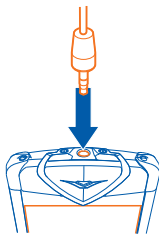

You can listen to FM radio stations using your device - just plug in a headset, and select a station!



Find and save radio stations



Search for your favourite radio stations, and save them, so you can easily listen to them later.

Select **Menu > Media > Radio**.

From the toolbar, select  > .

To find radio stations, you can use the automatic scanning, or you can set a frequency manually. The first time you open the FM radio, the application automatically searches for radio stations audible at your location.

Scan for all available stations

- 1 From the toolbar, select .
- 2 To save all found stations, from the toolbar, select . To save a single station, select and hold the station title, and from the pop-up menu, select **Save**.

Set a frequency manually

- 1 From the toolbar, select  **Tune manually**.
- 2 Use the up and down arrow icons to enter a frequency.

Listen to the radio



You can enjoy your favourite FM radio stations on the go.

Select **Menu > Media > Radio**.

Listen to a saved station

From the toolbar, select  > , and select a station from the list.

Go to the next or previous saved station

Swipe right or left. Alternatively, select  or .

Scan for another available station

Swipe up or down. Alternatively, select and hold  or .

Listen to the radio using the loudspeaker

Select **Options** > **Activate loudspeaker**. You still need to have a headset attached. You can make or answer a call while listening to the radio. The radio is automatically muted during an active call.

The quality of the radio broadcast depends on the coverage of the radio station in the area.



Reorder the list of saved stations

You can reorder the list of saved stations, so that your favourites are at the top.

Select **Menu** > **Media** > **Radio**.

The stations you have saved are listed in the Station list view.

Move a station on the list

- 1 From the toolbar, select  > .
- 2 Select and hold the station title, and from the pop-up menu, select **Move**.
- 3 Select the new place on the list.

Maps

Maps overview

 Select **Menu > Maps**.

Welcome to Maps.

Maps shows you what is nearby, helps you plan your route, and guides you where you want to go.

- Find cities, streets, and services.
- Find your way with turn-by-turn directions.
- Synchronise your favourite locations and routes between your phone and the Ovi Maps web service.
- Check weather forecasts and other local information, if available.

Some services may not be available in all countries, and may be provided only in selected languages. The services may be network dependent. For more information, contact your network service provider.

Using services or downloading content may cause transfer of large amounts of data, which may result in data traffic costs.

Contents of digital maps may sometimes be inaccurate and incomplete. Never rely solely on the content or the service for essential communications, such as in emergencies.

My position

View your location and the map

See your current location on the map, and browse maps of different cities and countries.

Select **Menu > Maps and Map**.

 indicates your current position, if available. When searching for your position,  blinks. If your position is not available,  indicates your last known position.

If accurate positioning is not available, a red halo around the positioning icon indicates the general area you might be in. In densely populated areas, the accuracy of the estimate increases, and the red halo is smaller than in lightly populated areas.

Browse the map

Drag the map with your finger. By default, the map is oriented north.

View your current or last known location

Select .

If you search for or browse to a location, and view details about the location using a service, such as Weather, the information for the location you are currently viewing is displayed. To return to viewing your current location, or to view information for your current location, select .

Zoom in or out

Select + or -.



Tip: To zoom, you can also place two fingers on the map, and slide your fingers apart to zoom in or together to zoom out. Not all phones support this feature.

If you browse to an area not covered by the street maps that are stored on your phone, and you have an active data connection, new street maps are automatically downloaded.

Prevent downloading new street maps automatically

In the main menu, select  > **Internet** > **Connection** > **Offline**.

New street maps are also downloaded if you upgrade to the latest Maps application version. When you use Maps the first time after an upgrade, select **Use Ovi Maps online**. You need an active data connection.

Map coverage varies by country and region.

Map view

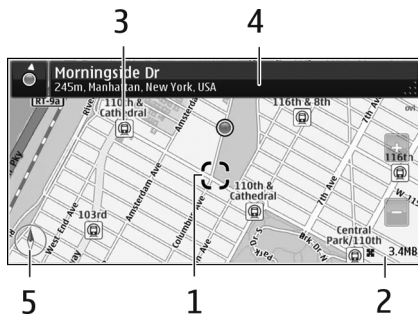

- 1 Selected location
- 2 Indicator area
- 3 Point of interest (for example, a railway station or a museum)
- 4 Information area
- 5 Compass

Change the look of the map

View the map in different modes, to easily identify where you are.

Select **Menu > Maps** and **Map**.

Select  and from the following:

Map view — In the standard map view, details such as location names or motorway numbers are easy to read.

Satellite view — For a detailed view, use satellite images.

Terrain view — View at a glance the ground type, for example, when you are travelling off-road.

3D view — For a more realistic view, change the perspective of the map.

Landmarks — Display prominent buildings and attractions on the map.

Night mode — Dim the colours of the map. When travelling at night, the map is easier to read in this mode.

Transit lines — View selected public transport services, such as metro and tram routes.

The available options and features may vary by region. The unavailable options are dimmed.

Download and update maps

Save new street maps to your phone before a journey, so you can browse the maps without an internet connection when travelling.

To download and update maps on your phone, you need an active WLAN connection.

Download maps

1 Select **Update > Add new maps**.

2 Select a continent and a country, and select **Download**.

To complete the download later, select **Pause** or **Exit download**.



Tip: You can also use the Nokia Ovi Suite PC application to download the latest street maps and voice guidance files, and copy them to your phone. To download and install Nokia Ovi Suite, go to www.ovi.com.

When you install a newer version of the Maps application on your phone, the country or region maps are deleted. Before using Nokia Ovi Suite to download new country or region maps, open and close the Maps application, and make sure you have the latest version of Nokia Ovi Suite installed on your computer.

Update maps

Select **Update > Check for updates**.

Use the compass

When the compass is activated, both the arrow of the compass and the map rotate automatically in the direction to which the top of your phone is pointing.

Select **Menu > Maps** and **Map**.

Activate the compass

Select .

Deactivate the compass

Select  again. The map is oriented north.

The compass is active when it is green. If the compass needs calibration, the compass is red.

Calibrate the compass

Turn the phone around until it beeps or vibrates.

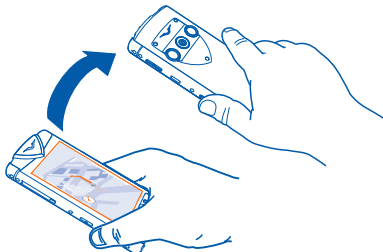

The compass has limited accuracy. Electromagnetic fields, metal objects, or other external circumstances may also affect the accuracy of the compass. The compass should always be properly calibrated.

About positioning methods

Maps displays your location on the map using GPS, A-GPS, WLAN, or network (cell ID) based positioning.

The global positioning system (GPS) is a satellite-based navigation system used for calculating your location. Assisted GPS (A-GPS) is a network service that sends you GPS data, improving the speed and accuracy of the positioning.

WLAN positioning improves position accuracy when GPS signals are not available, especially when you are indoors or between tall buildings.

With network (cell ID) based positioning, the position is determined through the antenna system your mobile device is currently connected to.

To avoid network service costs, you can disable A-GPS, WLAN, and network (cell ID) based positioning in your device positioning settings, but calculating your location may take much longer. For more information about positioning settings, see the user guide of your device.

The availability and quality of GPS signals may be affected by your location, satellite positions, buildings, natural obstacles, weather conditions, and adjustments to GPS satellites made by the United States government. GPS signals may not be available inside buildings or underground.

Do not use GPS for precise location measurement, and never rely solely on the location information provided by GPS and cellular networks.

The trip meter may not be accurate, depending on the availability and quality of your GPS connection.



Note: Using WLAN may be restricted in some countries. For example, in France, you are only allowed to use WLAN indoors. For more information, contact your local authorities.

Depending on the available positioning methods, the accuracy of positioning may vary from a few metres to several kilometres.

Find places

Find a location

Maps helps you find specific locations and businesses.

Select **Menu > Maps and Map > Search**.

- 1 Enter search words, such as a street address or place name.
- 2 Select an item from the list of proposed matches.

The location is displayed on the map.

Return to the list of proposed matches

Select **Search**.



Tip: In the search view, you can also select from the list of your previous search words.

Search for different types of nearby places

Select **Categories** and a category, such as shopping, accommodation, or transport.

If no search results are found, make sure the spelling of your search words is correct. Problems with your internet connection may also affect results when searching online.

If you have maps of the searched area stored on your device, to avoid data transfer costs, you can also get search results without an active internet connection, but the search results may be limited.

View location details

Find more information about a specific location or place, such as a hotel or restaurant, if available.

Select **Menu > Maps** and **Map > Search**.

The available options may vary by region. To view all the available place details, you need an active internet connection.

View the details of a place

Search for a place. Select the place and its information area.

Rate a place

Search for a place. Select the place, its information area, **Rate**, and the star rating. For example, to rate a place as being 3 out of 5 stars, select the third star.

When you find a place that does not exist or contains inappropriate information or incorrect details, such as the wrong contact information or location, it is recommended that you report it to Nokia.

Report incorrect place information

Select the place, its information area, **Report**, and the appropriate option.

Favourites

Save or view a place or route

Save an address, place of interest, or route, so it can be quickly used later.

Select **Menu > Maps**.

Save a place

- 1 Select **Map**.
- 2 Tap the location. To search for an address or place, select **Search**.
- 3 Tap the location's information area.
- 4 Select **Save**.

Save a route

- 1 Select **Map**.
- 2 Tap the location. To search for an address or place, select **Search**.
- 3 Tap the location's information area.
- 4 To add another route point, select **Navigate > Add to Route**.

5 Select **Add new route point** and the appropriate option.

6 Select **Show route > Options > Save route**.

View a saved place

In the main view, select **Favourites > Places**, the place, and **Show on map**.

View a saved route

In the main view, select **Favourites > Routes** and the route.

View and organise places or routes

Use your Favourites to quickly access the places and routes you have saved.

Group the places and routes into a collection, for example, when planning a trip.

Select **Menu > Maps** and **Favourites**.

View a saved place on the map

1 Select **Places**.

2 Go to the place.

3 Select **Show on map**.

To return to the list of saved places, select **List**.

Create a collection

Select **Create new collection**, and enter a collection name.

Add a saved place to a collection

1 Select **Places** and the place.

2 Select **Organise collections**.

3 Select **New collection** or an existing collection.

Rename or delete a saved place in a collection

1 Select **Places**.

2 Select the place, and from the pop-up menu, select the appropriate option.

Rename or delete a route in a collection

1 Select **Routes**.

2 Select and hold the route, and from the pop-up menu, select the appropriate option.

Share a location

When you want to show your friends a location on the map, you can send it to them.

Select **Menu > Maps** and **Map**.

1 Select a location and its information area.

2 Select **Share** > **Share via SMS** or **Share via Email**.

A mail or text message containing a link to the location on the map is sent to the recipient. Opening the link requires an active internet connection.

Synchronise your Favourites

Plan a trip on your computer at the Ovi Maps website, synchronise the saved places and routes with your phone, and access the plan on the go.

To synchronise places or routes between your phone and the Ovi Maps internet service, you need to be signed in to your Nokia account.

Synchronise saved places and routes

Select **Favourites** > **Synchronise with Ovi**. If you do not have a Nokia account, you are prompted to create one.

You can set your phone to synchronise your Favourites automatically when you open or close the Maps application.

Synchronise Favourites automatically

Select  > **Synchronisation** > **Synchronisation** > **At start-up and shut-d..**

Synchronising requires an active internet connection, and may involve the transmission of large amounts of data through your service provider's network. For information about data transmission charges, contact your service provider.

To use the Ovi Maps internet service, go to www.ovi.com.

Drive and Walk

Get voice guidance

Voice guidance, if available for your language, helps you find your way to a destination, leaving you free to enjoy the journey.

Select **Menu** > **Maps** and **Drive** or **Walk**.

When you use drive or walk navigation for the first time, you are asked to select the language of the voice guidance, and download the appropriate files.

If you select a language that includes street names, also the street names are said aloud.

Change the voice guidance language

In the main view, select  > **Navigation** > **Drive guidance** or **Walk guidance** and the appropriate option.

Deactivate voice guidance

In the main view, select  > **Navigation** > **Drive guidance** or **Walk guidance**, and select **None**.

Repeat the voice guidance for car navigation

In the navigation view, select **Options > Repeat**.

Change the volume of the voice guidance for car navigation

In the navigation view, select **Options > Volume**.

Drive to your destination

When you need turn-by-turn directions while driving, Maps helps you get to your destination.

Select **Menu > Maps** and **Drive**.

Drive to a destination

Select **Set destination** and the appropriate option.



Drive to your home

Select **Drive home**.

You can start driving without a set destination. The map follows your location, and traffic information is automatically displayed, if available. To set the destination later, select **Destination**.

By default, the map rotates to your driving direction.

Orient the map to north

Select . To rotate the map back to your driving direction, select .

When you select **Drive home** or **Walk home** for the first time, you are prompted to define your home location.

Change your home location

- 1 In the main view, select .
- 2 Select **Navigation > Home Location > Redefine**.
- 3 Select the appropriate option.

Change views during navigation

Swipe left to select **2D view**, **3D view**, **Arrow view**, or **Route overview**.

Obey all local laws. Always keep your hands free to operate the vehicle while driving. Your first consideration while driving should be road safety.

Navigation view

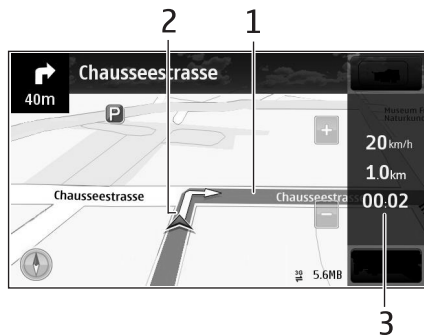

- 1 Route
- 2 Your location and direction
- 3 Information bar (speed, distance, time)

Get traffic and safety information

Enhance your driving experience with real-time information about traffic events, lane assistance, and speed limit warnings, if available for your country or region.

Select **Menu > Maps** and **Drive**.

View traffic events on the map

During drive navigation, select **Options > Traffic info**. The events are displayed as triangles and lines.

Update traffic information

Select **Options > Traffic info > Update traffic info**.

When planning a route, you can set the phone to avoid traffic events, such as traffic jams or roadworks.

Avoid traffic events

In the main view, select  **> Navigation > Reroute due to traffic**.

Walk to your destination

When you need directions to follow a route on foot, Maps guides you over squares, and through parks, pedestrian zones, and even shopping centres.

Select **Menu > Maps** and **Walk**.

Walk to a destination

Select **Set destination** and the appropriate option.

Walk to your home

Select **Walk home**.

You can start walking without a set destination.

By default, the map is oriented to north.

Rotate the map to your walking direction

Select . To rotate the map back to north, select .

When you select **Drive home** or **Walk home** for the first time, you are prompted to define your home location.

Change your home location

- 1 In the main view, select .
- 2 Select **Navigation > Home Location > Redefine**.
- 3 Select the appropriate option.

Plan a route

Plan your journey, and create your route and view it on the map before setting off.

Select **Menu > Maps** and **Map**.

Create a route

- 1 Tap the location of your starting point. To search for an address or place, select **Search**.
- 2 Tap the location's information area.
- 3 Select **Navigate > Add to Route**.
- 4 To add another route point, select **Add new route point** and the appropriate option.



Tip: If you want to plan a route from the convenience of your computer, and copy it to your phone, go to the Ovi Maps web service at www.ovi.com.

Change the order of the route points

- 1 Select a route point.
- 2 Select **Move**.
- 3 Tap the place where you want to move the route point to.

Edit the location of a route point

Tap the route point, and select **Edit** and the appropriate option.

View the route on the map

Select **Show route**.

Navigate to the destination

Select **Show route** > **Options** > **Start driving** or **Start walking**.

The route settings affect the navigation guidance and the way the route is displayed on the map.

Change the settings for a route

- 1 In the route planner view, open the Settings tab. To get to the route planner view from the navigation view, select **Options** > **Route points** or **Route points list**.
- 2 Set the transportation mode to **Drive** or **Walk**. If you select **Walk**, one-way streets are regarded as normal streets, and walkways and routes through, for example, parks and shopping centres, can be used.
- 3 Select the desired option.

Select the walking mode

Open the Settings tab, set the transportation mode to **Walk**, and select **Preferred route** > **Streets** or **Straight line**. **Straight line** is useful on off-road terrain as it indicates the walking direction.

Use the faster or shorter driving route

Open the Settings tab, set the transportation mode to **Drive**, and select **Route selection** > **Faster route** or **Shorter route**.

Use the optimised driving route

Open the Settings tab, set the transportation mode to **Drive**, and select **Route selection** > **Optimised**. The optimised driving route combines the advantages of both the shorter and the faster routes.

You can also choose to allow or avoid using, for example, motorways, toll roads, or ferries.

Give feedback on Maps

Participate in improving the Maps application, and send your feedback.

Select **Menu** > **Maps**.

- 1 Select **?** > **Feedback**.
- 2 Select how likely you are to recommend Maps to other people. You can also give your reasons.
The feedback is anonymous.
- 3 Select **Submit**.

To give feedback, you need to have an active internet connection.

After you have sent your feedback for the current version of Maps, the option is no longer available.

Office

Quickoffice

About Quickoffice



Select **Menu > Office > Quickoffice**.

Quickoffice consists of the following:

- Quickword for viewing Microsoft Word documents
- Quicksheet for viewing Microsoft Excel worksheets
- Quickpoint for viewing Microsoft PowerPoint presentations

Not all file formats or features are supported.

To buy the editor version of Quickoffice, select **Updates and upgrades**.

Read Microsoft Word, Excel, and PowerPoint documents

You can view Microsoft Office documents, such as Word documents, Excel worksheets, or PowerPoint presentations.

Select **Menu > Office > Quickoffice**.

Open a file

Select **Browse files** and the memory where the file is stored, browse to the correct folder, and select the file.

Sort files

Select **Options > Sort by**.

Not all formats or features are supported.

Read PDF documents



With Adobe Reader, you can read PDF documents.

Select **Menu > Office > Adobe PDF**.

Open a file

Select the memory where the file is stored, browse to the correct folder, and select the file.

Make a calculation



Select **Menu > Office > Calculator**.

- 1 Enter the first number of the calculation.

- 2 Select a function, such as add or subtract.
- 3 Enter the second number of the calculation.
- 4 Select =.

Save or retrieve the result of a calculation

Select **Options** > **Memory** > **Save** or **Recall**.

Write notes

About Notes

 Select **Menu** > **Office** > **Notes**.

You can write notes, such as meeting memos, and save received plain text files (TXT files) to the Notes application.

Make a shopping list

Shopping lists on paper are easy to lose. Instead of writing them on paper, you can make your shopping lists with Notes. This way, you always have the list with you! You can also send the list to, for example, a family member.

Select **Menu** > **Office** > **Notes**.

- 1 Select **Options** > **New note**.
- 2 Enter text in the note field.

Send the list

Open the note, and select **Options** > **Send** and the sending method.

Translate words from one language to another

 You can translate words from one language to another. Not all languages may be supported.

Select **Menu** > **Office** > **Dictionary**.

- 1 Enter text in the search field. Suggestions of words to translate are displayed.
- 2 Select the word from the list.

Change the source or target language

Select **Options** > **Languages** > **Source** or **Target**.

Download more languages from the internet

Select **Options** > **Languages** > **Download languages**.

English is preinstalled, and you can add two additional languages.

Open or create zip files

 You can open and extract files from zip files. You can also create new zip files, to store and compress files.

Select **Menu > Office > Zip**.

Phone management

Keep your phone software and applications up to date

About phone software and application updates

With phone software updates and application updates, you can get new features and enhanced functions for your phone. Updating the software may also improve your phone performance.

It is recommended that you back up your personal data before updating your phone software.



Warning: If you install a software update, you cannot use the device, even to make emergency calls, until the installation is completed and the device is restarted.

Using services or downloading content may cause transfer of large amounts of data, which may result in data traffic costs.

Before starting the update, connect a charger or make sure the device battery has enough power.

After the update, the instructions in the user guide may no longer be up to date.

Update software and applications on your phone

 You can check if there are updates available for your phone software or for individual applications, and then download and install them to your Vertu Constellation via the network service.

You can also set your phone to check for application updates automatically and notify you when important or recommended updates are available.

Before installing any software updates on your phone, make sure that you back up your personal data, and that your battery has sufficient power.

Check for and install phone software updates automatically

If you opted to receive notifications of software updates during setup, you are told whenever there are updates available to be installed on your Vertu Constellation.

Check for and install phone software updates manually

- 1 Select **Menu > Settings and Phone > Phone management > Device updates.**
- 2 Select **Options > Check for updates.**

If any updates are available, you are prompted to install them.

Install application software updates

- 1 Select **Menu > Office > Tools > SW update.**

- 2 To set your phone to automatically check for application updates, select **Options > Settings > Auto-check for updates**.
- 3 To install the available application updates, select which updates to install, and select .

Vertu Fortress

Set up and use Vertu Fortress on your phone

Vertu Fortress allows you to upload photos and videos from your Vertu Constellation to the Vertu Fortress cloud-based server.

Because you can also transfer the same types of files to and from the server using a Windows PC client, you are able to synchronise your Vertu Constellation with your PC.

Select **Menu > Vertu**.

Select **Install Fortress**. Follow the steps on the screen to install Vertu Fortress on your Vertu Constellation. When you are asked whether you want to install the application on the **Phone memory** or **Mass memory**, you are advised to select **Mass memory**, so that the application will still be accessible following software updates.

Synchronise your media files

- 1 Select Vertu Fortress.
- 2 You are prompted to enter your @vertu.me username and password.
- 3 You are informed that the default mode of synchronisation is manual. If you want to change this to automatic, select **Options > Settings > General**, and then select one of the following: **Push auto** if you want any new files, or newly edited files, to be uploaded immediately; or **WLAN auto** if you want your media files to be transferred in accordance with the number of minutes on the scheduler (the default is 30 minutes), whenever there is a WLAN connection.
- 4 For each type of media file (photos and videos), set the direction of synchronisation to one of the following: **Upload only** (the default), **Sync two-way** (for synchronisation both ways between the server and phone), or **Do nothing** (which stops all Vertu Fortress activity on the phone).
- 5 If you left the mode of synchronisation as manual, select **Sync all** when you are ready to synchronise your media files.

Because data costs can be high, especially when roaming, you are advised to proceed with caution with regard to the upload of large numbers of media files.

Manage your Vertu Fortress media files

You can use the Vertu Fortress Web portal to manage the photos and videos that you have uploaded to the cloud-based server.

- 1 Sign in to your @vertu.me account at www.vertu.me

- 2 Select Vertu Fortress.
- 3 Select the category of media files to view (photos or videos).



Tip: You can rename or delete files of any type, and rotate any photos.

Set up and use Vertu Fortress on your PC

Vertu Fortress allows you to transfer photos and videos between your Windows PC and the Vertu Fortress cloud-based server.

Install Vertu Fortress

- 1 Sign in to your @vertu.me account at www.vertu.me.
- 2 Select Vertu Fortress, followed by **Download Windows client**.
- 3 Follow the displayed instructions to install the Windows client. A folder called Vertu Fortress is created under your user on the PC. This is the folder from and into which Vertu Fortress will upload and download media files.

You can modify the synchronisation settings at any time.

Synchronise your media files

- 1 Ensure that all new files that you wish to transfer from your PC have been copied to the Vertu Fortress folder.
- 2 Launch the Windows client.
- 3 Select **Tools > Options**.
- 4 For each category of media files, select **Details**, followed by the direction of synchronisation: **Two-way** (the default), **One-way from the server to the client**, or **One-way from the client to the server**.
- 5 Synchronisation is manual, unless you select a number of minutes in the scheduler, in which case synchronisation takes place automatically after the number of minutes selected (the default is every 15 minutes).
- 6 Close the **Options** dialog. If you did not make a selection in the scheduler, select **Sync all** when you are ready to synchronise your media files manually.

Manage files

About the file manager

 Select **Menu > Office > File mgr.**

You can browse, manage, and open files on your phone.

View the files stored in your phone

Select **Menu > Office > File mgr.** and the desired memory.

The files and folders at the top level of that memory location are displayed.

View the contents of a folder

Select the folder.

Organise files

You can delete, move, copy, or create new files and folders. If you need to backup or upload files, organising them into their own folders eases the transfer.

Select **Menu > Office > File mgr..**

Create a new folder

In the folder where you want to create a sub-folder, select **Options > New folder.**

Copy or move a file to a folder

Select and hold the file, and from the pop-up menu, select the appropriate option.



Tip: You can also copy or move several files at the same time. Select **Options > Mark multiple items.**

Format the mass memory

When you format the mass memory, all the data on it is deleted.

Back up all data you want to keep before formatting the mass memory. All data is permanently deleted.

1 Select **Menu > Office > File mgr..**

2 Select and hold the mass memory, and from the pop-up menu, select **Format.**

Do not format the mass memory using PC software, because it may cause degraded performance.

Digital Rights Management (DRM) technologies may prevent some backup data from being restored. For more information about DRM used for your content, contact your service provider.

Increase available memory so you can add more content

While your Vertu Constellation includes a 32 GB fixed memory, there may be occasions when you need to increase the available phone memory, so you can install more applications or add more content.

You can delete the following if no longer needed:

- Text, multimedia, and mail messages.
- Contact entries and details.
- Applications.
- Installation files (.sis or .sisx) for installed applications.
- Music, pictures, or videos.

Copy content you want to keep to the mass memory or to a compatible computer.



Tip: If expired trial or demo applications are installed, remove them.

Manage applications

About Application manager

 Select **Menu > Settings and Application manager**.

You can view details of installed applications, remove applications, and define installation settings.

You can install the following types of applications:

- Java™ ME applications that have the .jad or .jar file extension
- Applications, compatible with the Symbian operating system, that have the .sis or .six file extension
- Widgets that have the .wgz file extension

Only install applications that are compatible with your phone.

Remove an application from your phone

You can remove installed applications that you no longer want to keep or use, to increase the amount of available memory.

Select **Menu > Settings and Application manager**.

- 1 Select **Installed apps**.
- 2 Select and hold the application to remove, and from the pop-up menu, select **Uninstall**.

If you remove an application, you can only reinstall it if you have the original installation file or a full backup of the removed application. You may not be able to open files created with a removed application.

If an installed application depends on a removed application, the installed application may stop working. For details, see the user documentation of the installed application.

The installation files may use large amounts of memory and prevent you from storing other files. Use Nokia Ovi Suite to back up installation files to a compatible PC, then file manager to remove the installation files from the phone memory.

Synchronise content

About Sync

 Select **Menu > Settings and Connectivity > Data transfer > Sync**.

With the Sync application, you can synchronise your contacts, notes, and other content between your device and a remote server. After the synchronisation, you have a back-up of your important data on the server.

Synchronise content between your phone and a remote server

You can have your calendar, notes, and other content backed up and available, whether you are working from your computer or from your mobile phone. This is done using the Sync application, which synchronises content between your phone and a remote server.

Select **Menu > Settings and Connectivity > Data transfer > Sync**.

You may receive synchronisation settings as a configuration message from your service provider. The synchronisation settings are saved as a synchronisation profile. When you open the application, the default or previously used synchronisation profile is displayed.

Include or exclude content types

Select a content type.

Synchronise data

Select **Options > Synchronise**.

Copy contacts or pictures between phones

With the Phone switch application, you can synchronise and copy contacts, pictures, and other content, between two compatible phones, using Bluetooth.

Select **Menu > Settings > Connectivity > Data transfer > Phone switch**.

1 Select from the following:



— Synchronise content between two phones.



— Copy content from another phone.



— Copy content to another phone.

2 Select the phone to which you want to connect, and pair the phones. Bluetooth needs to be activated in both phones.

3 If the other phone requires a passcode, enter it. The passcode, which you can normally define yourself, must be entered in both phones.

The passcode in some phones is fixed. For details, see the appropriate user guide.

The passcode is valid only for the current connection.

4 Select the content and **OK**.

Protect your phone

Set your device to lock automatically

You can protect your Vertu Constellation against unauthorised use. To do this, you need to define a lock code, and set your device to lock itself automatically when you are not using it.

Lock your device manually

On the home screen, press the power key briefly, select **Lock phone**, and enter the lock code.

Unlock your device

Slide the key lock switch, enter the lock code, and select **OK**.

Alternatively, press the menu key, and select **Unlock**.

If you set up a Mail for Exchange mailbox, the automatic device lock feature is automatically activated.

Lock your device remotely

You can lock your Vertu Constellation remotely to prevent unauthorised use. This is done using a predefined text message.

Enable remote locking

- 1 Select **Menu > Settings and Phone > Phone management > Security settings > Phone and SIM card > Remote phone locking > Enabled**.
- 2 Enter the text message content. It can be 5-20 characters, and both upper and lower case letters can be used.
- 3 Enter the same text again to verify it.
- 4 Enter the lock code.

Send the lock message

To lock the device remotely, write the predefined text, and send it to your device as a text message.

To unlock your device, you need the lock code.

Install PC Suite on your PC

With the PC Suite PC application, you can manage content on your phone, and keep it in sync with your compatible computer. You can also update your phone with the latest software, and download maps.

Download the latest version of PC Suite from www.ovi.com/suite to your computer.

To learn more about PC Suite, go to www.ovi.com/suite.

Accessories

Charge the battery

The wall charger supplied with your Vertu phone should be appropriate for your region. However, you should always check that the electrical rating of the AC outlet is appropriate for the charger before you attempt to plug it in.

The battery for your Vertu phone requires charging at regular intervals. The battery does not have to be completely discharged before you can charge it.

- 1 Connect the charger cable to the micro-USB connector of your Vertu phone. Make sure the cable is inserted correctly, with the USB symbol facing up.

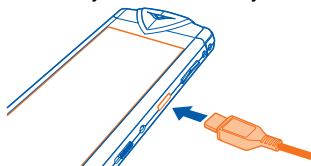

- 2 Connect the charger plug to the charger body.

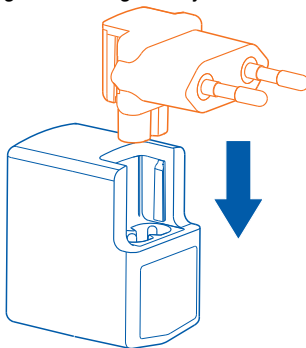

- 3 Connect the charger plug to a powered AC outlet. After a few seconds, the animated battery charge indicator on the phone is displayed.
- 4 When the battery is fully charged, the battery charge indicator stops animating. Disconnect the charger from your Vertu phone, and then from the wall outlet.



Tip: As an alternative, you can charge the battery by using any of the following:

- A compatible PC (this method also provides data connectivity).

- Vertu Portable Power.
- Vertu vehicle charger.

About Vertu Portable Power DC-15V

Vertu Portable Power allows you to charge the batteries in two compatible devices simultaneously when you have no access to an external power source.

You can do the following either separately or simultaneously:

- Charge your Vertu phone using the integrated USB cable (up to one full charge).
- Charge a compatible accessory, such as a Vertu Bluetooth headset, using the auxiliary USB power output (up to one full charge).
- Recharge Vertu Portable Power.

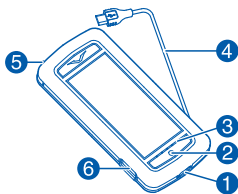

- 1 Power input
- 2 Power button
- 3 Charging indicator lights
- 4 Integrated USB cable for charging your Vertu phone
- 5 Cable management lever
- 6 Auxiliary USB power output

Use Vertu Portable Power DC-15V

Charge your Vertu Portable Power

- 1 Connect the USB cable provided between the power input on your Vertu Portable Power and your power source (this can be the Vertu charger (AC-31) supplied with your phone, or a compatible computer). When charging begins, successive charging indicator lights are illuminated. Once all five lights are illuminated, your Vertu Portable Power is fully charged.
- 2 Disconnect your Vertu Portable Power from the power source.

Your Vertu Portable Power switches off automatically if no charging takes place for 10 seconds, or if it automatically becomes discharged.

Use Vertu Portable Power to charge your Vertu phone

- 1 To switch on your Vertu Portable Power, press and hold down the power button until the charging indicator lights are illuminated.
- 2 Release the integrated USB cable using the cable management lever.
- 3 Connect the USB cable to the micro-USB connector on the Vertu phone.
- 4 When charging is complete, disconnect the phone from the pack and re-house the cable.

To ensure optimum signal performance of your Vertu phone, do not place your Vertu Portable Power against your phone during calls.

Use Vertu Portable Power to charge a compatible accessory

- 1 Switch on your Vertu Portable Power. Press and hold down the power button until the charging indicator lights are illuminated.
- 2 Connect the cable supplied with your accessory to the auxiliary USB power output on your Vertu Portable Power.
- 3 When charging is complete, disconnect the accessory from the pack.

In the unlikely event that the connected accessories draw excessive power from your Vertu Portable Power, charging is suspended and the indicator lights flash. Disconnect the accessories and press the power button to reset your Vertu Portable Power.

 **Note:** The surface of this device does not contain nickel in the platings. The surface of this device contains stainless steel.

Use the vehicle charger

You can use the vehicle charger to charge your Vertu phone battery quickly and safely from a standard 12 or 24 volt (DC) vehicle cigarette lighter outlet.

- 1 Connect the charger cable to the micro-USB connector of your Vertu phone. Make sure the cable is inserted correctly, with the USB symbol facing up.

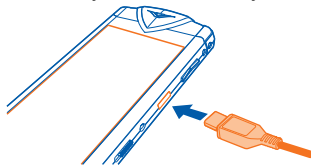

- 2 Connect the charger to the powered cigarette lighter outlet.

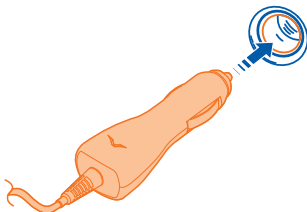

The green indicator light illuminates to show that the charger is connected to the power outlet. A confirmation message is displayed if your Vertu phone is switched on.

Some cigarette lighter sockets are only powered when the vehicle ignition is switched on. The vibrating alert is disabled while the charger is connected to your Vertu phone.

- 3 When the battery is fully charged, the battery charge indicator stops animating. Disconnect the charger from your Vertu phone, and then from the cigarette lighter outlet.

Only use the vehicle charger specifically designed for use with your Vertu phone. Never attempt to use a vehicle charger if it has been damaged.

The time taken to charge your battery depends on its existing charge. You can use your phone normally while it is charging, although this will increase the time to charge.

Use the data cable

The USB data cable enables you to transfer data between your Vertu phone and a compatible computer. You can also use your phone as a modem for a PC to connect to the internet.

- 1 Connect the USB data cable to the micro-USB connector of your Vertu Constellation. Make sure the cable is inserted correctly, with the USB symbol facing up.
- 2 Connect the cable to a USB port of the computer. The phone starts charging, and a number of USB connection modes are available. Select from the following:

PC Suite — For use with PC Suite on a PC.

Mass storage — To transfer files between your phone and a PC using the standard file management software.

Media transfer — To transfer audio or video files between your phone and a PC using the standard music or video handling software.

Conn. PC to net — To use the phone as a modem for your PC, and connect to the internet.

When a mode is selected, it is shown as **Active**.

When Mass storage mode is selected, you are not able to see or run applications that you have installed on the internal memory card.

Wired stereo headset

Your Vertu Constellation is supplied with a wired stereo headset, which includes a microphone. Connect this to the AV connector of your phone.

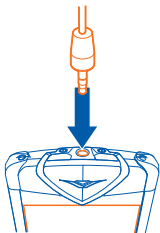

All the volume and music controls, and call handling functions, are contained within your Vertu Constellation.

If you use the headset with a device other than your Vertu Constellation, the 3.5 mm adaptor (supplied) may be required.

Common accessory settings

Select **Menu > Settings** and **Phone > Accessories**.

Accessory options include:

- Headset (which includes a microphone)
- Headphones
- Wireless car kit
- Music stand
- TV-Out
- Text phone

Set the profile that is used when connected to an accessory

Select the accessory and **Default profile**.

Set the phone to automatically answer a call after 5 seconds when connected to an accessory

Select the accessory and **Automatic answer**. If the ringing type is set to **Silent**, automatic answering is deactivated.

Turn the phone lights on when connected to an accessory

Select the accessory and **Lights > On**.

The available options may vary.

Troubleshooting

If your phone stops responding

Press and hold down the power key for about 8 seconds, until the phone vibrates and switches off.

Switch the phone back on if necessary.

No content, such as contacts or messages, is deleted.

Restore original settings

If your phone is not working properly, you can reset some settings to their original values.

- 1 End all active calls and connections.
- 2 Select **Menu > Settings** and **Phone > Phone management > Factory settings > Restore**.
- 3 Enter the lock code.

This does not affect documents or files stored on your phone.

After restoring the original settings, the phone switches off, and then on again. This may take longer than usual.

What to do when the memory is full?

If either of the following messages is displayed when you are deleting several items at the same time, delete items one by one, beginning with the smallest items:

- **Not enough memory to perform operation. Delete some data first.**
- **Memory low. Delete some data from phone memory.**

Copy content you want to keep to the mass memory or to a compatible computer. If possible, install applications to the mass memory, rather than the phone memory.

Message indicator blinking

Q: Why is the message indicator  blinking in the home screen?

A: The maximum number of messages are stored on your device. Delete some messages. The number of messages that can be stored on the SIM card is considerably lower than the number that can be stored in the device memory. You can use Nokia Ovi Suite to save messages to a compatible computer.

A contact appears twice in the contacts list

Q: I have a contact twice in my contacts list. How can I remove the extra contact?

A: You can merge two contacts into one. Select **Options > Merge contacts**, select the contacts to merge, and select **Merge**.

Unreadable characters while browsing the web

If unreadable characters are displayed, select **Menu > Web** and  **> Page > Default encoding** and the correct encoding for the character set of the language.

Remove all content and restore settings

If necessary, you can remove all personal information and content from your phone, and restore the original settings.

- 1 Back up the content you want to keep to a compatible computer.
- 2 Close all active connections and calls.
- 3 Select **Menu > Settings** and **Phone > Phone management > Factory settings > Delete data and restore**.
- 4 Enter the lock code.
- 5 Your phone switches off and then on again. Check carefully that all your personal content, such as contacts, pictures, music, videos, notes, messages, mails, presentations, games, and other installed applications, have been removed from the phone and internal memory card.

Content and information stored on the SIM card is not removed.

Examine your phone's compliance label

If you need to call Vertu or your service provider, you may need specific information listed on your phone label, for example the model and IMEI numbers.

 **Tip:** To find the IMEI number quickly, dial the sequence *#06# into the phone. The unique 15-digit IMEI code of your phone is instantly displayed. Write it down and keep it in a safe place so that you can find it if your phone is misplaced or stolen.

Locate the compliance label

- 1 Switch the device off.
- 2 Pull the SIM door outwards from the top of the phone.

 **Tip:** You might want to use your fingernail to do this.

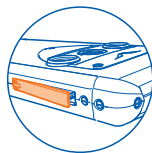

- 3 Fully extend the door.

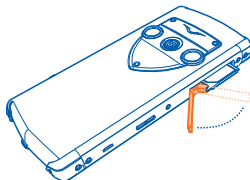

- 4 The SIM drawer automatically slides part way out of the phone. Remove the SIM drawer.

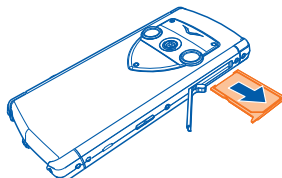

- 5 Pull out the compliance label from the SIM drawer recess. Write down any required information and keep it in a safe place.



Tip: You might want to pull the label out after first inserting a pin in the hole at the front of the label.

Unlike the SIM drawer, the label is not meant to be completely removed.

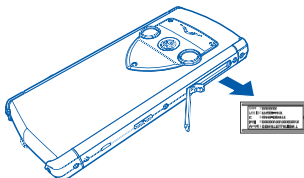

- 6 Re-insert the compliance label and then the SIM card into the SIM drawer recess.



Tip: When re-inserting the SIM card, ensure that the contact area is facing up, when the phone is looked at from the back. Align the card with the slanted corners of the recess

- 7 Fully re-insert the drawer, and close the door.

Specifications

Dimensions

- Volume: 73 cm³
- Weight: 164-199 g
- Length: 118.9 mm
- Width: 54.5 mm
- Thickness: 12.2 mm

Power management

- Rechargeable 1200 mAh Li-ion internal battery
Operation times are dependent on the SIM card, network settings, and usage.

Connectivity

- Quadband GSM 850/900/1800/1900 MHz
- WCDMA Bands I, II, IV, V, VIII
- HSDPA 10.2 Mb/s, HSUPA 2Mb/s
- WLAN 802.11 b/g inc WAPI for PRC
- Micro-USB connector
- 3.5mm AV connector
- Bluetooth with A2DP

Hardware characteristics

- 3.5" AMOLED 16:9 display with capacitive multipoint-touch capability
- 32 GB fixed user memory
- Graphics hardware accelerator chip
- 8 mega-pixel camera with full focus and integrated flash
- A-GPS with accelerometer and digital compass

Key features

- Symbian^3 operating system
- Personal, business, and Vertu mail, and Mail for Exchange compatibility with one mailbox of user's choice
- Auto synchronisation of Contacts and Calendar
- Office attachment viewers: Quickoffice and Acrobat Reader
- Blogging and social networking clients
- Web browser
- Widgets support

- J2ME MIDP 2.0 support
- Navigation with pre-loaded world maps
- Audio/Video player
- FM & Internet radio
- Dual Time Zone location-aware automatic clock
- Photo and Video editors
- Swype predictive text input

Accessories

- Leather phone pouch
- V Collection Wired Stereo Headset
- Wall charger (AC-31) with regional plugs
- Vertu vehicle charger (DC-7V)
- Vertu Portable Power (DC-15V)
- Micro-USB cable x 2
- Quick Start guide
- Polishing cloth
- Authenticity card

Protect the environment

Save energy

You do not need to charge your battery so often if you do the following:

- Close applications and data connections, such as your WLAN or Bluetooth connection, when not in use.
- Deactivate unnecessary sounds.

Recycle



Vertu complies with European Community requirements for the recycling of Waste Electrical & Electronic Equipment (WEEE). Such compliance is indicated by the addition of the crossed-out wheeled-bin symbol to the phone where appropriate. This symbol indicates that the phone was put onto the market after the WEEE legislation was implemented, and that the consumer should not dispose of the phone as normal household waste or unsorted municipal waste, but that it should be appropriately recycled.

Above all, never dispose of the phone in a fire, as the internal battery may explode. Should you wish Vertu to recycle your Product(s) at the end of its life, please either return it to the point from which you purchased your phone (if known), or return it to Vertu's headquarters. Alternatively, should you purchase a replacement phone from another supplier, the new supplier is obligated to take back the phone that is being replaced and recycle it appropriately. Background information on the European WEEE directive is available from ec.europa.eu/environment/waste/weee/index_en.htm.



Recycle packaging and user guides using your local recycling scheme.

Product and safety information

DECLARATION OF CONFORMITY



Hereby, Vertu declares that this RM-681V product is in compliance with the essential requirements and other relevant provisions of Directive 1999/5/EC. A copy of the Declaration of Conformity can be found at <http://www.vertu.com>.

© 2011 Vertu. All rights reserved.

Vertu and the V logo are registered trademarks or trademarks. Other product and company names mentioned herein may be trademarks or tradenames of their respective owners.

Reproduction, transfer, distribution, or storage of part or all of the contents in this document in any form without the prior written permission of Vertu is prohibited. Vertu operates a policy of continuous development. Vertu reserves the right to make changes and improvements to any of the products described in this document without prior notice.

Portions of the Nokia Maps software are ©1996-2011 The FreeType Project. All rights reserved.



Java and all Java-based marks are trademarks or registered trademarks of Sun Microsystems, Inc.

This product is licensed under the MPEG-4 Visual Patent Portfolio License (i) for personal and noncommercial use in connection with information which has been encoded in compliance with the MPEG-4 Visual Standard by a consumer engaged in a personal and noncommercial activity and (ii) for use in connection with MPEG-4 video provided by a licensed video provider. No license is granted or shall be implied for any other use. Additional information, including that related to promotional, internal, and commercial uses, may be obtained from MPEG LA, LLC. See <http://www.mpegla.com>.

To the maximum extent permitted by applicable law, under no circumstances shall Vertu or any of its licensors be responsible for any loss of data or income or any special, incidental, consequential or indirect damages howsoever caused.

The contents of this document are provided "as is". Except as required by applicable law, no warranties of any kind, either express or implied, including, but not limited to, the implied warranties of merchantability and fitness for a particular purpose, are made in relation to the accuracy, reliability or contents of this document. Vertu reserves the right to revise this document or withdraw it at any time without prior notice. The availability of particular products may vary by region. Please check with Vertu Concierge.

The availability of products, features, applications and services may vary by region. For more information, contact your Vertu dealer or your service provider. Your Vertu phone and headset kit may contain commodities, technology or software subject to export laws and regulations from the US and other countries. Diversion contrary to law is prohibited.

FCC/INDUSTRY CANADA NOTICE

Your device may cause TV or radio interference (for example, when using a telephone in close proximity to receiving equipment). The FCC or Industry Canada can require you to stop using your telephone if such interference cannot be eliminated. If you require assistance, contact Vertu Concierge. This device complies with part 15 of the FCC rules and Industry Canada licence-exempt RSS standard(s). Operation is subject to the following two conditions: (1) This device may not cause harmful interference, and (2) this device must accept any interference received, including interference that may cause undesired operation. The headset kit complies with part 15 of the FCC rules. Operation is subject to the following two conditions: (1) The components may not cause harmful interference, and (2) the components must accept any interference received, including interference that may cause undesired

operation. This Class B digital apparatus complies with Canada ICES-003. Any changes or modifications not expressly approved by Vertu could void the user's authority to operate this equipment.



Note: Vertu is not responsible for any radio or TV interference caused by unauthorised modifications to this equipment. Such modifications could void your authority to operate the equipment.

Some operations and features are SIM card and/or network dependent, MMS dependent, or dependent on the compatibility of devices and the content formats supported. Some services are subject to a separate charge.

Your Vertu phone contains a Passive Near Field Communication device. This device enables Vertu to verify the authenticity of the phone if it is presented at a Vertu branded store or Vertu authorised service company.

Network services and costs

Your device is approved for use on the EGSM 900 MHz, GSM 850/1800/1900 MHz, and WCDMA Band I, II, V and VI networks. To use the device, you need a subscription with a service provider.

Using network services and downloading content to your device may result in data traffic costs. Some product features require support from the network, and you may need to subscribe to them.

Take care of your device

Handle your device, battery, charger and accessories with care. The following suggestions help you protect your warranty coverage.

- Keep the device dry. Precipitation, humidity, and all types of liquids or moisture can contain minerals that corrode electronic circuits. If your device gets wet, allow the device to dry.
- Do not store the device in cold temperatures.
- Do not attempt to open the device other than as instructed in the user guide.
- Unauthorised modifications may damage the device and violate regulations governing radio devices.
- Do not drop, knock, or shake the device.
- Only use a soft, clean, dry cloth to clean the surface of the device.
- Keep your device away from magnets or magnetic fields.
- To keep your important data safe, store it in at least two separate places, such as your device, memory card, or computer, or write down important information.

During extended operation, the device may feel warm. In most cases, this is normal. If you suspect the device is not working properly, take it to the nearest authorised service facility.

Recycle

About Digital Rights Management

When using this device, obey all laws and respect local customs, privacy and legitimate rights of others, including copyrights. Copyright protection may prevent you from copying, modifying, or transferring pictures, music, and other content.

Content owners may use different types of digital rights management (DRM) technologies to protect their intellectual property, including copyrights. This device uses various types of DRM software to access DRM-protected content. With this device you can access content protected with WM DRM 10 and OMA DRM 2.0. If certain DRM software fails to protect the content, content owners may ask that such DRM software's ability to access new DRM-protected content be revoked. Revocation may also prevent renewal of such DRM-protected content already in your device. Revocation of such DRM software does not affect the use of content protected with other types of DRM or the use of non-DRM-protected content.

Digital rights management (DRM) protected content comes with an associated licence that defines your rights to use the content.

If your device has OMA DRM-protected content, to back up both the licences and the content, use the backup feature of PC Suite.

Other transfer methods may not transfer the licences which need to be restored with the content for you to be able to continue the use of OMA DRM-protected content after the device memory is formatted. You may also need to restore the licences if the files on your device become corrupted.

If your device has WMDRM-protected content, both the licences and the content are lost if the device memory is formatted. You may also lose the licences and the content if the files on your device become corrupted. Losing the licences or the content may limit your ability to use the same content on your device again. For more information, contact your service provider.

Some licences may be connected to a specific SIM card, and the protected content can be accessed only if the SIM card is inserted in the device.

Batteries and chargers

Battery and charger information

This device has an internal, nonremovable, rechargeable battery. Do not attempt to remove the battery from the device as you may damage the device. Take the device to the nearest authorised service facility for replacement of the battery.

This device is intended for use when supplied with power from the following chargers: AC-31. The exact charger model number may vary depending on the type of plug. The plug variant is identified by one of the following: E, X, AR, U, A, C, K, or B.

The battery can be charged and discharged hundreds of times, but it will eventually wear out. When the talk and standby times are noticeably shorter than normal, take the device to the nearest authorised service facility for battery replacement.

Battery safety



Note: The battery in your device is non-removable, so refer to the battery-related statements as applicable to your device.

When you unplug a charger or an accessory, hold and pull the plug, not the cord.

When your charger is not in use, unplug it from the electrical plug and the device. Do not leave a fully charged battery connected to a charger, as overcharging may shorten the battery's lifetime. If left unused, a fully charged battery will lose its charge over time.

Always keep the battery between 15°C and 25°C (59°F and 77°F). Extreme temperatures reduce the capacity and lifetime of the battery. A device with a hot or cold battery may not work temporarily.

Accidental short-circuiting can happen when a metallic object touches the metal strips on the battery. Short-circuiting may damage the battery or the connecting object.

Do not dispose of batteries in a fire as they may explode. Dispose of batteries according to local regulations. Recycle when possible. Do not dispose as household waste.

Do not dismantle, cut, open, crush, bend, puncture, or shred cells or batteries. If a battery leaks, do not let battery liquid touch skin or eyes. If this happens, immediately flush the affected areas with water, or seek medical help.

Do not modify, remanufacture, attempt to insert foreign objects into the battery, or immerse or expose it to water or other liquids. Batteries may explode if damaged.

Use the battery and charger for their intended purposes only. Improper use, or use of unapproved batteries or chargers may present a risk of fire, explosion, or other hazard, and may invalidate any approval or warranty. If you believe the battery or charger is damaged, take it to a service centre for inspection before continuing to use it. Never use a damaged battery or charger. Only use the charger indoors.

Additional safety information

Emergency calls

Make an emergency call

- 1 Ensure the device is switched on.
- 2 Check for adequate signal strength. You may also need to do the following:

- Insert a SIM card.
 - Remove call restrictions you have activated for your device, such as call barring, fixed dialling, or closed user group.
 - Ensure your device is not in an offline or flight profile.
 - If the device screen and keys are locked, unlock them.
- 3 To clear the display, press the menu key as many times as needed.
 - 4 Select **Call**.
 - 5 Enter the official emergency number for your present location.
 - 6 Select .
 - 7 Give the necessary information as accurately as possible. Do not end the call until given permission to do so.



Important: Activate both cellular and internet calls, if your device supports internet calls. The device may attempt to make emergency calls both through cellular networks and through your internet call service provider. Connections in all conditions cannot be guaranteed. Never rely solely on any wireless device for essential communications like medical emergencies.

Small children

Your device and its accessories are not toys. They may contain small parts. Keep them out of the reach of small children.

Medical devices

Operation of radio transmitting equipment, including wireless phones, may interfere with the function of inadequately protected medical devices. Consult a physician or the manufacturer of the medical device to determine whether they are adequately shielded from external RF energy. Switch off your device when regulations posted instruct you to do so, for example, in hospitals.

Implanted medical devices

Manufacturers of medical devices recommend a minimum separation of 15.3 centimetres (6 inches) between a wireless device and an implanted medical device, such as a pacemaker or implanted cardioverter defibrillator, to avoid potential interference with the medical device. Persons who have such devices should:

- Always keep the wireless device more than 15.3 centimetres (6 inches) from the medical device.
- Not carry the wireless device in a breast pocket.
- Hold the wireless device to the ear opposite the medical device.
- Turn the wireless device off if there is any reason to suspect that interference is taking place.
- Follow the manufacturer directions for the implanted medical device.

If you have any questions about using your wireless device with an implanted medical device, consult your health care provider.

Hearing



Warning: When you use the headset, your ability to hear outside sounds may be affected. Do not use the headset where it can endanger your safety.

Some wireless devices may interfere with some hearing aids.

Nickel



Note: The surface of this device does not contain nickel in the platings. The surface of this device contains stainless steel.

Operating environment

This device meets RF exposure guidelines in the normal use position at the ear or at least 1.5 centimetres (5/8 inch) away from the body. Any carry case, belt clip, or holder for body-worn operation should not contain metal and should position the device the above-stated distance from your body.

To send data files or messages requires a quality connection to the network. Data files or messages may be delayed until such a connection is available. Follow the separation distance instructions until the transmission is completed.

Vehicles

Radio signals may affect improperly installed or inadequately shielded electronic systems in motor vehicles such as electronic fuel injection, electronic antilock braking, electronic speed control, and air bag systems. For more information, check with the manufacturer of your vehicle or its equipment.

Only qualified personnel should install the device in a vehicle. Faulty installation or service may be dangerous and may invalidate your warranty. Check regularly that all wireless device equipment in your vehicle is mounted and operating properly. Do not store or carry flammable liquids, gases, or explosive materials in the same compartment as the device, its parts, or accessories. Remember that air bags inflate with great force. Do not place your device or accessories in the air bag deployment area.

Switch off your device before boarding an aircraft. The use of wireless devices in an aircraft may be dangerous to the operation of the aircraft and may be illegal.

Potentially explosive environments

Switch off your device in any area with a potentially explosive atmosphere. Obey all posted instructions. Sparks in such areas could cause an explosion or fire resulting in bodily injury or death. Switch off the device at refuelling points such as near gas pumps at service stations. Observe restrictions in fuel depots, storage, and distribution areas; chemical plants; or where blasting operations are in progress. Areas with a potentially explosive atmosphere are often, but not always, clearly marked. They include areas where you would be advised to turn off your vehicle engine, below deck on boats, chemical transfer or storage facilities and where the air contains chemicals or particles such as grain, dust, or metal powders. You should check with the manufacturers of vehicles using liquefied petroleum gas (such as propane or butane) to determine if this device can be safely used in their vicinity.

Certification information (SAR)

Your Vertu phone (Constellation T, RM-681V, P7QRM-681V) meets guidelines for exposure to radio waves.

Your mobile device is a radio transmitter and receiver. It is designed not to exceed the limits for exposure to radio waves recommended by international guidelines. These guidelines were developed by the independent scientific organisation ICNIRP and include safety margins designed to assure the protection of all persons, regardless of age and health.

The exposure guidelines for mobile devices employ a unit of measurement known as the Specific Absorption Rate or SAR. The SAR limit stated in the ICNIRP guidelines is 2.0 watts/kilogram (W/kg) averaged over 10 grams of tissue. Tests for SAR are conducted using standard operating positions with the device transmitting at its highest certified power level in all tested frequency bands. The actual SAR level of an operating device can be below the maximum value because the device is designed to use only the power required to reach the network. That amount changes depending on a number of factors such as how close you are to a network base station.

The highest SAR value under the ICNIRP guidelines for use of the device at the ear is 0.78 W/kg.

Use of device accessories may result in different SAR values. SAR values may vary depending on national reporting and testing requirements and the network band. Additional SAR information may be provided under product information at www.vertu.com.

Your mobile device is also designed to meet the requirements for exposure to radio waves established by the Federal Communications Commission (USA) and Industry Canada. These requirements set a SAR limit of 1.6 W/kg averaged over one gram of tissue. The highest SAR value reported under this standard during product certification for use at the ear is 0.99 W/kg and when properly worn on the body is 0.71 W/kg.

MANUFACTURER'S LIMITED WARRANTY



Note: This Limited Warranty does not affect your legal (statutory) rights under your applicable national laws relating to the sale of consumer products.

Vertu provides this Limited Warranty to you who have purchased the Vertu Product(s) included in the sales package. Vertu warrants to you that, during the warranty period, Vertu, or a Vertu-authorised service company, will, in a commercially reasonable time, remedy defects in materials, design and workmanship free of charge, by repairing, or, should Vertu in its discretion deem it necessary, replacing the Product(s) in accordance with this Limited Warranty (unless otherwise required by law).

Warranty period

The Warranty Period starts at the time of the original purchase of the Product(s) by the first end user. The sales package may contain several different Products and parts, and different Products and parts are covered by different Warranty Periods:

- a) Twenty-four (24) months for the phone and the fixed battery inside it.
- b) Twelve (12) months for the accessories (whether included in the phone sales package or sold separately), including the Vertu Portable Power and the fixed battery inside it, excepting the consumable parts and accessories listed in (c) and (d) below.
- c) Six (6) months for the following consumable parts and accessories: removable batteries, chargers, cables and covers.
- d) Ninety (90) days for the media on which any software is provided, e.g. CD-ROM, memory card.

As far as your national laws permit, the Warranty Period will not be extended or renewed or otherwise affected due to subsequent resale, Vertu-authorised repair, or replacement of the Product(s). However, any part(s) repaired or Product(s) replaced during the Warranty Period will be warranted from any defect on the intervention for the remainder of the original Warranty Period, or for twelve (12) months from the date of repair.

How to get warranty service

If you wish to make a claim under this Limited Warranty, please return the affected Product, or the affected part (if it is not an entire Product), to a Vertu-authorised service company. You can contact a Vertu call centre (national or premium rates may apply) for further details on how to make a claim. (Information about Vertu-authorised service companies and call centres can be found in the sales package, or on local Vertu web pages, where available.)

Any claim under this Limited Warranty is subject to you notifying Vertu or a Vertu-authorised service company of the alleged defect within a reasonable time of it having come to your attention, and in any event no later than the expiry date of the Warranty Period. When making a claim under this Limited Warranty, you will be required to provide: a) the affected Product (or the affected part); and b) the original proof of purchase, clearly indicating the name and address of the seller, the date and place of purchase, the Product type, and the IMEI or other serial number.

What is not covered?

1. Vertu does not provide a warranty for, or take any responsibility for, the functionality, content, or end-user support of third-party applications provided with your Product(s). By using an application, you acknowledge that the application is provided as is. Vertu does not make any representations, provide a warranty, or take any responsibility for, the functionality, content, or end-user support of third-party applications provided with your Product(s).
2. This Limited Warranty does not cover: a) normal wear and tear (including, without limitation, wear and tear of camera lenses, batteries or displays); b) defects caused by rough handling (including, without limitation, defects caused by sharp items, by bending, compressing or dropping, etc.); c) defects or damage caused by misuse of the Product(s), including use that is contrary to the instructions in this document, and in the user guide(s) for the Product(s); and/or d) other acts beyond the reasonable control of Vertu.
3. This Limited Warranty does not cover defects or alleged defects caused by the fact that the Product(s) was used with, or connected to, any device, accessory, software and/or service not manufactured, or supplied by Vertu, or was used other than for its intended purpose. Defects can be caused by viruses from your, or from a third party's, unauthorised access to services, other accounts, computer systems or networks. Such unauthorised access can take place through hacking, password mining or through a variety of other means.
4. This Limited Warranty does not cover defects caused by the fact that any battery for which you are making a claim has been short-circuited, or by the fact that the seals of the battery enclosure or the cells are broken or show evidence of tampering, or by the fact that the battery has been used in equipment other than that for which it has been specified.

5. This Limited Warranty is not enforceable if the Product(s) has been opened, modified or repaired by anyone other than an authorised service centre, if it is repaired using unauthorised spare parts, or if the serial number(s) of the Product(s), the mobile accessory date code, or the IMEI number, has been removed, erased, defaced, altered or are illegible in any way. This shall be determined by the sole discretion of Vertu.

6. This Limited Warranty is not enforceable if the Product(s) has been exposed to moisture, to dampness, to extreme thermal or environmental conditions or to rapid changes in such conditions, to corrosion, to oxidation, to spillage of food or liquid, or to influence from chemical products.

Other important notices

A third party/independent operator provides the SIM card and cellular and/or other network or system on which the phone operates. Therefore, Vertu will not accept responsibility under this Limited Warranty for the operation, availability, coverage, services or range of the cellular or other network or system. Before Vertu or a Vertu-authorised service company can repair or replace the phone, the operator may need to unlock any SIM-lock or other lock that may have been added in order to tie the phone to a specific network or operator. In such situations, please first ask the network or operator to unlock your phone.

Reverse engineering of software in the Product(s) is prohibited to the extent permitted by applicable law. Insofar as this user guide contains any limitations on Vertu's representations, warranties, damages and liabilities, such limitations shall likewise limit any representations, warranties, damages and liabilities of Vertu's licensors.

Please remember to make backup copies or keep written records of all important content and data stored in your phone, because content and data may be lost during repair or replacement of the phone. Vertu, in a manner consistent with the provisions of section "LIMITATION OF VERTU'S LIABILITY" below, shall not, under any circumstances, be liable, either expressly or by implication, for any damages or losses of any kind whatsoever resulting from loss of, damage to, or corruption of, content or data during repair or replacement of the phone.

All parts of the Product(s) or other equipment that Vertu has replaced shall become the property of Vertu. If the Product(s) is found not to be covered by the terms and conditions of this Limited Warranty, Vertu and its authorised service companies reserve the right to charge a handling fee. When repairing or replacing the Product(s), Vertu may use products or parts that are new, equivalent to new, or reconditioned.

The Product(s) may contain country-specific elements, including software. If the Product(s) has been re-exported from its original destination country to another country, the Product(s) may contain some country-specific elements that are not considered to be a defect under this Limited Warranty.

Limitation of Vertu's liability

This Limited Warranty is your sole and exclusive recourse against Vertu, and the only and exclusive liability of Vertu in respect of defects in your Product(s). This Limited Warranty replaces all other Vertu warranties and liabilities, whether oral, written, (non-mandatory) statutory, contractual, in tort or otherwise, including, without limitation, and where permitted by applicable law, any implied conditions, warranties or other terms as to satisfactory quality or fitness for purpose. However, this Limited Warranty shall neither exclude nor limit: i) any of your legal (statutory) rights under the applicable national laws; or ii) any of your rights against the seller of the Product(s).

Vertu

Keilalahdentie 2-4

FIN-02150 Espoo

Finland

Index

- A**
- alarm clock.....31
 - alarms.....31
 - alarm tone.....32
 - anniversary entries.....71
 - antennas.....21
 - applications.....28, 114, 118
 - audio messages.....60, 61
- B**
- backing up content.....78
 - barring calls.....53
 - battery
 - charging.....14, 15, 121, 122
 - saving power.....16
 - birthday entries.....71
 - blocking
 - devices.....76
 - blogs.....81
 - Bluetooth.....74, 75, 76
 - bookmarks.....80
 - breathing light.....29
 - browser
 - See *web browser*
 - business cards.....57, 75
- C**
- cable connection.....77
 - cache memory.....80
 - Calculator.....111
 - Calendar.....85
 - calendar.....30, 33, 69, 70, 71
 - appointments.....31
 - call waiting.....48
 - calls.....52
 - conference.....49
 - diverting.....52
 - internet calls.....50
 - last dialled.....51
 - making.....47
 - muting.....48
 - rejecting.....48
 - restricting.....53
 - camera.....86
 - location information.....87
 - recording videos.....88
 - sending pictures.....88
 - taking pictures.....86, 87
 - car kit.....125
 - care of your phone.....8
 - charging the battery.....14, 15, 121, 122, 123
 - chat services (IM).....58
 - City Brief.....24
 - clock.....31
 - analogue.....30
 - automatic time.....33
 - digital.....30
 - world clock.....32
 - compliance label
 - locating.....128
 - Concierge.....24, 25
 - Concierge Live.....26
 - connectivity.....78
 - contacts.....55
 - adding.....55
 - copying.....58, 119
 - editing.....55
 - favourites.....56
 - groups.....57
 - in social networks.....84, 85
 - pictures.....56
 - ringing tones.....56
 - saving.....55
 - searching.....47
 - sending.....57, 75
 - synchronising.....119
 - troubleshooting.....128
 - widgets.....36
 - copying content.....18, 77, 94, 119, 124
 - copyright protection.....95

D	
Dashboard.....	25
data connections.....	78
Bluetooth.....	74
dictionary.....	112
diverting calls.....	52
DRM (digital rights management).....	95
E	
e-mail	
<i>See mail</i>	
environmental tips.....	133
external memory.....	78
F	
factory settings, restoring.....	127
favourites.....	56
feeds, news.....	81
file management.....	116, 117
flashlight.....	43
FM radio.....	96, 97
Fortress.....	26, 115, 116
H	
headset.....	22, 125
help.....	7
home screen.....	27, 28, 34, 36, 67
I	
icons.....	42
IM (instant messaging).....	58
images	
<i>See pictures</i>	
inbox, messages.....	61
indicators.....	42, 127
installing applications.....	118
internet	
<i>See web browser</i>	
internet calls.....	50
internet connection.....	73
intranet.....	82
J	
Java applications.....	118
K	
key lock.....	14
keyboard.....	37, 38
keyguard.....	14
keypad.....	40
keys and parts.....	9, 10, 11
L	
language settings.....	63
lanyard.....	22
licences.....	95
location information.....	71, 87
lock code.....	120
locking	
device.....	120
keys.....	14
remotely.....	120
screen.....	14
Log.....	52
loudspeaker.....	21
M	
mail.....	64, 65
attachments.....	67
creating.....	67
folders.....	64
mailbox.....	64
reading and replying to.....	66
sending.....	67
setup.....	18, 64
widgets.....	67
Mail for Exchange.....	18, 65
mailbox.....	64
voice.....	52
Maps.....	98
browsing.....	98
changing views.....	100
compass.....	101
display elements.....	99, 107

downloading maps.....	100
driving routes.....	106
Favourites.....	104
feedback.....	109
finding locations.....	102
location details.....	103
navigating.....	106, 107
organising places.....	104
organising routes.....	104
planning routes.....	108
positioning.....	101
saving places.....	103
saving routes.....	103
sharing locations.....	104
synchronising.....	105
traffic information.....	107
viewing saved places.....	103
viewing saved routes.....	103
voice guidance.....	105
walking routes.....	107
mass memory.....	117
mass storage.....	124
media feeds.....	81
meeting entries.....	69, 70
memory.....	116, 128
clearing.....	117, 127
menu key.....	29
message reader.....	62
messages.....	60, 61, 127
audio.....	61
conversations.....	62
sending.....	60
Microsoft Exchange Server.....	66
MMS (multimedia message service)	60
movies.....	90
multimedia messages.....	60
multitasking.....	28
music.....	93, 94
playlists.....	94
music stand.....	125
My Card.....	57

N

news feeds.....	81
Nokia Ovi Suite	
See <i>PC Suite</i>	
Notes.....	112
notification light.....	29, 43

O

office applications.....	111
Office Communicator.....	58
offline profile.....	43

P

package contents.....	12
PC Suite.....	120, 124
personalising your phone.....	34, 45
phone	
rebooting.....	23, 127
switching on/off.....	23, 127
Phone switch.....	119
phonebook	
See <i>contacts</i>	
Photo editor.....	90
photographs	
See <i>pictures</i>	
pictures	
copying.....	77, 119
editing.....	90
location information.....	87
printing.....	91
sending.....	75, 88
sharing.....	84
taking.....	86, 87
viewing.....	89, 92
playlists.....	94
Portable Power.....	122
powering on/off.....	23
powering phone on/off.....	23, 127
printing.....	91
profiles.....	45
creating.....	45
offline.....	43

personalising.....	45	slideshow.....	91
Q		SMS (short message service).....	60
Quickoffice.....	111	social networks.....	83, 84, 85
QWERTY.....	38	soft keys.....	29
R		software.....	118
radio.....	96, 97	software updates.....	114
RDS (radio data system).....	96, 97	speakerphone.....	21
rebooting.....	23, 127	specifications.....	131
recording		speed dialling.....	49
calls.....	51	status updates.....	84
sounds.....	95	support.....	7
videos.....	88	switching on/off.....	23
recycling.....	133	switching phone on/off.....	23, 127
registration.....	17	Swype.....	37
Remote Assist.....	26	synchronisation.....	118, 119
remote drives.....	78	Microsoft Exchange Server.....	66
remote lock.....	120	T	
remote locking.....	120	taking pictures	
restoring settings.....	127, 128	<i>See camera</i>	
ringing tones.....	56	tasks.....	69
ringtones.....	45, 51	Technical Support.....	25, 26
S		text input.....	37, 38, 39, 40, 41
searching.....	44	text messages.....	60
contacts.....	47	text phone.....	125
radio stations.....	96	tones	
security code.....	120	personalising.....	45
Select.....	24	touch screen.....	40
sensor settings.....	51	touch screen.....	19
settings		transferring content.....	18, 77, 94, 119, 124
access points.....	73	turning on/off.....	23
language.....	63	turning phone on/off.....	23, 127
restoring.....	127, 128	TV	
Setup wizard.....	18	viewing pictures and videos on.....	92
sharing, online.....	84	TV out.....	125
shortcuts.....	36	type label	
silent profile.....	45	finding.....	128
SIM card.....	58	U	
inserting.....	12	updates	
removing.....	12	applications.....	114
		device software.....	114

phone software.....	114
USB charging.....	14, 15
USB connection.....	77, 78, 124
user guide.....	7

V

Vertu City Brief.....	24
Vertu Concierge.....	24, 25
Vertu Fortress.....	26, 115, 116
Vertu Select.....	24
videos.....	92
copying.....	77, 119
editing.....	90, 91
location information.....	87
playing.....	92
recording.....	87, 88
sending.....	75
sharing.....	84
watching.....	89, 92
virtual keyboard.....	37, 38
virtual keypad.....	40
voice calls	
See <i>calls</i>	
volume control.....	21

W

wall charger.....	121
wallpaper.....	34
web browser.....	80, 128
bookmarks.....	80
browsing pages.....	80
cache memory.....	80
intranet.....	82
web connection.....	73
web feeds.....	81
widgets.....	34, 35, 36, 67
WLAN (wireless local area network).....	
73, 74	
world clock.....	32

Z

zip files.....	113
----------------	-----

