

**VERTU**

HANDMADE IN ENGLAND

**ASTER T**

USER GUIDE VERSION 1.0

# Contents

<b>Introduction</b> .....	<b>5</b>	<b>Vertu Services</b> .....	<b>23</b>
Your Aster T phone .....	5	About Vertu Services .....	23
Help and support .....	5	<b>Text entry</b> .....	<b>25</b>
<b>Safety</b> .....	<b>6</b>	Keyboard entry .....	25
Safety .....	6	Predictive text .....	25
<b>Your phone</b> .....	<b>7</b>	Gesture typing .....	26
Package contents .....	7	Dictionaries .....	26
Features and keys .....	7	Change the keyboard language .....	26
Antenna locations .....	8	<b>Calls</b> .....	<b>27</b>
Headset .....	9	About calls .....	27
Change the volume .....	9	Make and answer calls .....	27
<b>Getting started</b> .....	<b>10</b>	Call the last number dialled .....	28
Insert the SIM card .....	10	Quickly call your favourites .....	28
Charge the phone .....	11	Listen to your voicemail .....	28
Switch the phone on or off .....	12	Divert calls to another number .....	29
Touch screen actions .....	13	Make a conference call .....	29
Start-up process .....	14	<b>Contacts</b> .....	<b>30</b>
Use your phone when it is locked .....	15	About contacts .....	30
<b>Explore</b> .....	<b>16</b>	Call, text or email contacts .....	30
About the home screen .....	16	Add contacts .....	31
Status and notification bar .....	16	Join contacts .....	31
Status and notification icons .....	17	Edit or delete a contact .....	31
Clock widget .....	18	Save a number from a call or message .....	31
Back, home and recent apps .....	18	Mark contacts as favourites .....	32
Add widgets to the home screen .....	18	Personalise contacts .....	32
Favourites tray .....	19	Transfer contacts .....	32
Aeroplane mode .....	19	<b>Messaging and email</b> .....	<b>34</b>
Voice actions .....	19	About messaging .....	34
<b>Apps</b> .....	<b>20</b>	Send and read messages .....	34
About apps .....	20	Send a message to a group .....	34
Recommended apps .....	20	Instant messages .....	34
Google Play™ .....	20	Manage messages .....	35
Apps precautionary advice .....	21	Corporate email setup .....	35
Update apps .....	21	Google mail setup .....	35
Manage and restore apps .....	21	Personal email setup .....	36
Close apps .....	21	<b>Music</b> .....	<b>37</b>
Uninstall apps .....	22	About music .....	37
		Adding songs or albums to Play Music .....	37
		Play music .....	38

<b>Maps and navigation</b> .....	<b>40</b>	Share photos and videos .....	52
Google Maps™ .....	40	View an album .....	52
Google Maps™ with Navigation beta ...	40	Create a folder .....	53
<b>Personalising your phone</b> .....	<b>41</b>	Assign contact images and wallpaper ..	53
Widgets .....	41	Take a screen shot .....	53
Shortcuts .....	41	<b>Office tools</b> .....	<b>54</b>
Ringtones .....	41	Clock .....	54
Wallpapers .....	42	Calculator .....	54
Assign sounds to actions .....	42	Calendar .....	54
Display settings .....	42	<b>Connectivity</b> .....	<b>56</b>
Auto-rotate .....	42	Wi-Fi .....	56
Screen lock .....	43	Bluetooth .....	56
Date and time settings .....	43	Location services .....	57
Language and region settings .....	43	Set your phone to sync with your computer .....	58
<b>Social networks</b> .....	<b>44</b>	Copy between the phone and a PC ...	58
Add an account .....	44	Tethering and portable hotspot .....	59
Delete an account .....	44	NFC .....	59
Synchronise contacts .....	44	<b>Phone management</b> .....	<b>60</b>
<b>Managing accounts</b> .....	<b>45</b>	System update .....	60
Configure sync options .....	45	Free up phone memory .....	60
Add and delete accounts .....	45	Optimise data usage .....	60
Backup and restore accounts .....	45	Data roaming settings .....	61
<b>Browser</b> .....	<b>46</b>	Back up and restore your phone .....	61
About the web browser .....	46	Set your phone to lock automatically ...	61
Browse the web .....	46	Change your PIN code .....	61
Connect to the internet .....	47	Access codes .....	62
Add a bookmark .....	47	Master reset .....	62
Widget feeds .....	47	<b>Tips and tricks</b> .....	<b>63</b>
Privacy and security .....	47	General tips .....	63
Downloads .....	48	Extend battery life .....	64
<b>Camera</b> .....	<b>49</b>	<b>FAQs</b> .....	<b>65</b>
About camera .....	49	Questions .....	65
Take and share photos .....	49	How can I extend the battery life of my phone? .....	66
Camera settings .....	50	Do I need a Google™ account to use my phone? .....	66
Record and share a video .....	50	How can I reduce my data costs, especially when abroad? .....	66
Video settings .....	51		
<b>Gallery</b> .....	<b>52</b>		
About gallery .....	52		
View and edit photos and videos .....	52		

How do I transfer music from my computer to my phone? .....	67
How can I listen to my iTunes music library on my phone? .....	67
How do I setup an email account on my phone? .....	68
How do I transfer contacts to my phone? .....	68
How do I set my music as ringtone? .....	69
How do I change the font size on my phone? .....	69
How do I check if I have the latest software updates on my phone? .....	69
Why have I got no connectivity? .....	69
Why is my internal storage less than advertised? .....	70
How do I protect my phone from unauthorised use? .....	70
How do I find the IMEI number of my phone? .....	70
How can I clear the log of my calls or the list of people I have contacted frequently? .....	70
Why does my phone get warm? .....	70
How do I know how much storage I have on my phone? .....	71
How do I set a photo as my wallpaper? .....	71
Can I still use Google Maps if I do not have a data connection? .....	71
<b>Accessories .....</b>	<b>72</b>
Battery charger .....	72
Data cable .....	73
Wired stereo headset .....	73
<b>Specifications .....</b>	<b>74</b>
Specifications .....	74
<b>Care of your phone .....</b>	<b>76</b>
General care .....	76
Embroidery .....	76
Exotic leathers .....	76
Leather .....	77
Non-precious metals .....	77
Precious metals .....	77
Precious stones .....	77
Sapphire and ceramics .....	78
<b>Safety and warranty .....</b>	<b>79</b>
Safety text .....	79
Additional care and maintenance .....	83
Manufacturer's Limited Warranty .....	84
Software application notices for the phone .....	87
Environmental .....	89
Export and controls .....	90
Copyright and trademark notices .....	90
SAR (Specific Absorption Rate) notice - VM-01T .....	91
Declaration of Conformity .....	92

# Introduction

## Your Aster T phone

This user guide is intended to provide you with details on how to use the prominent features on your Aster T.

To access the exclusive privileges and benefits such as Vertu Life, Vertu Concierge, and Vertu Certainty, you must register your phone.

The pictures used in this user guide are provided for illustration purposes only. They may differ from the exact appearance of your Aster T.

## Help and support

To find out more about using your phone:

- Contact Vertu Customer Service by either pressing the Vertu key or through the Vertu Certainty app.
- Refer to the user guide on your phone from the Vertu Certainty app, or on the Vertu website at <http://www.vertu.com/help-and-support/user-guides-and-downloads.aspx>.
- Use the setup wizards available on the phone to help you with registration to create an email account.

## Compliance information

You can find compliance information on a retractable metal flap that is located in the SIM compartment. For instructions on accessing the SIM compartment, see "Insert the SIM card" on page 10. The information displayed includes the IMEI number, serial number, product name and 2D barcode.

---

# Safety

## Safety

Read these simple guidelines. Not following them may be dangerous or illegal. Read the complete user guide for further information.



### **Switch off in restricted areas**

Switch the device off when mobile phone use is not allowed or when it may cause interference or danger, for example, in aircraft, in hospitals or near medical equipment, fuel, chemicals, or blasting areas. Obey all instructions in restricted areas.



### **Road safety comes first**

Obey all local laws. Always keep your hands free to operate the vehicle while driving. Your first consideration while driving should be road safety.



### **Interference**

All wireless devices may be susceptible to interference, which could affect performance.



### **Qualified service**

Only qualified personnel may install or repair this product.



### **Keep your device dry**

Your device is not water-resistant. Keep it dry.



### **Protect your hearing**

To prevent possible hearing damage, do not listen at high volume levels for long periods. Exercise caution when holding your device near your ear while the loudspeaker is in use.

# Your phone

## Package contents

- Aster T phone
- Wall charger (AC-32V) with regional plugs
- MicroUSB cable 1200 mm (CA-225DV)
- V Collection Wired Headset, Type WH-4V/WH-5V
- Polishing cloth
- NanoSIM to microSIM adapter
- Collateral pack, including Quick Start Guide, and Authenticity Card

The package contents may vary slightly in accordance with the materials used in your particular phone and with regional regulations.

## Features and keys

### Front

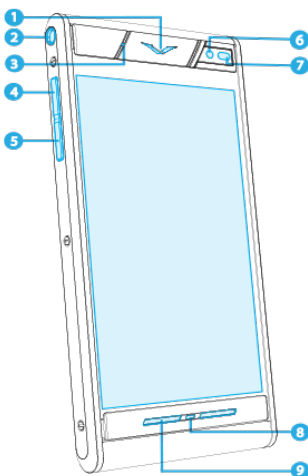

- 1 Earpiece speaker
- 2 Headset connector
- 3 Notification light
- 4 Volume up key
- 5 Volume down key
- 6 Front camera
- 7 Ambient light sensor
- 8 Microphone
- 9 Loudspeaker (Stereo)

## Back

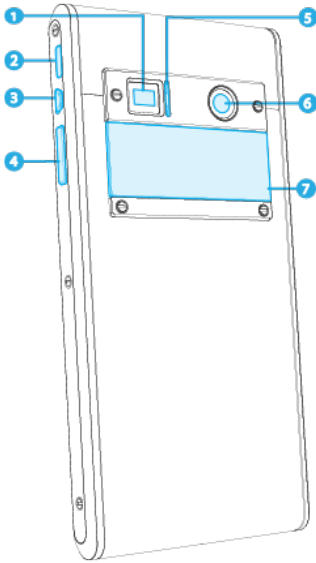

- 1 LED flash
- 2 MicroUSB connector
- 3 Vertu key
- 4 Power key/screen lock
- 5 Noise-cancelling microphone
- 6 Main camera
- 7 Back cover

## Antenna locations

Avoid touching the antenna areas while the antennas are in use. Contact with antennas affects the communication quality and may reduce battery life due to higher power levels during operation.

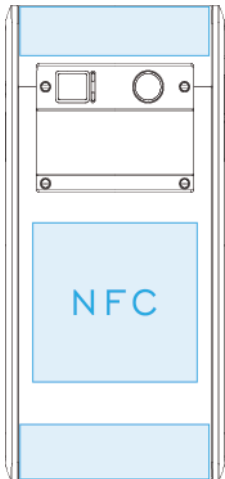



## Headset

Use the headset provided to connect to your phone. Alternatively, you can connect any compatible headsets.

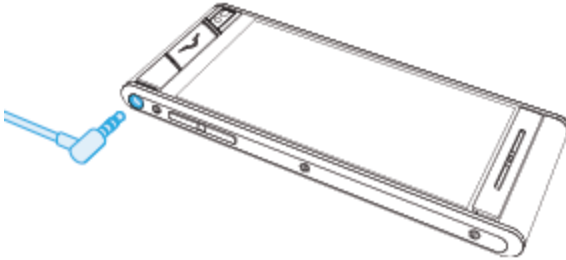

## Change the volume

Press the volume keys to change the volume of your ringtone or adjust the volume during a call. The Dolby Sound interface appears, use it to adjust the volume and settings on your phone.

Touch  to open Dolby sound quick options.

Touch  to open volume settings panel to customize music, ringtones, notifications, and alarms.

Touch  to open the standard Android sounds settings view.

# Getting started

## Insert the SIM card

Your Aster T phone is equipped to work with a microSIM card. If you are currently using a nanoSIM card, please use the adapter included in the sales pack.

 **Important:** Use of a nanoSIM card without the adapter may damage the card or your phone and may corrupt data stored on the card.

To avoid damaging the SIM card or your phone, follow these steps carefully:

1. Press and slide the back plate cover to open.

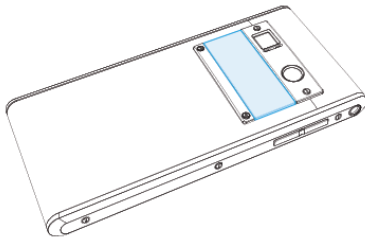

2. Next open the SIM door and place your microSIM into the cavity as shown.

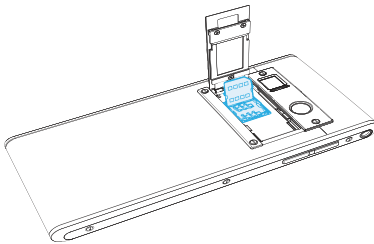

3. Finally, close the SIM door and lock into place (pictured). Then close the back cover and slide back.

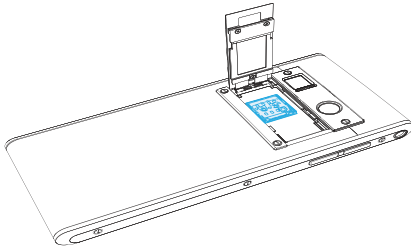

## Charge the phone

The internal battery needs activating prior to first use, and it is recommended to charge the battery at this point as it may not have been supplied with a full charge. Connect the supplied USB data cable into the charging port on the side of the phone. Then connect the other end of the cable to the USB port on your Vertu mains charger.



**Important:** Use only chargers, cables and accessories supplied by Vertu.

If the phone indicates a low charge, do the following:

1. Connect the supplied wall charger to the wall outlet and then insert the microUSB connector into your phone.

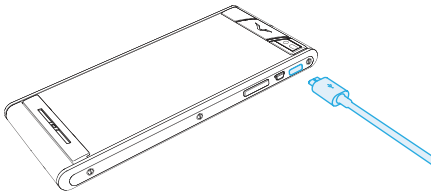

2. When the battery is fully charged, disconnect the charger from the phone and then from the wall outlet.

**Note:**

- You can use the phone while it is charging.
- If the battery is completely discharged, it may take several minutes before the charging indicator is displayed or before you can make any calls.
- The phone cannot be activated using the Vertu Wireless Powerpack.

**Other ways to charge the battery**

You can also charge your phone by connecting it to your computer using the USB cable, or by placing it on the optional Vertu Wireless Charging Stand.

**Note:** Your phone charges quicker when connected to the wall charger.

**Extend battery life**

For tips on how to extend battery life, see "Extend battery life" on page 64.

**Switch the phone on or off**

**Switch on:** Press and hold the Power key until the phone vibrates.

**Switch off:** Press and hold the Power key, and then touch **Power off**.

In the unlikely event that your phone stops responding, reboot it. To reboot, press and hold the Power and Volume Down keys, at the same time, until the phone vibrates. This takes approximately 10 seconds.

**Note:** Always remember to power off your phone before removing and inserting a SIM card. This action will ensure that your network connectivity is restored.

## Touch screen actions



**Important:** Avoid scratching the touch screen. Never use a pen, pencil, or other sharp object on the touch screen.

### Touch

To select an item on the screen, touch it.

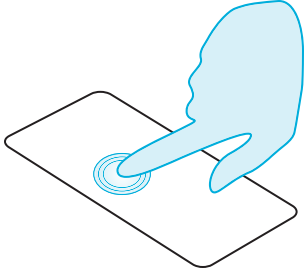

### Touch and hold

To select an item and the actions associated with it, touch and hold.

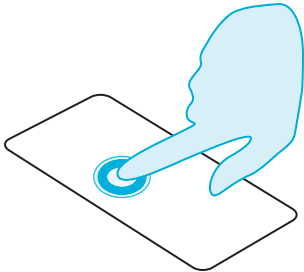

### Drag

Touch and hold the item, and then slide your finger across the screen.

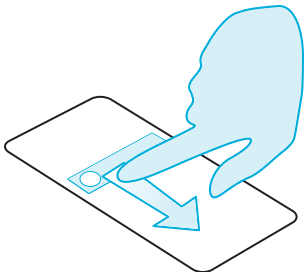

## Flick

Scroll quickly between views or through lists.

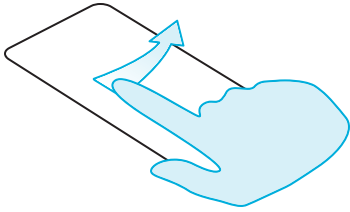

## Pinch or double-touch

Place two fingers on an item, such as a photo or web page, and then slide your fingers apart to zoom in or together to zoom out.

Or, simply double touch the item to zoom in or out.

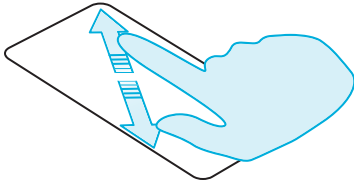

## Start-up process

### 1 Google™ registration

If you do not already have a Google account, you will be prompted to create one during the registration process. This is highly recommended as a Google account will give you access to Google Play™ and other Google apps.

Once you've logged in, all your Gmail™ contacts are synced to your Aster T, ready for use.

Gmail provides the primary means for backing up the contacts, emails and calendars associated with your account.

### 2 Vertu registration

If you are a new Vertu customer you will be asked to create a Vertu account. If you already own a Vertu phone you can simply log in to your existing account with your Vertu username and password.

Completing Vertu registration will give you access to unique privileges and benefits relevant to you.



**Tip:** For quick access to the range of exclusive services, press the Vertu key.

### 3 Recommended apps



For more on the apps that Vertu recommend, see "Recommended apps" on page 20.

### 4 Transfer contacts

Transfer contacts to your phone with your Gmail™ account or your SIM card.

For information on transferring contacts, see "Transfer contacts" on page 32.

## Use your phone when it is locked

To unlock the screen, press the Power key and then touch  and drag to .

You can lock the screen either by pressing the Power key or by simply leaving the screen to time out.

For more information on different screen lock types, see "Screen lock" on page 43.

# Explore

## About the home screen

The home screen acts as a gateway to the functions on your phone while also providing you with all the latest information:



- 1 Status and notification bar
- 2 Widget
- 3 Apps menu
- 4 Favourites tray
- 5 Back, Home and Recent Apps

## Status and notification bar

Status information, such as time, network signal strength and battery level indicator, is displayed at the top right of the screen.

Any notifications, such as new messages or calendar appointments, are displayed in the top left of the screen. To see your notifications, touch the bar and drag down. Touch a notification to open it.

You can also quickly control your Wi-Fi, Bluetooth, GPS, mobile data, USB connectivity and display options from the status and notification bar.











Touch Home  to close the status notification bar.



**Tip:** Flick the notification left or right to clear it from the list.



## Status and notification icons

	Network (full signal)		New Gmail
	No network		Wi-Fi connected
	GPRS data connection		Wi-Fi available
	Warning		Bluetooth™ connected
	+ (fastest data)		Bluetooth connected to an aptX® compatible accessory
	Battery (full charge)		GPS (location found)
	Battery (charging)		GPS (searching)
	Battery (empty)		USB connected
	Active call		Downloading
	Missed call		Uploading
	New voicemail		Preparing SD card
	Calendar reminder		Background data sync
	New SMS		Alarm set
	New MMS		Silent
	New chat		Vibrate
	New email		Aeroplane mode on

## Clock widget

The clock widget on the home screen displays the following information:

- Analogue clock with a digital date indicator
- Alarms set for the next 12 hours
- Free and busy periods, taken from the calendar, around the clock bezel
- Local time. If you are roaming, the clock displays both the local time and the time at your home location.

To set an alarm, touch the centre of the clock.

To display an appointment, touch the appropriate quadrant of the clock, and then touch the pop-up to open the appointment. To clear the appointment, touch the screen.

## Back, home and recent apps

You can use the three icons on the bottom of your screen to navigate between screens and apps.

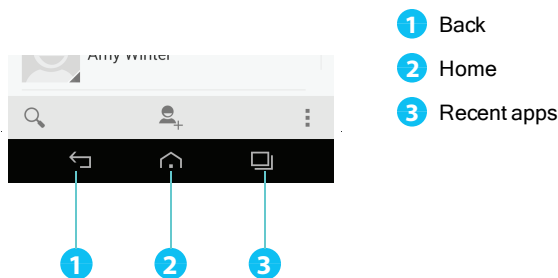

Touch Back to go back to your previous screen.

Touch Home to move an app to the background and return to the home screen. Touch and hold Home to go to the search screen.

Touch Recent apps to view a list of the apps you have used most recently.

## Add widgets to the home screen

Widgets are apps that provide live content such as news, weather forecasts and messages.

To add widgets to the home screen:

1. Press and hold the home screen.
2. Touch **WIDGETS**.
3. To select a widget, touch and hold it, and then drag it to the home screen.

---

To see the widget menu options, open the widget and touch .

To resize certain widgets, such as **Calendar**, touch and hold the widget and then release it. The widget is then highlighted and you can drag it to the size required.

**Note:** Downloaded apps from Google Play may automatically download other associated widgets. To check your widgets, touch and hold the home screen and then touch **WIDGETS**.

## Favourites tray

The favourites tray appears at the bottom of the home screen. Use it to access your favourite apps quickly.

To remove an app from the favourites tray, touch and hold the app then drag to **Remove** at the top of the screen.

**Note:** You cannot remove the  Apps shortcut from the favourites tray.

To add an app to the favourites tray, touch  Apps. Touch and hold the app, and drag it to the favourites tray.

## Aeroplane mode



To turn off all the wireless connections on your phone, press and hold the Power key > **Aeroplane mode**.



**Tip:** Aeroplane mode helps to conserve battery power.

## Voice actions

With voice actions you can set an alarm, call friends, and more just by speaking clearly into your phone.

- **Voice dialling:** on the home screen, touch  and then say "Call" and then a contact name or phone number.
- **Voice commands:** on the home screen, touch  and then say a command, such as "Open Calendar".

# Apps

## About apps

Your Aster T gives you access to a wide range of useful apps.

To access your apps, touch  Apps from the home screen. Flick left or right to see all your apps.

To close the apps screen, touch Home .

To view your most recently used apps, touch Recent apps .

## Recommended apps



Recommended apps provides you with a single, trusted destination where you can quickly and simply browse and install the apps you use every day. The selection of apps displayed has been chosen based on your country, ensuring that they are relevant to you.

## Google Play™



The Google Play Store app will help you with just about anything.

Scroll to the app you want to install, and then touch **Install** (if the app is free) or touch the price to buy. Once installed, the new app is displayed in the apps screen.

To view a list of your downloaded apps, touch  Apps >  **Settings** > **Apps**. A list of your downloaded apps is displayed, and these apps are available to download again.

To conserve data usage and only update your apps over Wi-Fi, touch  Apps >  **Play Store** >  > **Settings** > **Auto-update apps** > **Auto-update over Wi-Fi only**.



**Important:** Choose your apps carefully from trusted sites, or you can rely on Vertu recommended apps. See "Apps precautionary advice" on page 21 and "Recommended apps" page 20.

Your application purchases are tied to your Google account and can be installed an unlimited amount of times on any device. So, for example, if you remove 'My Favourite Game' to save memory, you can reinstall it at a later date with no charge by simply visiting My Apps. For more information on My Apps, see "Manage and restore apps" on page 21. You can also re-install apps from the My Android™ Apps section of [play.google.com](http://play.google.com).



## Apps precautionary advice

To protect your phone from the threat of spyware, phishing, or viruses, it is important that you choose your apps carefully. For Vertu-recommended security apps, see "Recommended apps" on page 20.

- Some apps drain your phone of phone memory and battery more than others. If you find that an app is draining your phone, simply uninstall it. For more information, see "Uninstall apps" on page 22.
- Before you get Android apps on Google Play, check the ratings and comments. If you aren't convinced by the legitimacy of an app, don't install it.
- Some apps may contain inappropriate content for children.

## Update apps

If you receive an over-the-air notification of an update on your phone for a Google Play™ app, you can follow the instructions to download and install the update software or you can opt to dismiss the notification.

The **Allow automatic updating** setting is often activated by default when you install an app. To change this setting, touch  Apps >  Play Store >  > **Settings > Auto-update apps**.





**Tip:** To conserve data usage and only update your apps over Wi-Fi, touch  Apps >  Play Store >  > **Settings > Auto-update apps > Auto-update over Wi-Fi only**.

## Manage and restore apps

To manage your apps, touch  Apps >  **Settings > Apps > All**.

Touch an app to see its details (such as access permissions and file size), and then touch to select options such as force the app to stop, uninstall, or clear data.

To restore apps that you have previously installed from Google Play Store, touch  Apps > **Play Store >  > My apps**. A list of your downloaded apps is displayed, and these apps are available to download again.

## Close apps

To close an app, touch Home .

Many of your apps will continue to run in the background after you have closed them. To quickly open recently used apps, touch Recent apps .



**Tip:** To remove apps from this list, flick left or right.

## Uninstall apps

To delete an app, touch  Apps >  **Settings** > **Apps** > app name > **Uninstall**.

# Vertu Services

## About Vertu Services

Your unique Vertu experience starts with registration. Once you have successfully registered your phone you are able to access the privileges and benefits by pressing the Vertu Key.

### Vertu Life

Enter a world of opportunity with exclusive access to curated experiences and events. These have been selected for you using our expertise and influence.

Enjoy privileged access to a private members club in Hong Kong, tickets for the Champions League final or an invitation to join the stars at the Academy Awards, all dynamically delivered through your handset.

Vertu Concierge is heavily integrated into the Life app, meaning that any of the content which interests you can be activated quickly and simply.

You can also manage your Concierge requests directly within the Life app.

**Vertu Concierge provides expert assistance designed to meet your every need, 24/7 via voice, email or Live Chat.**

More than ever before, the content delivered to you within the Life app will be tailored to your interests. In the app you can adjust your profile, including your interests. This personalisation will enhance the content that you see when you visit Vertu Life.

Vertu World View puts the exclusive world of Vertu Life into your hands. A finger touch allows your mind to travel anywhere on the globe to explore the beauty of what Vertu Life has to offer.

### Vertu Certainty

The concept for Vertu Certainty is to protect your phone, and your data. The Certainty app is divided into two sections.

The first section is about the phone. Here you can read the online user guide, including FAQs and information on how to care for the phone, or there is quick access to call or email Vertu Customer service for any additional support.

Once you have called Vertu Customer service, and provided that Vertu has your consent, the Remote Assist service enables the Technical Support Team to access your Aster T remotely. The service is intended to assist you if you have problems setting up or using your phone. Please contact Vertu Customer service if you wish to use the service. In this section of the app, you can also see the status of your warranty.

The second section of the Certainty app is about protecting your data. Here the application shows, in a graphical representation, how much of the internal data storage and how much of your Google Drive™ cloud data storage you are using. There is also a quick link to launch the Google Drive cloud data application. Finally there is a link to our Recommended apps section to support you with other data protection issues, such as anti-virus and malware, remote lock/track and wipe, and various elements of data backup.



# Text entry

## Keyboard entry

To open the touch screen keyboard, touch a text entry box. To enter text, touch the letters on the keyboard. The keyboard is displayed in your country's native text input format, for example, QWERTY, in both portrait and landscape modes.



**Tip:** You may find it easier to use the keyboard in landscape mode.

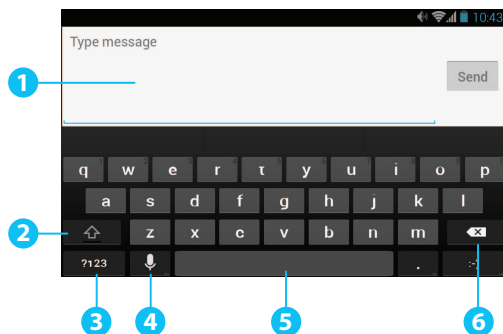

- 1 Text box
- 2 Shift
- 3 Keyboard for numbers and symbols
- 4 Speech-to-text dictation
- 5 Space
- 6 Delete

## Cut, copy and paste text

Touch and hold a section of text to select it. Tabs appear, marking the boundaries of the selection. Drag these tabs to reduce or increase the selection, and then touch or to cut or copy. (In a landscape display, touch **Edit** to view your options.) To paste the text, touch the point where you wish to insert it, and touch the tab that appears. Then touch **Paste**.

## Predictive text

Predictive text input is based on a built-in dictionary to which you can add new words. It is not available in all languages, and is active by default. As you start typing a word, your phone suggests possible words for you to choose. When the correct word is displayed, touch the word. If the word is not in the dictionary, the phone suggests an alternative word from the dictionary. To add a new word to the dictionary, touch the word you have typed.



**Tip:** To see a menu of punctuation marks, touch and hold the full stop key.

## Gesture typing

For many languages, your phone lets you to spell out words by sliding a finger tip across the keyboard. As you move between keys, your movements are traced by a blue trail across the keyboard and the word you have spelt out appears in the middle of the strip above the keyboard. To end a word and insert a space, lift your finger. The phone automatically inserts spaces between words.

## Dictionaries

To view your dictionaries, touch  Apps >  **Settings** > **Language & input** > **Personal dictionaries**.

Touch **+** to add words to your dictionary.

## Change the keyboard language

To change the language on your keyboard, touch  Apps >  **Settings** > **Language & input** and select another option from **KEYBOARD & INPUT METHODS**.

**Note:** The keyboard options available will change depending on your language selection.

If you change the keyboard language and you want to be able to use spellcheck for the new language, you must install an additional keyboard dictionary. Under **KEYBOARD & INPUT METHODS**, touch  (Google Keyboard) > **Add-on dictionaries** > a listed dictionary option > **Install**.

# Calls

## About calls



- 1 Recent calls
- 2 Calls
- 3 Options menu

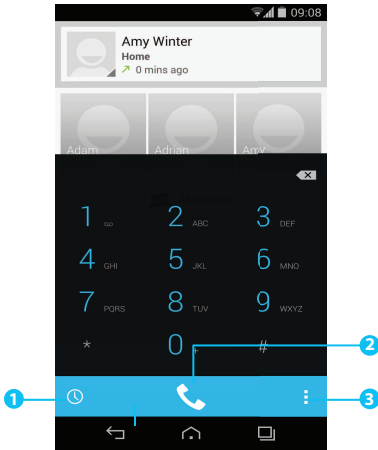

## Make and answer calls



To make a call:





1. Touch Apps > Phone > dial pad and enter the phone number on the dial pad.
2. To make the call, touch .
 

**Note:** To enter the + character, used for international calls, touch and hold **0**.
3. To end the call, touch .





**Tip:** To voice dial a contact from the home page, touch and say "Call" followed by a contact name.

To answer a call, touch  and drag to .

- To send an incoming call to your voicemail, touch  and drag to .
- To send an automated text message to the caller, touch , drag to , and then select an appropriate message.
- To silence an incoming call, press the Power key or Volume keys.



## Call the last number dialed



The call log displays information about the calls you have made and received. This makes it easy to call someone again if they are not answering. Simply access the call log and quickly retrieve the number.

From the home screen, touch  **Phone** > .

- To call a number, touch the phone icon next to the contact.
- To see call details, touch the contact.
- To clear the list, touch  **Clear call log**.

## Quickly call your favourites

To quickly call your most frequently called contacts, from the home screen touch  **People** > .

- To call, text, email, or view contact information, touch the contact.
- To edit, share or delete a contact, or to set a ringtone for a contact, touch the contact and then touch .
- To clear the list of frequently called contacts, display the list >  > touch **Clear frequents**.

## Listen to your voicemail

You can divert your incoming calls to your voicemail (network service). Also, people can leave you a message, for example, when you have not answered the call.

To listen to your voicemail messages, from the home screen touch  **Phone**, and then touch and hold 1 on the dial pad.

---

## Divert calls to another number

If you cannot answer your calls, you can divert incoming calls to another phone number.

From the home screen, touch  **Phone** >  > **Settings** > **Call forwarding**.

Several diverting options, such as **Forward when busy** and **Forward when unanswered** can be active at the same time.

**Note:** Call divert is a network service. For details, contact your service provider.

## Make a conference call

To start a conference call:

1. Call the first number.
2. After the call connects, touch .
3. Dial the next number, or select it from contacts or favourites.
4. When the next number answers, touch **Merge calls**.

**Note:** Conference calls are a network service. For details, contact your service provider.

# Contacts

## About contacts

With contacts, you can save and organise your friends' phone numbers, addresses and other contact information.

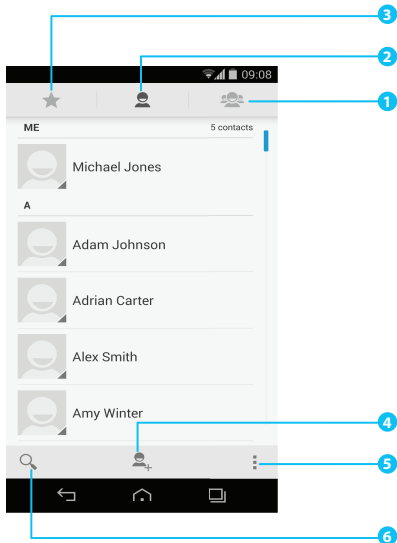

- 1 Groups
- 2 People
- 3 Favourites
- 4 Add a contact
- 5 Options menu
- 6 Search

## Call, text or email contacts



To call a contact, touch the contact and then touch the phone number.

To text a contact, touch the contact and then touch .

To email a contact, touch the contact and then touch the email address.

## Add contacts



1. Select an account to back up your contact.

**Note:** If you have not set up an account, like a Google or email account, your contact is only saved to your phone memory.

2. Enter the contact details, and then touch **DONE**.



**Tip:** Backing up your new contact to an account will also sync it to that account.

## Join contacts

If you have two or more contacts for the same person, maybe a Gmail contact that is also stored on your phone, you can join them.

Touch Apps > **People** > contact name > > **Edit** > > **Join**, and then touch the contact that you want to join.

## Edit or delete a contact

To edit or delete a contact, touch Apps > **People** > contact name > > **Edit** or **Delete**.

## Save a number from a call or message

When you receive a call or a message from a person whose phone number is not yet saved in the contacts list, you can save the number in a new or existing contact list entry.

To save a number from a received call:

1. From the home screen, touch **Phone** > .
2. Touch the call entry, and then touch .
3. Touch **CREATE NEW CONTACT**, and then enter the contact details.
4. Touch **DONE**.

To save a number from a received message:

1. From the home screen, touch Apps > **Messaging**.
2. Touch the message entry, and then touch > **Add to People**.
3. Touch **CREATE NEW CONTACT**, and then enter the contact details.
4. Touch **DONE**.

## Mark contacts as favourites

You can find and call important contacts more quickly if you mark them as favourites.

- To mark a contact as a favourite, touch  >  >  > a contact > . The star changes from white to grey. To remove a contact from your favourites, touch the grey star.
- To view the list of your favourites, touch  >  > .



**Note:** The screen of favourite contacts also includes a list of the people that you have contacted most frequently.

- To clear the list of frequently contacted people, display the favourites list >  > touch **Clear frequents**.

## Personalise contacts

Set unique photos and ringtones for your contacts.



To add a photo, touch the contact >  > **Edit** > .

To add a ringtone, touch the contact >  > **Set ringtone**.

## Transfer contacts

You can transfer contacts to your Aster T by using your Gmail™ account or by using your SIM card.

### Gmail

You can transfer your contacts to a Comma Separated Values (.csv) text file. After you have imported this file into your Gmail account, it will automatically sync with your phone (if you have already set up a Gmail account).

1. Export the contacts on your previous phone to a .csv file. For information on how to do this, refer to the user documentation supplied with your previous phone.
2. Log into your Gmail account on your PC and click **Contacts > Import Contacts**.
3. Click **Browse** and select the .csv file that you created.
4. Click **Import Contacts**.



 **Important:** Syncing your contacts with your Gmail account means that your contacts will always be backed up.

### SIM card

For details on exporting contacts stored on your old phone to your SIM card, refer to the user documentation supplied with your previous phone.



---

Then, to import these contacts stored on your SIM card to your Aster T, touch  Apps >  People >  > **Import/export** > **Import from SIM card**.

**Note:** Transferring contacts with your SIM card may result in some contacts data being lost.

# Messaging and email

## About messaging





You can send and receive various kinds of messages:

- Text messages
- Multimedia messages that contain photos, videos or audio

## Send and read messages



To send a message:

1. Enter the recipient and then type your message. Touch  to **Insert smiley** or **Add subject**.  
**Note:** To send the message to multiple recipients, add more than one contact in the **To** field.
2. Touch  to send your message.

To open a text message and the previous conversation, touch it.

To reply to a text message, open it and enter your response in the text box at the bottom, and then touch .

## Send a message to a group



To send a message:

1. Enter the recipients and then type your message.  
**Note:** You need to add each person to send a message to a group.
2. Touch  to send your message.

## Instant messages



To send and receive instant messages, you can use Google Hangouts™.



## Manage messages





To delete a message, touch and hold to select it, and then touch the trash can  at the bottom.







To change your messaging options, touch  Apps >  **Messaging** >  > **Settings**.



## Corporate email setup



From the home screen, touch  Apps >  **Settings** >  **Add account**. Select **Corporate** for work email accounts on Microsoft™ Exchange server. Enter details from your IT administrator.

 **Tip:** You need to enter your username and password. You may be prompted to enter your domain and server names. Contact your IT administrator for details.

To read and reply to messages on your email accounts, touch  Apps >  **Email**.

- To compose a new message, touch  . Enter your message and then touch  to send the email.
- To read a message, touch it from the inbox.
- To reply all or forward the email, touch .
- To manually refresh your mailbox, touch .
- To switch email accounts or view different folders within your mailbox, touch .

 **Tip:** When you have new email  will appear in the status bar.





Touch  Apps >  **Settings** and select your account to see options, such as **Signature**, **Sync Email** and **Remove account**.



## Google mail setup

From the home screen, touch  Apps >  **Settings** >  **Add account**. Select **Google** for your Gmail accounts. For account details, contact Gmail.

To read and reply to messages on your Gmail accounts, touch  Apps >  **Gmail**.

To delete an item, to move it to another label, or to mark it as unread or important, touch and hold the item within the label.

- To compose a new message, touch  . Enter your message and then touch  to send the email.
- To reply all or forward the email, touch .
- To read a message, touch it from the inbox.

- To manually refresh your mailbox, touch  > Refresh.
- To view different folders within your mailbox, touch .

## Personal email setup

From the home screen, touch  Apps >  **Settings** >  **Add account**. Select **Email** for your personal email accounts. For account details, contact the account provider.

To read and reply to messages on your email accounts, touch  Apps >  **Email**.

---

# Music

## About music



Google Play Music lets you listen to your current music collection and to buy additional music through Google Play Store.

The Music Manager desktop application provides a simple way for you to put your music collection into the cloud, unlocking the potential of the Play Music service. The application scans your computer for music files, including files in your iTunes® library, and makes any discovered tracks and albums available to you in Play Music. If your collection can be matched to music in Google Play Store, the tracks do not even need to be uploaded, saving you data transfer time.

Once your music is in the cloud, you can access it from any computer connected to Google.com or from any Android phone or tablet that has the Play Music app installed.

When you first listen to a track with Play Music on your Aster T, the song is cached on the phone. So, over time your favourites are automatically made available for offline listening, such as when you are travelling on an aeroplane.

**Note:** The Music Manager application and music purchases from Google Play Store are only available in certain markets.

## Supported file types

Your Aster T will play the following audio file formats: AMR, WB-AMR, AAC, AAC+, MP3, MP4, WAV, AU, WMA(10), M4A, OGG, EVRC, EVRC-B, and EVRC-WB/NB.

## Adding songs or albums to Play Music

You have two options for listening to music on your phone. You can listen to music files that you store on your phone, or you can listen to music in your online library in the Play Music cloud.

### To add your music to the Google Play Music cloud

1. **Sign up for your Google Play music library:** To get started, sign up for Google Play and download Music Manager, a desktop application that lets you upload your collection from your iTunes music library, or any music folder on your computer, to the cloud.
2. **Upload your collection:** Sign in to Music Manager and choose where you keep your music. Music Manager then starts uploading automatically. When you add new music to your computer, Music Manager can automatically add it to your library too. Music Manager even adds your iTunes playlists and ratings so you can start listening to your favourites right away.
3. **Access your music on the web and your phone:** After you have set up your Play Music music library, you can access it on your Aster T, on any Android phone or tablet or on the web. Sign in and all your music is ready to be played.

## To add your music to your Aster T phone only

To load music on your computer and then load it on your phone, you need the following:

- A Microsoft™ Windows™ computer or Apple Macintosh™ computer
- A USB data cable

**Note:** When you connect your phone for first time, your computer may prompt you that drivers are being installed. Complete the driver installation before you continue with the following steps.

1. Connect the microUSB cable from your phone's microUSB connector to a USB connection on your computer.
2. From the home screen, check that  appears in the status bar.
3. Drag the status bar down and touch **Connected as a media device**. Make sure the **Media device (MTP)** check box is ticked.
4. On your computer, navigate to the removable disk showing your phone and open the Internal Storage.
5. Drag and drop files between your computer and the 'Music' folder.
6. When you have finished, disconnect the USB cable.

## To buy new music through your Aster T phone







To buy new albums or tracks from your phone, follow these steps:



1. Go to the Google Play Store application.
2. Touch the 'Music' shortcut.
3. Follow the instructions in the app to make your choice and to complete the purchase.

## Play music

Touch a song or playlist to start playing music.

### Music player controls



- Play or pause: touch  or .
- Select the previous or the next song: touch  or .
- Fast forward or rewind: touch and hold the progress bar, and then drag forwards or backwards.
- Turn shuffle on or off: touch .
- Repeat all on or off: touch .
- Adjust the volume: press the volume keys on the side of the phone.

- Go to the music home screen: touch  in the top left of the screen.
- Add a song to playlist: while the song is playing, touch  > **Add to playlist** > playlist name.
- Delete a song: in the music library, touch  next to the song you wish to remove, and then touch **Delete**.

## Playlists

To add a song from the music library to a playlist, touch  and then touch **Add to playlist**. Choose an existing playlist or touch **New playlist**.

## Hide the music player

Touch Home . Your music will continue to play and you will see  in the status and notifications bar. You can continue to work with other apps while your music is playing.

When you see  in the status and notifications bar, a song is playing. Flick down to see details. Touch the song to return to the music controls.

## Turn off the music



Touch .

# Maps and navigation

## Google Maps™

Google Maps is a Google service offering powerful, user-friendly mapping technology and local business information, including business locations, contact information, and driving directions.



**Note:** You must enable GPS to use Google Maps. To do this, touch  Apps >  > **Location access** > **GPS satellites**.

You can save data from Google Maps to your phone so that a map is available for use offline. This feature is useful when you do not have a data connection, and it can also reduce your data transmission costs.

To save a map to your phone, view an area in Google Maps and touch  > **Make available offline**. If you wish to adjust the selected area, you can pinch the map to zoom in or zoom out. Touch **DONE** to download the map data.



**Tip:** Blocks of map data can be up to 100 MB. So Vertu recommends that you connect to a Wi-Fi network before you download.

For help with Google Maps™, touch  > **Help**.





**Tip:** To see listings for nearby restaurants, cafes and more, touch **Maps**  > **Local** in the top left corner of the screen.

## Google Maps™ with Navigation beta

Google Maps with Navigation beta is an internet-connected GPS navigation system with voice guidance.



**Note:** You must enable GPS to use Google Maps with Navigation beta. To do this, touch  Apps >  > **Location access** > **GPS satellites**.

Follow the prompts to speak or type your destination.

For help with Google Maps with Navigation beta, go to [www.google.com/mobile/navigation](http://www.google.com/mobile/navigation).



# Personalising your phone

## Widgets

To add widgets to the home screen:

1. Press and hold the home screen, and then select **WIDGETS**.
2. Touch and hold a widget, and then drag it to one of the home screen panels.

To download more widgets, see "Google Play™" on page 20.

To customise a widget, touch it to open it, and touch .

## Shortcuts

To add shortcuts to the home screen, touch  Apps, touch and hold an app, and then drag it to a spot on the home screen panels.

To create a shortcut folder, drag one shortcut on top of another. To add more shortcuts to the folder, drag them onto the folder icon. If you wish to name the folder, touch it and enter a name at the bottom.

- To move shortcuts or shortcut folders, touch and hold them, and then drag to a new location.
- To remove shortcuts or shortcut folders from the home screen, touch and hold them, and then drag to **Remove** at the top of the screen.



You can also drag shortcuts or shortcut folders in or out of the favourites tray for instant access from the home screen.

## Ringtones

You can adjust your ringtone for incoming calls or for notifications, such as a text message or email:

Touch  Apps >  **Settings** > **Sound** > **Phone ringtone** or **Default notification sound**.

To switch between an active or muted ringtone or to set the phone to vibrate, press and hold the Power key and then choose an option:









- Touch  to silence your phone and activate vibrate mode.
- Touch  to silence your phone without activating vibrate.
- Touch  to reactivate your ringtone.

To activate the ring and vibrate option, touch  Apps >  **Settings** > **Sound** > **Vibrate when ringing**.







## Wallpapers

To set a new wallpaper for the home screen, touch and hold an empty spot on the home screen, and then touch **Wallpapers**.



## Assign sounds to actions

- To set sounds for touches on the dial pad, touch  **Apps** >  **Settings** > **Sound** > **Dial-pad touch tones**.
- To set volume for ringtones, notifications, media, and alarms, touch  **Apps** >  **Settings** > **Sound** > **Volumes**.
- To hear when you lock or unlock the screen, touch  **Apps** >  **Settings** > **Sound** > **Screen lock sounds**.
- To set sounds for screen selections, touch  **Apps** >  **Settings** > **Sound** > **Touch sounds**.

## Display settings

Option	Setting
Set the brightness of the screen	From the home screen, touch  <b>Apps</b> >  <b>Settings</b> > <b>Display</b> > <b>Brightness</b> .
Set the font size for menus and settings	From the home screen, touch  <b>Apps</b> >  <b>Settings</b> > <b>Display</b> > <b>Font size</b> .
Turn on or off the notification light (This light flashes in at the top right corner of the front of your phone when you receive a notification, such as a text message or email.)	From the home screen, touch  <b>Apps</b> >  <b>Settings</b> > <b>Display</b> > <b>Pulse notification light</b> .

## Auto-rotate

To set whether the screen rotates automatically in certain apps, touch  **Apps** >  **Settings** > **Display** > **Auto-rotate screen**.

## Screen lock



You can make the touchscreen lock when it goes to sleep. This is recommended to protect your phone in case it becomes misplaced or stolen.

There are several different lock options. Touch  Apps >  **Settings** > **Security** > **Screen lock**, and then select the lock type:

- **Slide**: drag to the right to unlock.
- **Face Unlock**: look at your phone to unlock.
- **Pattern**: draw a pattern to unlock.
- **PIN**: enter a PIN code to unlock.
- **Password**: enter a password to unlock.

**Note:** Certain corporate email accounts make use of a specific lock that may disable the lock options listed above.

## Date and time settings

To set date, time, time zone, and time formats, touch  Apps >  **Settings** > **Date & time**.

To automatically use the network date and time, touch **Automatic date & time** or **Automatic timezone**.



## Language and region settings

To set your menu language and region, touch  Apps >  **Settings** > **Language & input** > **Language**.

# Social networks

## Add an account

With the Browser you can keep up to date with your social networking accounts on sites like Facebook™, Twitter™ and Google+™. If you don't have accounts, go to their websites to set them up. Most social networking accounts offer dedicated apps that can be installed on your Aster T from Google Play.

To download a social networking app, from the home screen touch  Apps >  **Play Store**.



To sign in to your social networking account, enter your username or email address and password.

The social networking accounts are third-party services and not provided by Vertu. Check the privacy settings of the social networking accounts to control what information you are sharing. Familiarise yourself with the terms of use and the privacy practices of any social networking accounts you use.

## Delete an account

To delete a social networking account from the phone, touch  Apps > touch and hold a social networking app and drag it to **Uninstall**.

## Synchronise contacts

When you sign in to a social networking account on your phone, you may be prompted to sync account contacts, pictures and status with your **People** app. You can accept or decline this request. To change your sync settings at any time, touch  Apps >  **Settings** > account name.

---

# Managing accounts

## Configure sync options

To sync your accounts, from the home screen, touch  Apps >  **Settings** > a listed account >  > **Sync now**.



To configure your sync options for an account, touch the account and then select the check boxes you want to sync, for example **Sync Calendar**, **Sync Contacts** or **Sync Gmail**. Leave the check box empty for options you do not want to sync.

## Add and delete accounts

To add accounts, from the home screen, touch  Apps >  **Settings** >  **Add account**. Some default accounts are shown, for example **Corporate**, **Email** and **Google**. Touch an account to add it. Enter your user name and password, and then follow the prompts to set up your account.

To delete an account from the phone, touch the account name >  > **Remove account**.

## Backup and restore accounts

To backup and restore your accounts, from the home screen touch  Apps >  **Settings** > **Backup & reset** > **Automatic restore**. Check that the **Automatic restore** box is ticked to ensure that backed up settings and data are restored when you reinstall an app.

**Note:** To backup application data, Wi-Fi passwords and other settings to Google servers make sure that the **Back up my data** box is ticked.

# Browser

## About the web browser

To browse the web with your Aster T, you must have either a cellular or Wi-Fi data connection.

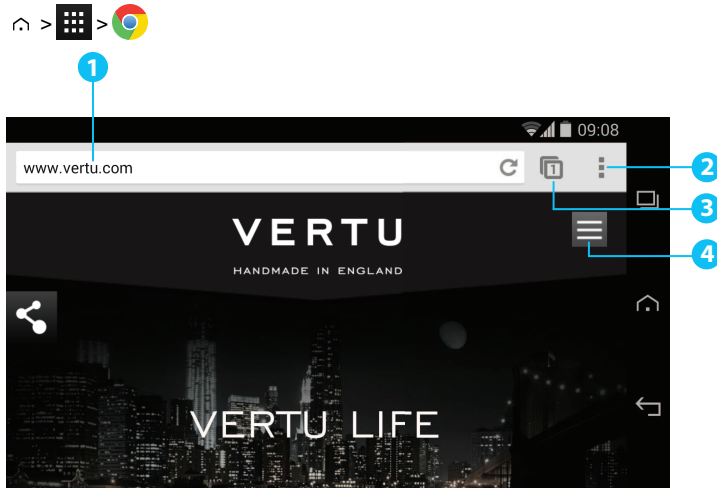



- 1 URL bar.
- 2 Touch a link to select it. Touch and hold for more options.
- 3 Browser options, such as bookmarks and browser settings.
- 4 Touch to see a list of previously visited pages.



**Tip:** To zoom in or out, touch the screen twice.

## Browse the web

To browse the web, from the home screen touch  Apps > .

To refresh a website, touch  > **Refresh**.



**Tip:** Check your data plan with your service provider. To save data costs, you can use Wi-Fi to connect to the internet.

To go to a website, touch the web address bar, enter a web address, and then touch **Go**.

## Cut, copy and paste text

Touch and hold the text to select it. Tabs mark the boundaries of the selected text. Drag these tabs to select the text you want, and then touch icons at the top of the screen to cut, copy or paste your selection.

## Connect to the internet

Your phone uses the cellular mobile phone network (over the air) or a Wi-Fi connection to access the internet.

**Note:** Check your data plan with your service provider. You may be charged to access the internet and to download data over the air.

To use a Wi-Fi network for faster internet access, touch the status bar at the top of the home screen and drag it down. Touch the **Wi-Fi networks available** notification to select a preferred network. See "Wi-Fi" on page 56.

To close your browser, touch Home .

**Note:** If you cannot connect to the internet, contact your service provider.

## Add a bookmark

If you visit the same websites regularly, add them to your bookmarks, so that you can easily access them.

To save a website as a bookmark, touch  > **Save to bookmarks**.



To view your bookmarked websites, touch  > **Bookmarks**.

## Widget feeds

If you use widget feeds, also known as media feeds, you no longer have to visit your favourite websites every time you want to find out what is going on. Instead, you can get links to the latest content automatically.

Touch and hold an empty spot on the home screen, then select **WIDGETS**. Touch and hold a widget to add it to the home screen.

## Privacy and security



To make changes to your privacy and security settings, from the home screen touch  Apps >  >  > **Settings > Privacy & security**.

To empty the cache, touch  > **Settings > Privacy > Clear browsing data > Clear cache**.

---

## Downloads

To download files in your browser, touch and hold a link or picture, and then touch **Save image** or **Save link**.

To see the files you have downloaded, from the home screen touch  Apps >  **Downloads**. Touch an item to open it. Touch the check box to select an item, and then touch the trash can  to delete it.



# Camera

## About camera

You can use your Aster T to take photos or record videos. You can then view or edit the photos and videos, share them on the internet, or send them to compatible devices.





- 1 Touch to show options for settings
- 2 Capture a photo or video
- 3 Current photo type. Touch to select another type.

**Note:** The location of the icons will vary depending on the orientation of your phone. The appearance will vary, depending on your current choice of photo type and camera settings.



## Take and share photos

To take a photo:









1. From the home screen, touch  Apps >  **Camera**.

**Note:** Touch the screen to change the focus location. A white circle shows your new focus location, and two markers turn from white to green when the camera has finished refocusing.

2. Touch  to take your photo.

To take a wide panoramic photo, touch  > . Move the phone slowly across the scene you want to take. The camera auto-captures multiple shots as you move the camera and joins them together to make one large photo.

Share a photo:

1. From the home screen, touch  Apps >  **Gallery**.
2. Touch the photo, touch  and then choose how you want to share: by , , , , , or .



**Tip:** To share a photo immediately after capture, touch the screen and flick left. The screen shows a "film strip" of your recent photos and videos. Flick right or left to move between photos.

Touch  to see the sharing options. To return to the live camera view, flick right to move to the far left of the film strip.

## Camera settings



To see the options, touch the symbol in the top right corner of the screen.

**Note:** You can only adjust the camera settings for the conventional photos, not the panoramic images.

## Record and share a video

Besides taking photos with your phone, you can also capture videos.

To take a video:







1. From the home screen, touch  Apps >  **Camera**.

**Note:** To switch from photo mode to video mode, touch .

2. To start recording, touch . To stop recording, touch . Your phone then stores the video.

**Note:** When recording a video, you do not have to touch the screen to set a focus location. The phone will auto-focus to the centre of the frame while you capture the video.

Share a video:

1. From the home screen, touch  Apps >  **Gallery**.
2. Touch the video, touch  and then choose how you want to share: by , , , or .



**Tip:** To share a video immediately after capture, touch the screen and flick left. The screen shows a "film strip" of your recent photos and videos. Flick right or left to move between videos.

Touch  to see the sharing options. To return to the live camera view, flick right to move to the far left of the film strip.

## Video settings

To see the options, touch the symbol in the top right corner of the screen. Then touch the option you wish to change and slide to a new setting.

# Gallery

## About gallery



With Gallery you can watch the videos you have recorded or browse through the photos you have taken.

To manage your media files more effectively, organise them into albums or folders.

## View and edit photos and videos



Just touch a photo or video to view it.



**Tip:** To zoom in and out, quickly touch the screen twice.











Touch  and then select an option: **Delete**, **Slideshow**, **Edit**, **Rotate left**, **Rotate right**, **Crop**, **Set picture as**, **Details** or **Show on map**.

The **Edit** option lets you change various photo settings, such as **B/W**, **Crop**, **Saturation** or an artistic picture border.

**Note:** For videos, you can only **Delete**, **Trim** or show **Details**.

## Share photos and videos

Share a photo or video:

1. From the home screen, touch  Apps >  **Gallery**.
2. Touch the photo or video, touch  and then choose how you want to share: by , , , , ,  or .

You can copy photos and videos between your phone and PC. See "Copy between the phone and a PC" on page 58 for details.

## View an album

You can view all your photos and videos, or you can arrange your photos and videos by album.



All your photos and videos are shown in **Albums**. Touch an album and then touch  > **Group by** and select an option from **Locations**, **Times**, **People** or **Tags** to show how the album is displayed.

## Create a folder

To organise your photos and videos you can create your own folders.

1. Connect your phone to your PC with the USB cable.
2. View your phone's internal storage on your PC, and then browse to the 'Pictures' folder and create new folders.
3. Drag your photos and videos into the folders.

## Assign contact images and wallpaper

Add a photo for a specific contact, or set your favourite photo as your background image.

🏠 >  >  > photo

Touch a photo, and then touch  > **Set picture as** > **Contact photo** or **Wallpaper**.

## Take a screen shot

To take a screen shot, press and hold the power key and volume down key at the same time.

To see the screen shot, touch  Apps >  **Gallery** > **Screenshots**.

# Office tools

## Clock



You can use Clock as an alarm clock, a timer, or a stop watch.

To view a list your current alarms, touch > . To activate an alarm, drag **OFF** to the right.

To add an alarm touch and then enter alarm details.

Touch to change the sound or other settings for an alarm. To change settings that affect all your alarms, touch > **Settings**.

When an alarm sounds, drag to the right to turn the alarm off or to the left to delay the alarm for ten minutes.

## Calculator



Your calculator has two views: basic and advanced. To change your views, touch > **Advanced panel** or **Basic panel**.



**Tip:** Swipe left or right to switch between the basic and advanced panels.

To clear your history, touch > **Clear history**.

## Calendar



With the Calendar app you can automatically see calendar events from your Google™ account.

You can view your calendar in different ways: touch the date, and then touch **Day**, **Week**, **Month**, or **Agenda** to change the view. Touch an event to see more details.



**Tip:** To add a calendar widget to the home screen, touch **WIDGETS**, touch and hold **Calendar**, and drag it to the home screen.

To add an event, touch > **New event**. Enter the event details and touch **DONE**.

To delete an event, touch it to open it, and then touch the trash can .

To see multiple calendars, touch > **Calendars to display**. Select the check boxes next to the calendars you want to see, touch **Calendars to sync** > **OK**.

To sync your calendar, touch  > **Calendars to display**. Select the check box next to your calendar and touch **Calendars to sync** > **OK**.

To change your calendar reminder tone, touch  > **Settings** > **General settings** > **Sound**.

**Note:** You will need to have added an account for each calendar that is shown.

# Connectivity



**Important:** There may be restrictions on the use of WLANs and Bluetooth technology in some countries. For more information, contact your local authorities.

## Wi-Fi

⌂ >  >  > **Wi-Fi**

With Wi-Fi connectivity, you can connect to a Wi-Fi network for a faster internet connection to browse the web or to stream music and videos.

To turn on Wi-Fi, touch **OFF** and drag it to the right.

To turn off Wi-Fi, touch **ON** and drag it to the left.

### Connect to a Wi-Fi network

To connect to a new Wi-Fi network:

1. Touch  >  **Settings** > **Wi-Fi**.
2. Touch **OFF** and drag it to the right to turn on.

If Wi-Fi is already on and if Wi-Fi networks are available, the Wi-Fi indicator  is shown in the status bar. Drag down the status bar and touch the **Wi-Fi networks** to select and connect to a network.

3. Touch a network in the list, and then touch **Connect**. You may need to enter **Network SSID**, **Security**, and **Password** details. For these details, contact the network administrator.

When your phone has connected, the Wi-Fi indicator  is shown in the status bar.



**Tip:** If you are using a domestic Wi-Fi connection, the security information can often be found on your Wi-Fi router.

**Note:** Using a Wi-Fi connection is highly recommended as it reduces cellular data consumption.

## Bluetooth

⌂ >  >  > **Bluetooth**

With Bluetooth connectivity, you can make a wireless connection to other compatible devices, such as phones, computers, headsets, and car kits. You can use the connection to send items from your phone, transfer files from your compatible PC, and print files with a compatible printer.



To turn Bluetooth on, touch **OFF** and drag it to the right.

To turn Bluetooth off, touch **ON** and drag it to the left.



## Connect a Bluetooth device

To connect with a new Bluetooth device, you need to pair your phone with it.

1. Make sure that the Bluetooth device you are going to pair with is in discoverable mode. For details, see the user guide of the device.
2. Touch  >  **Settings > Bluetooth**.
3. Touch **OFF** and drag it to the right to turn on and scan. If Bluetooth is already on, touch **SEARCH FOR DEVICES**.
4. Touch a device to connect. You may need to touch **OK** or to enter the device passkey to connect. For details, see the user guide of the device.

When your phone has connected, the Bluetooth indicator  is shown in the status bar.

The Aster T has been equipped to support accessories with aptX® capabilities.





**Tip:** Switch Bluetooth off when not in use to conserve battery power.



**Warning:** Obey all local laws. Always keep your hands free to operate the vehicle while driving. Your first consideration while driving should be road safety.



## Change your device name

You can change the name of your device.

1. Touch  >  **Settings > Bluetooth**.
2. Touch  > **Rename phone**.
3. Enter new name and touch **Rename**.



## Visible mode

To make your phone visible to other devices:

1. Touch  >  **Settings > Bluetooth**.
2. Touch your device name to make your phone visible for 2 minutes.

To change how long your phone is visible, touch  > **Visibility timeout**.

## Location services

 >  >  > **Location access**

To allow apps to use data from sources such as Wi-Fi and mobile networks to determine your approximate location, touch **Wi-Fi & network location**.

To allow apps to use GPS to pinpoint your location, touch **GPS satellites**.

**Note:** Enabling GPS gives you access to location based services, such as Google Maps™ and Google Maps™ with Navigation beta.

## Set your phone to sync with your computer

**Note:** When you connect your phone for first time, your computer may prompt you that drivers are being installed. Complete the driver installation.

1. Connect the microUSB cable from your phone's microUSB connector to a USB connection on your computer.
2. From the home screen, check  that appears in the status bar.
3. Drag the status bar down and touch **Connected as a media device**. Make sure the **Media device (MTP)** or **Camera (PTP)** check box is selected.
4. Follow the prompts on your computer to sync your digital media files.

When the sync has finished, disconnect the USB cable.

**Note:** Always use the Vertu microUSB cable supplied with your phone.

## Copy between the phone and a PC

**Note:** When you connect your phone for first time, your computer may prompt you that drivers are being installed. Complete the driver installation.

1. Connect the microUSB cable from your phone's microUSB connector to a USB connection on your computer.
2. From the home screen, check  that appears in the status bar.
3. Drag the status bar down and touch **Connected as a media device**. Make sure the **Media device (MTP)** check box is selected.
4. On your computer, navigate to the removable disk showing your phone and open the Internal Storage.
5. Drag and drop files between your computer and the phone Internal Storage folders, such as 'Music', 'Pictures' or 'Movies'.
6. When you have finished, disconnect the USB cable.

## Tethering and portable hotspot

You can 'tether' your phone to your computer, via a USB cable or a Wi-Fi or Bluetooth connection, so that the computer can share the phone's internet connection.

To read about the tethering options, touch  **Settings** > **More...** > **Tethering & portable hotspot** >  > **Help**.

## NFC

Near Field Communication (NFC) allows you to beam information (such as contacts, photos and browser pages) by bringing your phone close to another NFC-capable device (typically back to back).

From the home screen, touch  **Apps** >  **Settings** > **More...** > **NFC** and make sure the check box is selected. Touch  **Apps** >  **Settings** > **More...** > **Android Beam**, touch **OFF** and drag it to the right.

To beam information:

1. Go to the screen that shows the item you want to beam, such as a photo.
2. Bring your phone and the other device close together (back to back).
3. When you see **Touch to Beam**, touch your phone's screen.

See "Recommended apps" on page 20 for details of other apps that use NFC.

## Secure payment

The NFC feature in your Aster T is SIM-based secure element compliant. This means that you can use your phone for cashless, secure payments, provided that you have a suitable SIM card.

Contact your bank, credit card or network provider for more details about secure SIM cards.

**Note:** The Android Beam™ feature is not universally compatible with all other devices. Contact Vertu Customer service for more details.

# Phone management

## System update



If you receive an over-the-air notification of a system update on your phone, you can follow the instructions to download and install the update software or you can opt to dismiss the notification.

To check for updates on your phone, touch  Apps >  **Settings** > **About phone** > **System updates**.

## Free up phone memory

Your photos, videos, and other files are automatically stored in your phone's internal memory.

**Note:** The total available internal memory is shared between system, application and user information files.

To see the space available in your phone's internal memory, from the home screen touch  Apps >  **Settings** > **Storage**.

To free up space on your phone's internal memory, remove unwanted files. Touch a storage category such as **Pictures**, **videos**, touch and hold a folder or file, and then touch  > **Delete**.



**Tip:** You can view your phone memory and cloud memory usage by using the Vertu Certainty app. See "About Vertu Services" on page 23 for more information.

## Optimise data usage

You can monitor the amount of data uploaded and downloaded by your phone, and you can set a limit on your monthly data usage.



**Note:** Data usage information is provided to help you manage your usage. Your service provider might not measure data usage in the same way so check your data charges with your service provider.

 >  >  > **Data usage**

To set a data usage warning level, drag the right side of the orange bar up or down. You will receive a notification when the set level is reached.



To set a data usage limit, touch **Set mobile data limit** and then drag the right side of the red bar up or down. You will receive a notification when the set level is reached and your mobile data will be turned off automatically.



## Data roaming settings



To change your data roaming settings, from the home screen touch  Apps >  **Settings** > **More...** > **Mobile networks** > **Data roaming**.

**Note:** You may incur significant charges if you use data roaming. Check the data roaming conditions with your service provider.

## Back up and restore your phone



To back up your application data, Wi-Fi passwords and other settings to Google servers, touch  Apps >  **Settings** > **Backup & reset** > **Back up my data**.

Use Google Drive™ to back up your music, photos, videos and documents. touch  Apps > **Google Drive** >  > **Add new**.

Use your Gmail™ account to back up your contacts, emails and calendars. To set your Google sync settings, touch  Apps >  **Settings** > select your Google account.

To back up your text messages, use a Vertu-recommended app. For more information, see "Recommended apps" on page 20.

To back up your Google account, touch  Apps >  **Settings** > **Backup & reset** > **Backup account**.

To automatically restore your app settings and data when you reinstall an app, touch  Apps >  **Settings** > **Backup & reset** > **Automatic restore**.

## Set your phone to lock automatically

To set your phone to lock automatically, touch  Apps >  **Settings** > **Security** > **Screen lock** > lock type > **Automatically lock**. Then select how long after sleep mode you want to lock your phone.

**Note:** This feature does not apply to the **Slide** lock option.

## Change your PIN code

To set your PIN code, from the home screen touch  Apps >  **Settings** > **Security** > **Screen lock** > **PIN**. Enter your numerical PIN and then confirm it.

You will be prompted to enter the PIN to unlock your phone.

---

## Access codes



### PIN code (4-8 digits)

The PIN code protects your SIM against unauthorised use or is required to access some features. You can set your phone to ask for the PIN code when you switch it on. If you enter the code incorrectly three times in a row, you need to unblock the code with the PUK code. To change your PIN code, see "Change your PIN code" on page 61.

### PUK or PUK2 code (8 digits)

The PUK or PUK2 codes are required to unblock a PIN or PIN2 code. For PUK or PUK2 details, contact your service provider.



### IMEI number (15 digits)

The IMEI number is used to identify valid phones in the network. This number can also be used to block a stolen phone. You may be required to give this number to Vertu Customer service. To see your IMEI number, from the home screen touch  Apps >  **Settings** > **About phone** > **Status** > **IMEI**.

### Lock code (security code - minimum of 4 digits)

A lock code helps you protect your phone against unauthorised use. You can set your phone to ask for the lock code that you define. Keep the code secret and in a safe place separate from your phone. If you forget the code and your phone is locked, your phone will require service. Additional charges may apply, and all the personal data in your phone may be deleted.

## Master reset



A master reset returns your phone to the factory settings and erases all the data from the phone. To perform a master reset, from the home screen touch  Apps >  **Settings** > **Backup & reset** > **Factory data reset**.





**Warning:** You may want to back up your data before performing a master reset.

# Tips and tricks

## General tips





- To quickly view your most recently used apps, touch Recent apps .
- To see recently dialled numbers, touch  **Phone** > .
- The notification light constantly updates you on the status of your phone.

Colour of the light	Phone status
Steady green	Battery full
Flashing green	Battery charging
Steady red	Battery low but charging
Flashing red	Battery low and not charging. For example, if the phone is plugged into a PC, but there is not enough current to charge the phone.
Flashing blue	Call, text message or email received



- To edit the shortcuts in your favourites tray (bottom of the home screen), touch and hold a shortcut, and then drag it in or out.
- To put your phone in sleep mode, press the Power key. To wake your phone, press the Power key
- To set when the screen goes to sleep after a period of inactivity, touch  **Apps** >  **Settings** > **Display** > **Sleep**.
- To quickly turn aeroplane mode on or off, press and hold the power key > **Aeroplane mode**.
- To select text, touch and hold it. Tabs mark the boundaries of the selected text. Drag these tabs to select the text you want, and then touch the icons to cut, copy or paste your selection. In a landscape display, touch **Edit** to view your options.
- To quickly access the phone settings from the home screen, drag down the notification bar from the top of the screen. Touch the icon in the top right corner and then touch .

## Extend battery life

You can extend the life of the battery by adjusting your phone's settings to manage features that are heavy consumers of battery charge:

- Reduce the brightness of your screen or use the automatic brightness option. Touch  Apps >  **Settings** > **Display** > **Brightness**.
- To turn off background data transfers, touch  Apps >  **Settings** > **Data usage** and then drag the **Mobile data** power switch to **Off**.
- To turn off the connectivity options for Wi-Fi and Bluetooth™. To quickly adjust the settings, drag down the notification bar and touch the icon in the top right corner. Then touch any active connectivity option you wish to turn off.

Note: Turning off Wi-Fi may result in increased data costs.

- Reduce how often your phone checks for new emails in your mailbox. Open your email app and touch  > **Settings** > an account name > **Inbox check frequency** > a frequency option.
- Whenever possible, use Wi-Fi rather than cellular services for mobile data.
- Limit your use of widgets that dynamically updated their content. Remove widgets that you do not need or use.
- Limit the syncing activities of your accounts. To view and adjust the sync settings for an account, touch  Apps >  **Settings** > one of the listed accounts.
- At night, switch the phone to aeroplane mode. Press and hold the Power key and then touch **Aeroplane mode**.

Also, you can download battery-management apps that let you to control how and when your phone uses features that have the most impact on your battery's power. Visit Vertu Recommended apps for our latest suggestions on applications for battery and power management.



---





# FAQs

## Questions



How can I extend the battery life of my phone?	66
Do I need a Google™ account to use my phone?	66
How can I reduce my data costs, especially when abroad?	66
How do I transfer music from my computer to my phone?	67
How can I listen to my iTunes music library on my phone?	67
How do I setup an email account on my phone?	68
How do I transfer contacts to my phone?	68
How do I set my music as ringtone?	69
How do I change the font size on my phone?	69
How do I check if I have the latest software updates on my phone?	69
Why have I got no connectivity?	69
Why is my internal storage less than advertised?	70
How do I protect my phone from unauthorised use?	70
How do I find the IMEI number of my phone?	70
How can I clear the log of my calls or the list of people I have contacted frequently?	70
Why does my phone get warm?	70
How do I know how much storage I have on my phone?	71
How do I set a photo as my wallpaper?	71
Can I still use Google Maps if I do not have a data connection?	71

## How can I extend the battery life of my phone?

You can extend the life of the battery by adjusting your phone's settings to manage features that are heavy consumers of battery charge:

- Reduce the brightness of your screen or use the automatic brightness option. Touch  Apps >  **Settings** > **Display** > **Brightness**.
- Turn off background data transfers. Touch  Apps >  **Settings** > **Data usage** and then drag the **Mobile data** power switch to **Off**.
- Turn off the connectivity options for Wi-Fi and Bluetooth™. To quickly adjust the settings, drag down the notification bar and touch the icon in the top right corner. Then touch any active connectivity option you wish to turn off.

**Note:** Turning off Wi-Fi may result in increased data costs.

- Reduce how often your phone checks for new emails in your mailbox. Open your email app and touch  > **Settings** > an account name > **Inbox check frequency** > a frequency option.
- Whenever possible, use Wi-Fi rather than cellular services for mobile data.
- Limit your use of widgets that dynamically updated their content. Remove widgets that you do not need or use.
- Limit the syncing activities of your accounts. To view and adjust the sync settings for an account, touch  Apps >  **Settings** > one of the listed accounts.
- At night, switch the phone to aeroplane mode. Press and hold the Power key and then touch **Aeroplane mode**.



Also, you can download battery-management apps that let you to control how and when your phone uses features that have the most impact on your battery's power.

## Do I need a Google™ account to use my phone?

You'll still be able to perform basic functions on your phone without a Google account, like calling or text messaging, but a Google account is highly recommended as it will give you access to Google Play and other Google apps.

## How can I reduce my data costs, especially when abroad?

You can disable mobile data by touching  Apps >  **Settings** > **Data usage** > and then touching **ON** next to **Mobile data** and dragging left to turn it to **OFF**. Confirm **OK** when you are prompted.

You can set a limit on the amount of data you are able to use. Touch Home  >  >  > **Data usage**.

To set a data usage warning, drag the right side of the orange bar up or down. You will receive a notification when the level set is reached.

To set a data usage limit, touch **Set mobile data limit** and then drag the right side of the red bar up or down. You will receive a notification when the level set is reached and your mobile data will be automatically turned off.

**Note:** Data usage information is provided to help you manage your usage. The way your service provider measures data may not be the same so check your data charges with your service provider.

You can disable data roaming. Touch Home  >  >  > **More...** > **Mobile networks** > **Data roaming**.

## How do I transfer music from my computer to my phone?

When you connect your phone to your computer for the first time, your computer may prompt you that drivers are being installed. It is important that you install these drivers on your computer.

1. Connect the microUSB cable from your phone's microUSB connector to a USB connection on your computer.
2. From the home screen, check that  appears in the status bar.
3. Drag the status bar down and touch **Connected as a media device**. Make sure the **Media device (MTP)** check box is selected.
4. On your computer, navigate to the removable disk showing your phone and open the Internal Storage.
5. Drag and drop files between your computer and the 'Music' folder.
6. When you have finished, disconnect the USB cable.



**Tip:** If you drag and drop folders of music, such as a folder for an artist containing multiple album folders, this organisation will be replicated on your phone.

## How can I listen to my iTunes music library on my phone?

One easy way is to use Music Manager, a desktop application that puts your music collection into the cloud, unlocking the potential of the Play Music service. The application scans your computer for music files, including files in your iTunes® library, and makes any discovered tracks and albums available to you in Play Music. If your collection can be matched to music in Google Play Store, the tracks do not even need to be uploaded, saving you data transfer time. When you add new music to your computer, Music Manager can automatically add it to your library too. Music Manager even adds your iTunes playlists and ratings so you can start listening to your favourites right away.

Once your music is in the cloud, you can access it from any computer connected to Google.com or from any Android phone or tablet that has the Play Music app installed.

When you first listen to a track with Play Music on your phone, the song is cached on the phone. So, over time your favourites are automatically made available for offline listening, such as when you are travelling on an aeroplane.

**Note:** The Music Manager application and music purchases from Google Play Store are only available in certain markets.

To add your music to the Google Play Music cloud

1. **Sign up for your Google Play music library:** To get started, sign up for Google Play and download Music Manager.
2. **Upload your collection:** Sign in to Music Manager and choose where you keep your music. Music Manager then starts uploading automatically.
3. **Access your music on the web and your phone:** After you have set up your Play Music music library, you can access it on your Aster T, on any Android phone or tablet or on the web. Sign in and all your music is ready to be played.

## How do I setup an email account on my phone?

You can set up a number of different email accounts on your phone: corporate email, Gmail or personal email accounts.

To set up these accounts, touch  Apps >  **Settings** > **Add account**. Select **Corporate** for work email accounts on Microsoft™ Exchange server, **Google** for your Gmail accounts or **Email** for your personal email accounts.

## How do I transfer contacts to my phone?

To transfer contacts to your Aster T with your Gmail™ account you must first export the contacts on your old phone to a Comma Separated Values (.csv) file. Once this file is imported in to your Gmail account it will automatically sync with your phone (provided that you have already set up a Gmail account).

1. Export the contacts on your previous phone to a .csv file. For information on how to do this, please refer to the user documentation supplied with your previous phone.
2. Log into your Gmail account on your PC and click 'Contacts' > 'Import Contacts'.
3. Click 'Browse' and select the .csv file that you created.
4. Click 'Import Contacts'.

 **Important:** Syncing your contacts with your Gmail account means that your contacts will always be backed up.



To transfer contacts from a different Vertu phone to your Aster T phone:

1. Install and set up Vertu PC Suite on your computer. You can download Vertu PC Suite at <http://www.vertu.com/en/help-and-support/user-guides-and-downloads/software-for-mac-and-pc.aspx?td=rm-266v>
2. Using a USB cable, connect the different Vertu phone to the PC and ensure that Vertu PC Suite is selected.

3. From Vertu PC Suite, set up the synchronization options. Select MS Outlook as the target, and then the option to upload phone data to MS Outlook. Select the data you wish to synchronise, which can include contacts, calendars and notes.
4. Run the synchronization process.
5. Once your contacts are uploaded to Outlook, you can subsequently export your contacts to a .csv file.
6. Log into your Gmail account on your PC and click 'Contacts' > 'Import Contacts'.
7. Click 'Browse' and select the .csv file that you created.
8. Click 'Import Contacts'.
9. Once this file is imported in to your Gmail account it will automatically sync with your Aster T (provided that you have already set up a Gmail account).

### How do I set my music as ringtone?



Using your computer, you need to copy the song over to the 'Ringtones' folder on your Aster T:

1. Connect the microUSB cable from your phone's microUSB connector to a USB connection on your computer.
2. From the home screen, check that  appears in the status bar.
3. Drag the status bar down and touch **Connected as a media device**. Make sure the **Media device (MTP)** check box is selected.
4. On your computer, navigate to the removable disk showing your phone and open the Internal Storage.
5. Drag and drop the song file between your computer and the 'Ringtones' folder.
6. When you have finished, disconnect the USB cable.
7. Touch  Apps >  **Settings** > **Sound** > **Phone ringtone** > song > OK.

### How do I change the font size on my phone?

To change the font size, touch  Apps >  **Settings** > **Display** > **Font size**.



### How do I check if I have the latest software updates on my phone?

To check if your Aster T phone has the latest software, touch  Apps >  **Settings** > **About phone** > **System updates**.

### Why have I got no connectivity?

If you lose network connection, check your network signal strength in the top right corner of your screen. It is possible that you are in an area with poor network coverage. If this problem persists contact your service provider.



When your phone has a strong network connection, the network (full signal) indicator  is shown in the status bar.

If you lose your Wi-Fi connection, check the Wi-Fi status indicator at the top of your screen for the connection strength. You may be out of range. To scan for Wi-Fi networks, touch  Apps >  **Settings** > **Wi-Fi**. Touch **OFF** and drag it to the right to turn on. Touch a network in the list, and then touch **Connect**. You may need to enter **Network SSID**, **Security**, and **Password** details. For these details, contact the network administrator.



When your phone has connected, the Wi-Fi indicator  is shown in the status bar.

 **Tip:** If you are using a domestic Wi-Fi connection, the security information can often be found on your Wi-Fi router.

## Why is my internal storage less than advertised?



This may be due to the size of the system files on your phone, or the number of apps you have downloaded. For a graphical representation of the storage details, touch  Apps >  **Settings** > **Storage**.

## How do I protect my phone from unauthorised use?



You can choose from a number of different lock options to protect your Aster T. To select a lock type, touch  Apps >  **Settings** > **Security** > **Screen lock** and select from **Slide**, **Face Unlock**, **Pattern**, **PIN** or **Password**.

If you're using a corporate email account it may make use of a specific lock.

## How do I find the IMEI number of my phone?

The IMEI number is used to identify valid phones in the network. This number can also be used to block a stolen phone. You may be required to give this number to Vertu Customer service. To see your IMEI number, from the home screen touch  Apps >  **Settings** > **About phone** > **Status** > **IMEI**.

## How can I clear the log of my calls or the list of people I have contacted frequently?

To clear the call log, from the home screen, touch  **Phone** >  >  > **Clear call log**.

To clear the frequently contacted list, do one of the following:

- From the home screen, touch  **Phone** >  >  > touch **Clear frequents**.
- From the home screen, touch  **People** >  >  > touch **Clear frequents**.

## Why does my phone get warm?

Your Aster T may occasionally get warm when it is used for an extended period, being charged, or has been exposed to extreme heat. In these instances you should power off your phone (press and hold the

Power key, and then touch **Power off**) for a few minutes.

### How do I know how much storage I have on my phone?

To view how much storage is available for use, touch  Apps >  **Settings** > **Storage**. The available storage is shown in the internal storage section.

You can also view your phone's internal and cloud storage status from the Vertu Certainty app.

### How do I set a photo as my wallpaper?

To set a photo you've taken as your new wallpaper, touch and hold an empty spot on one of your home screen panels, then touch **Pick Image** and select the photo. Depending on the size, you may be required to crop the photo.

### Can I still use Google Maps if I do not have a data connection?

You can save data from Google Maps to your phone so that a map is available for use offline. This feature is useful when you do not have a data connection, and it can also reduce your data transmission costs.

To save a map to your phone, view an area in Google Maps and touch  > **Make available offline**. If you wish to adjust the selected area, you can pinch the map to zoom in or zoom out. Touch **DONE** to download the map data.

 **Tip:** Blocks of map data can be up to 100 MB. So Vertu recommends that you connect to a Wi-Fi network before you download.

---

# Accessories

## Battery charger

The wall charger supplied with your phone should be suitable for your region. However, you should always check that the electrical rating of the AC outlet is appropriate for the charger before you attempt to plug it in.

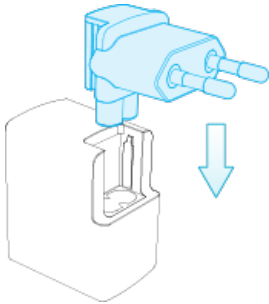

The battery for your Aster T requires charging at regular intervals. The battery does not have to be completely discharged before you can charge it.

For information on how to charge your phone, see "Charge the phone" on page 11.

## Other charging options

You can also charge the battery by using:

- A compatible PC (this method also provides data connectivity)
- The VERTU Wireless charger or a wireless charger that conforms to the Qi standard.



## Data cable

The USB data cable enables you to transfer data between your Aster T phone and a compatible computer.

**Note:** A microUSB cable, 1200 mm (CA-225DV), is supplied.

1. Connect the USB data cable to the microUSB connector of your Aster T. Make sure the cable is inserted correctly, with the USB symbol facing up.
2. Connect the cable to a USB port of the computer. The phone starts charging, and a number of USB connection modes are available. Drag the status and notification bar down to select from the following options:

**Media device (MTP)** – to transfer media files between your phone and a PC.

**Camera (PTP)** – to transfer photos, and any other file types not supported by **Media device (MTP)**, between your phone and a PC.

## Wired stereo headset

Your Aster T phone is supplied with a wired stereo headset, which includes a microphone and integrated volume controls. Connect this to the headset connector on the phone.

# Specifications

## Specifications

### Dimensions

- Length: 143.4 mm
- Width: 69 mm
- Depth: 11.2 mm
- Weight: 193.3 g

### Services

- Vertu Certainty, Vertu Life, and Vertu Concierge

### In-box

- Aster T phone
- Wall charger (AC-32V) with two regional plug heads
- MicroUSB data cable 1200 mm (CA-225DV)
- Wired stereo headset
- Polishing cloth
- NanoSIM adaptor
- Collateral pack, including Quick Start Guide, and Authenticity Card

### Operating system

- Android™ 4.4, Kit kat

### Hardware characteristics

- Qualcomm® Snapdragon™ Quad-core 2.3 GHz processor
- 4.7 inch, 1080 high-definition, brilliant, high-contrast display
- 13 MP main camera with AF and twin LED flash
- HD front camera
- 64 GB of internal memory
- High-fidelity stereo 11 mm x 15 mm loudspeakers with Dolby®Digital Plus support
- A-GPS and compass
- Gyro and accelerometer for orientation and game play

---

## Battery

- Internal 2275 mAh Li-ion
- Talk time: Up to 15 hours and 30 minutes (WCDMA)
- Stand-by: Up to 380 hours

## Connectivity

- Quadband GSM 850/900/1800/1900 MHz
- WCDMA Bands I, II, IV, V, VIII
- DC and HSPA+ Release 8, Cat24, 42 Mb/s downlink, Cat6 5.76 Mb/s uplink
- TD-SCDMA Bands 34, 39 & 40
- LTE Bands TDD: 34, 38, 39, 40 & 41
- LTE Bands FDD: 1-5, 7, 20 & 25
- LTE Cat 4, 150 Mbps
- Support for Circuit-Switch Fallback
- LTE FDD Cat4, 150 Mb/s downlink, 5.76 Mb/s uplink
- Dual-band WLAN 802.11 a, b, g, n, ac including WAPI for PRC
- Micro-AB\_USB system connector with USB2 On-The-Go support
- 3.5 mm audio socket (No OMTP support)
- Bluetooth v4 + LE
- CSR aptX® high quality encoded audio support
- NFC + support for embedded and SIM based secure elements
- Wi-Fi hotspot (tethering and portable hotspot)

## Applications

- Google Mobile services, including Google Play, Gmail, Google Chrome, Google+, Google Maps, Google Drive cloud storage, YouTube™ and other services.
- Browser, Calculator, Calendar, Camera, Clock, Downloads, Email, Gallery, Messaging, Movie Studio, People, Phone and Settings.

# Care of your phone

## General care

If your Aster T phone or any of the accessories are not working as they should, contact your Vertu dealer.

- Always use your Aster T in the documented manner. Incorrect usage may affect performance.
- Do not attempt to open or disassemble your Aster T phone. The only part you ever need to open is the SIM door. Your Aster T phone should only be serviced by Vertu-authorized personnel.
- Do not mishandle or abuse your Aster T phone.
- Use only Vertu-approved accessories.
- The supplied charger is are only intended for use with your Aster T phone. Do not use them with any other device, as this could result in permanent damage to the phone, battery, or charger.
- Keep your Aster T phone and all parts and accessories out of the reach of small children and pets.
- Do not allow your Aster T phone or accessories to come into contact with liquids or moisture, or dust and dirt.
- Do not expose your Aster T phone to extreme temperatures as these may cause the battery to stop working temporarily. Performance is particularly limited in temperatures well below freezing.
- Do not apply paint or other similar substances to your Aster T phone.
- Only use a soft, clean cloth to clean your Aster T phone. Do not use chemicals, detergents, abrasive substances, or any liquids. Use a cotton swab to clean the camera lens.
- Do not insert any sharp objects into any of the audio ports.

## Embroidery

Vertu recommends that you avoid the following:

- Direct exposure to strong light, heat and humidity
- Contact with items and substances that may stain or scratch the surfaces

If your Aster T phone gets wet, it is essential that you dry it as soon as possible with a soft, absorbent cloth.

## Exotic leathers

Vertu recommends that you occasionally wipe the exotic leather in the direction of the scales with a slightly damp soft cloth, avoiding excessive pressure.

- If your phone accidentally gets wet, it is essential that you dry it as soon as possible with a soft, absorbent cloth.

- Direct exposure to strong light, heat and humidity should be avoided, as well as contact with items and substances that may stain or scratch the surfaces.
- Vertu recommends that you store your handset in a pouch when not in use.

## Leather

Each piece of leather used by Vertu's craftsmen is unique. The natural markings present in the hide should be considered part of the individuality of fine leather. All leather can be damaged and should be treated with care.

Avoid the following:

- Exposure to water and high humidity
- Dropping, rubbing or knocking on hard surfaces
- Exposure to extreme temperatures
- Contact with oily substances, make-up and solvents

## Non-precious metals

Vertu metals are finished to a high standard and care needs to be taken to maintain their appearance.

Avoid the following:

- Contact with chemicals such as solvents, alkaline and acid solutions, cola-based drinks and exposure to salt water. Wipe with a clean, soft cloth as soon as possible if contact occurs.
- Contact with sharp objects
- Dropping or knocking against hard surfaces
- Metal polishes

## Precious metals

Precious metals, such as gold and platinum, have a much softer composite and extra care must be taken when handling a Vertu product containing these materials.

## Precious stones

Precious stones are extremely hard and durable, but can be damaged if handled inappropriately. For example, they can be broken, or their settings could be damaged by a sharp impact on a hard surface, causing the stone to become loose or fall out.

Care should also be taken to avoid contact with other jewellery such as diamond rings and diamond earrings as they can cause abrasion and chipping of the stone or the setting. Reasonable care should be taken to not catch the setting with threads that may bend the setting and loosen the stones.

We recommend that your Vertu phone is kept in a Vertu leather case when not being used, particularly when placed in handbags and other luggage.

If the stones appear to become dull from use, the product can be lightly polished using the Vertu microfibre polishing cloth.

## **Sapphire and ceramics**

Sapphire and ceramics are very hard materials but are also brittle and can be scratched by harder materials or objects. They can also be damaged if dropped.

Avoid the following:

- Contact with other hard materials such as diamond jewellery, nail files, abrasives and mineral crystals
- Dropping or knocking the product on hard surfaces
- Repeated rubbing against hard surfaces

# Safety and warranty

## Safety text

The sales package may contain several different products and parts (hereafter known collectively as the "Product"), for example a phone with various chargers. The following simple guidelines are intended to cover all products and parts. Not following the guidelines may result in risks to personal safety or data, damage to the Product, or in non-compliance with legal requirements.

## Medical considerations

The operation of radio transmitting equipment, including wireless phones, may interfere with the function of inadequately protected medical devices. Consult a physician or the manufacturers of the medical devices to determine whether they are adequately shielded from external RF (Radio Frequency) energy.

Manufacturers of medical devices recommend a minimum separation of 15.3 centimetres (6 inches) between a wireless device and an implanted medical device, such as a pacemaker or implanted cardioverter defibrillator. Persons who have such devices should also:

- Not carry the phone in a breast pocket.
- Hold the phone to the ear opposite the medical device.
- Turn the phone off if there is any reason to suspect interference.
- Follow the manufacturer's instructions for the implanted medical device.

If you have any questions about using your wireless device with an implanted medical device, consult your health care provider.



**To prevent possible hearing damage, do not listen at high volume levels for long periods. When you use the headset, your ability to hear outside sounds may be affected. Do not use the headset where it can endanger your safety. Listen to the headset at a moderate level, and do not hold the device near your ear when the loudspeaker is in use.**

## HAC Hearing Aid Compatibility (HAC) for digital handsets

Your phone complies with FCC (Federal Communications Commission) rules governing hearing aid compatibility. Some wireless devices may interfere with some hearing aids. For full hearing aid compatibility, you should turn off the Bluetooth connectivity.

FCC's wireless hearing aid compatibility rules ensure that consumers with hearing loss are able to access wireless communications services through a wide selection of handsets without experiencing disabling radio frequency (RF) interference or other technical obstacles.

To define and measure the hearing aid compatibility of handsets, FCC references ANSI C63.19 2007 version and 2011 version; ANSI C63.19 standard specifies testing procedures for determining the M-rating and T-rating of the digital handsets.

A handset is considered hearing aid-compatible for acoustic coupling if it meets a rating of M3 or M4, under the ANSI C63.19. A handset is considered hearing aid-compatible for inductive coupling if it meets a rating of T3 or T4, under ANSI C63.19. (Not all hearing-aids have telecoil inside.) This device was tested according to ANSI C63.19 2011 version, and this meets the M3/T4 rating.

This phone has been tested and rated for use with hearing aids for some of the wireless technologies that it uses. However, there may be some newer wireless technologies used in this phone that have not been tested yet for use with hearing aids. It is important to try the different features of this phone thoroughly and in different locations, using your hearing aid or cochlear implant, to determine if you hear any interfering noise. Consult your service provider or Vertu Customer Service for information on hearing aid compatibility. If you have questions about return or exchange policies, consult Vertu Customer Service.

### **Switch off the phone in restricted or dangerous areas**

Switch the phone off when mobile phone use is not allowed or when it may cause interference or danger, for example near medical equipment, fuel, chemicals, or blasting areas.

### **Airplane profile when travelling**

Unless specifically requested to turn the phone off, you can select the Airplane (offline) profile, which means that you cannot make or receive any calls, or use other features that require cellular network coverage. You can, however, still make emergency calls.

### **Use in vehicles**

Radio signals may affect improperly installed or inadequately shielded electronic systems in motor vehicles such as electronic fuel injection, electronic anti-lock braking, electronic speed control, and air bag systems. For more information, check with the manufacturer of your vehicle or its equipment.

Only qualified personnel should install the phone in a vehicle. Faulty installation or service may be dangerous and may invalidate your warranty. Check regularly that all wireless device equipment in your vehicle is mounted and operating properly. Do not store or carry flammable liquids, gases, or explosive materials, in the same compartment as the phone, its parts, or accessories. Remember that air bags inflate with great force, so do not place your phone or accessories in the air bag deployment area.

### **Keep the product away from children**

Keep your Product and all parts and accessories out of the reach of small children and pets. Failure to do this may endanger them and invalidate your Warranty.

### **Road safety comes first**

Obey all local laws. Always keep your hands free to operate your vehicle while driving. Your first consideration should be road safety.



## Qualified service

Only qualified personnel may install or repair the Product.

## Batteries, chargers and other accessories

If the Product has an internal battery, this is intended to be rechargeable and non removable, being intended for use when supplied with power from the Vertu Mains charger (AC-32V), or from a suitable computer. Do not attempt to remove the battery, as you may damage it.

The full performance of a new battery is achieved only after two or three complete charge and discharge cycles. The battery in a device can be charged and discharged hundreds of times, but it will eventually wear out. When you believe that the performance of the device has deteriorated (for example, when the talk and standby times on the phone are noticeably shorter than normal), replace the battery if it is removable, or, if it is non-removable, take the associated device to the nearest authorised service facility.

**Use the battery only for its intended purpose.**

**Never use any charger or battery that is damaged.**

**Use only Vertu-approved batteries, and recharge your battery only with Vertu approved chargers designated for the device.**

**Use of an unapproved battery or charger may result in a risk of fire, explosion, leakage, or other hazard. Do not connect other, incompatible devices to the chargers.**

**When your charger is not in use, unplug it from the electrical plug and the device. Do not leave a fully charged battery connected to a charger, as overcharging may shorten the battery's lifetime.**

Do not dismantle, cut, open, crush, bend, deform, puncture, or shred cells or batteries. In the event of a battery leak, do not allow the liquid to come in contact with the skin or eyes. In the event of such a leak, flush your skin or eyes immediately with water, or seek medical help.

Do not modify, remanufacture, attempt to insert foreign objects into the battery, or immerse or expose it to water or other liquids. Improper battery use may result in a fire, explosion, or other hazard. If the device or battery is dropped, especially on a hard surface, and you believe that the battery has been damaged, take it to the nearest service facility for inspection before continuing to use it. If the phone battery has not been used for a long time, then, in order to begin charging it again, you may need to connect the charger, and then disconnect and reconnect it. If the battery is completely discharged, it may take several minutes before the charging indicator appears on the display or before any calls can be made.

## Keep your device dry

Your Product is not fully water-resistant, so keep it dry.

## SIM card

The Aster T has been designed for use with a microSIM card. NanoSIM cards can be supported with an adaptor available in the sales pack. Standard SIM cards are not supported.

**The use of an incompatible SIM card or an adaptor not supplied by Vertu may damage the card or the phone, and may corrupt data stored on the card.**

## **IMEI number and compliance number**

To find the IMEI number, dial the sequence \*#06# into the phone. The unique 15-digit IMEI code of your phone is instantly displayed. Write it down and keep it in a safe place so that you can find it if your phone is misplaced or stolen. You can also find the IMEI number by checking the compliance label (refer to the phone's reference manual to locate this label).

## **WLAN**

Use encryption to increase the security of your WLAN connection.

## **Headset connector**

Do not connect products that create an output signal as this may cause damage to the phone. Do not connect any voltage source to the headset connector. If you connect an external device or headset, other than those approved by Vertu, pay special attention to volume levels.

## **Camera flash**

Keep a safe distance when using the flash in the camera. Do not use the flash on people or animals when they are at close range. Do not cover the flash while taking a picture.

## **Protect your phone from harmful content**

Your phone may be exposed to viruses and other harmful content. Take the following precautions:

- Be cautious when opening messages. They may contain malicious software or otherwise be harmful to your phone or computer.
- Be cautious when accepting connectivity requests, browsing the internet, or downloading content.
- Do not accept Bluetooth connections from sources that you do not trust.
- Only install and use services and software from sources that you trust and that offer adequate security and protection.
- Install anti-virus and other security software on your phone and any connected computer. Only use one anti-virus application at a time (using more may affect the performance and operation of the phone and/or computer).
- If you access pre-installed bookmarks and links to third party internet sites, take the appropriate precautions. Vertu does not endorse or assume liability for such sites.

## **Bluetooth hidden mode**

Operating the phone when Bluetooth Visibility is set to Hidden is a safer way to avoid malicious software. Alternatively, switch off the Bluetooth function completely (this does not affect other functions on the phone).

## **Magnetic fields**

Keep your phone away from magnets or magnetic fields.

## Antennae

Avoid touching the antennae unnecessarily while they are transmitting or receiving. Contact with the antennae affects the communication quality and may cause a higher power level during operation and reduce battery life.

## Backups

To keep your important data safe, store it in at least two separate places, such as on your phone and on your PC.

**It is particularly important to carry out a backup prior to repair or replacement of the Product because content and data may be lost during these operations.**

## Digital rights management (DRM)

When using the phone, you are required to obey all laws and respect local customs, privacy and the legitimate rights of others, including copyrights. Copyright protection may prevent you from copying, modifying, or transferring images, music, and other content.

## Additional care and maintenance

The Product in the sales package contains one or more sophisticated electronic devices. Vertu therefore strongly encourages you to familiarise yourself with the instructions provided with and for these devices.

To help protect your Warranty coverage, you should observe both the preceding "SAFETY TEXT" and the following:

- Always use your Product in the documented manner.
- Your Product contains high precision displays, camera lenses and other such parts, so handle them with great care to avoid scratching or otherwise damaging them.
- Do not attempt to remove any fixed internal battery or memory card.
- Keep the Product free of dust and dirt.
- Do not expose the Product to extreme temperatures, as these may cause the battery to stop working temporarily. Performance is particularly limited in temperatures well below freezing.
- Do not mishandle or abuse the Product.
- Do not paint the Product.
- Only use a soft, clean cloth to clean your Product. Do not use chemicals, detergents, abrasive substances, or any liquids. Use a cotton swab to clean the phone's camera lens.

## Specific phone care

- Avoid scratching the phone screen. Never use a pen, pencil, or other sharp object, on it.

- In order to protect the ceramics and sapphire, do not drop, knock, or rub your phone on or against hard surfaces. In particular, avoid contact with hard materials such as diamond jewellery, nail files, abrasives, and mineral crystals.
- All leather can be damaged and should be treated with care. Therefore, in addition to the avoidance of extreme temperatures or water and high humidity, avoid contact with oily substances, make-up, and solvents.
- Do not allow the metals on the phone to come into contact with sharp objects, metal polishes, and chemicals such as solvents, alkaline and acid solutions, cola-based drinks, and salt water. If contact occurs, wipe the surface with a clean, soft cloth as soon as possible.

## Manufacturer's Limited Warranty

**This Limited Warranty replaces all other Vertu warranties and liabilities, whether oral, written, (non-mandatory) statutory, contractual, in tort or otherwise, including, without limitation, and where permitted by applicable law, any implied conditions, warranties or other terms as to satisfactory quality or fitness for purpose. However, this Limited Warranty shall neither exclude nor limit: i) any of your legal (statutory) rights under the applicable national laws; or ii) any of your rights against the seller of the Product.**

Vertu warrants to you, the Purchaser of the Product, that, during the warranty period, Vertu, or a Vertu-authorized service company, will, in a commercially reasonable time, remedy defects in materials, design and workmanship free of charge, by repairing or, should Vertu in its discretion deem it necessary, replacing the Product in accordance with this Limited Warranty (unless otherwise required by law).

### Warranty periods

The Warranty starts at the time of the original purchase of the Product by the first end user. Different individual products and parts within the overall Product may be covered by different Warranty periods. The different possible Warranty periods are:

- a. Twenty-four (24) months for the mobile phone, and any fixed battery inside it.
- b. Twelve (12) months for all batteries other than those listed at a) (whether they are included as replaceable items in the mobile phone sales package, fixed inside an accessory, or sold separately).
- c. Twelve (12) months for all other accessories not listed above.

As far as your national laws permit, the particular Warranty period will not be extended or renewed, or otherwise affected due to subsequent resale, Vertu-authorized repair, or replacement of the Product. However, any part repaired or product replaced during the Warranty period will be warranted from any defect for 12 months from the date of repair, or for the remainder of the original Warranty period, whichever is the longer.

### How to get warranty service

If you wish to make a claim under this Limited Warranty, please return your Product, or the affected part (if it is not the entire Product), to a Vertu-authorized service company. For further details on how to make

a claim, you can contact a Vertu call centre (national or premium rates may apply). (Information about Vertu-authorized service companies and call centres can be found in the sales package, or on local Vertu web pages, where available.)

Any claim under this Limited Warranty is subject to you notifying Vertu, or a Vertu authorized service company, of the alleged defect within a reasonable time of it having come to your attention, and in any event no later than the expiry date of the Warranty period.

When making a claim under this Limited Warranty, you will be required to provide: a) the affected Product (or the affected part); and b) the original proof of purchase, clearly indicating the name and address of the seller, the date and place of purchase, the Product type, and the IMEI or other serial number.

### **What is not covered?**

1. This Limited Warranty does not cover user manuals or any third party software, settings, content, data or links, whether included or downloaded in the Product, whether included during installation, assembly, shipping or at any other time in the delivery chain or otherwise and in any way acquired by you. By using such a third party application, you acknowledge that the application is provided as is. Vertu does not warrant that any Vertu software will work in combination with any hardware or software provided by a third party, that the operation of any software will be uninterrupted or error-free, or that any defects in the software are correctable or will be corrected.
2. A third party/independent operator provides the SIM card and cellular and/or other network or system on which the Product operates. Therefore, Vertu will not accept responsibility under this Limited Warranty for the operation, availability, coverage, services or range of the cellular or other network or system. Before Vertu or a Vertu-authorized service company can repair or replace the Product, the operator may need to unlock any SIM-lock or other lock that may have been added to lock the Product to a specific network or operator. In such situations, please first ask the operator to unlock your Product.
3. This Limited Warranty does not cover: a) normal wear and tear (including, without limitation, wear and tear of camera lenses, batteries or displays); b) defects caused by rough handling (including, without limitation, defects caused by sharp items, by bending, compressing or dropping, etc.); c) defects or damage caused by misuse of the Product, including use that is contrary to the instructions provided by Vertu (for example, as set out in the Product's user guide), and/or d) other acts beyond the reasonable control of Vertu.
4. This Limited Warranty does not cover defects or alleged defects caused by the fact that the Product was used with, or connected to, any product, accessory, software and/or service not manufactured, or supplied by Vertu, or was used other than for its intended purpose. Defects can be caused by viruses from your, or from a third party's, unauthorised access to services, other accounts, computer systems or networks. Such unauthorised access can take place through hacking, password mining or through a variety of other means.
5. This Limited Warranty does not cover defects caused by the fact that the battery has been short-circuited, or by the fact that the seals of the battery enclosure or the cells are broken or show evidence of tampering, or by the fact that the battery has been used in equipment other than that for which it has been specified. This Limited Warranty is not enforceable if the Product has been opened, modified or repaired by anyone other than an authorised service centre, if it is repaired using unauthorised spare parts, or if the Product's serial number, the mobile accessory date

code, or the IMEI number, has been removed, erased, defaced, altered or are illegible in any way. This shall be determined by the sole discretion of Vertu.

6. This Limited Warranty is not enforceable if the Product has been exposed to moisture, to extreme thermal or environmental conditions (or to rapid changes in such conditions), to corrosion, oxidation, spillage of food or liquid, or to influence from chemical products.

### **Limitations of Vertu's liability**

This Limited Warranty is your sole and exclusive recourse against Vertu, and the only and exclusive liability of Vertu in respect of defects in your Product.

To the extent permitted by applicable law(s), Vertu does not assume any liability for loss of or damage to or corruption of data, for any loss of profit, loss of use or functionality of the Product, loss of business, loss of contracts, loss of revenues or of anticipated savings, increased costs or expenses or for any indirect loss or damage, consequential loss or damage, or special loss or damage. To the extent permitted by applicable law(s), Vertu's liability shall be limited to the purchase value of the Product. The above limitations shall not apply in cases of gross negligence or intentional misconduct of Vertu, or in case of death or personal injury resulting from Vertu's proven negligence.

### **Other important warranty notices**

The availability of products, features, applications, and services may vary by region. For more information, contact your nearest Vertu-branded store or Vertu-authorized service company.

All wireless devices may be susceptible to interference, which could affect performance.

**Vertu is not responsible for any radio or TV interference caused by unauthorised modifications to this equipment. Such modifications could void your authority to operate the equipment.**

Reverse engineering of software in the Product is prohibited to the extent permitted by applicable law. Insofar as this document contains any limitations on Vertu's representations, warranties, damages and liabilities, such limitations shall likewise limit any representations, warranties, damages and liabilities of Vertu's licensors.

Vertu, in a manner consistent with the provisions of section "Limitations of Vertu's liability" above, shall not under any circumstances be liable, either expressly or by implication, for any damages or losses of any kind whatsoever resulting from loss of, damage to, or corruption of, content or data during repair or replacement of the Product.

All parts of the Product or other equipment that Vertu has replaced shall become the property of Vertu. If the Product is found not to be covered by the terms and conditions of this Limited Warranty, Vertu and its authorized service companies reserve the right to charge a handling fee.

When repairing or replacing the Product, Vertu may use products or parts that are new, equivalent to new, or reconditioned. The Product may contain country-specific elements, including software. If the Product has been re-exported from its original destination country to another country, the Product may contain some country-specific elements that are not considered to be a defect under this Limited Warranty.

## Software application notices for the phone

The services on the phone, for example Vertu Life, Vertu Certainty and Recommended apps require a data connection to send up-to-date information to your Vertu phone. If the connection cannot be made, these features will be unavailable or will have reduced functionality. You will need to contact your network service provider for information on the availability of data connectivity when in your home network and when roaming onto other networks.

Some applications on the phone, including those listed above, may connect to the internet automatically. To prevent this, select the appropriate Connectivity settings on the phone and/or disable the services when roaming.

Before installing updates on the phone, ensure that the phone can connect to the internet, and that the phone battery has enough power (or connect the charger before starting the update).

If you install a software update, you cannot use the phone, even to make emergency calls, until the installation has been completed and the device restarted.

Service or software upgrades may reset timers on the phone.

The existence of a certificate considerably reduces the risks involved in remote connections and software installation. To benefit from increased security, certificates must be used correctly, and they must be authentic or trusted. Certificates have a restricted lifetime. If they are expired or invalid, check that the current date and time in your device are correct. Before changing any certificate settings, you must trust the owner of the certificate and be sure that the certificate belongs to the listed owner.

Network support is required to indicate that a sent message has been received or read. However, this information may not always be reliable.

You cannot use the voice recorder during a data call or when a GPRS/3G connection is open.

Only compatible devices can receive and display multimedia messages.

If the item you inserted in a multimedia message is too large for the network, the phone may automatically reduce the size.

Messages may look different in different devices.

If your phone is able to provide over-the-air synchronisation with Microsoft Exchange ActiveSync-enabled servers, the provision of this service does not grant you, and nor do you receive, any rights under any Microsoft intellectual property with respect to any server software, or server device, that is accessed using the phone, or with respect to the use of Microsoft Exchange ActiveSync outside of the phone.

When entering contacts or editing voice commands, do not use very short or similar names for different contacts or commands.

**Using voice tags may be difficult in a noisy environment or during an emergency, so you should not rely solely upon voice dialling in every circumstance.**

A cache is a memory location that is used to store data temporarily on the phone. If you have accessed, or have tried to access, confidential information or a secure service requiring passwords, clear the cache after each use.

The input methods and languages supported by handwriting recognition vary by region and may not be available for all languages.

The availability and quality of GPS signals may be affected by your location, satellite positions, buildings, natural obstacles, weather conditions and adjustments to GPS satellites made by the United States government. GPS signals may not be available inside buildings or underground. Do not use GPS for precise location measurement, and never rely solely on the location information provided by GPS and cellular networks.

Coordinate information may not be available in all regions.

Location information can be attached to an image or a video clip if location coordinates can be determined via network and GPS.

If you share an image or a video clip which has location information attached, the location information may be visible to others that view the image or the video clip. You can deactivate such geotagging in the camera settings.

Some location content is generated by third parties and not by Vertu. Some of this content may be inaccurate and subject to local availability.

Almost all digital cartography is inaccurate and incomplete to some extent. Never rely solely on the cartography that you download for use in this device.

The social networking services are third party services and are not provided by Vertu. They may not be available in all countries.

Check the privacy settings of the social networking service you are using as you may be sharing your location and information with a large group of people. The terms of use apply to sharing information on that service, and you should familiarise yourself with both the terms of use and the privacy practices of the service.

DRM-protected content comes with an associated license that defines your rights to use the content. Some licenses may be connected to a specific SIM card, and the protected content can be accessed only if the SIM card is inserted in the phone.

### **WLAN and Bluetooth restrictions**

There may be restrictions on the use of WLANs and Bluetooth technology in some countries. For more information, contact your local authorities.



## Passive near field communication device

Your phone may contain a Passive Near Field Communication device. This device enables Vertu to verify the authenticity of the phone if it is presented at a Vertu-branded store or Vertu-authorized service company.

## Environmental

### ROHS Statement

This Product does not contain any of the following substances, in accordance with EU RoHS (Reduction of Hazardous Substances) Directive 2011/65/EU:

- Lead
- Hexavalent Chromium
- Mercury
- Polybrominated Biphenyls (PBB)
- Cadmium
- Polybrominated Diphenyl Ethers (PBDE)

### Nickel

The surfaces of Vertu devices do not contain nickel in the platings. Depending on the model and variant of the device, surfaces may contain stainless steel or other alloys.

### EU recycling notice



Vertu complies with European Community requirements for the recycling of Waste Electrical & Electronic Equipment (WEEE). Such compliance is indicated by the addition of the crossed-out wheeled-bin symbol to the Product where appropriate. This symbol indicates that the Product was put onto the market after the WEEE legislation was implemented, and that the consumer should not dispose of the Product as normal household waste or unsorted municipal waste, but that it should be appropriately recycled. Background information on the European WEEE directive is available from [http://ec.europa.eu/environment/waste/weee/index\\_en.htm](http://ec.europa.eu/environment/waste/weee/index_en.htm).

If you want Vertu to recycle your Product at the end of its life, please either return it to the point from which you purchased it (if known), or return it to Vertu's headquarters. Alternatively, should you purchase a replacement Product from another supplier, the new supplier is obliged to take back the original Product and recycle it appropriately.

**Never dispose of a device that has an internal battery fitted, in a fire, because the internal battery may explode.**

## Export and controls

The Product may contain commodities, technology or software subject to export laws and regulations from the US and other countries. Diversion contrary to law is prohibited.

## Copyright and trademark notices

Copyright © Vertu 2011-2014. All rights reserved.

Vertu and the V logo are registered trademarks. Other product and company names mentioned herein may be trademarks or registered trademarks of their respective owners.

Vertu operates a policy of continuous development. Therefore, Vertu reserves the right to make changes and improvements to any of the products described in this document without prior notice.

Google, Google Play, Android and other marks are trademarks of Google Inc.

The Android robot is reproduced or modified from work created and shared by Google and used according to terms described in the Creative Commons 3.0 Attribution License.

This Product is licensed under the MPEG-4 Visual Patent Portfolio License (i) for personal and non-commercial use in connection with information that has been encoded in compliance with the MPEG-4 Visual Standard by a consumer engaged in a personal and non-commercial activity; and (ii) for use in connection with MPEG-4 video provided by a licensed video provider. No license is granted or shall be implied for any other use.

Additional information, including that related to promotional, internal, and commercial uses, may be obtained from MPEG LA, LLC. See <http://www.mpegla.com>.

Dolby and the double-D symbol are trademarks of Dolby Laboratories. Manufactured under licence from Dolby Laboratories.



© 2012 CSR plc and its group companies. The aptX® mark and the aptX logo are trademarks of CSR plc or one of its group companies and maybe registered in one or more jurisdictions.



This product uses Assertive Display technology by Apical Limited

The Bluetooth word mark and logos are owned by the Bluetooth SIG, Inc. and any use of such marks by Vertu is under license.

The availability of particular products, features, applications, and services may vary by region. For more information, contact your nearest Vertu retail store.

## SAR (Specific Absorption Rate) notice - VM-01T

### **YOUR VERTU PHONE (MODEL: Aster T, TYPE: VM-01T, FCC ID: P7QVM-01T) MEETS GUIDELINES FOR EXPOSURE TO RADIO WAVES**

Your phone is a radio transmitter and receiver. It is designed to not exceed the limits for exposure to radio waves recommended by international guidelines. These guidelines were developed by the independent scientific organization ICNIRP, and include safety margins designed to assure the protection of all persons, regardless of age and health.

The exposure guidelines for mobile devices employ a unit of measurement known as the Specific Absorption Rate, or SAR. The SAR limit stated in the ICNIRP guidelines is 2.0 Watts/kilogram (W/kg), averaged over ten grams of tissue. Tests for SAR are conducted using standard operating positions, with the device transmitting at its highest certified power level in all tested frequency bands. The actual SAR level of an operating device can be below the maximum value because the device is designed to use only the power required to reach the network. That amount changes depending on a number of factors, such as how close you are to a network base station. The highest SAR value under the ICNIRP guidelines for use of the device at the ear is 0.274 W/kg. This phone meets RF exposure guidelines when used either in the normal use position against the ear or when positioned at least 10 mm (3/8 inch) away from the body. When a carry case, belt clip or holder is used for body-worn operation, it should not contain metal, and should position the phone at the above-stated distance away from your body.

In order to transmit data files or messages, this device requires a good quality connection to the network. In some cases, transmission of data files or messages may be delayed until such a connection is available. Ensure that the above separation distance instructions are followed until the transmission is completed.

Use of phone accessories and enhancements may result in different SAR values. SAR values may vary depending on national reporting and testing requirements and the network band. Additional SAR information may be provided under Product information at [www.vertu.com](http://www.vertu.com).

### **USA and Canada**

Your phone is also designed to meet the requirements for exposure to radio waves established by the Federal Communications Commission (USA) and Industry Canada. These requirements set a SAR limit of 1.6 W/kg, averaged over one gram of tissue. The FCC/IC highest SAR values reported under this standard during Product certification for use at the head are 0.62 W/kg and 0.62 W/kg, and when properly worn on the body (10 mm gap) is 1.19 W/kg.

Your phone may cause TV or radio interference (for example, when using the phone in close proximity to receiving equipment). The FCC or Industry Canada can require you to stop using your phone if such interference cannot be eliminated. If you require assistance, contact Vertu Customer Service.

The Product, or Products, comply with Part 15 of the FCC rules.



Operation is subject to the following two conditions: (i) the Product(s) may not cause harmful interference, and (ii) the Product(s) must accept any interference received, including interference that may cause undesired operation. Any changes or modifications not expressly approved by Vertu could void the user's authority to operate this equipment.

This Class B digital apparatus complies with Canada ICES-3(B)/NMB-3(B).

The device could automatically discontinue transmission in case of absence of information to transmit or of operational failure. Note that this is not intended to prohibit the transmission of control or signalling information or the use of repetitive codes where required by the technology.

- The device for the band 5150-5250 MHz is only for indoor usage to reduce potential for harmful interference to co-channel mobile satellite systems.
- The maximum antenna gain permitted (for devices in the bands 5250-5350 MHz and 5470-5725 MHz) to comply with the limit on equivalent isotropically radiated power (EIRP).
- The maximum antenna gain permitted (for devices in the band 5725-5850 MHz) to comply with the EIRP limits specified for point-to-point and non point-to-point operation as appropriate.

In addition, high-power radars are allocated as primary users (meaning that they have priority) of the band 5250-5350 MHz, and these radars could cause interference and/or damage to licence-exempt LAN devices.

## Declaration of Conformity

**CE 0168**

We, Vertu, declare under our sole responsibility that the following are in conformity with the provision of Council Directive 1999/5/EC: Model VERTU Aster T, type VM-01T; Model Vertu V Collection Wired Headset type WH-4V & WH-5V; and USB data cable, type CA-225DV. A copy of the Declaration of Conformity can be found at <http://www.vertu.com>.

Vertu Corporation Limited, Beacon Hill Road, Church Crookham, Hampshire GU52 8DY.