

VERTU

HANDMADE IN ENGLAND

SIGNATURE S

USER GUIDE VERSION 1.0

Contents

Introduction	4
Your Signature phone	4
Help and support	4
Safety	5
Safety	5
Your phone	6
Package contents	6
Features and keys	6
Antenna locations	8
Change the volume	8
Getting started	9
Insert the SIM card	9
Insert the battery	10
Charge the phone	11
Switch the phone on or off	12
Start-up process	13
Lock and unlock your phone keypad	14
Explore	15
About the home screen	15
Status and notification bar	15
Status and notification icons	16
About the main menu	16
Change the menu layout	17
Go to menu	18
Vertu Services	19
About Vertu Services	19
Text entry	20
Enter text on the keypad	20
Calls	21
Make and answer calls	21
Call recent number	21
Call using speed dial	21
Listen to your voicemail	22
Divert calls to another number	22
View information about calls and data use	22
Use fixed dialling to restrict outgoing calls	22
Call barring	23
Contacts	24
About contacts	24
Add contacts	24
View contacts	25
Call or text contacts	25
Edit or delete a contact	25
Contact groups	26
View your own number	27
Save a number from a call or message	27
Add contacts to your speed dial list	27
Transfer contacts	28
Messaging and email	29
About messaging	29
Send and read messages	29
Set up your email	30
Send and read email	30
Manage messages and email	31
Music	32
About music	32
Play music	32
Personalising your phone	34
Profiles	34
Ringtones and alerts	35
Themes	35
Wallpapers	35
Shortcuts	36
Display settings	36
Date and time settings	37
Language settings	37
Browser	38
Connect to the internet	38
Browse the web	38
Gallery	39
About the gallery	39
View images and video clips	39
Listen to audio files	39
Organise the gallery	39
Office tools	41

Alarm clock	41	Battery charger	56
Calculator	41	Data cable	57
Calendar	42	Specifications	58
To-do lists	43	Specifications	58
Voice recorder	43	Care of your phone	60
Connectivity	44	General care	60
Restrictions	44	Embroidery	60
WLAN	44	Exotic leathers	60
Mobile data	44	Leather	61
Bluetooth	45	Non-precious metals	61
Sync with a cloud account	46	Precious metals	61
Transfer files between your phone and a computer	46	Precious stones	61
Tethering and portable hotspot	46	Sapphire and ceramics	62
Phone management	48	Safety and warranty	63
System update	48	Safety text	63
Data roaming settings	48	Additional care and maintenance	66
Set your phone to lock automatically	49	Manufacturer's Limited Warranty	67
Access codes	49	Software application notices for the phone	71
Use a PIN or PIN2 code	50	Environmental	72
Use a security keyguard	50	Export and controls	73
Reset to workshop settings	51	Copyright and trademark notices	73
Boot validation	51	SAR (Specific Absorption Rate) notice - Type: VM-06	74
FAQs	52	Declaration of Conformity	75
Questions	52		
How can I extend the battery life of my phone?	53		
How can I reduce my data costs?	53		
How do I transfer music or photos from my computer to my phone?	53		
How do I transfer contacts to my phone? ..	54		
How do I change the font size on my phone?	54		
Why have I got no connectivity?	54		
How do I protect my phone from unauthorised use?	54		
How do I find the IMEI number of my phone?	54		
Why does my phone get warm?	55		
Accessories	56		

Introduction

Your Signature phone

This user guide is intended to provide you with details on how to use the prominent features on your Signature.

To access the exclusive privileges and benefits from Vertu, you must register your phone.

The pictures used in this user guide are provided for illustration purposes only. They may differ from the exact appearance of your Signature.

Help and support

To find out more about using your phone:

- 1 Use Vertu Support to contact Vertu Customer Service by email or phone.
- 1 Refer to the user guide on the Vertu website at <http://www.vertu.com/gb/en/product-support/user-guides-and-downloads/>.
- 1 Use the setup wizard available on the phone to help you with things such as choosing a language and registration.

Compliance information

You can find compliance information on a metal plate that is located in the battery compartment. For instructions on accessing the battery compartment, see "Insert the battery" on page 10. The information displayed includes the IMEI number, serial number and product name. To view all of the compliance information for your Signature, Select GoTo (LSK) > Select Up key to move to bottom of GoTo list > 'Regulatory Info' should be highlighted – select Centre key to open.

Safety

Safety

Read these simple guidelines. Not following them may be dangerous or illegal. Read the complete user guide for further information.



Switch off in restricted areas

Switch the device off when mobile phone use is not allowed or when it may cause interference or danger, for example, in aircraft, in hospitals or near medical equipment, fuel, chemicals, or blasting areas. Obey all instructions in restricted areas.



Road safety comes first

Obey all local laws. Always keep your hands free to operate the vehicle while driving. Your first consideration while driving should be road safety.



Interference

All wireless devices may be susceptible to interference, which could affect performance.



Qualified service

Only qualified personnel may install or repair this product.



Keep your device dry

Your device is not water-resistant. Keep it dry.



Protect your hearing

To prevent possible hearing damage, do not listen at high volume levels for long periods. Exercise caution when holding your device near your ear while the loudspeaker is in use.

Your phone

Package contents

- 1 Signature phone
- 1 Battery
- 1 Wall charger (AC-32V) with regional plug
- 1 MicroUSB cable 1200 mm (CA-225DV)
- 1 Protective leather case
- 1 Polishing cloth
- 1 Collateral pack, including Quick Start Guide, Warranty and Authenticity Card

The package contents may vary slightly in accordance with the materials used in your particular phone and with regional regulations.

Features and keys

Front

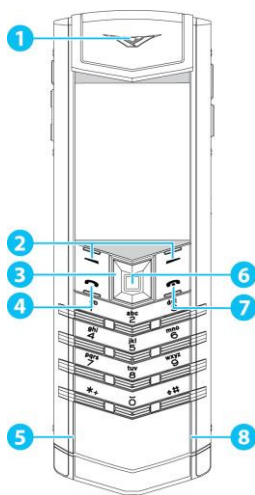

- 1 Notification LED
- 2 Selection keys
- 3 Navigation key
- 4 Call key
- 5 Microphone
- 6 Centre select key
- 7 End key
- 8 Light sensor

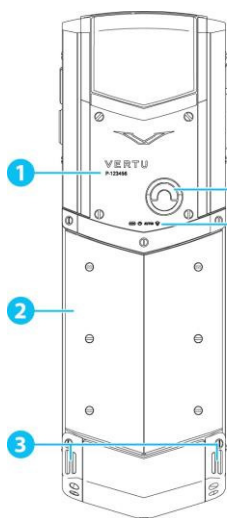
Back

- 1 Serial number
- 2 Battery cover
- 3 Speaker ports
- 4 Battery cover release D-ring
- 5 Hallmarks (precious metal phones only)

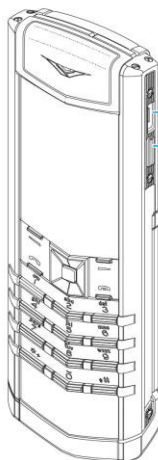
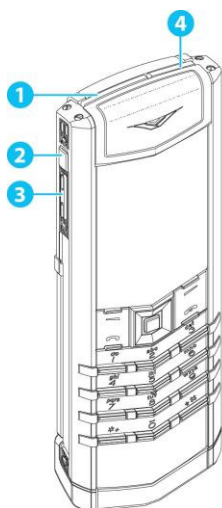
Side

- 1 SIM tray
- 2 Release lever for the SIM card tray
- 3 Volume keys
- 4 Power key
- 5 MicroUSB port
- 6 Vertu key

Antenna locations

Avoid touching the antenna areas while the antennas are in use. Contact with antennas affects the communication quality and may reduce battery life due to higher power levels during operation.

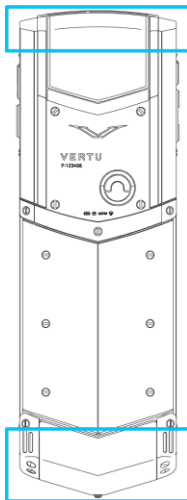

Change the volume

Press the volume keys to change the volume during a call. When you are not on a call, press the volume keys to change the ringtone volume.

Getting started

Insert the SIM card

Your Signature phone is equipped to work with a nanoSIM card.

To avoid damaging the SIM card or your phone, follow these steps carefully:

1. Slide your fingernail under the top of the release lever for the SIM tray. Pull the release lever down until the SIM tray pops out at the top of your phone.

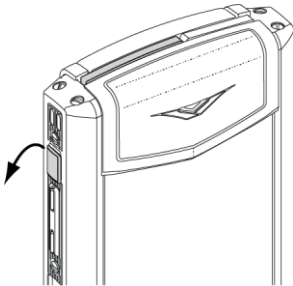

2. Pull the SIM tray out of your phone to remove it.

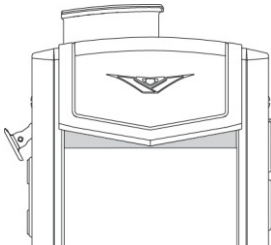

3. Place the SIM card in the SIM tray.

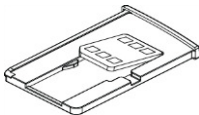

4. While holding the SIM card in the SIM tray, carefully insert the SIM tray into your phone. Gently push in the SIM tray until you feel it click into position.

Insert the battery

- !** **Important:** Before you remove the battery cover, ensure your phone is switched off and is not charging.

To avoid damaging the battery or your phone, follow these steps carefully:

1. On the back of your phone, use your fingernail to lift the battery cover release D-ring. Turn the D-ring anticlockwise until the battery cover pops open.

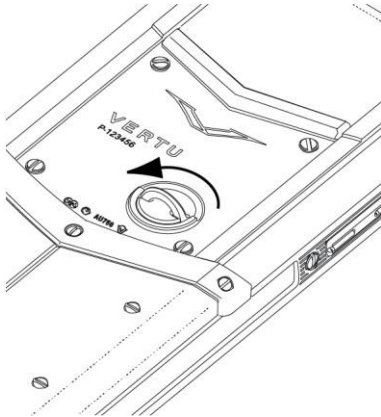

2. To remove the battery cover, lift the cover and then gently move it towards the top of your phone.

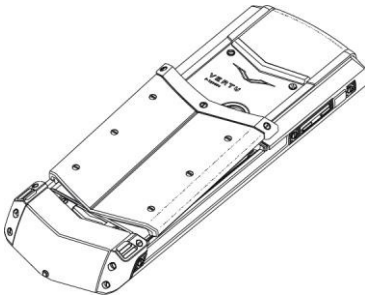

3. Insert the battery at a slight angle, so the metal contacts on the battery align with the metal contacts on your phone.

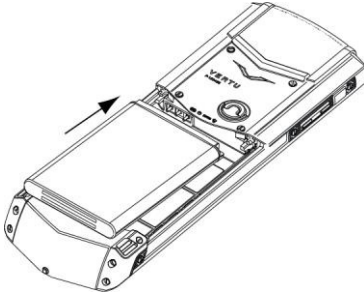

4. Lower the bottom of the battery into the battery compartment until it slots into place.
5. To replace the battery cover, insert the bottom clip of the cover into the slot below the battery.

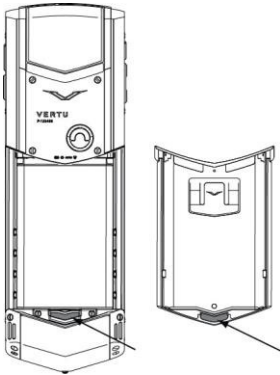

6. Gently push the top of the battery cover until it clicks into place.
7. Close the battery cover release D-ring.

Charge the phone

The battery needs activating prior to first use, and it is recommended to charge the battery at this point as it may not have been supplied with a full charge. Connect the supplied USB data cable into the charging port on the side of the phone. Then connect the other end of the cable to the USB port on your Vertu mains charger.



Important: Use only chargers, cables and accessories supplied by Vertu.

If the phone indicates a low charge, do the following:

1. Connect the supplied wall charger to the wall outlet and then insert the microUSB connector into your phone.

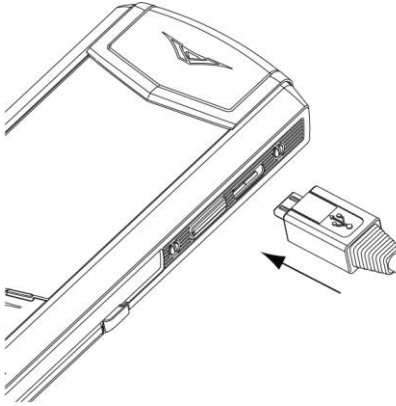

2. When the battery is fully charged, disconnect the charger from the phone and then from the wall outlet.

Note:

- 1 You can use the phone while it is charging.
- 1 If the battery is completely discharged, it may take several minutes before the charging indicator is displayed or before you can make any calls.

Other ways to charge the battery

You can also charge your phone by connecting it to your computer using the USB cable.

Note: Your phone charges quicker when connected to the wall charger compared to when connected to your computer.

Switch the phone on or off

To switch your phone on or off, press and hold the power key.

Start-up process

When you switch on your phone for the first time, a setup wizard helps you to get started. The setup wizard takes you through the following steps:

1 Choose a display language

1. Choose a language from the list and press **Select**.

2 Connect to a Wi-Fi network

To access Vertu services, connect to a nearby Wi-Fi network.

1. Choose a Wi-Fi network and press **Select**.
2. Use the number keys to enter the password for the Wi-Fi network, then press **OK**.



Tip: To change between upper and lower case, press the **⇧#** key.

Note: You can choose to skip this step, however you will not be able to register with Vertu until you do.

3 Set the date and time

If your phone does not set the date and time automatically, set them manually.

1. To set the date or change the date format, choose **Date** and press **Change**.



Tip: To enter the date, use the number keys.

1. To set the time or change time settings, choose **Time** and press **Change**. You can choose to display an analog or digital clock on the home screen, and choose a 12 hour or 24 hour time format. You can also set the time zone you are currently in.



Tip: To enter the time, use the number keys.

When you have saved your changes, press **Next**.

4 Choose your home time zone

Your home time zone is automatically set to the time zone you are currently in. If you live in a different time zone to the one shown, you can change it.

1. Press **Change**.
2. Choose a time zone and press **Save**.

When your home time zone is correct, press **Next**.

5 Register with Vertu

If you are a new Vertu customer, create a Vertu account. If you already own a Vertu phone, you can simply log in to your existing account with your Vertu username and password.

Register with Vertu to access unique privileges and benefits relevant to you.



Tip: For instant access to the Vertu Concierge service at any time, press the Vertu key.

6 Sync your contacts and calendar events

You can sync contacts and calendar events on your phone with an existing account in the cloud. To find out more about syncing with an existing account, see "Sync with a cloud account" on page 46.

7 You're ready to go

Your phone is now set up and ready to use.

To run the setup wizard again at a later date:

1. Press **Menu**.
2. Choose **Settings** and press **Select**.
3. Choose **Setup wizard** and press **Select**.

Lock and unlock your phone keypad

To lock the keypad, from the home screen, press the centre select key and then press ***+** within 2 seconds.

When the keypad is locked, your phone displays the  icon.

Note: When the keypad is locked, you can still make calls to emergency numbers.

To unlock the keypad, press the centre select key and then press ***+** within 2 seconds.

Explore

About the home screen

When you turn on your phone, it displays the home screen. Use the home screen to access the features of your phone. The home screen provides you with all the latest information:

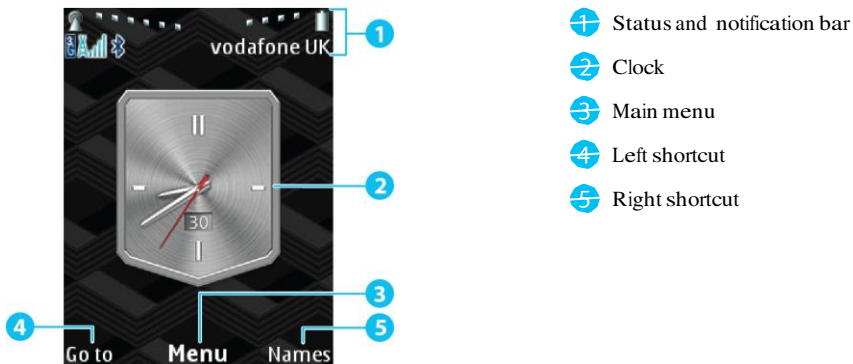





































Note: All of the steps described in this user manual assume you start from the home screen.

Status and notification bar

The status and notification bar at the top of the screen displays the following information:

- 1 Status information, for example, network signal strength and battery level
- 1 Notifications, for example, when you receive a new message or have missed a call

Status and notification icons

	Network signal strength		Sending message
	Battery level		WLAN available
	2G data connection (available)		WLAN scanning
	2G data connection (active) connected		WLAN
	2G data connection (suspended)		Bluetooth™ on
	3G data connection (available)		Bluetooth™ connected
	3G data connection (active)		Headset connected
	3G data connection (suspended)		Loading web page in browser
	Keypad locked		Secure web page in browser (encryption off)
	Silent mode		Secure web page in browser (encryption on)
	Active call		Flight mode
	Missed call		USB connected
	Speaker on		Selected contact is saved on your SIM card
	Call line 1		Text input mode
	Call line 2		Predictive text on
	New voicemail message		Predictive text off
	New text message		Alarm set
	New email snoozed		Alarm









About the main menu

The main menu gives you access to your phone's features.

To open the main menu, use the centre select key to press **Menu** on the home screen.

To move through the menus, use the navigation keys.

To return to the previous menu, press **Back**. If you are in a menu and want to return to the home screen without saving changes, press .

Menu	Use
 Messages	Send messages and view your message folders
 Contacts	View and update your contacts list
 Call history	View information about recent calls, messages and data use
 Settings	Configure your phone, for example, set a new ringtone or change Bluetooth™ settings
 Additions	Connect to the internet, listen to music, view your gallery or use the voice recorder
 Calendar	View your calendar, set reminders, create a to-do list or make notes
 Alarm clock	Set an alarm
 Calculator	Use the calculator
 Vertu Services	Access Vertu services, for example, Vertu Concierge

Change the menu layout

Your phone can display the main menu in a list, 3 by 3 grid, or using tabs. You can also rearrange menu items, so the features you use most are easy to find.

To change the menu layout:

1. Press **Menu**.
2. Press **Options**.

3. Choose **Main menu view** and press **Select**.
4. Choose a layout option and press **Select**.

To change the order of menu items:

1. Press **Menu**.
2. Press **Options**.
3. Choose **Organise** and press **Select**.
4. Choose a menu item and press **Move**.
5. Choose a new location for the menu item and press **OK**.
6. To save changes, press **Done** and then press **Yes**.

Go to menu

The Go to menu contains shortcuts to features and settings that you use most often.

To open the Go to menu, use the left selection key to press **Go to**.



Tip: If the left selection key is not assigned to the Go to menu, see "Shortcuts" on page 36.

You can choose the features and settings displayed in the Go to menu.

To personalise the Go to menu:

1. Press **Go to**.
2. Press **Options**.
3. To choose the features and settings that are listed:
 - a. Choose **Select options** and press **Select**.
 - b. Mark or unmark the features and settings you use most often.
 - c. To save changes, press **Done** and then press **Yes**.
4. To change the order of features and settings:
 - a. Choose **Organise** and press **Select**.
 - b. Choose a list item and press **Move**.
 - c. Choose a new location for the list item and press **OK**.
 - d. To save changes, press **Done** and then press **Yes**.

Vertu Services

About Vertu Services

Your unique Vertu experience starts with registration. When you have successfully registered your phone, you can access the benefits by pressing the Vertu key or going to the **Vertu Services** menu. It's simple to stay in touch, as you can email or call Vertu directly from your Signature.

Vertu Concierge

Concierge offers 24-hour worldwide assistance, recommendations and priority bookings. They facilitate your every request, from finding the perfect gift to accessing 'money-can't-buy' events, experiences and everything in between. Your Concierge will fulfil every request using their unique expertise and inside knowledge.

Vertu Support

If you require any help with your Signature, our renowned Vertu Customer Service is always available.

Vertu Sync

Vertu Sync allows you to sync your phone with your cloud account. For more information, see "Sync with a cloud account" on page 46.

Text entry

Enter text on the keypad

To enter text on your phone, use the keypad. Each of the keys on your phone represents several letters.

Text entry modes

You can choose between multi-tap mode and predictive mode.







Tip: Predictive mode allows you to enter text quicker than when in multi-tap mode.



To enter a word when in multi-tap mode:

1. Press a number key multiple times, until the first letter in the word appears.
2. Repeat this for the remaining letters in the word.

To enter a word when in predictive mode:





1. Press a number key once for the first letter in the word.
2. Press number keys for the remaining letters in the word. As you continue to press number keys, your phone suggests suitable words.
3. Accept the suggested word or choose a different word.
 1. To accept the suggested word and enter a space, press the  key. To accept the suggested word and enter a full stop, press the  key.
 1. To choose a different word, press the  key until the correct word is displayed, then press the  key.

To change how you enter text:

1. To change the text entry mode, press and hold the  key. You can choose to use number entry mode, turn predictive text on and off, or change the writing language.
1. To change between upper, lower and mixed case, press the  key.

Symbols and other characters

To enter symbols and other characters:

1. To enter a space, press the  key.
1. To enter punctuation such as full stops and commas, press the  key.
1. To view a list of symbols, press and hold the  key. To view more symbols, press the  key again. Use the navigation keys to choose a symbol, then press the centre select key to insert it.
1. To enter a number, press and hold a number key.

Calls

Make and answer calls

To make a call:

1. From the home screen, use the keypad to enter the phone number.
2. To make the call, press .

Note: To enter the + character, used for international calls, press *+ twice.

3. To end the call, press .

To answer a call, press .



You can also reject calls, silence calls or send a text message to the caller.

1. To send an incoming call to your voicemail, press .
1. To silence an incoming call, press the power key or volume keys.
1. To send a text message to the caller, press **Options**. Choose **Send message** and press **Select** to open the message editor.

Call recent number

The call log displays information about the calls you have made and received. This makes it easy to call someone again if they are not answering. Simply access the call log and quickly retrieve the number.

To call an entry in the call log:

1. From the home screen, press .
2. Choose the contact or phone number you want to call.
3. Press .

To delete an entry in the call log, press **Options**. Choose **Delete** and press **Select**.

To view detailed information about your calls and data use, see "View information about calls and data use" on page 22.

Call using speed dial

Speed dial enables you to quickly call your favourite contacts. You can assign a contact to each of the number keys from 2 to 9. The number 1 key is assigned to your voicemail.

To call a contact in your speed dial list, from the home screen press and hold a number key.

To add contacts to your speed dial list, see "Add contacts to your speed dial list" on page 27.

Listen to your voicemail

People can leave you a voicemail message, for example, when you have not answered the call.

To listen to your voicemail messages, from the home screen, press and hold .

Note: Voicemail is a network service. For details, contact your service provider.

Divert calls to another number

If you cannot answer your calls, you can divert incoming calls to another phone number.

Note: Call divert is a network service. For details, contact your service provider.

To change your call divert settings:

1. Press **Menu**.
2. Choose **Settings** and press **Select**.
3. Choose **Call** and press **Select**.
4. Choose **Call divert** and press **Select**.
5. Choose a divert option and press **Select**.
6. Choose to activate, cancel or check the status of the divert option. If you choose **Activate**, use the keypad to enter the phone number or choose a contact, then press **OK**.

View information about calls and data use

To view detailed information about your calls and data use:

1. Press **Menu**.
2. Choose **Call history** and press **Select**.
3. Choose from the following options:
 1. To view call logs, choose **All calls**, **Missed calls**, **Received calls** or **Dialled numbers**.
 1. To clear call logs, choose **Clear log lists**.
 1. To view the duration of your calls, for example for your most recent call, choose **Call duration**.
 1. To view the amount of data you have sent and received, choose **Data counter**.
4. Press **Select**.

Use fixed dialling to restrict outgoing calls

To restrict outgoing calls to only the numbers you specify in a list, use fixed dialling.

Note: Fixed dialling is a network service. For details, contact your service provider.

To turn fixed dialling on or off:

1. Press **Menu**.
2. Choose **Settings** and press **Select**.
3. Choose **Security** and press **Select**.
4. Choose **Fixed dialling** and press **Select**.
5. Choose one of the following options:
 1. To turn fixed dialling on or off, choose **On** or **Off** and press **Select**.
 1. To edit the list of numbers you can call when fixed dialling is on, choose **Number list** and press **Select**.

Call barring

Use call barring to allow or prevent incoming and outgoing calls. To manage your call barring settings, you need to enter a call barring password.

Note: Call barring is a network service. For details, contact your service provider.

To manage your call barring settings:

1. Press **Menu**.
2. Choose **Settings** and press **Select**.
3. Choose **Security** and press **Select**.
4. Choose **Call barring service** and press **Select**.
5. Choose to activate call barring for outgoing calls, international calls, incoming calls, or incoming calls when abroad.





Tip: To change your call barring password, choose **XXXXChange barring pass.XXXX** and press **Select**.

Contacts

About contacts

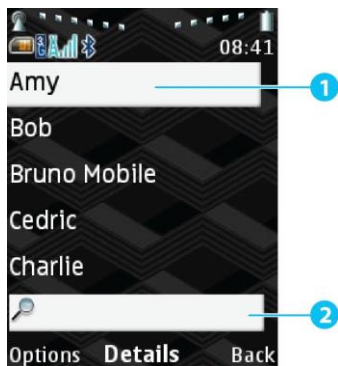
Use contacts to save and organise your friends' phone numbers, addresses and other contact information.



 Contact name

 Search box

Add contacts

To add a new contact:

1. Press **Menu**.
2. Choose **Contacts** and press **Select**.
3. Choose **Add new contact** and press **Select**.
4. If required, choose where to save the contact and press **Select**.
5. Enter the contact details.
6. To add more details to the contact, press **Options**. Choose **Add detail** and press **Select**.

Note: The first phone number you enter for a contact is automatically set as the default number. To change the default number for a contact, choose the phone number to set as default and press **Options**. Then choose **Set as default** and press **Select**.

7. To save the contact, press **Save**.



Tip: To import contacts from a cloud account, see "Sync with a cloud account" on page 46.

View contacts

To view your contacts list:

1. Press **Menu**.
2. Choose **Contacts** and press **Select**.
3. Choose **Names** and press **Select**. Your contacts list is displayed.



Tip: To search for a contact, use the keypad to start typing their name.

4. To see the details for a contact, press **Details**.

Call or text contacts

To call a contact:

1. Press **Menu**.
2. Choose **Contacts** and press **Select**.
3. Choose **Names** and press **Select**.
4. Choose a contact and press  to call their default number.



Tip: To call a phone number other than the default number, press **Details**. Choose a number and press .

To text a contact:

1. Press **Menu**.
2. Choose **Contacts** and press **Select**.
3. Choose **Names** and press **Select**.
4. Choose a contact and press **Details**.
5. Press **Options**.
6. Choose **Send message** and press **Select**.
7. Type in the message and press **Send**.

Edit or delete a contact

To edit or delete a contact:

1. Press **Menu**.
2. Choose **Contacts** and press **Select**.
3. Choose **Names** and press **Select**.
4. Choose a contact and press **Options**.

5. Choose to edit or delete the contact.
 1. To edit the contact, choose **Edit contact** and press **Select**. Edit the contact details and press **Save**.
 1. To delete the contact, press **Delete contact** and press **Select**. Press **Yes** to confirm.

Contact groups

You can organise contacts into groups. For example, you can add all of your family members to a group. Groups allow you to quickly send a message to all contacts in a group.

To create a group:

1. Press **Menu**.
2. Choose **Contacts** and press **Select**.
3. Choose **Groups** and press **Select**.
4. Add a new group.
 1. If you don't have any groups, press **Add**.
 1. If you have already created a group, press **Options**. Then choose **Add new group** and press **Select**.
5. Enter a group name and press **Save**.

To add contacts to a group:

1. Press **Menu**.
2. Choose **Contacts** and press **Select**.
3. Choose **Groups** and press **Select**.
4. Choose a group and press **View**.
5. Press **Add**.
6. Choose a contact to add to the group and press **Select**.

To remove contacts from a group:

1. Press **Menu**.
2. Choose **Contacts** and press **Select**.
3. Choose **Groups** and press **Select**.
4. Choose a group and press **View**.
5. Choose a contact to remove from the group and press **Options**.
6. Choose **Remove member** and press **Select**.

View your own number

You can easily check your own phone number. The displayed phone number is for the SIM card inserted in your phone.

To view your own number:

1. Press **Menu**.
2. Choose **Contacts** and press **Select**.
3. Choose **My numbers** and press **Select**.

Save a number from a call or message

You can use a phone number from a call or message to create or update a contact. If there is a phone number within the message, you can save that number too.

To save a number from your call log:

1. From the home screen, press .
2. Choose an entry and press **Options**.
3. Create a new contact or update an existing contact.
 1. To create a new contact, choose **Save** and enter the contact details.
 1. To update an existing contact, choose **Add to contact**. Choose a contact and press **Add**.

To save a number from a message:

1. Press **Menu**.
2. Choose **Messages** and press **Select**.
3. Choose **Inbox** and press **Select**.
4. Open a message and press **Options**.
5. Choose **Use detail** and press **Select**.
6. Choose **Number** and press **Select**.
7. Choose the number to save and press **Save** and choose a contact to update.

Add contacts to your speed dial list

You can add contacts that you often call to your speed dial list. Position 1 in your speed dial list is assigned to your voicemail.

To add contacts to your speed dial list:

1. Press **Menu**.
2. Choose **Contacts** and press **Select**.

3. Choose **Speed dials** and press **Select**.
4. Choose a speed dial position and press **Assign**.
5. Choose a contact and press **Select**.

Transfer contacts

You can transfer contacts between your SIM card and phone.



Tip: You can also use Vertu Sync to sync the contacts on your phone with your email account. See "Sync with a cloud account" on page 46.

To move or copy all contacts between your SIM card and phone:

1. Press **Menu**.
2. Choose **Contacts** and press **Select**.
3. Choose **Move contacts** or **Copy contacts**, then press **Select**.
4. Choose the direction to move or copy contacts and press **Select**.
5. Press **Yes** to transfer all contacts.

To move or copy individual contacts between your SIM card and phone:

1. Press **Menu**.
2. Choose **Contacts** and press **Select**.
3. Choose **Names** and press **Select**.
4. Choose a contact and press **Options**.
5. Choose **Move contact** or **Copy contact**, then press **Select**.
6. Press **Yes** to transfer the contact.

Messaging and email

About messaging

Send messages to your friends and family to keep in touch. You can send and receive the following types of messages:

- 1 Text messages
- 1 Multimedia messages, which contain photos, videos or audio

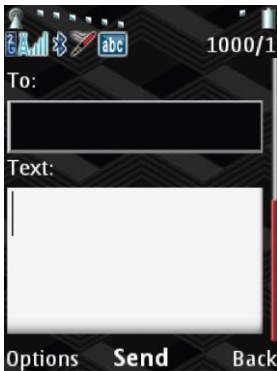

When you send and receive messages, your phone organises them into the following folders in the **Messages** menu:

- 1 **Inbox**
- 1 **Drafts**
- 1 **Outbox**
- 1 **Sent items**
- 1 **Saved items**

 **Tip:** To help organise your messages, you can create personal folders in the **Saved items** folder. When you are in the **Saved items** folder, press **Options**. Then choose **Add folder** and press **Select**.

Send and read messages

To send a message:

1. Press **Menu**.
2. Choose **Messages** and press **Select**.
3. Choose **Create message** and press **Select**.

4. In the **To:** field, enter one or more recipients.
 1. To enter a phone number, use the keypad.
 1. To add a recent number or contact, press **Add**.
5. In the **Text:** field, enter your message.
6. To view options for the message, press **Options**. For example, you can insert an image, save the message to your drafts folder, or change settings.
7. To send the message, press **Send**.

To read a new message:

1. When you receive a new message, a notification appears and the  icon is displayed in the status and notification bar. To open the new message, press **View**. To reply to the message, press **Reply**.

To read a message saved in a message folder:

1. Press **Menu**.
2. Choose **Messages** and press **Select**.
3. Choose a message folder and press **Select**.
4. Choose a message and press **Open**.

To delete a message:

1. Choose a message and press **Options**.
2. Choose **Delete** and press **Select**.

Set up your email

You can set up your email accounts on your phone, so you can keep in touch on the move.

To set up an email account:

1. Press **Menu**.
2. Choose **Messages** and press **Select**.
3. Choose **E-mail** and press **Select**.
4. Enter the email address and password for your email account, then press **Login**.
5. Change the settings for the email account. For example, you can change the mailbox name or change how often emails sync to your phone.
6. To finish setting up your email account, press **OK**.

Send and read email

You can send and read emails in your email mailbox.

To view your email mailbox:

1. Press **Menu**.
2. Choose **Messages** and press **Select**.
3. Choose your email mailbox and press **Select**.

To send an email from your mailbox:

1. Press **Options**.
2. Choose **XXXXNew E-mailXXXX** and press **Select**.
3. In the **To:** field, enter one or more recipients.
 1. To enter an email address, use the keypad.
 1. To add a recent email address or contact, press **Add**.
4. In the **Text:** field, enter the message for the email.
5. To view options for the email, press **Options**. For example, you can insert an image, save the email to your drafts folder, or preview the email.
6. To send the email, press **Send**.

To read an email in your mailbox:

1. Choose an email and press **Open**.

To reply to or delete an email in your mailbox:

1. Open an email and press **Options**.
2. Choose **Reply** or **Delete** and press **Select**.

Manage messages and email

You can change various settings for messages, such as the font size of messages or whether delivery reports are on or off. You can also add a contact or number as your favourite recipient, so they appear at the top of the recipient list when you send a message.

You can also change settings for your email account, such as the name of your mailbox or how often your phone checks for new emails.

To change message and email settings:



1. Press **Menu**.
2. Choose **Messages** and press **Select**.
3. Choose **Message settings** and press **Select**.
4. Choose which settings to change and press **Select**.

Music

About music

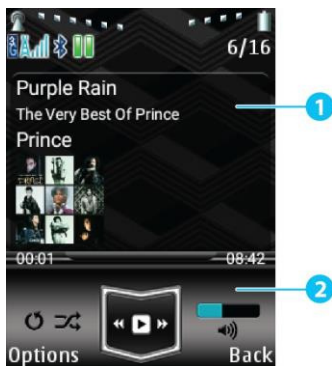
Use the music player to play music anywhere.



-  Current song
-  Music player controls

To add music to your Signature, see "Transfer files between your phone and a computer" on page 46.

Supported file types

Your Signature plays the following file formats: AAC, AAC+, MP3, MP4, WAV, M4A, OGG and WMA.

Play music

To play music:

1. Press **Menu**.
2. Choose **Additions** and press **Select**.
3. Choose **Music player** and press **Select**.
4. Choose one of the following options:
 1. To open the music player and start listening to music, choose **Go to Music player** and press **Select**.
 1. To browse through your music folders, use the navigation key. Your music is sorted into artists, albums and genres. You can also listen to a playlist of songs.

Music player controls



- 1. Play or pause: press the centre select key.
- 1. Skip to the previous or next file: press the left or right directional key.
- 1. Fast forward or rewind: press and hold the left or right directional key.

- 1 Change the volume: press the volume keys on the side of the phone.
- 1 Go to the music home screen: press **Back**.
- 1 Change settings for shuffle, repeat and equaliser: press **Options**. Choose **Settings** and press **Select**.
- 1 Add the current file to a playlist: press **Options**. Choose **Add to playlist** and press **Select**.
- 1 Play music through a Bluetooth device: press **Options**. Choose **Play via Bluetooth** and press **Select** to view available devices. To learn more about Bluetooth, see "Bluetooth" on page 45.

Personalising your phone

Profiles

Use profiles to easily change several settings at once. You can choose the settings for a profile in advance, then quickly activate the profile when you need it.

 **Tip:** The Flight profile puts your phone in flight mode. In flight mode, you cannot use features on your phone that require network coverage, WLAN or Bluetooth™. When you activate the Flight profile, the  icon is displayed in the status and notification bar.

To activate a profile:

1. Press the power key.
2. Choose a profile and press **Select**.

To personalise a profile:

1. Press **Menu**.
2. Choose **Settings** and press **Select**.
3. Choose **Profiles** and press **Select**.
4. Choose a profile and press **Select**.
5. Choose **Personalise** and press **Select**.
6. Change the settings for the profile.
7. Press **Save**.

When you activate a profile, you can also choose a time for it to end. For example, before you head into a meeting that is for an hour, temporarily activate the Meeting profile. After an hour, your phone automatically changes back to the General profile.

To temporarily activate a profile:

1. Press **Menu**.
2. Choose **Settings** and press **Select**.
3. Choose **Profiles** and press **Select**.
4. Choose a profile and press **Select**.
5. Choose **Timed** and press **Select**.
6. Use the number keys to enter the end time for the profile.
7. If you are using a 12 hour time format, choose **am** or **pm**.
8. Press **OK**.

Ringtones and alerts

You can change your ringtone and other sounds, such as the message alert. You can also change the volume of sounds and turn vibrate on or off.

Note: When you change your ringtone and other sound settings, it only affects the current profile.

To change your ringtone and other sound settings:

1. Press **Menu**.
2. Choose **Settings** and press **Select**.
3. Choose **Tones** and press **Select**.
4. Change settings for different sounds.



Tip: To turn vibrate on or off, change the **Vibrating alert** setting.

5. To save changes, press **Save**.

Themes

Use themes to change the look of menus and the home screen.



Tip: If you set a wallpaper, this overrides the theme on the home screen.

To set a theme:

1. Press **Menu**.
2. Choose **Settings** and press **Select**.
3. Choose **Themes** and press **Select**.
4. Choose a theme folder and press **Open**.
5. Choose a theme to use.

As you move through the list, a preview of each theme is displayed.

6. Press **Apply**.

Wallpapers

You can use any image as a wallpaper for the home screen. To add images to your Signature, see "Transfer files between your phone and a computer" on page 46.

To choose a wallpaper:

1. Press **Menu**.
2. Choose **Settings** and press **Select**.

3. Choose **Display** and press **Select**.
4. Choose **Wallpaper** and press **Select**.
5. Choose an image for the wallpaper.
6. Press **Apply**.

Shortcuts

Shortcuts allow you to quickly access your favourite features from the home screen. You can assign home screen shortcuts to the following keys:

- 1 Left selection key
- 1 Right selection key
- 1 Each of the four navigation keys

To change the shortcut assigned to the left or right selection key:

1. Press **Menu**.
2. Choose **Settings** and press **Select**.
3. Choose **My shortcuts** and press **Select**.
4. Choose **Left selection key** or **Right selection key** and press **Select**.
5. Choose a feature to assign to the key and press **Select**.

To change the shortcut assigned to a navigation key:

1. Press **Menu**.
2. Choose **Settings** and press **Select**.
3. Choose **My shortcuts** and press **Select**.
4. Choose **Navigation key** and press **Select**.
5. Choose a navigation key and press **Change**.
6. Choose a feature to assign to the key and press **Select**.

Display settings

You can change the display settings on your phone, for example, the font size or notification details.

To change the display settings:

1. Press **Menu**.
2. Choose **Settings** and press **Select**.
3. Choose **Display** and press **Select**.

4. Choose from the following options:

- 1 To open the font size settings, choose **Font size** and press **Select**. You can change the font size in messages, menus or the browser.
- 1 To show or hide the local area code on the home screen, choose **Cell info display** and press **Select**.
- 1 To show or hide details in notifications, for example, a caller's contact details, choose **Notification details** and press **Select**.

Date and time settings

To set the date and time and change time settings:

1. Press **Menu**.
2. Choose **Settings** and press **Select**.
3. Choose **Date and time** and press **Select**.
4. Choose from the following options:
 - 1 To choose whether to automatically use the network date and time, choose **XXXXAuto updateXXXX** and press **Select**.
 - 1 To set the date or change the date format, choose **Date** and press **Select**.



Tip: To enter the date, use the number keys.

- 1 To set the time or change time settings, choose **Time** and press **Select**. You can choose to display an analog or digital clock on the home screen, and choose a 12 hour or 24 hour time format. You can also set the time zone you are currently in.



Tip: To enter the time, use the number keys.

- 1 To set your home time zone, choose **Home location** and press **Select**. Choose the time zone for where you live.

Language settings

To change the display language on your phone:

1. Press **Menu**.
2. Choose **Settings** and press **Select**.
3. Choose **Phone** and press **Select**.
4. Choose **Language settings** and press **Select** twice.
5. Choose a language and press **Select**.

Browser

Connect to the internet

Your phone uses the cellular mobile phone network (over the air) or a WLAN connection to access the internet.

Note: Check your data plan with your service provider. You may be charged to access the internet and to use mobile data.

To use mobile data to access the internet, see "Mobile data" on page 44.

To use a WLAN network for faster internet access, see "WLAN" on page 44.

Note: If you cannot connect to the internet, contact your service provider.

Browse the web

To connect to a public WLAN network, you may need to enter more information in the browser.

Note: Due to the size of your phone's screen, it may be difficult to view some websites.

To open the browser:

1. Press **Menu**.
2. Choose **Additions** and press **Select**.
3. Choose **Web** and press **Select**.
4. Choose **Home** and press **Select**.

To close the browser, press .

Note: Remember to close your browser when you have finished using it, otherwise you may be charged by your service provider.

Gallery

About the gallery

The gallery allows you to view images and video clips you have downloaded to your phone. You can also listen to your audio files directly from the gallery.

To add media files to your Signature, see "Transfer files between your phone and a computer" on page 46.

View images and video clips

To view images and video clips:

1. Press **Menu**.
2. Choose **Additions** and press **Select**.
3. Choose **Gallery** and press **Select**.
4. Choose the **Images** or **Video clips** folder and press **Select**.
5. Choose the file you want to view and press **Open**.

Listen to audio files

To listen to a voice recording or music file:

1. Press **Menu**.
2. Choose **Additions** and press **Select**.
3. Choose **Gallery** and press **Select**.
4. Choose the **Recordings** or **Music files** folder and press **Select**.
5. Choose the file you want to listen to and press **Open**.

Organise the gallery

To organise your media files, you can create folders in the gallery. You can choose to display files and folders in list or grid format. To make files and folders easier to find you can sort them by name, date, size or format.

To create a folder:

1. Press **Menu**.
2. Choose **Additions** and press **Select**.
3. Choose **Gallery** and press **Select**.
4. Press **Options**.

5. Choose **Add folder** and press **Select**.
6. Enter a folder name and press **OK**.

To delete a file or folder:

1. Press **Menu**.
2. Choose **Additions** and press **Select**.
3. Choose **Gallery** and press **Select**.
4. Choose the file or folder you want to delete and press **Select**.
5. Press **Options**.
6. Choose **Delete** or **Delete folder** and press **Select**.
7. Press **Yes** to delete the file or folder.

To change the layout of the gallery:

1. Press **Menu**.
2. Choose **Additions** and press **Select**.
3. Choose **Gallery** and press **Select**.
4. Press **Options**.
5. Choose **Type of view** and press **Select**.
6. Choose **List with details**, **List** or **Grid** and press **Select**.

To sort your files or folders:

1. Press **Menu**.
2. Choose **Additions** and press **Select**.
3. Choose **Gallery** and press **Select**.
4. Choose from the following options:
 - 1 To sort your folders, press **Options**.
 - 1 To sort files within a specific folder, choose the folder you require and press **Select**. Then press **Options**.
5. Choose **Sort** and press **Select**.
6. Choose how to sort the files or folders and press **Select**.

Office tools

Alarm clock

You can use your phone's alarm clock to set an alarm. The alarm sounds even when your phone is turned off.



Tip: To change the alarm volume, see "Ringtones and alerts" on page 35.

To set the alarm:

1. Press **Menu**.
2. Choose **Alarm clock** and press **Select**.
3. Use the number keys to enter the alarm time and press **OK**.

The  icon is displayed in the status and notification bar, to indicate that the alarm is set.

To cancel the set alarm:

1. Press **Menu**.
2. Choose **Alarm clock** and press **Select**.
3. Choose **Turn alarm off** and press **Select**.

To change the set alarm:

1. Press **Menu**.
2. Choose **Alarm clock** and press **Select**.
3. Choose **Change alarm time** and press **Select**.
4. Use the number keys to enter the alarm time and press **OK**.

To silence the alarm when it sounds:

- ▮ To stop the alarm, press **Stop**.
- ▮ To snooze the alarm, press **Snooze**. The  icon is displayed in the status and notification bar.

Calculator

You can use the calculator to perform basic calculations.

To use the calculator:



1. Press **Menu**.
2. Choose **Calculator** and press **Select**.

3. When the calculator opens, use the keypad to enter numbers and symbols:
 1. To enter numbers, use the number keys.
 1. To enter common symbols, use the navigation keys.
 1. To view a list of symbols, for example square root and percentage, press ***+**.
 1. To enter a decimal point, press **⇧#**.

Calendar

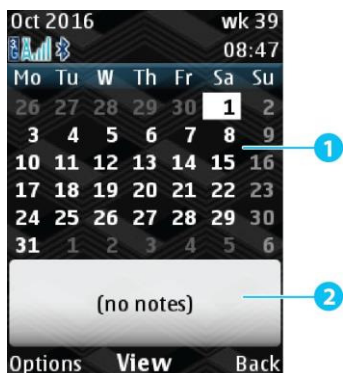
You can use your phone's calendar to keep track of events such as meetings, birthdays and anniversaries. You can also set reminders.



-  Calendar view
-  Events for the selected day

To view your calendar:

1. Press **Menu**.
2. Choose **Calendar** and press **Select**.
Your calendar opens on today's date.
3. To change how you view your calendar, press **Options**. Choose **Week view** or **Month view** and press **Select**.

To add an event to your calendar:

1. Choose a date and press **Options**.
2. Choose **Make a note** and press **Select**.
3. Choose a type of note, such as a reminder or anniversary, and press **Select**.
4. Enter the event details and press **Save**.

To-do lists

You can add tasks to a to-do list in your calendar.

To view your to-do list:

1. Press **Menu**.
2. Choose **Calendar** and press **Select**.
3. Press **Options**.
4. Choose **Go to to-do list** and press **Select**.
5. To add a new task to your to-do list, press **Options**. Then choose **Add** and press **Select**.

To add a task to your to-do list:

1. Press **Options**.
2. Choose **Add** and press **Select**.
3. Enter the task details and press **Save**. You can choose a priority, add a due date and time, and set an alarm.

Voice recorder

You can use the voice recorder to record memos. You can listen to recordings in the voice recorder or you can find them in the gallery.

To record a memo:

1. Press **Menu**.
2. Choose **Additions** and press **Select**.
3. Select **Voice recorder** and press **Select**.
4. To start the recording, press **Select**.
5. To stop the recording, press **Select**.

To play your most recent recording:

1. After you stop a recording, press **Options**.
2. Choose **Play last recorded** and press **Select**.

To play other recordings:

1. Press **Menu**.
2. Choose **Additions** and press **Select**.
3. Select **Voice recorder** and press **Options**.
4. Choose **Recordings list** and press **Select**.
5. Choose a recording and press **Open**.

Connectivity

Restrictions

 **Important:** There may be restrictions on the use of WLAN and Bluetooth technology in some countries. For more information, contact your local authorities.

WLAN

To reduce the amount of mobile data you use, you can connect to a nearby Wi-Fi network.

To connect to a new WLAN network:

1. Press **Menu**.
2. Choose **Settings** and press **Select**.
3. Choose **Connectivity** and press **Select**.
4. Choose **WLAN** and press **Select**.
5. Choose **Available WLANs** and press **Select**.

Your phone searches for nearby WLAN networks.

6. Choose a Wi-Fi network and press **Select**.
7. Use the number keys to enter the password for the WLAN network. If you need to enter more security information, contact the network administrator.
8. Press **OK**.



Tip: To connect to a public WLAN network, you may need to enter more information in your browser. See "Browse the web" on page 38.

Mobile data

When you are on the move and need to connect to the internet, you can use mobile data.

Note: Check your data plan with your service provider. You may be charged to access the internet and to use mobile data.

To turn mobile data on or off:

1. Press **Menu**.
2. Choose **Settings** and press **Select**.
3. Choose **Connectivity** and press **Select**.
4. Choose **XXXXMobile dataXXXX** and press **Select**.

5. Choose **XXXXMobile dataXXXX** and press **Select**.
6. Choose **On** or **Off** and press **Select**.

Bluetooth

You can use Bluetooth to make a wireless connection to other compatible devices, such as phones, computers, headsets, and car kits. You can then use Bluetooth to send and receive files on your phone.

To pair your phone with a Bluetooth device:

1. Press **Menu**.
2. Choose **Settings** and press **Select**.
3. Choose **Connectivity** and press **Select**.
4. Choose **Bluetooth** and press **Select**.
5. Choose **Paired devices** and press **Select**.
6. Choose **Add new device** and press **Select**.
Your phone searches for nearby devices.
7. Choose a device to connect to and press **Select**.
8. If required, enter a passkey to connect to the device. For details, see the user guide of the device.

The Signature has been equipped to support accessories with Qualcomm® aptX™ audio capabilities.



Tip: Switch Bluetooth off when not in use to conserve battery power.



Warning: Obey all local laws. Always keep your hands free to operate the vehicle while driving. Your first consideration while driving should be road safety.

You can change the name of your phone that is seen by other Bluetooth devices.

To change your phone's Bluetooth name:

1. Press **Menu**.
2. Choose **Settings** and press **Select**.
3. Choose **Connectivity** and press **Select**.
4. Choose **Bluetooth** and press **Select**.
5. Choose **My phone's name** and press **Select**.
6. Enter the new name for your phone and press **OK**.

Sync with a cloud account

You can set-up a cloud account on your phone. You can then sync contacts and calendar events between your phone and the cloud account.

To set up a cloud account on your phone:

1. Press **Menu**.
2. Choose **Vertu Services** and press **Select**.
3. Choose **XXXXVertu SyncXXXX** and press **Select**.
4. Choose **Add** and press **Select**.
5. Choose the cloud service that you have an account with and press **Select**.
6. Log into your account using your username and password.
7. Choose the content in your cloud account to sync to your phone.

Transfer files between your phone and a computer

Note: When you connect your phone to a computer for the first time, your computer may start to install drivers. To transfer files between your phone and the computer, complete the driver installation.

To transfer files between your phone and a computer:

1. Connect the microUSB cable from your phone's microUSB connector to a USB connection on your computer.
2. On your computer, go to the removable disk for your phone and open the internal storage folder.
3. Drag and drop files between your computer and the phone's folders.
4. When you have finished transferring files, safely disconnect your phone from the computer.
5. Disconnect the microUSB cable from your phone's microUSB connector.

Tethering and portable hotspot

When you tether your phone to a computer, the computer can share the phone's internet connection. To tether your phone to a computer, you can use a microUSB cable or a Bluetooth™ connection.

You can also turn your phone into a portable WLAN hotspot, which you can then connect your computer to.

To tether your phone or use it as a portable hotspot:

1. Press **Menu**.
2. Choose **Settings** and press **Select**.
3. Choose **Connectivity** and press **Select**.

4. Choose **XXXXHotspotXXXX** and press **Select**.

You can tum connections on and off and change portable hotspot settings.

Phone management

System update

You can update the software version on your phone using mobile data or a WLAN connection. You can manually update the software, or automatically update it when there is a new version available.

To change the software update settings:

1. Press **Menu**.
2. Choose **Settings** and press **Select**.
3. Choose **Phone** and press **Select**.
4. Choose **Phone updates** and press **Select**.
5. Choose **Automatic SW update** and press **Select**.
6. Choose **On** or **Off** and press **Select**.

To manually update your phone's software:

1. Press **Menu**.
2. Choose **Settings** and press **Select**.
3. Choose **Phone** and press **Select**.
4. Choose **Phone updates** and press **Select**.
5. Choose **XXXXUpdate softwareXXXX** and press **Select**.

Data roaming settings

Data roaming is accessing the internet using another mobile network while you are abroad. Data roaming can be expensive.

To change your data roaming settings:

1. Press **Menu**.
2. Choose **Settings** and press **Select**.
3. Choose **Connectivity** and press **Select**.
4. Choose **XXXXMobile dataXXXX** and press **Select**.
5. Choose **XXXXData roamingXXXX** and press **Select**.
6. Choose **On** or **Off** and press **Select**.

Note: You may incur significant charges if you use data roaming. Check the data roaming conditions with your service provider.

Set your phone to lock automatically

You can set your phone to lock automatically after it has not been used for a certain period of time.

To turn automatic locking on or off:

1. Press **Menu**.
2. Choose **Settings** and press **Select**.
3. Choose **Security** and press **Select**.
4. Choose **Automatic keyguard** and press **Select**.
5. Choose to turn automatic locking on or off.
 1. To turn automatic locking on, choose **On** and press **Select**. Enter the time to wait before your phone locks automatically and press **OK**.
 1. To turn on automatic locking off, choose **Off** and press **Select**.

Access codes

PIN and PIN2 code (4-8 digits)

The PIN code protects your SIM against unauthorised use or is required to access some features. The PIN2 code protects the advanced features of your SIM card, for example, fixed dialling lists. You can set your phone to ask for the PIN or PIN2 code when you switch it on. If you enter the code incorrectly three times in a row, you need to unblock the code with a PUK or PUK2 code. To change your PIN or PIN2 code, see "Use a PIN or PIN2 code" on page 50.

PUK or PUK2 code (8 digits)

The PUK or PUK2 codes are required to unblock a PIN or PIN2 code. For PUK or PUK2 details, contact your service provider.

IMEI number (15 digits)

The IMEI number is used to identify valid phones in the network. This number can also be used to block a stolen phone. You may be required to give this number to Vertu Customer Service.

To view your IMEI number:

1. Press **Menu**.
2. Choose **Settings** and press **Select**.
3. Choose **About** and press **Select**.

Security keyguard

A security keyguard helps you protect your phone against unauthorised use. You can choose a password made up of numbers and letters, or a PIN made up of numbers only. You can set your phone to ask for the

PIN or password that you define. Keep the PIN or password secret and in a safe place separate from your phone. If you enter the PIN or password five times in a row, your phone locks for five minutes. To change your security code, see "Use a security keyguard" on page 50.

Use a PIN or PIN2 code

Your phone can request the PIN or PIN2 code for your SIM card when you switch it on.

To turn the PIN or PIN2 code on or off:

1. Press **Menu**.
2. Choose **Settings** and press **Select**.
3. Choose **Security** and press **Select**.
4. Choose **XXXXSIM card lockXXXX** and press **Select**.
5. Choose **XXXXSIM PIN requestXXXX** or **XXXXSIM PIN2 requestXXXX** and press **Select**.
6. Choose **On** or **Off** and press **Select**.

To change the PIN or PIN2 code:

1. Press **Menu**.
2. Choose **Settings** and press **Select**.
3. Choose **Security** and press **Select**.
4. Choose **XXXXSIM card lockXXXX** and press **Select**.
5. Choose **XXXXChange SIM PINXXXX** or **XXXXChange SIM PIN2XXXX** and press **Select**.
6. Enter your current PIN or PIN2 code and press **OK**.
7. Enter your new PIN or PIN2 code and press **OK**.
8. Enter your new PIN or PIN2 code again and press **OK**.

Use a security keyguard

To turn the security keyguard for your phone on or off:

1. Press **Menu**.
2. Choose **Settings** and press **Select**.
3. Choose **Security** and press **Select**.
4. Choose **XXXXSecurity keyguardXXXX** and press **Select**.
5. If required, enter your security keyguard.

6. Choose one of the following options:

1. To turn the security keyguard on, choose **XXXXPINXXXX** or **XXXXPasswordXXXX** and press **Select**. Then enter a PIN or password to use as your security keyguard. You must enter at least 4 digits for a PIN or at least 4 characters for a password.
1. To turn the security keyguard off, choose **Off** and press **Select**.

Note: If you forget your security keyguard and your phone is locked, contact Vertu Customer Service to reset your phone. All of the personal data on your phone may be deleted.

Reset to workshop settings

You can reset your phone back to workshop settings. You can choose from the following options:

1. Restore settings on your phone to the workshop settings
1. Delete all personal content on your phone and restore settings to the workshop settings

 **Warning:** When you reset your phone to workshop settings, you cannot cancel or undo it. Before you continue, you may want to transfer files on your phone to a computer. For more information, see "Transfer files between your phone and a computer" on page 46.

To reset your phone to workshop settings:

1. Press **Menu**.
2. Choose **Settings** and press **Select**.
3. Choose **Workshop reset** and press **Select**.
4. Choose one of the following options:
 1. To restore the settings on your phone only, choose **Restore settings only** and press **Select**.
 1. To delete all content on your phone and restore your phone to workshop settings, choose **Restore all** and press **Select**.
5. Press **OK** to start the phone reset.

Boot validation

Each time your phone is booted, the phone software is tested for authenticity. Most of the time this is successful. However, two possible issues with authentication may occur. These are explained below.



Your device software has been unlocked for modification.



The authenticity of your device software cannot be verified.

If you receive either of these notifications and are unsure about what to do, contact Vertu Customer Service for assistance.

FAQs

Questions

How can I extend the battery life of my phone?	53
How can I reduce my data costs?	53
How do I transfer music or photos from my computer to my phone?	53
How do I transfer contacts to my phone?	54
How do I change the font size on my phone?	54
Why have I got no connectivity?	54
How do I protect my phone from unauthorised use?	54
How do I find the IMEI number of my phone?	54
Why does my phone get warm?	55

How can I extend the battery life of my phone?

You can extend the battery life of your phone by changing the following settings:

- 1 Turn off mobile data, WLAN or Bluetooth when not in use. To turn off a connection:
 1. Press **Menu**.
 2. Choose **Settings** and press **Select**.
 3. Choose **Connectivity** and press **Select**.
 4. Choose a connection type, such as mobile data, and press **Select**.
 5. Turn the connection off.
- 1 Reduce how often your phone checks for new emails in your mailbox. To change the sync setting for your emails:
 1. Press **Menu**
 2. Choose **Messages** and press **Select**.
 3. Choose **Message settings** and press **Select**.
 4. Choose **XXXXEmail messagesXXXX** and press **Select**.
 5. Choose an email account and press **Edit**.
 6. Choose **XXXXSync FrequencyXXXX** and press **Select**.
 7. Choose how often to sync your emails and press **Select**.

How can I reduce my data costs?

You can reduce the amount of data you use by doing the following:

- 1 Use WLAN networks to check your emails or access the internet, instead of mobile data. See "WLAN" on page 44.
- 1 Turn off data roaming when you travel abroad. See "Mobile data" on page 44.

How do I transfer music or photos from my computer to my phone?

When you connect your phone to your computer for the first time, your computer may prompt you that drivers are being installed. It is important that you install these drivers on your computer.

1. Connect the microUSB cable from your phone's microUSB connector to a USB connection on your computer.
2. On your computer, go to the removable disk for your phone and open the internal storage folder.
3. Drag and drop files between your computer and the phone's folders.
4. When you have finished transferring files, safely disconnect your phone from the computer.
5. Disconnect the microUSB cable from your phone's microUSB connector.

How do I transfer contacts to my phone?

You can use Vertu Sync to sync the contacts from a cloud account to your phone. To open Vertu Sync:

1. Press **Menu**.
2. Choose **Vertu Services** and press **Select**.
3. Choose **XXXXVertu SyncXXXX** and press **Select**.

You can also transfer contacts from your SIM card to your phone. See "Transfer contacts" on page 28.

How do I change the font size on my phone?

To change the font size in messages, your contacts list or the browser:

1. Press **Menu**.
2. Choose **Settings** and press **Select**.
3. Choose **Display** and press **Select**.
4. Choose **Font size** and press **Select**.
5. Choose an option and press **Select**.
6. Choose a font size and press **Select**.

Why have I got no connectivity?

If you lose network connection, check your network signal strength at the top of your screen. It is possible that you are in an area with poor network coverage. If this problem persists contact your service provider.

If you lose your WLAN connection, check the WLAN status indicator at the top of your screen for the connection strength. You may be out of range.



Tip: If you are using a domestic WLAN connection, the security information can often be found on your WLAN router.

How do I protect my phone from unauthorised use?

You can choose from a number of different lock options to protect your Signature. For example, you can use a PIN for your SIM or a security keyguard for your phone. See "Access codes" on page 49.

How do I find the IMEI number of my phone?

The IMEI number is used to identify valid phones in the network. This number can also be used to block a stolen phone. You may be required to give this number to Vertu Customer Service.

To see your IMEI number:

1. Press **Menu**.
2. Choose **Settings** and press **Select**.
3. Choose **About** and press **Select**.

Why does my phone get warm?

Your Signature may occasionally get warm when it is used for an extended period, being charged, or has been exposed to extreme heat. In these instances, power off your phone for a few minutes.

Accessories

Battery charger

The wall charger supplied with your phone should be suitable for your region. However, you should always check that the electrical rating of the AC outlet is appropriate for the charger before you attempt to plug it in.

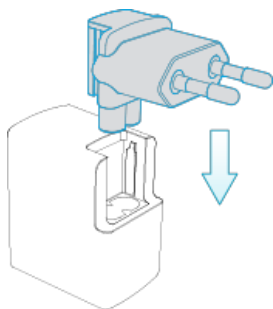

The battery for your Signature requires charging at regular intervals. The battery does not have to be completely discharged before you can charge it.

Other charging options

To charge the battery, you can also use the USB data cable to connect your phone to a compatible computer.

Data cable

The USB data cable enables you to transfer data between your Signature phone and a compatible computer.

Note: A microUSB cable, 1200 mm (CA-225DV), is supplied.

1. Make sure the cable is inserted correctly, with the USB symbol facing up.

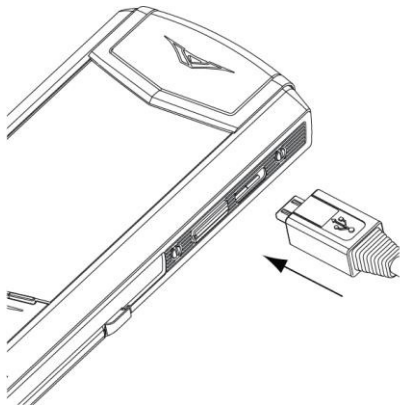

2. Connect the cable to a USB port of the computer.

The phone starts charging and you can transfer files between your phone and the computer. To transfer files, see "Transfer files between your phone and a computer" on page 46.

Specifications

Specifications

Dimensions

- 1 Length: 130 mm
- 1 Width: 42 mm
- 1 Depth: 13 mm
- 1 Weight: 166 g to 238 g (depending on phone variant)

Package contents¹

- 1 Signature phone
- 1 Wall charger (AC-32V) with regional plug heads
- 1 MicroUSB data cable 1200 mm (CA-225DV)
- 1 Spare battery
- 1 Polishing cloth
- 1 Collateral pack, including Quick Start Guide, Warranty and Authenticity Card

Operating system

- 1 Linux-based feature phone

Hardware characteristics

- 1 High resolution 2 inch QVGA portrait display
- 1 16 GB of internal memory
- 1 High-fidelity stereo 11 mm x 15 mm loudspeaker with dual sound ports

Battery¹

- 1 Removable Li-ion battery
- 1 Talk time:
 - 1 Up to XXX hours and XXX minutes (GSM)
 - 1 Up to XXX hours and XXX minutes (WCDMA)
- 1 Stand-by: Up to XXX hours

Connectivity

- 1 Quadband GSM 850/900/1800/1900 MHz
- 1 WCDMA¹ Bands I, II, V, VIII

- ▮ TD-SCDMA¹ Band 34 and 39
- ▮ CDMA2000¹ EV-DO BCO
- ▮ WLAN¹ 802.11 b/g/n 2.4 GHz, WAPI for PRC
- ▮ Micro USB system connector with USB On-The-Go support
- ▮ **B**luetooth™ v4.1
- ▮ CSR aptX® high quality encoded audio support

Applications

- ▮ Messages, Contacts, Call history, Settings, Additions, Calendar, Alarm clock, Calculator, Vertu Services

User interface display languages

- ▮ Arabic, Brazilian Portuguese, Danish, English (GB), English (US), Finnish, French, French Canadian, German, Hindi, Icelandic, Indonesian, Italian, Norwegian, Russian, Simplified Chinese, Spanish (ES), Spanish (US), Swedish, Traditional Chinese (HK), Traditional Chinese (Twn), Turkish, Ukrainian

¹ Features are location, network and/or service dependent.

Care of your phone

General care

If your Signature phone or any of the accessories are not working as they should, contact your Vertu dealer.

- 1 Always use your Signature in the documented manner. Incorrect usage may affect performance.
- 1 Do not attempt to open or disassemble your Signature phone. The only part you ever need to open is the SIM card tray and the battery cover. Your Signature phone should only be serviced by Vertu-authorized personnel.
- 1 Do not mishandle or abuse your Signature phone.
- 1 Use only Vertu-approved accessories.
- 1 The supplied charger is only intended for use with your Signature phone. Do not use them with any other device, as this could result in permanent damage to the phone, battery, or charger.
- 1 Keep your Signature phone and all parts and accessories out of the reach of small children and pets.
- 1 Do not allow your Signature phone or accessories to come into contact with liquids or moisture, or dust and dirt.
- 1 Do not expose your Signature phone to extreme temperatures as these may cause the battery to stop working temporarily. Performance is particularly limited in temperatures well below freezing.
- 1 Do not apply paint or other similar substances to your Signature phone.
- 1 Only use a soft, clean cloth to clean your Signature phone. Do not use chemicals, detergents, abrasive substances, or any liquids. Use a cotton swab to clean the camera lens.
- 1 Do not insert any sharp objects into any of the audio ports.

Embroidery

Vertu recommends that you avoid the following:

- 1 Direct exposure to strong light, heat and humidity
- 1 Contact with items and substances that may stain or scratch the surfaces

If your Signature phone gets wet, it is essential that you dry it as soon as possible with a soft, absorbent cloth.

Exotic leathers

Vertu recommends that you occasionally wipe the exotic leather in the direction of the scales with a slightly damp soft cloth, avoiding excessive pressure.

- 1 If your phone accidentally gets wet, it is essential that you dry it as soon as possible with a soft, absorbent cloth.

- 1 Direct exposure to strong light, heat and humidity should be avoided, as well as contact with items and substances that may stain or scratch the surfaces.
- 1 Vertu recommends that you store your handset in a pouch when not in use.

Leather

Each piece of leather used by Vertu's craftsmen is unique. The natural markings present in the hide should be considered part of the individuality of fine leather. All leather can be damaged and should be treated with care.

Avoid the following:

- 1 Exposure to water and high humidity
- 1 Dropping, rubbing or knocking on hard surfaces
- 1 Exposure to extreme temperatures
- 1 Contact with oily substances, make-up and solvents

Non-precious metals

Vertu metals are finished to a high standard and care needs to be taken to maintain their appearance.

Avoid the following:

- 1 Contact with chemicals such as solvents, alkaline and acid solutions, cola-based drinks and exposure to salt water. Wipe with a clean, soft cloth as soon as possible if contact occurs.
- 1 Contact with sharp objects
- 1 Dropping or knocking against hard surfaces
- 1 Metal polishes

Precious metals

Precious metals, such as gold and platinum, have a much softer composite and extra care must be taken when handling a Vertu product containing these materials.

Precious stones

Precious stones are extremely hard and durable, but can be damaged if handled inappropriately. For example, they can be broken, or their settings could be damaged by a sharp impact on a hard surface, causing the stone to become loose or fall out.

Care should also be taken to avoid contact with other jewellery such as diamond rings and diamond earrings as they can cause abrasion and chipping of the stone or the setting. Reasonable care should be taken to not catch the setting with threads that may bend the setting and loosen the stones.

We recommend that your Vertu phone is kept in a Vertu leather case when not being used, particularly when placed in handbags and other luggage.

If the stones appear to become dull from use, the product can be lightly polished using the Vertu microfibre polishing cloth.

Sapphire and ceramics

Sapphire and ceramics are very hard materials but are also brittle and can be scratched by harder materials or objects. They can also be damaged if dropped.

Avoid the following:

- 1 Contact with other hard materials such as diamond jewellery, nail files, abrasives and mineral crystals
- 1 Dropping or knocking the product on hard surfaces
- 1 Repeated rubbing against hard surfaces

Safety and warranty

Safety text

The sales package may contain several different products and parts (hereafter known collectively as the “Product”), for example a phone with various chargers. The following simple guidelines are intended to cover all products and parts. Not following the guidelines may result in risks to personal safety or data, damage to the Product, or in non-compliance with legal requirements.

Medical considerations

The operation of radio transmitting equipment, including wireless phones, may interfere with the function of inadequately protected medical devices. Consult a physician or the manufacturers of the medical devices to determine whether they are adequately shielded from external RF (Radio Frequency) energy.

Manufacturers of medical devices recommend a minimum separation of 15.3 centimetres (6 inches) between a wireless device and an implanted medical device, such as a pacemaker or implanted cardioverter defibrillator. Persons who have such devices should also:

- 1 Not carry the phone in a breast pocket.
- 1 **H**old the phone to the ear opposite the medical device.
- 1 Turn the phone off if there is any reason to suspect interference.
- 1 Follow the manufacturer’s instructions for the implanted medical device.

If you have any questions about using your wireless device with an implanted medical device, consult your health care provider.



To prevent possible hearing damage, do not listen at high volume levels for long periods. When you use the headset, your ability to hear outside sounds may be affected. Do not use the headset where it can endanger your safety. Listen to the headset at a moderate level, and do not hold the device near your ear when the loudspeaker is in use.

HAC Hearing Aid Compatibility (HAC) for digital handsets

FCC’s wireless hearing aid compatibility rules ensure that consumers with hearing loss are able to access wireless communications services through a wide selection of handsets without experiencing disabling radio frequency (RF) interference or other technical obstacles.

To define and measure the hearing aid compatibility of handsets, FCC references ANSI C63.19 2007 version and 2011 version; ANSI C63.19 standard specifies testing procedures for determining the M-rating and T-rating of the digital handsets.

A handset is considered hearing aid-compatible for acoustic coupling if it meets a rating of M3 or M4, under the ANSI C63.19. A handset is considered hearing aid-compatible for inductive coupling if it meets a rating

of T3 or T4, under ANSI C63.19. (Not all hearing-aids have telecoil inside.) This device was tested according to ANSI C63.19 2011 version, and this meets the M3 rating.

Consult your service provider or Vertu Customer Service for information on hearing aid compatibility. If you have questions about return or exchange policies, consult Vertu Customer Service.

Switch off the phone in restricted or dangerous areas

Switch the phone off when mobile phone use is not allowed or when it may cause interference or danger, for example near medical equipment, fuel, chemicals, or blasting areas.

Aeroplane profile when travelling

Unless specifically requested to turn the phone off, you can select the Aeroplane (offline) profile, which means that you cannot make or receive any calls, or use other features that require cellular network coverage, WLAN or Bluetooth. You can, however, still make emergency calls.

Use in vehicles

Radio signals may affect improperly installed or inadequately shielded electronic systems in motor vehicles such as electronic fuel injection, electronic anti-lock braking, electronic speed control, and air bag systems. For more information, check with the manufacturer of your vehicle or its equipment.

Only qualified personnel should install the phone in a vehicle. Faulty installation or service may be dangerous and may invalidate your warranty. Check regularly that all wireless device equipment in your vehicle is mounted and operating properly. Do not store or carry flammable liquids, gases, or explosive materials, in the same compartment as the phone, its parts, or accessories. Remember that air bags inflate with great force, so do not place your phone or accessories in the air bag deployment area.

Keep the product away from children

Keep your Product and all parts and accessories out of the reach of small children and pets. Failure to do this may endanger them and invalidate your Warranty.

Road safety comes first

Obey all local laws. Always keep your hands free to operate your vehicle while driving. Your first consideration should be road safety.

Qualified service

Only qualified personnel may install or repair the Product.

Batteries, chargers and other accessories

If the Product has an internal battery, this is intended to be rechargeable and non removable, being intended for use when supplied with power from the Vertu Mains charger (AC-32V), or from a suitable computer. Do not attempt to remove the battery, as you may damage it.

The full performance of a new battery is achieved only after two or three complete charge and discharge cycles. The battery in a device can be charged and discharged hundreds of times, but it will eventually wear

out. When you believe that the performance of the device has deteriorated (for example, when the talk and standby times on the phone are noticeably shorter than normal), replace the battery if it is removable, or, if it is non-removable, take the associated device to the nearest authorised service facility.

Use the battery only for its intended purpose.

Never use any charger or battery that is damaged.

Use only Vertu-approved batteries, and recharge your battery only with Vertu approved chargers designated for the device.

Use of an unapproved battery or charger may result in a risk of fire, explosion, leakage, or other hazard. Do not connect other, incompatible devices to the chargers.

When your charger is not in use, unplug it from the electrical plug and the device. Do not leave a fully charged battery connected to a charger, as overcharging may shorten the battery's lifetime.

Do not dismantle, cut, open, crush, bend, deform, puncture, or shred cells or batteries. In the event of a battery leak, do not allow the liquid to come in contact with the skin or eyes. In the event of such a leak, flush your skin or eyes immediately with water, or seek medical help.

Do not modify, remanufacture, attempt to insert foreign objects into the battery, or immerse or expose it to water or other liquids. Improper battery use may result in a fire, explosion, or other hazard. If the device or battery is dropped, especially on a hard surface, and you believe that the battery has been damaged, take it to the nearest service facility for inspection before continuing to use it. If the phone battery has not been used for a long time, then, in order to begin charging it again, you may need to connect the charger, and then disconnect and reconnect it. If the battery is completely discharged, it may take several minutes before the charging indicator appears on the display or before any calls can be made.

Keep your device dry

Your Product is not fully water-resistant, so keep it dry.

SIM card

IMEI number and compliance number

To find the IMEI number, dial the sequence *#06# into the phone. The unique 15-digit IMEI code of your phone is instantly displayed. Write it down and keep it in a safe place so that you can find it if your phone is misplaced or stolen. You can also find the IMEI number by checking the compliance label (refer to the phone's reference manual to locate this label).

WLAN

Use encryption to increase the security of your WLAN connection.

Protect your phone from harmful content

Your phone may be exposed to viruses and other harmful content. Take the following precautions:

- 1 Be cautious when opening messages. They may contain malicious software or otherwise be harmful to your phone or computer.
- 1 Be cautious when accepting connectivity requests, browsing the internet, or downloading content.

- 1 Do not accept Bluetooth connections from sources that you do not trust.
- 1 Only install and use services and software from sources that you trust and that offer adequate security and protection.
- 1 Install anti-virus and other security software on your phone and any connected computer. Only use one anti-virus application at a time (using more may affect the performance and operation of the phone and/or computer).
- 1 If you access pre-installed bookmarks and links to third party internet sites, take the appropriate precautions. Vertu does not endorse or assume liability for such sites.

Bluetooth hidden mode

Operating the phone when Bluetooth Visibility is set to Hidden is a safer way to avoid malicious software. Alternatively, switch off the Bluetooth function completely (this does not affect other functions on the phone).

Magnetic fields

Keep your phone away from magnets or magnetic fields.

Antennae

Avoid touching the antennae unnecessarily while they are transmitting or receiving. Contact with the antennae affects the communication quality and may cause a higher power level during operation and reduce battery life.

Backups

To keep your important data safe, store it in at least two separate places, such as on your phone and on your PC.

It is particularly important to carry out a backup prior to repair or replacement of the Product because content and data may be lost during these operations.

Digital rights management (DRM)

When using the phone, you are required to obey all laws and respect local customs, privacy and the legitimate rights of others, including copyrights. Copyright protection may prevent you from copying, modifying, or transferring images, music, and other content.

Additional care and maintenance

The Product in the sales package contains one or more sophisticated electronic devices. Vertu therefore strongly encourages you to familiarise yourself with the instructions provided with and for these devices.

To help protect your Warranty coverage, you should observe both the preceding "SAFETY TEXT" and the following:

- 1 Always use your Product in the documented manner.
- 1 Your Product contains a high precision display, so handle it with great care to avoid scratching or damaging it.
- 1 Do not attempt to remove any fixed internal battery or memory card.
- 1 Keep the Product free of dust and dirt.
- 1 Do not expose the Product to extreme temperatures, as these may cause the battery to stop working temporarily. Performance is particularly limited in temperatures well below freezing.
- 1 Do not mishandle or abuse the Product.
- 1 Do not paint the Product.
- 1 Only use a soft, clean cloth to clean your Product. Do not use chemicals, detergents, abrasive substances, or any liquids. Use a cotton swab to clean the phone's camera lens.

Specific phone care

- 1 Avoid scratching the phone screen. Never use a pen, pencil, or other sharp object, on it.
- 1 In order to protect the ceramics and sapphire, do not drop, knock, or rub your phone on or against hard surfaces. In particular, avoid contact with hard materials such as diamond jewellery, nail files, abrasives, and mineral crystals.
- 1 All leather can be damaged and should be treated with care. Therefore, in addition to the avoidance of extreme temperatures or water and high humidity, avoid contact with oily substances, make-up, and solvents.
- 1 Do not allow the metals on the phone to come into contact with sharp objects, metal polishes, and chemicals such as solvents, alkaline and acid solutions, cola-based drinks, and salt water. If contact occurs, wipe the surface with a clean, soft cloth as soon as possible.

Manufacturer's Limited Warranty

This Limited Warranty replaces all other Vertu warranties and liabilities, whether oral, written, (non-mandatory) statutory, contractual, in tort or otherwise, including, without limitation, and where permitted by applicable law, any implied conditions, warranties or other terms as to satisfactory quality or fitness for purpose. However, this Limited Warranty shall neither exclude nor limit: i) any of your legal (statutory) rights under the applicable national laws; or ii) any of your rights against the seller of the Product.

Vertu warrants to you, the Purchaser of the Product, that, during the warranty period, Vertu, or a Vertu-authorized service company, will, in a commercially reasonable time, remedy defects in materials, design and workmanship free of charge, by repairing or, should Vertu in its discretion deem it necessary, replacing the Product in accordance with this Limited Warranty (unless otherwise required by law).

Warranty periods

The Warranty starts at the time of the original purchase of the Product by the first end user. Different individual products and parts within the overall Product may be covered by different Warranty periods. The

different possible Warranty periods are:

- a. Twenty-four (24) months for the mobile phone and all technical accessories limited to: batteries, headsets, speakers, chargers, charger cables and data cables
- b. Twelve (12) months for all leather cases
- c. Twelve (12) months for all other products not listed above

As far as your national laws permit, the particular Warranty period will not be extended or renewed, or otherwise affected due to subsequent resale, Vertu-authorized repair, or replacement of the Product. However, any part repaired or product replaced during the Warranty period will be warranted from any defect for 12 months from the date of repair, or for the remainder of the original Warranty period, whichever is the longer.

How to get warranty service

If you wish to make a claim under this Limited Warranty, please return your Product, or the affected part (if it is not the entire Product), to a Vertu-authorized service company. For further details on how to make a claim, you can contact a Vertu call centre (national or premium rates may apply). (Information about Vertu-authorized service companies and call centres can be found in the sales package, or on local Vertu web pages, where available.)

Any claim under this Limited Warranty is subject to you notifying Vertu, or a Vertu authorized service company, of the alleged defect within a reasonable time of it having come to your attention, and in any event no later than the expiry date of the Warranty period.

When making a claim under this Limited Warranty, you will be required to provide: a) the affected Product (or the affected part); and b) the original proof of purchase, clearly indicating the name and address of the seller, the date and place of purchase, the Product type, and the IMEI or other serial number.

What is not covered?

1. This Limited Warranty does not cover user manuals or any third party software, settings, content, data or links, whether included or downloaded in the Product, whether included during installation, assembly, shipping or at any other time in the delivery chain or otherwise and in any way acquired by you. By using such a third party application, you acknowledge that the application is provided as is. Vertu does not warrant that any Vertu software will work in combination with any hardware or software provided by a third party, that the operation of any software will be uninterrupted or error-free, or that any defects in the software are correctable or will be corrected.
2. A third party/independent operator provides the SIM card and cellular and/or other network or system on which the Product operates. Therefore, Vertu will not accept responsibility under this Limited Warranty for the operation, availability, coverage, services or range of the cellular or other network or system. Before Vertu or a Vertu-authorized service company can repair or replace the Product, the operator may need to unlock any SIM-lock or other lock that may have been added to lock the Product to a specific network or operator. In such situations, please first ask the operator to unlock your Product.

3. This Limited Warranty does not cover: a) normal wear and tear (including, without limitation, wear and tear of camera lenses, batteries or displays); b) defects caused by rough handling (including, without limitation, defects caused by sharp items, by bending, compressing or dropping, etc.); c) defects or damage caused by misuse of the Product, including use that is contrary to the instructions provided by Vertu (for example, as set out in the Product's user guide), and/or d) other acts beyond the reasonable control of Vertu.
4. This Limited Warranty does not cover defects or alleged defects caused by the fact that the Product was used with, or connected to, any product, accessory, software and/or service not manufactured, or supplied by Vertu, or was used other than for its intended purpose. Defects can be caused by viruses from your, or from a third party's, unauthorised access to services, other accounts, computer systems or networks. Such unauthorised access can take place through hacking, password mining or through a variety of other means.
5. This Limited Warranty does not cover defects caused by the fact that the battery has been short-circuited, or by the fact that the seals of the battery enclosure or the cells are broken or show evidence of tampering, or by the fact that the battery has been used in equipment other than that for which it has been specified. This Limited Warranty is not enforceable if the Product has been opened, modified or repaired by anyone other than an authorised service centre, if it is repaired using unauthorised spare parts, or if the Product's serial number, the mobile accessory date code, or the IMEI number, has been removed, erased, defaced, altered or are illegible in any way. This shall be determined by the sole discretion of Vertu.
6. This Limited Warranty is not enforceable if the Product has been exposed to moisture, to extreme thermal or environmental conditions (or to rapid changes in such conditions), to corrosion, oxidation, spillage of food or liquid, or to influence from chemical products.

Limitations of Vertu's liability

This Limited Warranty is your sole and exclusive recourse against Vertu, and the only and exclusive liability of Vertu in respect of defects in your Product.

To the extent permitted by applicable law(s), Vertu does not assume any liability for loss of or damage to or corruption of data, for any loss of profit, loss of use or functionality of the Product, loss of business, loss of contracts, loss of revenues or of anticipated savings, increased costs or expenses or for any indirect loss or damage, consequential loss or damage, or special loss or damage. To the extent permitted by applicable law(s), Vertu's liability shall be limited to the purchase value of the Product. The above limitations shall not apply in cases of gross negligence or intentional misconduct of Vertu, or in case of death or personal injury resulting from Vertu's proven negligence.

Other important warranty notices

The availability of products, features, applications, and services may vary by region. For more information, contact your nearest Vertu-branded store or Vertu-authorized service company.

All wireless devices may be susceptible to interference, which could affect performance.

Vertu is not responsible for any radio or TV interference caused by unauthorised modifications to this equipment. Such modifications could void your authority to operate the equipment.

Reverse engineering of software in the Product is prohibited to the extent permitted by applicable law. Insofar as this document contains any limitations on Vertu's representations, warranties, damages and liabilities, such limitations shall likewise limit any representations, warranties, damages and liabilities of Vertu's licensors.

Vertu, in a manner consistent with the provisions of section "Limitations of Vertu's liability" above, shall not under any circumstances be liable, either expressly or by implication, for any damages or losses of any kind whatsoever resulting from loss of, damage to, or corruption of, content or data during repair or replacement of the Product.

All parts of the Product or other equipment that Vertu has replaced shall become the property of Vertu. If the Product is found not to be covered by the terms and conditions of this Limited Warranty, Vertu and its authorised service companies reserve the right to charge a handling fee.

When repairing or replacing the Product, Vertu may use products or parts that are new, equivalent to new, or reconditioned. The Product may contain country-specific elements, including software. If the Product has been re-exported from its original destination country to another country, the Product may contain some country-specific elements that are not considered to be a defect under this Limited Warranty.

Software application notices for the phone

Your Vertu phone can connect to the internet via a data connection. Contact your network service provider for information on the availability of data connectivity when in your home network and when roaming onto other networks.

Before installing updates on the phone, ensure that the phone can connect to the internet, and that the phone battery has enough power (or connect the charger before starting the update).

If you install a software update, you cannot use the phone, even to make emergency calls, until the installation has been completed and the device restarted.

Service or software upgrades may reset timers on the phone.

The existence of a certificate considerably reduces the risks involved in remote connections and software installation. To benefit from increased security, certificates must be used correctly, and they must be authentic or trusted. Certificates have a restricted lifetime. If they are expired or invalid, check that the current date and time in your device are correct. Before changing any certificate settings, you must trust the owner of the certificate and be sure that the certificate belongs to the listed owner.

Network support is required to indicate that a sent message has been received or read. However, this information may not always be reliable.

Only compatible devices can receive and display multimedia messages.

If the item you inserted in a multimedia message is too large for the network, the phone may automatically reduce the size.

Messages may look different on different devices.

If your phone is able to provide over-the-air synchronisation with Microsoft Exchange ActiveSync-enabled servers, the provision of this service does not grant you, and nor do you receive, any rights under any Microsoft intellectual property with respect to any server software, or server device, that is accessed using the phone, or with respect to the use of Microsoft Exchange ActiveSync outside of the phone.

A cache is a memory location that is used to store data temporarily on the phone. If you have accessed, or have tried to access, confidential information or a secure service requiring passwords, clear the cache after each use.

DRM-protected content comes with an associated license that defines your rights to use the content. Some licenses may be connected to a specific SIM card, and the protected content can be accessed only if the SIM card is inserted in the phone.

The OS of the phone must be upgraded through official channels. Any OS modification using 3rd party SW, hacker SW or unofficial SW will lead to system problems or security risks. In these cases, Vertu will not provide support.

WLAN and Bluetooth restrictions

There may be restrictions on the use of WLANs and Bluetooth technology in some countries. For more information, contact your local authorities.

Passive near field communication device

Your phone may contain a Passive Near Field Communication device. This device enables Vertu to verify the authenticity of the phone if it is presented at a Vertu-branded store or Vertu-authorized service company.

Environmental

ROHS Statement

This Product does not contain any of the following substances, in accordance with EU RoHS (Reduction of Hazardous Substances) Directive 2011/65/EU:

- 1 Lead
- 1 Hexavalent Chromium
- 1 Mercury
- 1 Polybrominated Biphenyls (PBB)
- 1 Cadmium
- 1 Polybrominated Diphenyl Ethers (PBDE)

Nickel

The surfaces of Vertu devices do not contain nickel in the platings. Depending on the model and variant of the device, surfaces may contain stainless steel or other alloys.

EU recycling notice



Vertu complies with European Community requirements for the recycling of Waste Electrical & Electronic Equipment (WEEE). Such compliance is indicated by the addition of the crossed-out wheeled-bin symbol to the Product where appropriate. This symbol indicates that the Product was put onto the market after the WEEE legislation was implemented, and that the consumer should not dispose of the Product as normal household waste or unsorted municipal waste, but that it should be appropriately recycled. Background information on the European WEEE directive is available from http://ec.europa.eu/environment/waste/weee/index_en.htm.

If you want Vertu to recycle your Product at the end of its life, please either return it to the point from which you purchased it (if known), or return it to Vertu's headquarters. Alternatively, should you purchase a replacement Product from another supplier, the new supplier is obliged to take back the original Product and recycle it appropriately.

Never dispose of your phone's battery in a fire, because it may explode.

Export and controls

The Product may contain commodities, technology or software subject to export laws and regulations from the US and other countries. Diversion contrary to law is prohibited.

Copyright and trademark notices

Copyright © Vertu 2011-2016. All rights reserved.

Vertu and the V logo are registered trademarks. Other product and company names mentioned herein may be trademarks or registered trademarks of their respective owners.

Vertu operates a policy of continuous development. Therefore, Vertu reserves the right to make changes and improvements to any of the products described in this document without prior notice.

This Product is licensed under the MPEG-4 Visual Patent Portfolio License (i) for personal and non-commercial use in connection with information that has been encoded in compliance with the MPEG-4 Visual Standard by a consumer engaged in a personal and non-commercial activity; and (ii) for use in connection with MPEG-4 video provided by a licensed video provider. No license is granted or shall be implied for any other use.

Additional information, including that related to promotional, internal, and commercial uses, may be obtained from MPEG LA, LLC. See <http://www.mpegla.com>.

Manufactured under license from Dolby Laboratories. Dolby, Dolby Audio, and the double-D symbol are trademarks of Dolby Laboratories.



Qualcomm aptX is a product of Qualcomm Technologies International, Ltd.

Qualcomm is a trademark of Qualcomm Incorporated, registered in the United States and other countries, used with permission. aptX is a trademark of Qualcomm Technologies International, Ltd., registered in the United States and other countries, used with permission.

The Bluetooth word mark and logos are owned by the Bluetooth SIG, Inc. and any use of such marks by Vertu is under license.

The availability of particular products, features, applications, and services may vary by region. For more information, contact your nearest Vertu retail store.

SAR (Specific Absorption Rate) notice - Type: VM-06

YOUR VERTU PHONE (MODEL: SIGNATURE S, TYPE: VM-06, FCC ID: P7QVM-06) MEETS GUIDELINES FOR EXPOSURE TO RADIO WAVES

Your phone is a radio transmitter and receiver. It is designed to not exceed the limits for exposure to radio waves recommended by international guidelines. These guidelines were developed by the independent scientific organization ICNIRP, and include safety margins designed to assure the protection of all persons, regardless of age and health.

The exposure guidelines for mobile devices employ a unit of measurement known as the Specific Absorption Rate, or SAR. The SAR limit stated in the ICNIRP guidelines is 2.0 Watts/kilogram (W/kg), averaged over ten grams of tissue. Tests for SAR are conducted using standard operating positions, with the device transmitting at its highest certified power level in all tested frequency bands. The actual SAR level of an operating device can be below the maximum value because the device is designed to use only the power required to reach the network. That amount changes depending on a number of factors, such as how close you are to a network base station. The highest SAR value under the ICNIRP guidelines for use of the device at the ear is 0.628 W/kg. This phone meets RF exposure guidelines when used either in the normal use position against the ear or when positioned at least 5 mm (3/16 inch) away from the body. When a carry case, belt clip or holder is used for body-worn operation, it should not contain metal, and should position the phone at the above-stated distance away from your body.

In order to transmit data files or messages, this device requires a good quality connection to the network. In some cases, transmission of data files or messages may be delayed until such a connection is available. Ensure that the above separation distance instructions are followed until the transmission is completed.

Use of phone accessories and enhancements may result in different SAR values. SAR values may vary depending on national reporting and testing requirements and the network band. Additional SAR information may be provided under Product information at www.vertu.com.

USA and Canada

Your phone is also designed to meet the requirements for exposure to radio waves established by the Federal Communications Commission (USA) and Innovation, Science and Economic Development Canada. These requirements set a SAR limit of 1.6 W/kg, averaged over one gram of tissue. The FCC/IC highest SAR values reported under this standard during Product certification for use at the head is 1.09 W/kg, and when properly worn on the body (10 mm, 3/8 inch gap) is 1.19 W/kg.

Carry this device at least 10 mm away from your body to ensure RF exposure level compliant or lower to the reported level. To support body-worn operation, choose the belt clips or holsters, which do not contain metallic components, to maintain a separation of 10 mm between this device and your body.

Your phone may cause TV or radio interference (for example, when using the phone in close proximity to receiving equipment). The FCC or Industry Canada can require you to stop using your phone if such interference cannot be eliminated. If you require assistance, contact Vertu Customer Service. The Product, or Products, comply with Part 15 of the FCC rules.



Operation is subject to the following two conditions: (i) the Product(s) may not cause harmful interference, and (ii) the Product(s) must accept any interference received, including interference that may cause undesired operation. Any changes or modifications not expressly approved by Vertu could void the user's authority to operate this equipment.

This equipment has been tested and found to comply with the limits for a Class B digital device, pursuant to part 15 of the FCC Rules. These limits are designed to provide reasonable protection against harmful interference in a residential installation. This equipment generates, uses and can radiate radio frequency energy and, if not installed and used in accordance with the instructions, may cause harmful interference to radio communications. However, there is no guarantee that interference will not occur in a particular installation. If this equipment does cause harmful interference to radio or television reception, which can be determined by turning the equipment off and on, the user is encouraged to try to correct the interference by one or more of the following measures:

- Reorient or relocate the receiving antenna.
- Increase the separation between the equipment and receiver.
- Connect the equipment into an outlet on a circuit different from that to which the receiver is connected.
- Consult the dealer or an experienced radio/TV technician for help

This Class B digital apparatus complies with Canada ICES-3(B)/NMB-3(B).

The device could automatically discontinue transmission in case of absence of information to transmit or of operational failure. Note that this is not intended to prohibit the transmission of control or signalling information or the use of repetitive codes where required by the technology.

ISED Canada Notice

RSS-Gen 8.4

This device complies with Innovation, Science and Economic Development Canada license-exempt RSS standard(s). Operation is subject to the following two conditions:

- (1) this device may not cause interference, and
- (2) this device must accept any interference, including interference that may cause undesired operation of the device.

IC: 4299A-VM06

ISED Canada Radiation Exposure Statement

This EUT is compliance with SAR for general population/uncontrolled exposure limits in RSS-102 and had been tested in accordance with the measurement methods and procedures specified in IEEE 1528 and IEC 62209. This equipment should be installed and operated with minimum distance 1.0 cm between the radiator and your body. This device and its antenna(s) must not be co-located or operating in conjunction with any other antenna or transmitter.

Declaration of Conformity

Model: SIGNATURE S

Type: VM-06

We hereby declare the above named product is in conformity with the essential requirements of Directive 2014/53/EU. A copy of the Declaration of Conformity can be found at <http://www.vertu.com>.

The above named product operates in the Frequency Bands with maximum Powers as shown below:

- ┆ GSM 850, GSM 900: 2 Watts
- ┆ GSM 1800, GSM 1900: 1 Watt
- ┆ WCDMA Bands I,II,V,VIII: 250 mW
- ┆ TD-SCDMA Bands 34,39: 250 mW
- ┆ CDMA2000: 250 mW
- ┆ WLAN 802.11 (2.4G) b,g,n: 100 mW
- ┆ BT (2.4G) 100mW

Vertu Corporation Limited, Beacon Hill Road, Church Crookham, Hampshire GU52 8DY.