

**i315**

**User Manual**

# Welcome!

PLEASE READ THIS INFORMATION BEFORE USING THE PHONE TO MAKE A BETTER USE OF YOUR PHONE. WE ARE NOT RESPONSIBLE FOR ANY DAMAGE DUE TO YOUR MISUNDERSTANDING OF THIS INFORMATION AND MISUSE.

The content of this manual is correct at the time of issuance, however Verykool USA, Inc. reserves the right to amend technology specifications without any prior notification.

Some descriptions in this manual may differ to some extent from the actual mobile phone, depending on differences in software and/or network providers.

## Introduction:



**Note:** All the illustrations, simulated screen and related images used in this manual are for reference only. Please refer to your handset for actuality.

# Contents

1. Safety Information .....	6
2. Essential .....	9
2.1 Install the SIM card .....	9
2.2 Battery Use and Installation .....	10
2.3 Memory Card .....	11
2.4 Power on/off .....	11
2.5 Make a call .....	11
2.6 Answer or Reject a call .....	11
2.7 Operation during a call .....	12
2.8 Insert international access code .....	12
2.9 Dial a extension or voicemail number .....	12
2.10 Emergency calls .....	13
3. Basic .....	13
3.1 Display .....	13
3.2 Password .....	15
4. Functions .....	16
5. Message .....	18
5.1 Writing Messages .....	18
5.2 Inbox .....	18
5.3 Drafts .....	19
5.4 Outbox .....	19
5.5 MMS .....	20
5.6 Broadcast message .....	22
5.7 Templates .....	22
5.8 SMS settings .....	23
6. Phonebook .....	23
7. Call Center .....	24
7.1 Call history .....	24
7.2 Call Settings .....	26
8. Settings .....	26
8.1 Phone Settings .....	27
8.2 Network Settings .....	27
8.3 Security Settings .....	27
8.4 Connectivity .....	28
8.5 Restore Factory Settings .....	29
8.6 Sound effects .....	29
9. Multimedia .....	29
9.1 Camera .....	29
9.2 Image viewer .....	30
9.3 Video recorder .....	30
9.4 Video Player .....	31
9.5 Audio Player .....	31
9.6 FM Radio .....	31
9.7 Sound Recorder .....	32
9.8 File manager .....	33
10. Organizer .....	35
10.1 Torch .....	35
10.2 Calendar .....	35
10.3 Tasks .....	35
10.4 Alarm .....	36
10.5 Calculator .....	36
10.6 Stopwatch .....	36

11. Fun & Games.....	37
11.1 Games.....	37
12. User Profiles.....	38
13. Services.....	39
13.1 WAP.....	39
14. Input Method.....	41
14.1 Text Input Method.....	41
14.2 Numeric Input Method.....	42
Trouble Shooting.....	43
Specific Absorption Rate Data.....	44

## 1. Safety Information

---

### Batteries

Never use a charger or battery that is damaged in any way.

Properly use the battery. Do not short-circuit the battery, which may damage the battery, cause heat or cause fire.

Do not dispose of batteries in high temperature or in a fire as they may explode.

Return the waste battery to the dealer or designated recycling center. Do not dispose as household waste.

Battery charging time depends on the remaining battery charge, the type of battery and the charger used. The battery can be charged and discharged hundreds of times, but it will gradually wear out. When your phone's operating time is noticeably shorter than normal, it is time to buy a new battery.

Use only original or approved chargers and batteries.

Unplug the charger from the electrical plug and the device when not in use.

Do not overcharge, which will damage the battery and shorten its life.

Leaving the battery in extremely hot or cold places will reduce the capacity of the battery. Cool down or heat up the temperature to normal level (Li-ion batteries are particularly affected by temperatures below 0°C (32°F)).

### Road safety

Your wireless phone gives you the powerful ability to communicate by voice, almost anywhere, anytime. Therefore, you must uphold some important responsibility.

When you are driving, driving is your first responsibility. When using your wireless phone while driving, be more alert and follow local regulations.

Understand the wireless phone and features, such as speed dial and redial which can help you make a call more conveniently without disturbing your driving.

Use a hands-free set if possible. Hands-free accessories may promote the convenience and safety of using your wireless phone.

Place your phone where is easy to access and does not require you to move your eyesight. If receiving a call at an inconvenient moment, let your voicemail answer for you.

When on the phone, tell your conversation partner that you are driving. Hang up in traffic jams or bad weather. Rain, rain with snow, snow, ice and traffic may be dangerous.

Air bags, brakes, speed control systems and fuel injection should not be influenced by radio transmission. If you have these problems, contact your car dealer immediately.

Switch off your mobile phone when fueling or anywhere two-way radio equipment usage is prohibited. Do not put your phone near flammable and explosive substances. Internal spark may cause fire or explosion.

Switch off the mobile phone prior to airplane take-off. To prevent interference to communication systems in the plane, never use a phone during flight. Using a phone before the plane takes off may be allowed by the crew in accordance with safety regulations.

During flight, make sure that your phone will not be automatically switched on by an alarm you have set.

#### Operating environment

Remember to follow any special regulations in force in your area and always switch off your phone whenever it is forbidden to use it, or it may cause danger.

When connecting the phone or any accessory to another device, read its user's guide for detailed safety instructions. Do not connect incompatible products.

It is recommended that the equipment only be used in the normal operating position (held to your ear with the antenna pointing over your shoulder) for your satisfactory operation of the equipment and for the safety of personnel.

Do not expose the equipment to temperature below  $-10^{\circ}\text{C}$  ( $14^{\circ}\text{F}$ ) or above  $50^{\circ}\text{C}$  ( $122^{\circ}\text{F}$ ).

#### Electronic devices

Most electronic equipment is shielded from radio frequency signals. Consult the manufacturer for relevant information.

**Pacemakers:** Maintain a minimum distance of 6 inches (15cm) between a wireless phone and a pacemaker; do not put your phone in a pocket near the chest; use your ear furthest from the pacemaker to reduce possible interference. If you have any reason to suspect that interference is taking place, switch off your phone immediately.

**Hearing aids:** Some digital wireless phones may interfere with some hearing aids. In the event of such interference, you may consult your hearing aid manufacturer.

**Other medical devices:** If you use any other personal medical devices, consult the manufacturer of your device to determine if it is adequately shielded from external RF energy. Your physician may be able to assist you in obtaining this information. Switch off your phone in health care facilities when regulations posted in these areas instruct you to do so.

**Vehicles:** RF signals may affect improperly installed or inadequately shielded electronic systems in motor vehicles. Check with the manufacturer.

#### Emergency calls

This phone, like any wireless phone, operates using radio signals, which cannot guarantee connection in all conditions. Therefore, you should never rely solely on any wireless phone for essential communications like medical emergencies.

To make or receive calls, the phone must be switched on and in a service area with adequate

signal strength.

To make an emergency call, enter the local emergency number in standby mode and press Snd to call.

Other important safety information

- Use original or approved accessories. Any unapproved accessory may affect the performance of your phone, damage your phone or even cause personnel injury.
- Your wireless phone sends out an electromagnetic field. Do not put the phone near magnetic storage media such as computer disks. Neighboring electric appliances such as TVs, phones, radio receivers and PCs may affect the use of your phone and its performance.
- Do not connect the phone to an incompatible device.
- Only qualified personnel should service the phone or install the phone in a vehicle.

Care and maintenance

Your phone is a product of superior design and craftsmanship and should be treated with care. The suggestions below will allow you to enjoy this product for many years.

- Keep your phone out of the hands of small children and pets. They may accidentally damage the phone or choke on small parts.
- Keep the phone dry and avoid liquids that corrode the phone.
- Do not use the phone with a wet hand, which may cause an electric shock.
- Do not store the phone in hot areas, which can shorten the life of electronic devices, damage batteries or melt accessories.
- Do not store the phone in cold areas. When the phone warms up to its normal operating temperature, moisture can form inside the phone, which may damage the phone's electronic circuit boards.
- Do not expose your phone to hot sun which may overheat your phone.
- Do not place your phone near flammable liquids, gases or explosive substances.
- Do not drop or knock the phone. Rough handling can break internal circuit boards.
- When cleaning your phone, use a slightly damp or anti-static cloth. Do not use a dry or static cloth. Do not use chemicals such as cleaning solvents to clean the surface. Switch off the phone first and then do the cleaning.
- Do not paint the phone. Paint can prevent proper operation.
- If your phone has a flash, do not use it too close to the eyes. This may cause damage to eyes.
- If the phone or battery gets wet and the label in the phone is damaged, phone repairs are no longer guaranteed by the manufacturer's warranty, even if the warranty for your phone has not expired.

Improper use will invalidate the warranty! These safety instructions also apply to original accessories.



## 2. Essential

### 2.1 Install the SIM card

Keep your SIM cards away from the children.

Please consult your SIM card franchiser about the services and usage. SIM franchiser can be the service provider, network provider or other franchisers.

Please turn off your mobile device and disconnect it with charger before removing the battery.

**Note:** turn off your mobile device and disconnect it with charger or any other device before removing the battery door. Place the door on the phone before using your mobile phone.

1, Remove the battery door:

Press and slide the battery door to the top of the phone, then take the battery door off.

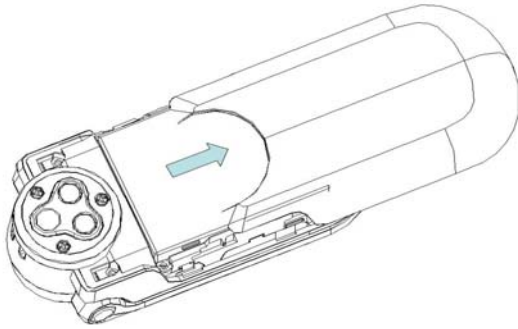

2, Insert the SIM card into the card slot:

Now you can see two card slots side by side, please insert the SIM cards with the right direction as shown.



## 2.2 Battery Use and Installation

### Battery tips

Battery life depends on the network, signal strength, temperature, and accessories you use. Always use Original batteries and chargers. The warranty does not cover damage caused by non-original batteries, charger and/or accessories.

New batteries or batteries stored for a long time may take more time to charge

When charging your battery, keep it near room temperature.

When storing your battery, keep it uncharged in a cool, dark, dry place.

Never expose batteries to temperatures below  $-10^{\circ}\text{C}$  ( $14^{\circ}\text{F}$ ) or above  $45^{\circ}\text{C}$  ( $113^{\circ}\text{F}$ ).

Always take your phone with you when you leave your vehicle.

It is normal for batteries to gradually wear down and require longer charging times. If you notice a change in your battery life, it is probably time to purchase a new battery.

Never dispose of batteries in a fire because they may explode.

### Battery installation

- 1, Slide the battery door up and then remove the door.

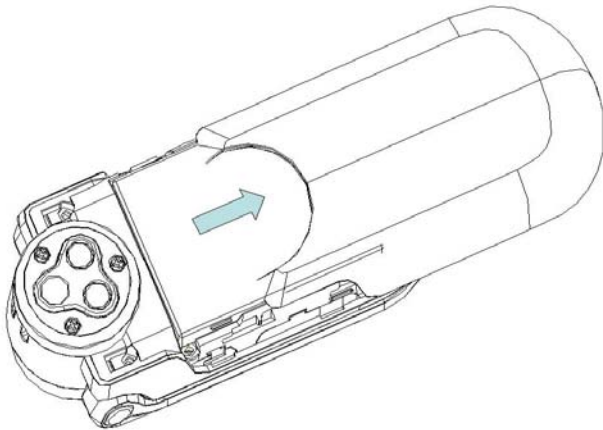

- 2, Aim the metal terminals of the battery at those in the battery compartment and then push down and into it.

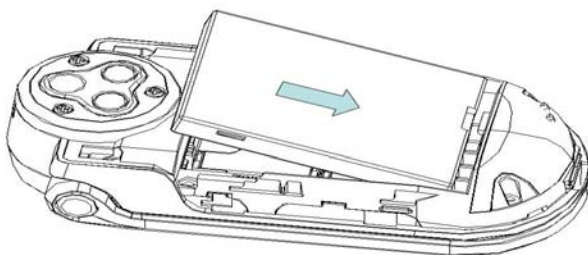

**Battery charging:**

New batteries are not fully charged. Open the protective cover on your phone's accessory connector port, then insert the battery charger plug into the accessory connector port on the side of your phone as shown, and plug the other end into an electrical outlet. Your phone might require several hours to charge fully. When your phone is power off, it might take a few seconds to show charging display and it shows charge complete when finished. When your phone is power on, the battery icon flickers when it starting charging and become still with full bars in battery icon when finished.

**2.3 Memory Card**

The memory card is built-in the phone and non-removable & unexposed, You can save music and other files.

**2.4 Power on/off**

**Caution:** On power up, the phone may prompt you to enter your SIM card PIN code to unlock the SIM card. If your phone shows Input PUK code meaning your SIM card is locked, please contact your service provider.

To turn on your phone, press and hold the power on/off key for two seconds. If prompted, enter your four-to-eight-digit SIM card PIN code and/or four-digit unlock code.

If you don't insert a SIM card, your phone shows **Insert SIM**. None of the functions related to SIM card can be used and you can make an emergency call only.

To turn off your phone, press and hold the power on/off key for two seconds.

**2.5 Make a call**

1. Input the telephone number directly.
2. Press the send key to dial calls.
3. After calling, press the power on/off key or end key to end.

**2.6 Answer or Reject a call**

When there is an incoming call, the phone rings and /or vibrates showing the number or the corresponding name.

Now the phone provide three mode,

**Not any key(set in profiles):** Press **answer key** or enter **option** and then select **answer** to

receive a call. If you don't want to answer, you can press the power on/off key or right soft key.

**Any key:** Except power on/off key and right soft key, press any key to answer a call.

**Earphone/Bluetooth mode:** when plugging the earphone (including bluetooth headsets), you can answer a call by pressing the key on the earphone; when you are not convenient to press the key, you can turn on the auto-answer mode (only in earphone mode) and make sure the earphone is plugged, your phone auto-answers a call 5 seconds after it rings and/or vibrates.

## 2.7 Operation during a call

Press **Option** to perform following operation during a call:

<b>Hold Single:</b>	Hold this call
<b>End Single:</b>	Hang up and end this call
<b>New Call*:</b>	Enter a new dialing display to make a new call
<b>PhoneBook:</b>	Enter the phone book
<b>Messages:</b>	Enter messages
<b>Mute:</b>	Set mute on or off. When setting mute on, your voice can not be heard through the line.
<b>Swap*:</b>	Switch between the current call and the holding call
<b>Conference*:</b>	You can add additional parties to a call.

**Note:** the menus marked with \* must be supported by your SIM card. For details, please contact your service provider. Only when two or more calls are on can **Swap** and **Conference** show.

## 2.8 Insert international access code

When you are dialing an international call, keep press \* **key** till the international call prefix “+” shows and then enter the number in the following order:

+ Country code    complete number    send key

## 2.9 Dial a extension or voicemail number

You need to enter P (pause) or W (wait) when dialing an extension number, keep press \* **key** to switch between ‘P’ and ‘W’. You can enter numbers as following:

District code    exchange phone number    P or W    extension number    send key

## 2.10 Emergency calls

You can make emergency calls as long as your current location is network-covered which you can know by checking the signal strength bar showing on the top left corner of the screen.

**Note:** Emergency numbers vary by country. The emergency number(s) in your phone may not work in all locations, and sometimes an emergency call cannot be placed due to network, environmental, or interference issues.

## 3. Basic



### 3.1 Display











The idle shows when you turn your phone on:

The idle mainly includes status icons area, Letter area, and Application area.

#### Clue icon area

**Note: For Dual-SIM models, please select SIM1/SIM2 before proceeding to below steps.**

	<p>Signal Strength</p> <p>The vertical bars show the network connection strength.</p> <p>SIM card signal</p> <p>SIM card is not open</p>
	<p><b>New messages</b></p> <p>This icon shows when you receive a new message.</p> <p><b>The inbox is full.</b></p> <p>This icon flickers when the inbox is full and you need to delete messages to receive new messages.</p>

	<p><b>New Media Messages</b></p> <p>This icon shows when you receive a new media message.</p>
	<p><b>Turn alarm on</b></p> <p>This icon shows when you turn alarm on.</p>
	<p><b>Earphone</b></p> <p>This icon shows when you plug the earphone in. Voice will be heard from the earphone.</p>
	<p><b>Alert Type</b></p> <p><b>Your current alert type:</b></p> <p>Ring</p> <p>Vibra</p> <p>Vibra and ring</p> <p>Vibra then ring</p> <p>Silent</p> <p>This icon shows when you divert all calls unconditionally.</p>
	<p><b>Missed calls</b></p> <p>This icon shows when you are viewing the missed call.</p>
	<p><b>Call Divert</b></p> <p>This icon shows when you divert all calls unconditionally.</p>
	<p><b>GPRS Connection</b></p> <p>This icon prompts you to the SIM card has connected to the GPRS status</p>
	<p><b>Roaming</b></p> <p>This icon shows when your phone is in roaming state.</p>
	<p><b>Bluetooth</b></p> <p>This icon shows when the Bluetooth is active.</p>
	<p><b>Stopwatch</b></p> <p>This icon shows when stopwatch is being used.</p>
	<p><b>Battery Capacity</b></p> <p>This icon's color shows the status of battery capacity.</p>

## Text Area

In the area, you can see the following contents:

Operator Name	Showing the status of SIM cards respectively, mainly the network operator's name and SIM card's current state etc. Exceptionally, please carry the correct operation according to the hints. For example, show that the "emergency call", said you can only make an emergency call.
Song Name	Shows the name of the music playing.
Owner Number	Shows the SIM number in your phone records.
Time and Date	Shows the time and date of your phone.

**Tips:** You can choose whether to show the date and owner number through the menu of settings.

## Functional Key Areas

This area shows you that the corresponding operation of the left and right soft keys. For example, the standby interface shows: **Menu**, press the left soft key to enter the main menu to choose the interface; **Names**, press the right soft key to check the contact list.

**Tips:** When you enter the main menu to process, please check the names corresponding to the left and right keys, and then carry out the corresponding operations.

## 3.2 Password

The password of your phone is originally set to **0000**. You can change it whenever you like. You can also change your SIM card password or barred dial password but you need to contact your service provider to change them.

**Note:** for details please contact your service provider.

## 4. Functions

---

### 1 Phonebook

### 2 Call Centre

#### 2-1 Call history

#### 2-2 Call Setting

##### 2-2-1 Advance settings

###### 2-2-1-1 Blacklist

###### 2-2-1-2 Auto redial

###### 2-2-1-3 IP dial

###### 2-2-1-4 Call time display

###### 2-2-1-5 Call time reminder

###### 2-2-1-6 Auto quick end

### 3 Settings

#### 3-1 SIM settings

#### 3-2 Phone settings

#### 3-3 Network settings

#### 3-4 Security settings

#### 3-5 Connectivity

#### 3-6 Restore factory Settings

#### 3-7 Sound effects

### 4 Messaging

#### 4-1 Write message

#### 4-2 Inbox

#### 4-3 Drafts

#### 4-4 Outbox

#### 4-5 MMS

##### 4-5-1 Write message

##### 4-5-2 Inbox

##### 4-5-3 Outbox

##### 4-5-4 Drafts

##### 4-5-5 MMS settings



4-6 Broadcast message

4-7 Templates

4-8 SMS settings

## 5 Multimedia

5-1 Camera

5-2 Image Viewer

5-3 Video recorder

5-4 Video Player

5-5 Audio Player

5-6 FM Radio

5-7 Sound recorder

5-8 File manager

## 6 Organizer

6-1 Torch

6-2 Calendar

6-3 Tasks

6-4 Alarm

6-5 Calculator

6-6 Stopwatch

## 7 Fun & Game

7-1 Games

## 8 User profiles

8-1 General

8-2 Meeting

8-3 Outdoor

8-4 Indoor

8-5 Headset

8-6 Bluetooth

## 9 Services

9-1 STK

9-2 Internet service

9-2-1 Homepage

9-2-2 Bookmarks

- 9-2-3 Recent pages
- 9-2-4 Input address
- 9-2-5 Service inbox
- 9-2-6 Settings

**Note:** “STK” may show different contents based on different service providers. For Dual SIM models, two STK menus may be shown based on the type of the SIM Card.

## 5. Message

---

You can receive and send messages, and MMS including Multimedia Information, attach photos, pictures, music and text. And can also use broadcast message and voice mail box. All service is web based requiring data service. Please consult the provider before using.

Messages make it possible for you to exchange messages with other wireless phone users. Enter main menu from idle mode and select **Message** to enter.

**Note: For Dual-SIM models, please select SIM1/SIM2 before proceeding to below steps.**

### 5.1 Writing Messages

You can write a new text message send to others, and also can insert template in the message. When finished, you can perform following operations:

<b>Send to</b>	Add a recipient address and send this message
<b>Input method</b>	Choose the input mode when editing text message
<b>Insert template</b>	Commonly used phrases can be inserted into when editing text
<b>Insert number</b>	Numbers can be inserted when editing text
<b>Insert name</b>	Names can be inserted when editing text
<b>Insert bookmark</b>	Bookmarks can be inserted when editing text
<b>Save to drafts</b>	Save this provision SMS to Drafts

### 5.2 Inbox

After entering the inbox menu, Depending on the selected mode, the phone vibrates or rings when you get a new message with screen showing the new message icon and prompt lights flickering. After you go back to idle mode, /shows on the top of the status bar till you read the new message.

While reading a message, you can perform following operations:

<b>Reply:</b>	Reply to a message
<b>Call sender</b>	Call the current message sender
<b>Forward:</b>	Send the message to somebody else
<b>Delete:</b>	Delete the message
<b>Use Number</b>	Extract the number from this message and perform operation with it
<b>Delete All:</b>	Delete all the messages in the inbox
<b>Mark several</b>	Can choose several messages in the current folder at one time to delete, copy, and other related operations
<b>Details</b>	View Message details
<b>Advanced</b>	Can copy, move, address, and other operations

**Note:**  keeps flickering in idle when your inbox is full. Please delete some messages to receive new messages.

### 5.3 Drafts

In the draft menu, you can perform following operations. Drafts stores incomplete messages not ready to be sent

You can perform following operation to the SMS stored:

<b>Send</b>	Send the SMS again.
<b>Edit</b>	Enter the SMS edit interface
<b>Delete</b>	Delete the SMS.
<b>Delete All</b>	Delete all the SMS in the draft box.
<b>Mark several</b>	Can choose multiple messages in the current folder in one time to delete, copy, and other related operations
<b>Advanced</b>	Can copy, move, address, and other operations

### 5.4 Outbox

In the outbox menu, you can perform following operations.

Enter outbox to view the sent messages that you saved to perform the following operations:

<b>Send:</b>	Send this message to one contact person
<b>Edit:</b>	Edit this message
<b>Delete:</b>	Delete this message
<b>Delete all:</b>	Delete all the messages in outbox
<b>Mark several</b>	Choose multiple messages in the current folder in one time to delete, copy, and other related operations
<b>Advanced</b>	Can copy, move, address, and other operations

## 5.5 MMS

### Write message

**Option** after editing the MMS:

Done	Confirmed the editing completed.
Cancel	Exit without saving edits
Input Method	Input method used when editing the text message.

When editing multimedia messages, you can see the following options: recipient, copied, send secretly, topic, content etc.

Input the corresponding address in the recipient, copied or send secretly items, then press the **Done** to operate the following operation:

Send only	Send the multimedia message edited.
Save and Send	Save the multimedia message edited and send.
Save to Drafts	Save the multimedia message edited to the draft box.
Send Options	Setup contents for the edited multimedia message.
Exit	Exit the editing interface without saving the message.

Against the recipient, copied or send secretly, can press the **options** key after editing to operate the following operations:

Add Number	Add the number of the multimedia message recipient.
Add Email	Add the E-mail of the multimedia message recipient.
Edit	Edit the recipient selected.
Delete	Delete the number from the recipient list.

Against the content of the multimedia message, press **options** to do the following operations:

Add text	Enter text in the current edited content
Add picture	Adding the selected picture file in the current edited content where Cursor stopped
Add audio	Adding the selected sound file in the current edited content where Cursor stopped
Add attachment	Add additional files in this MMS section
Add slide before	Add a new page before the current page
Add slide after	Add a new page after the current page
Preview	View the contents of this MMS
Slide time	Set play interval time between the current page and the next

**Note:** If your MMS can not send successfully, please check the corresponding settings of the

MMS. In the Setting-MMS Setting-Profile, please change the connection type to the WAP.

## Inbox

The Inbox is for storing received MMS. Depending on the selected mode, the phone vibrates or rings when you get a new MMS with screen showing the new message icon and prompt lights flickering. After you go back to idle mode,  shows on the top of the status bar till you read the new MMS.

Against the MMS in the inbox, you can operate the following operations:

<b>View</b>	View the MMS
<b>Reply</b>	Edit MMS to reply the sender or all
<b>Reply by SMS</b>	Send a short message to the sender
<b>Reply ALL</b>	Edit MMS to reply to the sender or all recipients
<b>Forward</b>	Edit the corresponding information including the recipient, address of the current MMS then send to other
<b>Delete</b>	Delete the MMS
<b>Delete All</b>	Delete all the MMS in the inbox
<b>Porperties</b>	View the details of the MMS
<b>Use details</b>	Extract the number or hyperlink from the message to access,

## Outbox

Enter outbox to view the MMS that you saved and you can perform following operation:

<b>View</b>	View the MMS
<b>Send</b>	Edit the current message's To, Cc, recipients and other relevant information and send to others
<b>Edit</b>	Modify the current MMS
<b>Delete</b>	Delete the MMS
<b>Delete All</b>	Delete all the MMS in the outbox
<b>Properties</b>	View the details of the MMS
<b>Use details</b>	Extract the number or hyperlink from the message, and you can dial, save the number; you can connect or add bookmarks for the hyperlink

## Draft Box

Store the messages you save when you edit.

you can perform following operation to the MMS stored:

<b>View</b>	View the MMS
<b>Send</b>	Edit the current message's To, Cc, address and other relevant information

---

	and send to others
<b>Edit</b>	Modify the current MMS
<b>Delete</b>	Delete the MMS
<b>Delete All</b>	Delete all the MMS
<b>Properties</b>	View the details of the MMS
<b>Use details</b>	Extract the number or hyperlink from the message, and you can dial, save the number; you can connect or add bookmarks for the hyperlink

## MMS Settings

You can setup your MMS through the menu by your need as following:

<b>Profiles</b>	Start or edit the service, when can not send MMS messages, you can use the current server - option to type online WAP. In this menu, please select the SIM card before you need to operate.
<b>Common settings</b>	You can edit, send, receive, filter-related settings; to view the multimedia content stored.

**Note:** If you fail to send MMS, please change the connection type to WAP in the server setting.

## 5.6 Broadcast message

Enter the Broadcast message menu, to perform the following operations.

Cell Broadcast is messages sent from network operator to GSM phone users, such as weather broadcast, traffic situation, stock updates etc. every kind of Cell Broadcast has a fixed model number and the phone can automatically store a Cell Broadcast from a new channel. The new Cell Broadcast message overrides the old one if they are from the same channel.

**Receive Mode:** Select the status of the broadcast message (on or off)

**Read Message:** Read the broadcast messages

**Language:** Set the language of the broadcast messages

**Channel Settings:** Set the broadcast messages channel

**Note:** this function must be supported by the network. For more information about this please contact your network provider.

## 5.7 Templates

The phone provides you 10 groups of commonly used phrases, you edit, delete, etc, and also can choose to create a short message from a template

## 5.8 SMS settings

Enter the settings menu, to perform following operations.

- Profile Settings:** Offer you four profiles and you can edit their names, set SC Address and Valid Period etc.
- Voicemail server** Computer response service: it will automatically give response (your own voice can be used), send greetings and record information when you cannot answer a call.
- Common Setting:** Set delivery report on or off
- Memory Status:** Check the capacity of messages stored.
- Preferred Storage:** Set the default message storage location, including phone storage and SIM card.

**Note:** you need support from the service provider to receive delivery reports.

## 6. Phonebook

---

Select **Phonebook** from main menu to open phone book.

The phone book consists of phone storage and SIM card storage and you can use both of them.

**Note: For Dual-SIM models, please select SIM1/SIM2 before proceeding to below steps.**

**Phone Storage:** Store the name, default number, family number, company name, email address, company number, fax number and group/individual ring for contacts.

**SIM card Storage:** The capacity depends on your SIM card type and there is only a name and one default number in each item. For details, please contact your service provider.

Choose **Add new contact** in the **Phonebook**, entry **Option** menu you can perform following operations:

- Select** In this menu you can add a new contact record, choose save to SIM or phone
- Search contact** Quick Find contacts by entering the name
- Mark several** Select multiple contacts to send text messages, and delete
- Caller groups** There are 5 caller groups in your phone and you can set the group name, group incoming call ring and group members.
- Phonebook settings** In this menu, you can set the speed dial, my number, card version and

other settings, and also can copy, move, delete contacts and other operations.

Select any contact record, enter the **Options** menu you can perform following operations:

<b>View</b>	View all the information about the name.
<b>Send text message</b>	Send messages to the item.
<b>Send multimedia message</b>	Send MMS to the item
<b>Call</b>	Use the Send key to call the sender
<b>IP dial</b>	IP calls on the item
<b>Edit</b>	Edit the information of the contact.
<b>Delete</b>	Delete the record.
<b>Copy</b>	Copy the contacts stored in the phone storage into the SIM card or vise-versa..
<b>Move</b>	Move the contacts stored in the phone storage into the SIM card or vise-versa.
<b>Send contact</b>	Send current contact numbers by SMS, MMS and Bluetooth
<b>Add to blacklist</b>	Add the selected contact to the blacklist
<b>Mark several</b>	Select multiple files in a folder
<b>Caller groups</b>	There are 5 caller groups in your phone and you can set the group name, group incoming call ring and group members.
<b>Phonebook settings</b>	In this menu, you can set the speed dial, my number, card version and other settings, and also copy, move, delete contacts and other operations.

## 7. Call Center

---

Enter the main menu **Call Center**, to perform the following operations.

**Note: For Dual-SIM models, please select SIM1/SIM2 before proceeding to below steps.**

### 7.1 Call history

You can view the log, related information and corresponding operations.

#### View call history

Your phone keeps lists of incoming and outgoing calls, even for calls that didn't connect. The most recent calls are listed first.

**Tip:** the phone keeps only the latest call of the same number.

- 1, Find the lists of **Dialed Calls, Received Calls, Missed Calls**



- 2, Press **OK** key to view the detail information: date, time and times etc.
- 3, press **Option** key to perform following operations:
 

<b>View</b>	View all the information of this record
<b>Call</b>	Call the number of this record
<b>Send text message</b>	Send SMS to the number of this record
<b>Send multimedia message</b>	Send MMS to the number of this record
<b>Save to Phone Book:</b>	Save the number of this record to the phone book.
<b>Add to blacklist</b>	Add the number in this record to the blacklist.
<b>Edit before call</b>	Enter the number edit screen, you can modify, save or dial the number.
 <b>Delete</b>	 Delete the record.

### Delete call history

You can delete all records in missed calls, dialed calls and answered calls, you can also choose to delete all records of all three parts.

### Call time

You can check the duration of calls made..

<b>Last Call</b>	Shows the length of the last call.
<b>Dialed Calls</b>	Shows the length of dialed calls.
<b>Received Calls</b>	Shows the length of answered calls.
<b>Reset All</b>	Reset the last call time, total dialed time and total incoming call time

### Call cost

You can check the call cost of the phone up to now through the menu.

<b>Last Call Cost</b>	Examine the last time call cost.
<b>Total Cost</b>	Examine all the calls' cost.
<b>Reset Cost</b>	Input the PIN2 code, to clear all the records.
<b>Max Cost</b>	Show the limitation of the currently cost, "0" means no limit.
<b>Price Per Unit</b>	Press setting to setup the unit time rates.

**Note:** The call cost function must be supported by the network service provider. Reset the cost, setup the maximum cost and rates need to input the PIN2 code, please check with your network provider to gain the password.

### SMS counter

You can examine the number of sent and received SMS.

## GPRS Counter

You can examine the transmission flow when using the GPRS web, including the data flow of **last sent**, **last received**, **all sent** and **all received**. You can also reset the records through the **Reset Counter** menu.

## 7.2 Call Settings

You can perform following operations through this menu, some should be separated from settings for SIM card or for other calls.

**Note: For Dual-SIM models, please select SIM1/SIM2 before proceeding to below steps.**

### Call settings

<b>Caller ID</b>	Input owner number or setup
<b>Call Waiting</b>	Setups the call waiting function.
<b>Call Divert</b>	Setups the call divert function.
<b>Call Barring</b>	Setups the call barring function.
<b>Line Switching</b>	Switch your current line and there are 2 lines available

### Advanced settings

This menu includes the call time display, call time reminder and auto quick end setting

- Blacklist** Can set 20pcs blacklist number. When this function is active, the incoming calls in the black list will be shielded automatically.
- Auto redial** When this function is active, dial a phone number if they do not answer will automatically redial the number
- IP dial** You can set three IP numbers in the phone, activate a set of IP numbers, after you choose the IP number, the phone will automatically be added to this group of IP numbers before the outgoing telephone numbers are dialed
- Call time display** Turn on or off the call time display function
- Call time reminder** Can prompt the user during a call, select Close, remind once or set a reminder cycle
- Auto quick end** When this function is active, the call will automatically end.

## 8.Settings

You can set your favorite wallpaper, ring or some other function. According to the main menu - **Settings** the configuration of the phone set .

## 8.1 Phone Settings

Enter **Settings** from main menu, select **Phone Settings** and then you can set the following:

- Time and Date**      Set your current time zone, time, date and their display format.
- Schedule Power On/Off**      You can set up to 4 time points to automatically turn the phone on and off.
- Language**              Set the display language.
- Preferred input methods**      Select the preferred input method as you like.
- Display**                You can find submenus such as wallpaper, screen saver, power on display, and power off display, show date and time, show owner number in display characteristic.
- Greeting text**        When power on, the screen will show a few words. Switch on/off this function.
- Dedicated Key**        Set four menus that you can enter directly from idle by press the 4-way navigation key up, down, left and right.
- LCD Back Light**      Setup the brightness & time of the back light.

**Note:** your choice of time zone does not change the time and date you has setup. The setting of Schedule Power On/Off won't be activated if you set the same time for them.

## 8.2 Network Settings

Enter **Settings** from main menu, select **Network Settings**:

- Network Selection Preferences**      New search, Select Network, Selection Mode
- Preferences**              Set the preferred network during searching.

## 8.3 Security Settings

Enter **Settings** from main menu, select **Security Settings** and then you can perform following operation:

- SIM security settings**              You can set SIM lock (PIN code), fixed dial, barred dial and change password for the SIM Card.
- Phone Lock**              Set a password for phone lock and the default password is **0000**.
- Cover open lock**        Set a password for cover open lock and the default password is **0000**.
- Change Password**      Change the Phone Lock Password.

**Note:** for Pin Password, please contact your service provider; Fixed Dial and Barred Dial must

be supported by your SIM card. For details, please contact your service provider.

## 8.4 Connectivity

Select the connectivity menu, you can perform the following operations:

### 8.4.1 Bluetooth

The phone provides Bluetooth function, select **Bluetooth** to enter, you can operate as follow:

#### Power

Select to turn on/off the Bluetooth Device, you must turn on the Bluetooth Device of the phone before using it.

#### Visibility

Turn on or off the can be searched function.

#### My Device

The menu will list all the Bluetooth Device that you inquired and you can select the device you need to perform the operations: **Connect, Set as default audio device, Service list, Rename, Delete, Delete all** etc.; also can examine the service list of the device selected.

#### Search Audio Device

Select the menu after turning on the Bluetooth, the phone will inquiry the Bluetooth Device within the scope automatically. Please sure that the Bluetooth Device that need to be inquired is power on before inquiring.

#### My name

Can set the device name of the phone.

#### Advanced

You can perform the following operations to the phone's Bluetooth device, such as :set the audio path, storage location, sharing permission, remote control and the bluetooth device address and other relevant operations

### 8.4.2 Data account

#### GPRS

In the sub-menu will list the current GPRS WAP settings to access account information on file list, select a setting item, select "Edit" can be as follows

**Account name:** Account name can be edited and settings

**APN:** Input APN

**User name:** APN server's user identity, default is empty

**Password:** APN server as needed to identify your password, default is null

**Auth. Type:** Press Left-right key to select **normal** or **secure** options, after "done" the set, you can set the authentication type in the WAP authentication.

**Primary DNS:** Set the primary DNS address

**Secondary DNS:** Set the secondary DNS address

## 8.5 Restore Factory Settings

Enter **Settings** from main menu, select **Restore Factory Settings** and then you can restore initialized settings for wallpaper, screen saver, ring etc.

## 8.6 Sound effects

Select **Audio effect** menu, you can set the audio effects , after open the Equalizer, you can set the sound effect as normal, bass, dance, classical, treble, party, pop and rock.

# 9. Multimedia

---

Your phone offers multimedia applications and you can use **Multimedia** from main menu to open it.

## 9.1 Camera

Your phone has a hi-Mega pixel camera that you can take photos whenever and wherever you like. After taking photos, store them in the phone memory or memory card (should be Sure the memory card is inserted).

### Camera Settings

Press **Options** in viewfinder display and make detail settings:

<b>Photos</b>	Can view the pictures that stored in the folders.
<b>Camera Settings</b>	Set the status of LED highlight, shutter sound, EV, Contrast, Anti-flicker, delay timer and Cont-shot
<b>Image Settings</b>	Adjust the photo's size and quality.
<b>White balance</b>	Set the white balance status.
<b>Scene Mode</b>	Select night or auto\ mode
<b>Effect settings</b>	Set special effect to the photo which will be token.
<b>Storage</b>	Set the storage location.
<b>Restore Default</b>	Use the default settings.

## Take a Photo

In the camera viewfinder state, there need to take the show in the frame, press the **OK** key to take a photo.

After photo graphing, enter **Options**, Select **Send** to save and send the photo as multimedia message or Via Bluetooth. Select **Delete** to give up saving and back to the view finder state.

**Tips:** All the photos are stored in the **Photos** file.

## 9.2 Image viewer

You can view the photos in this menu. All the photos related will be shown once you perform this function. You can press left soft key to open option menu:

<b>View</b>	View the image files supported by the phone.
<b>Browse style</b>	Can setup the browse style as: List style or Matrix style
<b>Send</b>	Send the file by MMS or Bluetooth.
<b>Use as</b>	Send the file to wallpaper to use.
<b>Rename</b>	Rename the file name.
<b>Delete</b>	Delete this picture file.
<b>Sort by</b>	Arrange the files by name, type, time, size or none.
<b>Delete All files</b>	Delete all the files in the current folder.
<b>Storage</b>	Set the view photos path: Memory card or phone.

## 9.3 Video recorder

Enter the video menu, the view-finder will appear on the screen. You can record movie by this mobile.

### Video Settings

Press left soft key to open **Option** menu:

<b>Camcorder setting</b>	Set the status of EV, Night mode and Anti-flicker
<b>Video settings</b>	Set the status of video's quality, size & time limit reach and Record audio.
<b>White balance</b>	Set the white balance status.
<b>Effect setting</b>	Set special video effect.
<b>Storage</b>	Set the movie save path: memory card or phone.
<b>Restore Default</b>	Use the default settings.

## Record the Video

In the video viewfinder mode, press the **OK** key to start recording, press the **OK** key a second time to pause the video; during the video recording press the right function key to stop recording and goto the video save interface, option **yes** to save the video file, otherwise abandon the current video.

**Tips:** All the videos are stored in the **Videos** file

## 9.4 Video Player

Choose **Video Player** to open it and view all video files. Press the **Option** and perform following operations on the selected video: play, send, rename, delete, delete all files ,sort by and storage.

During playing, press the up or down key to adjust the volume, press the left or right key to control playing rate.

## 9.5 Audio Player

You can use the audio player to broadcast music. Press **OK key** to play or pause the current music, press **left key** to the before, and press **right key** to the next. You can adjust the volume of the MP3 press **down key / up key**.

Select **List-Options-Settings** you can perform the following operations:

- |                           |  |
|---------------------------|--|
| <b>Player settings</b>    | Can set the Preferred Playlist's store path, turn on / off the auto generated list, set the repeat mode, on / off the shuffle playback and background play function. |
| <b>Sound effects</b>      | By this menu you can set the sound effects, on / off the Equalizer, when open the equalizer you can set a variety of sound effects.                                  |
| <b>Bluetooth settings</b> | After set this item, you can listen music by Bluetooth headset.  |

**Note:** **Background Play** is not available in Sound Recorder, Camera, Video Recorder and Video Player. If you don't need Background broadcast, please suspend broadcasting then withdraw the player.

## 9.6 FM Radio

Choose the **FM Radio** menu, and then turn the broadcasting FM Radio on.

### Listen to the FM Radio

Start the FM Radio function, the interface will show the location No., name (if saved) and frequency of the FM Radio channel.

**Tips:** To the channels saved, while listening, you can choose the location of the FM Radio channel needed by press the corresponding number.

Press the **left key** to enter the **Option** menu, you can perform the following operations:

**Channel list:** Memory channels, you can manually edit the channel, or by "automatically search and set" feature automatically generated.

**Manual input:** You can manually edit the channel, and it will automatically jump to the channel

**Auto search:** Available channels automatically found and stored in the channel list

**Settings:** Can set the background play, loudspeaker, record format, audio quality, record storage location.

**Record:** Can be recorded on the selected channel.

**Append:** Adding in the before recorded file.

**File list:** Enter the file manager to view file.

**Tips:** This phone has no built-in antenna, if you want to listen to the radio, insert the headset first.

## Basic Usage

The phone offers you with the FM Radio background play function, to turn off the FM Radio, please press **OK key** and under the FM Radio interface after it turn gray, then quit.

When you want to adjust the volume, press **up /down key** to increase/lower volume.

**Tips:** When listen to the FM Radio, you can make or answer a call normally. While talking, the volume of the broadcast will into mute automatically.

## 9.7 Sound Recorder

Press the **Options** and perform following operations on the sound file:

### New record

start recording and during recording, you can press the **pause** option to pause and press again to continue. Press the **stop** option to stop recording and go to save interface, press **Yes** to save the sound file. If you prefer not to save it, press **No** to go back.

**Tip:** the sound files are stored in the **Audio** file.

### ❖ Play

Play the selected sound file.

### ❖ Append

For files in AMR format, you can add a new sound recording onto the original one and then



save them.

**Tip:** **Append** is not available for files in other format.

✧ **Rename**

Change the name of the current sound file.

✧ **Delete**

Delete the current sound file.

✧ **Delete All files**

Delete all the sound files.

✧ **Use as**

Use the currently selected audio files in profile.

✧ **Send**

Send the current sound file to user profile, MMS or Bluetooth.

✧ **Settings**

Set the file format and storage location.

## 9. 8 File manager

Select **File manager** and you can find the storage devices and the capacity of total space and free space. On different objects, there are different operations.

✧ **Storage devices:** press **Option** to perform following operations:

<b>Open</b>	List all the folders and files
<b>Format</b>	Format the storage devices, the operation will delete all the data stored in the storage devices
<b>Details</b>	View memory card name, total size and the free size

✧ **Folders:** press **Option** to perform following operations:

<b>Open</b>	Show the file tree in this folder and list all files
<b>Create Folder</b>	Create a new folder and edit its name
<b>Rename</b>	Change the folder's name
<b>Delete</b>	Delete the folder

<b>Sort by</b>	Arrange the folders or files by <b>name, type, time, size or random</b>
----------------	---

✧ Files: press **Option** to perform following operations:

<b>Play</b>	For the multi-media files the phone supports, it show the menu; you can play the multi-media files by the menu
<b>Send</b>	Can send the select file as MMS or via Bluetooth.
<b>Use as</b>	Can send the audio files to user profiles, and use the image files as wallpaper, screen saver and etc.
<b>New folder</b>	Use this menu to build a new folder.
<b>Rename</b>	Edit the file's name
<b>Delete</b>	Delete this file
<b>Sort by</b>	Arrange the folders or files by <b>name, type, time, size or random</b>
<b>Copy</b>	Copy this file to any other folder in the same storage device
<b>Move</b>	Move this file to any other folder in the same storage device
<b>Delete All Files</b>	Delete all the files in current folder
<b>Detail</b>	Show the updating time and its size

**Tip:** the options may differ depending on the object types.

## 10. Organizer

---

Your phone provides you more management tool. Enter from main menu **Organizer**.

### 10.1 Torch

This phone could also work as an electric torch by opening the main menu **Organizer** ->**Torch**. You can choose **on** to turn the torch on, and choose **off** when it is on.

### 10.2 Calendar

The screen shows current date framed by special color box when entering Calendar. Press the up, down, left or right key to move to different date. Press OK key or left soft key to enter the corresponding menu and you can select view, view all, add event, delete event, jump to date & go to weekly view.

### 10.3 Tasks

Enter **Task** from Organizer and you can check all tasks. While the task list is empty, press left soft key to “**Add**” new tasks , choose Date, Call or Anniversary, different icons represent different to distinguish your convenience . After choose the sort, enter the editing interface, you need to edit the following: time, subject, alarm, location, priority. When you complete and save this, it will be shown in the tasks list. While viewing a task, you can also enter **Options** by pressing left key to perform following operation:

#### **View**

View the content of selected task

#### **Add**

Select Add to create a new task. You can edit its date, time, note, alarm mode and reminding mode etc.

#### **Edit**

Edit the content of selected task

#### **Delete**

Delete the content of selected task

#### **Delete overdue**

Delete the expiration tasks relative to the current date

#### **Delete All**

Delete all the tasks

#### **Jump to date**

Set the date you want to jump to.

**Send vCalendar**

Send the task as SMS, MMS or via Bluetooth.

**Save as file**

Save the task to file manager.

**Note:** there is fixed room for storing tasks and when no “Add” shows in “Option”, please delete some indifferent tasks to save room for important ones.

**10.4 Alarm**

Your phone has an alarm clock with 5 separate alarms that you can set to alert you at the time(s) you specify. To set an alarm clock, select one alarm and press left soft key to edit its on/off, time, repeat, alarm tone, snooze and alert type.

**10.5 Calculator**

Enter **calculator** menu, you can process simply digital computing. Now the phone becomes your calculator.

**10.6 Stopwatch**

Choose **stopwatch**, there are **Typical Stopwatch** and **nWay Stopwatch** for different occasions and following are ways to use them.

**Typical Stopwatch**—there are two ways for your timing, that is **Split Timing** and **Lap Timing**. Enter **View record** to check previous timing records.

**nWay Stopwatch**—press start you can time 4 courses by pressing the 4-way navigation key up, down, left and right.

## 11. Fun & Games

---

### 11.1 Games

Enter from menu **Fun & Games** → **Games**, the phone provides you many games interesting, which make your life wonderful.

To the rules of the built-in games, you can refer to the notes of the games.

And you can setup the sound and the shock through the game settings.

## 12. User Profiles

---

Enter **Settings--Profiles** from main menu and there are several profiles that you can edit the contents as you like: **General**, **Meeting**, **Outdoor**, **Indoor**, **Headset** and **Bluetooth**. Once you pair your phone with an earphone or a Bluetooth device, the **Headset** and **Bluetooth** are automatically activated and meanwhile the profile in use is deactivated.

You can choose any profile as you like and customize the selected one:

**Tone Settings:** Set the incoming call tone, incoming message tone and keypad tone

**Volume:** Set the volume of ring tone and key tone

**Alert Type:** Set ring, vibration only, vibration and ring , vibration then ring and silent

**Ring Type:** Set single ring, repeat ring or ascending ring

**Extra Tone:** Set warning ring and error ring on or off

**Answer Mode:** Set pressing any key to answer except power on/off key and right soft key or not. Set auto answer on or off (only in Headset Mode).

## 13. Services

---

The phone provides you more application software, and it makes you more convenient.

### 13.1 WAP

Your phone can connect to the Internet or run web-based applications by using web browser. If you need, please consult your service provider how to link the network. Enter from the main menu **Services** select the **WAP** menu.

**Note:** Your phone is applicable to the GPRS (General Packet FM Radio Service) network link. Type of the network link depends on your network service provider. This function must be supported by network. For more information about this please contact your network provider.

### Homepage

Selecting the main menu, you can log on the homepage set up to browse. If you do not set up, you can use the website pre-set by the manufacturer.

### Bookmarks

Enter the bookmark menu, the menu list shows all the bookmark exist, Select the **options** button, you can do the following operations to the bookmark selected:

<b>Goto</b>	Link the website appointed by the bookmark.
<b>Edit</b>	Edit the name and address of the current bookmark.
<b>Send</b>	Transmit the address of the bookmark by message or MMS.
<b>Delete</b>	Delete the bookmark.
<b>Delete All</b>	Delete all the information of bookmarks.
<b>Add Bookmark</b>	Add new name and address of the bookmark.

### Recent pages

The menu lists the website records your recent visit to facilitate your visit to the site.

### Input Address

Enter the menu, after inputting the URL address of the WAP service that you want to visit, select the **option** button and select complete. The phone automatically logs on the website you input.

### Service Inbox

You can check the web service message in this mailbox, and can also process delete etc.

## Settings

You can select **settings** menu, then set up the content relates to the WAP service as following:

<b>Select SIM</b>	Set SIM card setting
<b>Profiles</b>	Select and start the network configuration file you need, can set up homepage, account and login password etc.
<b>Browser options</b>	Waiting time of viewing the website and figures shown.
<b>Service Message Settings</b>	Turn on/off the reception of the service news.
<b>Clear Cache</b>	Use to clear the records in the cache.
<b>Clear Cookies</b>	Use to clear personal writing data.



## 14. Input Method.

The phone supports many input methods such as capital letter and small letter, numeric, and so on:

- Write or edit a message
- Input or edit a name in phone book
- Search for a name
- ...

### 14.1 Text Input Method

Text input method includes capital letter and small letter. Writing and keyboard both can use. The keys corresponding the uppercase and lowercase input separated by “;”, and no semicolon separates show that the two input method correspondingly appear the same characters.

Numeric Key	Character
Numeric Key 0	0, space
Numeric Key 1	1 or symbols
Numeric Key 2	ABC2; abc2
Numeric Key 3	DEF3; def3
Numeric Key 4	GHI4; ghi4
Numeric Key 5	JKL5; jkl5
Numeric Key 6	MNO6; mno6
Numeric Key 7	PQRS7; pqrs7
Numeric Key 8	TUV8; tuv8
Numeric Key 9	WXYZ9; wxyz9
*Key	Select symbol
#Key	Switch input method
4-way navigation key up	Move up cursor
4-way navigation down	Move down cursor
4-way navigation left	Move left cursor
4-way navigation right	Move right cursor
Right soft key	Back or Clear

While using English input method, please follow this order:

Keep tapping one key till the desired character shows.

Press \* key to find symbols.

Press # key to switch input method.

Press right soft key to clear the wrong character or go back.

## 14.2 Numeric Input Method

Handwriting and keyboard can use meanwhile in numeric input method. The definition of keys while using numeric input method:

Numeric Key	Character
Numeric Key 0	0,
Numeric Key 1	1
Numeric Key 2	2
Numeric Key 3	3
Numeric Key 4	4
Numeric Key 5	5
Numeric Key 6	6
Numeric Key 7	7
Numeric Key 8	8
Numeric Key 9	9
*Key	Select symbol
#Key	Switch input method
4-way navigation key up	Move up cursor
4-way navigation down	Move down cursor
4-way navigation left	Move left cursor
4-way navigation right	Move right cursor
Right soft key	Back or Clear

While using Numeric input method, please follow this order:

Press numeric key 0-9 to input desired character or the number on the screen directly.

Press \*key to find symbols.

Press # key to switch input method.

Press right soft key to clear the wrong character or go back.

## Trouble Shooting

This section lists some problems that you might meet while using your phone. If you feel your phone is not working properly, please try reset settings first, and then follow the Troubleshooting Guide. If you are still unable to solve problems, please contact the authorized service center or the store from where you purchased the phone.

Issue	Solutions
Can not answer or make a call	Make sure that the phone has been switched on. Make sure that the battery is charged. Make sure that the signal intensity is high enough. Make sure the own number function in the call setting is system preset or number sending. Make sure the line switch in call setting is the system preset line. Check whether you have set up call barring or fixed dialing or any other safety function. Check whether you have set up call diverts. Check whether you have inserted the proper SIM card correctly.
Low voice	Check if the volume has been set too low.
No ring	Check whether you have set up the " Silent" option. Check whether the ring volume is not too low Move away from a noisy place to check if you can hear the phone ringing. Check whether you have set up call diverts.

---

## Specific Absorption Rate Data

---

### **This model meets international guidelines for exposure to FM Radio waves.**

Your mobile device is a FM Radio transmitter and receiver. It is designed not to exceed the limits for exposure to FM Radio waves recommended by international guidelines. These guidelines were developed by the independent scientific organization ICNIRP and include safety margins designed to assure the protection of all persons, regardless of age and health.

The guidelines use a unit of measurement known as the Specific Absorption Rate, or SAR. The ICNIRP SAR limit for mobiles devices used by the general public is 2 W/kg.

This wireless phone meets the government's requirements for exposure to radio waves.

The guidelines are based on standards that were developed by independent scientific organizations through periodic and thorough evaluation of scientific studies. The standards include a substantial safety margin designed to assure the safety of all persons regardless of age or health.

The exposure standard for wireless mobile phones employs a unit of measurement known as the Specific Absorption Rate, or SAR, The SAR limit set by the FCC is 1.6 W/Kg.

### **Information from the World Health Organization**

The World Health Organization has stated that present scientific information does not indicate the need for any special precautions for the use of SAR Data mobile devices. They note that if you want to reduce your exposure then you can do so by limiting the length of calls or using a "hands-free" device to keep the mobile phone away from the head and body. Improvement of this device may cause a little change of the SAR data. However, the device is designed in accordance with the guidelines in any case.

Any Changes or modifications not expressly approved by the party responsible for compliance could void the user's authority to operate the equipment.

This device complies with part 15 of the FCC Rules. Operation is subject to the following two conditions: (1) This device may not cause harmful interference, and (2) this device must accept any interference received, including interference that may cause undesired operation.

Note: This equipment has been tested and found to comply with the limits for a Class B digital device, pursuant to part 15 of the FCC Rules. These limits are designed to provide reasonable protection against harmful interference in a residential installation. This equipment generates uses and can radiate radio frequency energy and, if not installed and used in accordance with the instructions, may cause harmful interference to radio communications. However, there is no

guarantee that interference will not occur in a particular installation. If this equipment does cause harmful interference to radio or television reception, which can be determined by turning the equipment off and on, the user is encouraged to try to correct the interference by one or more of the following measures:

—Reorient or relocate the receiving antenna.

—Increase the separation between the equipment and receiver.

—Connect the equipment into an outlet on a circuit different from that to which the receiver is connected.

—Consult the dealer or an experienced radio/TV technician for help.

