

S810

User Manual

Thank you for purchasing the S810 mobile phone

Introduction

Thank you for choosing the S810 mobile phone. This user manual will guide you through the explicit and User friendly feature-sets of the 3G HSDPA Full QWERTY Multimedia Messaging phone in detail. Please take full advantage of the User Manual to make the best use out of your new S810.

The content of this manual is correct at the time of issuance. However, Verykool USA, Inc. reserves the right to amend technology specifications without any prior notification.

Some descriptions in this manual may be different from the actual mobile phone, depending on differences in software and network suppliers.

Reading Statement for the Manual

In the manual, different typesetting styles are used to show different operations, the specific typesettings are as follows:

Operation	Description of Contents	Example
Showing contents	Show with normal characters	0-9
General key	All the keys except functional keys are shown by normal characters with frames	0-9
Functional key	Functional key is shown with bold and frame	OK
Menu item	Show in bold italics	<i>Hold</i>

CONTENT_Toc268794756

1	START USING.....	1
1.1	BATTERY.....	1
1.1.1	<i>Uninstallation and installation of battery.....</i>	<i>1</i>
1.1.2	<i>Charging the battery.....</i>	<i>2</i>
1.1.3	<i>Use of battery.....</i>	<i>2</i>
1.2	SIM CARD.....	2
1.2.1	<i>Inserting the SIM card.....</i>	<i>3</i>
1.2.2	<i>Unlock the SIM card.....</i>	<i>3</i>
1.3	PLUG AND UNPLUG THE MEMORY CARD.....	3
1.4	PLUG AND UNPLUG THE HEADSET.....	4
1.5	STATUS BAR AND CONTENT.....	4
1.5.1	<i>Keys.....</i>	<i>5</i>
2	DIAL AND ANSWER THE CALL.....	7
2.1	MAKING A CALL.....	7
2.2	ANSWERING A CALL.....	8
2.2.1	<i>Answering new voice call.....</i>	<i>8</i>
2.2.2	<i>Connecting two calls at the same time.....</i>	<i>8</i>
2.2.3	<i>Conference call.....</i>	<i>9</i>
2.2.4	<i>Answering a video call.....</i>	<i>9</i>
2.3	EMERGENCY CALL.....	9
3	STANDBY MODE AND MAIN MENU.....	10
4	MY FILES.....	10
4.1	PICTURES.....	10
4.2	SOUND.....	11
4.3	VIDEOS.....	11
4.4	DOCUMENTS.....	12
4.5	JAVA FILES.....	12
4.6	OTHERS.....	12

4.7	MANAGEMENT	12
4.8	T-FLASH	12
5	PHONE BOOK	12
6	LOG	13
7	ENTERTAINMENT	13
7.1	MUSIC PLAYER	13
7.2	VIDEO PLAYER	14
7.3	VOICE RECORDER	14
7.4	GAMES	14
7.5	JAVA BOX	14
7.6	FM RADIO	14
8	MESSAGE	15
8.1	SMS	15
8.2	MMS	15
8.3	E-MAIL	16
8.4	PUSH MESSAGES	16
9	VIDEOPHONE	16
10	CAMERA	16
11	TOOLS	17
11.1	ALARM CLOCK	17
11.2	SCHEDULE	17
11.3	CALCULATOR	17
11.4	DOC. EDITOR	18
11.5	NOTES	18
11.6	TO-DO	18
11.7	WORLD CLOCK	18
11.8	STOPWATCH	18
11.9	COUNTDOWN TIMER	18
11.10	CURRENCY EXCHANGE	18

12	SETTINGS	18
12.1	PHONE.....	18
12.2	PHONE PROFILES	19
12.3	DISPLAY	19
12.4	CALLS	20
12.5	SECURITY	21
12.6	NETWORK	21
12.7	VIDEOPHONE.....	22
12.8	DATA PROFILES	22
12.8.1	<i>Internet profile</i>	22
12.8.2	<i>Data profile</i>	22
12.9	RESTORE FACTORY SETTINGS	22
12.10	CLEAR ALL.....	22
13	CONNECTIVITY	22
13.1	BLUETOOTH	22
13.2	PACKET DATA CONNECTION	23
13.3	PC SYNCHRONIZATION.....	23
13.4	BACKUP TO T-FLASH	23
13.5	RESTORE FROM T-FLASH	23
14	INTERNET	23
15	SIM TOOLKIT	24
16	FREQUENTLY ASKED QUESTIONS	24

Health and safety

Batteries

Never use a charger or battery that is damaged in any way.

Properly use the battery. Do not short-circuit the battery, which may damage the battery, cause heat or cause fire.

Do not dispose of batteries in high temperature of in a fire as they may explode.

Return the waste battery to the dealer or designated recycling center. Do not dispose as household waste.

Battery charging time depends on the remaining battery charge, the type of battery and the charger used. The battery can be charged and discharged hundreds of times, but it will gradually wear out. When your phone's operating time is noticeably shorter than normal, it is time to buy a new battery.

Use only original or approved chargers and batteries.

Unplug the charger from the electrical plug and the device when not in use.

Do not overcharge, which will damage the battery and shorten its life.

Leaving the battery in extremely hot or cold places will reduce the capacity of the battery. Cool down or heat up the temperature to normal level (Li-ion batteries are particularly affected by temperatures below 0°C (32°F)).

Road safety

Your wireless phone gives you the powerful ability to communicate by voice, almost anywhere, anytime. Therefore, you must uphold some important responsibility.

When you are driving, driving is your first responsibility. When using your wireless phone while driving, be more alert and follow local regulations.

Understand the wireless phone and features, such as speed dial and redial which can help you make a call more conveniently without disturbing your driving.

Use a hands-free set if possible. Hands-free accessories may promote the convenience and safety of using your wireless phone.

Place your phone where is easy to access and does not require you to move your eyesight. If receiving a call at an inconvenient moment, let your voicemail answer for you.

When on the phone, tell your conversation partner that you are driving. Hang up in traffic jams or bad weather. Rain, rain with snow, snow, ice and traffic may be dangerous.

Air bags, brakes, speed control systems and fuel injection should not be influenced by radio transmission. If you have these problems, contact your car dealer immediately.

Switch off your mobile phone when fueling or anywhere two-way radio equipment usage is prohibited. Do not put your phone near flammable and explosive substances. Internal spark may cause fire or explosion.

Switch off the mobile phone prior to airplane take-off. To prevent interference to communication systems in the plane, never use a phone during flight. Using a phone before the plane takes off may be allowed by the crew in accordance with safety regulations.

During flight, make sure that your phone will not be automatically switched on by an alarm you have set.

Operating environment

Remember to follow any special regulations in force in your area and always switch off your phone whenever it is forbidden to use it, or it may cause danger.

When connecting the phone or any accessory to another device, read its user's guide for detailed safety instructions. Do not connect incompatible products.

It is recommended that the equipment only be used in the normal operating position (held to your ear with the antenna pointing over your shoulder) for your satisfactory operation of the equipment and for the safety of personnel.

Do not expose the equipment to temperature below -10°C (14°F) or above 50°C (122°F).

Electronic devices

Most electronic equipment is shielded from radio frequency signals. Consult the manufacturer for relevant information.

Pacemakers: Maintain a minimum distance of 6 inches (15cm) between a wireless phone and a pacemaker; do not put your phone in a pocket near the chest; use your ear furthest from the pacemaker to reduce possible interference. If you have any reason to suspect that interference is taking place, switch off your phone immediately.

Hearing aids: Some digital wireless phones may interfere with some hearing aids. In the event of such interference, you may consult your hearing aid manufacturer.

Other medical devices: If you use any other personal medical devices, consult the manufacturer of your device to determine if it is adequately shielded from external RF energy. Your physician may be able to assist you in obtaining this information. Switch off your phone in health care facilities when regulations posted in these areas instruct you to do so.

Vehicles: RF signals may affect improperly installed or inadequately shielded electronic systems in motor vehicles. Check with the manufacturer.

Emergency calls

This phone, like any wireless phone, operates using radio signals, which cannot guarantee connection in all conditions. Therefore, you should never rely solely on any wireless phone for essential communications like medical emergencies.

To make or receive calls, the phone must be switched on and in a service area with adequate signal strength.

To make an emergency call, enter the local emergency number in standby mode and press <Send> to call.

Other important safety information

- Use original or approved accessories. Any unapproved accessory may affect the performance of your phone, damage your phone or even cause personnel injury.
- Your wireless phone sends out an electromagnetic field. Do not put the phone near magnetic storage media such as computer disks. Neighboring electric appliances such as TVs, phones, radio receivers and PCs may affect the use of your phone and its performance.
- Do not connect the phone to an incompatible device.
- Only qualified personnel should service the phone or install the phone in a vehicle.

Care and maintenance

Your phone is a product of superior design and craftsmanship and should be treated with care. The suggestions below will allow you to enjoy this product for many years.

- Keep your phone out of the hands of small children and pets. They may accidentally damage the phone or choke on small parts.

- Keep the phone dry and avoid liquids that corrode the phone.
- Do not use the phone with a wet hand, which may cause an electric shock.
- Do not store the phone in hot areas, which can shorten the life of electronic devices, damage batteries or melt accessories.
- Do not store the phone in cold areas. When the phone warms up to its normal operating temperature, moisture can form inside the phone, which may damage the phone's electronic circuit boards.
- Do not expose your phone to hot sun which may overheat your phone.
- Do not place your phone near flammable liquids, gases or explosive substances.
- Do not drop or knock the phone. Rough handling can break internal circuit boards.
- When cleaning your phone, use a slightly damp or anti-static cloth. Do not use a dry or static cloth. Do not use chemicals such as cleaning solvents to clean the surface. Switch off the phone first and then do the cleaning.
- Do not paint the phone. Paint can prevent proper operation.
- If your phone has a flash, do not use it too close to the eyes. This may cause damage to eyes.
- If the phone or battery gets wet and the label in the phone is damaged, phone repairs are no longer guaranteed by the manufacturer's warranty, even if the warranty for your phone has not expired.

Improper use will invalidate the warranty! These safety instructions also apply to original accessories.

1 Start Using

1.1 Battery

Before using your phone for the first time, please follow the instructions below to charge your battery completely. Do not overcharge, which will damage the battery and shorten its life. When not in use, unplug the charger from both your phone and the electrical outlet.

Battery charging time depends on the remaining battery charge, the type of battery, and the charger used. The battery can be charged and discharged hundreds of times, but it will gradually wear out. When the operation time is noticeably shorter than normal, it is time to buy a new battery.

1.1.1 Uninstallation and installation of battery

- Push the back cover of the phone upward as shown below and remove.

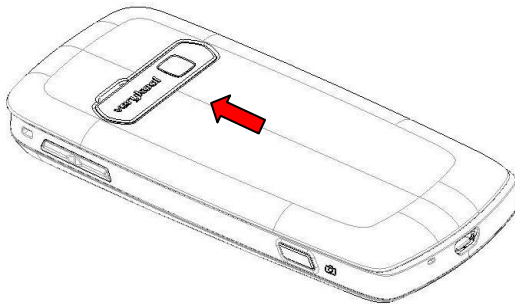

- Pull out the top of the battery and remove.

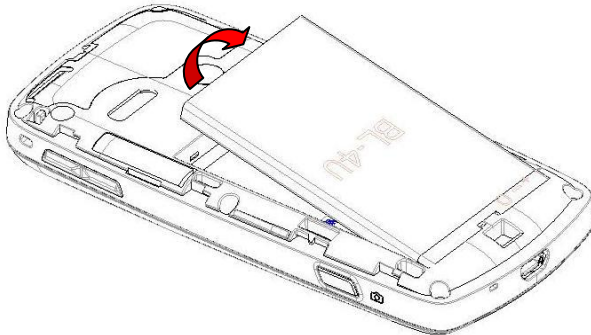

- When installing the battery, insert the metal contact at the bottom of the battery into the corresponding slot of the mobile phone, and then press the battery down to install it in place. The battery must be

ensured to be installed before power on.

- Finally install the back cover of the mobile phone.

1.1.2 Charging the battery

When the power of the battery is lower than usual, the phone will prompt battery low. Please charge the battery, otherwise you will lose unsaved files. If you don't charge for a long time, the phone will be powered off automatically.

When charging, the battery icon at the upper corner of the screen will appear in a charging state. During the charge, the phone and charger may heat up a little bit, which is considered a normal phenomenon.

Warning:

The stated charging temperature ranges from 0°C to 40°C. Please do not use charging equipment if the temperature exceeds the range. Please only use the charger provided by the supplier. Application of unauthorized charger may trigger danger and breach the mobile phone maintenance warranty.

1.1.3 Use of battery

In actual use, the standby time and talk time of the mobile phone varies with the network status, working conditions and different usage behaviors.

SIM card

Your network operator will provide you a SIM card which is the key for your access to the digital GSM/3G network. **Prior to using the phone, you need to insert an activated SIM card in the mobile phone.**

All relevant information concerning network connection will be recorded in the SIM card. SIM card can be removed from your mobile phone and be used in any other GSM mobile phones (new mobile phone automatically reads the SIM).

In order to prevent loss and damage to the information in the card, you should avoid touching the metal area and keep it away from electric and magnetic places. SIM card once being damaged, you will not be registered to the GSM network.

Warning:

You must power off the mobile phone before removing the SIM card. Inserting or removing the SIM card is absolutely prohibited when the external power supply is connected, otherwise the SIM card and mobile phone may be damaged.

1.1.4 Inserting the SIM card

- Power off the mobile phone, remove the back cover and battery.
- Insert the SIM card correctly in the card slot; finally install the back cover and battery of the mobile phone.

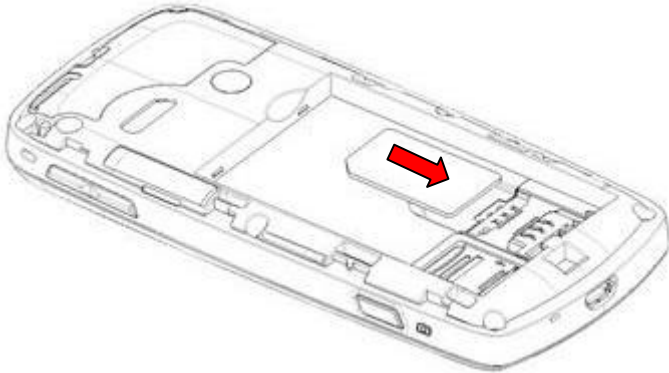

1.1.5 Unlock the SIM card

In order to prevent illegal use, SIM card adopts PIN code (personal identification code) encryption protection.

If this function is selected, PIN code should be inputted correctly each time when you power on the mobile phone, thus to unlock the SIM card for normal use. Users can disarm the SIM card protection but illegal use of the SIM card cannot be prevented.

If the PIN code input is incorrect for three consecutive times, your SIM card will be locked by the network. The mobile phone will enquire the PUK code which will be provided by your network operator. If the PUK code input is wrong for 10 times, the SIM card will be permanently barred.

Note:

Your network operator will set a standard PIN code (4 to 8 numbers) for you and you should change it to private password as soon as possible.

Plug and unplug the memory card

■ Power off the mobile phone, remove the rear cover and battery. The memory card slot at the side of SIM card slot. You should push the memory card slot according to the indication marked in the slot to open it, firstly.

- Insert the memory card to the slot according to the figure below.

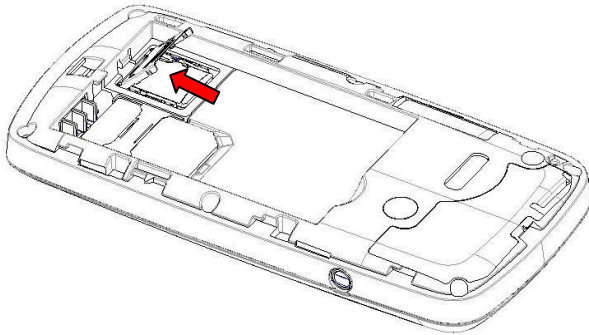

- Then pull the memory card slot to close it.

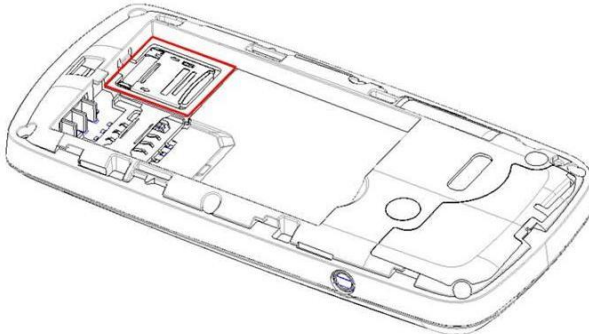





- Finally, install the battery and cover the back cover of the mobile phone. Please keep your memory card safe.

















Plug and unplug the headset

Insert the connector of the headset to the headset jack at the left side of the mobile phone. Gently pull out the headset to remove it.

Status bar and content

In standby interface you can get the information that you need from the indication icons on the screen.

	No service or No SIM card inserted in slot
	Signal strength of WCDMA network
	Signal strength of GSM network
	Internet connected, but no data transfer
	The keypad of mobile phone is locked

	Packet data connected
	Roaming
	Unread SMS
	Unsent SMS
	Unread MMS
	USB cable connected
	Music playing in background
	FM radio playing background
	Unread push message
	The current phone profile is meeting mode
	The current phone profile is outdoor mode
	The current phone profile is driver mode
	All incoming calls are diverted to a defined number
	Headset has been inserted
	Bluetooth power on
	Bluetooth headset connected
	Indicating current battery capacity

1.1.6 Keys

Functions of the keys are described as following:



Sn	Keys	Function description
1	Send key (Snd)	Making a call; answering a call; on the standby interface press the Snd key to enter the Log.
2	End key (End)	Short press End key to hang up the call and back to the standby interface.
3	Left soft key (LSK)	Pop up menu; enter the corresponding function in standby screen.
4	Right soft key (RSK)	Back; enter the corresponding function in standby screen.
5	OK key	Select; enter main menu in standby screen.
6	Navigation key	Move the cursor to left, right, upward or downward.
7	Menu key	Short press to enter main menu screen.
8	Clear key (C)	Clear the item before the cursor in editor.

9	Keyboard	Input number, letter, symbol and character.
10	Receiver	Listen to the voice of the other side when calling.
11	LED	Indicate the event of missed call, unread message, charging and alarm.
12	Headset jack	Insert the headset to answer calls and to listen to the music, and so on.
13	Power key(Pwr)	Long press the key to power on/off the phone.
14	USB port	Connecting USB cable or charger.
15	Microphone	During the calling process, please do not cover the microphone with hand.
16	Volume key	Short press to adjust volume when calling or on standby interface.
17	Camera key	Press to launch the camera; in preview screen press camera key to take a picture.
18	Speaker	For activating the speaker, you can listen audio or calls in hands-free mode.
19	Camera lens	For finding a view with the camera and taking picture or video.

When you have a missed call and unread SMS, the standby interface will display relevant icon (s), press navigation key to switch the item that you want to view; then press **OK** key to view the selected content.

Note:

In the manual “short press X key” refers to loose the key at once after pressing; “long press X key” refers to loose the X key after pressing it for over one second.

2 Dial and answer the call

Making a call

When the network operator’s name appears on the screen, the mobile phone enters into the normal standby state in which you can dial or answer a call. The network signal strength indicator at the top of the screen will show the network signal strength. The call quality has a relatively high impacted from obstacles. Therefore, movement in a small range can effectively improve the signal strength.

In the standby interface, input the call numbers, press **Snd** key to make the voice call, active **LSK** and select **Video call** to make the video call.

Making domestic call

In the standby interface, input the call numbers (please add the area code for domestic long-distance calls), then press **[Snd]** key to make the call.

Calling extension of fixed number

When calling the extension number of a fixed number, you need to dial the host number and then dial the extension number according to the corresponding voice hints. If you insert “p” between the host number and extension number, the mobile phone will automatically dial the extension number for you.

Making an international call

To make an international call, you simply need to input the symbol “+”, then input the country code and complete phone number that you want to dial.

Answering a call

2.1.1 Answering new voice call

If there is a new incoming call during a call in progress, the mobile phone will pop up caller interface (call waiting is activated) and give a short prompt to tell you that you have a new call. At this time, you can press **[Snd]** key or activate **[LSK]** to select **Answer incoming** to answer the new call. When you answer a new call, the original call will enter holding status. At this time, you can activate **[LSK]** to select **Switch** to the original call, and the new call will enter into holding status.

Note:

When you are in call progress, the new call to another SIM card can't be dialed in.

2.1.2 Connecting two calls at the same time

When two telephone numbers are connected, activate **[LSK]**, and you can operate as follows:

Switch: switch call. End active End hold End all, SMS, Phone Book, Mute, Create conference, Enable Bluetooth

End active: hang up the current call.

End all: hang up all the calls.

SMS: edit the SMS and send it.

Phone Book: enter the phone book interface.

Mute: select **Mute** to turn off the microphone. In this mode, the other party will not hear you but you can still hear the other party. You can select **Unmute** to turn the microphone back on and the other party can hear you again.

Create conference: when making conference call, you can have a talk separately with designated conference participants.

Enable Bluetooth: select Bluetooth to turn on Bluetooth and the icon will display on the screen.

2.1.3 Conference call

During the conference call, activate **LSK**, and you also can operate as follows:

Hold: hold the conference call then others can not hear your voice; and the option of **Hold** changed to **Active**, select it and you can go back to the conference call mode.

New call: enter the dialing interface. Press **Snd** key to make the call after inputting the number.

Conference list: display the members that in conference call..

2.1.4 Answering a video call

During the video call, activate **LSK**; you can also operate as follows:

Screen mode: select the display mode of video call, such as: minimize myself, maximize myself, display other person only, display myself only.

Video settings: you can send live video, an image or a video clip to the other party via selecting a live video, substituted picture or substituted video.

Image quality: you can adjust the image quality of the caller and the calling party.

Emergency call

In any country using the digital GSM network, if you are in the network coverage area (you can check the network signal strength at the top of mobile phone screen), even without the SIM card, you also are able to make an emergency call.

Inputting the PIN code or the phone unlocking interface, input emergency number then press **SOS** and you can make an emergency call.

Note:

The emergency call numbers vary in different countries or regions. Please refer to the local information for specific emergency service numbers.

3 Standby mode and main menu

In standby mode, the screen displays lots of useful information, such as missed calls, new messages. You can press navigation keys to select the corresponding items.

In standby interface, press **Menu** key to enter the main menu and use the navigation keys to switch the icons and access the functions directly. The following table shows the twelve functions of the Main Menu where icons appear in the same order on the screen (Sequence of the menus may vary depending on network operators).

My Files	Phone Book	Log
Entertainment	Message	Videophone
Camera	Tools	Settings
Connectivity	Internet	SIM Toolkit

4 My Files

In my files, you can manage files such as pictures, sound, videos and others applications stored in the phone or memory card.

Pictures

All photos and images are stored in this folder including Images/Preset wallpapers. Press **OK** key to preview pictures and press **LSK** for the menu to manage your picture files (for preset pictures, some options below may not be operable):

Delete: delete the current files.

Send: send the selected file via MMS, E-mail or Bluetooth.

Copy: copy the file to destination folder.

Move: move the file to destination folder.

Rename: rename for the picture.

New folder: create a new folder.

Open in sequence: display all file automatically in full screen status orderly.

Use image: use image to relevant applications.

Type of view: arrange the selection according to titles or thumbnails.

Sort: arrange the files according to name, size, date and type.

Mark/ Mark all: mark selected pictures to perform options on multiple pictures.

Getting certificate: get the certificate for the current picture.

Property: display current file details including: Format, Date and time, Size, etc.

Sound

All music and sound files are stored in this folder. Press **OK** key to play files and press **LSK** for the menu to manage your files:

Delete: delete the current files.

Send: send the selected file via MMS, E-mail or Bluetooth.

Copy: copy the file to destination folder.

Move: move the file to destination folder.

Rename: rename for the music.

New folder: create a new folder.

Set as ring tone: set the current audio file as voice call ring, video call ring or message ring.

Add to playlist: add the audio file to playlist.

Type of view: arrange the selection according to titles or thumbnails.

Sort: arrange the files according to name, size, date and type.

Mark/ Mark all: mark selected files to perform options on multiple selections.

Getting certificate: get the certificate for the current file.

Property: display current file details including: Format, Date and time, Size, etc.

Videos

All video clips are stored in this folder. Press **OK** key to play/ pause the file or press **LSK** for the menu to manage your videos:

Delete: delete the current files.

Send: send the selected file via MMS, E-mail or Bluetooth.

Copy: copy the file to destination folder.

Move: move the file to destination folder.

Rename: rename for the video.

New folder: create a new folder.

Open in sequence: orderly play all the videos automatically.

Add to playlist: add the video file to playlist.

Type of view: arrange the selection according to titles or thumbnails.

Sort: arrange the files according to name, size, date and type.

Mark/ Mark all: mark selected video to perform options on multiple videos.

Getting certificate: get the certificate for the current file.

Property: display current file details including: Format, Date and time, Size, etc.

Documents

You can view the documents that stored in your phone.

Java files

All the java files are stored in this folder. You can install and enjoy java applications with this function.

Others

Other unrecognized files are stored in this folder.

Management

Enter management; you can do the operations below:

Storage type: set the storage position as phone or T-flash.

Format T-flash: clear all the data in the T-flash card.

Memory status: displays the available storage in phone and T-flash.

T-flash

T-flash is the memory card used for storing your data. In my file, use left/right navigation key switch to **T-flash** to view all the files stored in the memory card. Press **LSK** for the menu to manage the files.

5 Phone Book

Enter the phone book interface, input the first letter of the name, you can search relevant records. Activate **LSK** to conduct the following operations:

New contact: create a new contact.

Edit contact: edit the current contact.

Delete: delete the information of current contact.

Find: search the the contact by name, number or group.

Send message: send message to current contact.

Send vCard: send the information of current contact as vCard mode.

IP dial: add IP number and call the current contact.

Video call: call the current contact in video call mode.

Copy: copy the contact to designated place.

Move: move the contact to designated place.

Mark/Mark all: mark selected contact to perform options on multiple contacts.

Advanced: you can view the member of group, set the position to view contacts from, view my number from other numbers and check the

memory status of SIM card or Phone.

6 Log

Enter log interface, there displays the records of missed calls. You can press left/right navigation key to switch to other tabs, such as received calls, dialed calls and all calls.

In every sheet, activate **LSK**, you can operate as follows:

Save: save the current number as new contact or replace the existing contact.

IP dial: add IP number and call the current number.

Voice call/Video call: call the current number in voice call or video call.

Send SMS/MMS: send SMS or MMS to the current number.

Edit before call: edit the number before making the call.

Add to blacklist: add the current number to blacklist.

Call duration: you can check the duration time of the last call, received calls, dialed calls and total.

Packet data counter: you can view the count of all sent and received.

Delete/Delete all: delete the current number/ all the numbers.

7 Entertainment

Music player

With the music player you can play audio files stored in the phone or memory card. In music player, press **LSK** to select from the following options:

Play via Bluetooth: switch the sound from phone to Bluetooth headset when the Bluetooth headset has been matched.

Playlist: open to view all audio files in current playlists.

My playlist: from here you can add, rename and delete playlists as needed.

All music: list the entire audio files.

Play mode: set the play mode to Once, Repeat track, Original play, Repeat all and Random.

Equalizer: set the equalizer to Normal, Pop, Rock, Jazz, Classic, Define1, Define2 or Define3 play modes. The Define1, Define2 and Define3 can be edited.

Visual effects: set the visual effects to none (standard), Spectrum analysis or Night vision

Minimize: hide the Entertainment but will continue playing in the background while other applications are running.

Set as ring tone: set the playing audio file as ringtone for voice call ring, video call ring or message ring.

Send: send the selected audio file via MMS/E-mail/Bluetooth.

Property: open to view the property of music file being played.

Video player

With the video player you can play video files stored in the phone or memory card. In video player, press **LSK** to select from the following options:

Play via Bluetooth: switch the playing sound from phone to Bluetooth headset when the Bluetooth headset has been matched.

Playlist: open to view all video files in current playlists.

My play list: from here you can add, rename and delete playlists as needed.

All video: list the entire video files.

Full screen: playing the video in full screen mode.

Play mode: set the play mode to Once, Repeat track, Original play, Repeat all and Random.

Mute audio: set Mute/Unmute audio. When the status is **Mute audio**, it should display **Unmute audio**.

Send: send the selected video file via MMS/E-mail/Bluetooth.

Property: open to view the property of the file being played.

Voice recorder

Select voice recorder press **LSK** to select from the following options:

Record time: set recording time, when recording is over or when **OK** key is pressed to stop, the recording will save automatically.

My recordings: open the recordings folder to view recordings.

Games

To add richness to your entertainment life, the phone provides some fun games. Please get more information in the instructions of the phone.

Java box

The Java box feature enables you to install a Java application to your phone, view the Java applications currently installed on the phone or remove Java applications which you no longer want.

FM radio

To listen to the FM radio, you must plug in the headset first. In the FM radio screen, press left/right navigation key to change stations in sequential order; press up navigation key to enter my favorite list; press

down navigation key to switch and select the search mode from Manual, Favorite or Automatic. By using the **LSK** you can do the operation as follows:

Save: save the current channel to my favorite list.

My favorite: view the saved channels in the list. You also can edit or add new channels.

Search Mode: set the search mode as Manual, Favorite or Automatic.

Shortcut key setting: assign a key to a designated channel and press the shortcut key to play the predefined channel.

Minimize: exit the FM radio screen and the FM radio continues playing in the background.

8 Message

SMS

New: create a new SMS message and send or save it.

Inbox: you can view the received SMS messages.

Drafts: store incomplete SMS messages that you can finish later.

Outbox: store the SMS messages that are pending to be sent.

Sent: store the SMS message that sent successfully according to the settings.

SMS templates: you can create a new template; you also can edit or delete existing templates.

Voice mail: receive voice messages when you are unable to answer. Please contact your service provider to get the voice mail box number.

Settings: set the correlative parameter for SMS message, such as service center, date of expiry, delivery reports, broadcast and so on.

SMS counter: note the counter of total sent and total received.

Memory status: view the memory status of the SIM and Phone.

MMS

New: create a new MMS message and send or save it.

Inbox: you can view the received MMS messages.

Drafts: store the incomplete MMS messages that you can finish later.

Outbox: store the MMS messages that are pending to be sent.

Sent: store the MMS message that sent successfully according to the settings.

Folders: store the MMS message that moved to the created folder.

MMS templates: you can create a new template; you also can edit or delete existing templates.

Settings: set the correlative parameter for MMS message, such as

profile, send, receive, edit and view mode.

E-mail

New: create a new E-mail and send or save it.

Inbox: you can view received E-mails.

Drafts: store incomplete E-mails that you can finish later.

Outbox: store the E-mail messages that are pending to be sent.

Sent: store the E-mail that sent successfully according to the settings.

Settings: you can edit, rename, delete and create account. Set the correlative parameter for E-mail, such as user information, connection, and message preference.

Accounts: several accounts can be stored and you can select one as the default.

Push messages

In push messages, you can view or delete saved push messages.

9 Videophone

Video call: input number and press **LSK** can dial out video call.

Screen mode: select the display mode of video call, such as: minimize myself, maximize myself, display other person only, display myself only.

Video settings: you can send live video, an image or a video clip to the other party via selecting live video, substituted picture or substituted video.

Image quality: you can adjust the image quality of the caller and the calling party.

Color mode: you can adjust the color of the image or video from Default, Sepia, or Black&white.

Video settings: you can send your live video, substituted picture or substituted video to the remote party.

Voice auto switch: set the function of voice auto switch on/off.

10 Camera

By using the **LSK** and the navigation key you can view the following options:

Switch camera: you can use navigation key to switch between photo and video modes to take pictures and videos.

Image size/Video size: set the size of the image/video that will be captured.

Quality: set the quality of the photo/ video.

White balance: set the white balance state.

Effects: put effects in the pictures taken.

Night mode: set night mode on/off.

Shutter sound: set shutter sound on/off.

Shooting mode: set normal, continuous or self-timer as the shooting mode.

Screen direction: set the display mode of screen.

My photos/My videos: enter pictures or videos in my files to view the photo or video.

11 Tools

Alarm Clock

There are 3 alarms in your phone. The functions and using methods are completely the same. You can set to turn on/off respectively.

Set alarm

Select an alarm, enter the settings interface of this alarm, you can start or stop this alarm, and set the time, repeat frequency of the alarm, at the same time, and more.

Alarm remind

When the alarming sets off, there is an alarm notice in the handset (refer to alarm settings).

If the mobile phone is in power off state, after the alarm sets off, bring up the power on confirmation interface, and you can select power on or not.

Schedule

Enter schedule interface, the current month calendar is displayed and the current date has a frame around the number with special mark.

Activate **LSK**, and you can operate as follows:

New: create a new calendar entry.

Select date: switch the date that needs to be changed (in a valid period of time), the selected date will be displayed.

List: display a list of appointments and events.

Memory status: display the number of used and free storage for schedule entries.

Calculator

The calculator performs four operations as addition, subtraction, multiplication and division. Enter the calculator interface, you can input numbers directly and press the navigation key to switch between the operations needed, and then start calculation.

When the calculation of dividing 0 overflows, the result is larger than 999999999 or less than -999999999, the mobile phone will display the error message as “E”.

Doc. Editor

View the document file that stored in Phone and T-flash card.

Notes

You can make and save notes on your phone.

To-Do

This function is used for adding and viewing task items. You also can edit or delete the existing tasks from the list.

World clock

Enter world clock interface, you can switch the city by using the navigation key, you also can use the **LSK** to select your home city.

In the city list, you can quick search the city by inputting the first letter of the city.

Stopwatch

Enter stopwatch, press the **OK** key to begin timekeeping, and press **OK** key **each time** to split records. Press **RSK** to stop the recording, press **LSK** to reset the record. Maximum number of records is nine.

Countdown timer

Enter countdown timer then press Numeric keys to set times, then press **OK** key to edit fields, and the countdown begins. When the set time is up you will hear bell sounds. Countdown can run in background.

Currency exchange

Enter currency exchange, set the base currency in the **From** field then set the other currency in the **To** field. Input the exchange rate in the **Rate** field; Input the amount to be converted. Press **OK** key to get the result of the conversion.

12 Settings

Phone

Time and date: you can modify the local time, date, time format, date format, activate/deactivate the DST (Daylight Saving Time), you also can set hide or show local time and date and destination time and date.

Language: you can set the language of the phone.

Shortcut key: separately assign an application to the left selection key and right selection key.

Automatic keylock: when the phone is in standby status not operated for a certain period of time (preset), the keypad will be locked automatically after the set time. Then the standby interface will show keypad locked icon. At the right bottom corner of the screen, the word **Unlock** will appear. If you need to unlock the keypad, you only need to press **LSK**, and operate according to relevant interface prompts.

Schedule Power On/Off: after setting and activating this function, the mobile phone will be automatically powered on/off on the set time.

Memory status: shows the information of used and free space in the phone and T-flash card.

Phone profiles

Phone Profiles are a group of preset sound settings. You can also change and save other settings in the profiles according to your own preference. The phone provides a set of default profiles including Normal mode, Meeting mode, Outdoor mode, Driver mode, Flight mode. The default profile is Normal mode. If you opt to use a different profile, a corresponding icon will be displayed at the top of the idle mode screen. Select the phone profile that you wanted, press **OK** key to activate it. You also can press LSK to do the operation as following:

Edit phone profiles: set the parameters under different profiles, such as ring volume, message volume, ring tone, ring type, keypad volume, low battery tone, vibration pattern and ring/vibration.

Timed: mark the profiles effectively in a particular time, you can set the time (within 24 hours), when the set period is over, the profile will return to the current profile.

Display

Enter the display interface, you can operate as follows:

Greeting: you can set a text or animation to be displayed when you power on your phone. Select **Animation** to use the default animation, **Text** to write a welcome note, or **No greeting** to disable this feature.

Wallpaper: you can choose an image from the My Files pictures folder to set as wallpaper in the standby mode.

Themes: you can select theme 1 or 2 as the theme for the phone.

Main menu style: set the style of the main menu as list or matrix mode.

Active standby apps.: connect the applications to certain shortcut keys to be used in standby mode.

Power saving: set the brightness and timer for backlight.

Font size: set the font size of the phone.

Calls

Enter the calls interface, you can operate as follows:

Call divert: you can set voice call divert, video call divert, fax call divert separately, and you also can set all call types divert to divert all calls.

Note:

If the transfer call you set up is a fixed phone, please include the area code of the fixed phone.

Call waiting: you can set the function on/off and can query status of the call waiting. After the function is set on, if you have a new incoming call while in calling process, your phone will prompt the calling interface, and the call can be received normally. If the function is set off, new incoming calls can not be displayed.

Call barring: you can set barring voice call or video call. This function needs network support. Please contact your network provider to open this feature. Network provider will provide the corresponding network password for you to activate the call barring service.

Caller ID: this network service allows you to select whether your phone number should be displayed or hidden from the person who you are calling.

Any key answer: set the function on to enable you to answer the incoming call by pressing any key, except the **RSK**, **End** key, **Pwr** key, **OK** key.

Auto redial: turn on/off auto redial function. If the function is set on, when the phone makes an outgoing call and the other side is unable to answer, then the phone will auto redial the number for a maximum of seven times. You can cancel dialing the current number when calling.

Headset auto answer: set the function on to enable your phone to answer the incoming call automatically after five seconds when you are using a headset.

IP number setting: you can create a list of prefix name and prefix numbers that are used for IP dial.

Alert tone: you can set the tone of connection or minute alert on/off.

Firewall: you can view, edit, add from phone book, delete, delete all the record in blacklist/whitelist; you also can set select blacklist, whitelist, unknown incoming call barring from **Mode**. If set the blacklist mode on, the number in the list is blocked; if set the whitelist mode on, only the number in the list is allowed to dial in; if set to unknown incoming call

barring on, the number that is not stored in the phone book is blocked; set to off to remove the Firewall.

Security

Enter the security interface, you can operate as follows:

PIN activate: the function can prevent others from using your SIM card without your permission. After the SIM card PIN code is activated, correct PIN code must be inputted every time when the mobile phone is powered on; otherwise you can only make emergency calls.

Note:

PIN code is the operating password giving access to the SIM card. The SIM card will be locked, if incorrect PIN code is entered for 3 consecutive times. When locked, you will need the PUK code to unlock the SIM card. The PUK code may be provided for you together with the PIN code and the SIM card. If not, please contact your network provider.

Change PINs: if the PIN/PIN2 is activated, you can change the current PIN and PIN2 through the system prompts.

Power on lock: set the function on and input the security code correctly, correct security code must be inputted every time when the phone is powered on.

Phone lock: input the correct security code to lock the phone to stop others from using it or to prevent keys from being pressed accidentally.

Change security code: you can change the security code through the system prompts.

Fixed numbers: set the function on, the phone with the current SIM card is only allowed to be used to dial the telephone numbers existing in the list. To turn on the function, you need to input your PIN2 code. Please consult with your network service provider for more details.

Privacy guard: if activated, the phone will ask for a security code before you can access the applications that you set to be privacy guarded.

Network

Enter the network interface, you can operate as follows:

Search type: you can select automatic or manual type for searching.

New search: re-search for an available network and manually select the network you want to use.

Preferred network: the list of networks in your SIM card defines the order of preference in which your phone will select a network in

automatic mode. Enter the individual networks in your own preferred order and store them in your SIM card.

Network mode: you can set the network mode as automatic, WCDMA only or GSM only.

Videophone

See chapter 9 of the Manual.

Data profiles

12.1.1 Internet profile

Enter the internet profile, you can operate as follows:

Web Browser profile: you can select the correct profile for web browser.

MMS profile: you can select the correct profile for MMS.

12.1.2 Data profile

Enter the data profile, you can operate as follows:

Edit data profile: you can select and edit the name and APN for the corresponding profile that you selected in the profile list.

Select data profile: you can select the corresponding profile for MMS, Java box, Internet, E-mail and Streaming.

Restore factory settings

Select this function to restore your phone's settings to factory settings.

Clear all

Select this function to delete all data and cancel all settings previously made on your phone. It is important to backup your data to the memory card or your computer if clear all has to be performed.

13 Connectivity

Bluetooth

Enter into Bluetooth menu interface, you can operate as follows:

Bluetooth status: turn on/off the Bluetooth function. When Bluetooth function is turned off, all Bluetooth connections are suspended, you can not transmit and receive data by using Bluetooth. Please turn off the Bluetooth function when your phone is used for other operations, because Bluetooth connection will consume the battery power.

Paired devices: select **Search for device** to find the device that is in range and in visible status. When you pair your phone with other device in the list, you agree on a shared password for both devices to be used.

Active device info: displays the information of the connected device, such as: device name, bluetooth address, device type and so on.

My phone's visibility: you can set the status for your phone as shown to all or hidden.

Own device info: show the related service information of the Bluetooth device, including: device name, Bluetooth address and so on.

Packet data connection

You can select the packet data connection mode as **When needed** or **Always online**.

PC synchronization

You can use the PC Suite/Tools to connect your phone with the PC and perform the following:

Contact: synchronize your phone's contacts by importing or exporting contacts to/from your PC.

Calendar: synchronize your phone's calendar by importing or exporting the calendar to/from your PC.

Ringer: import or export the music file between PC and phone.

Picture: import or export the picture between PC and phone.

Movie: import or export the movie between PC and phone.

File: import or export the file between PC and phone.

SMS: import the sms from phone or create new sms in PC.

Internet: access the internet by snapdialer.

Before connecting to your PC, you should install the PC Suite/Tools. Please follow the on-screen guide on your PC when installing the PC Suite/Tools. Before running the PC Suite/Tools, your phone must enter the PC synchronization mode and stay "Waiting for connection with PC..." screen (except the dialing-up to internet function), the PC Suite/Tools software can run normally.

Backup to T-Flash

Backup user data to T-flash card, including contacts, SMS, MMS, Email, gallery, etc.

Restore from T-Flash

Restore the backup data from T-flash card to the phone.

14 Internet

Prior to using the Internet, the following settings must be carried out first:

Apply for WAP services; contact your network service provider for specifics of WAP services. Make necessary WAP settings on your mobile phone by referring to the data and proxy settings.

Enter internet interface, you can operate as follows:

Enter Address: input the website that you want to access.

Search Google: use the google as the engine for searching according to the settings.

Home Page: you can access the internet of an assigned URL set as home page in the browser profile.

My Bookmark: my bookmark is used to save the websites that you set as favorites.

History: display the address list of websites recently browsed.

Saved Pages: shows the list of pages you have selected to be saved.

When highlighting home page, my bookmark or history, use the **LSK** enter the settings screen, you can select search engine or delete temporary files, you also can set the parameters of load content, look and feel, security, browser profile.

15 SIM Tookit

This function is provided by the network operator. According to the services provided by the SIM card, there will be different options appearing in this directory. The name and content of the menu are based entirely on the services provided by the network operator. For more information, please contact your network operator.

16 Frequently Asked Questions

The mobile phone can not be powered on

■ The mobile phone can not be powered on since the battery voltage is too low. Please recharge the battery.

Unable to make calls

■ Call barring has been set and barred utilization of the mobile phone. Please check and cancel call barring.

Other person is answering my call

■ The mobile phone has been set into divert your calls to another phone number. Please check and cancel call divert.

The mobile phone can not connect to the network

■ The mobile phone is outside of the network coverage area (or there are physical obstacles between the mobile phone and the transmitter), and calls can not be made or answered. If you are in one room, please move closer to the window.

In the operation process, the mobile phone may display the following operating tips:

“Emergency”

■ You must insert the SIM card before using the mobile phone. If the SIM card has been inserted, please take it out and wipe clean with a dry cloth on the gold metal part, and then insert the SIM card. Or you are outside the network coverage area of the service provider. But another network found will allow you to make emergency calls with sufficient signal strength.

“Invalid SIM”

■ The SIM card of the mobile phone is locked and the inserted SIM card is unable to be accepted. Please insert the correct SIM card or contact your network provider.

“Please Enter PUK”

■ The SIM card has been locked since the wrong PIN code has been inputted three consecutive times. You must consult your network provider for special PUK code with eight numbers to unlock the SIM card (The PUK code may have been provided with your PIN code at the same time).

Warning:

The SIM card will be permanently locked if you input the wrong PUK code for ten consecutive times then you must apply for a new SIM card from your network provider.

RF Exposure Information and Statement

The SAR limit of USA (FCC) is 1.6 W/kg averaged over one gram of tissue. This model (FCC ID: WA6S810) has also been tested against this SAR limit. The highest SAR value reported under this standard during product certification for use at the ear is 0.699 W/kg and when properly worn on the body is 1.173 W/kg. This device was tested for typical body-worn operations with the back of the handset kept 1.5cm from the body. To maintain compliance with FCC RF exposure requirements, use accessories that maintain a 1.5cm separation distance between the user's body and the back of the handset. The use of belt clips, holsters and similar accessories should not contain metallic components in its assembly. The use of accessories that do not satisfy these requirements may not comply with FCC RF exposure requirements, and should be avoided.

This device complies with the FCC HAC requirements has also been tested E-Field, H-Field and T-Coil, the worst test result of M rating is M3, the T rating is T3.

This device complies with part 15 of the FCC rules. Operation is subject to the following two conditions: (1) this device may not cause harmful interference, and (2) this device must accept any interference received, including interference that may cause undesired operation.

NOTE: The manufacturer is not responsible for any radio or TV interference caused by unauthorized modifications to this equipment. Such modifications could void the user's authority to operate the equipment.

NOTE: This equipment has been tested and found to comply with the limits for a Class B digital device, pursuant to part 15 of the FCC Rules. These limits are designed to provide reasonable protection against harmful interference in a residential installation. This equipment generates uses and can radiate radio frequency energy and, if not installed and used in accordance with the instructions, may cause harmful interference to radio communications. However, there is no guarantee that interference will not occur in a particular installation. If this equipment does cause harmful interference to radio or television reception, which can be determined by turning the equipment off and on, the user is encouraged to try to correct the interference by one or more of the following measures:

- Reorient or relocate the receiving antenna.
- Increase the separation between the equipment and receiver.
- Connect the equipment into an outlet on a circuit different from that to which the receiver is connected.
- Consult the dealer or an experienced radio/TV technician for help