

GB: Operating instructions

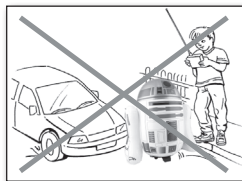

Not to scale

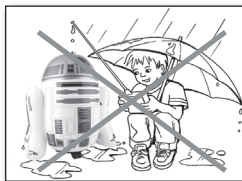

⚠ WARNING

- Dispose of the 2x AA batteries included before operating the product.
- DO NOT operate the product using these batteries.
- DO NOT mix old and new batteries. DO NOT mix alkaline, standard (carbon-zinc), or rechargeable (nickel-cadmium or nickel-metal hydride) batteries.

GB:

To obtain the result we recommend using only alkaline batteries!

Product specification, colours and contents may vary.

Warranty covers manufacturers faults only and not damage caused by user error.

Any damage caused by accident, negligence or improper use is in no way covered by the manufacturer. Any change or modification to the product will void any warranty.

Please retain this information for future reference.

Bladez Toyz, Portsmouth Technopole, Kingston Crescent, Portsmouth, PO2 8FA, UK.

www.bladeztoyz.com / support@bladeztoyz.co.uk / +44(0) 2392 658 255

Declaration of Conformity

Hereby, Bladez Toyz Ltd, declares that this item is in compliance with the essential requirements and other relevant provisions of Directive 1999/5/EC (R&TTE).

The original declaration of conformity can be viewed on the internet at the following URL: www.bladeztoyz.com/doc

Conforms to product safety standard ASTM F963-08 and EN71 regulatory requirements.

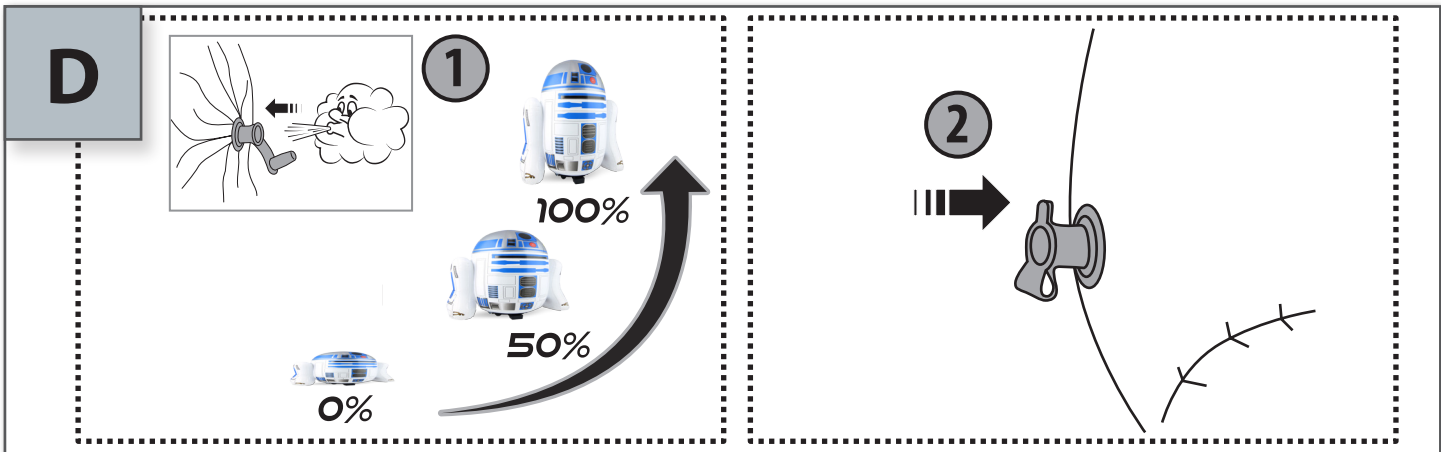
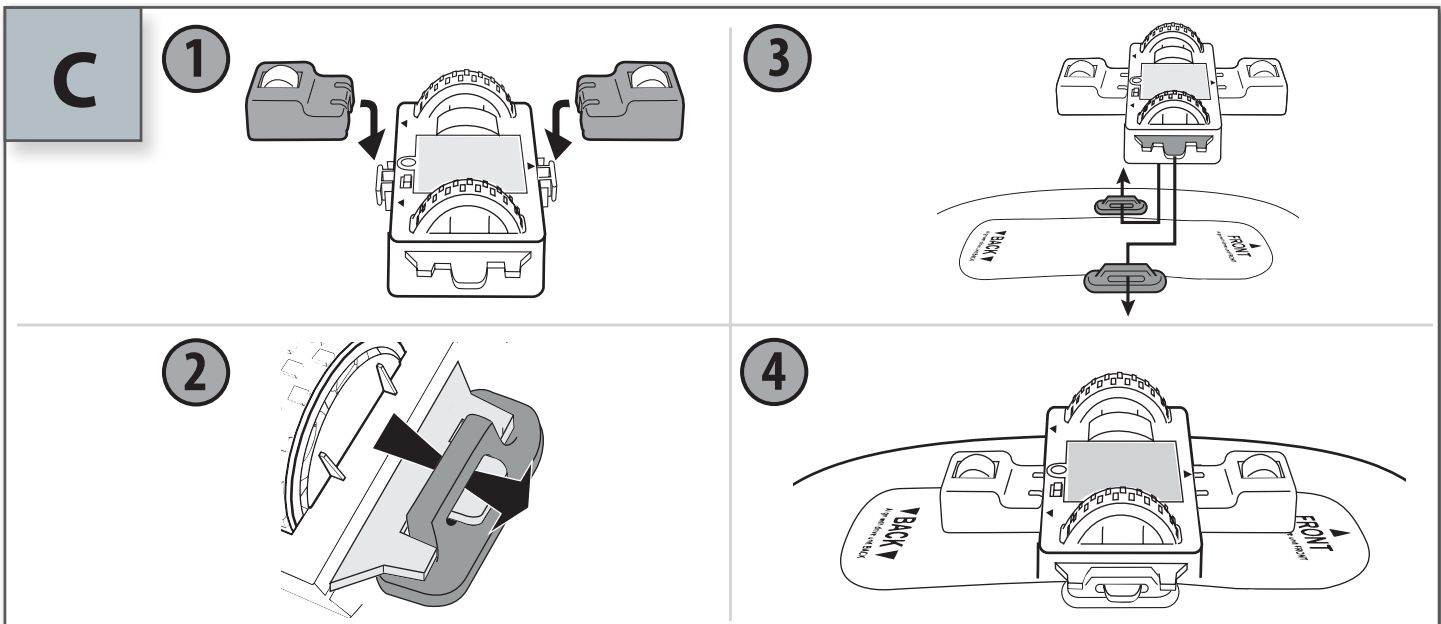
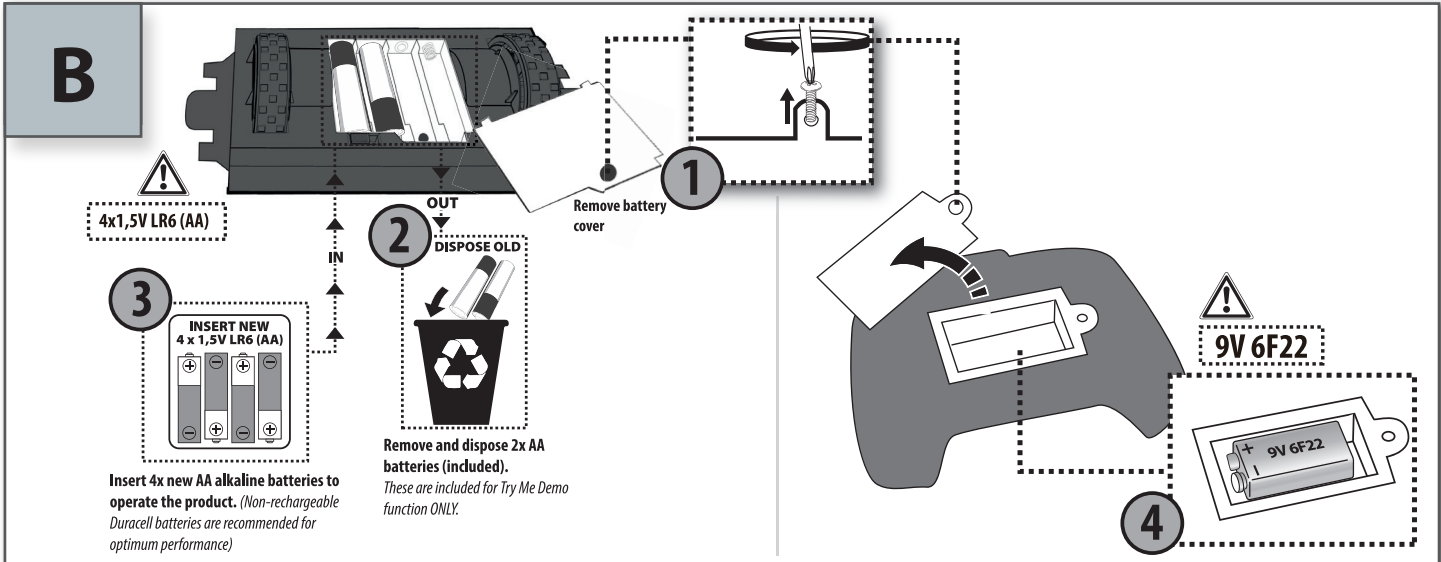
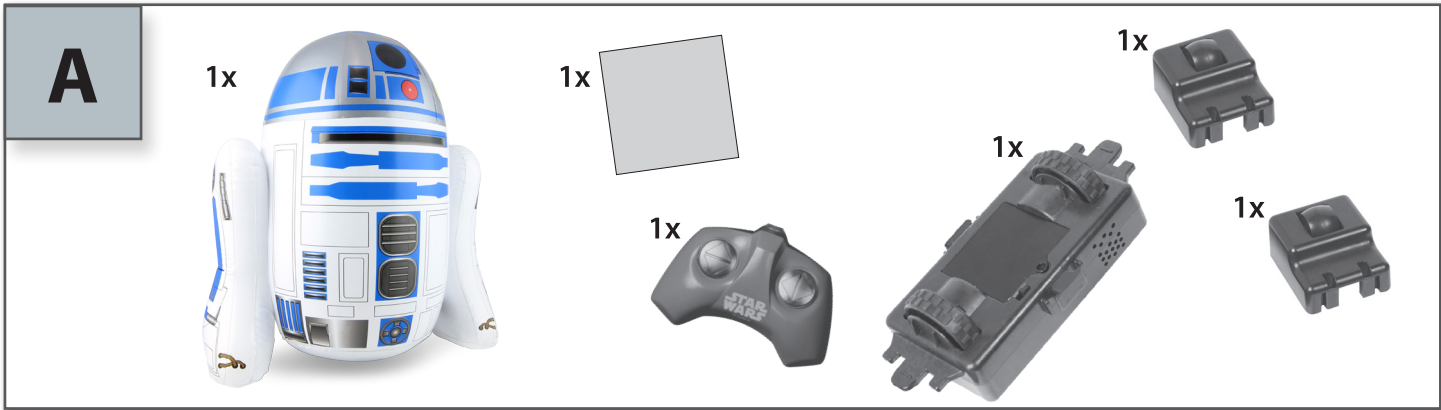

E

1

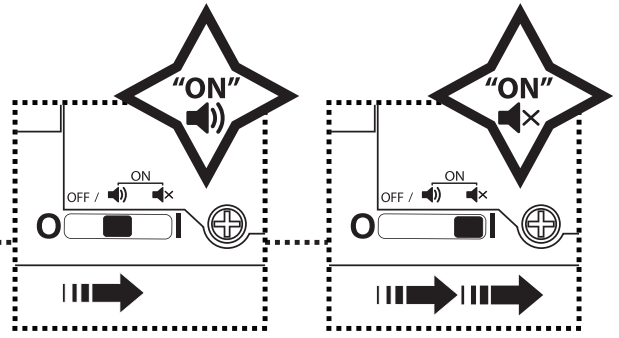
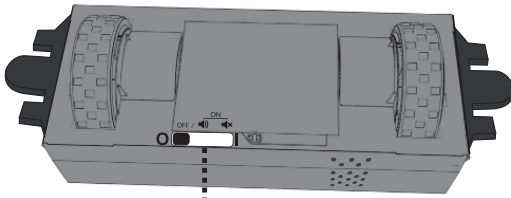

2

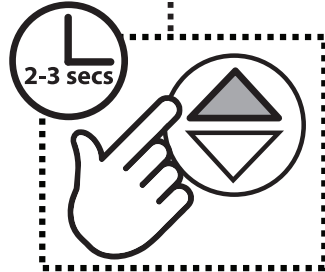
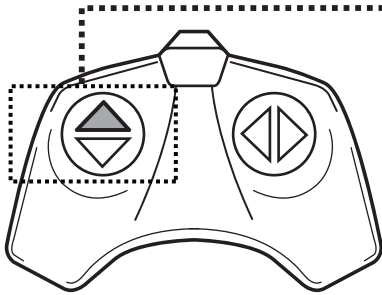

F

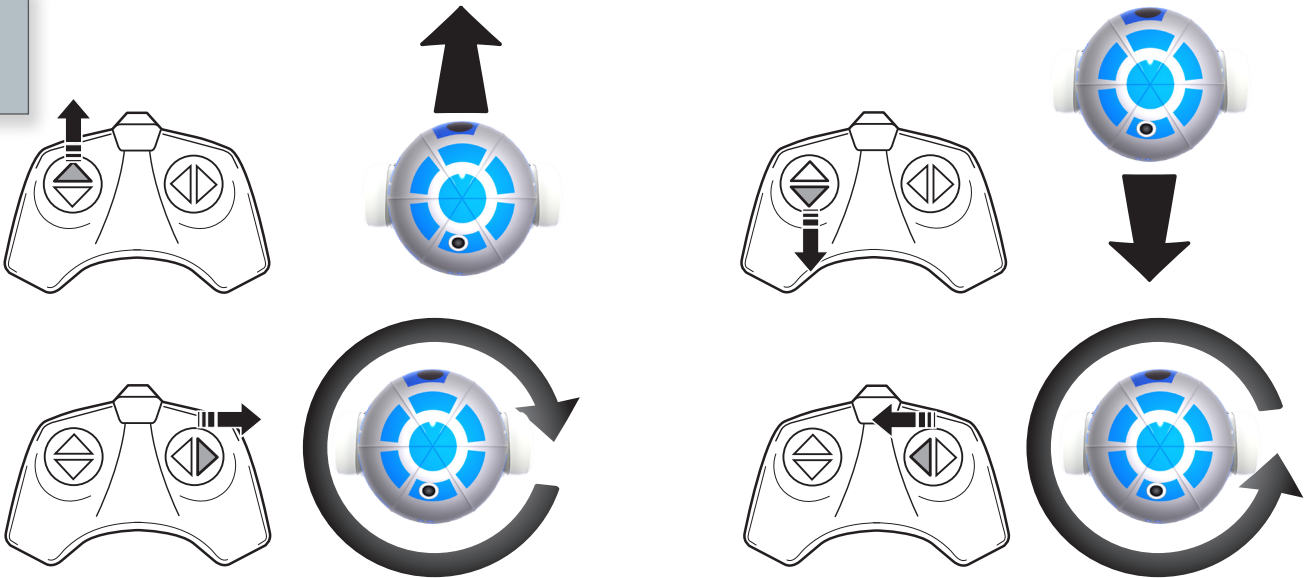

G

Multiplayer setup



Player 1 READY



Player 2
Repeat steps A - E



H

1

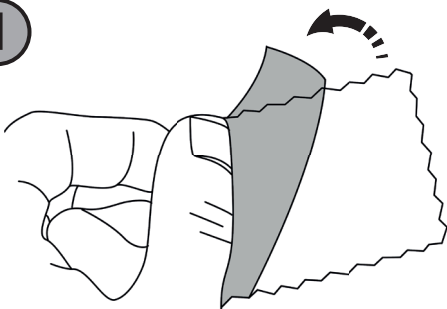

2

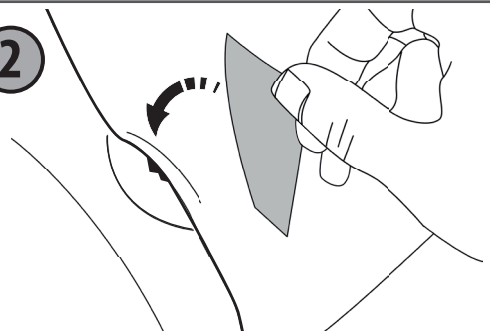

A**Contents included****B****Opening the battery compartment and insert the batteries**

1. Unscrew battery compartment.



2. Dispose of 2x 1.5V AA batteries included. These batteries are included for demo "try me" function **ONLY**. **DO NOT** operate product using these batteries.

3. Insert 4x new 1.5V AA batteries. For optimum performance we recommend non-rechargeable alkaline batteries are used.

4. Insert 1x 9V 6F22 battery into handset.

C**Attach radio control drive unit and stabilisers to inflatable body (adult assembly required)****D****Inflate /Deflate the inflatable body****E****Switch on**

1. Slide switch on drive unit to the right to select the desired mode:

-  - ON with sound FX. Sound FX are motion activated.
-  - ON without sound FX.

2. Press and hold forward button for 2-3 seconds. After 2-3 seconds the handset and drive unit are fully synchronized and ready to use.

N.B. Low battery power may cause the handset and drive unit to de-synchronize.

N.B. This R/C drive unit has an electronic protection mode. It will shut down automatically after approximately 15 minutes if it is left ON without use. To reset, turn drive unit OFF (O) and ON (I) again.

F**Vehicle operation****G****Multi - player setup**

Operate up to a maximum of 10 players at the same time. Each player must be setup individually.

1. Ensure player 1 is setup and ready.

2. Wait 10 seconds.

3. Repeat steps A - E for each player consecutively.

N.B. DO NOT setup more than one player at the same time. If you try to setup multiple players at the same time the product may not operate correctly due to interference.

H**Repair**

- Inflatable must be completely deflated before repairing punctures.
- Cut out a suitable size patch, and ensure the corners are rounded to avoid peeling.
- Ensure puncture area is clean, then press patch over the puncture firmly.
- Once the puncture has been repaired, do not inflate for 20 minutes.

Features

- Radio control vehicle
- 7 driving functions: forward-left-right backward-left-right, stop
- 2.4GHz

GB**Precautions (Please retain!)**

- **WARNING!** Not suitable for children under three years. Risk of choking due to small parts that may be swallowed! Please keep this packaging information for any possible correspondence. Subject to technical change and change of colour. Adult help is required to remove the securing devices.
- Never lift the vehicle up while the wheels are still turning.
- Keep fingers, hair and loose clothing clear from the motor or wheels when the vehicle is switched to "ON".
- To prevent accidental operation of the vehicle, batteries and power packs must be removed from the toy when not in use.
- Wires are not to be inserted into socket-outlets.
- Do not over-inflate the body. Over-inflation can cause the inflatable body to puncture.
- Inflation and set up of product must be carried out by an adult - keep away from children.
- Do not sit on inflatable, it is not a ride-on toy.
- Do not use a high pressure pump.
- Never use any hard/ sharp objects to assist with inflation and assembly of product.
- Do not pinch, drive over broken glass, bushes, or any environment with risk of puncture to inflatable.
- Do not drive over or near hot surfaces, radiators, fire, or any environment that may cause heat/burn damage to the product. Keep product away from all sources of heat.
- Do not use in water. This is not an aquatic toy.
- Interference with the radio signal can restrict the product from working.

**Battery information**

- Requires 4x AA (LR6) batteries for the drive unit. Not Included.
- Requires 1x 9V (6LR61) battery for the handset. Not Included.
- Manufacturer makes no guarantee as to demonstration of battery life.
- Non-rechargeable batteries are not to be recharged.
- Non-rechargeable alkaline batteries are recommended.
- If used, rechargeable batteries are to be removed from the toy before charging.
- If used, rechargeable batteries are only to be charged under adult supervision.
- Do not mix old and new batteries.
- Do not mix alkaline, standard (carbon-zinc), or rechargeable (nickel-cadmium or nickel-metal hydride) batteries.
- Only batteries of the same or equivalent type are to be used.
- Always remove exhausted or dead batteries from the product.
- Consumer is responsible for replacement of batteries.

Battery installation or replacement

- Batteries should be installed or replaced by an adult only.
- Remove screws to open battery compartment covers to install and replace batteries.
- Batteries are to be inserted with the correct polarity.
- The supply terminals are not to be short-circuited.
- Replace battery compartment covers and screws.
- Dispose of batteries safely.
- Do not dispose of batteries in fire. Battery may explode or leak.

Ensure the correct positive (+) and negative (-) polarities with the corresponding markings are followed. For best performance, Alkaline batteries are recommended. Other types of batteries such as carbon-zinc, or rechargeable (NiCd or NiMH) batteries may cause erroneous responses and not function correctly. If the battery level gets too low that the driving wheels spin slowly, replace the batteries immediately.

?**The vehicle does not work**

- Position the switch on the vehicle to "ON".
- Have the batteries/power packs been inserted correctly?
- Are the battery contacts bent or dirty?
- Are the batteries discharged or defective?
- Is battery power fading?
- Are any other remote control devices close by which might be transmitting on the same frequency?
- Is interference being caused by metal railings or fences?
- Transmitter or power masts often cause the model vehicle to behave in an uncontrolled manner.
- Are there walkie-talkies or CB radios in the vicinity that might cause interference?

**Warning:**

The manufacturer is not responsible for any radio or television interference which might be caused by unauthorised modifications to this equipment. Modifications of this nature may invalidate the user's consumer rights.

FCC**FCC/EMC Requirements**

This product conforms to the product safety standards ASTM F963-08 and EN71 regulatory requirements.

This device complies with part 15 of the FCC rules. Operation is subject to the following two conditions: (1) This device may not cause harmful interference, and (2) this device must accept any interference received, including interference that may cause undesired operation.

This device has been tested and found to comply with the limits for a Class B digital device, pursuant to part 15 of the FCC Rules. These limits are designed to provide reasonable protection against harmful interference in residential use. This device can radiate radio frequency energy that may cause harmful interference to radio communications. If this device does cause harmful interference to radio or television reception, which can be determined by turning the device off and on, the user is encouraged to try to correct the interference by one or more of the following measures:

- Reorient or relocate the receiving antenna.
- Increase the separation between the device and receiver.
- Connect the equipment into an outlet on a circuit different from that to which the receiver is connected.
- Consult the dealer or an experienced radio/TV technician for help.

Warning: Changes or modifications to this unit not expressly approved by the party responsible for compliance could void the user's authority to operate the equipment.

If at any time in the future you should need to dispose of this product please note that waste electrical products should not be disposed of with household waste. Please recycle where facilities exist. Check with your local authority or retailer for recycling advice (Waste Electrical and Electronic Equipment Directive).



Please keep these instructions for future reference as they contain important information.

Online

Share a photo or video of your R2-D2™ with the Bladez team for your chance to win prizes!*



#bladeztoyz
@bladeztoyz



facebook.com/BladezToyz
competition@bladeztoyz.com

Also available at bladeztoyz.com

- New products
- Order spare parts
- Videos
- Product information

*Terms and conditions apply. Visit www.bladeztoyz.com for full terms and conditions.

Talk to the team

Call: +44 (0) 2392 658 255

Email: support@bladeztoyz.co.uk

Write: Bladez Toyz Ltd, Portsmouth Technopole, Kingston Crescent, Portsmouth, PO2 8FA, UK