

## Product overview

The VT7300 PI thermostat family is specifically designed for fan coil control. The product features a backlit LCD display with dedicated function menu buttons for simple operation. Accurate temperature control is achieved due to the product's PI proportional control algorithm, which virtually eliminates temperature offset associated with traditional, differential-based thermostats.



Models are available for On/Off, 3 point floating and analog 0 to 10 Vdc control and can control up to three fan speed. Three additional inputs are also provided for monitoring and / or various advanced functions.

All models feature configurable System and Fan button functions to meet all possible applications. They all contain an SPST auxiliary switch that can be used to control lighting or auxiliary reheat.

The thermostats are also compatible with the new Viconics PIR cover accessories. Thermostats equipped with a PIR cover provide advanced active occupancy logic, which will automatically switch occupancy levels from Occupied to Stand-By and Unoccupied as required by local activity being present or not. This advanced occupancy functionality provides advantageous energy savings during occupied hours without sacrificing occupant comfort. All thermostats can be ordered with or without a factory installed PIR cover ( see ordering notes below ).

The additional following documents are available at: [www.viconics.com](http://www.viconics.com)

- PIR application information and examples, are available on document: *APP-PIR-Guide-Exx*
- PIR cover installation information is available on document: *PIR Cover Installation-Exx*
- Information on the LON models (VT73xxX5000E), is available on document *ITG-VT7300-PIR-LON-Exx*
- Information on the BACnet models (VT73xxX5000B), is available on document *ITG-VT7300-PIR-BAC-Exx*
- Information on the Wireless models (VT73xxX5000W), is available on documents: *ITG-VWG-40-BAC-Exx* and *LIT-VWG-40-SETUP-Exx*

## Models available

Viconics Part Numbers	VT7300A5000(X)	VT7300C5000(X)	VT7350C5000(X)	VT7305A5000(X)	VT7305C5000(X)	VT7355C5000(X)	VT7300F5000(X)	VT7350F5000(X)	VT7305F5000(X)	VT7355F5000(X)
Application	2 & 4 Pipes On/Off	2 & 4 Pipes Floating & On/Off		2 & 4 Pipes On/Off	2 & 4 Pipes Floating & On/Off		2 & 4 Pipes Analog 0-10 Vdc			
RH sensor	No	No	Yes	No	No	Yes	No	Yes	No	Yes
Market	Commercial / Institution			Hotels / Lodging			Commercial / Institution		Hotels / Lodging	

### Ordering Information Notes:

- (X) model number represents available communication options: **X=none** for Stand-alone, **X=B** for BACnet MS-TP, **X=E** for Echelon and **X=W** for Wireless
- Thermostats can be ordered with a factory installed PIR cover. Please use (5500) extension instead of the (5000) only extension.: Ex. VT7300C5500E.
- Thermostats ordered without a PIR cover can be retrofitted with a separate PIR accessory cover afterwards when required

## Features and benefits

Features	Benefits
• Models available with internal humidity sensing	⇒ Increased occupant comfort through dehumidification
• Advanced occupancy functions	⇒ Through the network or smart local occupancy sensing
• Ready for PIR accessory cover	⇒ Fully integrated advanced occupancy functionality with a PIR accessory cover
• 3 configurable inputs	⇒ Adds functionality
• Configurable sequences of operation	⇒ Single model meets more applications
• Configurable fan functions button	⇒ Meets more applications with a single model
• Unique configuration setup utility	⇒ Minimizes parameter tampering
• Multi level lockable keypad	⇒ Tamper proof, no need for thermostat guards
• Auto Fan speed mode	⇒ Increased occupant comfort in cooling mode by reducing humidity and offer less fan noise in all mode of operation
• Available for 24 Vac On/Off, Floating or Analog control	⇒ Meet advanced applications requirements
• Auxiliary output	⇒ Can be used for lighting or reheat

## Programmable BI/UI inputs overview

### Binary input #1 can be configured for the following functions:

1. **(None):** No function will be associated with the input
2. **(Rem NSB):** remote NSB timer clock input. The scheduling will now be set as per the binary input. It provides low cost setback operation via a dry contact
  - Contact opened = Occupied
  - Contact closed = Unoccupied
3. **(Motion NO) and (Motion NC):** Advanced PIR occupancy functions using a Normally Open (NO) or Normally Closed (NC) remote PIR motion sensor. Occupancy mode is now set as per applied PIR function and configuration. Application information and examples, are available on document: *APP-PIR-Guide-Exx*. This document will provide the installers and system designers with detailed examples on applications, parameter configuration information, sequence of operation, troubleshooting and diagnostic help required for the proper usage of the PIR accessory covers
4. **(Window) EMS:** Forces the system to disable any current heating or cooling action by the thermostat. The mode stays the same and the current setpoints are the same Occupied setpoints. Only the outputs are disabled. There is a Door/Window alarm displayed on the thermostat to indicate to the local tenant that the door/window needs to be closed for cooling or heating to resume. Use NC contact.
  - Contact opened = System disabled with local Window alarm
  - Contact closed = System enabled

### Binary input #2 can be configured for the following functions:

1. **(None):** No function will be associated with the input
2. **(Door Dry) Door contact & Motion detector:** This configuration is only functional if binary input #1 is set to **Motion NO** or **Motion NC** or a **PIR accessory cover** is used.  
With this sequence enabled, the occupancy is now dictated through those 2 inputs. Any motion detected will set the zone to occupied status. The zone will remain permanently in occupied mode until the door contact switch opens momentarily. The thermostat will then go in stand-by mode. If more movements are detected, the occupied mode will resume. While the door is opened, any movements detected by the remote PIR sensor or the PIR accessory cover will be ignored. Use a Normally Closed contact switching device.
  - Contact opened = Door opened
  - Contact closed = Door closed

3. **(RemOVR):** temporary occupancy remote override contact. This function disables the central button override function on the thermostat. The override function is now controlled by a manual remote momentarily closed contact. When configured in this mode, the input operates in a toggle mode. It is now possible to toggle between unoccupied & occupied setpoints for the amount of time set by parameter (TOccTime) temporary occupancy time.
4. **(Filter):** a backlit flashing **Filter** alarm will be displayed on the thermostat LCD screen when the input is energized. It can be tied to a differential pressure switch that monitor filters
  - Contact opened = No alarm
  - Contact closed = Alarm displayed
5. **(Service):** a backlit flashing Service alarm will be displayed on the thermostat LCD screen when the input is energized. It can be tied in to the AC unit control card, which provides an alarm in case of malfunction.
  - Contact opened = No alarm
  - Contact closed = Alarm displayed

### Universal input #3 can be configured for the following functions:

1. **(None):** No function will be associated with the input
2. **(COC/NH) Change over dry contact. Normally Heat:** Used for hot / cold water change over switching in 2 pipe systems.
  - Contact closed = Cold water present
  - Contact opened = Hot water present

Only used and valid if system is setup as 2 pipes. Parameter ( Pipe No ) set as 2 pipes.
3. **(COC/NC) Change over dry contact. Normally Cool:** Used for hot / cold water or air change over switching in 2 pipe systems.
  - Contact closed = Hot water present
  - Contact opened = Cold water present

Only used and valid if system is setup as 2 pipes. Parameter ( Pipe No ) set as 2 pipes.
4. **(COS) Change over analog sensor:** Used for hot / cold water or air change over switching in 2 pipe systems.  
Only used and valid if system is setup as 2 pipes. Parameter ( Pipe No ) set as 2 pipes.
  - If temperature is > 77 °F = Hot water present
  - If temperature is < 75 °F = Cold water present
5. **(SS) Supply air sensor monitoring:** Used for supply air temperature monitoring.  
Only used for network reporting of the supply air temperature. Has no internal function in the thermostat.

## Installation

- Remove security screw on the bottom of thermostat cover.
- Open up by pulling on the bottom side of thermostat.
- Remove Assembly and remove wiring terminals from sticker. **(Fig. 3)**
- Please note the FCC ID and IC label installed in the cover upon removal of cover for the wireless products.

### A) Location:

- 1- Should not be installed on an outside wall.
- 2- Must be installed away from any heat source.
- 3- Should not be installed near an air discharge grill.
- 4- Should not be affected by direct sun radiation.
- 5- Nothing must restrain vertical air circulation to the thermostat.

### B) Installation:

- 1- Swing open the thermostat PCB to the left by pressing the PCB locking tabs. **(Fig. 4)**
- 2- Pull out cables 6" out of the wall.
- 3- Wall surface must be flat and clean.
- 4- Insert cable in the central hole of the base.
- 5- Align the base and mark the location of the two mounting holes on the wall. Install proper side of base up.
- 6- Install anchors in the wall.
- 7- Insert screws in mounting holes on each side of the base. **(Fig. 4)**
- 8- Gently swing back the circuit board on the base and push on it until the tabs lock it.
- 10- Strip each wire 1/4 inch.
- 11- Insert each wire according to wiring diagram.
- 13- Gently push back into hole excess wiring **(Fig. 5)**
- 14- Re-Install wiring terminals in correct location. **(Fig. 5)**
- 15- Reinstall the cover (top side first) and gently push back extra wire length into the hole in the wall.
- 16- Install security screw.



- If replacing an old thermostat, label the wires before removal of the old thermostat.
- Electronic controls are static sensitive devices. Discharge yourself properly before manipulation and installing the thermostat.
- Short circuit or wrong wiring may permanently damage the thermostat or the equipment.
- Anti-short cycling can be set to 0 minutes for equipment that posses their own anti cycling timer. Do not use that value unless the equipment is equipped with such internal timer. Failure to do so can damage the equipment.
- All VT7000 series thermostats are to be used only as operating controls. Whenever a control failure could lead to personal injury and/or loss of property, it becomes the responsibility of the user to add safety devices and/or alarm system to protect against such catastrophic failures.

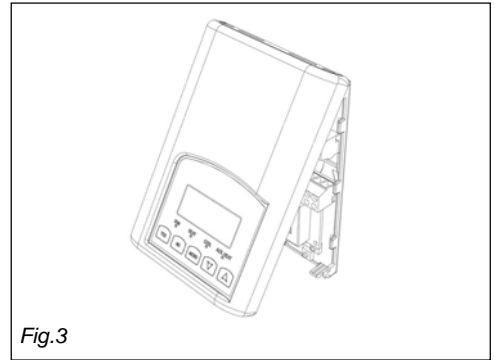

Fig.3

Location of PCB retaining tabs

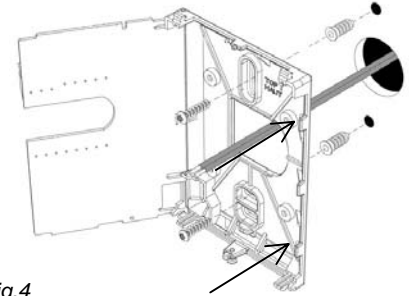

Fig.4

Re-install terminal blocks

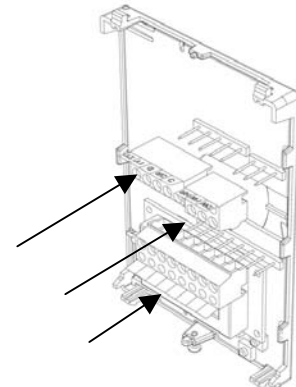

Fig.5

Thermostat assembly  
(VT7300F5000B shown)



Fig.6

**Terminal identification**

<b>Viconics Part Numbers</b> Description / Application	<b>VT73xxA5x00(x)</b> 2 & 4 Pipe On/Off	<b>VT73xxC5x00(x)</b> 2 & 4 Pipe Floating 2 & 4 Pipe On/Off	<b>Viconics Number</b> Description / Application	<b>VT73xxF5x00(x)</b> 2 & 4 Pipe Analog
<b>Internal Temperature</b> <b>Internal Humidity</b>	<b>X</b>	<b>X</b> Model Dependent	<b>Internal Temperature</b> <b>Internal Humidity</b>	<b>X</b> Model Dependent
<b>1- High Fan Speed</b> <b>2- Medium Fan Speed</b> <b>3- Low Fan Speed</b> <b>4- 24 V~ Hot</b> <b>5- 24 V~ Com</b>	Fan-H Fan-M Fan-L 24 V~ Hot 24 V~ Com	Fan-H Fan-M Fan-L 24 V~ Hot 24 V~ Com	<b>1- High Fan Speed</b> <b>2- Medium Fan Speed</b> <b>3- Low Fan Speed</b> <b>4- 24 V~ Hot</b> <b>5- 24 V~ Com</b>	Fan-H Fan-M Fan-L 24 V~ Hot 24 V~ Com
<b>6- Aux BO 5</b> <b>7- Aux BO 5</b> <b>8- BO 3 Open Heat</b>	BO 5-Aux BO 5-Aux BO 3	BO 5-Aux BO 5-Aux BO 3	<b>6- Aux BO 5</b> <b>7- Aux BO 5</b>	BO 5-Aux BO 5-Aux
<b>9- BO 4 Close Heat</b> <b>10- BO 1 Open Cool</b> <b>11- BO 2 Close Cool</b> <b>12- BI #1</b> <b>13- RS</b> <b>14- Scom</b> <b>15- BI #2</b> <b>16- UI #3 COS / COC /SS</b>	BO 2 BI 1 RS Scom BI 2 UI 3	BO 4 BO 1 BO 2 BI 1 RS Scom BI 2 UI 3	<b>9- AO 2 Heat</b> <b>10- AO 1 Cool</b> <b>Not used Blank</b> <b>12- BI #1</b> <b>13- RS</b> <b>14- Scom</b> <b>15- BI #2</b> <b>16- UI #3 COS / COC /SS</b>	AO 2 AO 1 <b>Blank</b> BI 1 RS Scom BI 2 UI 3

**Wiring**

**Power & Fan ( All models )**

24 V~ transformer relay pack  
3 speed 2 speed Single speed

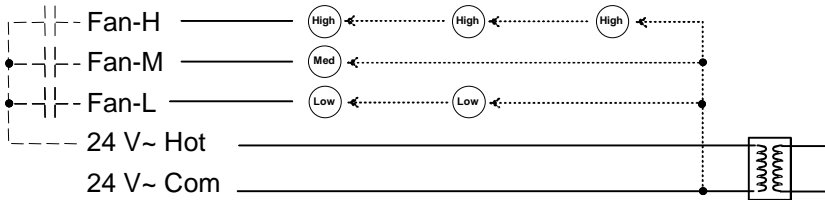

**Remote inputs ( All models )**

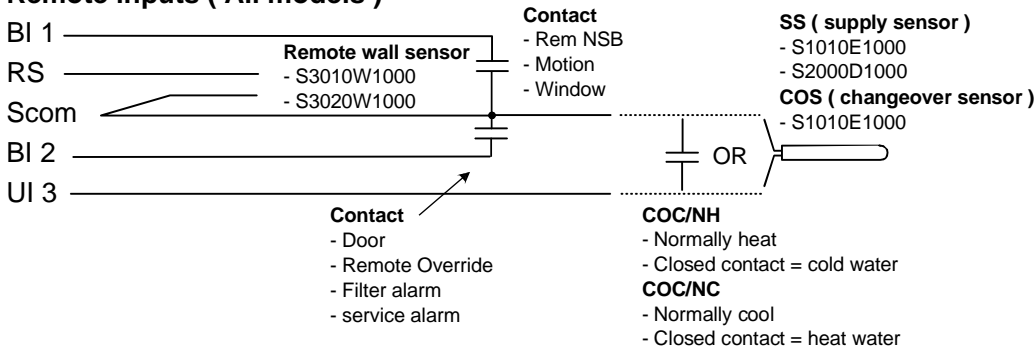

**Auxiliary output ( All models )**

- Dry contact to end device 24 V~ maximum

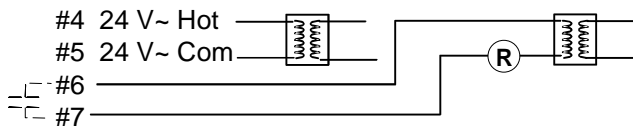

- 24 Vac power to relay

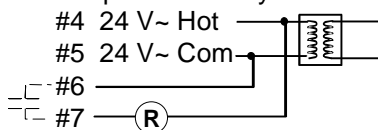

Main outputs wiring

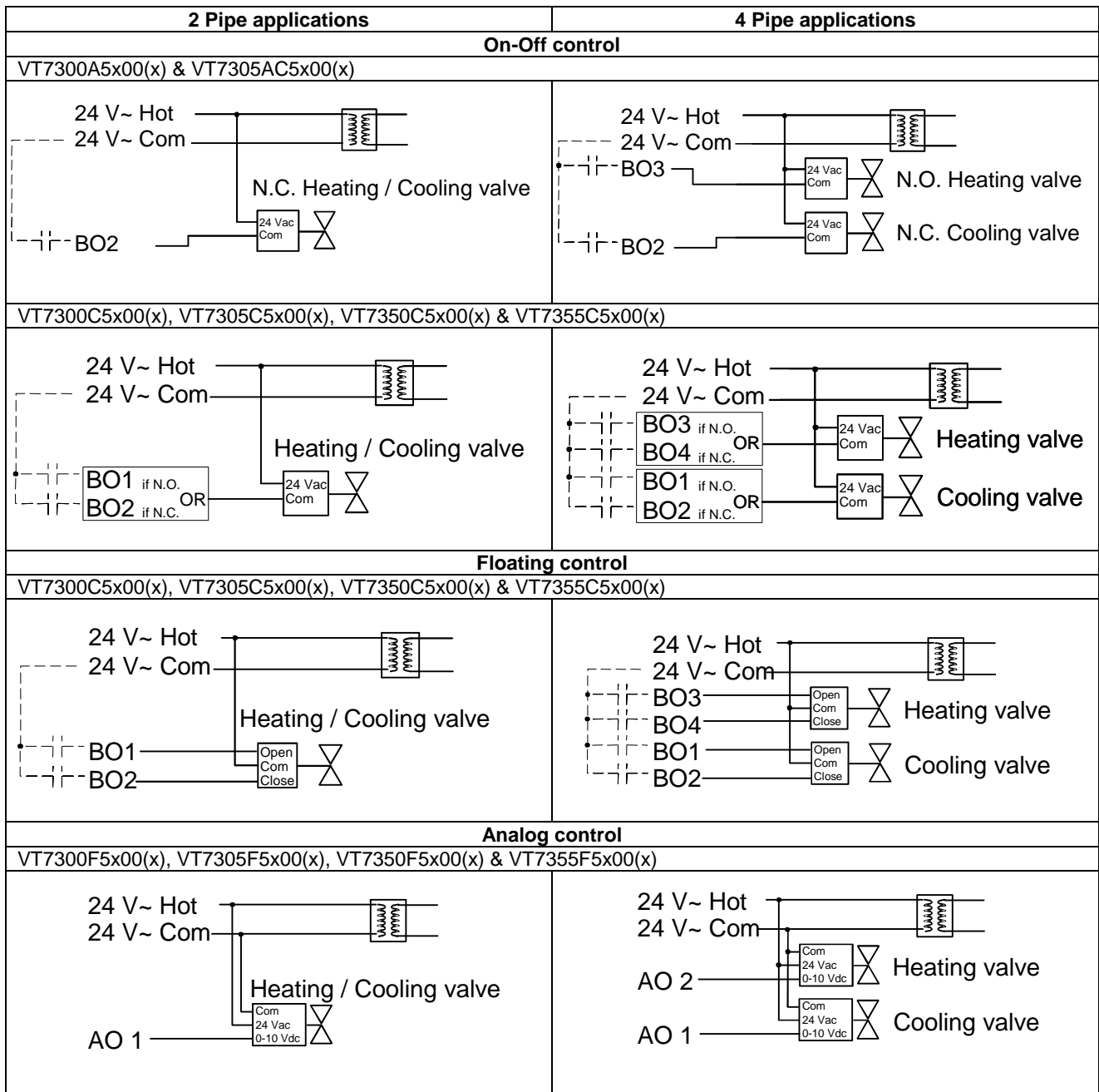

## Typical applications

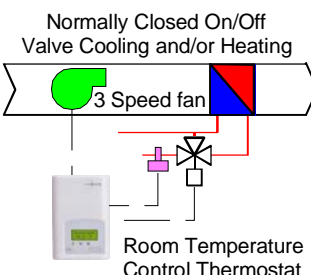
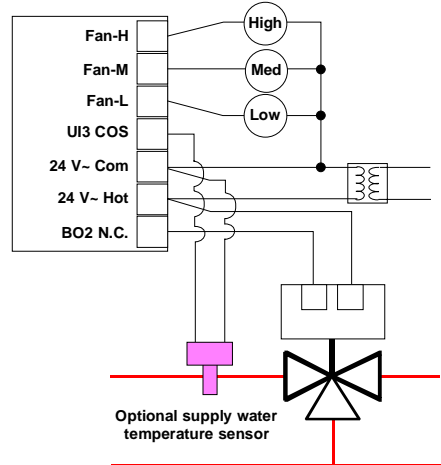
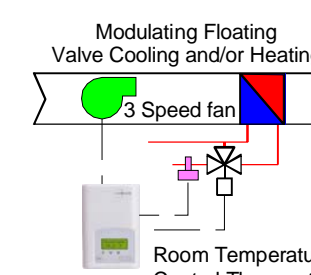
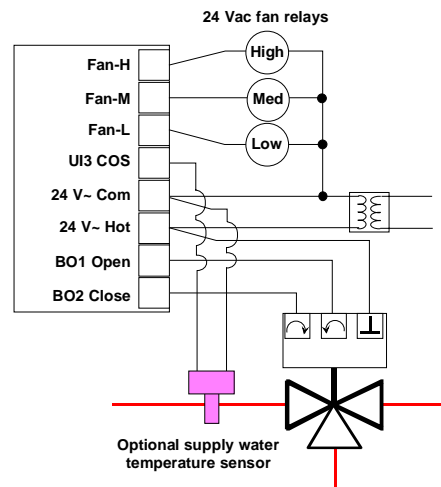
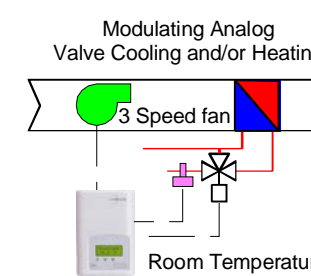
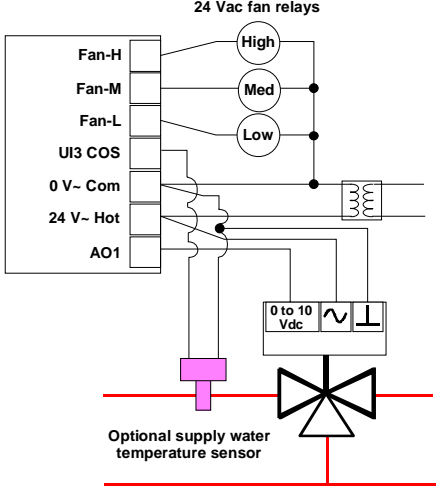
Schematic	Wiring	Settings
<p><b>2 pipe system cooling and/or heating: VT7300A5x00(x), VT7300C5x00(x) &amp; VT7305C5x00(x) On / Off N.C. actuator</b></p>  <p>Normally Closed On/Off Valve Cooling and/or Heating</p> <p>3 Speed fan</p> <p>Room Temperature Control Thermostat</p>	<p><b>Wiring</b></p> <p>24 Vac fan relays</p>  <p>Optional supply water temperature sensor</p>	<p><b>Settings</b></p> <p><b>Mandatory</b></p> <ul style="list-style-type: none"> <li>• Pipe no = 2 pipes</li> <li>• CntrlTyp = On/Off</li> <li>• Fan Menu = 0 (L-M-H)</li> <li>• FL time = <i>as per actuator</i></li> </ul> <p>If <b>cooling only</b> set::</p> <ul style="list-style-type: none"> <li>• SeqOpera = 0 Cooling only</li> </ul> <p>If <b>heating only</b> set::</p> <ul style="list-style-type: none"> <li>• SeqOpera = 1 Heating only</li> </ul> <p>If <b>heat / cool auto-changeover</b> with a local water temperature sensor set:</p> <ul style="list-style-type: none"> <li>• SeqOpera = 0 Cooling only</li> <li>• UI3 = COS</li> </ul>
<p><b>2 pipe system cooling and/or heating: VT7300C5x00(x) &amp; VT7305C5x00(x) Floating actuator</b></p>  <p>Modulating Floating Valve Cooling and/or Heating</p> <p>3 Speed fan</p> <p>Room Temperature Control Thermostat</p>	<p><b>Wiring</b></p> <p>24 Vac fan relays</p>  <p>Optional supply water temperature sensor</p>	<p><b>Settings</b></p> <p><b>Mandatory</b></p> <ul style="list-style-type: none"> <li>• Pipe no = 2 pipes</li> <li>• CntrlTyp = Floating</li> <li>• Fan Menu = 0 (L-M-H)</li> <li>• FL time = <i>as per actuator</i></li> </ul> <p>If <b>cooling only</b> set::</p> <ul style="list-style-type: none"> <li>• SeqOpera = 0 Cooling only</li> </ul> <p>If <b>heating only</b> set::</p> <ul style="list-style-type: none"> <li>• SeqOpera = 1 Heating only</li> </ul> <p>If <b>heat / cool auto-changeover</b> with a local water temperature sensor set:</p> <ul style="list-style-type: none"> <li>• SeqOpera = 0 Cooling only</li> <li>• UI3 = COS</li> </ul>
<p><b>2 pipe system cooling and/or heating: VT7300F5x00(x) &amp; VT7305F5x00(x) Analog actuator</b></p>  <p>Modulating Analog Valve Cooling and/or Heating</p> <p>3 Speed fan</p> <p>Room Temperature Control Thermostat</p>	<p><b>Wiring</b></p> <p>24 Vac fan relays</p>  <p>Optional supply water temperature sensor</p>	<p><b>Settings</b></p> <p><b>Mandatory</b></p> <ul style="list-style-type: none"> <li>• Pipe no = 2 pipes</li> <li>• Fan Menu = 0 (L-M-H)</li> <li>• RA/DA = <i>as per actuator</i></li> </ul> <p>If <b>cooling only</b> set::</p> <ul style="list-style-type: none"> <li>• SeqOpera = 0 Cooling only</li> </ul> <p>If <b>heating only</b> set::</p> <ul style="list-style-type: none"> <li>• SeqOpera = 1 Heating only</li> </ul> <p>If <b>heat / cool auto-changeover</b> with a local water temperature sensor set:</p> <ul style="list-style-type: none"> <li>• SeqOpera = 0 Cooling only</li> <li>• UI3 = COS</li> </ul>

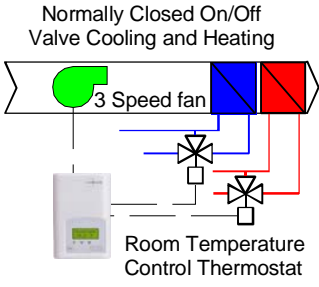
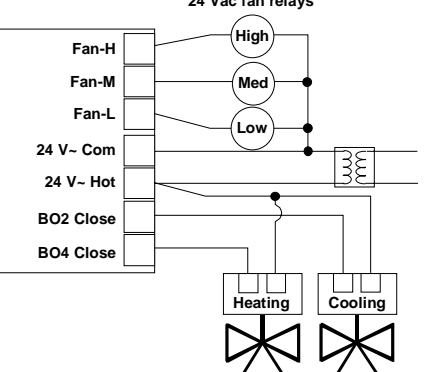
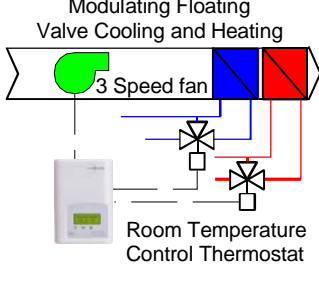
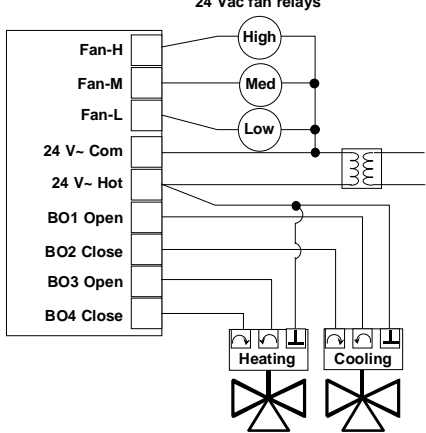
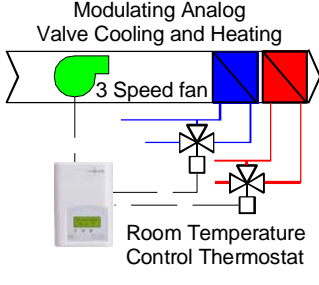
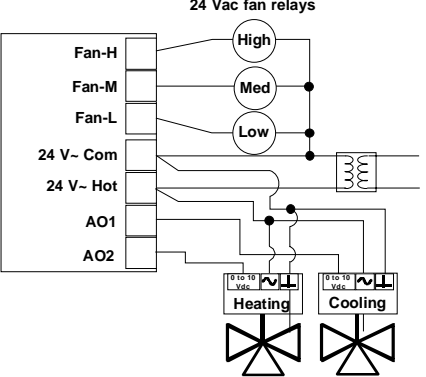
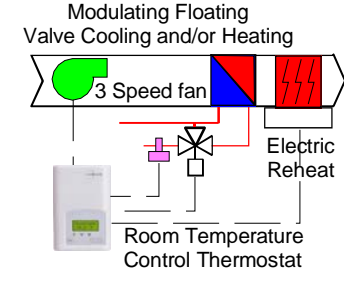
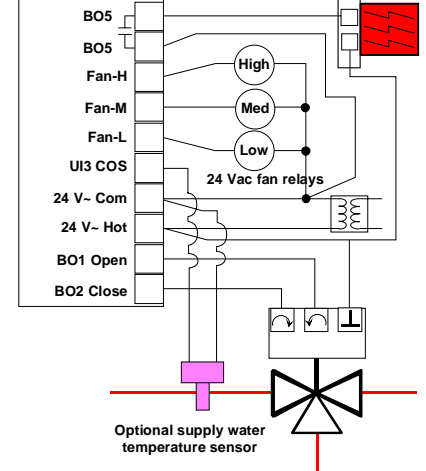
Schematic	Wiring	Settings
<b>4 pipe system cooling and heating: VT7300C5x00(x) &amp; VT7305C5x00(x) On / Off N.C. actuators</b>		
<p>Normally Closed On/Off Valve Cooling and Heating</p>  <p>Room Temperature Control Thermostat</p>	<p>24 Vac fan relays</p> 	<p><b>Mandatory</b></p> <ul style="list-style-type: none"> <li>• Pipe no = 4 pipes</li> <li>• CntrlTyp = On/Off</li> <li>• Fan Menu = 0 (L-M-H)</li> <li>• FL time = <i>as per actuator</i></li> <li>• SeqOpera = 4 Cool/Heat</li> </ul>
<b>4 pipe system cooling and heating: VT7300C5x00(x) &amp; VT7305C5x00(x) Floating actuators</b>		
<p>Modulating Floating Valve Cooling and Heating</p>  <p>Room Temperature Control Thermostat</p>	<p>24 Vac fan relays</p> 	<p><b>Mandatory</b></p> <ul style="list-style-type: none"> <li>• Pipe no = 4 pipes</li> <li>• CntrlTyp = Floating</li> <li>• Fan Menu = 0 (L-M-H)</li> <li>• FL time = <i>as per actuator</i></li> <li>• SeqOpera = 4 Cool/Heat</li> </ul>
<b>4 pipe system cooling and heating: VT7300F5x00(x) &amp; VT7305F5x00(x) Analog actuators</b>		
<p>Modulating Analog Valve Cooling and Heating</p>  <p>Room Temperature Control Thermostat</p>	<p>24 Vac fan relays</p> 	<p><b>Mandatory</b></p> <ul style="list-style-type: none"> <li>• Pipe no = 4 pipes</li> <li>• Fan Menu = 0 (L-M-H)</li> <li>• RA/DA = <i>as per actuator</i></li> <li>• SeqOpera = 4 Cool/Heat</li> </ul>
<b>2 pipe system cooling or heating with reheat: VT7300C5x00(x) &amp; VT7305C5x00(x) Floating actuator</b>		
<p>Modulating Floating Valve Cooling and/or Heating</p>  <p>Room Temperature Control Thermostat</p> <p>Electric Reheat</p>	<p>24 Vac fan relays</p>  <p>Optional supply water temperature sensor</p>	<p><b>Mandatory</b></p> <ul style="list-style-type: none"> <li>• Pipe no = 2 pipes</li> <li>• CntrlTyp = Floating</li> <li>• Fan Menu = 0 (L-M-H)</li> <li>• FL time = <i>as per actuator</i></li> <li>• SeqOpera = 2 Cool/Reheat</li> <li>• UI3 = COS</li> </ul>



Remote sensor accessories

Model no.	Description
S3010W1000	Wall mounted temperature sensor
S3020W1000	Wall mounted temperature sensor with override button and occupancy status LED
S2060A1000	Averaging temperature sensor
S2000D1000	Duct mounted temperature sensor



FIG.8 – S3020W1000 WALL MOUNTED SENSOR

Remote mount temperature sensors use 10K type 2 NTC thermistors.

Features:

- Each sensor can be configured for various averaging combinations
- Optional occupancy led
- Optional override key

Wiring example of single remote room sensor:

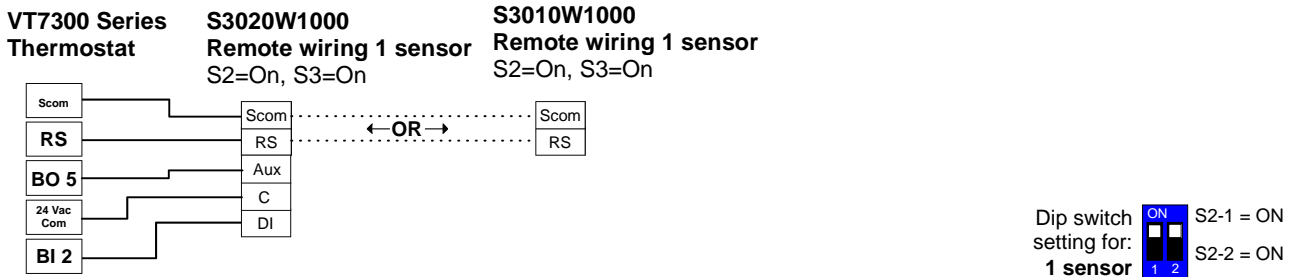

Wiring examples of 2 remote room sensors for averaging applications:

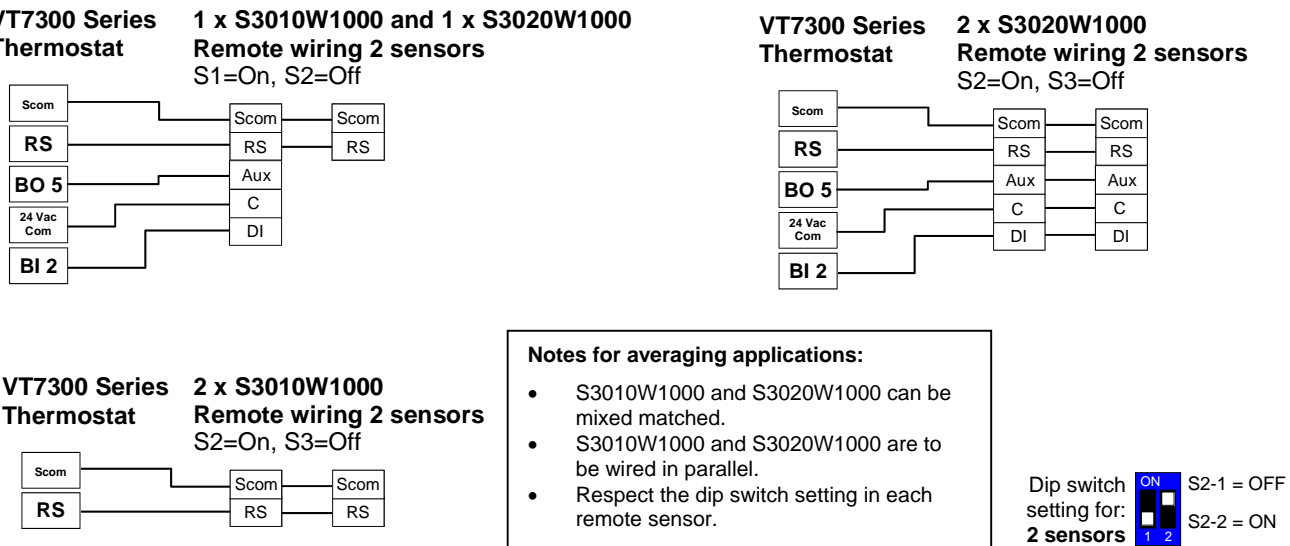

Wiring examples of 3 remote room sensors for averaging applications:

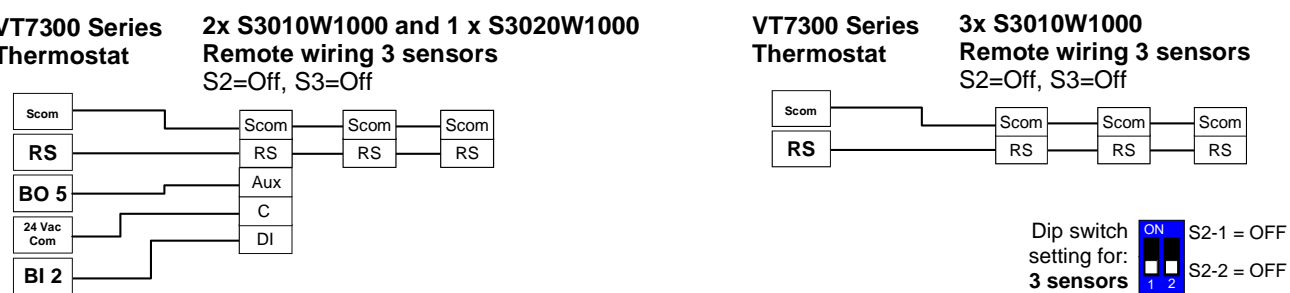

Temperature vs resistance chart for 10 Kohm NTC thermistor ( $R_{25^{\circ}\text{C}} = 10\text{K}\Omega \pm 3\%$ ,  $B_{25/85^{\circ}\text{C}} = 3975\text{K} \pm 1.5\%$ )

°C	°F	Kohm	°C	°F	Kohm	°C	°F	Kohm	°C	°F	Kohm	°C	°F	Kohm
-40	-40	324.3197	-20	-4	94.5149	0	32	32.1910	20	68	12.4601	40	104	5.3467
-35	-31	234.4009	-15	5	71.2430	5	41	25.1119	25	77	10.0000	45	113	4.3881
-30	-22	171.3474	-10	14	54.1988	10	50	19.7390	30	86	8.0694	50	122	3.6202
-25	-13	126.6109	-5	23	41.5956	15	59	15.6286	35	95	6.5499	55	131	3.0016



**Programming and status display instructions**

**Status display**

The thermostat features a two-line, eight-character display. There is a low level backlight level that is always active and can only be seen at night.

When left unattended, the thermostat has an auto scrolling display that shows the actual status of the system. There is an option in the configuration menu to lockout the scrolling display and to only present the room temperature and conditional outdoor temperature to the user. With this option enabled, no local status is given of mode, occupancy and relative humidity.

Each item is scrolled one by one with the back lighting in low level mode. Pressing any key will cause the back light to come on to high level. When left unattended for 10 seconds after changes are made, the display will resume automatic status display scrolling.

To turn on the back light to high level, press any key on the front panel. The back lit display will return to low level when the thermostat is left unattended for 45 seconds

**Sequence of auto-scroll status display:**

Room & Humidity	System Mode	Schedule Status	Outdoor Temperature	Alarms
x.x °C or °F XX % RH If humidity display enabled RoomTemp x.x °C or °F If humidity display is not enabled	Sys mode Auto Sys mode Cool Sys mode heat Sys mode off	Occupied Stand-By Unoccup Override	Outdoor x.x °C or °F Network value only	Service Filter Window

**% RH display is conditional to:**

(Humidity display is model and configuration dependent)

- Model with RH sensor built in
- Display function can be enabled with RH display parameter. Displayed range is 10 to 90 % RH

**Outdoor air temperature**

- Display is only enabled when outdoor air temperature network variable is received.

**Occupancy Status**

- Occupied, Stand-By, Unoccupied and Override status are displayed on the scrolling display.

**Alarms**

- If alarms are detected, they will automatically be displayed at the end of the status display scroll.
- During an alarm message display, the backlit screen will light up at the same time as the message and shut off during the rest of the status display.
- Two alarms maximum can appear at any given time. The priority for the alarms is as follows:

<b>Service</b>	Indicates that there is a service alarm as per one of the programmable binary input ( B12 )
<b>Filter</b>	Indicates that the filters are dirty as per one of the programmable binary input ( B12 )
<b>Window</b>	Indicates that the outside window or door is opened and that the thermostat has cancelled any cooling or heating action ( B11 )

**Three status LED's** on the thermostat cover are used to indicate the status of the fan ( any speed ), a call for heat, or a call for cooling.

**Fan coil models**

- When any of the fan speeds are ON, the FAN LED will illuminate.
- When heating & reheat is ON, the HEAT LED will illuminate.
- When cooling is ON, the COOL LED will illuminate.



Fig.11 – Hotel models °C/°F



Fig. 12 Commercial models with Override

### Installer configuration parameter menu

Configuration can be done through the network or locally at the thermostat.

- To enter configuration, press and hold the middle button (°C/°F or Override) for 8 seconds
- Press the same middle button repetitively to scroll between all the available parameters
- Use the up and down key to change the parameter to the desired value.
- To acknowledge and save the new value, press the middle button again.
- The next listed parameter is now displayed

### Configuration interface

<b>Fan</b>	Re-starts the configuration parameter list at the beginning
<b>°C/°F</b>	Enters the configuration mode. Press and hold for 8 seconds
<b>Override</b>	Pressing repetitively will scroll all available parameters one by one
<b>Down</b>	Adjust / rotate parameter value down
<b>Up</b>	Adjust / rotate parameter value up

### User interface

#### • Unoccupied mode Override

An Override can be made on commercial models during an Unoccupied period. If the Override option is enabled in the lockout configuration pressing the middle override button will resume occupied setpoints for a time specified by parameter ToccTime

#### • Keypad interface

<b>System</b>	Is used to toggle between the different system mode available as per sequence and menu selected Pressing repetitively the button will toggle between all the available modes Available menus are dependent on selected sequence of operation
<b>Fan</b>	Is used to toggle between the different fan mode available as per sequence and menu selected Pressing repetitively the button will toggle between all the available modes Available menus are dependent on selected sequence of operation and menu selected for Fan
<b>°C/°F Override</b>	❖ Middle key is <ul style="list-style-type: none"> <li>• °C / °F for Hotel models</li> <li>• Override for commercial models</li> </ul>
<b>Down</b>	Adjust the setpoints down ❖ In cooling mode only the cooling setpoint displayed, ❖ In heating mode only the heating setpoint displayed ❖ In auto mode, (See below)
<b>Up</b>	Adjust the setpoints up ❖ In cooling mode only the cooling setpoint displayed, ❖ In heating mode only the heating setpoint displayed ❖ In auto mode, (See below)

1. Any setpoint change can be permanent or temporary based on configuration parameter (Setpoint Type)
2. Any setpoint written through the network, will be permanent and cancel any active temporary setpoints
3. Lockouts of access to certain functions is made with configuration parameter (lockout)

#### • Occupied setpoint adjustments

<b>Cooling mode</b>	<b>Heating mode</b>	<b>Off mode</b>	<b>Auto Mode</b> <ul style="list-style-type: none"> <li>• Setpoint presented to user is the setpoint from the last action taken by the thermostat or the one currently in use.</li> <li>• If the other setpoint is the one desired, then the MODE button is used to toggle between the current displayed one and the other.</li> </ul>
Cool XX.X °F or °C	Heat XX.X °F or °C	No access to setpoint	Cool XX.X °F or °C or Heat XX.X °F or °C <b>Toggle to ( Heat or Cool )with MODE button</b>

- Heat/Cool setpoint toggle with MODE button to be active only in AUTO mode.
- If cooling, heating or off mode is active, function is disabled

#### • Unoccupied and Stand-By setpoints adjustments

Setting the stand-by and unoccupied setpoints is done through the network or through configuration setup only.

- **Mode button menu sequence.**

- Modes presented to the user are dependent on sequence of operation selected
- **Default mode** is in **bold** when sequence of operation parameter is changed
- \* Auto mode menu can be disabled with (AutoMode) parameter

Sequence selected	Mode Menu
0 = Cooling only	Off - <b>Cool</b>
1 = Heating only	Off - <b>Heat</b>
2 = Cooling With Reheat	Off - <u>Auto</u> * - <b>Heat</b> - Cool
3 = Heating With Reheat	Off - <b>Heat</b>
4 = Cooling / Heating 4 pipes	Off - <u>Auto</u> * - <b>Heat</b> - Cool
5 = Cooling / Heating 4 pipes with Reheat	Off - <u>Auto</u> * - <b>Heat</b> - Cool

\* Auto. The Auto mode can be disabled from the menu with the (AutoMode) parameter

- **Available fan button menu sequences.**

Fan button menu configuration	Menu presented are dependent on model used and sequence of operation selected	Default value when sequence toggled
0 Low-Med-High	3 Speed configuration using 3 fan relays ( L-M-H )	High
1 Low-High	2 Speed configuration using 2 fan relays ( L-H )	High
2 Low-Med-High-Auto	3 Speed configuration with <b>Auto</b> fan speed mode using 3 fan relays ( L-M-H )	High
3 Low-High-Auto	2 Speed configuration with <b>Auto</b> fan speed mode using 2 fan relays ( L-H )	High
4 On-Auto	<b>Single</b> Speed configuration. Auto is for Fan on demand / On is On all the time	Auto

Auto speed fan mode is also offered in heating mode applications; it will not however have any effect on dehumidification. It will be strictly for noise comfort issues

Configuration parameters Default value	Significance and adjustments
<b>Com Addr</b> Thermostat networking address Default value = <b>4</b> <b>Range is:</b> 0 to 254	<b>Conditional parameter to BACnet MS-TP models (VT730xX1000B)</b> <b>Conditional parameter to Wireless models (VT730xX1000W)</b> This parameter will only appear when a BACnet or wireless network adapter is present. If the thermostat is installed as a stand-alone unit or with an Echelon adapter, this parameter will not be used or displayed <ul style="list-style-type: none"> <li>• For BACnet MS-TP models valid range to use is from 1 to 127</li> <li>• For wireless models valid range is 0 to 254 with a maximum of 30 thermostat per VGG</li> </ul>
<b>PAN ID</b> Personal Area Network Identification Default value = 0 <b>Range is:</b> 0 to 500	<b>Conditional parameter to Wireless models (VT730xX1000W)</b> This parameter will only appear when a wireless network adapter is present. If the thermostat is installed as a stand-alone unit or with a BACnet or Echelon adapter, this parameter will not be used or displayed  This parameter (Personal Area Network Identification) is used to link specific thermostats to a single specific Viconics wireless gateway ( VWG ) For every thermostat reporting to a gateway ( maximum of 30 thermostats per gateway ), be sure you set the <b>SAME</b> PAN ID value both at the gateway and the thermostat(s).  The default value of 0 is <b>NOT</b> a valid PAN ID. The valid range of available PAN ID is from 1 to 500
<b>Channel</b> Channel selection Default value = 10 <b>Range is:</b> 10 to 26	<b>Conditional parameter to Wireless models (VT730xX1000W)</b> This parameter will only appear when a wireless network adapter is present. If the thermostat is installed as a stand-alone unit or with a BACnet or Echelon adapter, this parameter will not be used or displayed  This parameter (Channel) is used to link specific thermostats to specific Viconics wireless gateway(s) ( VWG ) For every thermostat reporting to a gateway ( maximum of 30 thermostats per gateway ), be sure you set the <b>SAME</b> channel value both at the gateway and the thermostat(s).  <b>Viconics recommends using only the 2 last channels ( 25-2575MHz and 26-2580MHz )</b>  The default value of 10 is <b>NOT</b> a valid channel. The valid range of available channel is from 11 to 26

<p><b>Get From</b> Thermostat Get From another device configuration utility Default value = <b>0</b> <b>Range is:</b> 0 to 254</p>	<p><b>Conditional parameter to Wireless models (VT730xX1000W)</b></p> <p><b>This parameter / function is not currently supported by the wireless thermostats.</b></p>
<p><b>BI1</b> Binary input no.1 configuration Default value = None</p>	<p><b>(None):</b> No function will be associated with the input <b>(Rem NSB):</b> remote NSB timer clock input. The scheduling will now be set as per the binary input. It provides low cost setback operation via a dry contact Contact opened = Occupied Contact closed = Unoccupied</p> <p><b>(Motion NO) or (Motion NC):</b> Advanced PIR occupancy functions using a Normally Open (NO) or Normally Closed (NC) remote PIR motion sensor. Occupancy mode is now set as per applied PIR function and configuration. Application information and examples are available on document: <i>APP-PIR-Guide-Exx</i>. This document will provide the installers and system designers with detailed examples on applications, parameter configuration information, sequence of operation, troubleshooting and diagnostic help required for the proper usage of the PIR accessory covers</p> <p><b>(Window) EMS:</b> Forces the system to disable any current heating or cooling action by the thermostat. The mode stays the same and the current setpoints are the same Occupied setpoints. Only the outputs are disabled. There is a Door/Window alarm displayed on the thermostat to indicate to the local tenant that the door/window needs to be closed for cooling or heating to resume.</p> <p>* these settings will disable the local override function on the thermostat.</p>
<p><b>BI2</b> Binary input no.2 configuration Default value = None</p>	<p><b>(None):</b> No function will be associated with the input <b>(Door Dry) Door contact &amp; Motion detector:</b> This configuration is only functional if binary input #1 is set to <b>Motion NO</b> or <b>Motion NC</b> or a <b>PIR accessory cover</b> is used. With this sequence enabled, the occupancy is now dictated through those 2 inputs. Any motion detected will set the zone to occupied status. The zone will remain permanently in occupied mode until the door contact switch opens momentarily. The thermostat will then go in stand-by mode. If more movements are detected, the occupied mode will resume. While the door is opened, any movements detected by the remote PIR sensor or the PIR accessory cover will be ignored. Use a Normally Closed contact switching device. Contact opened = Door opened Contact closed = Door closed</p> <p><b>(RemOVR):</b> temporary occupancy remote override contact. This function disables the central button override function on the thermostat. The override function is now controlled by a manual remote momentarily closed contact. When configured in this mode, the input operates in a toggle mode. It is now possible to toggle between unoccupied &amp; occupied setpoints for the amount of time set by parameter (TOccTime) temporary occupancy time.</p> <p><b>(Filter):</b> a backlit flashing <b>Filter</b> alarm will be displayed on the thermostat LCD screen when the input is energized. It can be tied to a differential pressure switch that monitor filters Contact opened = No alarm Contact closed = Alarm displayed</p> <p><b>(Service):</b> a backlit flashing <b>Service</b> alarm will be displayed on the thermostat LCD screen when the input is energized. It can be tied in to the AC unit control card, which provides an alarm in case of malfunction. Contact opened = No alarm Contact closed = Alarm displayed</p>

<p><b>UI3</b> Universal input no.3 configuration Default value = <b>None</b></p>	<p><b>(None):</b> No function will be associated with the input</p> <p><b>(COC/NH) Change over dry contact. Normally Heat:</b> Used for hot / cold water or air change over switching in 2 pipe systems. Contact closed = Cold water or air present Contact opened = Hot water or air present Only used and valid if system is setup as 2 pipes. Parameter ( Pipe No ) set as 2 pipes.</p> <p><b>(COC/NC) Change over dry contact. Normally Cool:</b> Used for hot / cold water or air change over switching in 2 pipe systems. Contact closed = Hot water present Contact opened = Cold water present Only used and valid if system is setup as 2 pipes. Parameter (Pipe No ) set as 2 pipes.</p> <p><b>(COS) Change over analog sensor:</b> Used for hot / cold water or air change over switching in 2 pipe systems. Only used and valid if system is setup as 2 pipes. Parameter (Pipe No ) set as 2 pipes. If water temperature is &gt; 78 °F = Hot water present If water temperature is &lt; 75 °F = Cold water present</p> <p><b>(SS) Supply air sensor monitoring:</b> Used for supply air temperature monitoring. Only used for network reporting of the supply air temperature. Has no internal function in the thermostat.</p>			
<p><b>MenuScro</b> <b>Menu scroll</b> Default value = <b>On</b> = Scroll active</p>	<p>Removes the scrolling display and only present the room temperature/humidity to the user. With this option enabled, no status is given of mode, schedule and outdoor temperature. <b>On = Scroll active</b> <b>Off = Scroll not active</b></p>			
<p><b>AutoMode</b> Enables <b>Auto</b> menu for Mode button Default value = <b>Off</b></p>	<p>Enables Auto function for the mode button For sequences 2, 4 &amp; 5 only <b>On = Auto active</b> (Off-Cool-Heat-Auto) <b>Off = auto not active</b> (Off-Cool-Heat)</p>			
<p><b>C or F</b> Sets scale of the thermostat Default value = <b>°F</b></p>	<p><b>°F</b> for Fahrenheit scale <b>°C</b> for Celsius scale On hotel models, this sets the default value when the thermostat powers up</p>			
<p><b>%RH disp</b> <b>Local %RH Display</b>  Default value = <b>OFF</b> Models with Humidity sensor only <b>VT735xX5x00(x) models only</b></p>	<p>RH models only Enables the display of humidity below the room temperature on the display  <b>ON</b> = Display %RH <b>OFF</b> = No display of %RH</p>			
<p><b>Lockout</b> Keypad lockout levels Default value = <b>0 No lock</b></p>				
<p><b>Level</b></p>	<p><b>Occupied temperature setpoints</b></p>	<p><b>System mode setting</b></p>	<p><b>Fan mode setting</b></p>	<p><b>Unoccupied Override</b></p>
<p>0</p>	<p>Yes access</p>	<p>Yes access</p>	<p>Yes access</p>	<p>Yes access</p>
<p>1</p>	<p>Yes access</p>	<p>Yes access</p>	<p>Yes access</p>	<p>No access</p>
<p>2</p>	<p>Yes access</p>	<p>No access</p>	<p>No access</p>	<p>Yes access</p>
<p>3</p>	<p>Yes access</p>	<p>No access</p>	<p>No access</p>	<p>No access</p>
<p>4</p>	<p>No access</p>	<p>No access</p>	<p>No access</p>	<p>Yes access</p>
<p>5</p>	<p>No access</p>	<p>No access</p>	<p>No access</p>	<p>No access</p>
<p><b>Pipe No</b> System type installation Number of pipes Default is: <b>4.0</b> Pipes</p>	<p>Defines the type of system installed <b>2.0</b> Pipes, will limit the number of sequences of operation available from 0 to 3 Will enable heat/cool operation from the same output ( refer to wiring diagram ) <b>4.0</b> Pipes, can access all the sequences of operation from 0 to 5 Will enable heat/cool operation from different output ( refer to wiring diagram )</p>			

<b>CntrlTyp</b> Control type for Triac models Default is: <b>Floating</b>	Defines the type of control output for the type of valves installed <b>VT7350C10xx, VT7300C10xx, VT7355C10xx and VT7305C10xx only</b> <b>On/Off</b> is for normally opened or normally closed 24 Vac 2 position valves  <b>Floating</b> is for modulating 3 wires control of 24 Vac floating valves	
<b>SeqOpera</b> Sequence of operation Default is: <b>Sequence #1</b>	<b>System = 2 Pipes</b>	<b>System = 4 Pipes</b>
0 = Cooling Only	Yes access	Yes access
1 = Heating only	Yes access	Yes access
2 = Cooling With Reheat	Yes access	Yes access
3 = Heating With Reheat	Yes access	Yes access
4 = Cooling / Heating 4 pipes	No access	Yes access
5 = Cooling / Heating 4 pipes with Reheat	No access	Yes access
	For single output applications, the system access is also limited if UI3 is configured for local changeover COS, COC/NC or COC/NC. The system mode available for the local configuration or network write is then limited by the current water temperature detected by the UI3.	
<b>Fan Menu</b> Mode button menu configuration Default is: <b>Menu #4</b>	Menu presented are dependent on model used and sequence of operation selected	
0 = Low-Med-High	<b>3</b> Speed configuration using 3 fan relays ( L-M-H )	
1 = Low-High	<b>2</b> Speed configuration using 2 fan relays ( L-H )	
2 = Low-Med-High-Auto	<b>3</b> Speed configuration with Auto fan speed mode using 3 fan relays ( L-M-H )	
3 = Low-High-Auto	<b>2</b> Speed configuration with Auto fan speed mode using 2 fan relays ( L-H )	
4 = On-Auto	<b>Single</b> Speed configuration. Auto is for Fan on demand / On is On all the time	
<b>DHumiLCK</b> Dehumidification lockout <b>VT735xX5x00(x) models only</b> Default value: <b>On = Authorized</b>	Typically toggled through the network. This variable enables or disables dehumidification based on central network requirements from the BAS front end <b>On = Dehumidification Authorized</b> <b>Off = Dehumidification Not Authorized</b>	
<b>%RH set</b> Dehumidification setpoint Default is <b>50 % RH</b>	Used only if dehumidification sequence is enabled: Range is: <b>30-95% RH</b> <b>VT735xX5x00(x) models only</b>	
<b>DehuHyst</b> Dehumidification Hysterisys Default is <b>5 % RH</b>	Humidity control hysterisys. Used only if dehumidification sequence is enabled: Range is: <b>2 to 20% RH</b> <b>VT735xX5x00(x) models only</b>	
<b>DehuCool</b> Maximum Dehumidification Cooling output Default is <b>100 %</b>	Maximum cooling valve position when dehumidification is enabled. This can be used to balance smaller reheat loads installed in regards to the capacity of the cooling coil. Range is: <b>20 to 100 %</b> <b>VT735xX5x00(x) models only</b>	
<b>St-By TM</b> Stand-by Timer value Default <b>0.5 hours</b>	Time delay between the moment where the PIR cover detected the last movement in the area and the time which the thermostat stand-by mode and setpoints become active. Range is: <b>0.5 to 24.0 hours</b> in 0.5hr increments	
<b>Unocc TM</b> Unoccupied Timer value Default <b>0.0 hours</b>	Time delay between the moment where the thermostat toggles to stand-by mode and the time which the thermostat unoccupied mode and setpoints become active. The factory value or <b>0.0 hours</b> : Setting this parameter to its default value of 0.0 hours disables the unoccupied timer. This prevents the thermostat to drift from stand-by mode to unoccupied mode when PIR functions are used Range is: <b>0.0 to 24.0 hours</b> in 0.5hr increments	
<b>St-By HT</b> Stand-by heating setpoint Default value = <b>69 °F</b>	The value of this parameter should reside between the occupied and unoccupied heating setpoints and make sure that the difference between the stand-by and occupied value can be recovered in a timely fashion when movement is detected in the zone. Stand-by heating setpoint range is: <b>40 to 90 °F ( 4.5 to 32.0 °C )</b>	

<b>St-By CL</b> Stand-by cooling setpoint limit Default value = <b>78 °F</b>	The value of this parameter should reside between the occupied and unoccupied cooling setpoints and make sure that the difference between the stand-by and occupied value can be recovered in a timely fashion when movement is detected in the zone. Stand-by cooling setpoint range is: <b>54 to 100 °F ( 12.0 to 37.5 °C )</b>
<b>Unocc HT</b> Unoccupied heating setpoint Default value = <b>62 °F</b>	Unoccupied heating setpoint range is: <b>40 to 90 °F ( 4.5 to 32.0 °C )</b>
<b>Unocc CL</b> Unoccupied cooling setpoint limit Default value = <b>80 °F</b>	Unoccupied cooling setpoint range is: <b>54 to 100 °F ( 12.0 to 37.5 °C )</b>
<b>heat max</b> Maximum heating setpoint limit Default value = <b>90 °F ( 32 °C )</b>	Maximum occupied & unoccupied heating setpoint adjustment. Heating setpoint range is: <b>40 to 90 °F ( 4.5 to 32.0 °C )</b>
<b>cool min</b> Minimum cooling setpoint limit Default value = <b>54 °F ( 12 °C )</b>	Minimum occupied & unoccupied cooling setpoint adjustment. Cooling setpoint range is: <b>54 to 100 °F ( 12.0 to 37.5 °C )</b>
<b>Set Type</b> Temporary setpoint enable Default is : <b>Permment</b>  Enables temporary setpoints feature to any change of occupied or unoccupied setpoint.	<b>Temporar:</b> (temporary) Local changes to the heating or cooling setpoints by the user are temporary. They will remain effective for the duration specified by ToccTime. Setpoints will revert back to their default value after internal timer ToccTime expires. To change setpoints permanently, revert to <b>No</b> this variable or write setpoints through the network. Any setpoints written through the network will be permanent ones and saved to EEPROM. <b>Permment:</b> (permanent) Any change of occupied or unoccupied setpoints through the keypad by the user are permanent and saved to & EEPROM
<b>TOccTime</b> Temporary occupancy time Default value = <b>2 hours</b>	Temporary occupancy time with occupied mode setpoints when override function is enabled When the thermostat is in unoccupied mode, function is enabled with either the menu or UI2 configured as remote override input. Range is: <b>0,1, 2, 3, 4, 5, 6, 7, 8, 9, 10, &amp; up to 24 hours</b>
<b>deadband</b> Minimum deadband Default value = <b>2.0 °F ( 1.0 °C )</b>	Minimum deadband value between the heating and cooling setpoints. If modified, it will be applied only when any of the setpoints are modified. Range is: <b>2, 3, 4 or 5 °F, 1.0 °F increments ( 1.0 to 2.5 °C, 0.5 °C increments )</b>
<b>cal RS</b> Room temperature sensor calibration Default value = <b>0.0 °F or °C</b>	Offset that can be added/subtracted to actual displayed room temperature Range is: <b>± 5.0 °F, 1.0 °F increments ( ± 2.5 °C, 0.5 °C increments )</b>
<b>cal RH</b> Humidity sensor calibration Default value = <b>0 %RH</b>	Offset that can be added/subtracted to actual displayed humidity by ± 15.0 %RH. Range is : <b>± 15.0 %RH</b>



<p><b>aux cont</b> Auxiliary contact function &amp; configuration Default value = <b>0</b> Not Used</p>	<p><b>0 Aux contact function used for reheat</b> <i>IF SEQUENCE IS SET TO REHEAT THROUGH NETWORK OR LOCAL</i>, Ignore this parameter</p> <p><b>The output will directly follow the occupancy of the thermostat</b> <b>1 Auxiliary NO</b>, Occ or St-By = Contact Closed / Unoccupied = Contact Opened <b>2 Auxiliary NC</b>, Occ or St-By = Contact Opened / Unoccupied = Contact Closed</p> <p><b>Output to follow directly main occupancy and Fan on command</b> Typically used for 2 position fresh air damper applications. <b>3 Auxiliary NO</b>, Occ or St-By &amp; Fan On = Contact Closed / Unoccupied &amp; Fan On or Off = Contact Opened <b>4 Auxiliary NC</b>, Occ or St-By &amp; Fan On = Contact Opened / Unoccupied &amp; Fan On or Off = Contact Closed</p> <p><b>Output to follow secondary network occupancy command</b> <b>5 Auxiliary On/Off Control</b> through auxiliary network command. The output can be commanded through the network for any required auxiliary functions through a separate &amp; dedicated network variable.</p>
<p><b>FL time</b> For floating models <b>VT73xxC5x00(x)</b> only Default value: <b>1.5 minutes</b></p>	<p>Floating actuator timing Maximum stroke time of floating valve actuator. Range is: <b>0.5 to 9.0 minutes</b> in 0.5 minutes increment</p>
<p><b>cph</b> On/Off devices cycles per hour For On/Off models &amp; sequences <b>VT73xxC5x00(x)</b> only Default value = <b>4 C.P.H.</b></p>	<p>Will set the maximum number cycles per hour under normal control operation. It represents the maximum number of cycles that the equipment will turn ON and OFF in one hour. Note that a higher C.P.H will represent a higher accuracy of control at the expense of wearing mechanical components faster. Range is: <b>3, 4, 5, 6,7 &amp; 8 C.P.H.</b></p>
<p><b>RA/DA</b> For Analog models <b>VT73xxF5x00(x)</b> only Default value: <b>DA signal</b></p>	<p>Reverse acting or Direct acting signal for Analog output signals <b>DA</b> = Direct acting, 0 to 100 % = 0 to 10 Vdc <b>RA</b> = Reverse acting, 0 to 100 % = 10 to 0 Vdc</p>
<p><b>Reheat</b> Default value: <b>0 = 15 minute</b></p>	<p>Sets the reheat output time base Valid only if reheat sequences are enabled <b>0</b> = 15 minutes <b>1</b> = 10 seconds for Solid state relays</p>
<p><b>UI3 dis</b> Display UI3 value.</p>	<p>Used as diagnostic / service help to troubleshoot and diagnose sensor operation Supply or change over temperature when UI3 is configured as an analog input ( SS or COS )</p>

## Specifications

Thermostat power requirements:	19-30 Vac 50 or 60 Hz; 2 VA Class 2
Operating conditions:	0 °C to 50 °C ( 32 °F to 122 °F ) 0% to 95% R.H. non-condensing
Storage conditions:	-30 °C to 50 °C ( -22 °F to 122 °F ) 0% to 95% R.H. non-condensing
Temperature sensor:	Local 10 K NTC thermistor
Temperature sensor resolution:	± 0.1 °C ( ± 0.2 °F )
Temperature control accuracy:	± 0.5 °C ( ± 0.9 °F ) @ 21 °C ( 70 °F ) typical calibrated
Humidity sensor and calibration:	Single point calibrated bulk polymer type sensor
Humidity sensor precision:	Reading range from 10-90 % R.H. non-condensing 10 to 20% precision is 10% 20% to 80% precision is 5% 80% to 90% precision is 10%
Humidity sensor stability	Less than 1.0 % yearly (typical drift)
Dehumidification setpoint range:	30% to 95% R.H.
Occ, Stand-By and Unocc cooling setpoint range:	12.0 to 37.5 °C ( 54 to 100 °F )
Occ, Stand-By and Unocc heating setpoint range:	4.5 °C to 32 °C ( 40 °F to 90 °F )
Room and outdoor air temperature display range	-40 °C to 50 °C ( -40 °F to 122 °F )
Proportional band for room temperature control:	Cooling & Heating: 1.8°C ( 3.2°F )
Binary inputs:	Dry contact across terminal BI1, BI2 & UI3 to Scm
Contact output rating:	Fan relay output: 30 Vac, 1 Amp. Maximum, 3 Amp. in-rush Valve triac output: 30 Vac, 1 Amp. Maximum, 3 Amp. in-rush Valve analog: 0 to 10 Vdc into 2KΩ resistance min.
Wire gauge	18 gauge maximum, 22 gauge recommended
Dimensions:	4.94" x 3.38" x 1.13"
Approximate shipping weight:	0.75 lb ( 0.34 kg )
Agency Approvals all models:	<b>UL:</b> UL 873 (US) and CSA C22.2 No. 24 (Canada), File E27734 with CCN XAPX (US) and XAPX7 (Canada) <b>Industry Canada:</b> ICES-003 (Canada) <b>FCC:</b> Compliant to CFR 47, Part 15, Subpart B, Class A (US) <b>CE:</b> EMC Directive 89/336/EEC (Europe Union) <b>C-Tick:</b> AS/NZS CISPR 22 Compliant (Australia / New Zealand) Supplier Code Number N10696
Agency Approvals Stand-Alone, BACnet & LON models	<b>FCC:</b> Compliant to Part 15, Subpart C
Agency Approvals Wireless models	<b>FCC:</b> Compliant to: Part 15, Subpart C

THIS DEVICE COMPLIES WITH PART 15 OF THE FCC RULES. OPERATION IS SUBJECT TO THE FOLLOWING TWO CONDITIONS: (1) THIS DEVICE MAY NOT CAUSE HARMFUL INTERFERENCE, AND (2) THIS DEVICE MUST ACCEPT ANY INTERFERENCE RECEIVED, INCLUDING INTERFERENCE THAT MAY CAUSE UNDESIRE OPERATION.

## Drawing & Dimensions

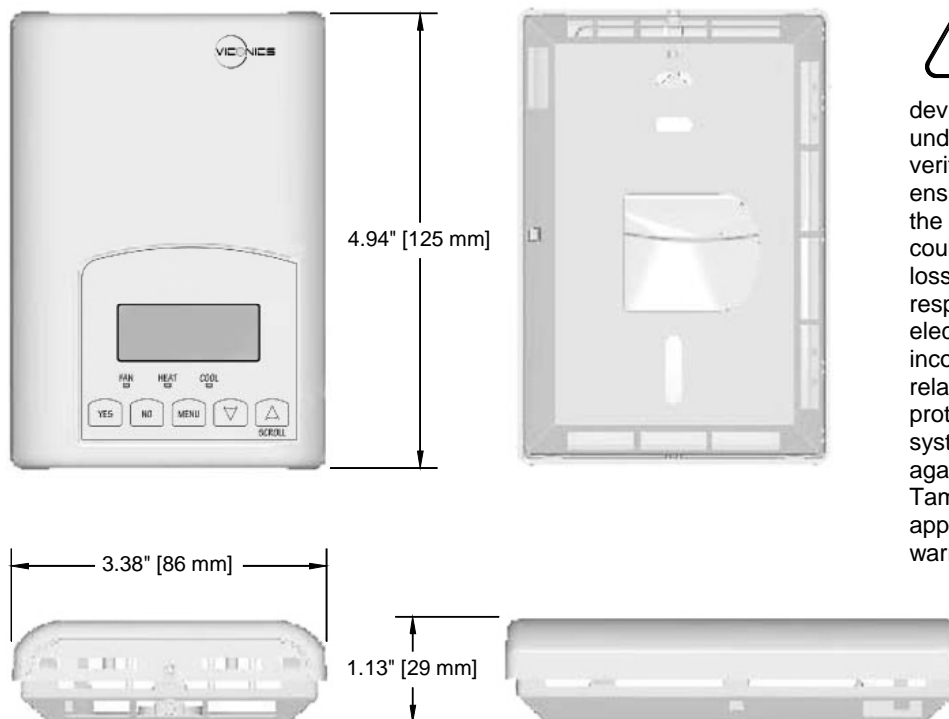

Fig. 13 – Thermostat dimensions

## Important Notice



All VT7300 series controls are for use as operating controls only and are not safety devices. These instruments have undergone rigorous tests and verifications prior to shipment to ensure proper and reliable operation in the field. Whenever a control failure could lead to personal injury and/or loss of property, it becomes the responsibility of the user / installer / electrical system designer to incorporate safety devices ( such as relays, flow switch, thermal protections, etc...) and/or alarm system to protect the entire system against such catastrophic failures. Tampering of the devices or miss application of the device will void warranty.