

**VIEW-MASTER®**



*Three Dimension*

**PHOTOGRAPHY**

*Welcome to*

# **VIEW-MASTER PHOTOGRAPHY**

**You have added another dimension (stereo) and the colors of the rainbow to your everyday picture taking. You will be one of the first to enjoy your own "Personal", full color, three dimension pictures,**

**To insure your enjoyment,**

**1. We have made this camera - this whole system of photography - as simple and easy to use as we possibly could, and,**

**2. We have written this instruction book to tell you, and show you with pictures, everything you must know to start taking pictures that will be truly satisfying and everywhere admired.**

## **SAWYER'S INC.**

*Home Office*

**Box 4903500 No.**

**Portland 7, Ore.**

*chicago Office*

**3500 No. Kostner Ave.**

**Chicago 41, Ill**

Copyright 1952 by Sawyer's Inc.-Revised Edition 1953  
Printed in U. S. A. ©Sawyer's Inc., Portland 7. Oregon  
Trade-Mark Reg. U.S. Patent Office-Marca Registrada

PRICE 25c

# INSTRUCTIONS

**Illustrated  
Instructions**  
Page

## PRE-LOADING CHECKS

- Turn SHIFT KNOB to "A" . . . . . 4
- Lock WINDING KNOB by turning.
- Set COUNTER to 20X OR 36X . . . . . 5

## LOADING

- Open camera and lay it face down on a table . . . 6
- Insert three perforations of film in slot of SPOOL . . . 7
- Engage magazine on slotted shaft . . . . . 8
- Fit film on SPROCKET and pull film tight.
- Close back of camera . . . . . 9

## INITIAL WINDING

- Turn WINDING KNOB three full turns . . . . . 10
- Check FILM ADVANCE INDICATOR . . . . . 10

## EXPOSURE - EASY METHOD

- Set CENTER DIAL for FILM SPEED.
- Set SHUTTER at
- Match proper SKY BRIGHTNESS to correct SUBJECT  
COLOR by turning the LENS OPENING DIAL . . 11

# INSTRUCTIONS

**illustrated  
Instructions**  
Page

## ADVANCING THE FILM

Turn WINDING KNOB a full turn after each exposure.

When Winding Knob LOCKS and  
Shutter will not CLICK, you have  
reached the important HALFWAY POINT. . . . 12

. . . then . . .

Turn SHIFT KNOB to "B".

Take last picture when COUNTER reads "19" or "36".

Wind FOUR times before unloading . . . . . 13

## UNLOADING

Unload in subdued light.

Tell processor, "Don't cut my roll" . . . . . 14

PERSONAL REEL MOUNTING. . . . . 14 & 15

LABELLED VIEW OF CAMERA. . . . . 16 17

Part Two

INFORMATION SECTION

See Page 18 for Table of Contents

## PRE-LOADING CHECKS

### 1. CHECK THE RED SPOT

If this opening shows BLACK, it is safe to open the camera.

If it shows RED, the camera is loaded. In this case, check the counter (see page 13) to see if it is safe to open the camera.

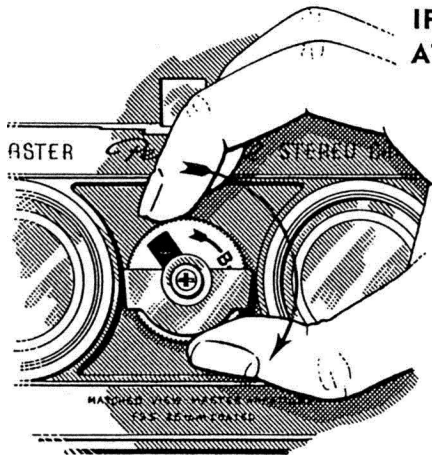
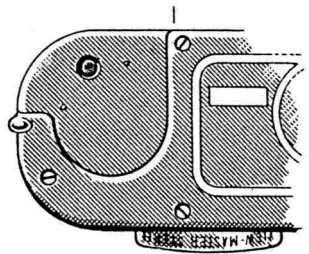

**IF SHIFT KNOB IS  
AT "B" . . . . .**

### 2. TURN SHIFT KNOB TO "A"

Turn until black square disappears. This will lock the lenses in their lower position.

SHIFT KNOB should look like this when you start to load your camera,

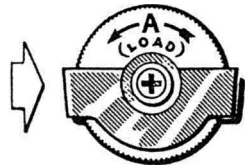

## PRE-LOADING CHECKS

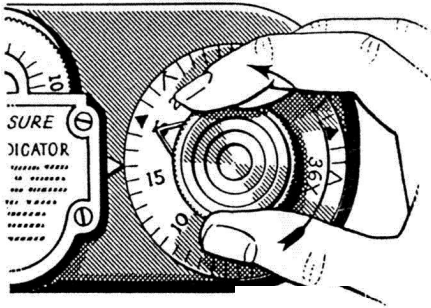

### 3. SET THE COUNTER

a. Turn the WINDING KNOB until it locks – until it will not turn in either direction.

b. Pull up AND turn to set COUNTER.

A continuous upward pull is necessary while you turn the WINDING KNOB.

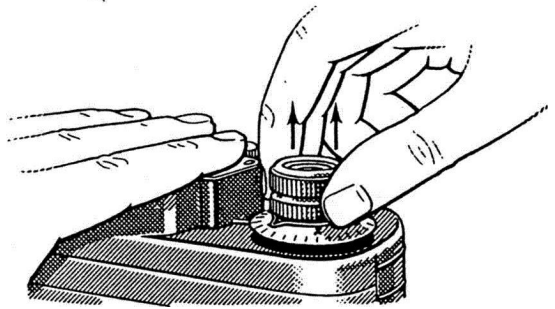

c. Set counter to . . .

. . . 20X for roll.

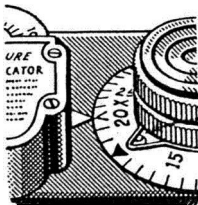

. . . 36X for 36-exposure roll.

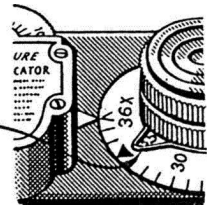

Set  
FILM LENGTH  
INDICATOR -35  
This will remind you when  
to stop taking pictures.

# LOADING

## THE FILM



		INDOORS		INCANDESCENT LIGHTS	OUTDOORS		SUNLIGHT
		A.S.A. FILM SPEED		FILTER	A.S.A. FILM SPEED		FILTER
KODACHROME	DAYLIGHT	4*		Kodachrome Filter for Photoflood Wratten No. 80	10		NONE
	TYPE A	16		NONE	10*		Type A Filter Wratten No. 85
ANSCO COLOR FILM	DAYLIGHT	3*		Anso Conversion Filter No. 10	12		NONE
	TUNGSTEN	12		NONE	12*		Anso Conversion Filter No. 11

\* == with Filter

AFTER completing pre-loading checks (pages 4 & 5) . . .

1. UNLOCK AND OPEN THE CAMERA BACK.

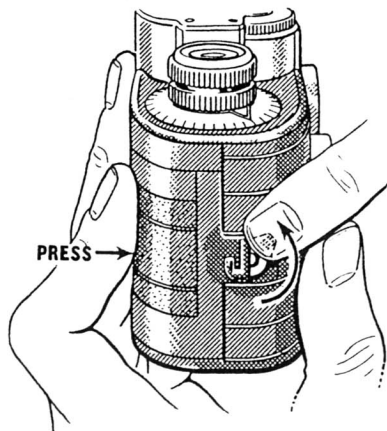

2. LAY CAMERA FACE DOWN ON A TABLE.

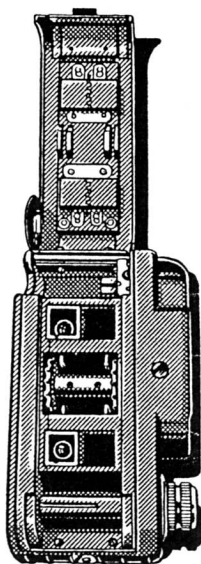

## LOAD FILM IN SUBDUED LIGHT

### 3. TURN SLOT OF SPOOL TO 45° POSITION

Roll SPOOL with your finger as pictured.

LOADING

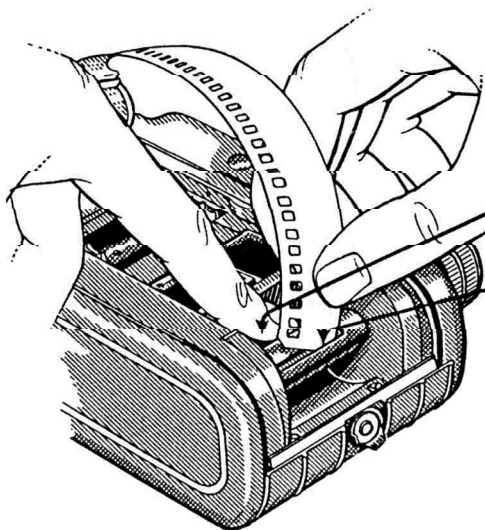
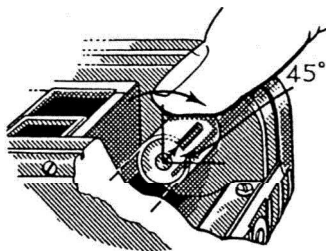

### 4. INSERT FILM END

- a. Press firmly to prevent SPOOL from slipping.
- b. Start film wise, then straighten.

c. Insert THREE PERFORATIONS of film, then slide film to the left as far as it will go.

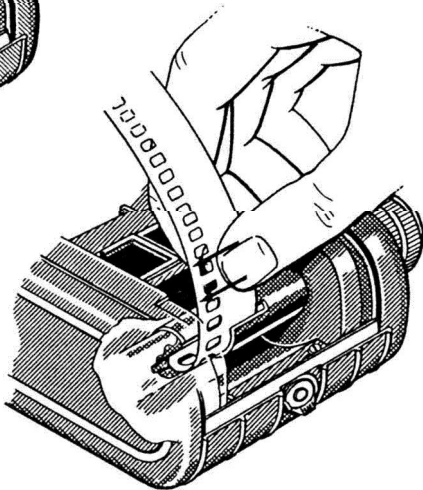



## LOADING

### 5. INSERT THE FILM MAGAZINE

a. Draw magazine towards the slotted shaft on which it fits. By holding film flat in the film channel, the amount of extra film which will be pulled out of the magazine can be held to a minimum.

b. Tilt magazine down UNDER the bracket.

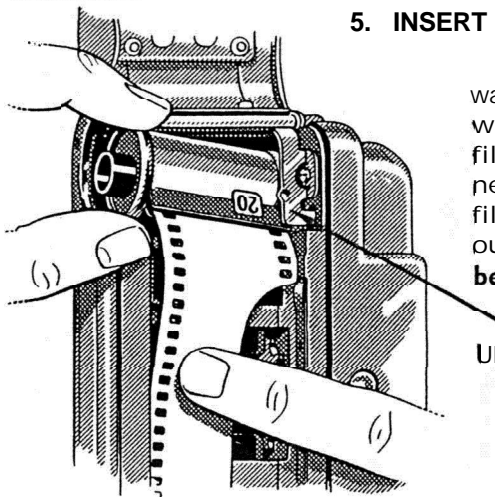

HOW MAGAZINE  
FITS SHAFT.

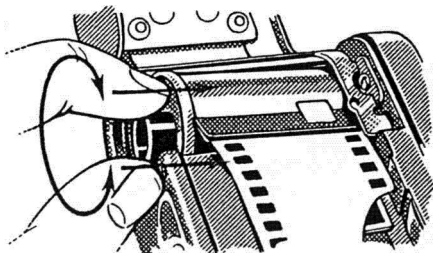
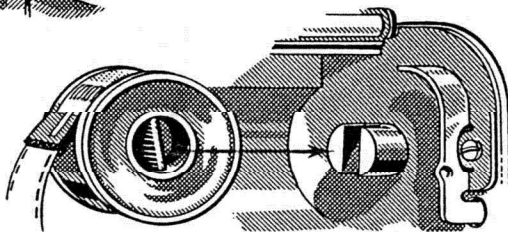

a. Turn the small end of the magazine and push until it pops into place.

## 6. FIT PERFORATIONS ON SPROCKET THEN PULL FILM TAUT AS SHOWN

The toothed SPROCKETS in the center of the camera drive the film in **and** out of the film magazine exactly 8 perforations each time the Winding Knob is turned a full turn.

The Wind-up Spool and the Magazine Drive Shaft turn to help advance the film, but are slip-clutched so they will not pull against the SPROCKETS.

a. Engage perforations on the teeth of the SPROCKET.

b. Roll wind-up SPOOL towards you pulling film reasonably tight.

7. CLOSE CAMERA BACK  
BE SURE LATCH IS LOCKED!

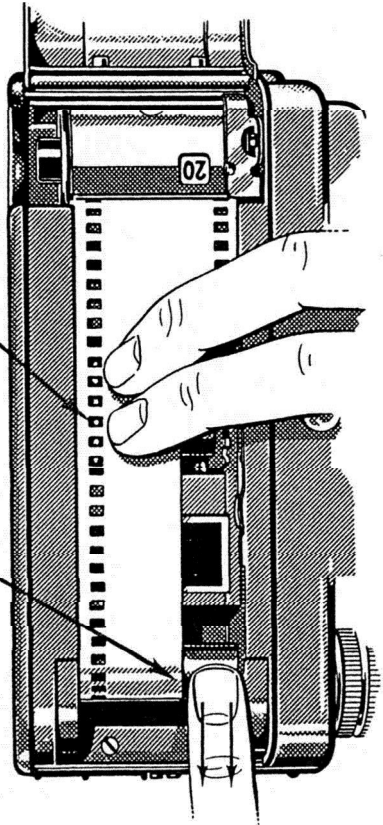
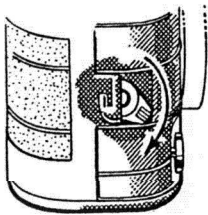

NOW, SEE NEXT **PAGE**  
9

## INITIAL WINDING

1. Click Shutter

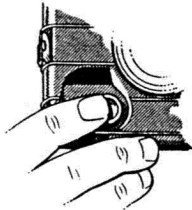

then

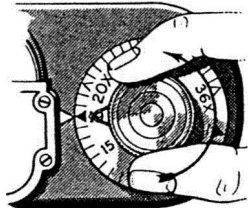

turn Winding Knob

Turn it a full turn until it locks - until it will not turn either way. The reference point will then point to 21 on the exposure counter scale of the Winding Knob, or to 37 for a 36-exposure roll.

2. Click Shutter then turn Winding Knob for a second time.

The exposure counter will then read 20 (or 36).

3. Click Shutter then turn Winding Knob for a third time.

The exposure counter will then read 19 (as pictured above) or 35, for 36-exposure rolls.

When the red cross of the Film Advance Indicator revolves, you know the film is winding properly. (See Exception below.)

The next time you CLICK the shutter, you will take your first picture!

## THE FILM ADVANCE INDICATOR

The red cross turns when the film magazine spool turns. This indicates movement of the film in or out of the magazine.

EXCEPTION: During the initial winding, the indicator may not start turning until the slack film is taken up.

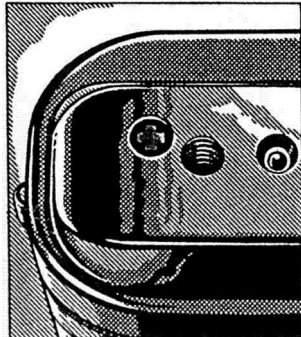

## EXPOSURE-EASY METHOD

1. TURN CENTER DIAL TO PROPER FILM SPEED- a. Use A.S.A. Numbers found on chart, page 6, or on data sheet that comes with your film.

b. Match A.S.A. Number to "summer" or "winter".

**NOTE:** Adjust only twice a year-Mar. 22 and Sept. 22, or for different speed film.

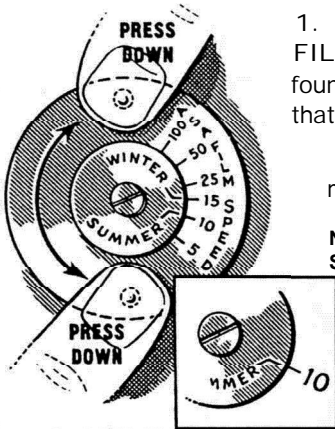

Example - FILM SPEED of "10" set to "SUMMER".

### 2. SET SHUTTER SPEED DIAL TO "50"

This means 1/50th of a second.

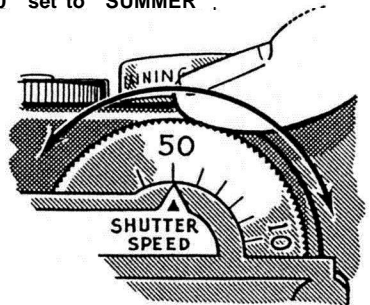

### 3. ADJUST LENS OPENING DIAL

This will move the CENTER DIAL and allow you to MATCH the proper SUBJECT COLOR to the existing SKY BRIGHTNESS.

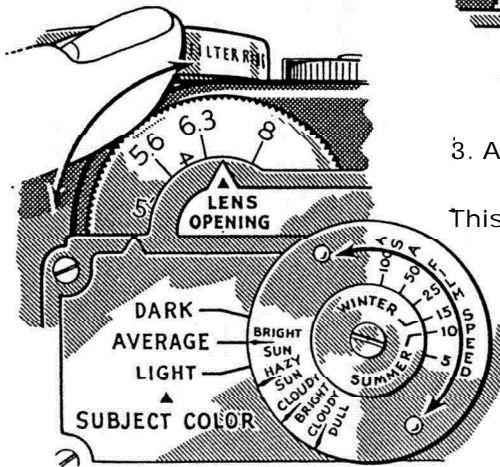

SKY BRIGHTNESS  
Pictured on Page 20.

## ADVANCING THE FILM

1. AFTER EACH EXPOSURE  
WIND ONE FULL TURN.

Caution: After winding, try to turn the Winding Knob both ways to be sure it is locked.

A full turn of the Winding Knob cocks the shutter, counts each exposure, and advances the film alternating the stereo pairs as pictured below.

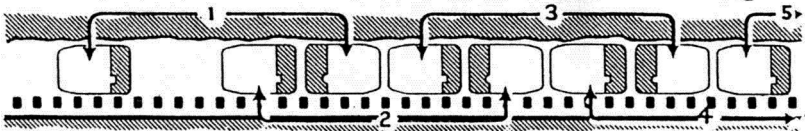
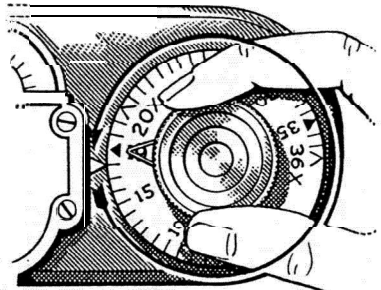

PICTURE COUNTING-The COUNTER will look like this as you take your first 19 pictures (first 35 pictures for 36-exp. roll for which counter will read "34, 33,32". etc.).

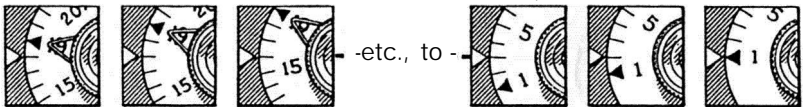

**DANGER!** Too much film used in loading or a roll cut short in manufacture can cause trouble.

SYMPTOM-WINDING KNOB becomes hard to turn while turning counter from 3 to 2, or 2 to 1. This means that all of the film but the attached end is out of the magazine: forcing the WINDING KNOB may tear free this end making it impossible to re-wind.

CURE-Turn SHIFT KNOB to "B", then, carefully, turn WINDING KNOB in the opposite direction (clockwise) until it locks. Now click the shutter (which may not be cocked) and turn another full turn.

## THE HALFWAY POINT

WINDING KNOB LOCKS SHUTTER WILL NOT CLICK

This happens after taking a picture at "1". Now, turn SHIFT KNOB as shown on next page.

## 2. TURN SHIFT KNOB TO "B"

Be sure black square disappears.

Then . . .

Turn WINDING KNOB a full turn clockwise to cock the shutter.

ADVANCING THE FILM

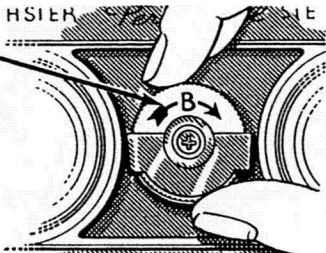

## PICTURE' COUNTING

Now as you take pictures, the COUNTER INDICATOR will point successively at 2, 3, 4, . . . etc. to . . . 16, 17, 18; or (for 36-exposure rolls) to . . . 32, 33, 34,

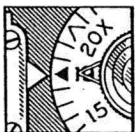

## 3. TAKE LAST PICTURE AT "19" OR "35"

The FILM LENGTH INDICATOR set properly when loading, will help you remember when to stop taking pictures.

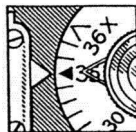

## 4. BEFORE UNLOADING, TURN WINDING KNOB FOUR FULL TURNS

Click the shutter each time.

This winding will draw your last exposure into the light-proof magazine.

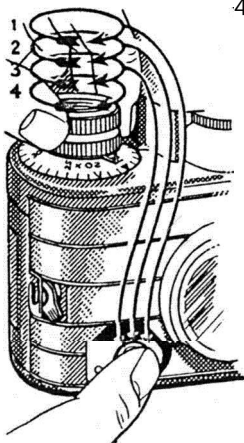

**THE BOTTOM PLATE OF THE CAMERA  
WILL HELP YOUR MEMORY.**



## UNLOADING

### UNLOAD IN SUBDUED LIGHT- NEVER IN DIRECT SUNLIGHT!

When you open the camera back, take out the film and immediately place it in the safety of its metal container.

TELL THE FILM PROCESSOR,  
"DO NOT CUT!"

KODAK FILM-Cut off the corner of the MAILING LABEL.

OTHER FILM-Write "Do Not Cut" on your order.

You want your roll of film back UN CUT!



THE VIEW-MASTER FILM CUTTER quickly registers and die-cuts Stereo Pairs from the COMPLETE, UNCUT roll of developed film. See next page.

### THE THREE CHOICES

When your film is developed and returned, it is ready to be mounted in View-Master Personal Reels. There are three ways to do this.

1. MOUNT THEM YOURSELF - It is easy and economical- the equipment will soon pay for itself. You will enjoy and appreciate your pictures more if you edit and mount them yourself. You need only the inexpensive View-Master Film Cutter and blank Reels carried by your View-Master dealer.

2. TAKE THE FILM TO YOUR VIEW-MASTER DEALER- He will carefully mount them in Personal Reels and return them to you promptly for a modest fee.

3, SEND THEM DIRECT TO SAWYER'S INC.-If no dealer in your area offers a mounting service, you may send the film to Sawyer's Inc.

## PERSONAL REEL MOUNTING

### MAKE YOUR OWN REELS! IT'S EASY! IT'S FUN!

Each Reel of 7 Stereo Pairs can be a "production" that "stars" your family and friends. More than just a photographer, you will be author, director and film editor. Your Reels will be picture stories admired by everyone.

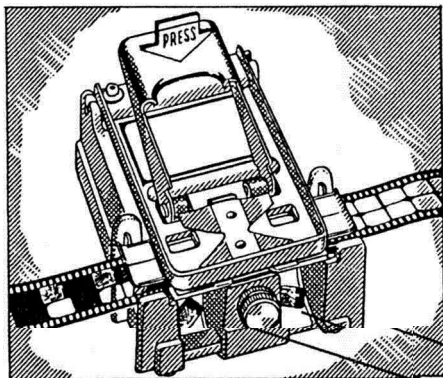

### THE VIEW-MASTER FILM CUTTER DOES THE WORK

You just fit the proper film perforations on a sprocket-press down—and an accurately die-cut Stereo Pair falls from the machine.

Turning the Film Advance Knob automatically registers the next pair.

### THE "L" AND "R" MARKS

These marks are photographically etched into each picture. To mount, you simply match a "R" marked picture to a "R" marked pocket. Then put the other half of the Stereo Pair, a "L" marked picture, into the opposite "L" marked pocket.



DIE-CUT  
FILM  
SLIPS  
INTO  
DIE-  
FORMED  
POCKETS

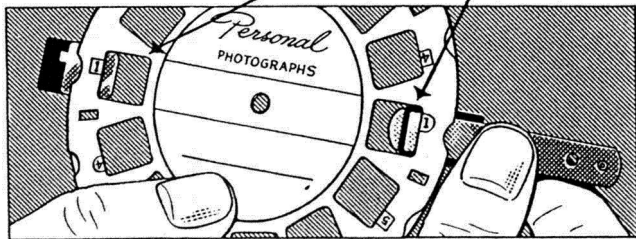



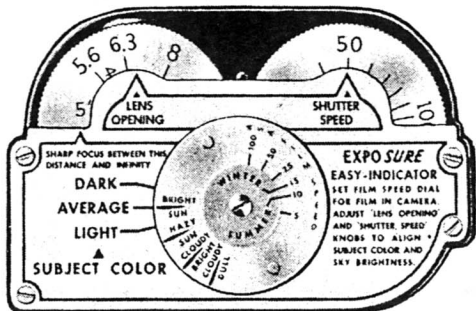

the *Revolutionary*  
COUPLED  
EXPOSURE CALCULATOR  
an  
Outstanding Feature  
of the  
**VIEW-MASTER *Personal***  
STEREO CAMERA

- Easy to operate, even for beginners.
- Based on easily-judged sky and cloud conditions.
- Calculates simply by matching two lines.
- Matching lines adjusts coupled Lens Opening and Shutter.
- Amazing accuracy even for color photography.

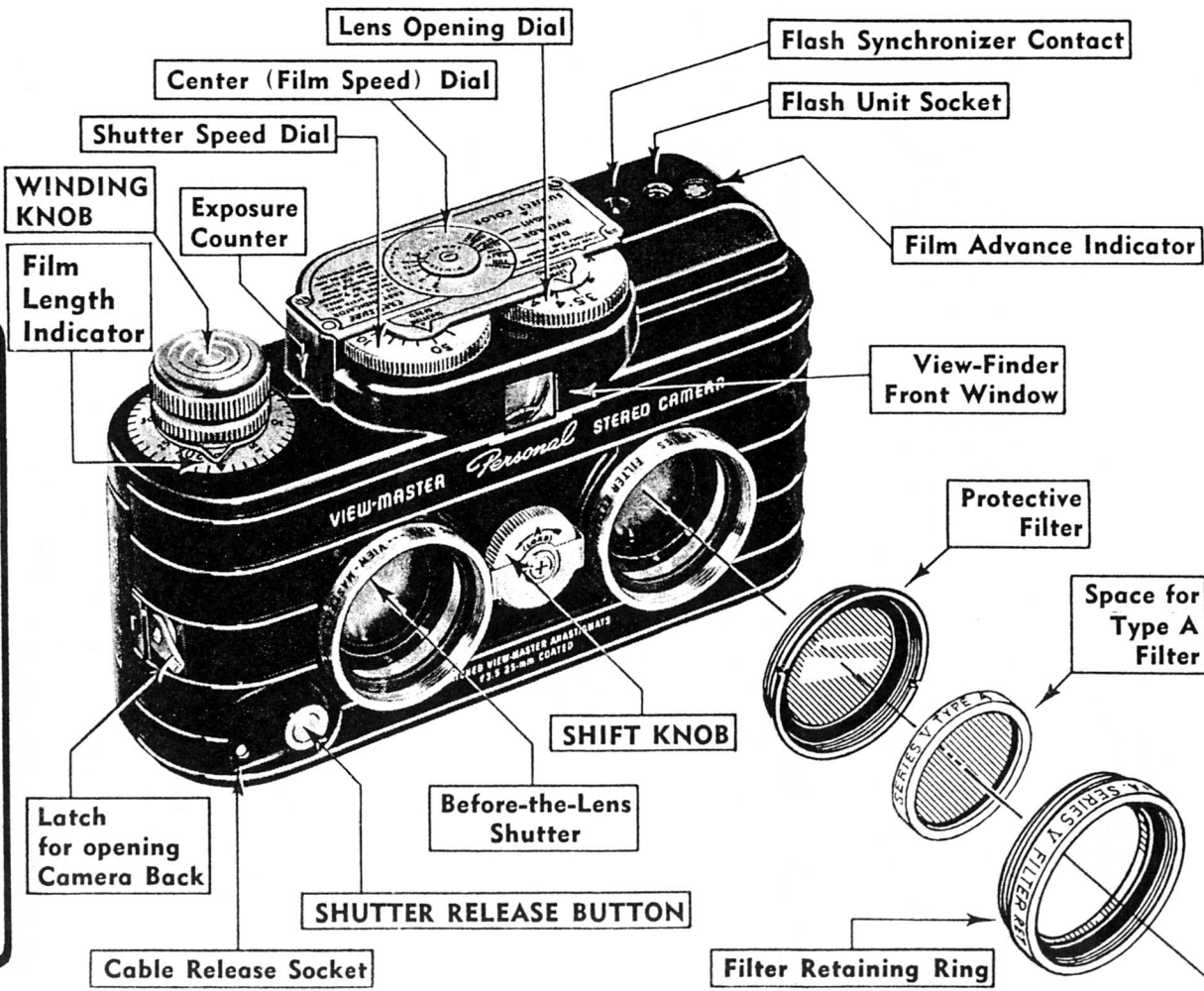

## **INFORMATION SECTION**

Pager

<b>How the Lens Shift Works . . . , . . . , .</b>	<b>19</b>
<b>Sky Brightness Pictures . . . . . ,</b>	<b>.20</b>
<b>Exposure-the Full Story . . .</b>	<b>21,22,23</b>
<b>Flash Pictures . . . . .</b>	<b>24 &amp; 25</b>
<b>Picture Taking Hints . . . . .</b>	<b>26,27,28</b>
<b>Care of the Camera . . . . .</b>	<b>29 &amp; 30</b>
<b>Camera Accessories . . . . .</b>	<b>31</b>
<b>Viewing Accessories . . . . .</b>	<b>32</b>

## THE "FILM MISER" LENS SHIFT

37 Stereo Pairs  
from a  
20-exposure magazine.

69 Stereo Pairs  
from  
36-exposure magazine.

### THIS IS HOW IT WORKS

Your first 19 stereo pairs, in a 20-exp. roll, alternate along the bottom half of the film.

Then, you turn the Shift Knob to "B".

This locks the lenses in a raised position and transforms the Winding Knob into a "Re-winding Knob".

You then take 18 stereo pairs along the top half of the film.

Shift Knob at "A"  
lenses lowered  
Stereo Pairs  
along bottom

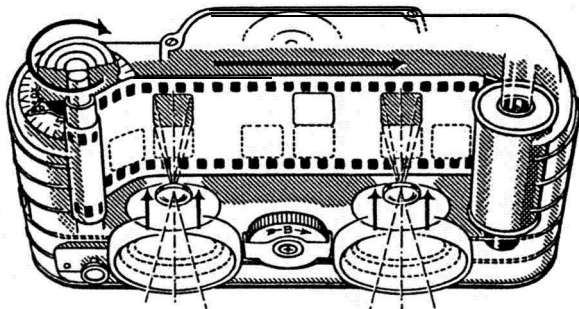
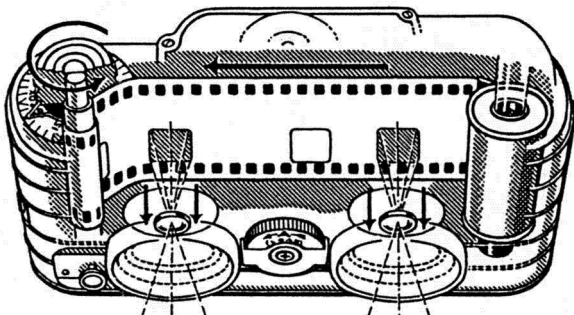

Shift Knob at "B"  
lenses Raised  
Stereo Pairs  
along top

# EXPOSURE --THE FULL STORY

## CALCULATOR BASED ON FRONT-LIGHTED SUBJECTS SUBJECT COLOR

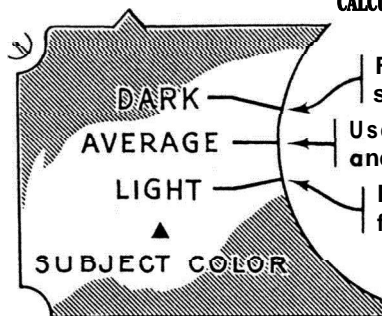

For dark complexions, dark foliage, subjects in light shade, etc.

Use this mark for most subjects and when in doubt.

For clouds, foaming water, delicate flesh tones, white buildings, etc.

**NOTE:** Use DARK or beyond for heavy shade. Use LIGHT or beyond for snow or beach scenes.

**BACK-LIGHTED SUBJECT**  
Bright Sun-Open 2 full stops  
Hazy Sun-Open a full stop

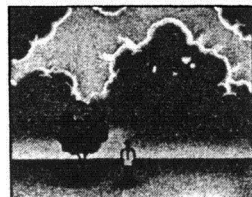
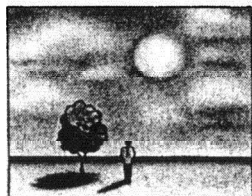

**SIDE-LIGHTED SUBJECT**  
Bright Sun-Open a full stop  
Hazy Sun -Open stop

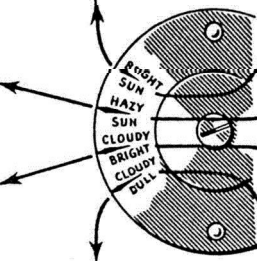
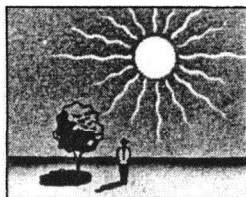

## SKY BRIGHTNESS

### BRIGHT SUN

Sun in clear sky or clouds not near sun.

### HAZY SUN

Sun's disk shows through haze or light clouds.

### CLOUDY BRIGHT

Clouds hide sun but bright area shows sun's approximate position.

### CLOUDY DULL

Heavy clouds nearly cover the sky.

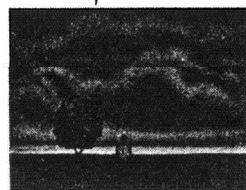

# EXPOSURE --THE FULL STORY

## CORRECT EXPOSURE MAKES THE PICTURE!

UNDEREXPOSED



COLORS DARKENED

CORRECT



COLORS BRIGHT AND TRUE

OVEREXPOSED



COLORS FADED OUT

You have learned the EASY METHOD. Now you want to learn more about Exposure-more about your Personal Camera.

### 1. THE LENS OPENING DIAL CONTROLS A LIGHT VALVE

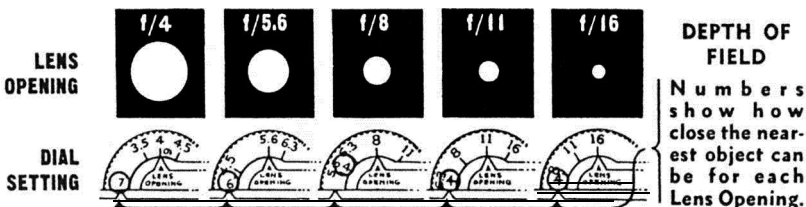

### 2. THE SHUTTER SPEED DIAL CONTROLS A TIMER

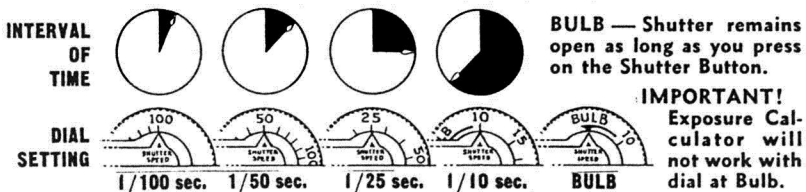

## EXPOSURE--THE FULL STORY

3. BOTH DIALS CONTROL THE CENTER DIAL TO CALCULATE CORRECT EXPOSURE

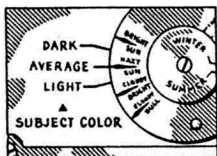
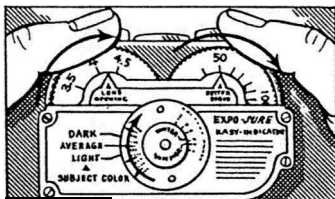

When you MATCH these lines for SKY and SUBJECT, as shown on page 20, you move the Dials to ONE COMBINATION of Shutter Speed and Lens Opening that gives CORRECT EXPOSURE.

4. MANY COMBINATIONS GIVE THE SAME EXPOSURE

Set these Dial Settings on your camera. Notice that both give the same exposure -MATCH the same lines.

1/100 sec.  at f/4



gives a lot of light for a short time.

1/25 sec.  at f/8

gives 1/4 as much light for 4 times as long.

5. CHOOSE THE COMBINATION TO FIT YOUR PICTURE

After you have correctly MATCHED Sky Brightness and Subject Color with one combination of LENS OPENING and SHUTTER SPEED, you will find many reasons for selecting another LENS OPENING or SHUTTER SPEED.

6a. HOW TO CHOOSE LENS OPENINGS

f/3.5    f/4    f/4.5



for POOR LIGHT

If it is Cloudy Dull, or Cloudy Bright, use one of these LENS OPENINGS instead of a SHUTTER SPEED less than 1/25

See Next Page

# EXPOSURE--THE FULL STORY

f/16



f/11



for EXTRA CLOSE-UPS

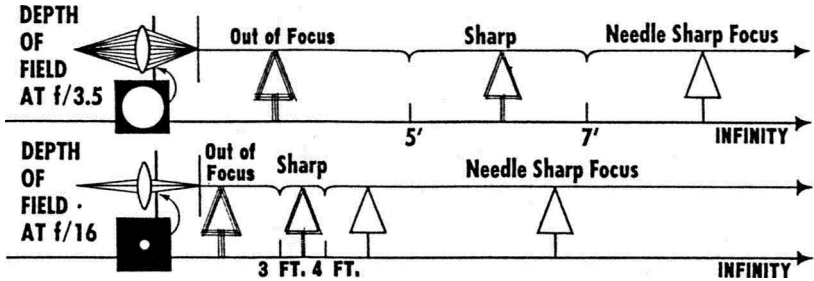

## 6b. HOW TO CHOOSE SHUTTER SPEEDS

1/50



for MOST SHOTS } Stops some action  
 Takes care of ordinary camera movement

1/100 to



STOP ACTION

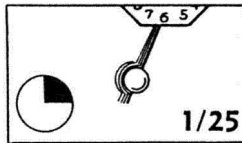

1/25

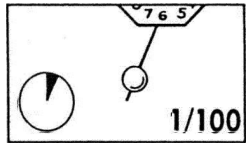

1/100

1/10

1/15

1/25



for POOR LIGHT, or } Extra sharpness - or Extra  
 Close-Ups in Bright Light

USE  
 TRIPOD  
 OR FIRM  
 SUPPORT  
 WITH  
 THESE  
 SPEEDS

BULB



for TIME EXPOSURES

} By holding shutter open for 80 secs.  
 at f/11 you can take a color shot in  
 ordinary room light.

R  
 E  
 V  
 I  
 E  
 W

Set FILM SPEED ON CENTER DIAL

MATCH proper SKY BRIGHTNESS and SUBJECT COLOR lines

Choose a LENS OPENING or Choose a SHUTTER SPEED

This may move the CENTER DIAL off CORRECT EXPOSURE, so:--

Turn Shutter Speed DIAL or Turn lens Opening DIAL

to RE-MATCH proper Sky Brightness and Subject Color

## FLASH PICTURES

**VIEW-MASTER**

FLASH ATTACHMENT

for the

*Personal* CAMERA

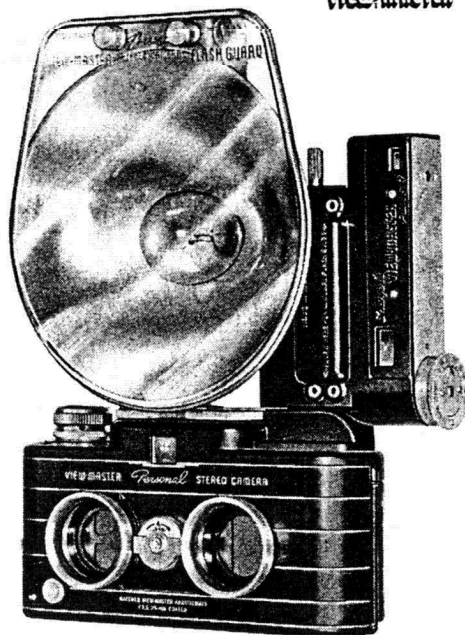

- Enables YOU to take wonderful flash pictures.
- Calculates correct exposure with an optical rangefinder.
- Has simple one-dial operation.
- Uses low cost midget flash bulbs.
- Equipped with plastic Flash Guard.
- Takes action, color shots anytime, anywhere.

### FOUR STEPS TO PERFECT FLASH PICTURES

#### 1. SET SHUTTER SPEED DIAL TO "25"

This "slow" shutter speed will allow the shutter to open, remain open during the brief "flash" of the bulb (about 1/200 of a second for SM bulbs) and then close.

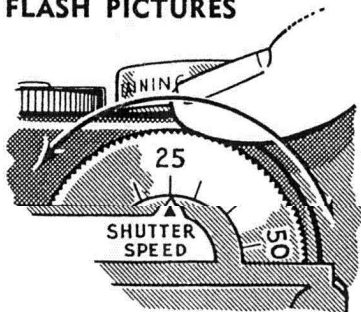



## FLASH PICTURES

### 2. SET INNER FLASH DIAL TO GUIDE NUMBER

Each combination of film, flash bulb and shutter speed has its own **GUIDE NUMBER**. See flash bulb carton for details. For example: 57 is the Guide Number for SM bulbs and Type A or Tungsten color film.

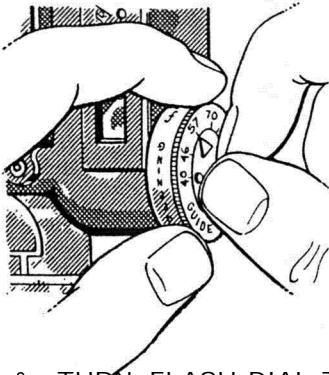

### 3. TURN FLASH DIAL TO MATCH SPLIT IMAGE

This measures the distance and automatically divides it into the **GUIDE NUMBER**. The result you read on the edge of the **FLASH DIAL** is a **LENS OPENING**.

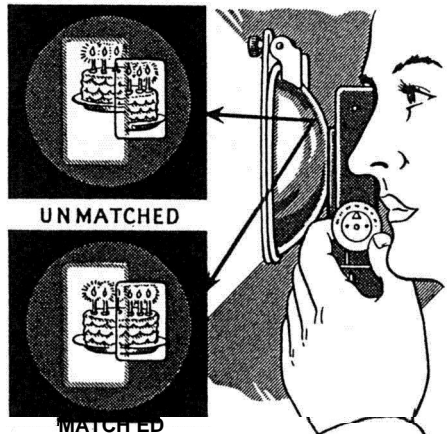

### 4. TURN LENS OPENING DIAL TO NUMBER SHOWN ON FLASH DIAL

This will give the **Correct Exposure** for the subject whose split image you have matched.

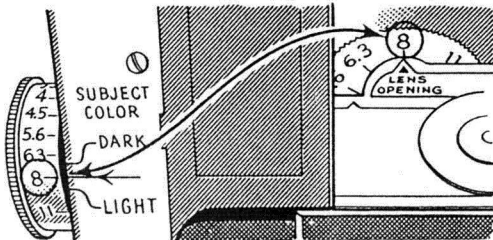

## PICTURE TAKING

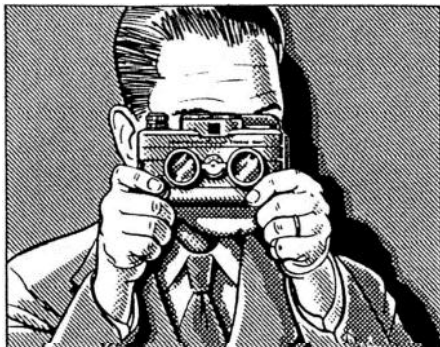

### 1. HOLD THE CAMERA RIGHT

Grip firmly, thumbs up-right along camera back.

Press against face for steadiness.

Press shutter button with right index finger.

Keep left index finger under filter ring -do not block the lens.

How NOT to hold the camera

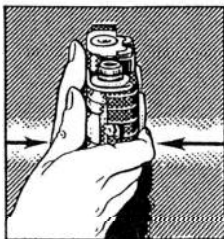
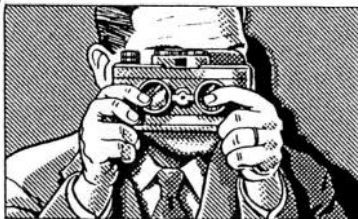

### 2. SQUEEZE THE SHUTTER

Jabbing the Shutter Button will jar camera causing blurred pictures.

"Squeeze off" each picture by tightening whole right hand. **Practice with** an unloaded camera.

### 3. USE A TRIPOD AND CABLE RELEASE FOR EXTRA SHARP PICTURES

To eliminate ALL camera movement, use a good tripod and a cable release (with either the ASA Straight Thread, American, or the ASA Taper Thread, European).

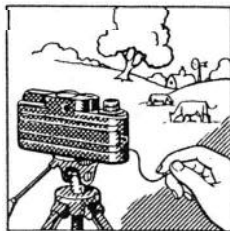

## PICTURE TAKING

### 4. USE VIEWFINDER CORRECTLY

← **THIS** Put your eye about ½ inch from the Viewfinder eyepiece. **NOT THIS** →

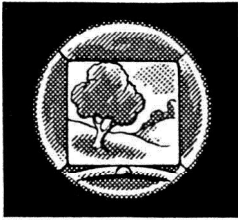

### ← **THIS** 5. COMPOSE YOUR PICTURE CAREFULLY

Keep the picture simple. Do not center your subject.



**NOT THIS** →

← **THIS**

Watch your backgrounds.



**NOT THIS** →

← **THIS**

Make action and lines lead into the picture.

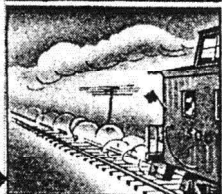
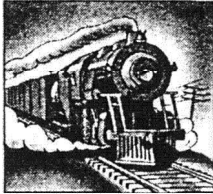

**NOT THIS** →

← **THIS**

Do not amputate your friends.

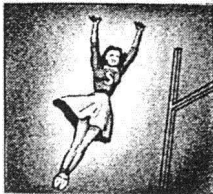

**NOT THIS** →

## PICTURE TAKING



**6. CENTER THE LEVEL BUBBLE TO LEVEL HORIZONTAL LINES.**

Don't photograph vorticls. You will have to view them like this.

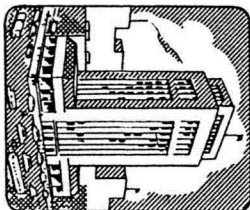

**7. CHECK YOUR FILTERS**

COLOR FILM	TUNGSTEN OR TYPE A		DAYLIGHT TYPE	
TYPE OF LIGHT FILTERS	FLASH and FLOOD	DAYLIGHT	FLASH and FLOOD	DAYLIGHT
NO FILTER	Perfect Color	Bluish, Cold Pictures	Red, Muddy Pictures	Perfect Color
ORANGE ★	Red, Muddy Pictures	Perfect Color	NEVER USE WITH THIS FILM	
BLUE ★	NEVER USE WITH THIS FILM		Perfect Color	Bluish, Cold Pictures

★ COLOR COWERSON FILTERS

Black Printing-Correct Filter Choice  
Red Printing-A Filter Mistake

## 8. THE SUN AND FLASH FOR YOUR BEST PICTURES.

a. **THE SUN**-When the sun is out and the sky is blue, you will get scenic pictures full of brilliant color and sparkling detail. When light clouds soften the sharp shadows, you will get your best outdoor portraits.

b. **THE FLASH PICTURE**-Indoors, flash shots are the easiest, most satisfying way to take pictures. Your indoor action shots will make photography a year 'round hobby.

**9. DUPLICATE REELS.** Sawyer's Inc. will duplicate Personal Reels, and some color processors duplicate entire strips of uncut film which you can cut and mount. However, originals are better and less costly, so take extra pictures for your, family and friends right at the scene!

## CARE OF THE CAMERA

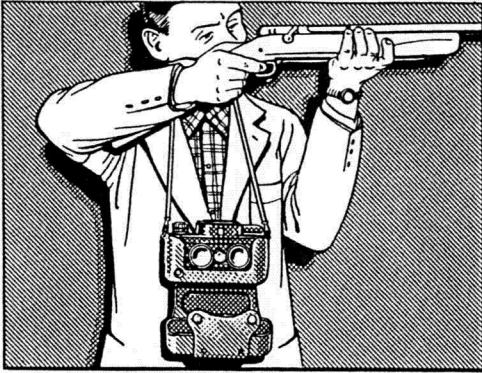

**HANDY AND SAFE**

1. PROTECT FROM DROPPING, HARD KNOCKS, RAIN, ETC.

Your View-Master Personal Camera is all-metal, and durably built but one fall could put it out of action.

A carrying case is the best protection you can give your camera.

2. DON'T "MUSCLE" THE MOVING PARTS!

All the dials and knobs will turn easily or not at all.

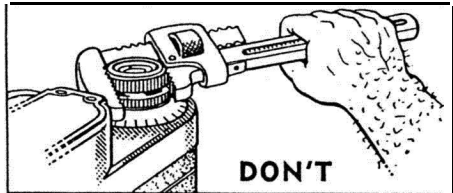

3. CHECK LENGTH OF YOUR TRIPOD SCREW.

If over  $\frac{1}{4}$  long, file it down before screwing it into your camera.

THIS LOCKS FOR FIRM SUPPORT.

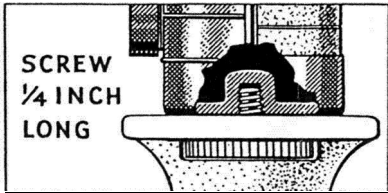

THIS RESULTS IN A WOBBLY, OR EVEN BROKEN CAMERA.

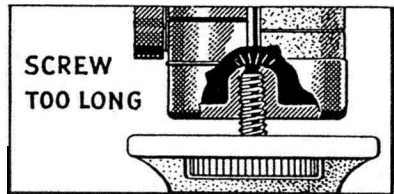

## CARE OF THE CAMERA

### 4. KEEP GLASS SURFACES CLEAN

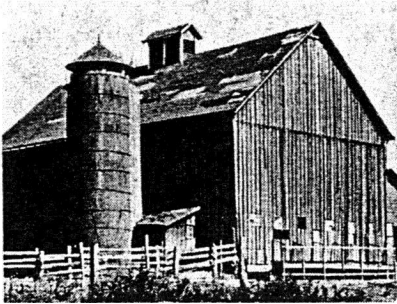

With CLEAN Lenses and Filters

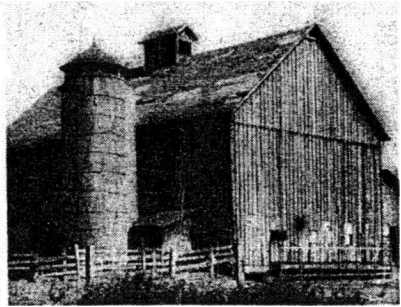

With DIRTY Lenses and Filters

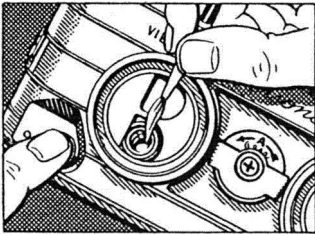

#### TO CLEAN LENSES . . .

Use only a soft brush!

**FRONT LENS**-Remove protective filter and hold shutter open to "BULB".

**REAR LENS**-Open camera back and set Lens Opening Dial to  $f/3.5$ .

#### TO CLEAN FILTERS . . .

Remove dust by brushing or blowing. Then breathe-on filter and polish with lens tissue or chamois.

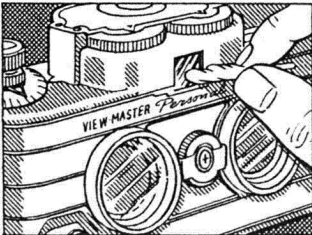

#### TO CLEAN VIEWFINDER . . .

Wrap chamois or lens tissue on a paper match. Breathe on the gloss and polish front and back window.

## CAMERA ACCESSORIES by **VIEW-MASTER**

CLOSE-UP ATTACHMENTS-24" and 36" models. Prism lenses give "natural" close-up pictures. With case.

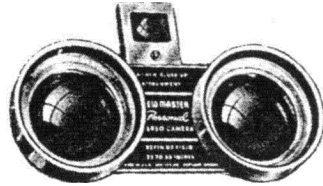

CAMERA CARRYING CASE -Top grade cowhide. Detachable, drop front.

"STEREO-MATIC 500" 3-D PROJECTOR  
-Twin-lensed, die-cast aluminum stereo projector. Matched, f/3.0 anastigmat lenses project 50-inch, 3-D, full-color image. 500-watt. split-beam illumination insures balanced lighting. Automatically focuses when images are registered on screen. Blower-cooled. Carrying case available.

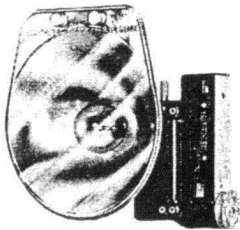
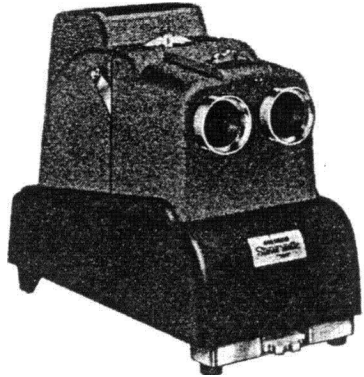

FLASH ATTACHMENT- Synchronized. Exposure simplified. See pages 24 and 25.

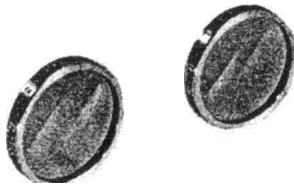

TYPE "A" FILTERS - Matched. Corrects Type A Tungsten Film for daylight use. Coated.

## VIEWING ACCESSORIES by VIEW-MASTER



*Personal* REELS - The patented 7-scene mounts that make stereo photography easy and economical. Die-formed pockets. See page 15.

**FILM CUTTER** - Die cuts stereo pairs for the Personal Reel. Makes stereo mounting fast, accurate and fun. See Page 15.

**FILM INSERTER** - for safe, quick and easy Reel mounting.

**STEREOSCOPE** - Compact, durable, easy to operate viewer.

**Uses** 'I-scene View-Master Reels. **Lever** scene changing.

**Model S-1 PROJECTOR** (Non-Stereo) - Cast aluminum body. F/3.0, coated Anastigmat lens. Brilliant 36-inch image.

**LIGHT ATTACHMENT** - Provides proper light source for viewing Reels in View-Master Stereoscope. Battery-powered.

**JUNIOR PROJECTOR** (Non-Stereo) - Low cost, plastic projector. F/3.0 Doublet lens.

**TRANSFORMER & CORD** - Replaces the batteries in the Light Attachment. Plugs into any 110-volt, A.C. source.

**SCENIC & STORY REELS** -- Professional photographs complete your stereo picture collection. Ask for complete Reel List.

**ALBUM** - Pocket-size, bound, tough, pliable, red leather-grained cover. holds 30 envelopes and Index Page for View-Master Reels.

