

V38r Rugged Handheld

with
Pocket PC 2003 Operating System

User Guide

ViewSonic® 
the choice of professionals

Copyright © ViewSonic Corporation, 2006. All rights reserved.

ViewSonic and the three birds logo are registered trademarks of ViewSonic Corporation.

Intel XScale is a trademark or registered trademark of Intel Corporation or its subsidiaries in the United States and other countries. Bluetooth is a trademark owned by its proprietor and used by Intel Corporation under license.

Microsoft, Windows, the Microsoft Internet Explorer logo graphic, ActiveSync, PowerPoint, Outlook, DirectX, DirectSound, Pocket Word, MSN, Pocket Excel, Pocket Internet Explorer, Microsoft Exchange, and the Windows logo are either registered trademarks or trademarks of Microsoft Corporation in the United States and/or other countries. ClearVue is a trademark of the Westtek Corporation.

Corporate names and trademarks are the property of their respective companies.

Disclaimer: ViewSonic Corporation shall not be liable for technical or editorial errors or omissions contained herein; nor for incidental or consequential damages resulting from furnishing this material, or the performance or use of this product.

In the interest of continuing product improvement, ViewSonic Corporation reserves the right to change product specifications without notice. Information in this document may change without notice.

No part of this document may be copied, reproduced, or transmitted by any means, for any purpose without prior written permission from ViewSonic Corporation.

Product Registration

To meet your future needs, and to receive any additional product information as it becomes available, please register your product on the Internet at: **www.viewsonic.com**. The **ViewSonic** product also comes with a CD-ROM that has a registration form that you can print and mail or fax to **ViewSonic Corporation**.

For Your Records			
Model Name:	ASV38r		
Model Number:	VS10418		
Document Number:	V38r-PPC_UG_ Rev1 F	4 January 06	
Serial Number:	_____		
Purchase Date:	_____		

Product disposal at end of product life

ViewSonic is concerned about the preservation of our environment. Please dispose of this product properly at the end of its useful life. Your local waste disposal company may provide information about proper disposal.

Contents

INTRODUCTION

Packaged contents	1
Features (if equipped)	2
Software installed	2
Front view	3
Back view	4
Side views	5

INITIAL SETUP

1.Remove the back panel	6
2.Slide the backup battery switch to ON	7
3.Install the battery	8
4.Replace the back panel and close the latch	9
5.Remove the protective cover (depending on model)	9
6.Connect AC power	10
7.Charge the battery overnight	10
8.Turn the power on	11

MORE ABOUT SETUP

Battery and power properties	12
Battery power status	12
The stylus	13
Calibrating the touch screen	14
Adjusting the stylus double-tap rate	14
Enable wireless	15

USING THE V38r

The Today screen	17
Status icons	18
Navigation bar and Command bar	19
Running programs	20
Pop-up menus	21
Notifications	21
Entering information	22
Entering text using the Input Panel	22
Writing on the screen	24
Drawing on the screen	27
Recording a message	28
Playing a message	29
Recording formats	29
Using My Text	30

MANAGING THE V38r

Managing power	31
Smart power management	32
Power-saving tips	33
Battery storage	33
Data storage	33
Managing memory	34
Storage and program memory	34
Memory cards	34
SD memory capabilities	34
SDRAM memory allocation	35
Memory map for 64/128 MB SDRAM	35
Antenna signal properties	35
Finding and organizing information	36
Customizing the V38r	37
Setting a password	38
Adding/removing programs	39
Adding programs	39
Removing programs	39
Backing up data	40
Using Backup	40

MICROSOFT ACTIVESYNC

Using Microsoft ActiveSync	42
Synchronizing data	43
Connecting to your PC	44
By USB cable	44
By infrared	44

POCKET OUTLOOK

Scheduling appointments/meetings	45
Creating an appointment	46
Using the summary screen	47
Creating meeting requests	47
Managing contacts	48
Finding a contact	50
Using the Summary screen	50
Tasks: keeping a To Do list	51
Creating a task	52
Using the Summary screen	53
Notes: capturing thoughts and ideas	54
Creating a note	54
Inbox: sending and receiving email	55
Synchronizing email messages	55
Using the message list	55
Managing email messages and folders	57

COMPANION PROGRAMS

Pocket Word	58
Using Pocket Word	58
Tips for working in Pocket Word	59
Pocket Excel	60
Tips for working in Pocket Excel	60
Windows Media Player for Rugged Handheld	61
Microsoft Reader	62
Getting books onto your V38r	62
Using the Library	63
Reading a book	64
Using reader features	65
Removing a book	66
Other programs	66

POCKET INTERNET EXPLORER

Using Pocket Internet Explorer	67
Viewing Mobile Favorites and Channels	68
Browsing the Internet	68
The Mobile Favorites Folder	69
Favorite links	69
Mobile Favorites	69
Conserving memory	70
Using AvantGo channels	70

GETTING CONNECTED

Connecting to a network or the Internet	71
Using an infrared connection	72
Wireless connection information	73
Wireless connection signal status	74
Wireless and network settings	74
WLAGS46F1 manual settings	74
VPN settings	75

THE CAMERA

Requirements	77
Install Active Sync & the camera application	77
To un-install the camera application	78
Launch the camera application	79
Take a picture	80
View picture	82
Delete a picture(s)	84
View pictures side-by-side	85
Compare one picture with another	86
Make the other side stationary	87
Download pictures	89
Changing the camera setup	89
Basic settings	90
Advanced settings	91
System settings	92
Exit the camera application	92

BAR CODE SCAN

Scan a bar code	93
Adding different bar code formats	93

TROUBLESHOOTING & MAINTENANCE

Reset the V38r	99
Warm reset – do this first!	99
Cold reset	99
Firmware image upgrade	100
Power problems	101
Memory problems	101
Screen problems	103
Device connection problems	104
USB dock/cradle connection problems	104
Infrared connection problems	105
Care and maintenance	105
Travel guidelines	106
Customer support	106
Wireless products disclaimer	106

APPENDIX

Optional accessories	107
Safety guidelines	108
Compliance and safety notices	110
Radio frequency interference (RFI) compliance	110
Data loss disclaimer	113
Specifications	114
Limited Warranty	115

INTRODUCTION

Congratulations on purchasing the **ViewSonic® V38r Rugged Handheld**. **Windows®** Pocket PC operating system enables you to keep your most important business and personal information up-to-date and close at hand. This section introduces you to the internal and external parts of the **V38r** and provides initial setup instructions.

Packaged contents

These items vary depending on the model shipped.

- The **ViewSonic V38r** may include front protective cover depending on model
- Quick Start Guide
- **V38r** battery
- AC power adapter
- AC power connector
- USB cable
- Dongle (for communication, AC power, with a USB-A mini and a USB-B port)
- Stylus (1) and stylus tether (1)
- **ViewSonic** CD with user guide(s), camera application, & **Active Sync**



For more information on Pocket PC software, go to this Microsoft Pocket PC website

<http://www.microsoft.com/windowsmobile/pocketpc/ppc/default.aspx>

Features (if equipped)

- **V38r** Rugged Handheld
- Dock/cradle connector for optional cradle for input devices
- Wireless 802.11b/g
- 1D CCD Bar code scanner
- Standard joy stick/navigation pad
- SD card slot for extended memory
- Rechargeable battery (Lithium Ion)
- Color display and touch screen
- Synchronize data between desktop/laptop computer and your **V38r**
- Microphone to record messages, internal speaker
- Fingerprint sensor (depending on model, instructions come with the SDK)
- Camera for snapshots (depending on model)

Software installed

The software listed below is already installed along with the **V38r PPC 2003** operating system. Your company's software development department most likely ensured that all software is set up for the **V38r** to perform its designated function(s) in the field.

- Internet Explorer
- Windows Explorer
- Media Player
- MS WordPad
- Microsoft Inbox
- Microsoft ActiveSync*
- Microsoft File Viewers
 - MS Excel Viewer
 - MS Image Viewer
 - MS PDF Viewer
 - MS Word Viewer

ActiveSync** allows you to synchronize your **V38r** with your PC. **ActiveSync** may be on a CD that came with your **V38r** depending on the model. But, for the latest version of **ActiveSync**, go to the **Microsoft** website to your PC and download **ActiveSync** to your PC. *For more information on installing **ActiveSync**, see the step in this guide to **Install MS ActiveSync on your PC.

Front view



Programmable buttons can be changed to a different shortcut/function in **Setup**.

Back view



Side views

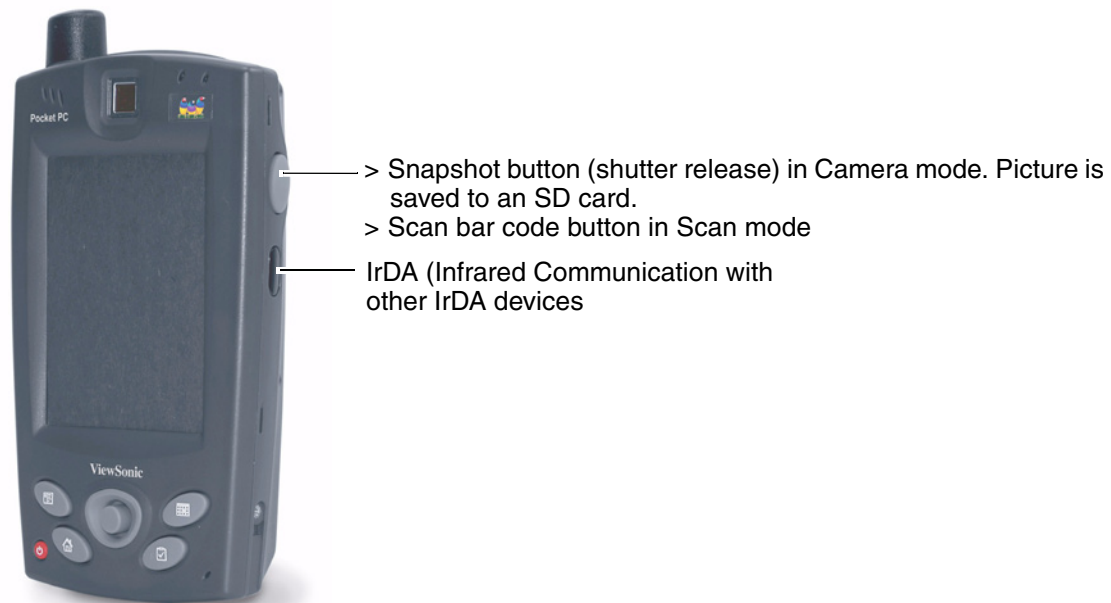

*The Secure Digital (SD) Memory Card is a flash memory storage device only and is not compatible with SD I/O cards.

INITIAL SETUP

The **V38r** allows you to connect to your PC to view and edit files, wirelessly send/receive email, and explore the World Wide Web. To get started, do the initial steps below. *For more information, see **More About Setup** in this guide.*

1. Remove the back panel

Turn the latch shown below counter-clockwise and remove the back panel.



2. Slide the backup battery switch to ON

Slide the backup battery switch in the battery compartment to the ON position. Leave the backup battery switch ON, especially when you need to change batteries.

WARNING! If you change batteries without the backup switch in the ON position, all data on SDRAM will be lost.



3. Install the battery

Slide the battery into the battery compartment making sure to line up the pin connections as shown below.

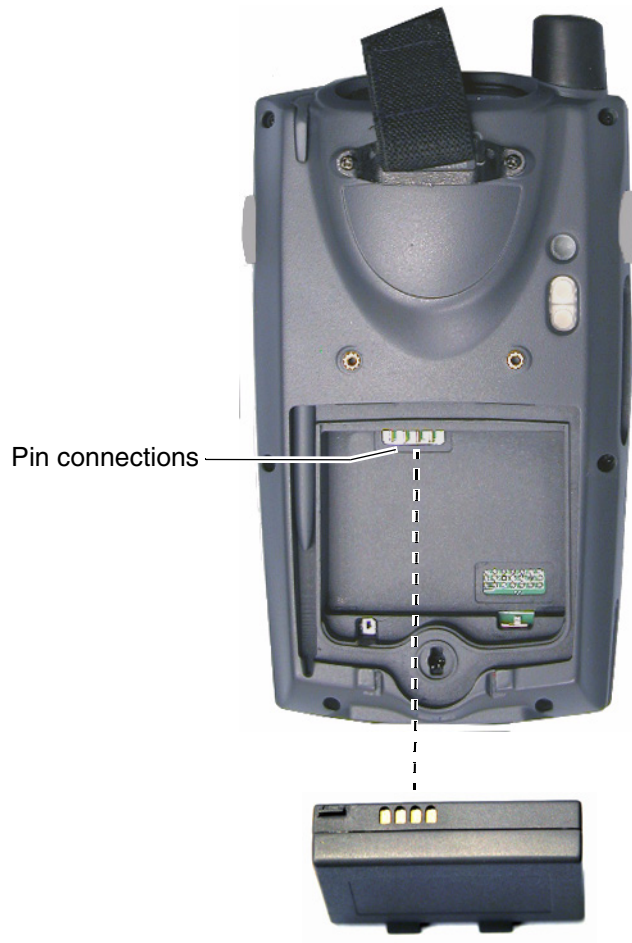

4. Replace the back panel and close the latch

Turn the latch clockwise to lock the panel.

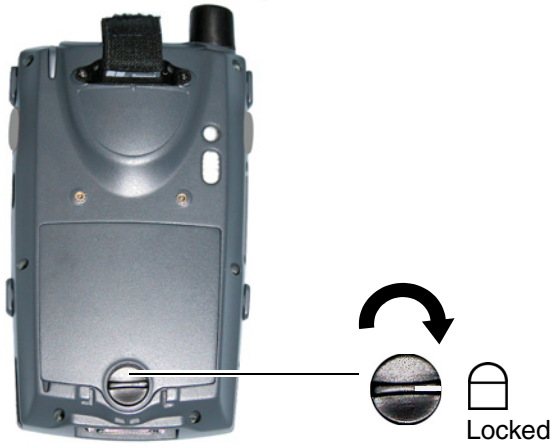

5. Remove the protective cover (depending on model)

Depending on the model shipped, a protective cover might be included in the package but not attached to the device. In any event, make sure the cover is off so you can start using the device. To remove the cover, pinch the sides as shown below and push the cover off.

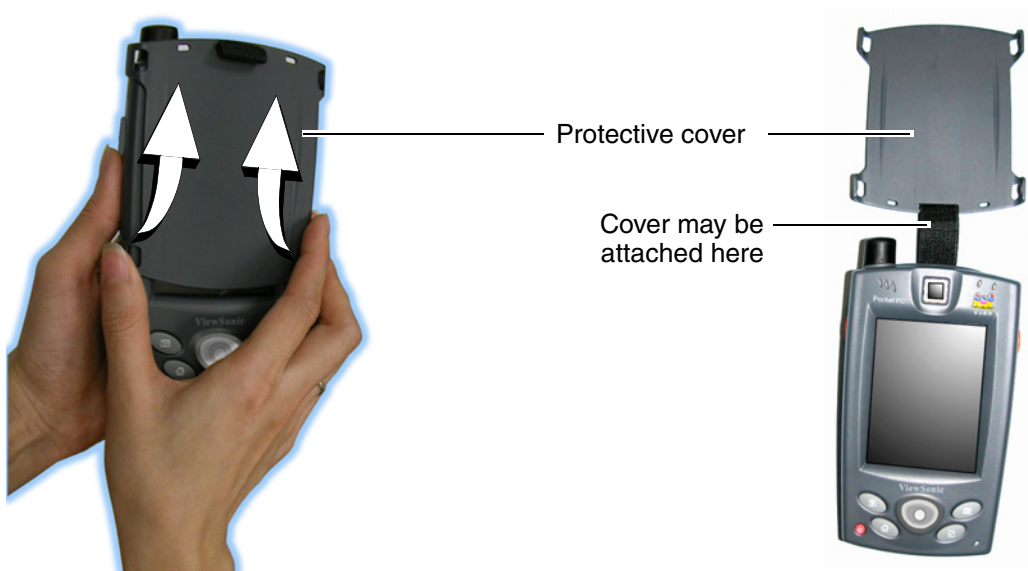

6. Connect AC power

Use only the cords that came with your **V38r**. Plug the **AC power connector** to the **V38r** while pinching the sides as shown below. Attach the connector to the **AC power cord adapter**. Plug the adapter into an AC power wall outlet.

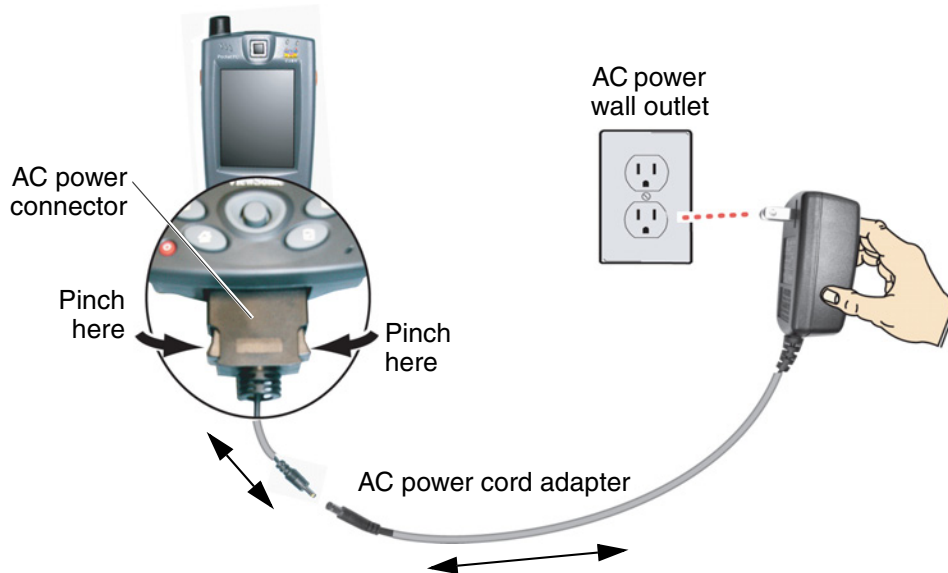

7. Charge the battery overnight

Charge the battery overnight to ensure that the battery is fully charged before using the **V38r** the first time.



WARNING! If the backup battery switch is in the OFF position when you remove the battery, all data on the SDRAM will be lost. Leave the backup battery switch in the ON position while using the device or changing the main battery.

8. Turn the power on

Press the power button. The **Power Status LED** turns green. **Initial Setup** is done. You can start using the **V38r**. For more information, see **MORE ABOUT SETUP** in this guide: includes **Battery and power properties, Reset, firmware upgrade, and wireless connection information**.

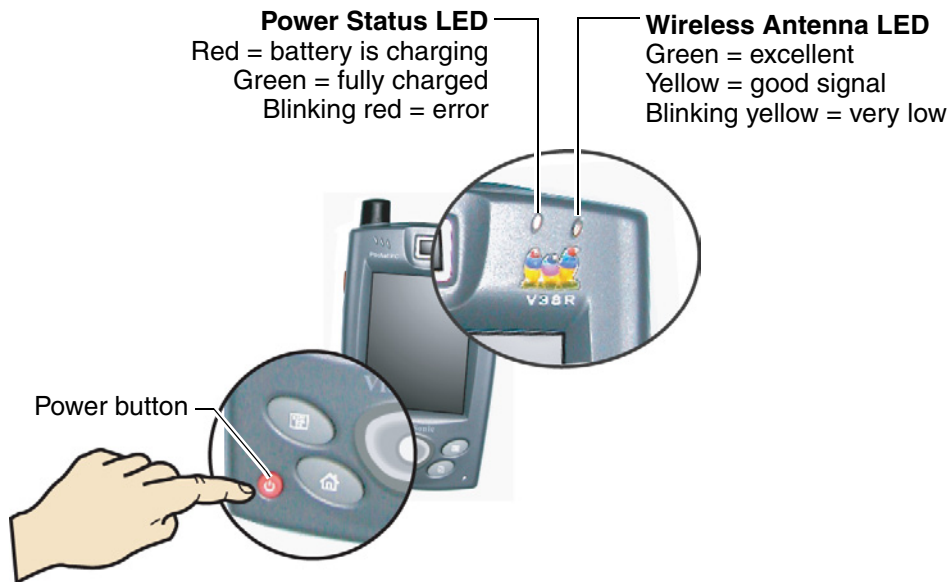

MORE ABOUT SETUP

Battery and power properties

Your **V38r** has several possible sources for power: battery or AC (using the AC power connector or the optional cradle). Use only the cable(s) that came in the package. **CAUTION:** Replace the battery with one of the following **V38r** series part numbers only:

- Standard Battery part number: BAT-002
- Extended Battery part number: BAT-001

After the **Initial setup**, the **V38r** recharges in approximately two (2) to three (3) hours while not using or four (4) hours while using the device. Normally, the **V38r** operates on battery power alone. A fully charged battery can last up to four (4) hours depending on power consumption factors such as the screen's brightness setting.



Extended back cover for extended battery (depending on model)



WARNING! If allowed to discharge completely for 2 ~ 4 weeks, the battery may not recharge. If you are not using the V38r on a daily basis, store the device plugged into an AC power wall outlet with the AC power adapter and AC power connector. **If you remove the battery from the device, you lose all data in SDRAM. That's why you have to keep the battery charged.**

Battery power status

To determine the main battery's current charge level, on the **V38r** tap the Window's **Start** button > select the **Control Panel** > tap the **Battery Power icon** > **Properties** > **Battery Status**. The **Battery Status** window opens with the percentage of power left in the main battery and rates the quality of the external power connection and backup battery as either Good, Low, or Very Low.

When the **V38r** is in the cradle and connected with the AC power cord adapter, the Power LED on top of cradle means the following:

- Red = battery charging
- Green = fully charged
- Blinking Red = error

The stylus

Use the stylus to “tap” or “double-tap” on the touch screen with icons and to select menu items. The stylus is also used to “type” on the Input Panel and to write notes when in handwriting recognition mode. The stylus that came with the device is designed for the **V38r** screen. Using other pointers could damage the screen and may void the warranty.

When the **V38r** is not being used, slide the stylus into the stylus slot on the top edge of the **V38r** shown below. To keep from losing the stylus, attach the stylus tether that came in the package to the bracket on the back of the **V38r**.

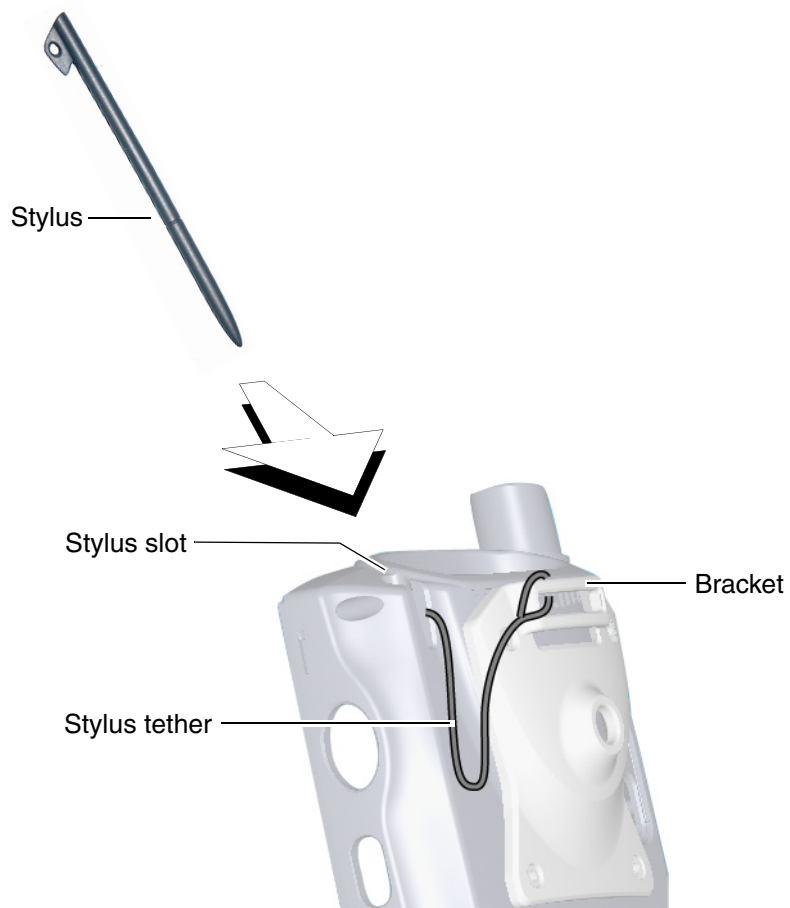

Calibrating the touch screen

If your touch screen is not responding accurately to taps with the stylus, you can recalibrate the screen as follows.

- 1 Tap Windows **Start** > **Settings** > **Control Panel** > **Stylus** > **Stylus Properties** > **Calibration** > **Recalibrate** (the cross hairs appear).
- 2 Follow the on-screen instructions to place the stylus on a cross-hair. Rather than just tapping the screen, hold the stylus in place for a second or two as directed until the program responds. Repeat this at each corner of the screen.
- 3 When finished, tap the screen. Recalibration is complete.



Adjusting the stylus double-tap rate

The double-tap rate can also be adjusted in the **Settings** window:

- 1 Tap Windows **Start** > **Settings** > **Control Panel** > **Stylus** > **Stylus Properties** > double-tap on the checkerboard graphic to set your double-tap rate.
- 2 Close the **Settings** window. To save your settings, press the power button which goes into **Suspend** mode > wait momentarily > press the power button again and resume working.

Enable wireless

Connect the **V38r** to a network or to the Internet using a wireless connection and a Network Encryption key. See your IT administrator for wireless setup information.

- 1 Tap **Start** > **Settings** > **System** > the **V38r Utility icon** []. A window appears showing the ROM version and the device id.
- 2 Tap the box at the bottom of the window saying **Wireless Card** > tap **Yes** to enable WLAN. The **WLAN LED** blinks as it searches. A **Connectivity** window appears. Wait for the list of wireless **APs (Access Point)** to appear. A screen like the one shown on the right appears. If you do not see the AP that you want, tap **Settings**. Select the **AP** that is available.
- 3 Enter the web encryption from your Administrator. Tap the **Network Key** tab.
- 4 Clear the box next to "**The key is provided for me automatically.**" Then, enter your network key in the network key field > tap **OK** at the top of the screen. Wait a few seconds till you see the symbol [] at the top of the screen that looks like a beacon to indicate the status. The status bar [] also appears at the bottom of the screen.

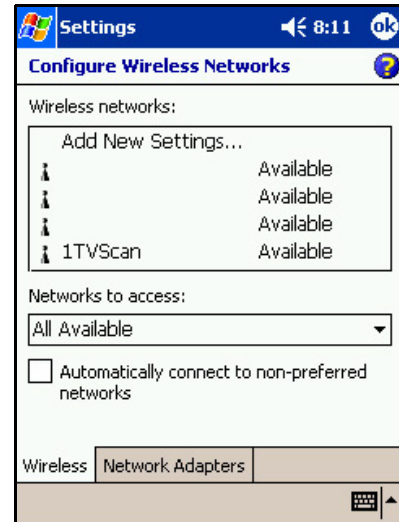

To verify that you are connected properly, tap **Start** > **Programs** > the **WMAGS46 icon** [] > the **Wireless Client window** appears to show the status of the device. To check the IP Address, tap **ADVANCED**. A pop-up appears > tap **Network Troubleshooting**. The IP Address assigned to your device appears > tap **OK**. You are now connected wirelessly!

To check the IP Address, tap **ADVANCED**. A pop-up appears > tap **Network Troubleshooting**. The IP Address assigned to your device appears. tap **OK**.

You are now connected wirelessly!

For more information

For information on:	See this source
Operating the V38r	V38r Hardware Guide (a PDF file on the ViewSonic V38r Companion CD.)
Programs on your V38r	V38r Hardware Guide and Help on your PC.
Additional programs that can be installed on your V38r	ViewSonic V38r Companion CD
Connecting to and synchronizing with a PC	V38r Hardware Guide or online Help. Tap Help on the Start menu to view Help.
ViewSonic Customer Support	Customer Support section in the Appendix of this guide
Troubleshooting	See the Troubleshooting section later in this guide
Last-minute updates and technical information	The Read Me files in the "Microsoft ActiveSync" folder on your PC or the ViewSonic V38r Companion CD
The latest on Windows Powered devices	The Microsoft Mobile Devices Web site: www.microsoft.com/mobile/

USING THE V38r

This section introduces you to the basics of working with programs and documents on your **V38r**.

The *Today* screen



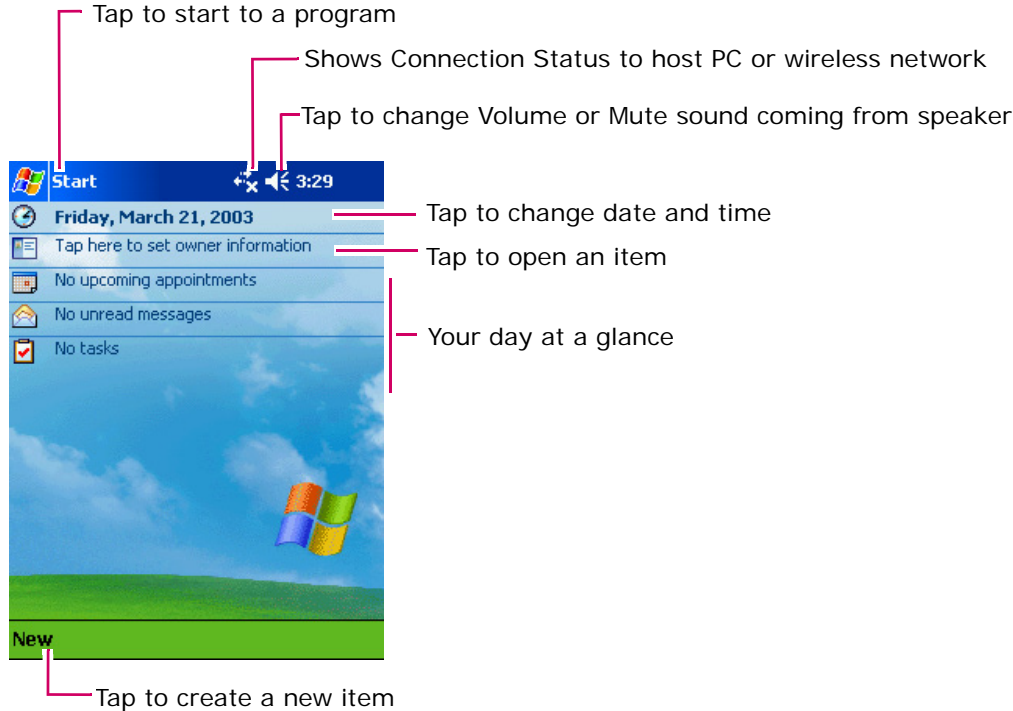





The **Today** screen shown below appears when you turn on your **V38r** for the first time each day or after four hours of inactivity. The **Today screen** shows at a glance important information for the day: current date, appointments, activities, new email, and create new documents.



Another way to show the **Today** screen is to tap the Windows **Start** button  > tap **Today**.

Status icons

From the **Today** screen appears, the status icons in the table below appear on the Command bar or on the Navigation bar (see next page). For more information, tap the icon and the associated control panel appears. For example, tap  to see information about the battery status.

Icon	Description
	Active Connection: there is an active connection to host PC or wireless network
	Inactive Connection: no active connection to host PC or wireless network
	Speaker is On
	Speaker is Off
	Main battery is low
	Main battery is very low
	Main battery is fully charged
	Synchronization is beginning or ending

Navigation bar and Command bar

The **Navigation bar** shown below is located at the top of the screen. It displays the active program and current time, and allows you to switch programs and close screens.

The **Navigation bar** and **Start** menu:

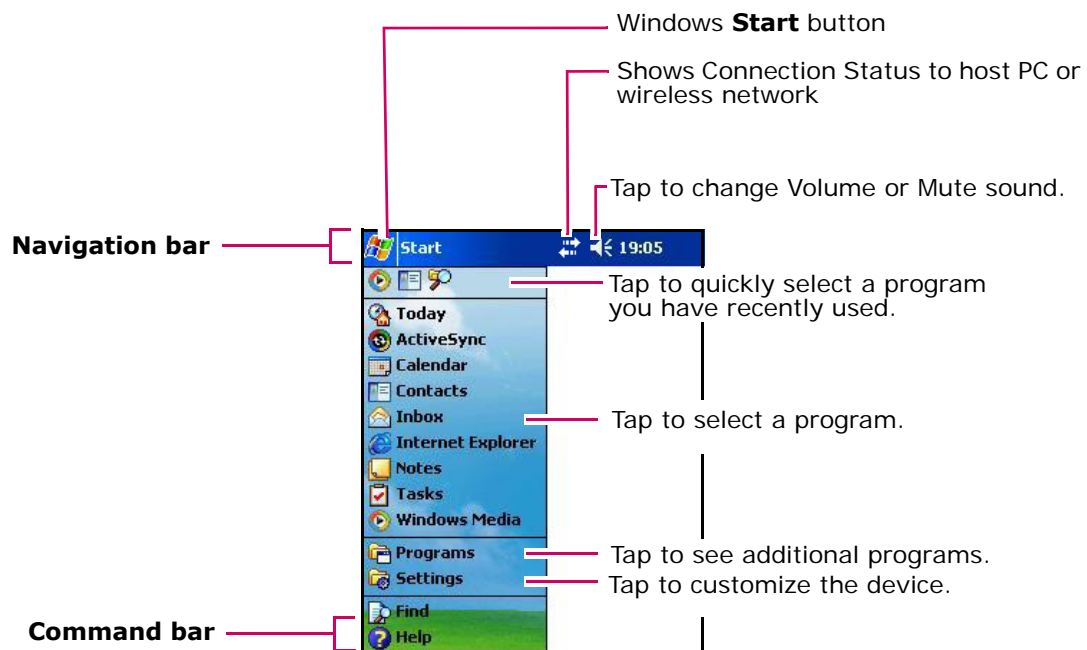

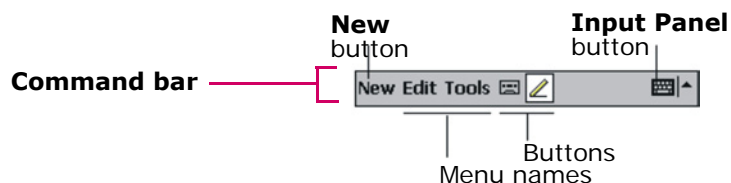

Use the Command bar at the bottom of the screen to perform tasks in programs. The Command bar includes menu names, buttons, and the Input Panel button. To create a new item in the current program, tap **New**. To see the name of a button, press and hold the stylus on the button. Drag the stylus off the button so that the command is not carried out.











Running programs

Depending on the program you want to run, you can:

- Tap  or tap **Start** at the top of the screen and select from the menu. (You can customize which programs you see on this menu. For information, see the section “Customizing Your **V38r**”).
- Tap  and then tap **Programs** to access additional programs. Tap the icon to run the program.
- Press program buttons on the front of your **V38r** to open the program. The icons on the buttons identify the programs they are associated with. (You can customize which programs are associated with the buttons. For information, see the section “Customizing Your **V38r**” in this guide).

The following table contains a partial list of the program icons on your **V38r**.

Icon	Program	Description
	ActiveSync	Synchronize information between your V38r and PC.
	Calendar	Keep track of your appointments and create meeting requests.
	Contacts	Keep track of your friends and colleagues.
	Inbox	Send and receive email messages.
	Pocket Internet Explorer	Browse Web and WAP (Wide Area Protocol) sites, and download new programs and files from the Internet.
	Notes	Create handwritten or typed notes, drawings, and recordings.
	Tasks	Keep track of your tasks.
	Pocket Excel	Create new workbooks or view and edit Excel workbooks created on your PC.
	Pocket Word	Create new documents or view and edit Word documents created on your PC.

Pop-up menus

With pop-up menus, you can quickly choose an action for an item. For example, you can use the pop-up menu in the contact list to quickly delete a contact, make a copy of a contact, or send an email message to a contact. The actions in the pop-up menu vary from program to program. To access a pop-up menu, press and hold the stylus on the name of the item that you want to perform the action on.

When the menu appears, lift the stylus, then tap the action you want to perform. Or tap anywhere outside the menu to close the menu without performing an action.

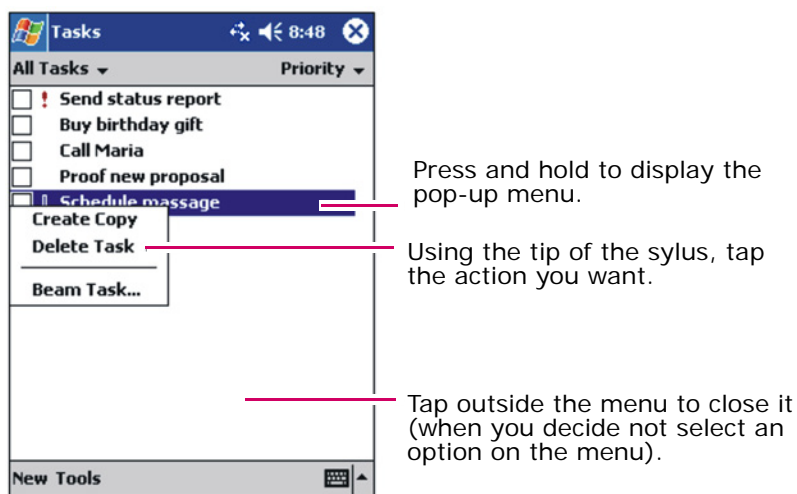

Notifications

Your **V38r** reminds you in a variety of ways when you have something to do. For example, if you have set up an appointment in **Calendar**, a task with a due date in **Tasks**, or an alarm in **Clock**, you will be notified in any of the following ways:

- A message appears on-screen.
- A sound, which you can specify, is played.
- The notification LED flashes.

To choose reminder types and sounds for your **V38r**, tap **Settings** on the **Start** menu. On the **Personal** tab, tap **Sounds & Notifications**.

Entering information

You have the following options for entering new information:

- Use the **Input Panel** to enter typed text, either by using the soft keyboard (on-screen) or other input methods.
- Write directly on the screen.
- Draw pictures on the screen.
- Speak into the microphone to record a message. *For more information on using the microphone, see the section on "Recording a Message".*

Entering text using the Input Panel

Use the **Input Panel** to enter information into any program on your **V38r**. As you type with the on-screen **Soft Keyboard** or write with the **Block Recognizer** or **Letter Recognizer** characters appear as typed text on the screen. *For more information on these options, see the next few pages.* But, first do the following:

- 1 Open a new or existing file in an application like **Word** or **Excel**. The **Input Panel** button appears at the bottom of the screen in the command bar.
- 2 Tap the **Input Panel** button as shown below > tap the arrow next to the **Input Panel** button. A menu appears.

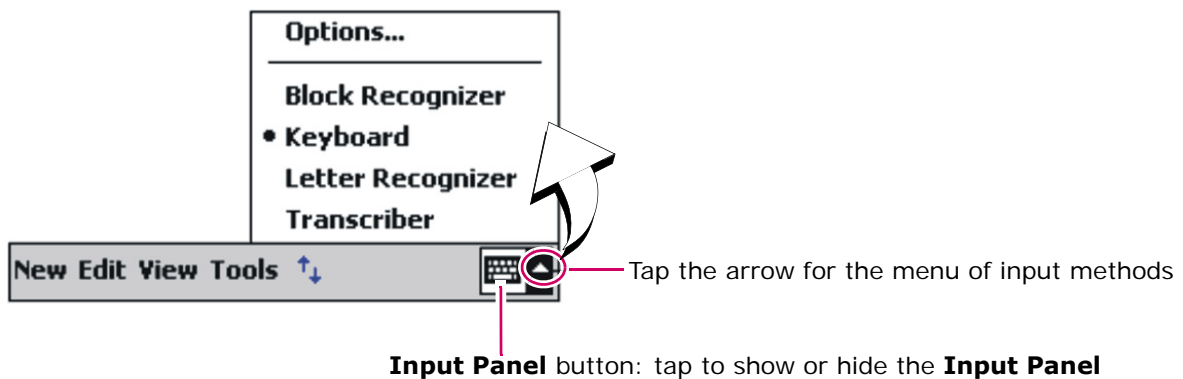

3 Tap one of the following input methods on the **Options** menu shown above: as you type with any of these options, the **Input Panel** anticipates the word you are typing or writing and displays the word above the Input Panel. The more you use the V38r, the more words it learns to anticipate. To change word suggestion options, such as the number of words suggested at one time, tap **Start** > **Settings** > **Personal Information** tab > **Input** > **Word Completion**.

- **Block Recognizer**: with the **Block Recognizer** option, a box appears at the bottom of the **Input Panel** where you can write a letter with the stylus to input characters and words. The letter is converted to typed text that appears on-screen. *For specific instructions on using Block Recognizer, open Block Recognizer, and then tap the question mark (?) next to the writing area.*
- **Keyboard**: an on-screen (soft) keyboard displayed at the bottom of the **Input Panel**. Tap the keys with your stylus.
- **Letter Recognizer**: write a letter in the box at the bottom of the Input Panel with the stylus like you would use a pen on paper. The text is converted to typed text. *For specific instructions on using Letter Recognizer, open Letter Recognizer and tap the question mark next to the writing area.*
- **Transcriber**: with **Transcriber** you can write anywhere on the screen using the stylus just as you would write with a pen on paper. Unlike **Letter Recognizer** and **Block Recognizer**, you can write a sentence or more of information; then, pause and let **Transcriber** change the written characters to typed characters. *For specific instructions on using Transcriber, open Transcriber, then tap the question mark in the lower-right corner of the screen.*

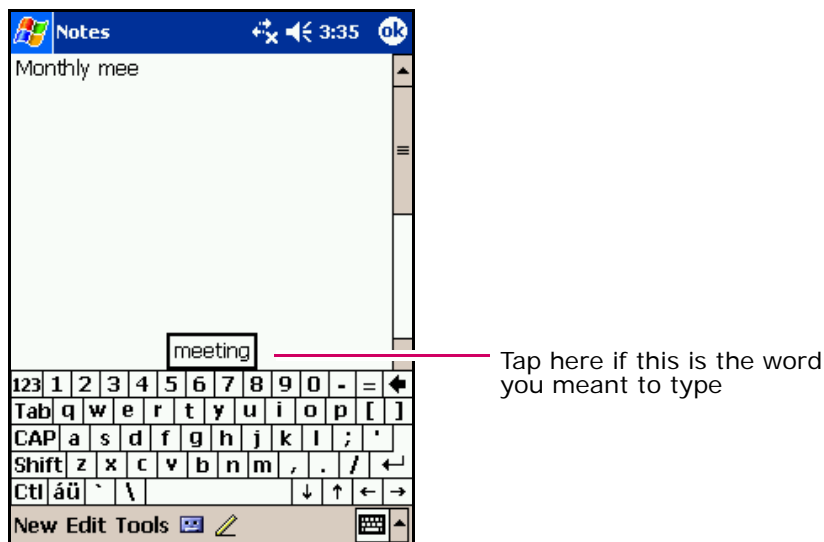

Writing on the screen

In any program that accepts writing—such as the Notes program and the **Notes** tab in **Calendar**, **Contacts**, and **Tasks**—you can use your stylus to write directly on the screen. Write the way you do on paper. You can edit and format what you have written and convert the information to text later.

To write on the screen, tap the **Pen** button to switch from tapping to writing mode. This action displays lines on the screen to help you write.

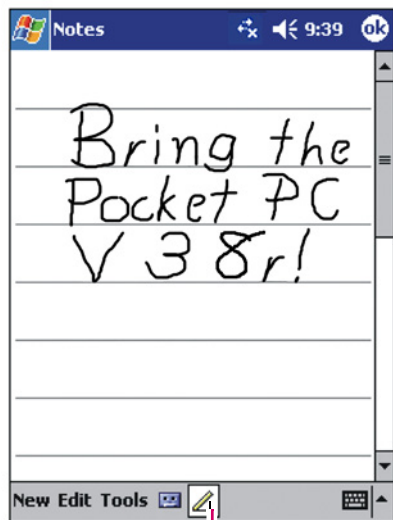

Tap the **Pen** button and use your stylus like a pen

Some programs that accept writing may not have the **Pen** button. See the documentation for that program to find out how to switch to writing mode.

If you want to edit or format writing, select it first. To select writing:

- 1 Press and hold the stylus next to the text you want to select until the insertion point appears.
- 2 Without lifting, drag the stylus across the text you want to select.

If you write accidentally on the screen, tap **Tools**, then **Undo**, and try again. You can also select text by tapping the **Pen** button to deselect it and then dragging the stylus across the screen.

You can cut, copy, and paste written text in the same way you work with typed text: press and hold the stylus on the selected words and then tap an editing command on the pop-up menu, or tap the command on the **Edit** menu. To convert writing to text, tap **Recognize** on the **Tools** menu.

If you want to convert only certain words, select them before tapping **Recognize** on the **Tools** menu (or press and hold the selected words and then tap **Recognize** on the pop-up menu). If a word is not recognized, it is left as writing.

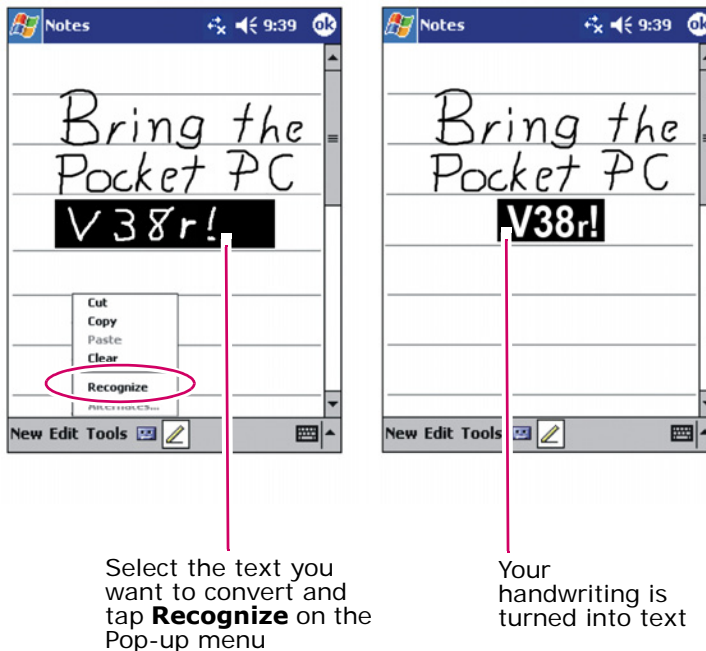

If the conversion is incorrect, you can select different words from a list of alternates or return to the original writing. To do so, press and hold the incorrect word (tap one word at a time). On the pop-up menu, tap **Alternates**.

A menu with a list of alternate words appears. Tap the word you want to use, or tap the writing at the top of the menu to return to the original writing.

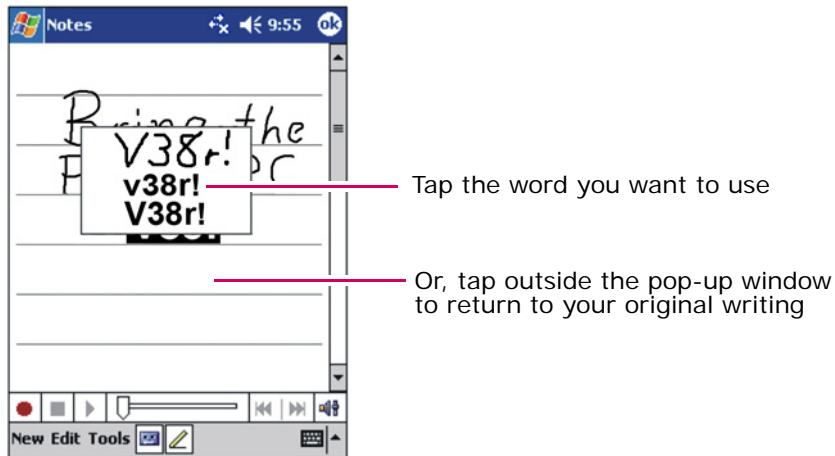

Some tips for getting good recognition are listed below:

- Write on the lines and draw descenders below the line. Write the cross of the "t" and apostrophes below the top line so that they are not confused with the word above. Write periods and commas above the line.

For better recognition, use the **Tools** menu to increase the zoom level to 300%.

- Write the letters of a word close together and leave big gaps between words.
- Hyphenated words, foreign words that use special characters such as accents, and some punctuation cannot be converted.
- If you add writing to a word to change it (such as changing a "3" to an "8") after you attempt to recognize the word, the writing you add will not be included if you attempt to recognize the writing again.

Drawing on the screen

Drawing on-screen is similar to writing on-screen except the way items are selected and edited. For example, selected drawings can be resized, but writing cannot be resized.

To create a drawing, cross three ruled lines on your first stroke. A drawing box appears. Drawings that do not cross three ruled lines will be treated as writing.

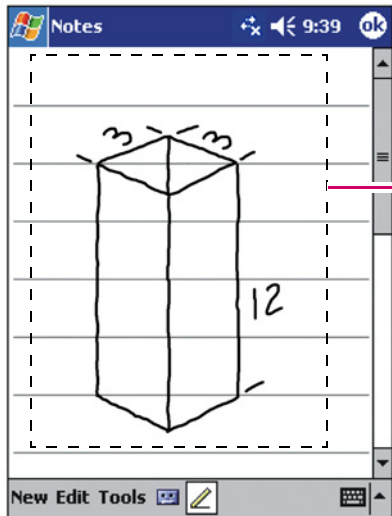

The drawing box indicates the boundaries of the drawing

You may want to change the zoom level so that you can more easily work on or view your drawing. Tap **Tools**, then choose a zoom level.

To edit or format a drawing, select the drawing first. To select a drawing, press and hold the stylus on the drawing until the selection handle appears. To select multiple drawings, deselect the Pen button and drag to select the drawings you want.

Cut, copy, and paste selected drawings, press and hold the selected drawing and tap an editing command on the pop-up menu, or tap the command on the **Edit** menu. To resize a drawing, make sure the Pen button is not selected, and drag a selection handle.

Recording a message

In any program where you can write or draw on the screen, you can also quickly capture thoughts, reminders, and phone numbers by recording a voice message. In **Calendar**, **Tasks**, and **Contacts**, you can include a recording in the **Notes** tab. In the **Notes** program, you can either create a stand-alone message or include a message in a written note. To include the message in a note, open the note first, then record your message. Or, in the **Inbox** program, add a message to an email message as follows:

- 1 Hold the **V38r**'s microphone about three inches from your mouth.
- 2 With a note open, press and hold the on-screen record button on the bottom of the screen as shown below. If the speaker is not muted, a beep indicates that your **V38r** is recording. While holding down the record button, speak into the microphone. You can also press the button on the left side of the device.

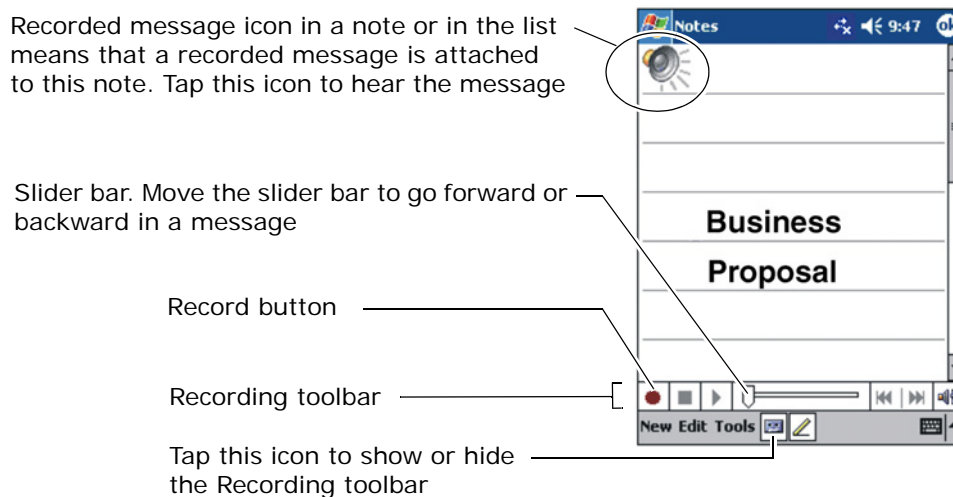

- 3 To stop recording, release the record button. Two beeps mean recording stopped. The new message is attached. The recorded message icon appears in the note list or in the note as shown above.

Playing a message

Tap the **Record** button in the list or in the note as shown below.

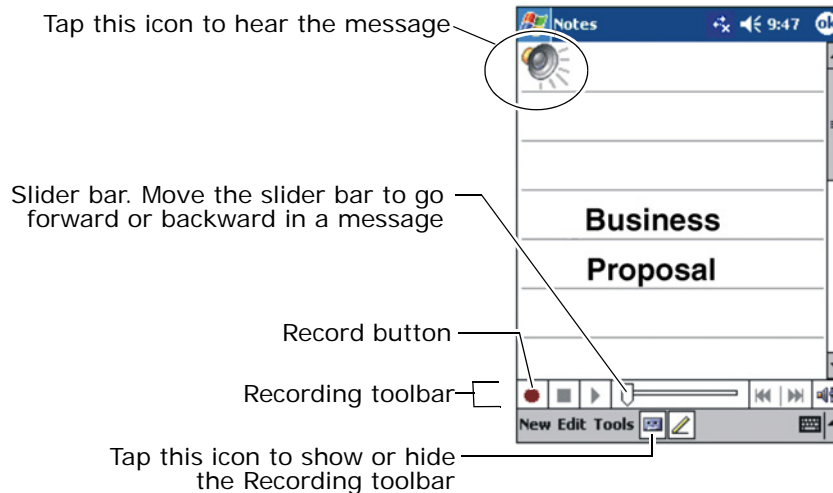

Recording formats

Your **V38r** supports several formats for voice notes. The formats vary in both the quality of the recording and the size of the sound file. When selecting a recording format, you should consider the quality you need as well as how much storage memory the recording will use on your **V38r**.

Not all recording formats are compatible with other software or computers. If you will be sharing your recordings with others or transferring a recording to your PC, be sure to choose a recording format that is supported by the software used to play recordings on the other computer.

To select a recording format:

- 1 On the **Start** menu, tap **Settings**, and then tap the **Input** icon.
- 2 On the **Options** tab in the Input control panel, select a voice recording format from the drop-down list.

The list of recording formats on your **V38r** indicates the sample rate, whether the format is stereo or mono, and how much storage memory is required per second of recording. You may need to experiment with different sample rates and formats to determine which format best suits your voice.

Using *My Text*

When using **Inbox**, use **My Text** to quickly insert a preset or frequently used messages into the text entry area. To insert a message, tap **My Text**, and then tap a message. After inserting a **My Text** message, you can add text before sending the message.

To edit a **My Text** message, on the **Tools** menu, tap **Edit My Text Messages**. Select the message you wish to edit and make desired changes.

MANAGING THE V38r

This section tells you how to effectively manage power and memory, and how to add/remove programs, and back up your data.

Managing power

It is important to maintain a continuous power supply to the **V38r** to prevent data or files stored in RAM from being damaged. Your **V38r** can operate either on external AC power or internal battery power. **You will lose any information, programs or settings that you added if the battery completely runs out of power.**

A fully charged battery should provide power for using up to 4 hours. The operating time of a fully charged battery depends on how you are using the **V38r**. Some functions, such as multimedia features or a Secure Digital memory card, may consume extra battery power.

Recharge the battery when a warning of low power is displayed on your V38r, or the V38r will turn off automatically. Connect the **V38r** to external AC power for charging before using it again.

To check the remaining power, on the **Start** menu, tap **Settings** > on the **System** tab, tap the **Power** icon. The remaining power appears on a status bar in the **Power** control panel.

Smart power management

Power management utilities supplied with your **V38r** provide options that help prolong the battery's operating time.

To access these utilities tap the Windows **Start** button [🌐], tap **Settings > System** tab > **Advanced Settings** (three tabs appear: **System**, **Smart Battery**, and **Power Manager**). *For more information, see the tables below.*

System: The **System** screen shows system information only but not any control options.

Smart Battery

Option	Description
Auto (default setting)	This mode automatically adjusts the CPU speed according to the need of the current operation.
Low Performance	This mode prolongs the battery life by minimizing the CPU's performance.
High Performance	This mode enhances battery life by improving the CPU's performance.
Superior Performance	This mode decreases the battery life, resulting from maximum CPU performance.

Power Manager: You can also select the events that wake up your **V38r** from Sleep Mode: for each of the three options below the default setting is "checked."

Option	Description
Application Buttons	If this option is checked, you can wake up your V38r by pressing one of these four application buttons on the front of your V38r : Note , Calendar , Contacts , or Task .
Record Button	If this option is checked, you can wake up your V38r by pressing the Record button on the V38r .
SD/MMC Card Insertion/Removal	If this option is checked, you can wake up your V38r by inserting or removing an SD card.

Power-saving tips

Follow these suggestions to maximize the battery's operating time:

- **Turn off the backlight.** Press and hold the power button to turn off the backlight, or use the Backlight control panel to set the backlight to turn off automatically after a short period of inactivity.
- **Always use AC power when connecting your V38r to your PC.** Note that your **V38r** will not auto-suspend while it is connected.
- **Turn off sounds.** Use the Sounds & Notifications control panel to turn off all but the most necessary system sounds.
- **Avoid using memory card accessories while on battery power.** Some memory cards use considerable power and will quickly drain your battery.
- **Do not "listen" for infrared transfers.** Although you can set your **V38r** to constantly monitor the IR port for files sent from other devices, doing so will quickly drain your batteries.

Battery storage



Battery Storage: to store the **V38r** if you are not using the device on a daily basis, leave the battery in the device and plug the **V38r** into AC power.

Data storage



Data Storage: Remove the back cover by turning the latch counterclockwise then take the battery out. **CAUTION:** Removing the battery can cause the loss of content that is not saved in the Persistent Storage folder.

Before removing the battery, we strongly recommend that you do one of the following:

- Drag any changed files you want to protect to the **V38r**'s Persistent Storage folder (under **My Computer**), then press the Power button (to turn the **V38r** off/Suspend Mode) before removing the old battery. Or,
- Plug the AC Power Cord into the **V38r** before removing the old battery to prevent a disruptive interruption of power. Or,
- Press the Power button to put the **V38r** in Suspend Mode, remove the old battery, and insert the replacement battery quickly. The *backup battery* (permanently installed) will prevent an interruption of power, providing a maximum of five (5) minutes of power while in Suspend Mode.

Managing memory

Your **V38r** uses two kinds of memory: storage and program memory (RAM), and optional memory cards.

Storage and program memory

RAM (Random Access Memory) on your **V38r** is shared between storage memory and program memory. "Storage memory" is used to store the data you create and additional programs you install. "Program memory" is used to run programs on your **V38r**. Your **V38r** automatically manages the allocation between storage and program memory. However, in some situations, such as when the memory is running out, your **V38r** may not be able to automatically adjust the allocation.

Memory cards

Memory cards are small, removable flash storage cards that enable you to expand the memory of your **V38r**. You can use memory cards for backup storage, archives, or to transfer large files to other devices. Your **V38r** supports Secure Digital memory cards. Memory cards can be purchased from a variety of third-party vendors.

SD memory capabilities

Your **V38r** has an SD card slot which accepts an SD (Secure Digital) memory card. You can purchase an SD card to expand the memory capacity and capabilities of your **V38r**.

To insert an SD memory card

- 1 Slide the end of the card with the chipped corner into the SD slot on the side of the **V38r**.
- 2 Push the card into the slot until it clicks into place.

To remove an SD memory card

Press the card. When the card pops out slightly, you can pull it out.

SDRAM memory allocation

The **V38r** has the following SDRAM memory:

- For the USA and European models: 15 MB is used by the Rugged Handheld 2003 Operating System, applications, and drivers.
- The remaining memory is available for user applications and file storage: 36.5MB for the USA and Europe **V38r** models.

Memory map for 64/128 MB SDRAM

Description	64	128
Flash ROM Image allocated for Rugged Handheld 2003 Operating System and applications	28.8 MB	60.8MB
Drivers	5.40 MB	6.3 MB
Available for user applications and file storage	23.4 MB	54.4 MB
Flash ROM	25.18	21.30
Total Memory	57.59 MB	121.5 MB

The USA and Europe **V38r** models have an additional 36 MB of Flash ROM memory available for file storage called "**My Flash Disk.**"

Antenna signal properties

Your **V38r** uses the 802.11b/g wireless radio signal standard to communicate with a local 802.11b/g networks. The quality of your radio connection signal can be weakened by excessive distance and by intervening materials such as walls and furnishings. If the wireless connection seems to work intermittently, check the quality of your wireless connection.

Finding and organizing information

The **Find** feature on your **V38r** helps you quickly locate information. To find a file, on the **Start** menu, tap **Find**. Enter the text you want to find, select a data type, and then tap **Go** to start the search.

To quickly find information that is taking up storage space on your **V38r**, under **Type** select **Larger than 64KB**.

You can also use the **File Explorer** to find files on your **V38r** and to organize these files into folders. On the **Start** menu, tap **Programs**, tap **File Explorer**.

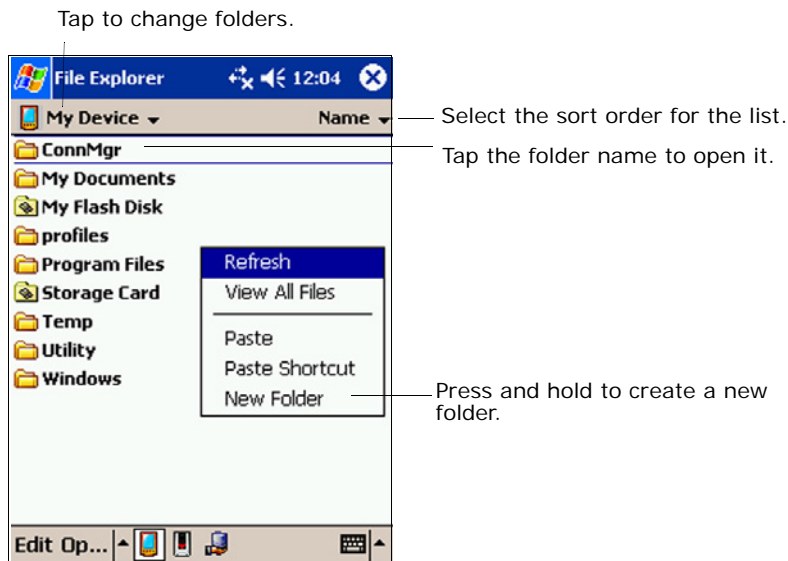

Customizing the V38r

To customize the settings of the **V38r** to your own preferences, tap **Start** > **Settings** > tap any of the icons on the **Personal Information**, **System**, or **Connections** tabs. The customization options are as follows:

Tab	Options	Description
PERSONAL INFORMATION	Buttons	Assigns your favorite programs to the program buttons
	Input	Sets the settings related to Block Recognizer, soft keyboard, Letter Recognizer and Transcriber input methods.
	Menus	Selects items that appear on Start menu & New menu on Today screen.
	Owner Information	Saves your personal information.
	Password	Sets the password to your V38r to protect the stored data.
	Sounds & Notifications	Sets the conditions and types of the sounds, system volume, and ways of notifications.
	Today	Sets the items that appear on the Today screen.
SYSTEM	About	Shows information about the version of the operating system, the name of the Rugged Handheld, and copyrights.
	Backlight	Adjusts the backlight of the display.
	Certificates	Network administrator.
	Clock & alarms	Sets the current time and alarm.
	Memory	Adjusts the allocation of data and program storage.
	Power	Shows the remaining battery and external AC power, and set the time for the V38r to turn off automatically.
	Regional Settings	Sets the region of your location, and formats for number, currency, time and date.
	Remove Programs	Removes programs pre-installed in RAM.
	Screen	Realigns the touch screen for accurate taps.
	V38r Utility	Information only and a button to enable the Wireless Card.

Tab	Options	Description
CONNECTIONS	Connections	Connect to modem, server, VPN
	AvantGo Connection	Defines properties of server setting for AvantGo.
	Beam	Allows for receiving & transmitting data through infrared.
	Bluetooth	Enable another Bluetooth device.
	Network Cards	Defines different network adapter drivers available on the device.

Setting a password

A password can safeguard your **V38r** against unauthorized use. To set your password:

- 1 Tap **Start**, tap **Settings**, then tap the **Password** icon on the **Password** tab.
- 2 Tap the digits or characters to set your password. You can set a four-digit password, or a long password containing a combination of at least seven characters, digits or punctuation.
- 3 You can set the time for the **V38r** to prompt for a password after idling.
- 4 Tap **OK**.

Adding/removing programs

Adding programs

You can add even more functionality to your **V38r** by installing additional software and programs. A wide variety of software is available for Windows Powered Rugged Handhelds, ranging from custom business applications and system utilities to games and entertainment. Some programs are available from software vendors or on the Web.

Install only programs designed specifically to run on a Rugged Handheld personal digital assistant and/or a Windows Powered Rugged Handheld. You cannot run programs designed for Windows on your **V38r**. In addition, you may need a version of the program designed specifically for the **X-Scale** processor used by your **V38r**.

Install software to your **V38r** by first loading the installation files onto your PC. Use **ActiveSync** on your PC to transfer and install programs to the storage memory (RAM) in your **V38r**.

Removing programs

To free storage memory on your **V38r**, you can remove programs you no longer use. Only programs that are stored in RAM can be removed.

Programs pre-installed in Flash ROM cannot be removed; however, these programs do not use storage memory.

To remove a program:

- 1 On the **Start** menu, tap **Settings**.
- 2 On the **System** tab, tap **Remove Programs**.
- 3 Select the program in the list, and then tap **Remove**.

If the program does not appear in the list of installed programs, use **File Explorer** on your **V38r**. Locate the program, press and hold the stylus on the program, and then tap **Delete** on the pop-up menu.

Backing up data

To prevent loss of data, you should back up your **V38r** frequently. Your **V38r** comes with two programs for backing up data:

- **Microsoft ActiveSync.** **ActiveSync** enables you to back up data to your PC. You can back up all data on your **V38r**, or only your PIM databases (**Calendar**, **Contacts**, and **Tasks**). You can set **ActiveSync** to back up automatically each time you connect, or you can back up manually, whenever you choose. *For more information, see **ActiveSync Help** on your PC.*
- **Backup** enables you to back up all data stored in the internal (RAM) memory on your **V38r**. You can save the backup file on an optional Secure Digital memory card.

Using Backup

Backup gives you added flexibility in backing up your valuable data. With **Backup**, you can back up all data in RAM. You can save the backup file to an optional SD memory card, so you can safeguard your data even while you are traveling or away from your PC.

An internal storage device called "My Flash Disk" is included. When using **Backup**, you can choose this disk as your target backup device.

Backing up data using Backup

- 1 Close all running applications and insert a memory card.
- 2 Disconnect your **V38r** from your PC.
- 3 On the **Start** menu on your **V38r**, tap **Programs** and then tap the **Backup** icon.
- 4 Tap **Backup**, then tap **Next**.
- 5 Tap your preference of storage media for backing up your data, then tap **Next**.
- 6 Tap the item you want to back up, then tap **Next**.
- 7 Tap **Backup**, then tap **Yes** to start the backup process.
- 8 Remove the memory card after the backup is complete.

CAUTION:

- Never delete the backup file in the memory card. If the backup file is deleted, the backup data will be lost and cannot be restored.
- When you use the backup file to restore information, information on your **V38r** is replaced with the information stored in the backup file. If you have created files on your **V38r** since the last backup and do not want to delete these files during the restore process, move the files from your **V38r** to your PC – or to an optional memory card – before restoring the information.

Restoring data using Backup

- 1 Close all running applications and insert a memory card with the backup data.
- 2 Disconnect your **V38r** from your PC.
- 3 On the **Start** menu tap **Programs**, then tap the **Backup** icon.
- 4 Tap **Restore**, then tap **Yes**.
- 5 Tap your preference of storage media for restoring your data, then tap **Next**.
- 6 Tap the item you want to restore, then tap **Next**.
- 7 Tap **Restore**, then tap **Yes** to start the restore process.
- 8 Remove the memory card after the restore process is complete, and reset your **V38r**.

IMPORTANT: When you restore data, your **V38r** must have the same regional settings that it had when you completed the backup; otherwise, you will not be able to restore the files. To change regional settings, on the **Start** menu, tap **Settings**, and then tap the **Regional Settings** icon on the **System** tab. Select your region from the drop-down list.

MICROSOFT ACTIVESYNC

This section tells you what the **Microsoft ActiveSync** program is and what you need to do to use it.

Using Microsoft ActiveSync

ActiveSync is already installed on your **V38r**. You need to install ActiveSync on your PC. *For more detail, see the section on installing **ActiveSync**.*

Microsoft ActiveSync allows you to synchronize the information on your PC with information on your **V38r**. Synchronization compares the data on the two sides and updates both computers with the most recent information. For example, you can:



- Keep your Pocket Outlook Contacts, Calendar, and Tasks databases up-to date by synchronizing your **V38r** with Microsoft Outlook data on your PC.
- **IMPORTANT:** Outlook must be installed on your PC in order to synchronize your email data.
- Synchronize email messages in your **V38r** Inbox with email messages in Microsoft Outlook on your PC.
- Synchronize **Microsoft Word** and **Microsoft Excel** files between your **V38r** and PC. Your files will be automatically converted to the correct format.

With **ActiveSync**, you can also:

- Back up and restore your **V38r** data.
- Copy (rather than synchronize) files between your **V38r** and PC.
- Add and remove programs on your **V38r**.

Synchronizing data

Once you have created a synchronization partnership and completed the first synchronization, you can initiate synchronization from your **V38r**. Follow this procedure:

- 1 Connect your **V38r** to your PC.
- 2 On your **V38r**, tap , and then tap **ActiveSync**.
- 3 Tap  to begin synchronization.

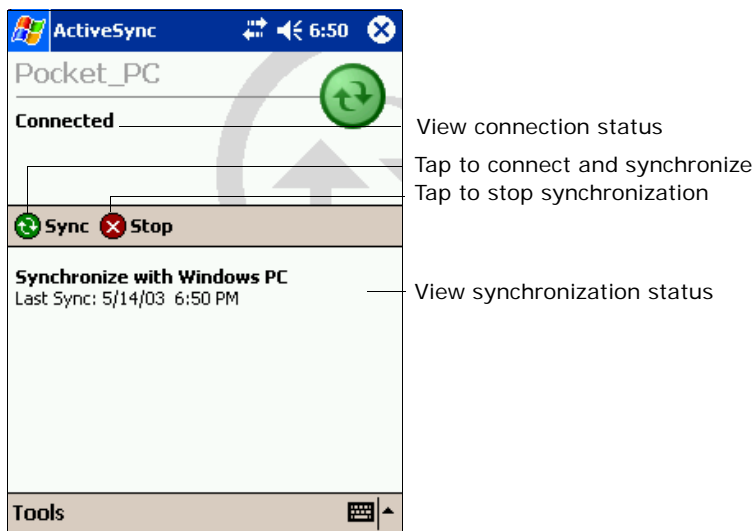

By default, **ActiveSync** does not automatically synchronize all types of information. Use **ActiveSync** options to turn synchronization on and off for specific information types. You can:

- Control when synchronization occurs by selecting a synchronization mode. For example, you can synchronize continually while the **V38r** is connected or only when you choose the synchronize command.
- Select which information types are synchronized and control how much data is synchronized. For example, you can choose how many weeks of past appointments you want synchronized.

For information on setting **ActiveSync** options and using ActiveSync on your PC, see **ActiveSync Help** on your PC. For information on using **ActiveSync** in your **V38r**, see **ActiveSync Help** on the **V38r**.

Connecting to your PC

CAUTION: Do not shut down or restart your PC while the **V38r** is connected. Turn off the **V38r** or disconnect the USB cable before shutting down your PC.

By USB cable

CAUTION: Before connecting the **V38r** to the USB synchronization cable, be sure your PC is turned on, that **ActiveSync** is on your PC and is configured to allow a USB connection. *For more information, see the section "Installing Microsoft ActiveSync" in this guide.*

By infrared

You can use the IR port instead of using the cable to synchronize data with your PC. IR ports are on many notebook computers; however, on a PC, you may need to install and configure an IR port. To install the port, follow the manufacturer's instructions. *For complete instructions on connecting to your PC by infrared, refer to ActiveSync Help on your PC.*

POCKET OUTLOOK

This section introduces you to the basics of Microsoft Pocket Outlook, including Calendar, Contacts, Tasks, Notes and Inbox.

Scheduling appointments/meetings

Use **Calendar** to schedule appointments, including meetings and other events.

You can check your appointments in one of several views (**Agenda**, **Day**, **Week**, **Month**, and **Year**) and easily switch views by using the **View** menu.

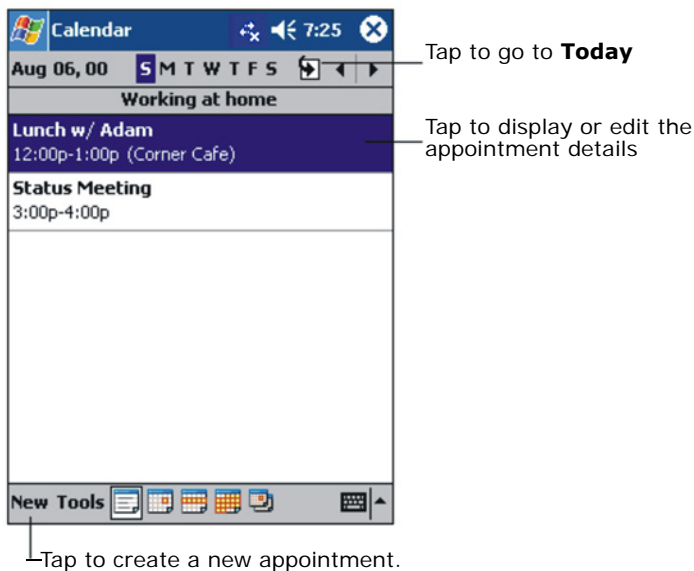

You can customize the **Calendar** display (for example, change the first day of the week), by tapping **Options** on the **Tools** menu.

Creating an appointment

- 1 In Day or Week view, tap the desired date and time for the appointment.
- 2 Tap **New**.

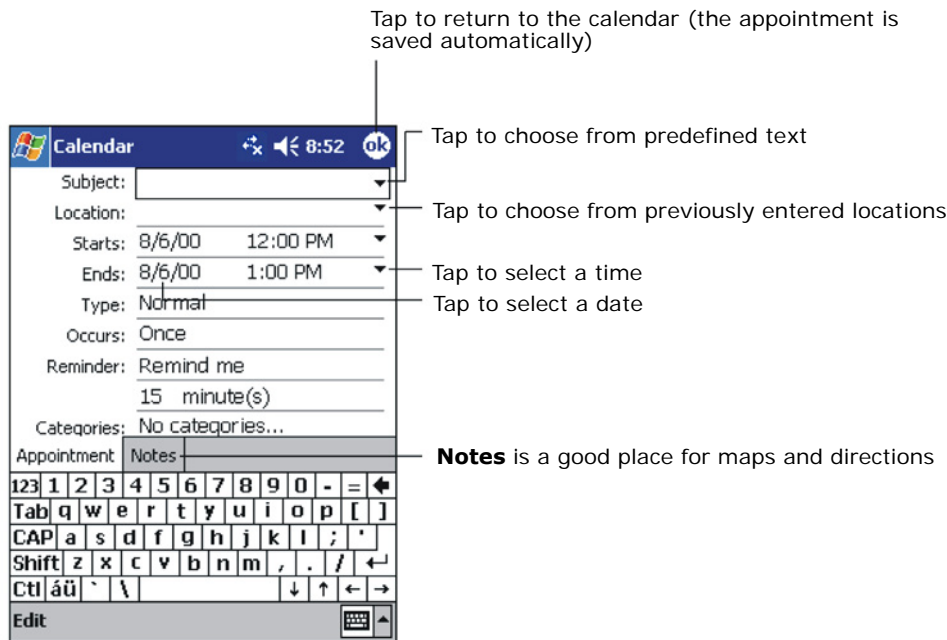

- 3 When using the Input panel, tap first to select the field, and then enter a description and a location.
- 4 If needed, tap the date and time to change them.
- 5 Enter other desired information. You will need to hide the Input panel to see all available fields.
- 6 To add notes, tap the **Notes** tab. You can enter text, draw, or create a recording. *For more information on creating notes, see "Notes: Capturing Thoughts and Ideas" later in this section.*
- 7 Tap **OK** to return to Calendar.

If you select **Remind me** in an appointment, your **V38r** will remind you according to the options set in the **Sounds & Notifications** control panel.

Using the summary screen

When you tap an appointment in **Calendar**, a summary screen displays. To change the appointment, tap **Edit**.

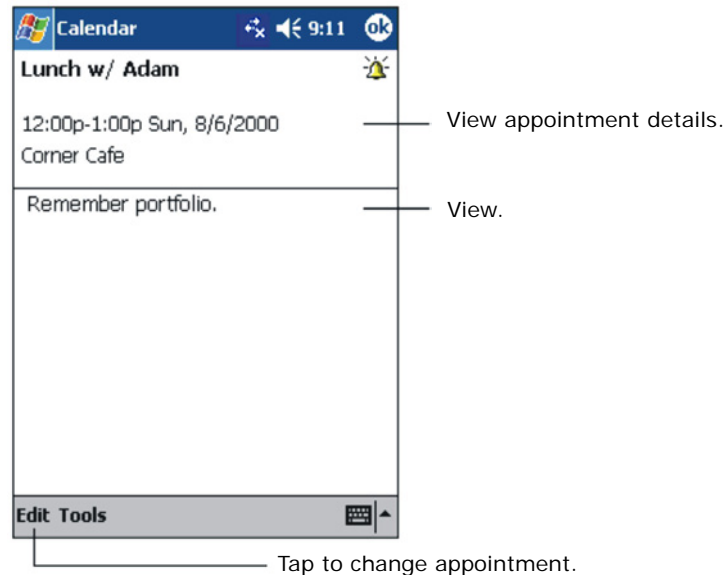

Creating meeting requests

You can use **Calendar** to set up meetings with users of **Outlook** or **Pocket Outlook**. The meeting notice will be created automatically and sent either when you synchronize Inbox or when you connect to your email server. Indicate how you want meeting requests sent by tapping **Tools** and then **Options**. If you send and receive email messages through **ActiveSync**, select **ActiveSync**.

To schedule a meeting:

- 1 Create an appointment.
- 2 In the appointment details, hide the Input panel, and then tap **Attendees**.
- 3 From the list of email addresses in **Contacts**, select the meeting attendees. The meeting notice is created automatically and placed in the **Outbox** folder. *For more information on sending and receiving meeting requests, see **Calendar Help** and **Inbox Help** on your **V38r**.*

Managing contacts

Contacts maintains a list of your friends and colleagues so that you can easily find the information you are looking for, whether you are at home or on the road. Using the IR port on the **V38r**, you can quickly share **Contacts** information with users of Rugged Handhelds and other mobile devices.

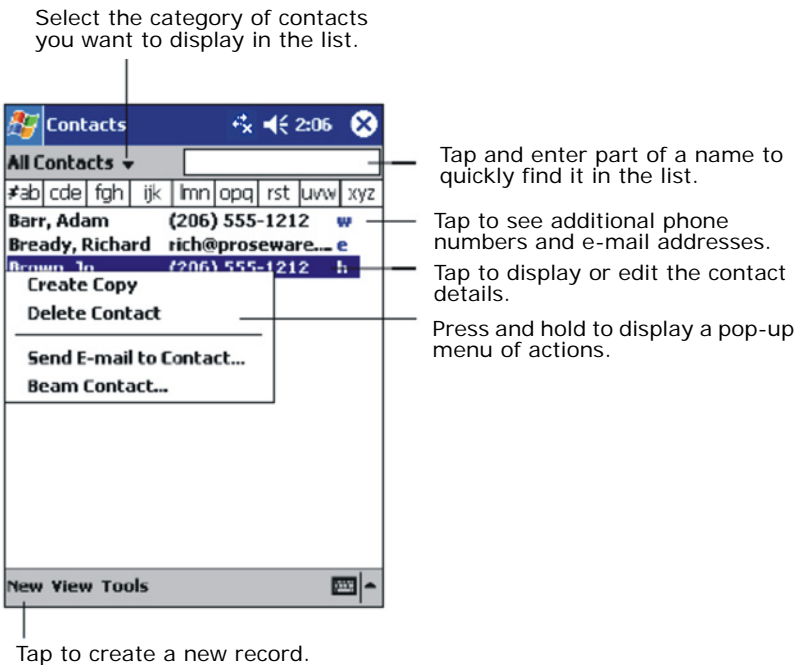

To change the way information is displayed in the list, tap **Tools** then tap **Options**.

1 Tap **New**.

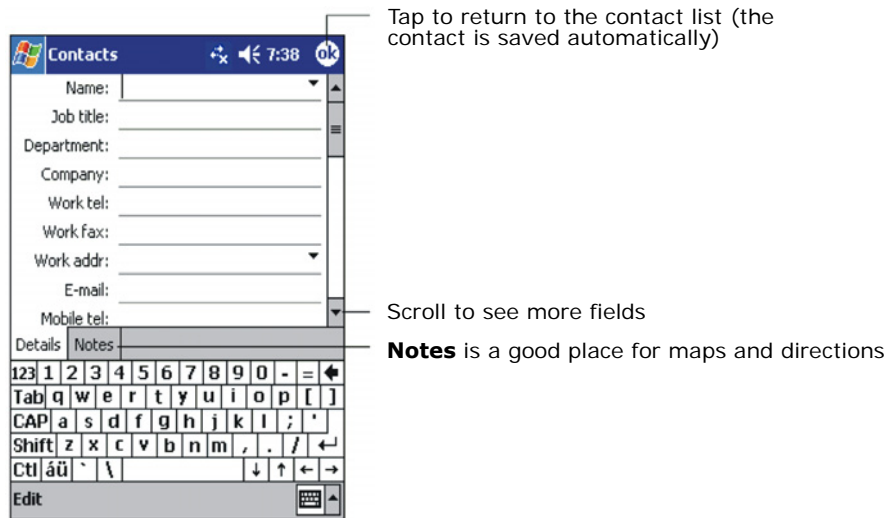

- 2 Using the **Input panel**, enter a name and other contact information. Scroll down to see all available fields.
- 3 To assign the contact to a category, scroll to and tap **Categories**, then select a category from the list. In the contact list, you can display contacts by category.
- 4 To add notes, tap the **Notes** tab. You can enter text, draw, or create a recording. *For more information on creating notes, see "Notes: Capturing Thoughts and Ideas" later in this section.*
- 5 Tap **OK** to return to the contact list.

Finding a contact

There are several ways to find a contact:

- On the **Start** menu, tap **Find**, enter the contact name, select **Contacts** for the type, and then tap **Go**.
- In the contact list, enter a contact name in the box under the Navigation bar.
- To show all contacts again, clear text from the box or tap the button to the right of the box.
- In the contact list, tap the category list (labeled **All Contacts** by default) then select the type of contact that you want displayed. To show all contacts again, select **All Contacts**. To view a contact not assigned to a category, select **None**.
- To view the names of companies your contacts work for, in the contact list, tap **View** then tap **By Company**. The number of contacts that work for that company will be displayed to the right of the company name.

Using the Summary screen

When you tap a contact in the contact list, a summary screen displays. To change the contact information, tap **Edit**.

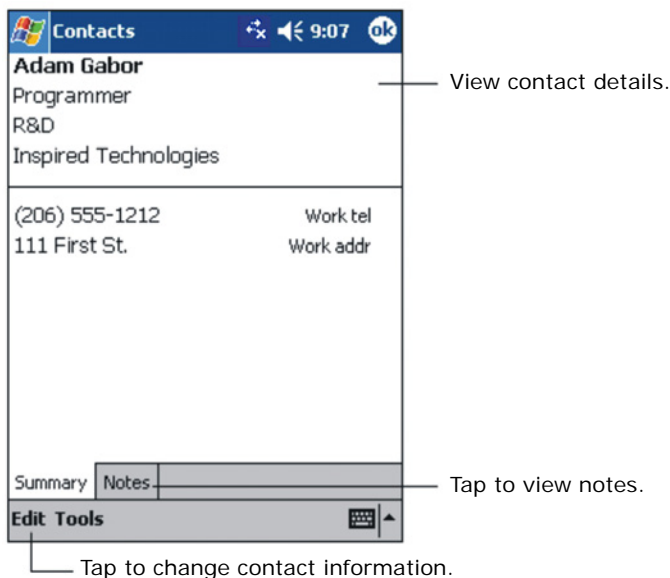

Tasks: keeping a To Do list

Use **Tasks** to keep track of what you have to do.

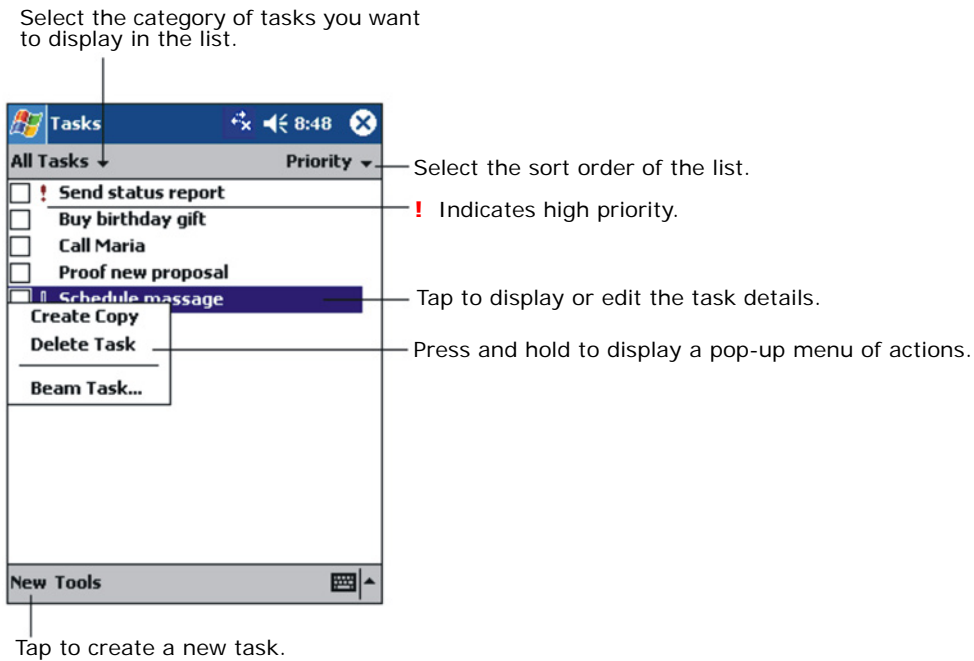

Creating a task

- 1 Tap **New**.

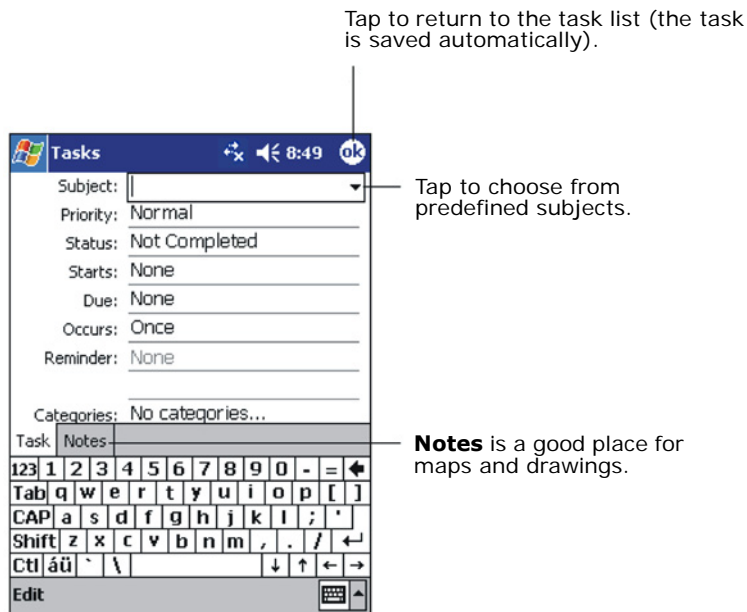

- 2 Using the **Input** panel, enter a description.
- 3 You can enter a start date and due date, or enter other information by first tapping the field. If the Input panel is open, you will need to hide it to see all available fields.
- 4 To assign the task to a category, tap **Categories**, then select a category from the list. In the task list, you can display tasks by category.
- 5 To add notes, tap the **Notes** tab. You can enter text, draw, or create a recording. *For more information on creating notes, see "Notes: Capturing Thoughts and Ideas" later in this section.*
- 6 Tap **OK** to return to the task list.

Using the Summary screen

When you tap a task in the task list, a summary screen displays. To change the task, tap **Edit**.

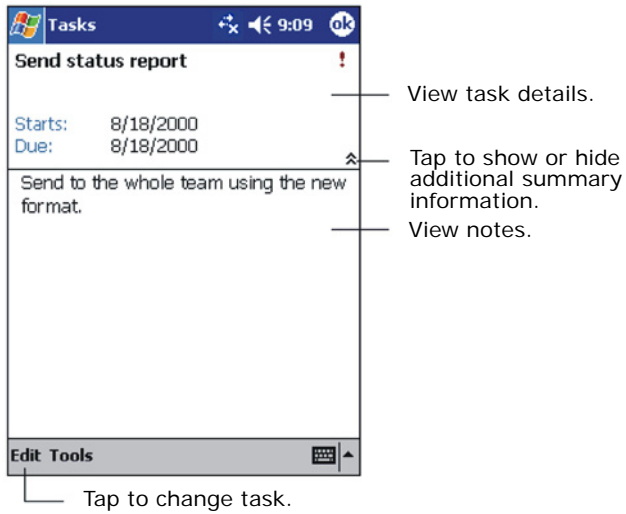

Notes: capturing thoughts and ideas

Quickly capture thoughts, reminders, ideas, drawings, and phone numbers with **Notes**. You can create a written note or a recording. You can also include a recording in a note. If a note is already open when you create the recording, it will be included in the note as an icon. If the note list is displayed, the recording will be created as a stand-alone recording.

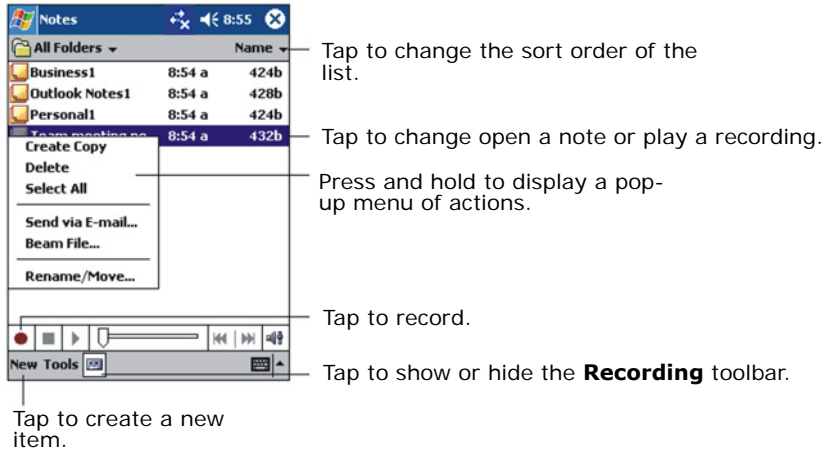

Creating a note

- 1 Tap **New**.
- 2 Create your note by writing, drawing, typing, or recording. *For more information about using the **Input** panel, writing and drawing on the screen, and creating recordings, see the section on "Entering Information" in this guide.*

Inbox: sending and receiving email

Use the **Inbox** to send and receive e-mail messages with **Microsoft Outlook** on your PC.

Synchronizing email messages

Email messages can be synchronized as part of the general synchronization process. To do this, you need to enable **Inbox** synchronization in **ActiveSync**. For information on enabling **Inbox** synchronization, see **ActiveSync Help** on the PC.

During synchronization:

- Messages are copied from the mail folders of **Exchange** or **Outlook** on your PC to the **ActiveSync** folder in **Inbox** on your **V38r**.
- Email messages in the **Outbox** folder on your **V38r** are transferred to **Exchange** or **Outlook**, and then sent from those programs.
- Email messages in subfolders must be selected in **ActiveSync** on your PC in order to be transferred.

Using the message list

Messages you receive are displayed in the message list. By default, the most recently received messages are displayed first in the list.

Select the Internet Service Provider and the folder you want to display.

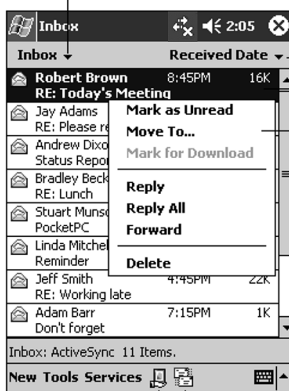

Select the sort order for messages.

Tap to open a message.

Press and hold to display a pop-up menu of actions.

Tap to connect, and to send and receive e-mail.

Tap to connect to the selected Internet Service Provider.

When you receive a message, tap the message to open it. Unread messages display in bold.

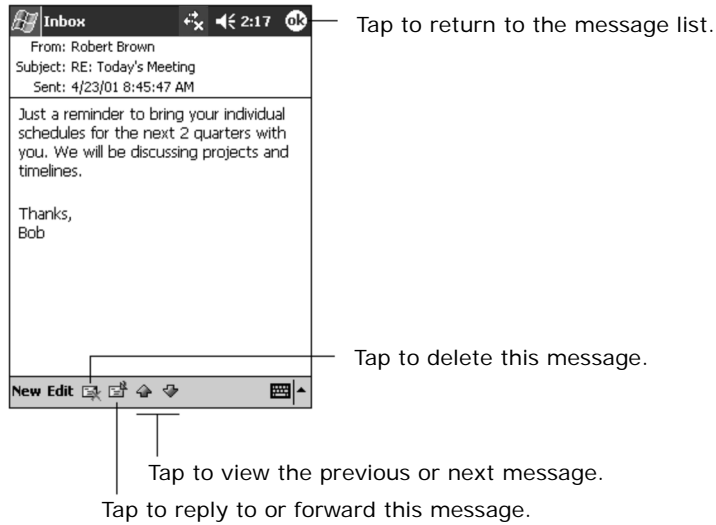

IMPORTANT: When you synchronize with your PC, by default, you will receive messages from the last three days only, the first 100 lines of each new message, and file attachments of less than 100 KB in size. The original messages remain on your PC.

To compose a message:

- 1 Tap **New**.
- 2 In the **To** field, enter an email of one or more recipients, separating them with a semicolon, or select a name from the contact list by tapping the **Address Book** button. All email addresses entered in the email fields in **Contacts** appear in the **Address Book**.

Tap to send the message.

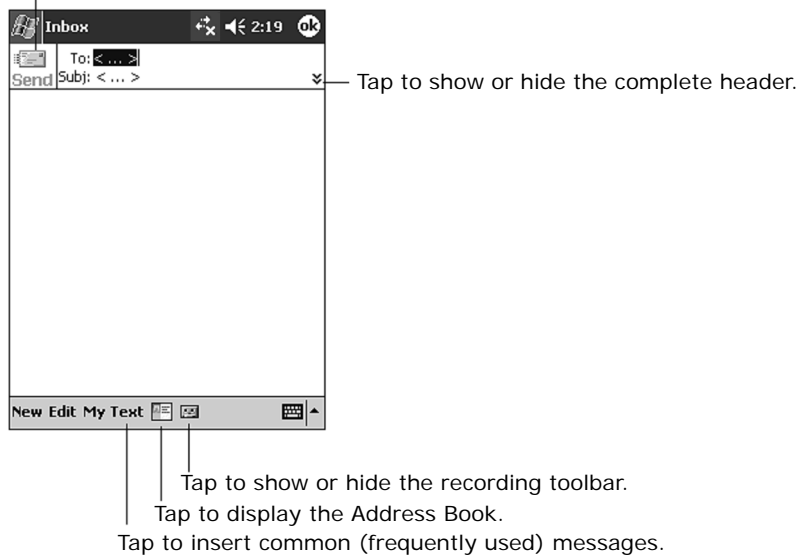

- 3 Compose your message. To enter preset or frequently used messages, tap **My Text** and select a message.
- 4 Tap **Send** when you have finished the message. If you are working offline, the message is moved to the **Outbox** folder and is sent the next time you connect. The message is placed in the **Outbox** folder on your device.

Managing email messages and folders

By default, messages are displayed in one of five folders for each service you have created: **Inbox**, **Deleted Items**, **Drafts**, **Outbox**, and **Sent Items**. The **Deleted Items** folder contains messages that were deleted from the **V38r**. The behavior of the **Deleted** and **Sent Items** folders depends on the options you have chosen. In the message list, tap **Tools** then tap **Options**. On the **Message** tab, select your options.

If you want to organize messages into additional sub-folders, tap **Tools**, then tap **Manage Folders** to create new folders. To move a message to another folder, in the message list, press and hold the message then tap **Move** on the pop-up menu.

COMPANION PROGRAMS

This section tells you about **Microsoft Pocket Word** and **Microsoft Pocket Excel**.

Pocket Word

Microsoft Pocket Word works with **Microsoft Word** on your PC to give you easy access to copies of your documents. You can create new documents on your **V38r** or you can copy documents from your PC. **IMPORTANT:** Synchronize documents between your PC and your **V38r** regularly so that you have the most up-to-date content in both locations.

Using Pocket Word

- 1 On the **Start**, tap **Programs** and then tap the **Pocket Word** icon.
- 2 Type the name of a document in the file list or tap **New** to open a blank document.

To open a template rather than a blank document, select a template for new documents. Tap on the **Tools** menu, tap **Options**, then browse to select the default template. When you tap **New**, the template appears with appropriate text and formatting already provided.

You can open only one document at a time; when you open a second document, you will be asked to save the first. You can save a document you create or edit in a variety of formats, including **Pocket Word** (.psw), Rich Text Format (.rtf), and Plain Text (.txt).

You can enter information in **Pocket Word** in four modes: writing, drawing, typing, and recording. Use the **View** menu to switch between modes. Each mode has its own toolbar which you can show or hide by tapping the **Show/Hide Toolbar** button on the Command bar.

- **Typing Mode.** Use the Input panel to enter typed text into the document with the soft keyboard. *For more information, see the section on "Entering Information."*
- **Writing Mode.** In writing mode, use your stylus to write directly on the screen. Ruled lines are displayed as a guide, and the zoom magnification is greater than in typing mode to allow you to write more easily. *For more information, see the section on "Entering Information."* Written words are converted to graphics (metafiles) when a Pocket Word document is converted to a **Word** document on your PC.

- **Drawing mode.** In drawing mode, use your stylus to draw on the screen. Gridlines appear as a guide. When you lift your stylus off the screen after the first stroke, you will see a drawing box indicating the boundaries of the drawing. Every subsequent stroke within or touching the drawing box becomes part of the drawing. *For more information, see the section on "Entering Information."*
- **Recording mode.** Use recording mode to embed a recording into your document. Recordings are saved as WAV files. *For more information, see the section on "Entering Information."*

Tips for working in Pocket Word

- You can change the zoom magnification by tapping **View** and then tapping **Zoom**. Then select the percentage you want. Select a higher percentage to enter text and a lower one to see more of your document.
- If you are opening a Word document created on a PC, select **Wrap to Window** on the **View** menu so that you can see the entire document.

Pocket Excel

Microsoft Pocket Excel works with **Microsoft Excel** on your PC to give you easy access to copies of your workbooks. You can create new workbooks in your **V38r**, or you can copy workbooks from your PC to your **V38r**. Synchronize workbooks between your PC and your **V38r** so that you have the most up-to-date content in both locations. **Pocket Excel** provides fundamental spreadsheet tools, such as formulas, functions, sorting, and filtering, which enable you to create simple workbooks, such as expense reports and mileage logs.

On the **Start** menu, tap **Programs** and then tap the **Pocket Excel** icon > tap the name of a workbook in the file list or tap **New** to open a blank workbook. You can open only one workbook at a time; when you open a second workbook, you will be asked to save the first. You can save a workbook you have created or edit in a variety of formats, including **Pocket Excel** (.pxl) and Excel (.xls).

Tips for working in Pocket Excel

- View in full-screen mode to see as much of your worksheet as possible. Tap **View** and then tap **Full Screen**. To exit full-screen mode, tap **Restore**.
- If your workbook contains sensitive information, you can protect it with a password. To do so, open the workbook, tap **Edit**, and then tap **Password**.
- Show or hide window elements. Tap **View**, then tap the elements you want to show or hide.
- Freeze panes on a worksheet. First, select the cell where you want to freeze panes. Tap **View** and then tap **Freeze Panes**. You might want to freeze the top and furthest left panes in a worksheet to keep row and column labels visible as you scroll through a sheet.
- Split panes to view different areas of a large worksheet. Tap **View** and then tap **Split**. Then drag the split bar to where you want it. To remove the split, tap **View** and then tap **Remove Split**.
- Show and hide rows and columns. To hide a row or column, select a cell in the row or column you want to hide, tap **Format**, tap **Column**, then tap **Hide**. To show a hidden row or column, tap **Tools**, tap **Go To**, then type a reference that is in the hidden row or column. Tap **Format**, then tap **Row** or **Column**, then tap **Unhide**.

Windows Media Player for Rugged Handheld

Use **Microsoft Windows Media Player** for **V38r** to play digital audio and video files that are stored on your **V38r** or on a network. To switch to **Windows Media Player** for **V38r**, tap  and tap **Windows Media**.

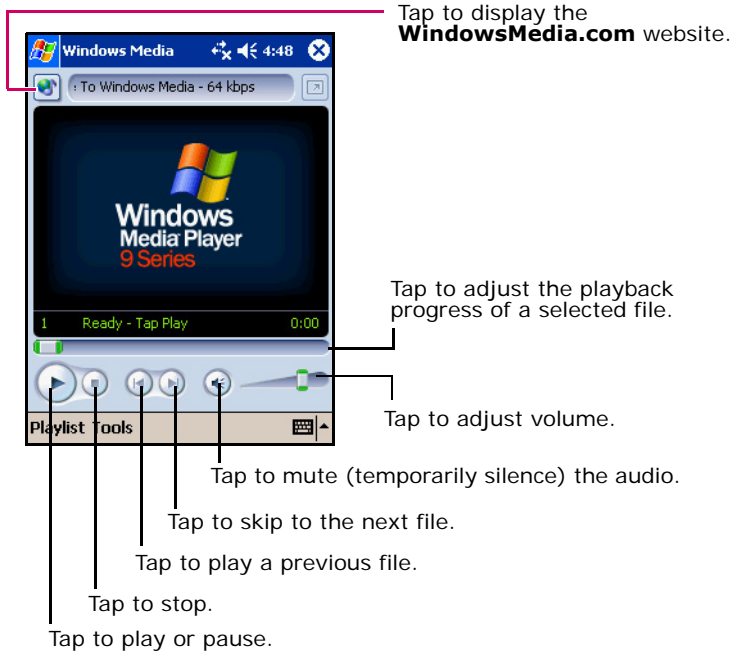

Use **Microsoft Windows Media Player** on your PC to copy digital audio and video files to your **V38r**. You can play **Windows Media** and MP3 files on your **V38r**.

For more information about using Windows Media Player, tap , then tap **Help**.

Microsoft Reader

Use **Microsoft Reader** to read eBooks on your **V38r**. Download books to your PC from your favorite eBook Web site. Use **ActiveSync** to copy the book files to your activated **V38r**. The books appear in the Reader Library, where you can tap them in the list to open them.

Before you can use **Microsoft Reader**, activate it from the **Microsoft** activation site (<http://das.microsoft.com/activate>). Follow the directions given at the **Microsoft** site.

Each book consists of a cover page, an optional table of contents, and the pages of the book. You can:

- Page through the book by tapping the page number on each page.
- Annotate the book with highlighting, bookmarks, notes, and drawings.
- Search for text or look up definitions for words.

The Guidebook contains all the information you need to use the software. To open the Guidebook, tap **Help** on the Reader command bar. Or, on a book page, press and hold on the book title, and then tap **Help** on the pop-up menu.

To switch to Microsoft Reader, tap , tap **Programs**, then tap **Microsoft Reader**.

Getting books onto your V38r

You can download book files from the Web. Just visit your favorite eBook retailer and follow the instructions to download the book files.

Sample books and a dictionary are also included in the MSReader folder on the Companion CD.

Use **ActiveSync** to download the files from your PC to your activated **V38r** as described in the **Read Me** file in the **MSReader** folder.

Using the Library

The Library is your Reader home page. The home page displays a list of all books stored on your **V38r** or storage card.

To open the Library:

- On the Reader command bar, tap **Library**.
- On a book page, tap the book title, and tap **Library**, on the pop-up menu.

To open a book, tap its title in the Library list.

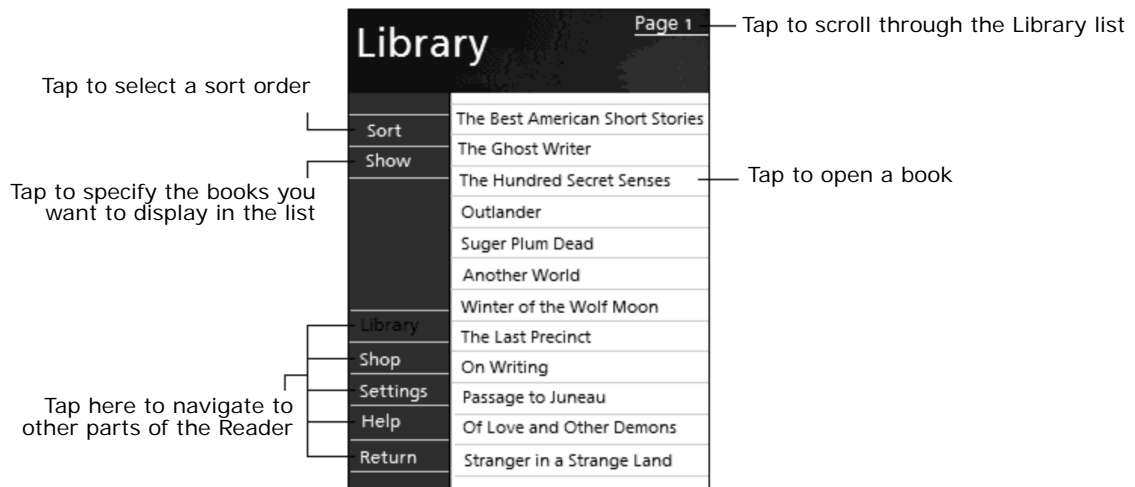

Reading a book

Each book consists of a cover page, an optional table of contents, and the pages of the book. Navigation options are listed in the bottom portion of the cover page.

The first time you open a book, you will probably want to go to the first page or to the table of contents, if there is one. Subsequently, whenever you open the book, you automatically go to the last page read.

In addition to the text, each book page includes a page number and book title.

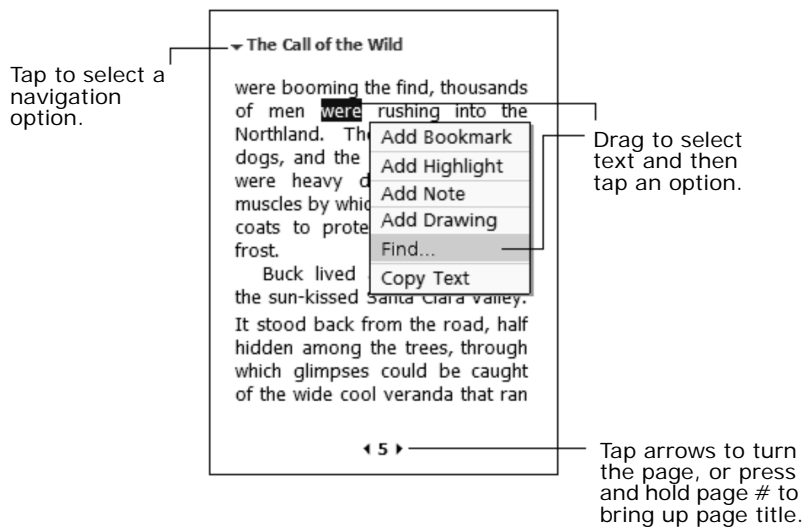

Using reader features

Reading a book electronically gives you several options not available with paper books. These options are available from any book page.

Select text by dragging across the text on the page. Then, tap an option on the pop-up menu, as described here.

- **Search for Text.** Find text in a book by tapping **Find** on the pop-up menu. Enter the word you want to search for, and tap the desired Find option. Reader highlights found text on the page. To close Find, tap outside the box. To return to your original page, tap the title, then tap **Return** on the pop-up menu.
- **Copy Text.** You can copy text from books that support this feature into any program that accepts text. On a book page, select the text you want to copy. Then, tap **Copy Text** on the pop-up menu. The text can be pasted into the program of your choice.
- **Bookmarks.** When you add a bookmark to a book, a color-coded bookmark icon appears in the right margin. You can add multiple bookmarks to a book. Then, from anywhere in the book, tap the bookmark icon to go to the bookmarked page.
- **Highlights.** When you highlight text, it appears with a colored background.
- **Notes.** When you attach a note to text, you enter the text in a note pad that appears on top of the book page. A Note icon displays in the left margin. To show or hide the note, tap the icon.
- **Drawings.** When you add a drawing, a Drawing icon appears in the bottom-left corner of the page and drawing tools appear across the bottom of the page. Draw by dragging your stylus.

To see a list of a book's annotations, including bookmarks, highlights, text notes, and drawings, tap **Annotations Index** on the book's cover page. You can tap an entry in the list to go to the annotated page.

Removing a book

When you finish reading a book, you can delete it to conserve space on your **V38r**. If a copy of the book is stored on your PC, you can download it again at any time.

To remove a book from your **V38r**, press and hold the title in the Library list, and then tap **Delete** on the pop-up menu.

Other programs

The following programs are permanently installed in your **V38r**:

Program	How to Access the Program
Infrared Receiver	On the Start menu, tap Programs and then tap the Infrared Receiver icon. Infrared Receive establishes the connection between your V38r and the IR device.
Terminal Services	On the Start menu, tap Programs and then tap the Terminal Services icon. Terminal Services allows you to access the programs and documents in a Windows NT server type PC that is running Terminal Services.
Backup	To determine if your company has registered your device with the V38r web service and has any software download ready for you, you can run the RDMUpdate.exe file on your V38r . On the Start menu, tap Programs and then tap the Backup icon. Backup enables you to back up all data stored in the internal (RAM) memory on your V38r . <i>For more information, see section "Backing up Data" in this guide.</i>

POCKET INTERNET EXPLORER

This section tells you about **Microsoft Pocket Internet Explorer**, **Mobile Favorites Folder** and **AvantGo Channels**.

Using Pocket Internet Explorer

Use **Microsoft Pocket Internet Explorer** to view Web pages by doing the following:

- During synchronization with your PC, download your favorite links and mobile favorites that are stored in the Mobile Favorites subfolder in Internet Explorer on the PC.

To start **Pocket Internet Explorer**

- On the **Start** menu, tap **Internet Explorer**. The **Pocket Internet Explorer** home page:

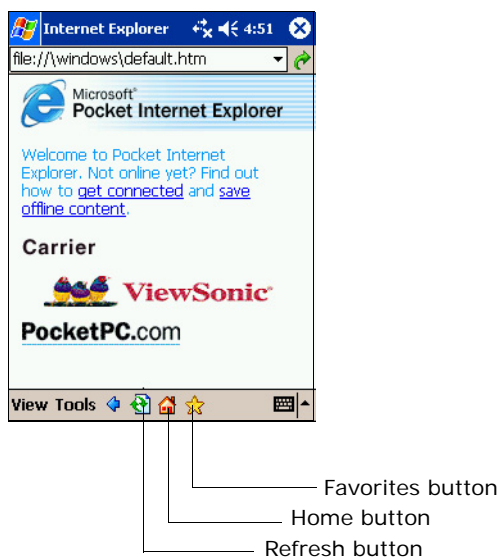

Viewing Mobile Favorites and Channels

- 1 Tap the **Favorites** button to display your list of favorites.
- 2 In the list, tap the page you want to view.

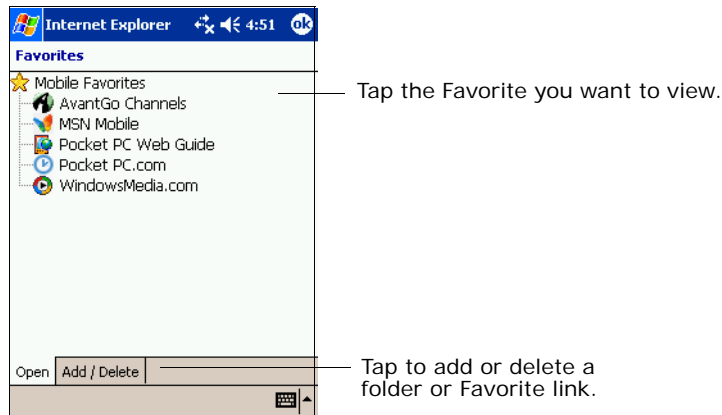

You will see the page that was downloaded the last time you synchronized with your PC. If the page is not on your **V38r**, it will be dimmed in the **Favorites** list. You will need to synchronize with your PC again to download the page to your **V38r**, or connect to the Internet to view the page.

Browsing the Internet

To connect and start browsing, do one of the following:

- Tap the **Favorites** button, and then tap the favorite you want to view.
- Tap **View**, and then tap **Address Bar**. In the address bar that appears at the top of the screen, enter the Web address you want to visit and then tap **Go**. Tap the arrow to choose from previously entered addresses.

The Mobile Favorites Folder

Only items stored in the **Mobile Favorites** subfolder in the **Favorites** folder in **Internet Explorer** on your PC will be synchronized with your Rugged Handheld. This folder is created automatically when you install **ActiveSync**.

Favorite links

During synchronization, the list of favorite links in the **Mobile Favorites** folder on your PC is synchronized with **Pocket Internet Explorer** on your **V38r**. Both computers are updated with changes made to either list each time you synchronize. Unless you mark the favorite link as a mobile favorite, only the link (and not the page) will be downloaded to your **V38r**, and connect to your ISP or network to view the content. *For more information on synchronization, see **ActiveSync Help on your PC**.*

Mobile Favorites

If you are using **Microsoft Internet Explorer** 5 or later on your PC, you can download mobile favorites to your **V38r**. When you synchronize your PC and **V38r**, the content of your mobile favorites is downloaded to your **V38r** so that you can view pages while you are not connected to your ISP or your network.

Use the Internet Explorer plug-in installed with **ActiveSync** to create mobile favorites quickly.

To create a mobile favorite:

- 1 In **Internet Explorer** on your PC, tap **Tools**, tap **Create**.

To change the link name, enter a new name in the Name box.

To change how often the mobile favorite is updated, select a desired update schedule under **Update**.

- 2 Tap **OK**. Internet Explorer downloads the latest version of the page to your PC.
- 3 If you want to download the pages that are linked to the mobile favorite you just created, tap the mobile favorite and then tap **Properties**. On the **Download** tab, specify the number of links deep you want to download. To conserve memory on your **V38r**, download only one level of links.
- 4 Synchronize your **V38r** and PC. Mobile favorites that are stored in the **Mobile Favorites** folder in **Internet Explorer** are downloaded to your **V38r**.

If you do not specify an updated schedule, manually download content to keep the information updated on your PC and **V38r**. Before synchronizing in Internet Explorer or your PC, tap **Synchronize** on the **Tools** menu. You will see the last time content was downloaded to your PC, and you can manually download if needed. You can add a button to the **Internet Explorer** toolbar for creating mobile favorites. In **Internet Explorer** on your PC, on the **View** menu, tap **Toolbars**, and tap **Customize**.

Conserving memory

Mobile favorites take up storage memory on your **V38r**. Follow these tips to minimize the amount of memory used:

- Use ActiveSync settings to turn off pictures and sounds for the Mobile Favorites information type or to stop some mobile favorites from being downloaded to your **V38r**. *For more information, see **ActiveSync Help**.*
- Limit the number of downloaded linked pages. In Internet Explorer on the PC, tap the mobile favorite you want to change, and then tap **Properties**. On the **Download** tab, specify 0 or 1 for the number of linked pages you want to download.

Using AvantGo channels

AvantGo is a free interactive service that gives you access to personalized content and thousands of popular Web sites. You subscribe to **AvantGo** channels directly from your **V38r**. Then you synchronize your **V38r** with your PC or connect to the Internet to download the content. *For more information, visit the **AvantGo** Web site: http://www.avantgo.com/frontdoor/learn_more.html*

To sign up for **AvantGo**:

- 1 In **ActiveSync** options on the PC, turn on synchronization for the **AvantGo** information type.
- 2 In **Pocket Internet Explorer** on your **V38r**, tap the **Favorites** button to display your list of favorites.
- 3 Tap the **AvantGo Channels** link.
- 4 Tap the **Activate** button.
- 5 Follow the directions on the screen. Synchronize your **V38r** with your PC, and tap the **My Channels** button to complete the **AvantGo** setup.

When synchronization is complete, tap the **AvantGo Channels** link in your list of favorites to see a few of the most popular channels. To add or remove channels, tap the **Add** or **Remove** link.

GETTING CONNECTED

This section explains how to connect your **V38r** to the Internet or to a network using a wireless connection. This section also explains how to connect with other mobile devices or to your PC using an infrared (IR) connection.

Connecting to a network or the Internet

You will need a Network Encryption key from your IT Administrator for this procedure.

- 1 Tap **Start** > **Settings** > **System** tab at the bottom of the screen > **V38r Utility** > tap **YES** to enable the **Wireless Card**.
- 2 Wait for the list of wireless **APs** (**Access Point**) to appear. If you do not see the AP that you want, tap **Settings**. Select the **AP** that is available.
- 3 The **Network Key** screen appears. Enter the web encryption from your Administrator. tap the **Network Key** tab.
- 4 Clear the box next to "**The key is provided for me automatically.**" Then, enter your network key in the network key field.
- 5 Tap **OK** at the top of the screen. Wait a few seconds till you see the symbol at the top of the screen that looks like a beacon as shown on the right to indicate the status. Also, notice the status bar at the bottom of the screen.



Using an infrared connection

An infrared (IR) connection will allow you use your **V38r** to exchange information (such as contacts and appointments) with other mobile devices as well as your PC. *For more information, see the section on "Using Microsoft ActiveSync."*

Use the infrared (IR) port on the **V38r** to exchange (send/receive) files with another mobile device.

Sending Information

- 1 Switch to the program in which you created the item you want to send, then locate the item in the list.
- 2 Align the IR ports so that they are unobstructed and within a close range.

CAUTION: If the devices are too far apart or if something blocks the path between the two ports, data might not be sent or received correctly.

- 3 Press and hold the item, then tap **Beam Item** on the pop-up menu.

You can also send items, but not folders, from File Explorer. Press and hold the item you want to send, then tap **Beam File** on the pop-up menu.

Receiving Information

- 1 Align the IR ports so that they are unobstructed and within a close range.
- 2 Tap , tap **Programs**, then tap **Infrared Receive**.
- 3 Have the owner of the other device send the information to you. Your **V38r** will automatically receive it.

Wireless connection information

To enable wireless, tap the Windows **Start** button > **Settings** > **Control Panel** > tap the **Wireless LAN On/Off** icon with the antennae > check **Turn Wi-Fi On** > **OK** double-tap the **Nethood icon** . The **WLAGS46F1** information window opens with the following three tabs:

- **IP Information Tab** - Displays current IP settings
- **IPv6 Information Tab** - Displays additional current settings
- **Wireless Information Tab** - Automatic IP address assignment

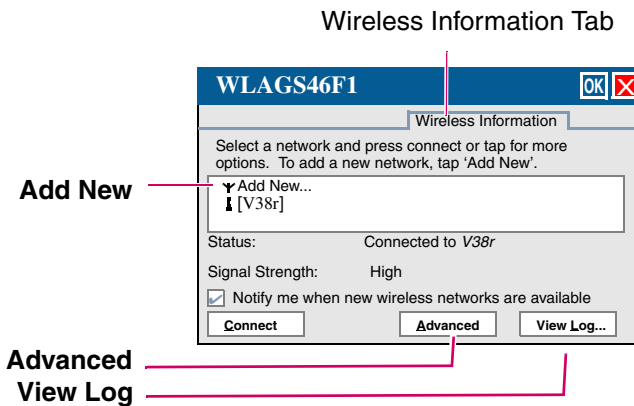

The **Wireless Information** window lists all Wi-Fi networks available to the **V38r**, allowing you to choose a connection. It also allows you to alter and control connections to available networks:

- **Add New** - opens the **Wireless Network Properties** window allowing you to set up a new network and provides settings for network name, encryption type, and authentication options.
- **Advanced** - Allows you to set a hierarchy of connections in order of preference. Should one connection become unavailable, the device automatically cycles down the list to the next connection on the list.
- **View Log** - opens the **Wireless Network Log** window which displays the success or failure of the most recently made attempts to connect to available networks.

IMPORTANT! *If you are not thoroughly familiar with network types, you should avoid making changes to your **Advanced** settings without first seeking assistance from your IT Administrator.*

Wireless connection signal status

The Antenna Status LED at the upper right corner of the **V38r** also displays useful information on the wireless signal connection.

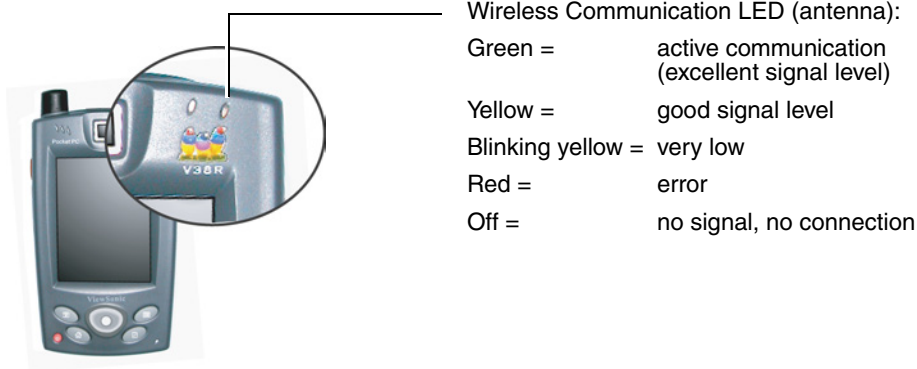

Wireless and network settings

The quality of your radio connection signal can be weakened by excessive distance and by intervening materials such as walls and furnishings.

WLAGS46F1 manual settings

Tap Windows **Start** > **Settings** > **Control Panel** > **Network** and **Dial-up Connections**. This panel allows you to assign IP server address and Domain Name server address for your **V38r**.

VPN settings

To access VPN (Virtual Private Network) settings, tap the Windows **Start** button > selecting **Settings, Control Panel > Network > tap the Dial-up Connections** icon > make a new connection icon with **add, name**, and configure five types of connection options to your **V38r**.

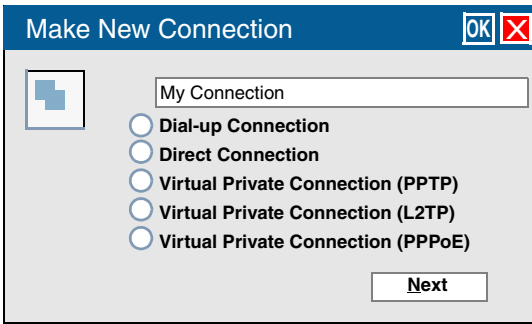

- Dial-up Connection - through modem (not currently supported)
- Direct Connection - through cable
- Virtual Private Network (PPTP) - through host or IP address
- Virtual Private Network (L2TP) - through host or IP address
- Virtual Private Network (PPPoE) - through host or IP address

Each connection type has options for Security and TCP/IP settings accessed by tapping the **Next** button. The Dial-up and Direct connections have additional options for the configuration of port settings and connection preferences.

ISP Address Tab - Allows you to choose between an automatically set IP address (DHCP) or a specified IP (user filled-in) address.

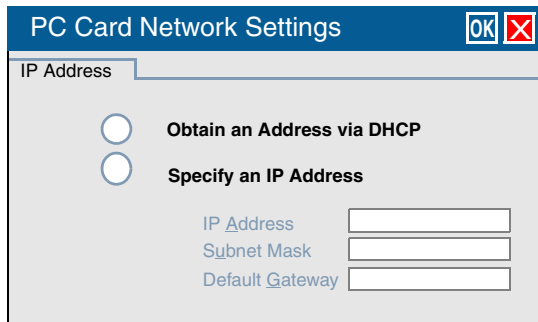

- Obtain an IP Address via DHCP - Prompts device to chose an automatically set IP address (DHCP) rather than a specified IP (user filled-in) address.
- Specify an IP Address - Prompts the device to select the DNS server address entered rather than relying on the network to automatically assign one.

Name (Domain) Servers Tab - DNS assignment, if DHCP is enabled

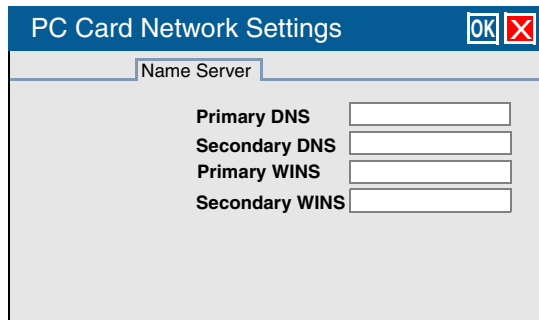

Primary/Secondary DNS - Allows you to enter DNS preferences.

Primary/Secondary WINS - Allows you to enter WINS preferences.

IMPORTANT: *If you are not thoroughly familiar with IP and DNS settings, you should avoid making changes here without first seeking assistance from your IT Administrator.*

THE CAMERA

Availability depends on the model shipped.

This section shows how to download **Active Sync** to your PC and the camera application to the **V38r** device followed by some of the camera features.

Requirements

- The **V38r Camera** application works on a **ViewSonic V38r Rugged Handheld** running on **Microsoft Windows** with CE.NET and Pocket PC 2003 Second Edition
- 1.9 MB free space for the camera application

WARNING: If you remove the battery, you lose the camera application. Reinstall the backup files from the SD card which includes the camera application and the backup software.

Install Active Sync & the camera application

This step synchronizes your PC with the **V38r** device.

- 1 Put the **ViewSonic Companion CD** into the CD ROM drive of your PC. The CD auto loads and a menu appears. Select **Active Sync**.
- 2 Install **ActiveSync** or browse the **ViewSonic Companion CD** to the **ActiveSync** folder and tap **setup.exe**. A message appears about the **file downloading**.

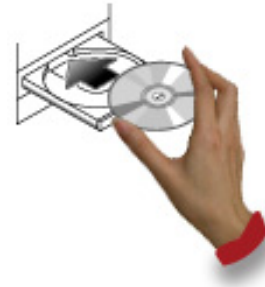

Not enough free space? Close all programs > re-start your PC > download again. Temporary files will be deleted automatically from your hard drive when installation is complete.

Continued...

- 3 Turn the **V38r** OFF > connect the dongle that came in the package to the **V38r** > connect a USB cable to the dongle and the other end to your PC.



- 4 Turn the **V38r** power **ON** by pressing the power button. **ActiveSync** auto-detects your **V38r**. The connection status appears. A **New Relationship** menu appears. Select **Guest** > tap **Next Step**. A **Connecting** message appears. Follow the on-screen instructions.
- 5 Tap **VS Cam.exe** on the CD ROM or hard drive to install the camera application. A message appears about the status of the installation > tap **OK**. The camera application launches.

To un-install the camera application

Tap **Windows Start** > select **Settings** > **Control Panel** > **Add or Remove Programs**. Wait for the list of programs to appear > select **VS Cam** > **Remove**.

Launch the camera application

If you just installed the camera application as shown on the previous page, the application launches automatically. But, if you have turned the **V38r** off and want to launch the camera application, tap **Windows Start > Programs > VS Cam.**

When the camera application launches, the buttons and the touch screen icons function as shown below. Some icons are either functional or give useful information like the status of the battery or the date.

For more information on the functions and status of the icons, see the next few pages. The icons change depending on where you are in the camera application, whether you are taking a picture, viewing images, or viewing images side-by-side.

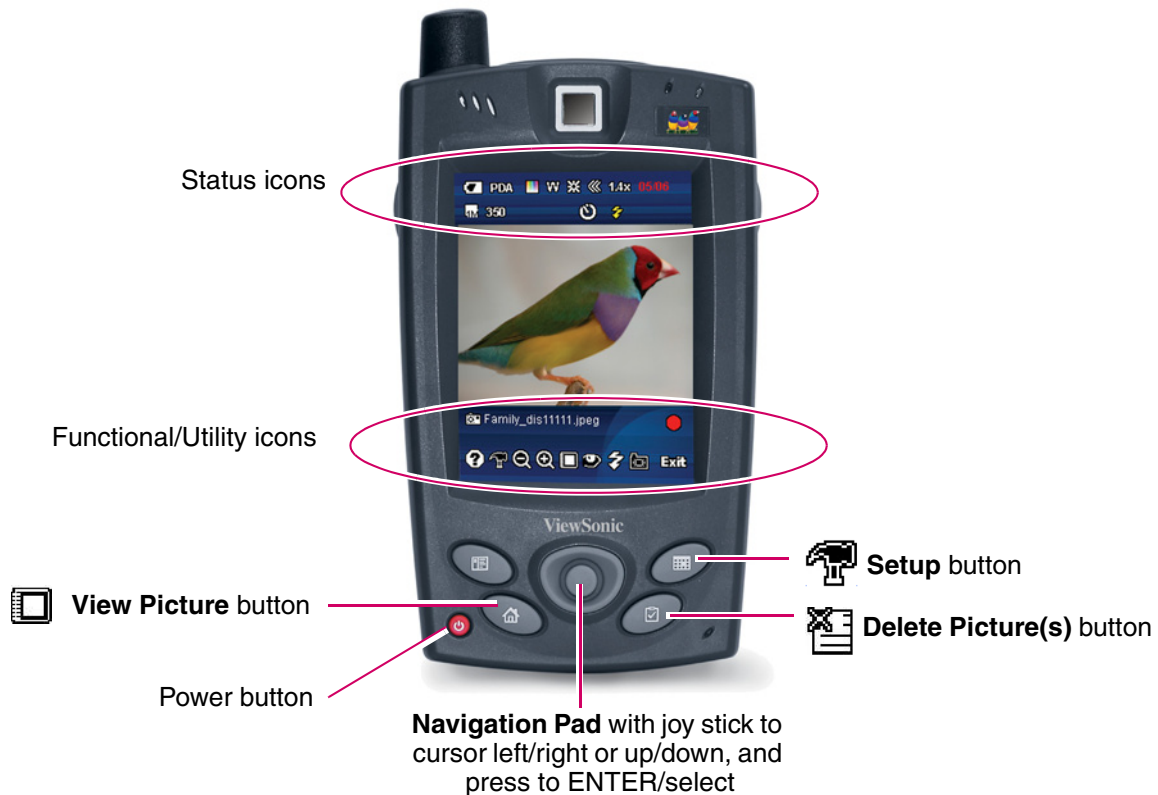











Take a picture

Pictures are taken in the camera application only in **PORTRAIT** mode as shown below. To take a picture, press the **Shutter release** button on the left side or tap the red dot icon [] with the stylus.



Functions and status icons when TAKING A PICTURE

	Icon	Description
Functions		Press this icon to take a picture
		Flash ON/OFF
		Setup Mode. You can change settings in Setup Mode; for example, switch between Left or Right Hand Mode.
		View images
		Zoom IN/OUT: Only at low resolution
Status		Continuous Shooting ON in Photo Mode
		Brightness
		White Balance
	XGA VGA QVGA QCIF	Picture resolution: default is 640 x 480
	SD PDA USB	Storage capacity
		Timer ON in Photo Mode
	Date	Default is MM-DD-YY+HH-Mm. Change format in Changing the SETUP section of this guide
		Battery
	1.0x 1.2x 1.4x 1.6x 1.8x 2.0x	Zoom

View picture

To view pictures, tap the **VIEW picture icon** [🖼️] or the **HOME button** [🏠]. In the camera application, the **HOME button** changes functions to **VIEW picture**. The **V38r** automatically goes to **LANDSCAPE** mode to view pictures.

PORTRAIT mode



LANDSCAPE mode (view picture)



💡 Images are stored in the device's memory by default. *To change where the images are stored, see the section on **Changing the Setup**.*

To view the previous or next picture in the folder, tap the **View Previous/Next** icon. *For more information about the icons in View mode, see the table below.*



Functions and status icons when VIEWING pictures

	Icon	Description
Functions		Back to Capture Mode
		Browse pictures in other folders
		Delete the picture on-screen. <i>For more information, see Deleting the picture(s) on the next page</i>
		Delete all pictures in current folder. <i>For more information, see Deleting a picture(s) on the next page</i>
		Zoom in/out
		View pictures side-by-side. <i>For more information, see the Side-By-Side section in this guide</i>
		Save picture in low resolution: a pop-up menu appears > choose to save the file in 640x480, 320x240, or 176x144. If the picture is already 640x480 (320x240) or lower, this option is not be available
		View previous picture in the current folder or press the left/right navigation buttons
Status	+	Filename
	nn/NN	Picture order number/total number of pictures in folder
	Date/Time/ Hour	Time the picture was taken: i.e., 2005 6 1 14:20

Delete a picture(s)

To delete a picture(s), press the **Delete picture** button [] or icon []. A menu appears for you to make a selection.

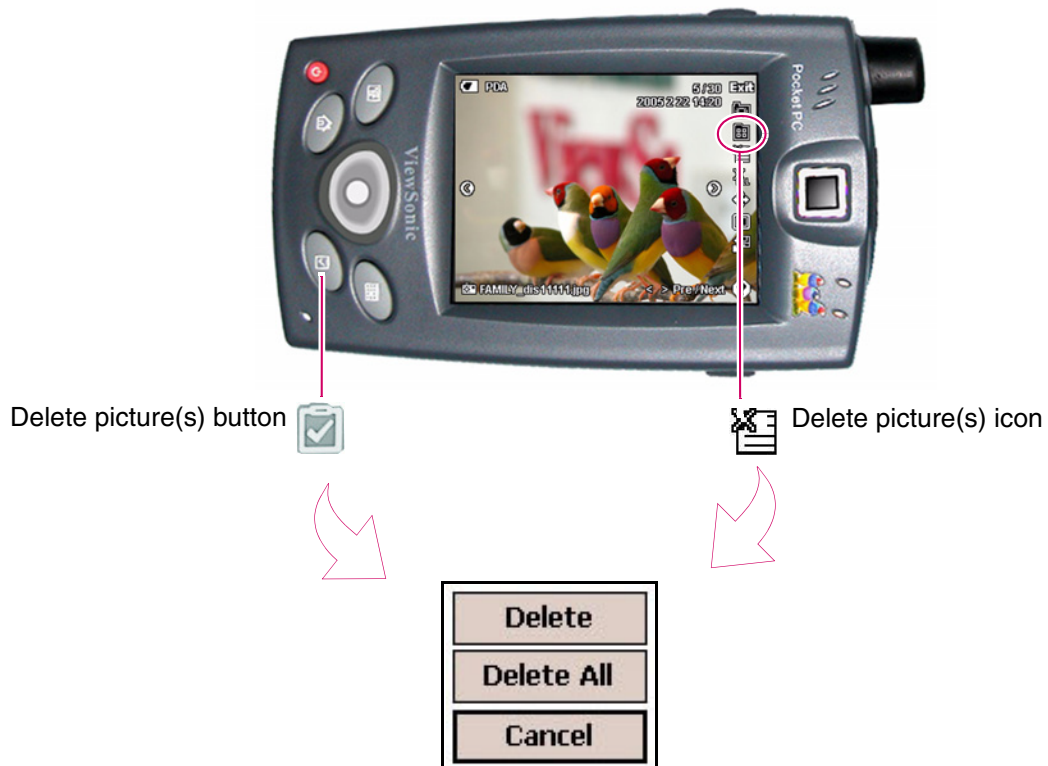

View pictures side-by-side

Tap the **Side-by-side icon** [] to view two pictures on-screen.



Side-by-side icon



Two pictures side-by-side

Compare one picture with another

With two pictures side-by-side on-screen, you can compare one picture with another. One picture remains stationary and the other goes to the **Previous** or **Next** picture in the folder. Tap the **Previous/Next** picture icon [🔍🔍] under the picture on the left side as shown below. The picture changes while the picture on the right side remains stationary.







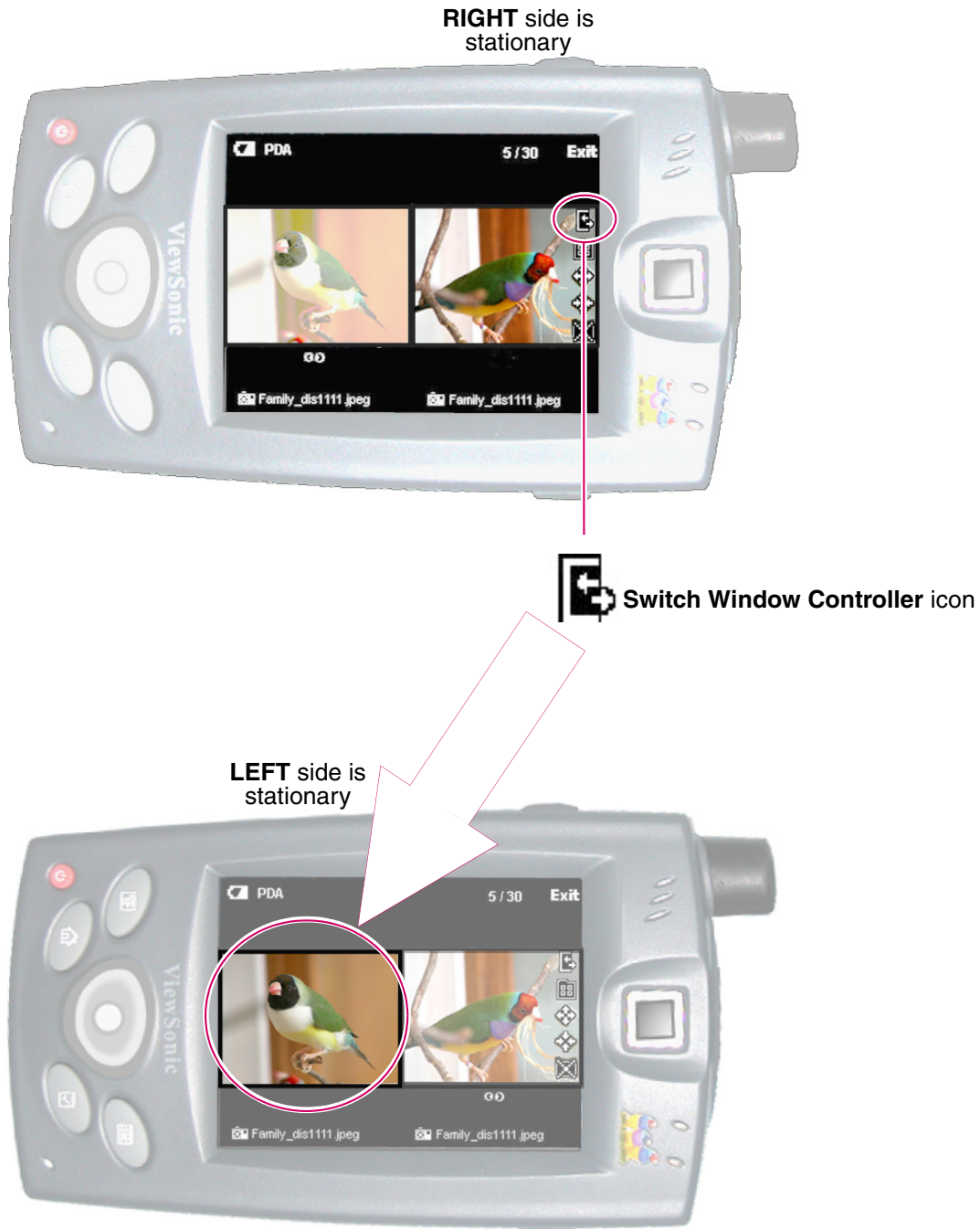







Make the other side stationary

To switch the side that stays stationary, tap the **Switch Window Controller** icon [🔍]. The stationary picture switches over to the other side as shown below.



Functions and status icons in SIDE-BY-SIDE mode

	Icon	Description
Functions		Switch Window Controller from one side of the screen to the other to compare pictures in different folders. Default: sub window
		Browse pictures in other folders
		Expand image to view actual size. Press left/right, up/down, or drag the picture with the stylus to move picture on-screen
		Fit the image in the current window to the screen
		Close side-by-side view
		View Previous Picture in the current folder
		View Next Picture in the current folder
Browse		Select a folder to browse
		Browse images by list
		Browse images by thumbnails (3x2)
		OK to view the selected image
		Exit Browse

Download pictures

To download pictures, do one of the following:

- Move pictures from the VS Cam folder to the SD memory card, or
- In **ActiveSync** mode, download pictures to a PC folder connected with a USB cable.

Changing the camera setup

To change settings, press the **Setup icon** or the **Setup Button** as shown on the right. A menu appears where you can select **Basic**, **Advanced**, or **System** settings.

The **Setup Icon** [] appears in the Camera application but not in the Bar Code application.



Basic settings

Function	Option	Description	Default
Continuous	1/ 2/ 4/ 6	The number of images taken per snap	1
Picture Resolution	1024 x 768 XGA 640 x 480 VGA 320 x 240 QVGA 176 x 144 QCIF	In JPEG file format	640 x 480
Storage	SD DEVICE USB Memory Device	Secure Digital Memory Card Built-in memory External hard/memory disc	Device memory
Shutter Sound	Check box to Enable/ Disable	Simulates the sound of pressing a camera's shutter release to take a picture	ON
Timer	Check box to Enable/ Disable	When Timer is enabled, the Timer icon  appears on-screen: when you press the Snap Picture Button or the on-screen icon, the Timer Icon blinks for 10 seconds and then takes the picture	OFF
Flash	ON/OFF		OFF

Advanced settings

Function	Option	Description	Default
Formats for Date/ Time/ Hour/ Minutes	None YY – MM – DD MM – DD – YY YY – MM – DD+HH – Mm MM – DD – YY+HH – Mm	Time format	MM – DD – YY+HH – Mm
On-screen location for the Date/ Time/ Hour/ Minutes	Top Left Top Right Bottom Left Bottom Right		Top Right
White Balance	Auto Indoor Halogen Indoor Office Outdoor Sunny Cloudy Outdoor Sunny Only Outdoor Cloudy		Auto
Brightness	Darkest Darker Dark Normal Brighter Brightest		Auto
Zoom	1.0x 1.2x 1.4x 1.6x 1.8x 2.0x	Only zoom in lower resolution	1.0x

Check the box to Enable or Disable file deleting from the camera (allow deleting a file).

System settings

Function	Option	Description	Default
Operation Mode	Portrait (Right Handed ONLY) Landscape (Right or Left Handed)	Camera rotates to use with right or left hand	Left Handed
Flicker Control	50Hz 60Hz		60Hz
Default Value	Tap on Default Value to return settings to factory defaults		
S/W Version	Version	Camera software version	
About	Product Information	ViewSonic Copyright Software version	

Exit the camera application

Tap **EXIT** on-screen to exit the camera.



BAR CODE SCAN

Scan a bar code

- 1 Open MS **Word** or **Excel** (tap Windows **Start** > **Programs** > **MS Word** or **Excel**) Open a **New Document**.
- 2 Point the **V38r** four to five inches from the bar code and press the scan button on the right side. The bar code number appears in the display and beeps. You're done scanning!

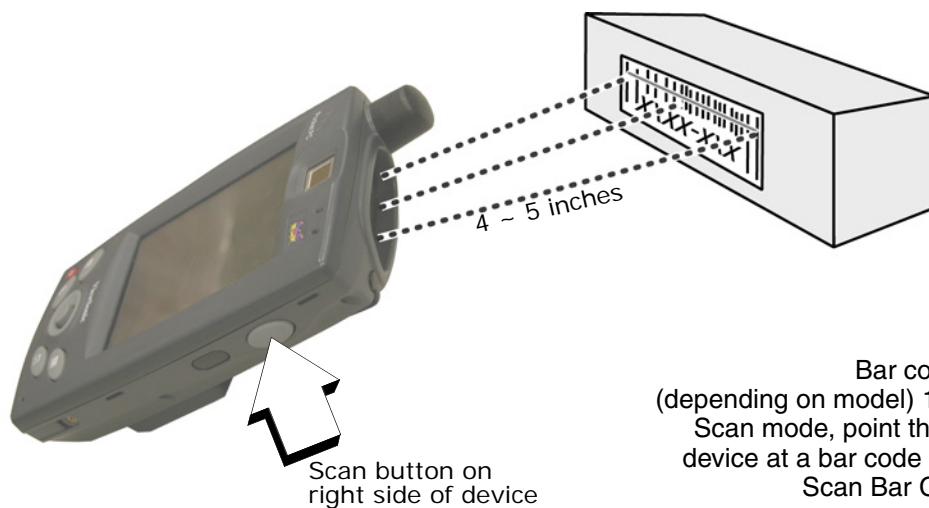

Adding different bar code formats

To add an additional bar code format to the **V38r** for scanning, your administrator should assist you with this process. Point the **V38r** bar code scanner at one of the following bar codes.

1 Reset factory defaults (optional)



2 Select baud rate (* default value)



3 Select data bits



4 Select parity



5 Select stop bits



6 Select postamble

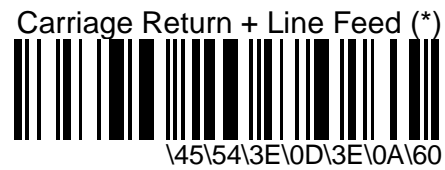

7 Disable all symbologies



8 Select symbologies

Codabar (minimum length=6)



\41\52\60

Code 39 (*)



\41\4C\60

Code 128 / EAN 128



\41\5A\60

Interleaved 2 of 5
(minimum length=6)



\41\4E\60

Standard 2 of 5
(minimum length=6)



\41\50\60

UPC-A, UPC-E, EAN-8,
EAN-13 (*)
(UPC-A → EAN-13)

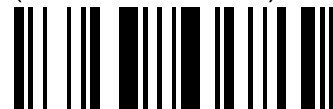

UPC-A, UPC-E, EAN-8, EAN-13
(UPC-A → UPC-A)



9 Test symbologies

Codabar



123456

Code 39

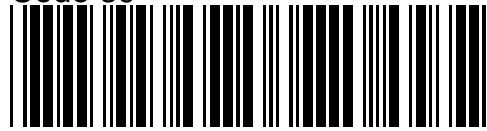

CODE 39

Code 128

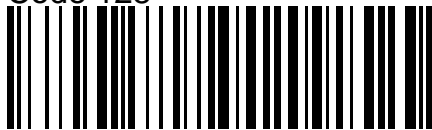

CODE 128

Interleaved 2 of 5



12345678901234

Standard 2 of 5

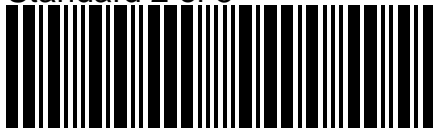

123456

EAN-13



1234567890128

UPC-A

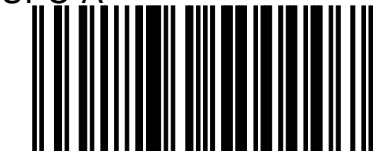

0 01234 50000 7

TROUBLESHOOTING & MAINTENANCE

This section gives solutions to common **V38r** problems you may encounter when using the device and guidelines for taking care of your **V38r**. If you encounter a problem that you cannot solve, contact your reseller or **ViewSonic Customer Support**. See the "Customer Support" section for contact information.

Reset the V38r

Warm reset – *do this first!*

A **Warm reset** may be required on rare occasions if your **V38r** completely locks up. To do a **Warm reset**, press and hold both the **POWER** and the **HOME** buttons down for four (4) seconds. This should unlock the device. If not, do a **Cold reset**.

Cold reset



WARNING! all customization in SDRAM (files, programs, and settings) will be lost with a **Cold reset**. As a precaution, make sure the backup battery switch is in the ON position, then drag any changed files that you want to protect to the **V38r's Permanent Storage** folder before removing the battery.

If the **Warm reset** did not work and your **V38r** locks up or fails to respond to the stylus, do a **Cold reset** as follows: press and hold the **POWER** button down for 15 seconds to reset the device to factory settings.

Firmware image upgrade

From time to time, **ViewSonic** may offer a firmware image upgrade for the **V38r**. For current information, visit our web site at viewsonic.com or check with your IT Administrator. You need access to the Internet on your PC in order to download new firmware.

- 1 Before upgrading to a new firmware image, save all your data to your storage device.
- 2 **VERY IMPORTANT!** Slide the backup battery switch that is in the battery compartment to the **OFF** position. Remove all power connections (AC and battery).
- 3 Format the SD Memory Card to FAT16. Copy the firmware image (**NK.bin**) onto the SD Memory Card.
- 4 Loosen the screw to the **SD slot cover** shown on the right. Slide the SD card carefully into the slot on the side of the **V38r** until the card snaps into place.
CAUTION: Make sure the card is turned correctly before sliding the card into the slot. The card should have an arrow saying which side is up and which end goes in first. Do not force the card in or out. It should be easy to slide in or out.
- 5 Connect the AC power to the device **WITHOUT** turning on the power.
- 6 Press and hold down the button as shown on the right.
- 7 Press and release the power button to turn the device **ON** and let the new image be installed. Wait for the message saying the installation is "**DONE.**"
- 8 To remove the SD card, push the card inwards until the card pops out.
- 9 **VERY IMPORTANT!** Slide the backup battery switch to the **ON** position before using the device.



Power problems

Power does not turn on when using battery power

The remaining battery power may be too low to run your **V38r**. Connect the AC adapter to your **V38r** and to external AC power. Then, turn on your **V38r**. (Charge the battery whenever possible to avoid running out of battery power and thus losing data.)





Battery runs out of power quickly

You might be using your **V38r** in ways that drain power quickly. For more information, see the section “Managing Power” in this guide for tips on saving power.

Memory problems

If a warning message of not enough memory appears due to a memory allocation problem, try the following to free memory on your **V38r**.

CAUTION: Be discreet when you delete files. Deleting files of which the function is unknown can cause programs or features to malfunction. It is recommended that you create a backup before deleting files.

- Delete files you no longer need. Tap , **Programs**, and then **File Explorer**. Press and hold the file you wish to delete, then tap **Delete** on the pop-up menu. To find your largest files, tap , then **Find**. In the **Type** list, tap **Larger than 64KB**, then tap **Go**.
- Remove programs you no longer need. Tap , and then **Settings**. Tap **System** tab, then tap **Remove Programs**. Tap the program you want to remove then tap **Remove**.
- In Internet Explorer options, delete all files then clear history. In Internet Explorer, tap **Tools** then **Options**. Tap **Delete Files** then **Clear History**.
- If you are copying files from a computer or other device to your **V38r**, try adjusting the slider in the Memory setting. Tap , then **Settings**. Tap **System** tab, then tap **Memory**. Check to see if you can manually move the slider before copying files.

Stop programs you are not currently using. In most cases, programs automatically stop to free needed memory. However, in some situations, such as when confirmation dialog boxes are waiting for a user response, the program may not be able to automatically stop. To check the state of your active programs, tap , then **Settings**. Tap **System** tab, tap **Memory**, then **Running Programs**. Tap the program you want to view and tap **Activate**. Close any open windows or messages and return the program to list view. If this does not work, you can stop the program

manually. First, make sure that your work is saved by closing open items and return the program to list view. Then, stop the program by tapping **Stop** or **Stop All** on the **Running Programs** tab.

Reset your **V38r** as described earlier in this section.

If you have an SD card, move data to the SD card as follows:

Tap , **Programs**, then **File Explorer**. Press and hold the file you want to move, then tap **Cut**. Browse to My Documents folder in the SD card folder, tap **Edit**, then **Paste**. Files stored in folders other than My Documents or stored in subfolders within subfolders in My Documents may not show up in the list view of some programs. When using Notes, Pocket Word, or Pocket Excel, you can also move files by opening the item then tapping **Tools** or **Edit** then **Rename/Move**.

Files stored in folders other than My Documents or stored in subfolders within subfolders in My Documents may not show up in the list view of some programs. When using Notes, Pocket Word, or Pocket Excel, you can also move files by opening the item then tapping **Tools** or **Edit** then **Rename/Move**.

Screen problems

Screen is off

If the screen does not respond, even after you press the power button, try the following until the problem is solved:

- 1 Connect the AC adapter to your V38r and to external AC power, then
- 2 Reset your **V38r** as described in “Resetting Your **V38r**” earlier in this section.

Screen responds slowly

Make sure that your **V38r** is not running out of battery power or running many active programs. If the problem still exists, reset your **V38r** as described in “Resetting Your **V38r**” earlier in this section.

Screen freezes

Reset your V38r as described in “Resetting Your V38r” earlier in this section.

Screen is hard to read

- Make sure that the backlight of the display is on.
- Move to a location with enough light.
- If you are having a hard time reading a document on the screen, try adjusting the zoom percentage or text size.
 - In **Notes**, tap **Tools**, then select a zoom percentage.
 - In **Pocket Word** and **Pocket Excel**, tap **View**, tap **Zoom**, then select a zoom Percentage.
 - In **Pocket Internet Explorer**, tap **View**, tap **Text Size**, then select a size.
 - In **Calendar**, **Contacts**, and **Tasks**, tap **Tools**, tap **Options**, then select **Use large font**.

Inaccurate response to stylus taps

Realign the touch screen. Tap **Start**  > **Settings** > **System** tab > **Align Screen**. If you cannot realign the touch screen, turn off the **V38r**. Press the power button to turn on the **V38r**. You should now be able to start the touch screen alignment process.

Device connection problems

USB dock/cradle connection problems

- Make sure that you installed the correct version of **ActiveSync** on your desktop PC. Install the version **ActiveSync** included with your **V38r**.
- Make sure that your **V38r** and your desktop PC are turned on.
- Make sure that you do not have any other active connections.
- When using the USB cradle, make sure that your **V38r** is properly seated.
- Make sure that the cable is securely plugged into the USB port on your desktop PC. Connect the USB cable directly to your desktop PC — do not run the cable through a USB hub.
- Make sure that the USB connection is enabled in ActiveSync on your desktop PC. If the USB connection is already enabled, disable the USB connection, close the Connection Settings window, and then reopen and re-enable the USB connection.
- Reset your **V38r** before connecting the USB cable. (See “Resetting Your **V38r**” earlier in this section.) Always disconnect your **V38r** before you restart your desktop PC.
- Connect only one **V38r** or personal digital assistant to your desktop PC at a time.

Infrared connection problems

- Transfer only one file, or no more than 25 contact cards, at a time.
- Position the IR ports so that they line up at a distance less than 20 cm (8 inches) but more than 5 cm (2 inches) apart.
- Make sure that there are no obstacles between the two IR ports.
- Adjust the room lighting. Some types of light interfere with IR communications. Try moving to a different location or turning off some lights.

Care and maintenance

Taking good care of your **V38r** ensures trouble-free operation and reduces the risk of damage to your **V38r**.

General guidelines

- Keep your **V38r** away from excessive moisture and extreme temperatures.
- Avoid exposing your **V38r** to direct sunlight or strong ultraviolet light for extended periods of time.
- Do not place anything on top of your **V38r** as this may damage the display.
- Do not drop your **V38r**.
- Store your **V38r** in a protective case when not in use.
- The screen surface is easily scratched. Use only the stylus to tap on the screen. Avoid touching the screen with your fingers, pens, or pencils.

To clean the screen

- 1 Make sure the V38r is turned off.
- 2 Never use paper towels to clean the screen.
- 3 Never spray or pour any liquid directly onto the screen or case.
- 4 Never immerse the **V38r** in any liquid.
- 5 Use a soft, lint-free cloth moistened with water to remove dust and other particles off the screen and the exterior of the **V38r**.
- 6 If still not clean, apply a small amount of non-ammonia, non-alcohol based glass cleaner onto a clean, soft, lint-free cloth, and wipe the screen.

Disclaimer: ViewSonic® does not recommend using any ammonia or alcohol-based cleaners on the V38r screen or case. Some chemical cleaners have been reported to damage the screen and/or case of the device. Doing so may void the warranty and ViewSonic will not be liable for damage resulting from using any ammonia or alcohol-based cleaners.

Travel guidelines

- Before traveling with your **V38r**, back up your data. As an added precaution, bring along a backup copy.
- Turn off your **V38r** and disconnect all external devices.
- Make sure that the battery is fully charged.
- Take the AC adapter with you. Use the AC adapter as the power source and as a battery-recharger.
- Hand-carry your **V38r** in a protective case.
- Consult the airlines first before using your **V38r** on the plane. You need to be very careful when using electronic devices during the flight.
- If you plan to travel abroad with your **V38r**, consult your dealer for the appropriate AC adapter for use in your country of destination.

Customer support

For Customer Support contact information, see the **V38r Rugged Handheld User Guide** on the **ViewSonic Companion CD**. You will need the product's serial number on hand when you call. Before sending the **V38r** out for service, be sure to back up all data and remove all third party software. See the Data Loss Disclaimer in the Appendix.

Country/Region	Website (for email address also)	T = Telephone F = FAX
United States	www.viewsonic.com	T: (800) 688-6688 F: (909) 468-1202
Canada	www.viewsonic.com	T: (800) 688-6688 F: (909) 468-1202

Wireless products disclaimer

The actual data throughput rate is controlled by several factors including but not limited to the following: (1) network conditions (volume of network traffic, network overhead, etc.) and (2) environmental factors (power surge, building materials, and construction, etc.).

APPENDIX

Optional accessories

The following optional accessories will be available from ViewSonic:

- Cradle with battery charging and communication
- Car adapter
- Extended battery with extended back cover
- Dongle with communication and AC power
- Belt clip
- Hand strap

The cradle: the optional **V38r** cradle easily connects to the ports shown below. The cradle can be used to charge, recharge, and/or operate your **V38r**. *For more information, see the Battery Power and Properties section of this guide.*

IMPORTANT: Remove any cable or dongle connected to the **V38r** and place the **V38r** in the cradle.



V38r mounted in the cradle

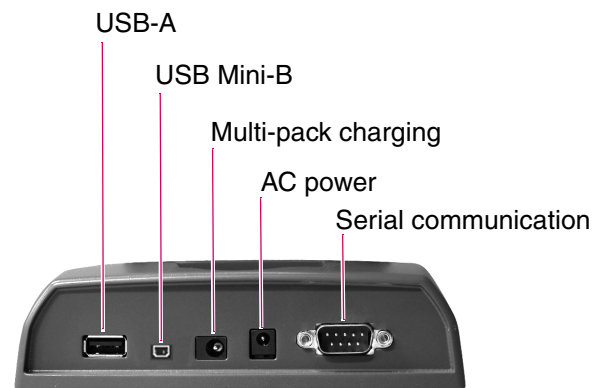

Back of cradle

External USB keyboard and mouse: You can attach a USB external keyboard or mouse that is commercially available to the cradle's USB-A port or the communication dongle.

Safety guidelines

CAUTION: The socket-outlet should be installed near the equipment and be easily accessible.

CAUTION: Use a power cable that is properly grounded. Always use the appropriate AC cord that is certified for the individual country. Some examples are listed below:

USA	UL	Switzerland	SEV
Canada	CSA	Britain	BASE/BS
Germany	VDE	Japan	Electric Appliance Control Act

IMPORTANT NOTICE CONCERNING POWER CORD SELECTION: The power cord set for this unit has been enclosed and has been selected according to the country of destination and must be used to prevent electric shock.

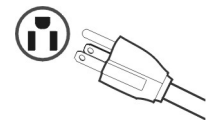

For the United States and Canada: In the United States and Canada the male plug is NEMA5-15 style (shown above), UL Listed, and CSA Labeled. For units which are mounted on a desk or table, type SVT or SJT cord sets may be used. For units which sit on the floor, only SJT type cord sets may be used. The cord set must be selected according to the current rating for your unit. Please consult the table below for the selection criteria for power cords used in the United States and Canada.

Cord Type	Size of Conductors in Cord	Maximum Current Rating of Unit
SJT	18 AWG	10 Amps
	16 AWG	12 Amps
	14 AWG	12 Amps
SVT	18 AWG	10 Amps
	17 AWG	12 Amps

For European countries

In Europe you must use a cord set which is appropriate for the receptacles in your country. The cord set is HAR-Certified, and a special mark that will appear on the outer sheath, or on the insulation of one of the inner conductors.

AC PLUG CORD PRECAUTIONS FOR THE UNITED KINGDOM

FOR YOUR SAFETY PLEASE READ THE FOLLOWING TEXT CAREFULLY.

IF THE FITTED MOULDED PLUG IS UNSUITABLE FOR THE SOCKET OUTLET THEN THE PLUG SHOULD BE CUT OFF AND DISPOSED OF SAFELY. THERE IS A DANGER OF SEVERE ELECTRICAL SHOCK IF THE CUT OFF PLUG IS INSERTED INTO AN APPROPRIATE SOCKET.

If a new plug is to be fitted, please observe the wiring code as shown below. If in any doubt, please consult a qualified electrician.

WARNING: THIS APPLIANCE MUST BE EARTHED.

IMPORTANT: The wires in this mains lead are coloured in accordance with the following code:

- Green-and-Yellow: Earth
- Blue: Neutral
- Brown: Live

If the coloured wires of the mains lead of this appliance do not correspond with the coloured markings identifying the terminals in your plug, proceed as follows:

The wire which is coloured GREEN-AND-YELLOW must be connected to the terminal in the plug which is marked by the letter E or by the Earth symbol or coloured GREEN or GREEN-AND-YELLOW.

The wire which is coloured BLUE must be connected to the terminal in the plug which is marked with the letter N or coloured BLACK. The wire which is coloured BROWN must be connected to the terminal in the plug which is marked with the letter L or coloured RED.

If you have any questions concerning which proper power cord to use, please consult with the dealer from whom you have purchased the product.

Compliance and safety notices

Radio frequency interference (RFI) compliance

United States compliance notice

This equipment has been tested and found to comply with the limits for a Class B digital device, pursuant to Part 15 of the Federal Communications Commission (FCC) Rules. These limits are designed to provide reasonable protection against harmful interference in a residential installation. This equipment generates, uses, and can radiate radio frequency energy and, if not installed and used in accordance with the instructions, may cause harmful interference to radio communications. However, there is no guarantee that interference will not occur in a particular installation. If this equipment does cause harmful interference to radio or television reception, which can be determined by turning the equipment off and on, the user is encouraged to try to correct the interference by one or more of the following measures:

- Reorient or relocate the receiving antenna.
- Increase the separation between the equipment and the receiver.
- Connect the equipment into an outlet on a circuit different from that to which the receiver is connected.
- Consult the dealer or an experienced radio or television technician for help.

CAUTION: The Part 15 radio device operates on a non-interference basis with other devices operating at its frequency. Any changes or modification to said product not expressly approved could void the user's authority to operate this device.

FCC Caution: Any changes or modifications not expressly approved by the party responsible for compliance could void the user's authority to operate this equipment.

This device complies with Part 15 of the FCC Rules. Operation is subject to the following two conditions: (1) This device may not cause harmful interference, and (2) this device must accept any interference received, including interference that may cause undesired operation.

The antenna(s) used for this transmitter must not be co-located or operating in conjunction with any other antenna or transmitter.

IMPORTANT NOTE: FCC Radiation Exposure Statement:

This equipment complies with FCC radiation exposure limits set forth for an uncontrolled environment. This equipment should be installed and operated with minimum distance **1.5cm** between the radiator & your body.

Proper operation of this radio according to the instructions found in this user's guide will result in user exposure that is substantially below the FCC recommended limits.

- Do not touch or move antenna while the unit is transmitting or receiving.
- Do not hold any component containing the radio such that the antenna is very close or touching any exposed parts of the body, especially the face or eyes, while transmitting.
- Do not operate a portable transmitter near unshielded blasting caps or in an explosive environment unless it is a type especially qualified for such use.
- Do not operate the radio or attempt to transmit data unless the antenna is connected: if not, the radio may be damaged.

Canadian compliance notice

English: This digital apparatus does not exceed the Canada ICES-003 Class B limits for radio noise emissions from digital apparatus as set out in the radio interference regulations of the Canadian Department of Communications.

French: Le present appareil numerique nemet pas de bruits radioelectriques depassant les limites applicables aux appareils numeriques de Canada ICES-003 Class B prescrites dans le reglement sur le brouillage radioelectrique edicte par le Ministere des Communications du Canada.

European compliance notice

Products with the CE Marking comply with both the EMC Directive (89/336/EEC) and the Low Voltage Directive (73/23/EEC) issued by the Commission of the European Community.

Compliance with these directives implies conformity to the following European Norms:

- EN55022 (CISPR 22) Radio Frequency Interference
- EN55024 (IEC61000-4-2, -4-4, -4-5, -4-6, -4-11)
- EN60950 (IEC950) Product Safety



Industry Canada Statement

"This device has been designed to operate with the antennas listed below, and having a maximum gain of 3.21 dBi. Antennas not included in this list or having a gain greater than 3.21 dBi are strictly prohibited for use with this device. The required antenna impedance is 50 ohms."

"Operation is subject to the following two conditions: (1) this device may not cause interference, and (2) this device must accept any interference, including interference that may cause undesired operation of the device."

"To reduce potential radio interference to other users, the antenna type and its gain should be so chosen that the equivalent isotropically radiated power (e.i.r.p.) is not more than that permitted for successful communication."

Battery safety notice

- The battery pack is intended for use only with this device.
- Do not disassemble the pack.
- Do not dispose of the battery pack in fire or water.
- To avoid risk of fire, burns, or damage to your battery pack, do not allow a metal object to touch the battery contacts.
- Handle a damaged or leaking battery with extreme care. If you come in contact with the electrolyte, wash the exposed area with soap and water. If it contacts the eye, flush the eye with water for 15 minutes and seek medical attention.
- Do not charge the battery pack if the ambient temperature exceeds 113 degrees Fahrenheit (45 degrees Celsius).
- To obtain a replacement battery, contact your local dealer.
- Do not expose the battery pack to high storage temperatures (above 140 degrees Fahrenheit, 60 degrees Celsius).
- When discarding a battery pack, contact your local waste disposal provider regarding local restrictions on the disposal or recycling of batteries.

Lithium battery notice

The **V38r** has two batteries: one is under the back cover which you can replace yourself but the other is inside the device itself. **DO NOT ATTEMPT TO REMOVE THE INTERNAL BATTERY** as this will void the warranty.

There is also danger of explosion if the device is not used, handled, or disposed of correctly, or if the batteries are replaced incorrectly. Replace batteries only with the same or equivalent type battery as recommended in the **Battery and power properties** section of this guide. Discard used batteries according to the manufacturer's instructions or local laws.

Power supply safety notice

The power supply provided with this device is for use with this device only. Replace only with the same or equivalent type power supply as recommended by the manufacturer.

Infrared LED safety notice

If this device contains an infrared networking or peripheral connection capability, or if one is added to the device, the following precautions are recommended:

- Do not attempt to view the infrared LED beam with any type of optical device.
- Do not attempt to make any adjustment of the unit.
- If the unit requires service, contact an authorized service center.
- Avoid direct eye exposure to the infrared LED beam. Be aware that the beam is invisible light that cannot be seen.

Mercury warning

This product contains mercury. Dispose of in accordance to local, state and federal laws.

Data loss disclaimer

Before sending the **V38r** out for service, be sure to backup all data and remove all third party software.

With respect to all service provided, it is your responsibility to backup the contents of your **V38r**, including any data you have stored or software you have installed on the **V38r**. It is likely that the contents of your **V38r** will be lost in the course of service and ViewSonic will not be responsible for any damage to or loss of any programs, data or other information stored on any media or any part of any Product serviced hereunder.

IF DURING THE REPAIR OF THE PRODUCT THE CONTENTS OF THE **V38r** ARE ALTERED, DELETED, OR IN ANY WAY MODIFIED, VIEWSONIC IS NOT RESPONSIBLE WHATSOEVER. YOUR PRODUCT WILL BE RETURNED TO YOU CONFIGURED AS ORIGINALLY PURCHASED (SUBJECT TO AVAILABILITY OF SOFTWARE).

Be sure to remove all third party hardware, software, features, parts, options, alterations, and attachments not warranted by ViewSonic prior to sending the product to ViewSonic for service. ViewSonic is not liable for any loss or damage to these items.

Specifications

THE V38r DEVICE	Processor	Intel® Bulverde® 416MHz CPU with 64MB flash		
	OS	Microsoft® Windows® PPC2003 (included)		
	Memory	64MB SDRAM (128MB SDRAM depending on model)		
	Display	240x320 transfective TFT panel, 256K colors (3.5" diagonal) Contrast Ratio: 5:1 (B/L off); 80:1 (B/L on); Brightness: Typical 90 nits (with touch panel)		
	Touch Screen	4-wire resistive type, Hardness: 3H Punch life: 1M cycles with 250g force, 2 times/sec Stroke life: 100K cycles with 250g force, repeat 1 inch		
	1.3 Megapixel camera	Picture formats	SXGA, VGA, QVGA, CIF, QCIF	
		F Number	2.8	
		Output Format	YUV, Raw RGB data	
	SD Memory Slot	User accessible SD slot on the left side of unit		
	Dimensions	145mm (L) x 83mm (W) x 32mm (H)		
	Weight	<500g including battery pack and standard expansion hatch cover, excluding Scanner engine and WWAN solution		
	Communication	IrDA (SIR 115 kbps)		
	Wireless Communication	WLAN 802.11b/g (Wi-Fi Compliant), BT (BQB certification)		
	Integrated Antenna	For WLAN		
	Standard battery	3.7V, 1800mAh removal battery pack. Up to 3 hours life (depending on use and configuration), 2000mAh (fast charging), 14.8V (nominal voltage)		
	Extended battery (opt'l)	3.7V, 3600mAh removable battery pack. Over 8 hours operation with full WLAN		
	Power Consumption	System operating, 400mW, LCD maximum brightness, 460mW WLAN/Bluetooth module, Continuous Transmit 1.0829W, Continuous Received 643mW		
	Environment	Operation	-10° F to 104° (-10° C to 55° C), 10% to 85% non-condensing humidity, 0 - 3,000 meters	
		Storage	-4° F to 140° F (-20° C to 75° C), 10% to 85% non-condensing humidity, 0 to 12,000 meters	
	Bar code scanner	1-D Imager	1-D CCD Image engine	
Symbologies		UPC (E&A), EAN, Code 11, Code 39, Code 128, UCC EAN 128, ISBN, ISBT, Interleaved, Matrix, Industrial and Standard 2 of 5, Codabar, Code 93, MSI, Plessey, Telepen		
Basic Software	Internet Explorer Windows Explorer Media Player MS WordPad Solitaire	Microsoft File Viewers MS Excel Viewer MS Image Viewer MS PDF Viewer MS Word Viewer	Windows PPC2003 Microsoft ActiveSync Microsoft Inbox	
Regulatory Approvals	FCC, UL, Radio Country Approvals, US/Canada			
ACCESSORY	Dongle	Power connector with one USB-A port, one mini USB port, Serial RS232 port		
	Cradle	Supports USB, and one serial RS232 port		
OPTIONAL	Echo cancelling option	Hardware echo cancelling for VoIP		
	Fingerprint (depending on model)	Supports AuthenTec® AES3400 SDK fingerprint program (optional) available at ViewSonic® (instructions come with the SDK)		

Limited Warranty

RUGGED HANDHELD PRODUCTS

What the warranty covers:

ViewSonic® warrants its Rugged Handheld products to be free from defects in material and workmanship during the warranty period. If a Rugged Handheld product proves to be defective in material or workmanship during the warranty period, ViewSonic will, at its sole option, repair or replace the product with a like product. Replacement product or parts may include remanufactured or refurbished parts or components. ViewSonic provides no warranty for the third party software included with the product. For specific warranty information, please see the EULAs included with the product. ViewSonic does not warrant that software will meet your requirements or that operation of software will be uninterrupted or error free. VIEWSONIC AND ITS SUPPLIERS DISCLAIM ALL WARRANTIES AND CONDITIONS, EITHER EXPRESS OR IMPLIED, INCLUDING, BUT NOT LIMITED TO, IMPLIED WARRANTIES OF MERCHANTABILITY, FITNESS FOR A PARTICULAR PURPOSE, AND NON-INFRINGEMENT.

How long the warranty is effective:*

ViewSonic Rugged Handhelds are warranted for one (1) year for all parts (except software) and one (1) year for all labor from the date of the first consumer purchase.

Who the warranty protects:

This warranty is valid only for the first consumer purchaser.

What the warranty does not cover:

1. Software
2. Any product on which the serial number has been defaced, modified or removed.
3. Damage, deterioration or malfunction resulting from:
 - a. Accident, misuse, neglect, fire, water, lightning, or other acts of nature, unauthorized product modification, or failure to follow instructions supplied with the product.
 - b. Repair or attempted repair by anyone not authorized by ViewSonic.
 - c. Damage to or loss of any programs, data or removable storage media.
 - d. Software or data loss occurring during repair or replacement.
 - e. Any damage of the product due to shipment.
 - f. Removal or installation of the product.
 - g. Causes external to the product, such as electrical power fluctuations or failure.
 - h. Use of supplies or parts not meeting ViewSonic's specifications.
 - i. Normal wear and tear.
 - j. Any other cause which does not relate to a product defect.
4. Removal, installation, and set-up service charges.

How to get service:

1. For information about receiving service under warranty, contact ViewSonic Customer Support. You will need to provide your product's serial number.
2. To obtain service under warranty, you will be required to provide (a) the original dated sales slip, (b) your name, (c) your address, (d) a description of the problem, and (e) the serial number of the product.
3. Take or ship the product freight prepaid in the original container to an authorized ViewSonic service center or ViewSonic.
4. For additional information or the name of the nearest ViewSonic service center, contact ViewSonic.

Limitation of implied warranties:

THERE ARE NO WARRANTIES, EXPRESS OR IMPLIED, WHICH EXTEND BEYOND THE DESCRIPTION CONTAINED HEREIN INCLUDING THE IMPLIED WARRANTY OF MERCHANTABILITY AND FITNESS FOR A PARTICULAR PURPOSE.

Exclusion of damages:

VIEWSONIC'S LIABILITY IS LIMITED TO THE COST OF REPAIR OR REPLACEMENT OF THE PRODUCT. VIEWSONIC SHALL NOT BE LIABLE FOR:

1. DAMAGE TO OTHER PROPERTY CAUSED BY ANY DEFECTS IN THE PRODUCT, DAMAGES BASED UPON INCONVENIENCE, LOSS OF USE OF THE PRODUCT, LOSS OF DATA, LOSS OF TIME, LOSS OF PROFITS, LOSS OF BUSINESS OPPORTUNITY, LOSS OF GOODWILL, INTERFERENCE WITH BUSINESS RELATIONSHIPS, OR OTHER COMMERCIAL LOSS, EVEN IF ADVISED OF THE POSSIBILITY OF SUCH DAMAGES.
2. ANY OTHER DAMAGES, WHETHER INCIDENTAL, CONSEQUENTIAL OR OTHERWISE.
3. ANY CLAIM AGAINST THE CUSTOMER BY ANY OTHER PARTY.

Effect of state law:

This warranty gives you specific legal rights, and you may also have other rights which vary from state to state. Some states do not allow limitations on implied warranties and/or do not allow the exclusion of incidental or consequential damages, so the above limitations and exclusions may not apply to you.

Sales outside the U.S.A. and Canada:

For warranty information and service on ViewSonic products sold outside of the U.S.A. and Canada, contact ViewSonic or your local ViewSonic dealer.

* **For Europe:** This Limited Warranty is effective in Europe for two (2) years for all parts (except software) and two (2) years for all labor from the date of the first consumer purchase.

ViewSonic Rugged Handheld Warranty (V1.0)

Release Date: February 4, 2005

ViewSonic®