

# VIVIX-S 1012N User Manual



CE 0434

© Vieworks. 2015 All rights reserved.

Under copyright laws, this manual should not be reproduced, in whole or in part, without the written permission of Vieworks.

## Contents

<b>1. Instruction .....</b>	<b>8</b>
<b>1.1 Document Guide .....</b>	<b>9</b>
1.1.1 Caution Information .....	9
1.1.2 Target.....	9
1.1.3 Symbols.....	9
1.1.4 Notations.....	10
1.1.5 Contact Department.....	10
<b>1.2 Product Use Guide .....</b>	<b>11</b>
1.2.1 Product Usage.....	11
1.2.2 Disclaimer.....	11
1.2.3 Product Disposal.....	12
1.2.4 Trademarks.....	12
<b>1.3 Safety Instruction.....</b>	<b>13</b>
1.3.1 Management and Authority.....	13
1.3.2 Power Supply.....	13
1.3.3 Handling.....	14
1.3.4 Battery Pack and Charger.....	15
1.3.5 Environment of Use.....	16
1.3.6 Problem Management.....	17
1.3.7 Maintenance and Inspection.....	17
<b>1.4 Product Usage Guide.....</b>	<b>18</b>
1.4.1 Calibration.....	18
1.4.2 Length Measurement.....	18
1.4.3 Left/Right Marker.....	18
1.4.4 Image Backup.....	18
1.4.5 Use Limitations .....	19
1.4.6 Disposal.....	19
1.4.7 Pediatric Application .....	19
1.4.8 Before Exposure.....	19
1.4.9 During Exposure.....	20
1.4.10 Operating and Storage Environment .....	20
1.4.11 Others.....	20
<b>2. Product.....</b>	<b>21</b>
<b>2.1 Overview.....</b>	<b>22</b>
2.1.1 Features.....	22
<b>2.2 Product Components.....</b>	<b>23</b>

2.2.1	Detector.....	23
2.2.2	SCU (System Control Unit).....	23
2.2.3	Battery & Charger.....	24
2.2.4	Accessories.....	25
<b>2.3</b>	<b>VIVIX-S 1012N Detector .....</b>	<b>26</b>
2.3.1	Specifications.....	26
2.3.2	Drawing Sheet.....	27
2.3.3	Functions.....	29
2.3.4	Deco Sheet.....	31
2.3.5	Wireless Communication.....	33
2.3.6	Use Environment.....	33
<b>2.4</b>	<b>SCU Basic (FXRS-02A) .....</b>	<b>34</b>
2.4.1	Specifications.....	34
2.4.2	Drawing Sheet.....	34
2.4.3	Functions.....	35
<b>2.5</b>	<b>SCU Basic (FXRS-03A) .....</b>	<b>37</b>
2.5.1	Specifications.....	37
2.5.2	Drawing Sheet.....	37
2.5.3	Functions.....	38
<b>2.6</b>	<b>SCU mini (FXRS-04A).....</b>	<b>40</b>
2.6.1	Specifications.....	40
2.6.2	Drawing Sheet.....	40
2.6.3	Functions.....	41
<b>2.7</b>	<b>Battery Pack .....</b>	<b>43</b>
2.7.1	Specifications.....	43
2.7.2	Drawing Sheet.....	43
<b>2.8</b>	<b>Battery Charger .....</b>	<b>44</b>
2.8.1	Specifications.....	44
2.8.2	Drawing Sheet.....	44
<b>2.9</b>	<b>Others.....</b>	<b>45</b>
2.9.1	X-ray Generator (Recommended Exposure Condition).....	45
2.9.2	Recommended Specifications of Workstation (PC).....	45
2.9.3	Recommended Specifications of Grid.....	45
<b>3.</b>	<b>System Configuration .....</b>	<b>46</b>
<b>3.1</b>	<b>Detector Connection Methods .....</b>	<b>47</b>
3.1.1	Wireless Connection.....	47
3.1.2	Wired Connection.....	48

<b>3.2</b>	<b>Diagram</b> .....	<b>49</b>
3.2.1	Block Diagram.....	49
3.2.2	Wiring Diagram.....	49
<b>3.3</b>	<b>System Configuration</b> .....	<b>50</b>
3.3.1	AP Mode (SCU AP Mode).....	50
3.3.2	Tether Interface Mode.....	51
3.3.3	External AP Mode.....	52
3.3.4	Detector AP Mode.....	53
3.3.5	Detector Stand-Alone Mode.....	54
<b>3.4</b>	<b>Generator Interface</b> .....	<b>55</b>
3.4.1	AED (Auto Exposure Detection) Interface.....	55
3.4.2	DR Trigger Interface.....	56
<b>3.5</b>	<b>Configuring DR Trigger Interface</b> .....	<b>57</b>
3.5.1	Trigger Interface Way.....	57
3.5.2	Packet Trigger.....	57
3.5.3	Line Trigger.....	58
3.5.4	EXT_INF Port Pin Map.....	59
3.5.5	Input / Output Circuit.....	61
<b>4.</b>	<b>Installation</b> .....	<b>62</b>
<b>4.1</b>	<b>Battery Pack</b> .....	<b>63</b>
4.1.1	How to insert a battery pack.....	63
4.1.2	How to take out a battery pack.....	64
4.1.3	How to charge a battery pack.....	65
<b>4.2</b>	<b>Product Installation</b> .....	<b>67</b>
4.2.1	Connecting Devices.....	67
4.2.2	Booting up SCU.....	70
4.2.3	Booting up the Detector.....	70
4.2.4	Checking Status LED of Detector.....	71
<b>4.3</b>	<b>Software Installation</b> .....	<b>73</b>
4.3.1	Software Classification.....	73
4.3.2	Software Installation.....	73
<b>4.4</b>	<b>Windows Environment Setting</b> .....	<b>74</b>
4.4.1	Network Configuration.....	74
4.4.2	Disabling Sleep Mode of Monitor.....	78
<b>5.</b>	<b>Setting</b> .....	<b>79</b>
<b>5.1</b>	<b>Start Setting</b> .....	<b>80</b>
5.1.1	Setup Program.....	80

5.1.2	Checking Devices.....	80
5.1.3	Getting into the Devices .....	82
<b>5.2</b>	<b>SCU Setting .....</b>	<b>83</b>
5.2.1	SCU Configuration .....	83
5.2.2	SCU Diagnosis.....	86
<b>5.3</b>	<b>Detector Setting .....</b>	<b>87</b>
5.3.1	Detector Configuration .....	87
5.3.2	Detector Power Save Function .....	90
<b>5.4</b>	<b>Changing the Wireless Setting .....</b>	<b>92</b>
5.4.1	Switching to the Detector AP Mode .....	92
5.4.2	Synchronizing the Wireless Setting.....	92
<b>6.</b>	<b>Calibration .....</b>	<b>93</b>
<b>6.1</b>	<b>Calibration Dialogue .....</b>	<b>94</b>
6.1.1	System Configuration Dialogue .....	94
6.1.2	Offset Calibration Dialogue .....	97
6.1.3	Defect Calibration Dialogue .....	98
6.1.4	Gain Calibration Dialogue .....	99
<b>6.2</b>	<b>Detector Configuration .....</b>	<b>100</b>
<b>6.3</b>	<b>Calibration Guide .....</b>	<b>102</b>
<b>6.4</b>	<b>Calibrating by Loading the Calibration Data .....</b>	<b>103</b>
6.4.1	Preparing Calibration Data.....	103
6.4.2	Loading Defect Calibration Data.....	103
6.4.3	Loading Gain Calibration Data.....	104
<b>6.5</b>	<b>Direct Calibration .....</b>	<b>105</b>
6.5.1	Preparation.....	105
6.5.2	Offset Calibration.....	105
6.5.3	Gain Calibration.....	106
6.5.4	Auto Defect Correction .....	107
6.5.5	Manual Defect Correction .....	111
<b>7.</b>	<b>Diagnosis, Inspection and Maintenance .....</b>	<b>114</b>
<b>7.1</b>	<b>Diagnosis .....</b>	<b>115</b>
7.1.1	Image Diagnosis.....	115
7.1.2	Battery Pack Diagnosis.....	117
7.1.3	Wireless Communication Diagnosis.....	118
7.1.4	Communication Speed Diagnosis.....	119
<b>7.2</b>	<b>Product Inspection.....</b>	<b>120</b>

7.2.1	Daily Inspection .....	120
7.2.2	Performance Inspection .....	120
<b>7.3</b>	<b>Cleaning and Disinfection .....</b>	<b>124</b>
<b>7.4</b>	<b>Product Initialization .....</b>	<b>125</b>
7.4.1	SCU Initialization .....	125
7.4.2	Detector Initialization .....	126
7.4.3	Wireless Initialization of Detector .....	127
<b>7.5</b>	<b>Replacing the Fuse of SCU (SCU Basic only) .....</b>	<b>128</b>
<b>8.</b>	<b>Troubleshooting .....</b>	<b>129</b>
<b>8.1</b>	<b>Trobleshooting .....</b>	<b>130</b>
8.1.1	Failed to Turn the Detector On .....	130
8.1.2	The Power Switch of SCU or Status LED is not worked .....	130
8.1.3	Communication Test is failed .....	131
8.1.4	The Active LED and Data LED of the Detector are blinking .....	131
8.1.5	Errors in Detector LED .....	132
8.1.6	Rapid Consumption of Battery .....	132
8.1.7	Battery Pack or Installation Part of Battery is Getting Hot .....	132
<b>9.</b>	<b>Regulatory Information .....</b>	<b>133</b>
<b>9.1</b>	<b>Medical Equipment Safety Standards .....</b>	<b>134</b>
9.1.1	Medical Equipment Classification .....	134
9.1.2	Product Safety Standard .....	134
<b>9.2</b>	<b>Radio Frequency Compliance Information .....</b>	<b>136</b>
9.2.1	FCC Compliance .....	136
9.2.2	FCC SAR .....	137
9.2.3	CE R&TTE SAR .....	137
<b>9.3</b>	<b>Labels and Symbols .....</b>	<b>138</b>
9.3.1	Label .....	138
9.3.2	Product Serial Number .....	143
9.3.3	Product Symbols .....	144
<b>9.4</b>	<b>Guidance and Manufacturer's Declaration for EMC .....</b>	<b>145</b>
9.4.1	Electromagnetic Emissions .....	145
9.4.2	Electromagnetic Immunity .....	145
<b>10.</b>	<b>Information .....</b>	<b>148</b>
<b>10.1</b>	<b>Service Information .....</b>	<b>149</b>
10.1.1	Product Lifetime .....	149
10.1.2	Regular Inspection and Maintenance .....	149

10.1.3 Repair .....149

10.1.4 Replacement Parts Support.....149

10.1.5 Consumables.....149

**10.2 Warranty.....150**

**10.3 Revision History.....151**

DRAFT

---

# 1. Instruction

---

This section gives basic information of this manual and products with the safety guide.

Document Guide  
Product Use Guide  
Safety Instruction  
Product Operation Guide

DRAFT



## 1.1 Document Guide

This User Manual explains how to use the **VIVIX-S 1012N** detector made by Vieworks, X-ray interface unit, and other peripheral equipment. With this user manual, you can install, set and manage the **VIVIX-S 1012N** wired/wireless detectors as well as use its various functions.

### 1.1.1 Caution Information

**If the user is not fully acquainted with this manual, the product can be malfunctioned or unsuspected problem can be happened due to carelessness. To prevent any medical accidents, the user should fully understand the instructions of this manual before operating this product.**

### 1.1.2 Target

This manual is intended for service engineers who install and set the **VIVIX-S 1012N** detector.

### 1.1.3 Symbols

This product should be operated under the safety instructions with the warning or caution symbol in this manual. It is important for you to read and understand the contents with the following symbol for operating the products safely.

#### Caution and Warning Symbol



- This symbol is used to indicate a potentially hazardous situation which may cause death, personal injury or substantial property damage if the instructions are ignored. Be sure to understand the instructions of this symbol for the safe operation.

#### Information Symbol



- This symbol is used to indicate reference and complementary information related to the product. Users should read the instructions of this symbol carefully.

#### Symbol for Change



- This symbol is indicated in the cases below.
  - Items under consideration for adding, deleting or revising contents.
  - Items ready to review for the expected product change.
  - Items need a final review and approval.
  - Items which need to improve sentences or images.

### 1.1.4 Notations

#### Bold Types

We applied bold font style to the words which indicated products terms, or the words and sentences which are needed to transmit clear meaning to the customers. This helps you to easily distinguish the words from other technical ones for explaining functions.

### 1.1.5 Contact Department

For any comments or inquiries regarding this document, contact via email below.

Item	Contents
Department	Technical Support Division in Vieworks
E-mail	<a href="mailto:techsupport@vieworks.com">techsupport@vieworks.com</a>

## 1.2 Product Use Guide

This chapter provides instructions about the use of product and disposal as well as the liability limit of Vieworks.

### 1.2.1 Product Usage

- 1 Only a physician or a legally certified operator should use this product.
- 2 The equipment should be kept in a safe and operable condition by maintenance personnel.
- 3 Observe the contents written in this user manual when installing and using this product.
- 4 Use only specifications of computers and image display monitors recommended by this user manual.
- 5 Use only the dedicated cables provided with this product.
- 6 For details about installing and using this product, consult your sales representative or a distributor.

### 1.2.2 Disclaimer

- 1 In no event shall Vieworks be liable for damage or loss arising from a fire, earthquake, any intentional or negligent action by users.
- 2 In no event shall Vieworks be liable for damage or loss arising from any trial usage, or other usage under abnormal conditions.
- 3 In no event shall Vieworks be liable for personal physical harm or property damage that is sustained when the instructions of this manual are not followed.
- 4 In no event shall Vieworks be liable for direct or indirect consequential damages arising from the use of this product.
- 5 In no event shall Vieworks be liable for any damage arising from moving, alteration, inspection or repair by a person other than authorized service engineers.
- 6 In no event shall Vieworks be liable for loss of image data for any reason.
- 7 Roentgenography, image processing, image reading, and image data storage must be performed in accordance with the laws of the country or region in which the product is being used.
- 8 The user is responsible for maintaining the privacy of image data acquired from this product.
- 9 It is the responsibility of the attending physicians to provide medical care services. Vieworks will not be liable for faulty diagnoses.
- 10 Specifications, composition, and appearance of this product may change without prior notice.

### 1.2.3 Product Disposal

Disposal of this product in an unlawful manner may have a negative impact on human health and the environment. When disposing this product, therefore, be absolutely sure to follow the procedure which is in conformity with the laws and regulations applicable in your area.

#### European Union (and EEA\*) only



This symbol indicates that this product is not to be disposed with your household waste, according to the WEEE Directive (2002/96/EC) and your national law.

This product should be handed over to a designated collection point, e.g., on an authorized one-for-one basis when you buy a new similar product or to an authorized collection site for recycling electrical and electronic equipment (EEE). Improper handling of this type of waste



could have a negative impact on the environment and human health due to potentially hazardous substances that are generally associated with EEE. At the same time, your cooperation in the correct disposal of this product will contribute to the effective usage of natural resources. For more information on where you can drop off your waste equipment for recycling, please contact your local city office, waste authority, approved WEEE scheme, or your household waste disposal service.

\*EEA: Norway, Iceland, and Liechtenstein

### 1.2.4 Trademarks

The name "Vieworks" and Vieworks logo are registered trademarks of Vieworks.

© Vieworks. 2014 All rights reserved.

The copyright of this document is owned by Vieworks. Under copyright laws, this document cannot be reproduced, in whole or in part, without the written permission of Vieworks.

## 1.3 Safety Instruction

This product is designed and manufactured to ensure maximum safety of operation and to meet all the safety requirements applicable to electronic medical equipment. Follow these safeguards while using the products. If not, severe personal injury or substantial property damage can be happened. It is important for you to read and understand the contents of this manual before attempting to use the product.

### 1.3.1 Management and Authority



- The product should be installed, operated, and serviced according to Vieworks maintenance procedures and by personnel from Vieworks or distributor who providing purchase of the Vieworks' product.
- Operation and maintenance should be done in strict compliance with the operation instructions contained in the manual.
- The system, in whole or in part, cannot be modified in any way without prior approval from Vieworks.
- Before authorizing any person to operate the system, verify that the person has read and fully understood the User Manual. The owner should make certain that only properly trained and fully qualified personnel are authorized to operate the equipment. An authorized operators list should be made and maintained.
- It is important that this User Manual be kept at hand, studied carefully, and reviewed periodically by the authorized operators.
- If a malfunction occurs, do not use this device until qualified personnel correct the problem.

### 1.3.2 Power Supply



- Do not operate the equipment using any type of power supply other than the one indicated on the rating label. Otherwise, it may result in a fire or electric shock.
- Do not supply power to more than one piece of equipment using the same AC outlet for this product. Doing so may result in a fire or electric shock.
- Do not connect a multiple portable socket-outlet or extension cord to the system. Doing so may result in a fire or electric shock.
- Always connect the three-core power cord plug to a grounded AC power outlet.
- Be sure to ground the equipment to an indoor grounded connector. Also, be sure to connect all the grounds for the system to a common ground.
- Do not use any power source other than the one provided with this product. Otherwise, a fire or electric shock may be caused due to a leakage.
- The owner should ensure continuous power supply to the system with voltage and current according to the product specifications. If the system is powered unstably during its operation, we recommend you to install UPS (Uninterrupted Power Supply) to avoid loss of data.

- To make it easy to disconnect the plug at any time, avoid putting any obstacles near the outlet. Otherwise, it may not be possible to disconnect the plug in an emergency.
- Do not place a heavy object such as medical equipment on cables and cords, and do not pull, bend, bundle, or step on them. Doing so may damage their sheath. If you alter them, it may damage the cords which could result in a fire or electric shock.
- Securely plug the power cord into the AC outlet. If contact failure occurs, or if dust/metal objects come into contact with the exposed metal prongs of the plug, fire or electric shock may result.
- Be sure to turn OFF the power to each piece of equipment before connecting or disconnecting the cords. Otherwise, you may get an electric shock that could result in death or serious injury.
- Be sure to hold the plug or connector to disconnect the cord. If you pull the cord, the core wire may be damaged, resulting in a fire or electric shock.
- Do not handle the product with wet hands. You may experience an electric shock that could result in death or serious injury.

### 1.3.3 Handling

- Never disassemble or modify the equipment. Doing so may result in a fire or electric shock. Also, since the equipment incorporates parts that may cause an electric shock as well as other hazardous parts, touching them may cause death or serious injury.
- Do not connect any equipment which is not specified in this User Manual.
- Do not place anything on surface of the equipment. The object may fall and cause an injury. Also, if metal objects such as needles or clips fall into the equipment, or if liquid is spilled, it may result in a fire or electric shock.
- Do not hit or drop the equipment. It may be damaged if receiving a strong jolt. If the equipment is used without being repaired, it may result in a fire or electric shock.
- Do not place excessive weight on the detector. The internal image sensor may be damaged and it can affect to the image quality.
- Have the patient take a fixed posture and do not let him or her touch parts unnecessarily. If the patient touches connectors or switches, it may result in electric shock or malfunction of the equipment.
- Do not spill liquid or chemicals onto the detector. In cases where the patient is injured, protect the equipment with a disposable covering not allow to come in contact with blood or other body fluids. Otherwise, it may result in a fire or electric shock.
- For safety reasons, be sure to turn OFF the power of the equipment when the inspections indicated in this manual are going to be performed.
- Do not submerge the detector in water.
- Be sure to use the detector on a flat surface so it will not bend. Otherwise, the internal image sensor may be damaged. Be sure to securely hold the detector while using it in upright positions.
- Because the equipment cable is long, take care that cables do not become tangled during use. Also, be careful not to get your feet caught in the cable. It may cause a malfunction of the equipment or injury to the user from tripping over the cable.



- Do not block the ventilation ports of **SCU** to prevent overheating. Overheating can cause product's malfunctions and damages.

### 1.3.4 Battery Pack and Charger

- Do not use the battery pack as a power source for equipment other than **VIVIX-S 1012N** detector. Be sure to use only the dedicated battery pack for the **VIVIX-S 1012N** detector.
- The battery charger is designed for the dedicated battery pack. Do not use the battery charger other than the dedicated one. Otherwise, a battery explosion or a battery leak may occur, resulting in fire or electrical shock.
- Do not operate the battery charger using any type of power supply other than the one indicated on the rating label.
- Do not handle the product with wet hands.
- Do not attempt to disassemble, alter, or apply heat to the product.
- Avoid dropping or subjecting the product to severe impacts. To avoid the risk of injury, do not touch the internal parts of the battery if it has been cracked.
- Stop using the battery pack immediately if it emits smoke, a strange smell, or otherwise behaves abnormally.
- Do not let the battery pack and battery charger come into contact with water or other liquids and do not allow them to get wet.
- Do not clean with substances containing organic solvents such as alcohol, benzene, thinner, or other chemicals. Otherwise, fire or electrical shock may result.
- Do not allow dirt or metal objects (such as hair pins, clips, staples or keys) to contact the terminals. Otherwise, battery explosion or leakage of electrolyte may occur, resulting in fire, injury or pollution of surrounding area. If the battery leaks and the electrolytes come into contact with your eyes, mouth, skin or clothing, immediately wash it away with running water and seek medical attention.
- Do not leave, store, or place the product in a location near heat sources, or in a place subject to direct sunlight, high temperature, high humidity, excessive dust, or mechanical shock. Otherwise, battery leakage, overheating or damage to the product may occur, resulting in electrical shock, burns, injury or fire.
- Do not attempt to use a battery pack that has deteriorated. Using a battery pack that has exceeded its life cycle may lead to overheating, fire or explosion.
- The Lithium ion battery is recyclable.
- Battery slowly discharges even if not in use.
- The battery pack may have expired if it discharges immediately after being fully charged. You can purchase an optional battery pack to replace an exhausted one.
- The battery pack is a consumable item. If a fully charged battery is consumed quickly, use a new and fully charged battery pack.
- Be sure to charge the battery periodically (once a year) if it is not used for an extended period of time. The battery pack cannot be charged if it has been over discharged.
- Before discarding the battery pack, cover the terminals with adhesive tape or other insulators. Contact with other metal materials may cause fire or explosion.



### 1.3.5 Environment of Use

- Do not install the equipment in any of the locations listed below. Doing so may result in failure or malfunction, equipment falling, fire, or injury.
  - Close to facilities where water is used.
  - Where it will be exposed to direct sunlight
  - Close to the air outlet of an air-conditioner or ventilation equipment
  - Nearby the electric heating appliance such as a heater
  - Where the power supply is unstable
  - In a dusty environment
  - In a saline or sulfurous environment
  - Where temperature or humidity is higher than the operating temperature
  - Where there is freezing or condensation
  - In areas prone to vibration
  - On an incline or in an unstable area
- This product may malfunction due to electromagnetic interference (EMI) caused by telecommunication devices, transceivers, electronic devices, etc. To prevent the electromagnetic wave from badly influencing the product, be sure to avoid placing it in close proximity to the product. Or, change direction or position of the product or move into the shielded place to reduce electromagnetic interference.
- This equipment is not suitable for use in the presence of a flammable anesthetic mixture with air or with oxygen or nitrous oxide.
- Conductive fluids that drain into the active circuit components of the system may cause short circuits that can result in electrical fire. Therefore, do not place fluids or food on any part of the system.
- To avoid electric shocks and burns caused by use of the wrong type of fire extinguisher, make sure that the fire extinguisher at the site has been approved for use on electrical fires.
- The battery charger and **SCU** (System Control Unit) cannot be used in patient's vicinity.

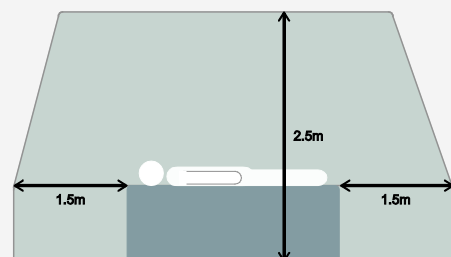
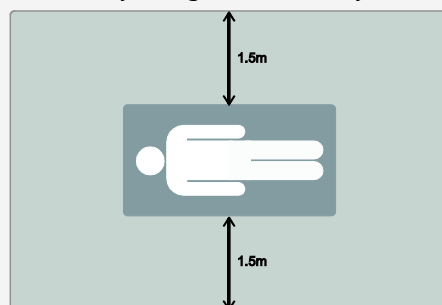



### 1.3.6 Problem Management



- Should any of the following occur, immediately turn OFF the power to each piece of equipment, unplug the power cord from the AC outlet, and contact sales representative or distributor.
  - When there is smoke, an odd smell or abnormal sound no period.
  - When liquid is spilled into the equipment or a metal object is entered through an opening.
  - When the equipment has been dropped and is damaged.

### 1.3.7 Maintenance and Inspection



- Do not use or store the equipment near flammable chemicals such as acetone, benzene, thinner, etc. If chemicals are spilled or evaporated, it may result in a fire or electric shock through contact with electric parts inside the equipment.
- If any flammable cleaning agent is used for the product, be sure to take care when using them.
- When the equipment is going to be cleaned, be sure to turn OFF the power of the equipment and unplug the power cord from the AC outlet. Never use thinner, acetone, benzene or any other flammable cleaning agent. Otherwise, it may result in a fire or electric shock.
- Clean the plug of the power cord periodically by unplugging it from the AC outlet and removing dust or dirt from the plug, its periphery, and AC outlet with a dry cloth. If the cord is kept plugged in for a long time in a dusty, humid or sooty place, dust around the plug will attract moisture, and this could cause insulation failure that could result in a fire.
- Be sure to turn OFF the power of the equipment while cleaning. Otherwise, a fire or electric shock may occur.

## 1.4 Product Usage Guide



- When using the equipment, take the following precautions. Otherwise, problems may occur and the equipment may not function correctly.

### 1.4.1 Calibration

- To ensure optimal system performance, it is important to verify that the system is calibrated correctly.
- Check if the calibration is performed after the equipment is completed to be installed or repaired.
- Do not try to use the system if the calibration has not been performed.
- You can process calibration with the calibration data CD (provided).



- The calibration result can be different by the use environment. Therefore, if the result with the provided calibration data is not satisfied, you can create the data at the field in person by using **VIVIX Setup**, the calibration software.

### 1.4.2 Length Measurement

- Before taking any length measurement on an image, carry out the length calibration with a reference object and verify its results for correct measurement.

### 1.4.3 Left/Right Marker

- The operator is responsible for making a correct and clear mark on the left or right side of the image.
- The software includes a function to mark the image with **L** (left) or **R** (right) while acquiring the image through printing and archiving.
- Prepare an alternative way to prevent any confusion if the operator does not choose to use **L/R** marks.

### 1.4.4 Image Backup

- To avoid missing images which might result in a patient being exposed to additional dose of radiation, it is important to send images to PACS or backup images by using film or external storage media (CD, DVD, HDD, USB).
- If the hard disk of your workstation is about to be full, the operator should backup images to somewhere else and delete them to make storage (memory) space in the hard disk for new patients.



- The image backup should be done as a routine operation for every patient and image.

### 1.4.5 Use Limitations

- Vieworks software has the engineer mode operated by inputting the administrator password only.
- This mode should be operated by the person who is qualified by Vieworks.

### 1.4.6 Disposal

- Disposal of this product in an unlawful manner may have negative effects on human health and the environment.
- Be sure to follow the procedure which is in conformity with the laws and regulations applicable in your area.

### 1.4.7 Pediatric Application

- Every request should be reviewed by a pediatric radiologist prior to beginning the examination to ensure that an appropriate study is being performed.
- If the technologist notices an unusual request, he or she must contact a radiologist in charge. Examples include orders- a Full Cervical, Thoracic, and Lumbar Spine series. The pediatric radiologist should contact the ordering physician and decide which study is best for the pediatric patient.
- The technologist should use a proper technique considering the patient's size to decrease the radiation dose when he or she acquires diagnostic images.
- ALL pediatric patients shall be shielded for their X-ray examinations, except for when the shield will obscure the region of interest, as in a pelvic or SI joint X-ray for trauma or arthritis, or when it is physically or clinically unreasonable to shield the patient.
- For routine Hip X-Rays, ALL male children shall have their scrotum shielded using the small gonadal shield while females may not be shielded because doing so would obscure the hips.
- To minimize motion in infants and young children, swaddle the infant. Use distraction tools to improve cooperation and projectors with child-friendly themes, music, toys with flashing lights or music, child-friendly images on the ceiling or walls, singing, counting, and a parent reading and talking to the child through the console all can help reduce anxiety and comfort the child.
- A scoliosis series will consist of a single frontal standing view of the spine. No lateral view or supine view is needed, unless specifically asked for by the Orthopedist or Radiologist. If the female's breasts can be shielded without obscuring the spine, breast shields should be used.

### 1.4.8 Before Exposure

- Be sure to check the equipment daily and confirm that it works properly.
- Sudden heating of the room in cold areas will cause condensation to form on the equipment. In this case, wait until the condensation evaporates before performing an exposure. If the equipment is used while condensation is formed in it, problems may occur in the quality of captured images.
- When an air-conditioner is used, be sure to raise/lower the temperature gradually so that difference between the temperature in the room and in the equipment does not occur, to prevent condensation.

### 1.4.9 During Exposure

- This equipment is not protected (sealed) against liquids such as blood and medicine in the operating room. If necessary, wrap the equipment in a disposable cover when using it.
- Do not use the selected frequency channel (2.4 GHz and 5 GHz dual band) for other wireless devices. Mutual interference may affect the image data transmission rate.
- Do not use the detector near devices generating a strong magnetic field. Doing so may produce image noise or artifacts.

### 1.4.10 Operating and Storage Environment

- This equipment is mainly used in the X-ray exposure room and hospital wards. To use it in other places, consult Viewworks' sales representative or a distributor.
- Do not expose this equipment to high temperatures and/or high humidity. Malfunctions may occur.
- When not in use, keep the products in a safe location.
- Be sure to use and store this equipment under the conditions described below.

Classification	Temperature	Humidity (Non-condensing)	Atmosphere
<b>Operating Environment</b>	+10 ~ +35°C	30 ~ 85%	700 ~ 1060 hPa
<b>Storage Environment</b>	-15 ~ +55°C	10 ~ 90%	500 ~ 1060 hPa

### 1.4.11 Others

- Do not use this equipment in combination with peripherals such as defibrillators or large electric motors as these may cause power-supply noise or power supply voltage variations. Doing so may prevent normal operation of this equipment and peripherals.

---

## 2. Product

---

This section gives an instruction about the product components and their specifications.

Overview

Product Components

VIVIX-S 1012N Detector

SCU

Battery Pack

Battery Charger

Others

## 2.1 Overview

**VIVIX-S 1012N** detector is the digital X-ray imaging solution. It acquires images by exposing X-ray which has been penetrated the human body. When X-ray photons pass through scintillator in the detector, the photons convert to visible ray, and the visible ray is converted to electronic signals through TFT (a-Si). Then the detector digitalizes x-ray images and transfers them to the computer (workstation) for radiography diagnostics. Users can perform image diagnosis easily through the image display monitor with this process. Advanced digital image processing also allows considerably efficient diagnosis, all kinds of information management, and sharing of image information on network.





- This detector is used for the general-purpose diagnostic procedures, and it is intended to replace radiographic film / screen systems.
- This detector is not intended for mammography applications.

### 2.1.1 Features





- Since **VIVIX-S 1012N** detector is compatible with a conventional film cassette, it enables to replace the analog radiographic diagnosis (Supporting ISO4090 standard).
- The new sensor with 124 $\mu$ m pixel pitch produces high spatial resolution (approx. 5.2 Mega pixels) digital images.
- Various applications such as neonatal, ENT, equine and cephalo
- Choose between two scintillator types (CsI and Gadox) of detector provided by Vieworks.
- The built-in wireless communication supports **IEEE 802.11n** to acquire images without a wired connection in anytime, anywhere.
- Make direct wireless communication with the built-in wireless AP function. (Inside AP™)
- Supports the stable and reliable AED (Auto Exposure Detection) function. (Anytime™)
- Designed as lightweight and thin with portability to allow easy exposure in anytime, anywhere.
- Used in various ways for infant / animals and in the dental clinic / ENT, etc.

## 2.2 Product Components

### 2.2.1 Detector

Component		Description
<p>VIVIX-S 1012N Wireless Detector</p>		<ul style="list-style-type: none"> <li>• FXRD-1012NAW (2.2kg)</li> <li>• FXRD-1012NBW (2.2kg)</li> </ul>
<p>VIVIX-S 1012N Wired Detector</p>		<ul style="list-style-type: none"> <li>• FXRD-1012NA (2.2kg)</li> <li>• FXRD-1012NB (2.2kg)</li> </ul>
	<ul style="list-style-type: none"> <li>• A deco sheet attached on the detector can be different depending on each client company.</li> </ul>	

### 2.2.2 SCU (System Control Unit)

Component		Description
<p>SCU Basic (FXRS-02A)</p>		<ul style="list-style-type: none"> <li>• FXRS-02A (2.5kg)</li> </ul>
		<ul style="list-style-type: none"> <li>• AC Power Cable (2m)</li> </ul>
<p>SCU Basic (FXRS-03A)</p>		<ul style="list-style-type: none"> <li>• FXRS-03A (2.8kg)</li> </ul>
		<ul style="list-style-type: none"> <li>• AC Power Cable (2m)</li> </ul>



- FXRS-04A (1.2kg)

SCU mini  
(FXRS-04A)



- DC Power Supply (24V)





- AC Power Cable (2m)







• You can choose the type of SCU depending on the purpose of use.

### 2.2.3 Battery & Charger

Component	Description
Battery	 <ul style="list-style-type: none"> <li>• FXRB-03A (0.12kg, 2EA)</li> </ul>
Charger	 <ul style="list-style-type: none"> <li>• FXRC-02A (0.8kg)</li> </ul>
	 <ul style="list-style-type: none"> <li>• DC Power Supply (24V)</li> </ul>



### 2.2.4 Accessories

Component	Description
Resource	 <ul style="list-style-type: none"> <li>• Software (Viewer or SDK)</li> <li>• Manuals</li> </ul>
Cables	 <ul style="list-style-type: none"> <li>• Tether Interface Cable (7m)</li> </ul>
	 <ul style="list-style-type: none"> <li>• Ether Con Cable (7m, Option)</li> </ul>
	 <ul style="list-style-type: none"> <li>• Generator Interface Cable (7m)</li> </ul>
	 <ul style="list-style-type: none"> <li>• UTP LAN Cable (15m, Direct)                             <ul style="list-style-type: none"> <li>▫ CAT 5E or CAT6</li> </ul> </li> </ul>



- The use of accessories and cables other than those approved and sold by Viewworks Co., Ltd. may result in increased release of electromagnetic waves or decreased stability of the equipment.
- Accessory equipment connected to the analog and digital interfaces must be certified according to the respective IEC standards. All combinations of equipment must be in compliance with **IEC 60601-1-1** system requirements.
- Any person who connects additional equipment to the signal input or signal output ports configures a medical system, and is therefore responsible for ensuring that the system complies with the requirements of the system standard **IEC 60601-1**.
- Consult your sales distributor or manufacturer if you have any concerns.

## 2.3 VIVIX-S 1012N Detector

VIVIX-S 1012N is designed to acquire digital images by collecting x-ray signals and several conversion processes. You can use the acquired image (10" x 12" film size) diversely depending on the purpose of use.



- VIVIX-S 1012N is one of the VIVIX detector models produced by Vieworks.

### 2.3.1 Specifications

Item	Specifications
<b>Model</b>	<ul style="list-style-type: none"> <li>• FXRD-1012NA (CsI)</li> <li>• FXRD-1012NB (Gadox)</li> <li>• FXRD-1012NAW (CsI)</li> <li>• FXRD-1012NBW (Gadox)</li> </ul>
<b>Image Sensor</b>	<ul style="list-style-type: none"> <li>• TFT: a-Si (Amorphous Silicon)</li> </ul>
<b>X-ray Scintillator Type</b>	<ul style="list-style-type: none"> <li>• FXRD-1012NA(W) : CsI: TI (Thallium doped Caesium Iodide)</li> <li>• FXRD-1012NB(W) : Gd<sub>2</sub>O<sub>2</sub>S:Tb (Gadolinium oxysulfide)</li> </ul>
<b>Pixel Pitch</b>	<ul style="list-style-type: none"> <li>• 0.124mm (124μm)</li> </ul>
<b>Field of View</b>	<ul style="list-style-type: none"> <li>• 10" x 12"</li> </ul>
<b>Active Area (H x V)</b>	<ul style="list-style-type: none"> <li>• 253.95mm x 317.44mm</li> </ul>
<b>Active Array</b>	<ul style="list-style-type: none"> <li>• 2048 x 2560 pixels</li> </ul>
<b>Effective Area</b>	<ul style="list-style-type: none"> <li>• 252.5mm x 316.0mm</li> </ul>
<b>Effective Array</b>	<ul style="list-style-type: none"> <li>• 2036 x 2548</li> </ul>
<b>Grayscale</b>	<ul style="list-style-type: none"> <li>• 16bit</li> </ul>
<b>Spatial Resolution</b>	<ul style="list-style-type: none"> <li>• Min. 4.0 lp/mm</li> </ul>
<b>Image Acquisition Time (Wired)</b>	<ul style="list-style-type: none"> <li>• 1.5 sec.</li> </ul>
<b>Image Acquisition Time (Wireless)</b>	<ul style="list-style-type: none"> <li>• 3 sec.</li> </ul>
<b>Recommended Cycle Time</b>	<ul style="list-style-type: none"> <li>• 15 sec.</li> </ul>
<b>X-ray Synchronization Control</b>	<ul style="list-style-type: none"> <li>• AED (Auto Exposure Detection)</li> <li>• DR Trigger (External line trigger)</li> </ul>
<b>Rated Power Supply</b>	<ul style="list-style-type: none"> <li>• DC +24V, Max. 0.8A</li> <li>▫ Wired: Powered by SCU with a tether interface cable.</li> <li>▫ Wireless: Powered by a battery pack (3,100 mA h)</li> </ul>
<b>Power Consumption</b>	<ul style="list-style-type: none"> <li>• Max. 19.2 W</li> </ul>
<b>Dimensions (H x W x D)</b>	<ul style="list-style-type: none"> <li>• 287.0mm x 350.0mm x 15.0mm</li> </ul>
<b>Weight (including a battery pack)</b>	<ul style="list-style-type: none"> <li>• 2.2 kg</li> </ul>
<b>Image Transfer</b>	<ul style="list-style-type: none"> <li>• Wired: Gigabit Ethernet (1000BASE-T) via PoE (Power over Ethernet)</li> <li>• Wireless: IEEE802.11n</li> </ul>
<b>Data Transmission Rate (Wired)</b>	<ul style="list-style-type: none"> <li>• Max. 1Gbps</li> </ul>
<b>Data Transmission Rate (Wireless)</b>	<ul style="list-style-type: none"> <li>• Max. 300Mbps (MIMO 2X2)</li> </ul>

### 2.3.2 Drawing Sheet

#### VIVIX-S 1012NAW / 1012NBW (Wireless Detector)

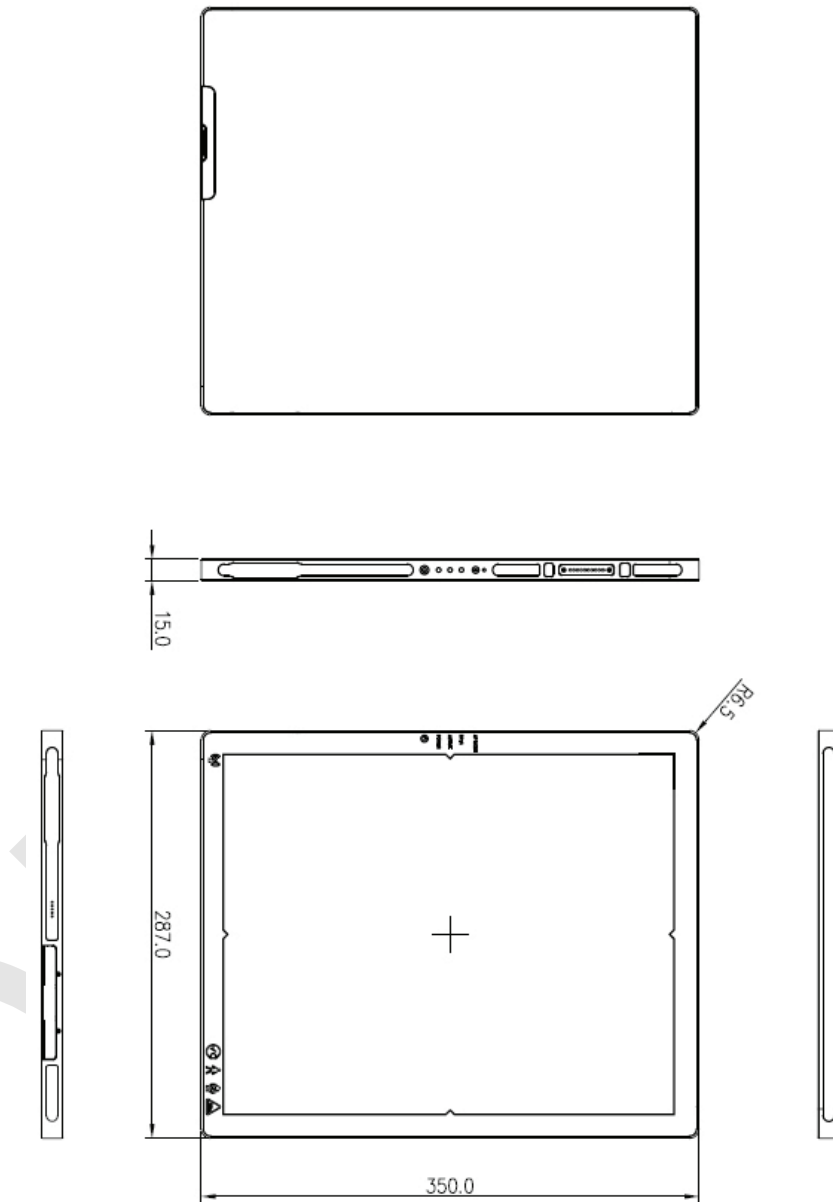

Item	Description
Dimensions (H × W × D)	287.0mm × 350.0mm × 15.0mm
Curvature of Edges	R6.5



- Under the **ISO4090** regulation, the allowed tolerance of a thickness of detector is from -2mm ~ +1mm.

VIVIX-S 1012NA / 1012NB (Wired Detector with a tether interface cable)

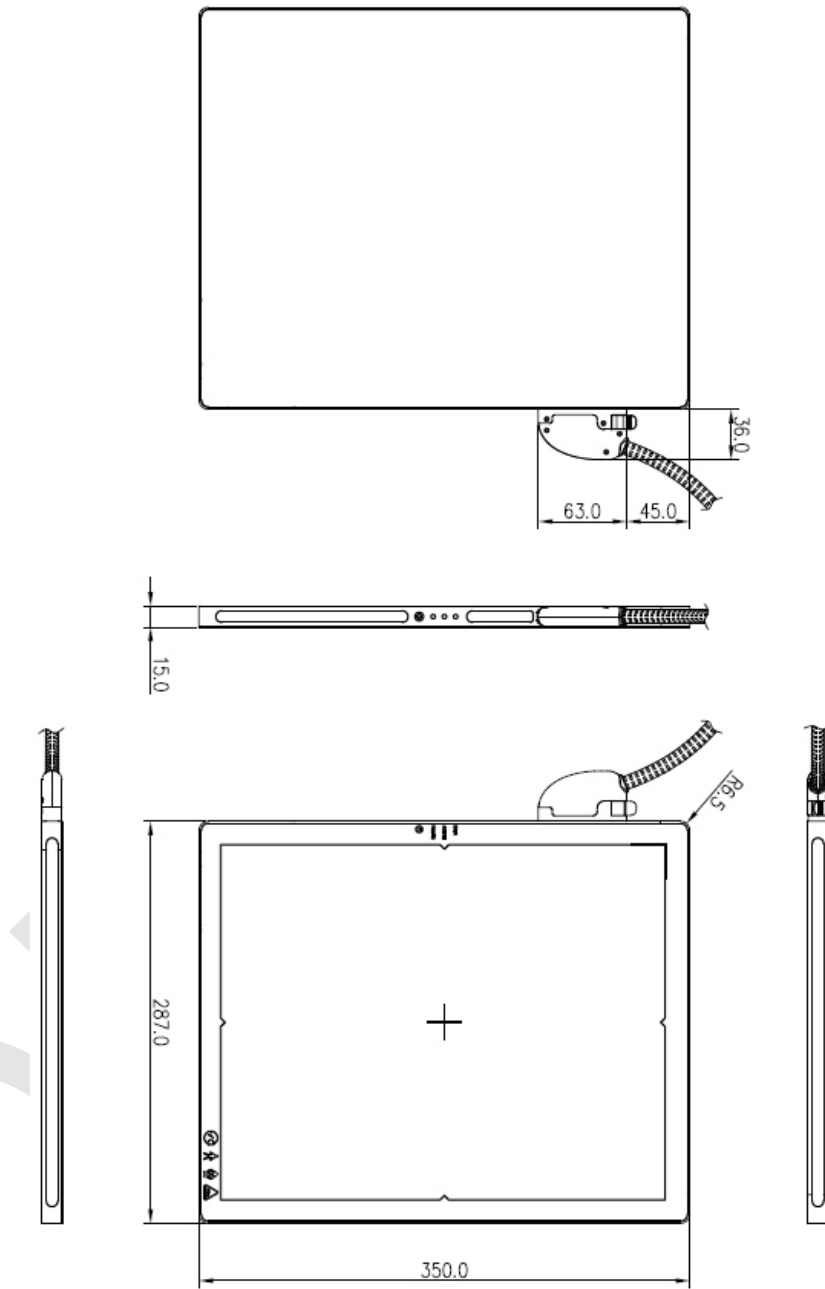

Item	Description
Dimensions (H × W × D)	287.0mm × 350.0mm × 15.0mm
Curvature of Edges	R6.5



- Under the **ISO4090** regulation, the allowed tolerance of a thickness of detector is from -2mm ~ +1mm.

### 2.3.3 Functions

#### VIVIX-S 1012NAW / 1012NBW (Wireless)

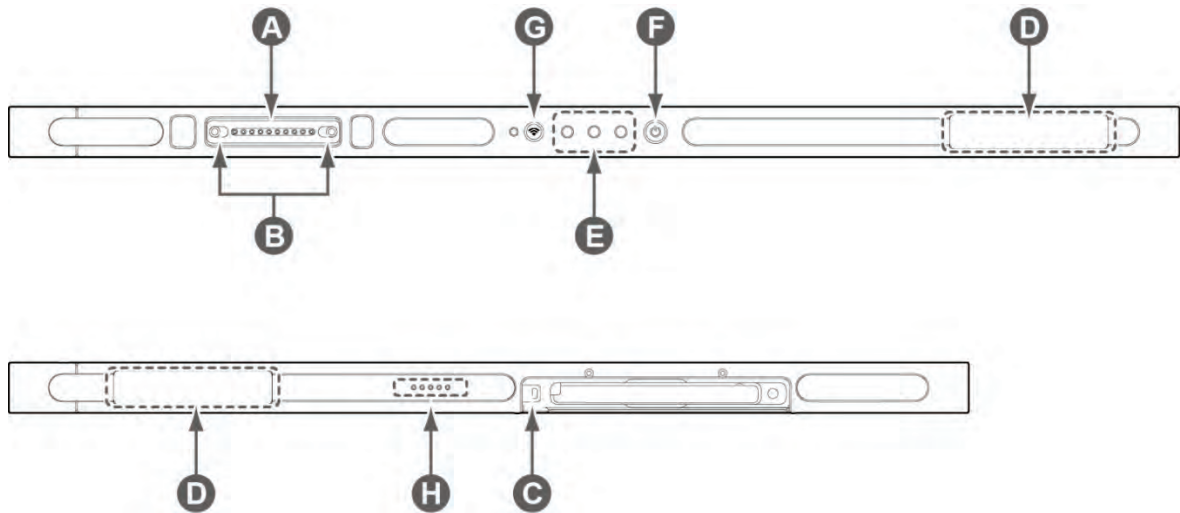

Name	Description
<b>A Tether interface connector</b>	<ul style="list-style-type: none"> <li>Used for tighten the tether interface cable.</li> <li>Used for wired connection between a detector and <b>SCU</b>.</li> </ul>
<b>B Tether interface holder</b>	<ul style="list-style-type: none"> <li>Fix/release holder of the tether interface cable.</li> </ul>
<b>C Battery lock lever</b>	<ul style="list-style-type: none"> <li>Lock/unlock lever of the equipped battery pack.</li> </ul>
<b>D Antenna for wireless LAN</b>	<ul style="list-style-type: none"> <li>Antennas for wireless communication (2EA)</li> </ul>
<b>E Status indicator</b>	<ul style="list-style-type: none"> <li>Detector status indicator                             <ul style="list-style-type: none"> <li><b>DATA LED</b> (Blue): Indicates communication and transmission</li> <li><b>ACTIVE LED</b> (Orange): Indicates ready to work</li> <li><b>POWER LED</b> (Green): Indicates power On/Off status</li> </ul> </li> </ul>
<b>F Power button</b>	<ul style="list-style-type: none"> <li>Detector power button</li> </ul>
<b>G AP ON /OFF Button</b>	<ul style="list-style-type: none"> <li>Turns on / off the AP mode.</li> </ul>
<b>H Battery Remaining LED</b>	<ul style="list-style-type: none"> <li>Notices the remaining of battery in 5 levels.</li> </ul>

## VIVIX-S 1012NA / 1012NB (Wired)

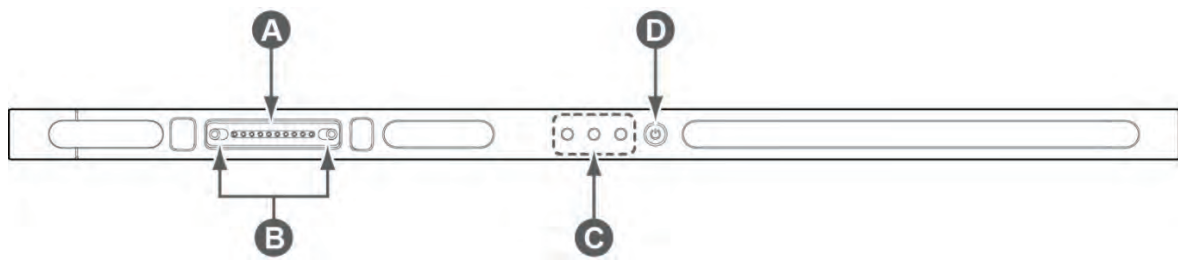

Name	Description
<b>A Tether interface connector</b>	<ul style="list-style-type: none"> <li>Used for tighten the tether interface cable.</li> <li>Used for wired connection between a detector and <b>SCU</b>.</li> </ul>
<b>B Tether interface holder</b>	<ul style="list-style-type: none"> <li>Fix/release holder of the tether interface cable.</li> </ul>
<b>C Status indicator</b>	<ul style="list-style-type: none"> <li>Detector status indicator               <ul style="list-style-type: none"> <li><b>DATA LED</b> (Blue): Indicates communication and transmission</li> <li><b>ACTIVE LED</b> (Orange): Indicates ready to work</li> <li><b>POWER LED</b> (Green): Indicates power On/Off status</li> </ul> </li> </ul>
<b>D Power button</b>	<ul style="list-style-type: none"> <li>Detector power button</li> </ul>

### 2.3.4 Deco Sheet

#### VIVIX-S 1012NAW / 1012NBW (Wireless)

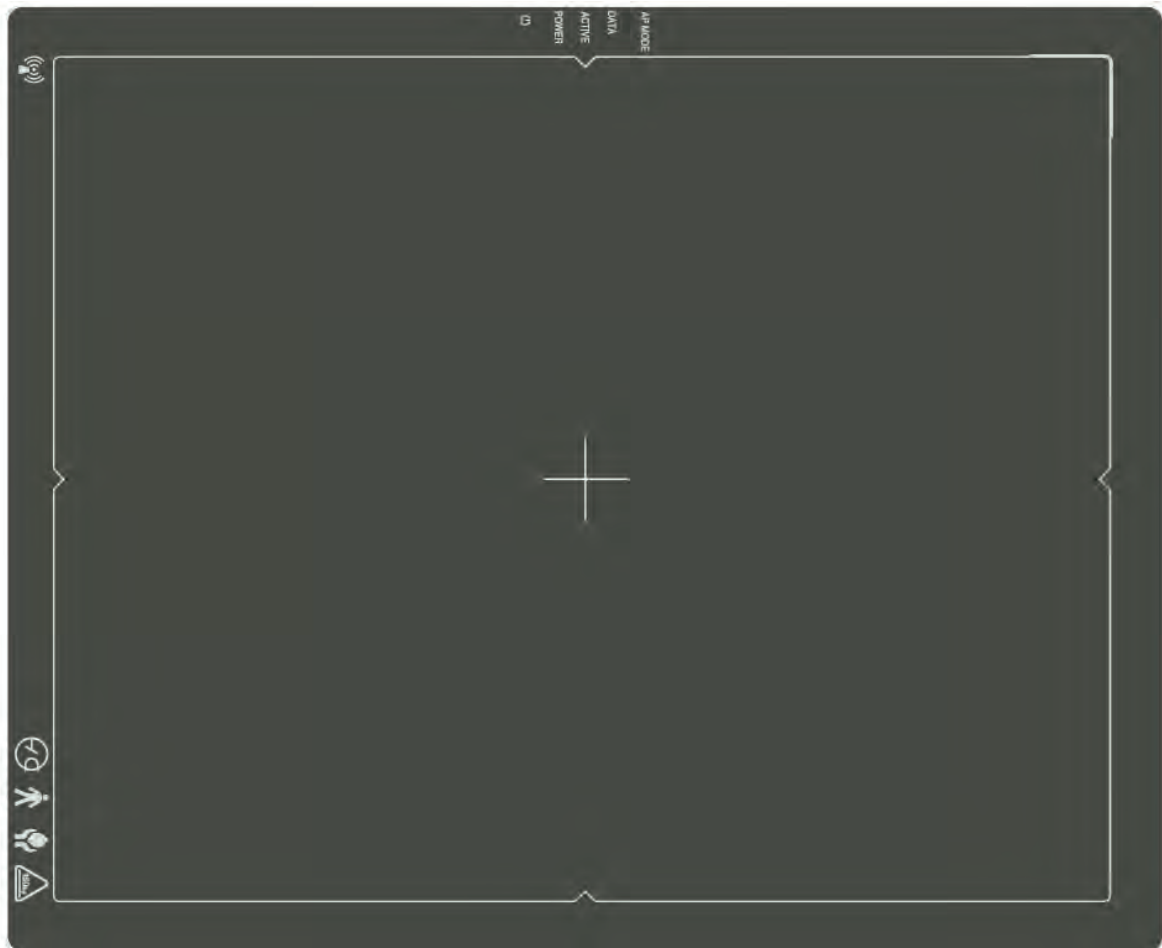

	Indication Info.	Description
A	<b>Wireless communication logo</b>	Indicates that this model can be operated wirelessly.
B	<b>Status indication logo</b>	Indicates the operating state of detector. • AP Mode, DATA, ACTIVE, POWER
C	<b>Image starting point</b>	Indicates the starting point of an original image.
D	<b>Center of the detector</b>	Indicates the central position of detector.
E	<b>Vieworks logo</b>	Indicates the logo of Vieworks.
F	<b>Certification logo</b>	Indicates the certification logos relating to a medical device.



- Image starting point (0.0) of this detector is located nearby the tether interface connector. You can change the displayed direction of an image from the **VIVIX Setup** program, but it does not mean that the starting point and direction of the original image are changed.

VIVIX-S 1012NA / 1012NB (Wired)

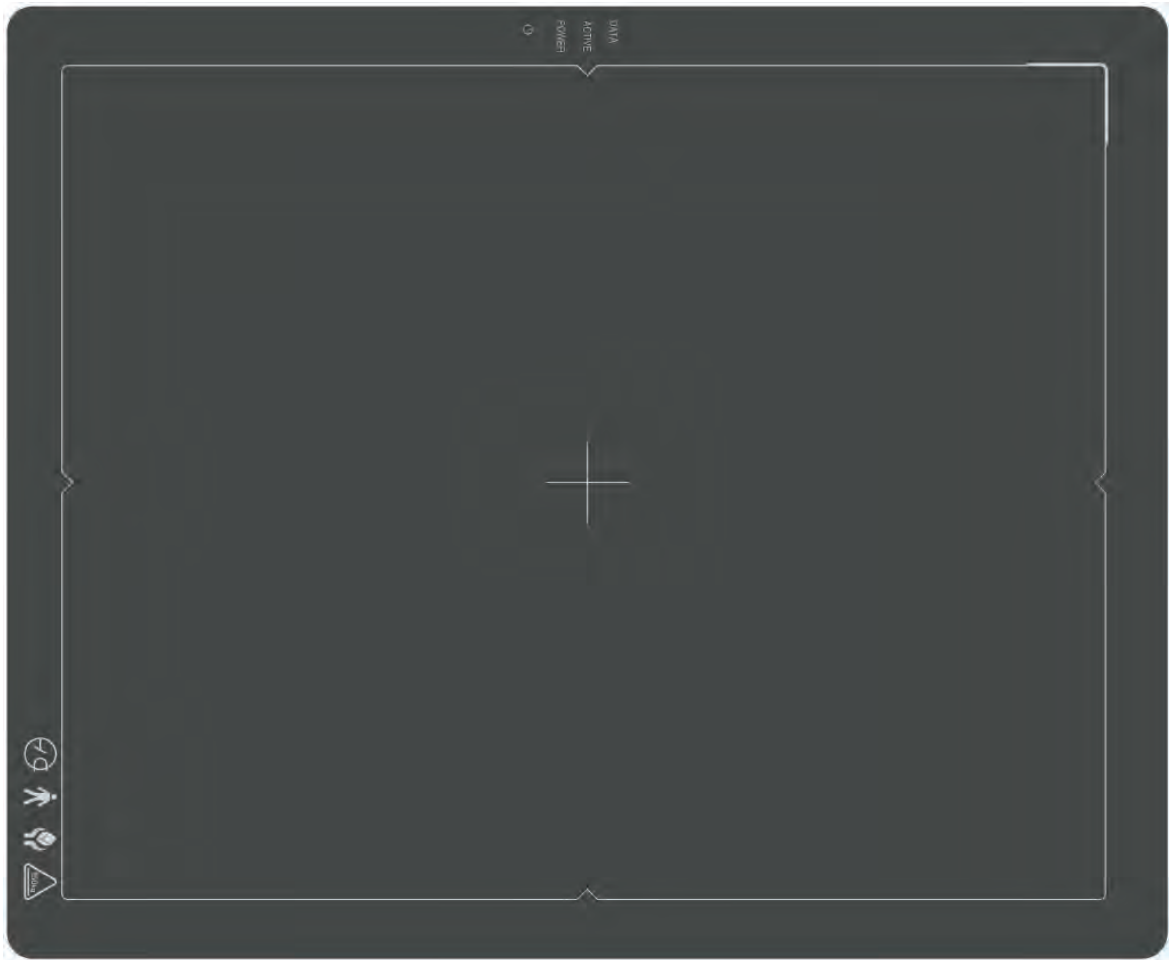

	Indication Info.	Description
A	<b>Status indication logo</b>	Indicates the operating state of detector. • DATA, ACTIVE, POWER
B	<b>Image starting point</b>	Indicates the starting point of an original image.
C	<b>Center of the detector</b>	Indicates the central position of detector.
D	<b>Vieworks logo</b>	Indicates the logo of Vieworks.
E	<b>Certification logo</b>	Indicates certification logos relating to a medical device.



### 2.3.5 Wireless Communication

Item	Specifications
Wireless standard	IEEE802.11n
Frequency range	2.412 ~ 2.472GHz (13 Channels)
	5.18 ~ 5.24GHz (4 Channels)
	5.745 ~ 5.805GHz (4 Channels)
Data transmission rate	802.11n: Max. 300Mbps (MIMO 2X2)
Modulation	BPSK, QPSK, 16-QAM, 64-QAM
Transmission power	Max. 17dBm
Security	WPA2-PSK
Antenna	Dual Band Antennas (2EA, inbuilt)



- The specification of detector and SCU are same, but the location of antenna is different.

### 2.3.6 Use Environment

Item	Operation	Storage & Transportation
Temperature	+10 ~ +35°C	-15 ~ +55°C
Humidity	30 ~ 85% (Non-condensing)	10 ~ 90% (Non-condensing)
Atmospheric pressure	700 ~ 1060 hPa	500 ~ 1060 hPa
Shock	1.6G	20G
Vibration	0.7G	0.7G



- The use environment of detector and SCU is same.

#### Load Limit of Detector

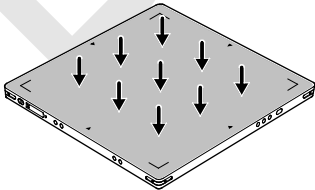
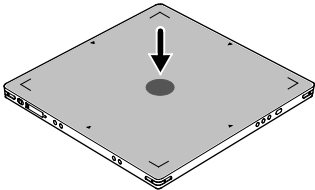
Uniform load	Local load
Over the whole surface	Center diameter 40mm
Max. 100 kg	Max. 150 kg
	



- Do not let the patient or object heavier than load limit be on the detector. Then, detector can be damaged.
- Do not let the patient lie or get on the detector. Internal devices such as a sensor can be seriously damaged even if his/her weight is within the load limit.

## 2.4 SCU Basic (FXRS-02A)

SCU synchronizes the image and X-ray signal as locating among the detector, workstation and the X-ray generator. You can use the SCU directly when the power supplies to SCU after connecting it under the VIVIX-S 1012N system environment.

### 2.4.1 Specifications

#### SCU

Item	Specifications
Model	<ul style="list-style-type: none"> <li>FXRS-02A</li> </ul>
Power Supply	<ul style="list-style-type: none"> <li>Input: AC100 to 240V, 50/60Hz, Max. 200VA</li> <li>Output: DC +24V 3.3A, 80W</li> </ul>
Cable Connection port	<ul style="list-style-type: none"> <li>Gigabit Ethernet ports (3ea)</li> <li>Two(2) PoE (Power over Ethernet) ports</li> </ul>
Dimension (H × W × D)	<ul style="list-style-type: none"> <li>210.0 mm × 300.0 mm × 54.2 mm</li> </ul>
Weight	<ul style="list-style-type: none"> <li>2.5 kg</li> </ul>

### 2.4.2 Drawing Sheet

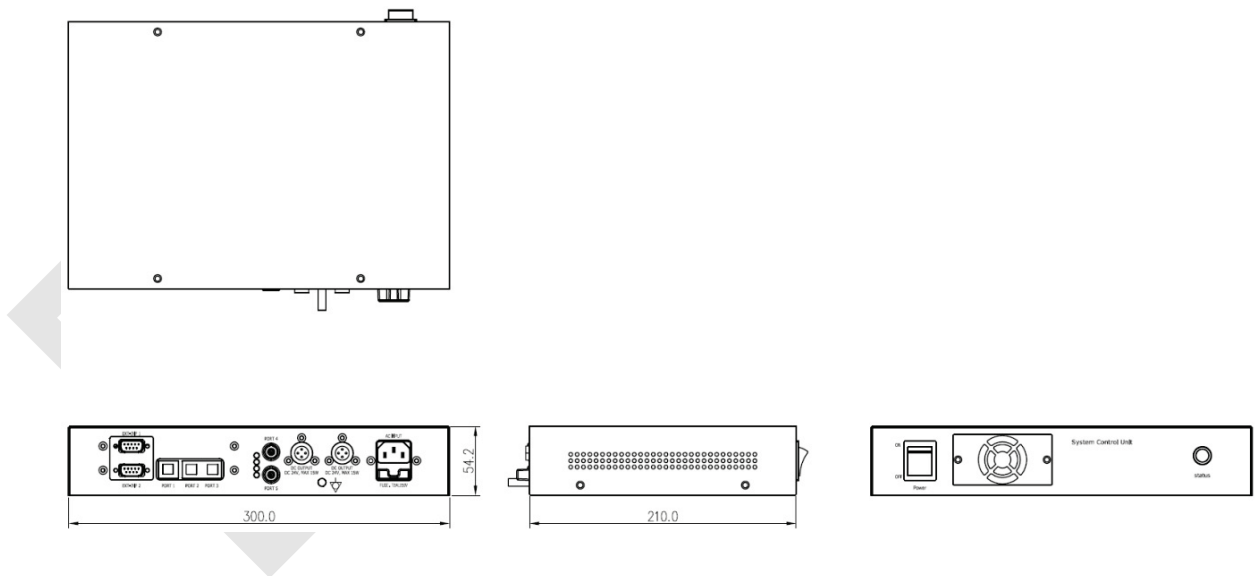

### 2.4.3 Functions

#### Front Side

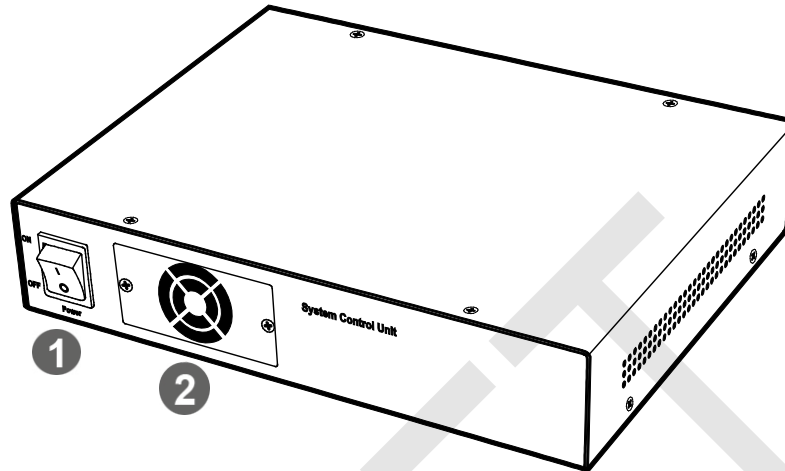

No.	Name	Description
1	Power Switch	<ul style="list-style-type: none"> <li>• SCU power switch (ON or OFF) (Including green LED Lamp)</li> </ul>
2	Fan	<ul style="list-style-type: none"> <li>• Expels interior air of SCU</li> </ul>

#### Rear Side

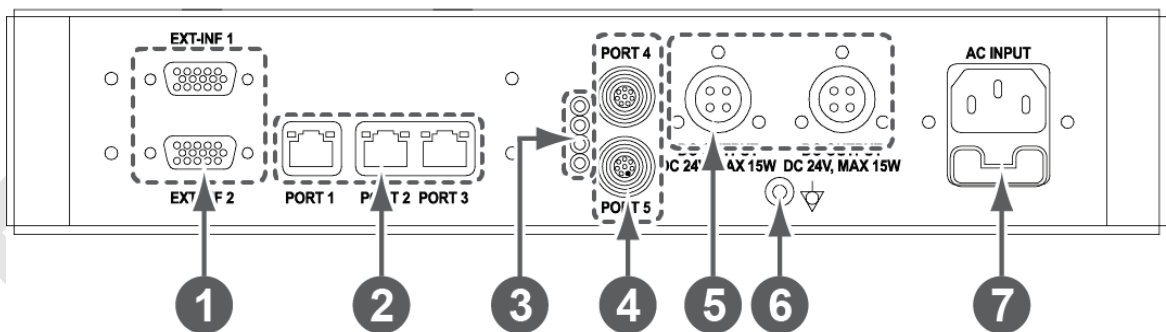

No.	Name	Description
1	EXT_INF1 EXT_INF2	X-ray generator interface connector (D-SUB 15 pins x 2 EA, Female) <ul style="list-style-type: none"> <li>• EXT_INF1 : 1 ~ 15</li> <li>• EXT_INF2 : 16 ~ 30</li> </ul>
2	LAN port (Port 1, 2, 3)	Gigabit Ethernet port (1000BASE-T) <ul style="list-style-type: none"> <li>• <b>Port 1</b>: Communicates between workstation and SCU Basic.</li> <li>• <b>Port 2, 3</b>: Communicates between FXRD-1717S detector and SCU Basic when configuring multiple detectors.</li> </ul>
3	PoE status lamp	Indicates the status of PoE port (Port 4, Port 5) <ul style="list-style-type: none"> <li>• Green: 1 Gbps</li> </ul>

		<ul style="list-style-type: none"><li>• Orange: 100 Mbps</li></ul>
4	<b>PoE port (Port 4, 5)</b>	PoE (Power over Ethernet) port (1000BASE-T) <ul style="list-style-type: none"><li>• Communicates between the detector and SCU Basic.</li><li>• Supplies power to the detector.</li></ul>
5	<b>Detector power supply port</b>	Max. DC +24V/15W (2 ports) <ul style="list-style-type: none"><li>• For FXRD-1717S detector only.</li></ul>
6	<b>P.E</b>	Equipotential ground
7	<b>AC input port</b>	T2AL250V fuse (2 EA) <ul style="list-style-type: none"><li>• 100 ~ 240V</li><li>• 50/60Hz</li><li>• Supplies power to SCU Basic.</li></ul>



- The P.E (Potential Equalization) port of SCU is used to maintain potential equalization between SCU and another grounded system. Use the conductor that can be detached without the use of a tool.

## 2.5 SCU Basic (FXRS-03A)

SCU Basic synchronizes the image and X-ray signal as locating among the detector, workstation and the X-ray generator. You can use the SCU Basic directly when the power supplies to SCU Basic after connecting it under the **VIVIX-S 1012N** system environment

### 2.5.1 Specifications

Item	Specifications
<b>Model</b>	<ul style="list-style-type: none"> <li>FXRS-03A</li> </ul>
<b>Power supply</b>	<ul style="list-style-type: none"> <li>Input: AC100 to 240V, 50/60Hz, Max. 200VA</li> <li>Output: DC +24V 3.25A, 78W</li> </ul>
<b>Cable connection port</b>	<ul style="list-style-type: none"> <li>Gigabit Ethernet port (3EA)</li> <li>PoE (Power over Ethernet) Port (2EA)</li> </ul>
<b>Wireless communication</b>	<ul style="list-style-type: none"> <li>IEEE 802.11n (2.4 GHz / 5 GHz)</li> </ul>
<b>Dimension (H × W × D)</b>	<ul style="list-style-type: none"> <li>236.0 mm × 300.0 mm × 58.0 mm</li> </ul>
<b>Antenna</b>	<ul style="list-style-type: none"> <li>105 mm (2EA, Dual band)</li> </ul>
<b>Weight</b>	<ul style="list-style-type: none"> <li>2.8 kg</li> </ul>

### 2.5.2 Drawing Sheet

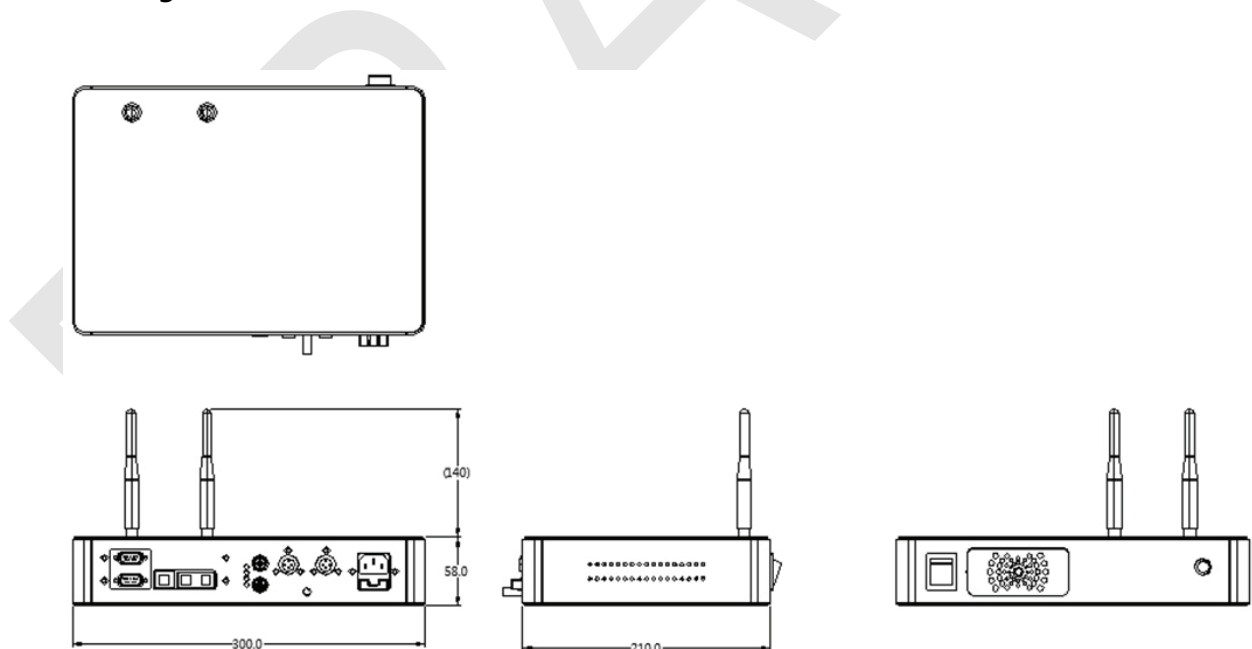

## 2.5.3 Functions

### Front Side

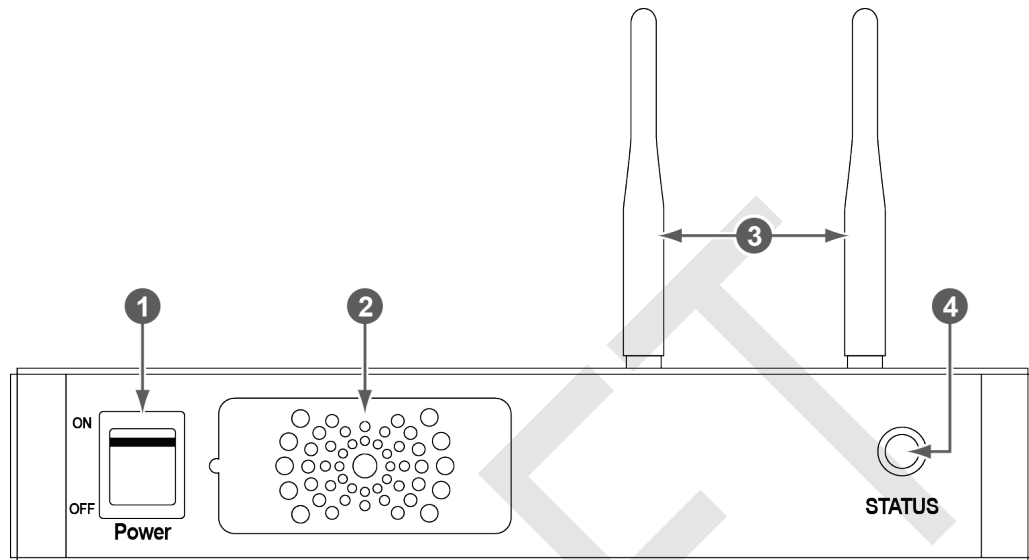

No.	Name	Description
1	<b>Power switch</b>	Turns on/off the power of SCU Basic. (Including Green LED Lamp)
2	<b>Fan</b>	Expels the air inside of SCU Basic.
3	<b>Antenna</b>	Assists communications between the detector and SCU Basic.
4	<b>Status LED</b>	Indicates the operation and connection status of SCU Basic. <ul style="list-style-type: none"> <li>• Blinking green: Booting</li> <li>• Green: Completed to boot up</li> <li>• Blue: The software is connected and ready to communicate.</li> </ul>

Rear Side

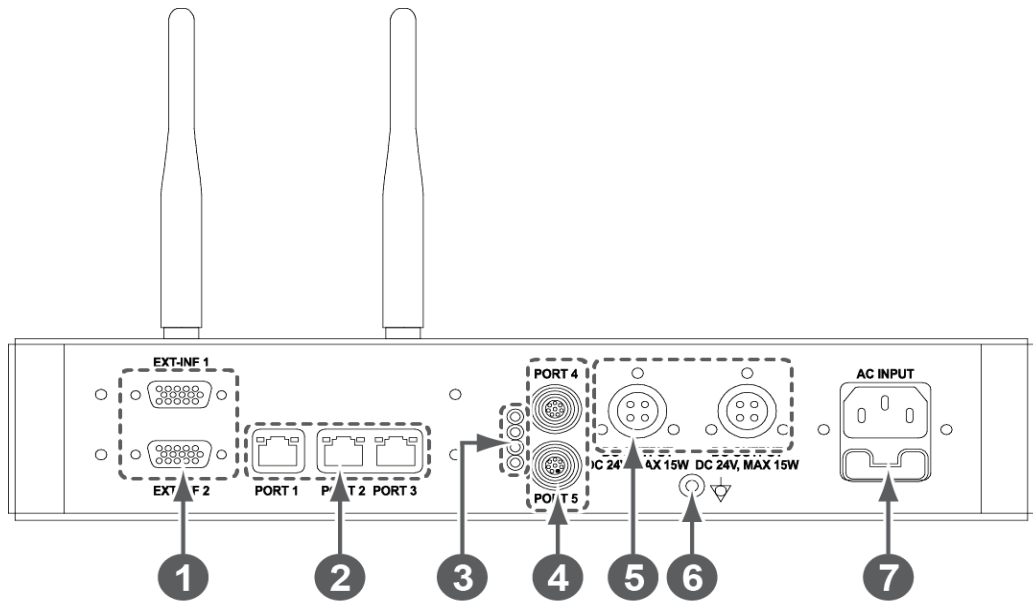

No.	Name	Description
1	EXT_INF1 EXT_INF2	X-ray generator interface connector (D-SUB 15 pins x 2 EA, Female) <ul style="list-style-type: none"> <li>• EXT_INF1 : 1 ~ 15</li> <li>• EXT_INF2 : 16 ~ 30</li> </ul>
2	LAN port (Port 1, 2, 3)	Gigabit Ethernet port (1000BASE-T) <ul style="list-style-type: none"> <li>• Port 1: Communicates between workstation and SCU Basic.</li> <li>• Port 2, 3: Communicates between FXRD-1717S detector and SCU Basic when configuring multiple detectors.</li> </ul>
3	PoE status lamp	Indicates the status of PoE port (Port 4, Port 5) <ul style="list-style-type: none"> <li>• Green: 1 Gbps</li> <li>• Orange: 100 Mbps</li> </ul>
4	PoE port (Port 4, 5)	PoE (Power over Ethernet) port (1000BASE-T) <ul style="list-style-type: none"> <li>• Communicates between the detector and SCU Basic.</li> <li>• Supplies power to the detector.</li> </ul>
5	Detector power supply port	Max. DC +24V/15W (2 ports) <ul style="list-style-type: none"> <li>• For FXRD-1717S detector only.</li> </ul>
6	P.E	Equipotential ground T2AL250V fuse (2 EA)
7	AC input port	<ul style="list-style-type: none"> <li>• 100 ~ 240V</li> <li>• 50/60Hz</li> <li>• Supplies power to SCU Basic.</li> </ul>



• The P.E (Potential Equalization) port of SCU is used to maintain potential equalization between SCU and another grounded system. Use the conductor that can be detached without the use of a tool.

## 2.6 SCU mini (FXRS-04A)

SCU mini synchronizes the image and X-ray signal as locating among the detector, workstation and the X-ray generator. You can use the SCU mini directly when the power supplies to SCU mini after connecting it under the **VIVIX-S 1012N** system environment

### 2.6.1 Specifications

Item	Specifications
<b>Model</b>	• FXRS-04A
<b>Power supply</b>	• Input: DC +24V 2A Max
<b>Cable connection port</b>	• Gigabit Ethernet port (3EA) • PoE (Power over Ethernet) Port (1EA)
<b>Wireless communication</b>	• IEEE 802.11n (2.4 GHz / 5 GHz)
<b>Dimension (H × W × D)</b>	• 211.5 mm × 170.0 mm × 45.0 mm
<b>Antenna</b>	• 105 mm (2EA, Dual band)
<b>Weight</b>	• 1.2kg

### 2.6.2 Drawing Sheet

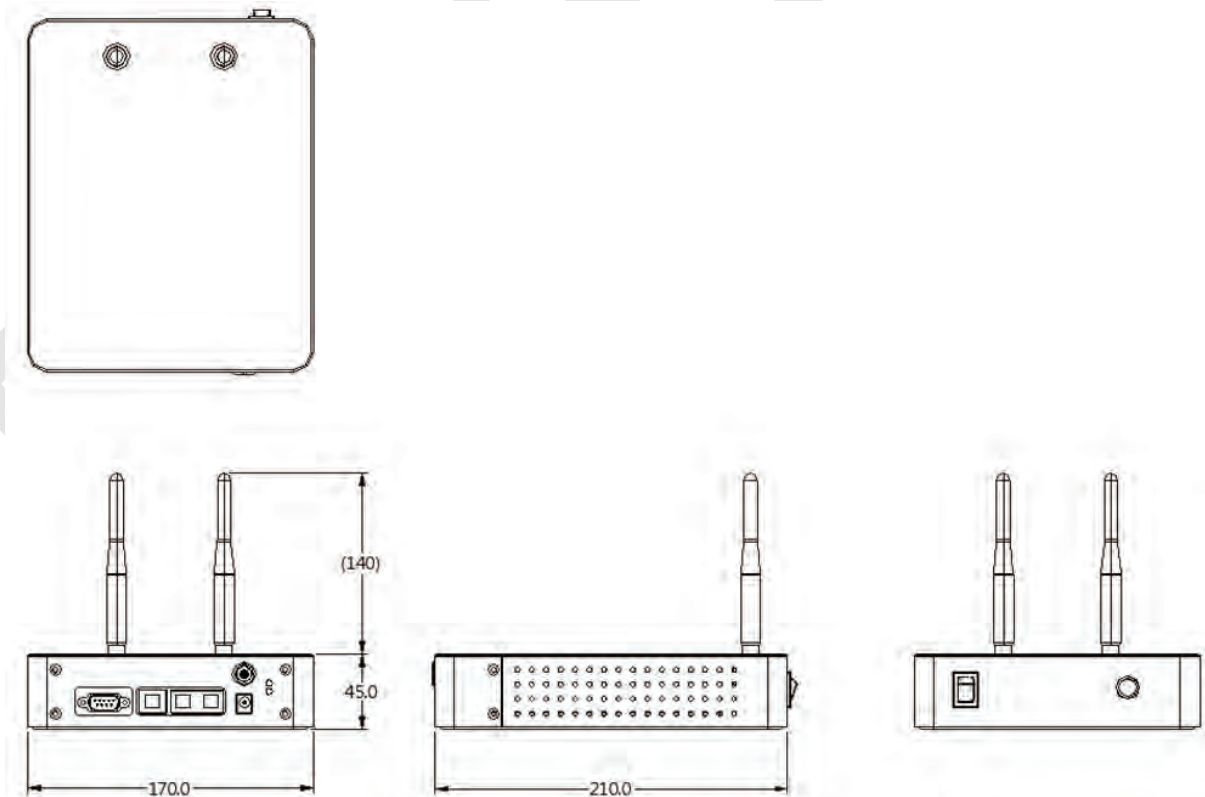



## 2.6.3 Functions

### Front Side

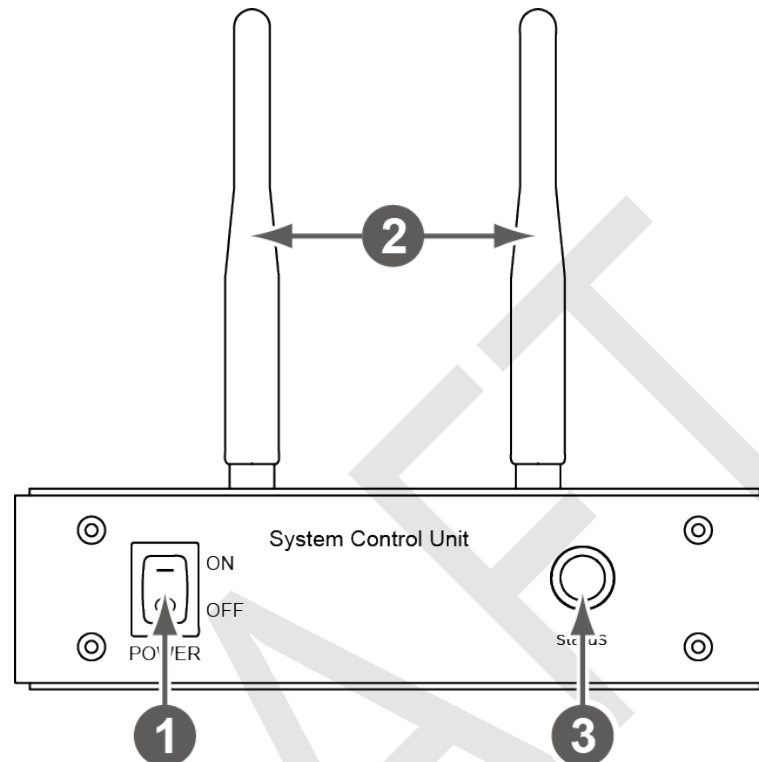

No.	Name	Description
1	<b>Power switch</b>	Turns on/off the power of SCU mini. (Including Green LED Lamp)
2	<b>Antenna</b>	Assists communications between the detector and SCU mini.
3	<b>Status LED</b>	Indicates status of SCU mini operation and connection. <ul style="list-style-type: none"> <li>• Blinking green: Booting</li> <li>• Green: Completed to boot up</li> <li>• Blue: The detector is connected and ready to communicate.</li> </ul>

Rear Side

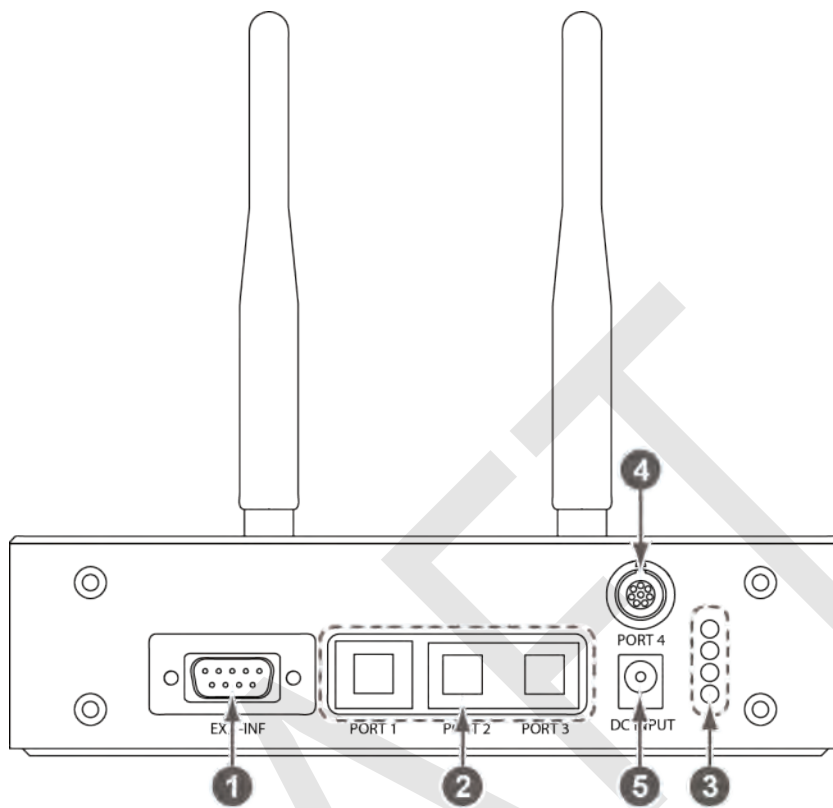

No.	Name	Description
1	EXT_INF	X-ray generator interface connector (D-SUB 15pin, Female)
2	LAN port (Port 1, 2, 3)	Gigabit Ethernet port (1000BASE-T) <ul style="list-style-type: none"> <li>• <b>Port 1:</b> Communication between the workstation and SCU mini.</li> <li>• <b>Port 2, 3:</b> Communication between <b>FXRD-1717S</b> detector and SCU mini when configuring multiple detectors.</li> </ul>
3	PoE status lamp	Indicates the status of <b>PoE</b> port. <ul style="list-style-type: none"> <li>• Green: 1 Gbps</li> <li>• Orange: 100 Mbps</li> </ul>
4	PoE port	<b>PoE</b> (Power over Ethernet) port (1000BASE-T) <ul style="list-style-type: none"> <li>• Communication between the detector and SCU mini.</li> <li>• Supplies power to the detector.</li> </ul>
5	DC power input port	DC +24V <ul style="list-style-type: none"> <li>• Supplies power to SCU mini.</li> </ul>

## 2.7 Battery Pack

### 2.7.1 Specifications

Item	Specifications
Model	FXRB-03A
Type	Lithium Ion
Rated Power Supply	Output: DC +7.6V
Capacity	3,100mAh
Number of cell	2S1P (2 Series 1 Parallel)
Life	Approx. 500 times (Fully charged/Discharged completely, 1cycle)
Dimension (H × W × D)	160.0 mm × 61.8 mm × 5.7 mm
Weight	115g

### 2.7.2 Drawing Sheet

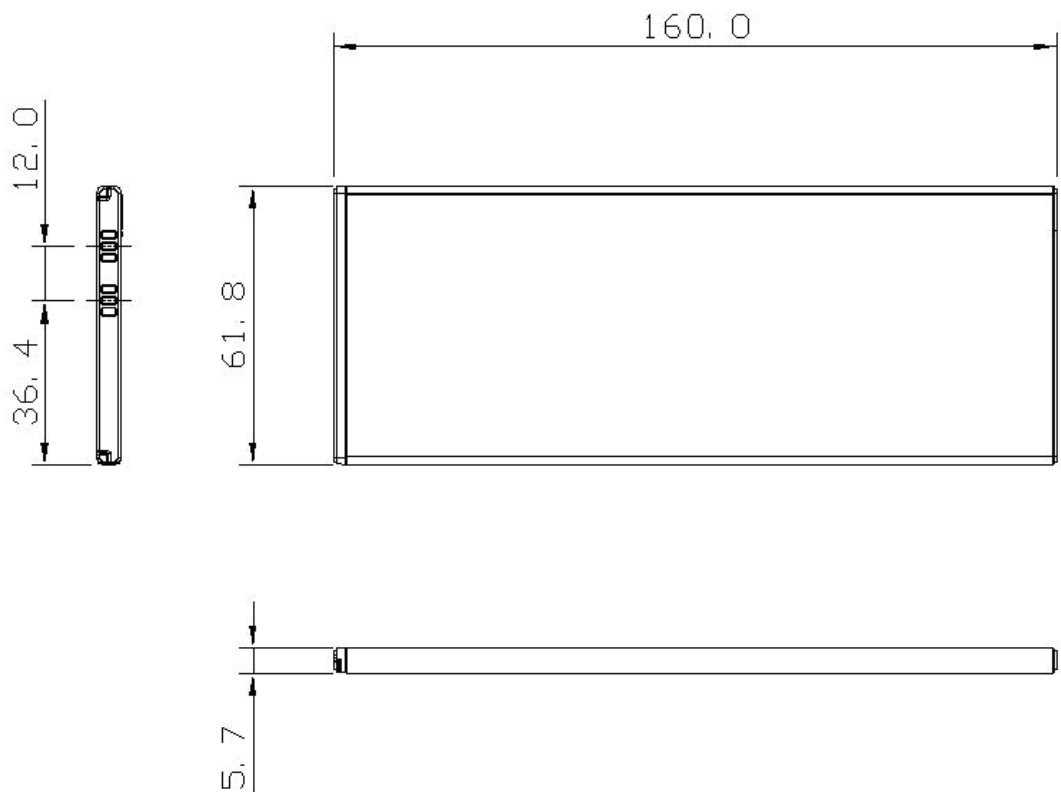

## 2.8 Battery Charger

### 2.8.1 Specifications

Item	Specifications
Model	FXRC-02A
Simultaneous Charging	2 battery packs
Charging time	3 hours
Rated power supply	DC +24V, 2A Max.
Dimension (H × W × D)	192.0 mm × 101.0 mm × 26.0 mm
Weight	0.8 kg

### 2.8.2 Drawing Sheet

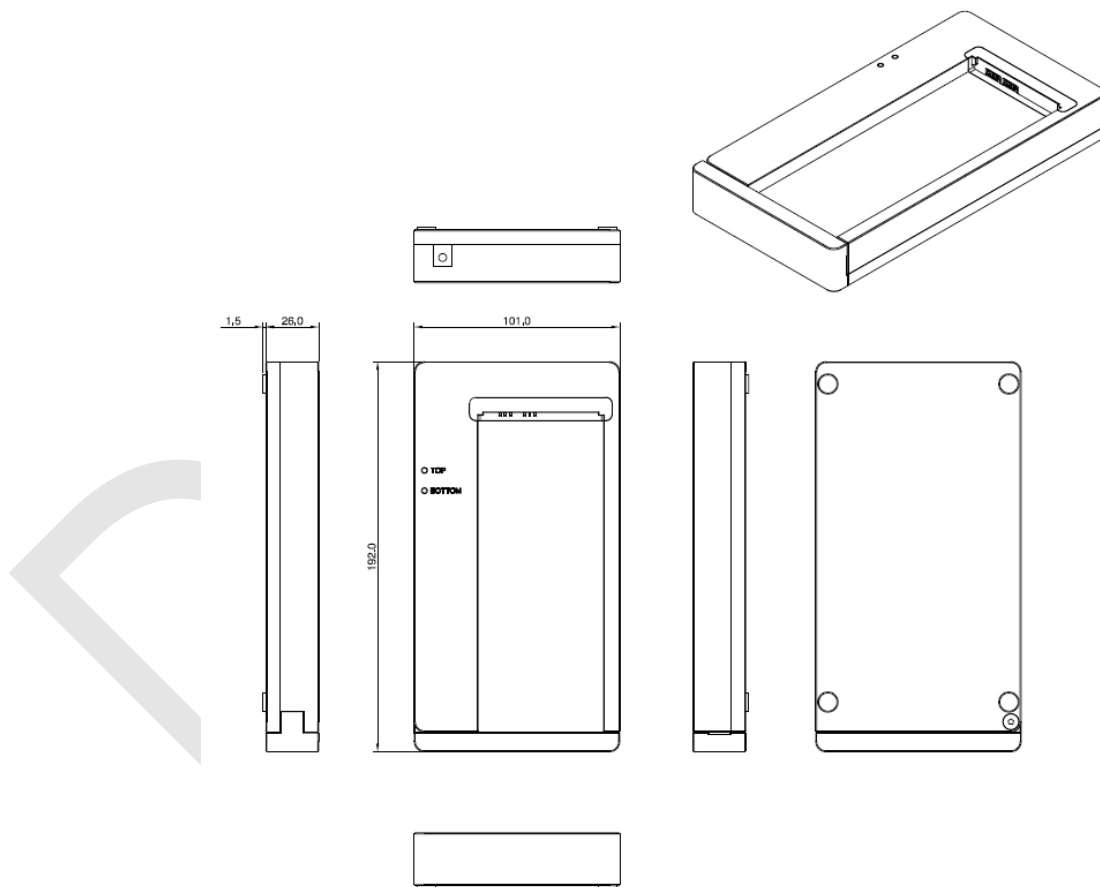

No.	Name	Description
1	Top / Bottom LED	Indicates the position and status of a battery being charged.
2	Power input port	Supplies electric power by connecting a power adapter to the battery charger.

## 2.9 Others

### 2.9.1 X-ray Generator (Recommended Exposure Condition)

Item	Recommended condition
X-ray energy range	• 40kVp ~ 150kVp
Reliability (Lifetime Dose)	• 74Gy or higher (35 uGy x 365days x 24hrs x 60min. x 60sec. / 15sec.)

### 2.9.2 Recommended Specifications of Workstation (PC)

Item	Recommended specification
Operating System	<ul style="list-style-type: none"> <li>• VIVIX Setup               <ul style="list-style-type: none"> <li>▫ Microsoft Windows 7 (32bit / 64bit)</li> <li>▫ Microsoft Windows 7 64bit SP1 (Professional Edition or higher)</li> <li>▫ Microsoft Windows Vista Service pack 1 or higher (32bit / 64bit)</li> <li>▫ Microsoft Windows 8 (32bit / 64bit) / 8.1 64bit SP1 (Professional Edition or higher)</li> <li>▫ Microsoft Windows 8.2 (32bit / 64bit)</li> </ul> </li> </ul>
CPU	• Intel Core i5 2600 or higher (or compatible CPU)
Memory	• 4GB or higher
Hard Disk	• 1TB or higher
LAN Card (only for detector communication)	<ul style="list-style-type: none"> <li>• Gigabit (for detector only)</li> <li>• Intel® PRO 1000 Series (Gigabit LAN Card for network interface)</li> <li>• Min.requiremetns               <ul style="list-style-type: none"> <li>▫ Speed: 1Gbps or more</li> <li>▫ Jumbo Frames: 9K</li> </ul> </li> <li>• Receive Descriptors: 2K (1024 or higher)</li> </ul>
Monitor	• 1024 x 768 or more
CD-ROM	• CD or DVD R/W

### 2.9.3 Recommended Specifications of Grid

Item	Recommended specification
SID	• 100cm / 130cm / 150cm / 180cm
Size	• 451mm x 365mm x 1.5mm
Ratio	• 8.1 / 10:1 / 12:1
Frequency	• 215 line/inch
INTER SPACER	• AL



- Check the recommended specifications by Vieworks first before buying the generator, workstation and grid.

---

## 3. System Configuration

---

This section gives information about the various connection / configuration ways among the detector, SCU, workstation and X-ray generator.

You can figure out the most suitable way of system configuration through this instruction.

Detector Connection Method  
Diagram  
System Configuration  
Generator Interface

### 3.1 Detector Connection Methods

You can organize wired or wireless connection between the **VIVIX-S 1012N** detector and SCU. You can also choose other connection ways suitable for the use environment in case of need.

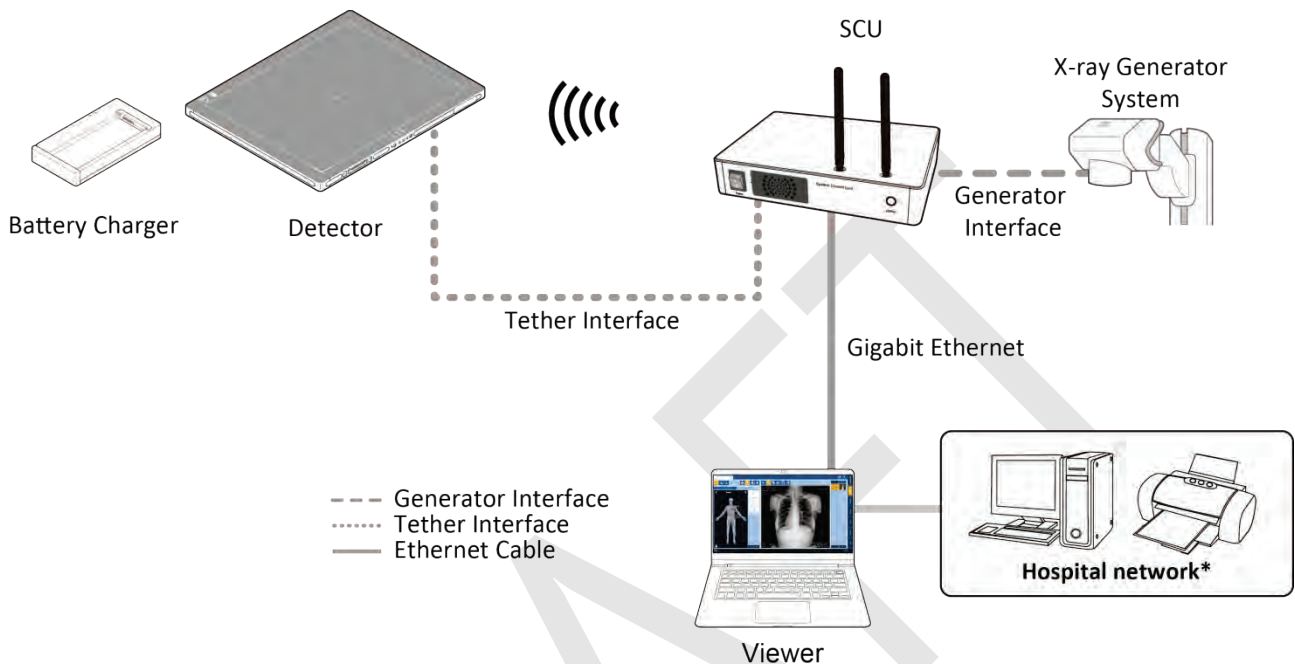

#### 3.1.1 Wireless Connection

- The images and data are transmitted between the **VIVIX-S 1012N** detector and SCU by wireless connection.
  - A battery pack should be installed in the detector to use it under the wireless configuration.



- We recommend you to use the wireless connection method for the following cases.
  - When using the unfixed detector.
  - When the wired communication is in trouble by the interruption of cables.
- The wireless connection is more freely to operate than the wired connection.
- Use the wireless connection with a laptop computer to enhance mobility.



- Be sure to operate the wireless communication between the detector and SCU within a maximum of **8m**.
- Use of multiple WLAN devices within the same frequency band may interfere with each wireless communication and cause a decline in transmission speed.
- Do not cover or block the wireless module of the detector. Also, do not put any shielding materials between the detector and SCU. Otherwise, the transmission speed or operable distance may be reduced.

### 3.1.2 Wired Connection

- Connect **VIVIX-S 1012N** detector and SCU with a tether interface cable to make a wired configuration.
  - As the tether interface cable supplies power to the detector, a battery pack is not needed to be installed in the detector.



- We recommend you the wired connection method for the following cases.
  - When continuous power supply to the detector is needed.
  - When the detector is fixed in a bucky stand or on a table.
  - When you upgrade the detector firmware or change the inner configural information.
  - When you need the data communication to be faster than the wireless connection.
- A battery pack in the detector keeps charging under the wired connection.
- The wireless communication module of the detector maintains inactivation status.



### 3.2 Diagram

#### 3.2.1 Block Diagram

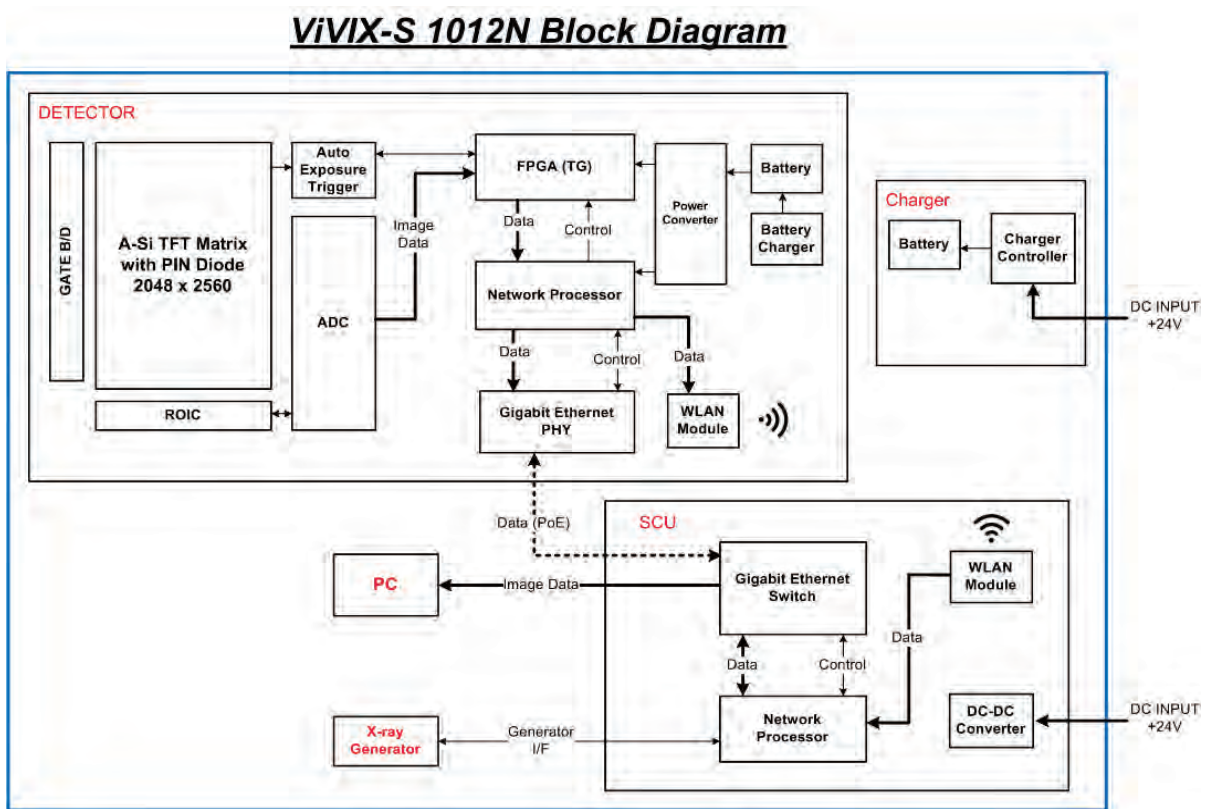

#### 3.2.2 Wiring Diagram

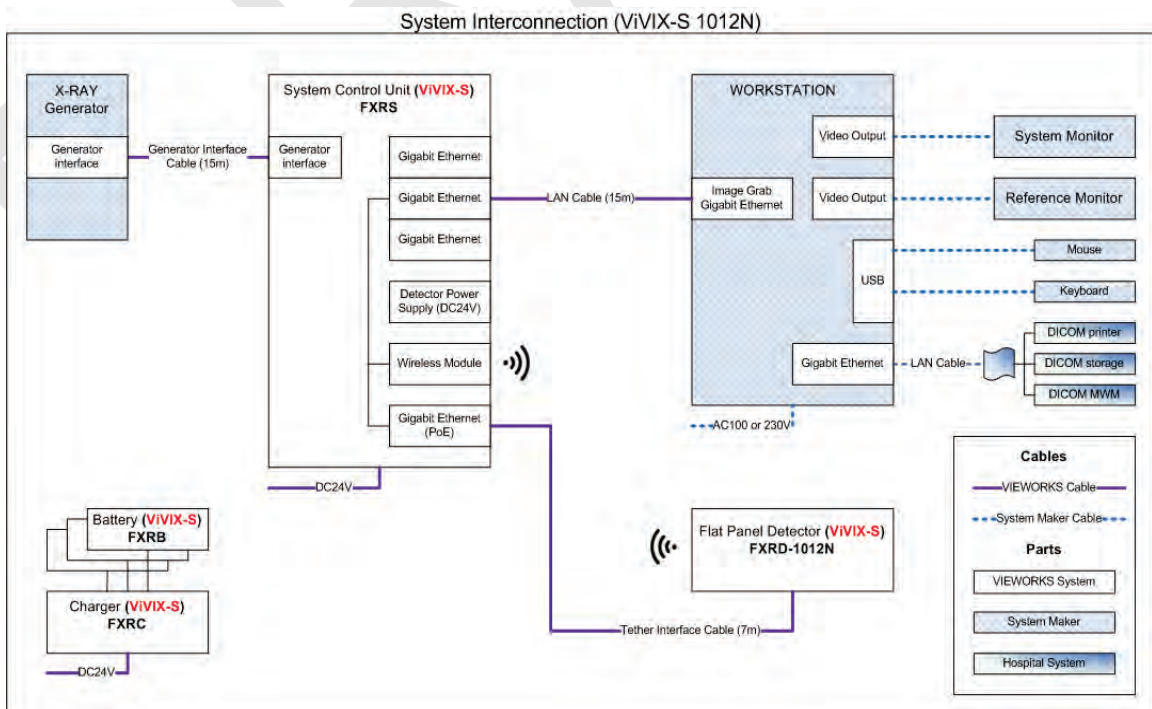

### 3.3 System Configuration

This section gives information about the configuration modes of **VIVIX-S 1012N** detector, SCU, workstation and the generator.

#### 3.3.1 AP Mode (SCU AP Mode)

SCU AP mode is the wireless connection method that connecting the detector with **SCU** as the center wirelessly.

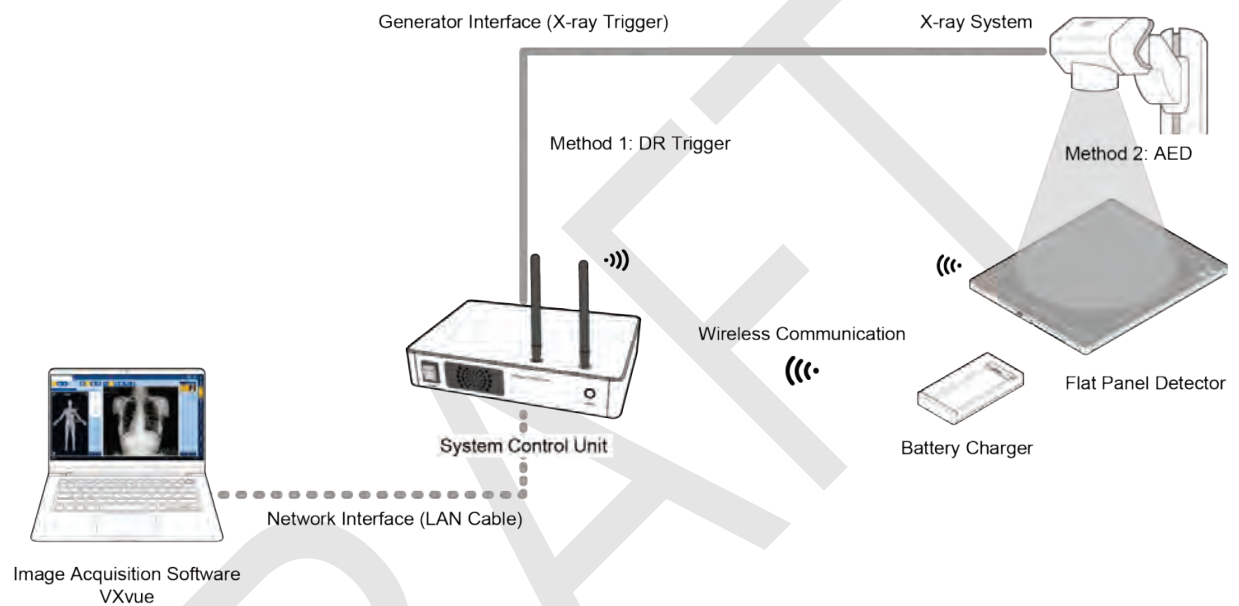

#### SCU & Detector

- The **VIVIX-S 1012N** detector and SCU are connected wirelessly. In this case, SCU and the detector operate as **AP** (Access Point) and **STATION** respectively.

#### SCU & PC (Workstation)

- SCU and PC (Workstation) are connected with the LAN cable.



- It is available to connect SCU and PC wirelessly. In this case, SCU and the detector operate as **AP** (Access Point) and **STATION** respectively.

#### SCU & Generator

- SCU and the generator can be connected with the generator interface cable.



- It is unnecessary to connect SCU and the generator with a generator interface cable if you use AED mode of the detector.

### 3.3.2 Tether Interface Mode

Tether interface mode is the wired connection method that connecting the detector with SCU as the center.

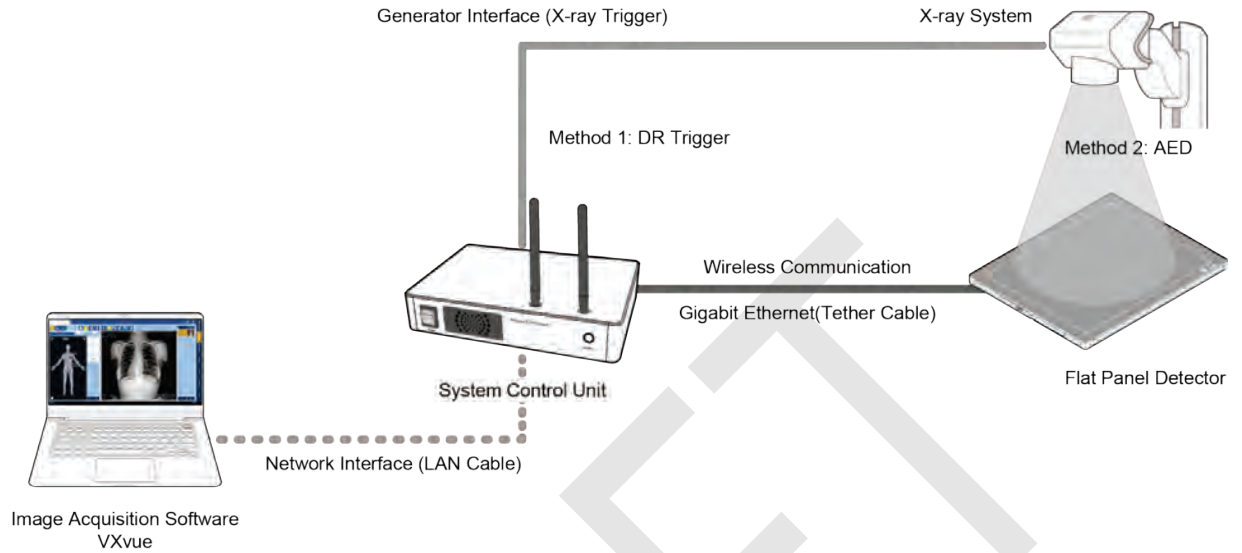

#### SCU & Detector

- SCU and the **VIVIX-S 1012N** detector are connected with the tether interface cable.



- Other connection ways of the tether interface mode are the same as the AP mode.

### 3.3.3 External AP Mode

External AP mode is the wireless connection method that adding the external AP device instead of SCU.

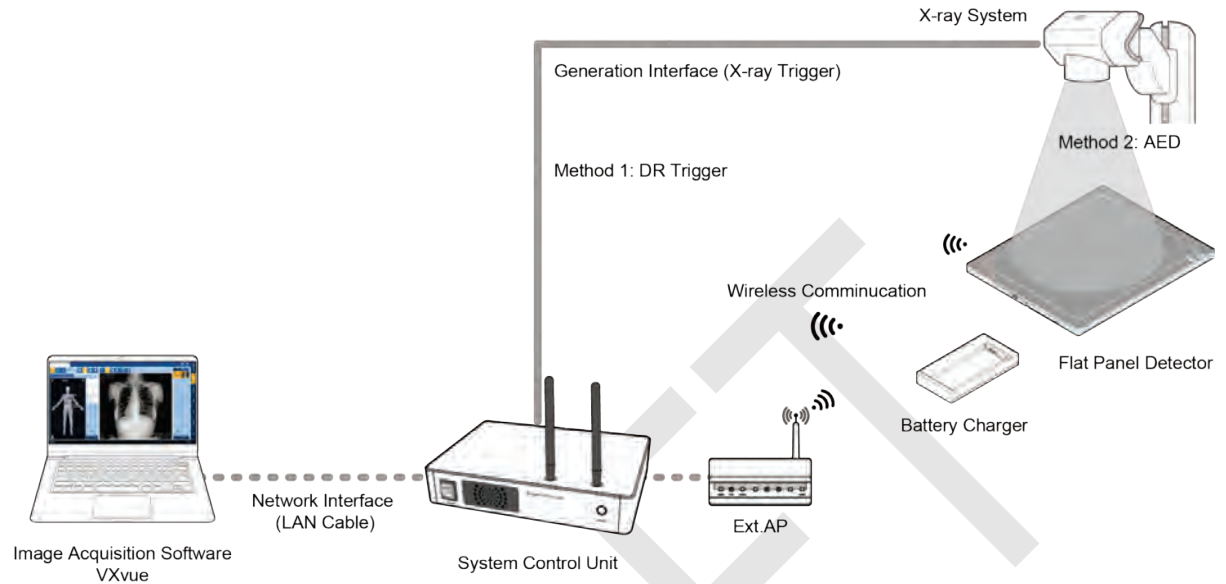

#### External AP & SCU

- The external AP and SCU are connected with a LAN cable.

#### External AP & Detector

- The external AP and **VIVIX-S 1012N** detector are connected wirelessly. In this case, the external AP and the detector operate as **AP** (Access Point) and **STATION** respectively.



- Other connection ways of the tether interface mode are the same as the AP mode.



- Be sure to check the specifications of external AP device when configuring the external AP mode, since the wireless communication performance can be different by the specifications.

### 3.3.4 Detector AP Mode

Detector AP mode is the wireless connection method that connecting the PC (Workstation) with the detector as the center wirelessly.

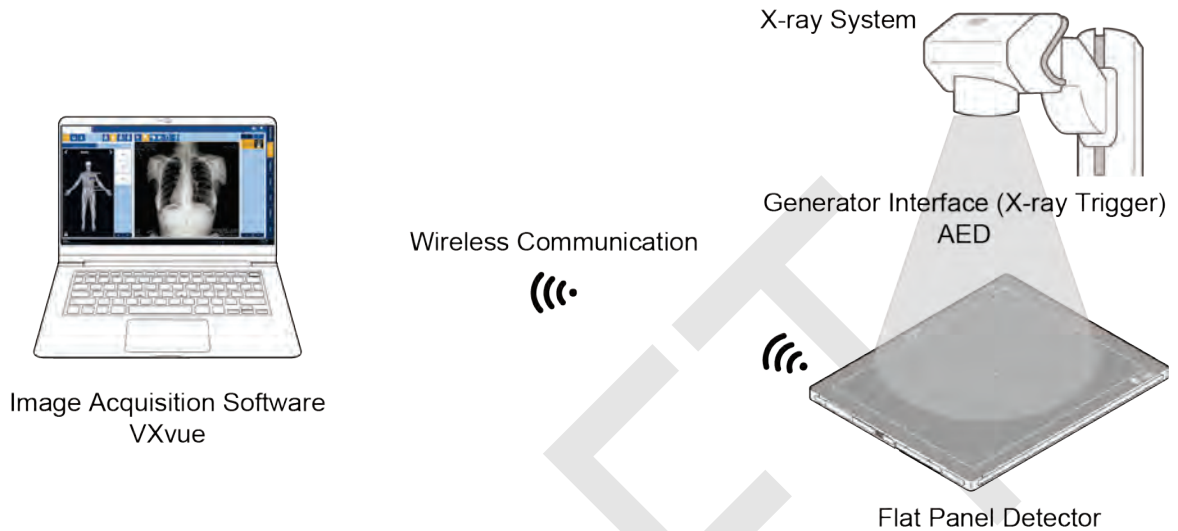

#### Detector & PC (Workstation)

- The **VIVIX-S 1012N** detector and PC are connected wirelessly. In this case, the detector and the PC operate as **AP** (Access Point) and **STATION** respectively.



- Since SCU is not used for configuring the detector AP mode, you can only use the **AED** mode without a wired connection. (Cannot use the **DR Trigger** mode.)
- This mode can be used when mobility and portability are needed.



- When configuring the detector AP mode, be sure to check the specifications of wireless module installed in the PC. The wireless communication performance can be different depending on the specifications of the wireless module.
- If the wireless connection cannot be made normally because of unexpected problems, SCU can be needed to check the detector condition.

### 3.3.5 Detector Stand-Alone Mode

You can use the **Stand-Alone** mode without making a wired or wireless connection.

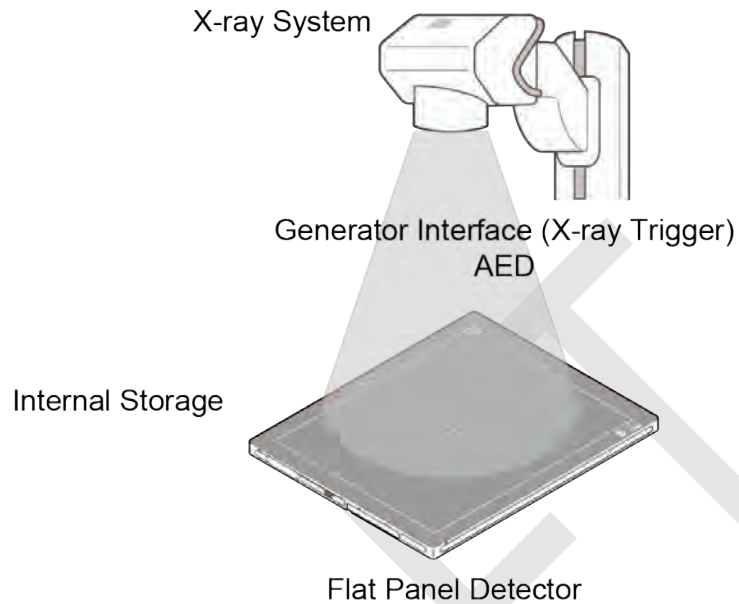

- You should take images with the **AED** mode only when using the **Stand-Alone** mode. (Cannot use the **DR Trigger** mode.)
- The acquired images are stored in the internal storage of the detector in order and the images can be transmitted to the PC after connecting the detector to the PC.
- The transmitted images are removed automatically from the detector.

### 3.4 Generator Interface

VIVIX-S 1012N detector provides **DR Trigger** interface and **AED** interface as a generator interface way to acquire images by detecting X-ray.

Mode	Description
AED	The detector detects X-ray exposure from the generator automatically and then performs image acquisition without any cable connection.
DR Trigger	The detector and generator receive and send their signal to each other for image acquisition. SCU and X-ray generator should be connected with the generator interface cable.

#### 3.4.1 AED (Auto Exposure Detection) Interface

If the VIVIX-S 1012N detector is used as the **AED** interface, you can acquire images without connecting the generator to the detector with a generator interface cable.

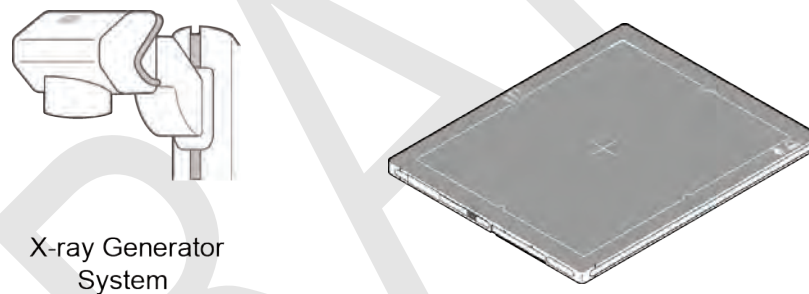

#### Cautions when using AED interface



- Make sure to follow the operating environmental condition (Temp: +10°C ~ +35°C).
- Do not give impact to the product. If it receives strong jolt, unwanted images may be acquired without the X-ray exposure because of the malfunction of the **AED** sensor.
- You may not acquire images or horizontal artifacts may occur depending on the external environment such as exposure condition, thickness of object or the use of grid.
- When you set X-ray exposure area to the direction of the detector, the center of the detector should be involved in the X-ray exposure area. Otherwise, you may not acquire an image.



### 3.4.2 DR Trigger Interface

Connect the detector and X-ray generator with a generator interface cable, and then acquire images by sending and receiving their signal.

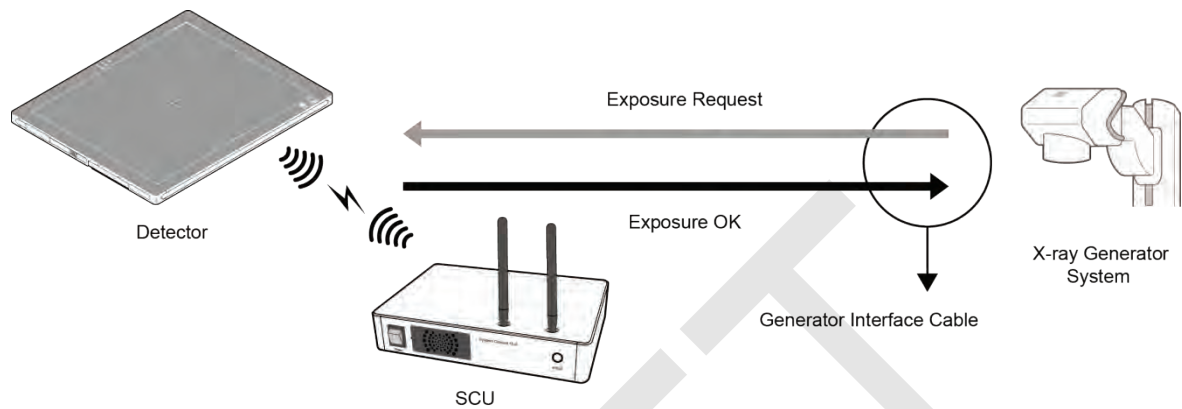

#### Signal Processing Steps

- 1 The detector receives **EXP\_REQ** signal from the X-ray generator.
- 2 After the detector completes to prepare image acquisition, it sends the **EXP\_OK** signal to the X-ray generator.
- 3 The X-ray generator confirms **EXP\_OK** signal and generates X-rays.
- 4 The detector acquires images and then transmits the image data.



- **EXP\_REQ** is a sending signal from X-ray generator to the detector for requesting exposure.
- **EXP\_OK** is an exposure ready signal from the detector to X-ray generator.



### 3.5 Configuring DR Trigger Interface

To configure the **DR Trigger** interface, SCU and the generator should be connected with a generator interface cable. Connect the one end of generator interface cable to **EXT\_INF** port of SCU, and then connect the other end to the generator.



- Up to three generators can be connected with SCU Basic.
- Only one generator can be connected with SCU mini.

#### 3.5.1 Trigger Interface Way

The generator interface cable is connected differently depending on the two (2) types of trigger interface.

Trigger Interface	Description
Packet Trigger	Handles exposure signal by exchanging packet.
Line Trigger	Handles exposure signal by exchanging electrical signal.

#### 3.5.2 Packet Trigger

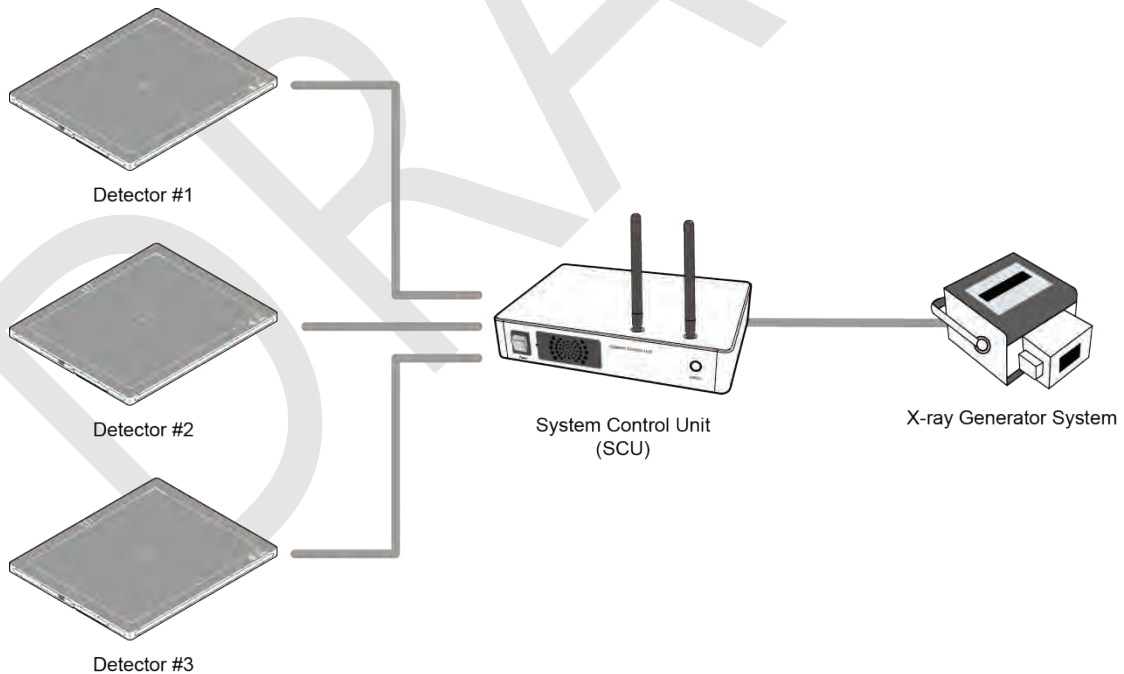

- Multiple detectors share one generator signal together.
- Connect a generator interface cable to one of the pin groups.
- The generator transmits and receives signal with the one selected detector for taking images.

### 3.5.3 Line Trigger

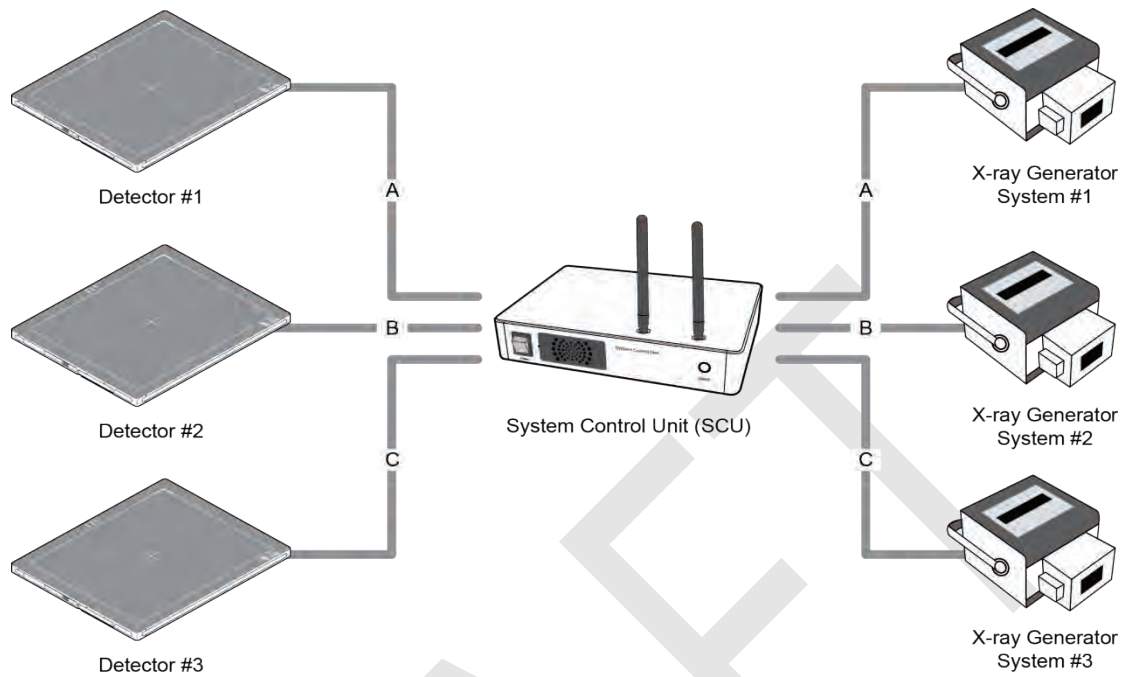

- Each detector shares a signal signal by being connected with generators separately.
- Up to three X-ray generators can be connected to SCU.
- The connection of each detector and generator can be configured from **VIVIX Setup**.



- You should comprehend about a detector and X-ray generator to make correct exposure. Otherwise, X-ray can be exposed to the detector in different location.
- The engineer who understand the generator device and interface technology should be in charge of interface work between SCU and the generator.

### 3.5.4 EXT\_INF Port Pin Map

EXT\_INF port is D-SUB 15 pin female connectors of SCU, and used for the generator interface.

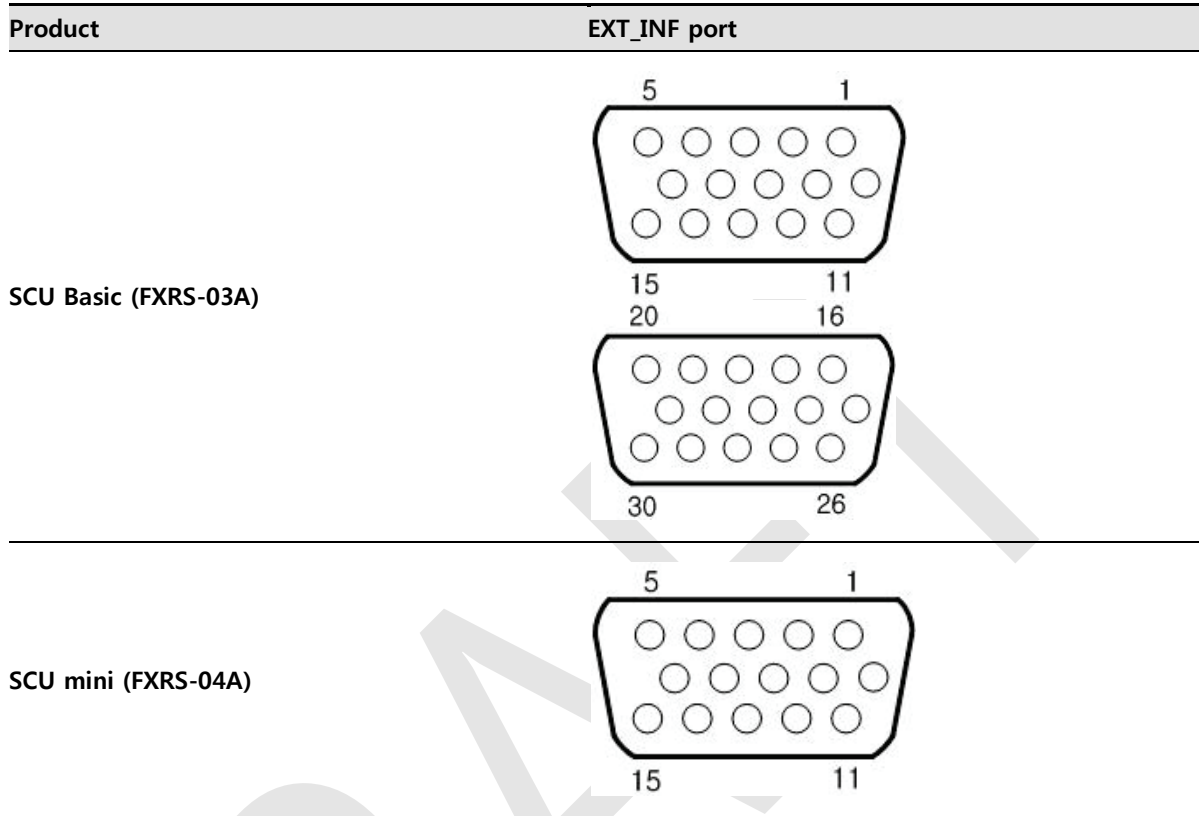

#### EXT\_INF1 port pin map definition (1 ~ 15)

No.	Signal name	I/O	Type	Color	Ch.	Description
1	EXP_REQ+_A	Input	Contact	Red	A	Receives EXP_REQ
2	EXP_REQ-_A	Input	Contact	Black	A	Returns signal from EXP_REQ+_A
3	EXP_REQ_TTL_A	Input	TTL	Orange	A	Receives EXP_REQ
4	EXP_REQ_GND_A	Input	TTL	Gray	A	Returns signal from EXP_REQ_TTL_A
5	EXP_OK_POWER_A/B	Input	-	Yellow	A/B	Power of TTL signal
6	EXP_OK+_A	Output	-	Green	A	Sends EXP_OK
7	EXP_OK-_A	Output	-	Brown	A	Returns signal from EXP_OK+_A
8	EXP_OK+_B	Output	-	Blue	B	Sends EXP_OK
9	EXP_OK-_B	Output	-	Pink	B	Returns signal from EXP_OK+_B
10	Reserved	-	-	-	-	Reserved for test only.
11	EXP_REQ+_B	Input	Contact	White	B	Receives EXP_REQ
12	EXP_REQ-_B	Input	Contact	Purple	B	Returns signal from EXP_REQ+_B
13	EXP_REQ_TTL_B	Input	TTL	White/Red	B	Receives EXP_REQ
14	EXP_REQ_GND_B	Input	TTL	White/Black	B	Returns signal from EXP_REQ_TTL_B
15	Reserved	-	-	-	-	Reserved for test only.

**EXT\_INF2 port pin map definition (16 ~ 30)**

No.	Signal name	I/O	Type	Color	Ch.	Description
16	EXP_REQ+_C	Input	Contact	Red	C	Receives EXP_REQ
17	EXP_REQ-_C	Input	Contact	Black	C	Returns signal from EXP_REQ+_C
18	EXP_REQ_TTL_C	Input	TTL	Orange	C	Receives EXP_REQ
19	EXP_REQ_GND_C	Input	TTL	Gray	C	Returns signal from EXP_REQ_TTL_C
20	EXP_OK_POWER_C	Input	-	Yellow	C	Power of TTL signal
21	EXP_OK+_C	Output	-	Green	C	Sends EXP_OK signal
22	EXP_OK-_C	Output	-	Brown	C	Returns signal from EXP_OK+_C
23	EXT_W+	Input	Contact	-	-	User-defined Pin 1
24	EXT_W-	Input	Contact	-	-	Returns signal from EXT_W+
25	EXT_X+	Input	Contact	-	-	User-defined Pin 2
26	EXT_X-	Input	Contact	-	-	Returns signal from EXT_X+
27	EXT_Y+	Input	Contact	-	-	User-defined Pin 3
28	EXT_Y-	Input	Contact	-	-	Returns signal from EXT_Y
29	EXT_Z+	Input	Contact	-	-	User-defined Pin 4
30	EXT_Z-	Input	Contact	-	-	Returns signal from EXT_Z+



- Since SCU mini has **EXT\_INF 1** port, only one generator can be connected with.



- Up to three X-ray generators can be connected to **EXT\_INF1** and **EXT\_INF2** ports, and each generator should be connected with a same channel.



- There are **Contact** type (OPEN/ CLOSE) and **TTL** type (ON/ OFF) on the signal in/output pin.
- TTL type information
  - ON : VCC
  - OFF : GND
  - Current: 5 mA ~ 10 mA
  - Voltage: 12 V ~ 24 V



- When you plan to add interface using a user-defined pin, contact to the person in charge of Vieworks.

### 3.5.5 Input / Output Circuit

#### Exposure Request Input Circuit (EXP\_REQ)

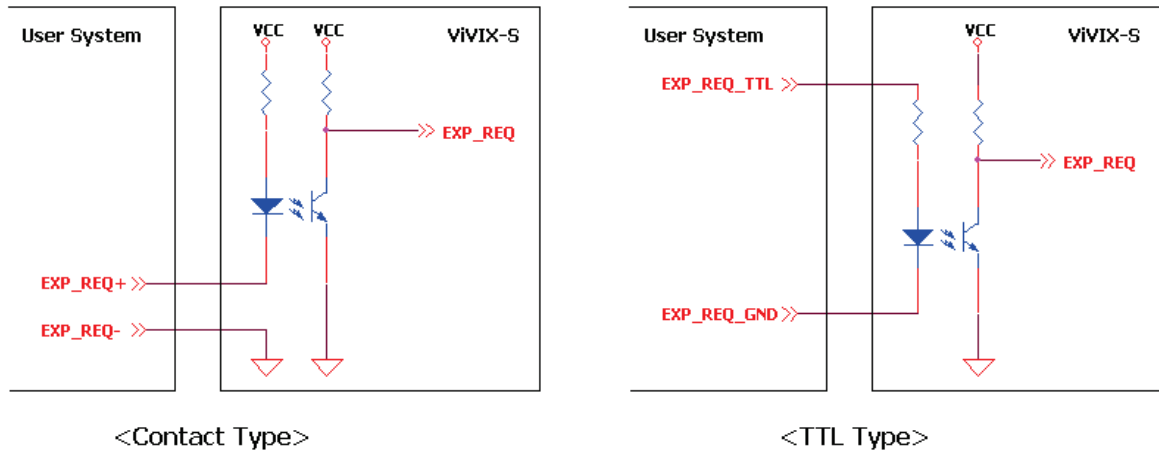

#### Exposure Respond Output Circuit (EXP\_OK)

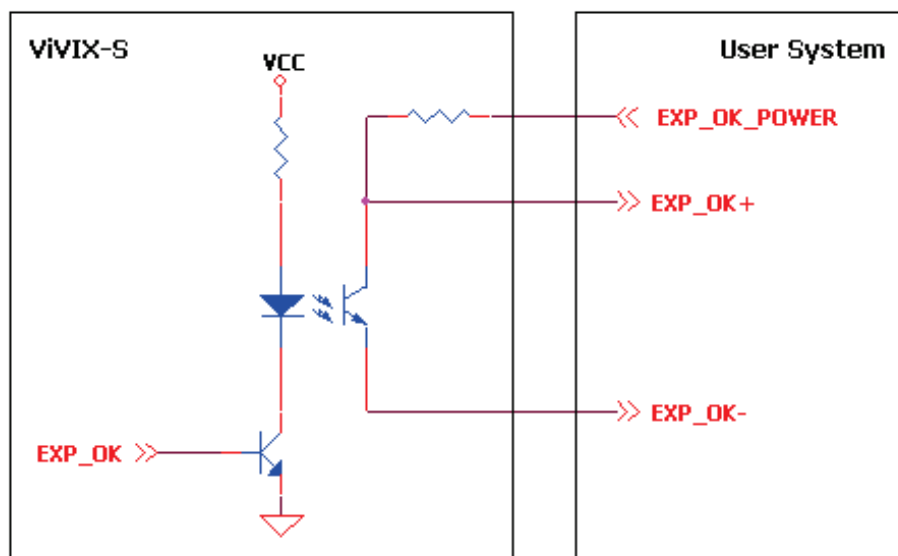

---

## 4. Installation

---

This section gives information about the installation process and method to use a detector.

Battery Pack

Product Installation

Generator Connection

Software Installation

Windows Environment Setting

## 4.1 Battery Pack



- Detector and its attached devices should be installed by an authorized service engineer.
- If you encounter any problems, consult the sales representative in Vieworks or a relevant engineer.

### 4.1.1 How to insert a battery pack

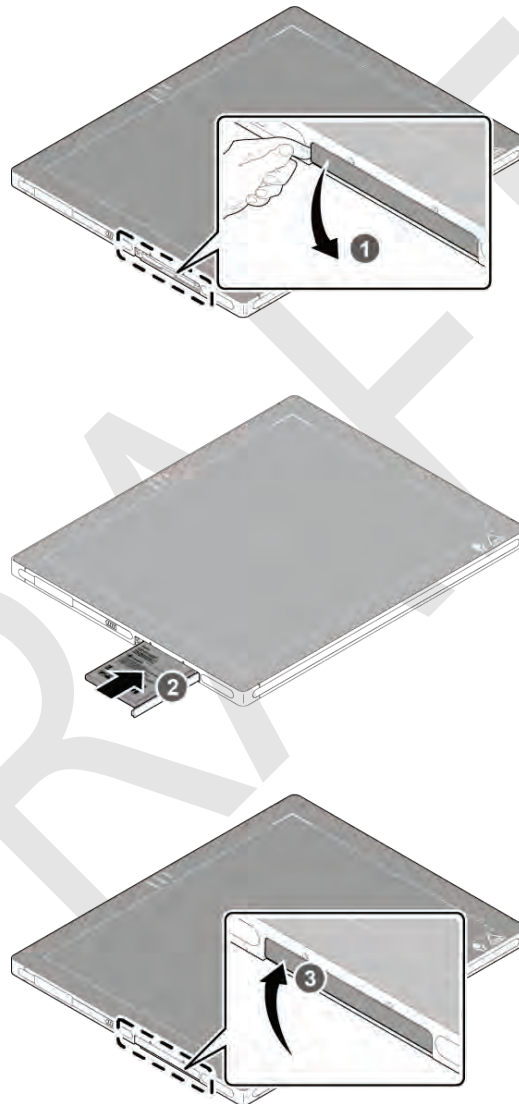

- 1 Open the battery cover.
- 2 Insert a battery into a slot until it clicks and push the lever to the right for fixing the battery.
- 3 Close the battery cover.



- Check if the battery is fully charged before using.
- Make sure that the battery pack is securely inserted.
- The remaining battery can be checked from the battery lamp on the side of detector or from the **VIVIX Setup** program.

### 4.1.2 How to take out a battery pack

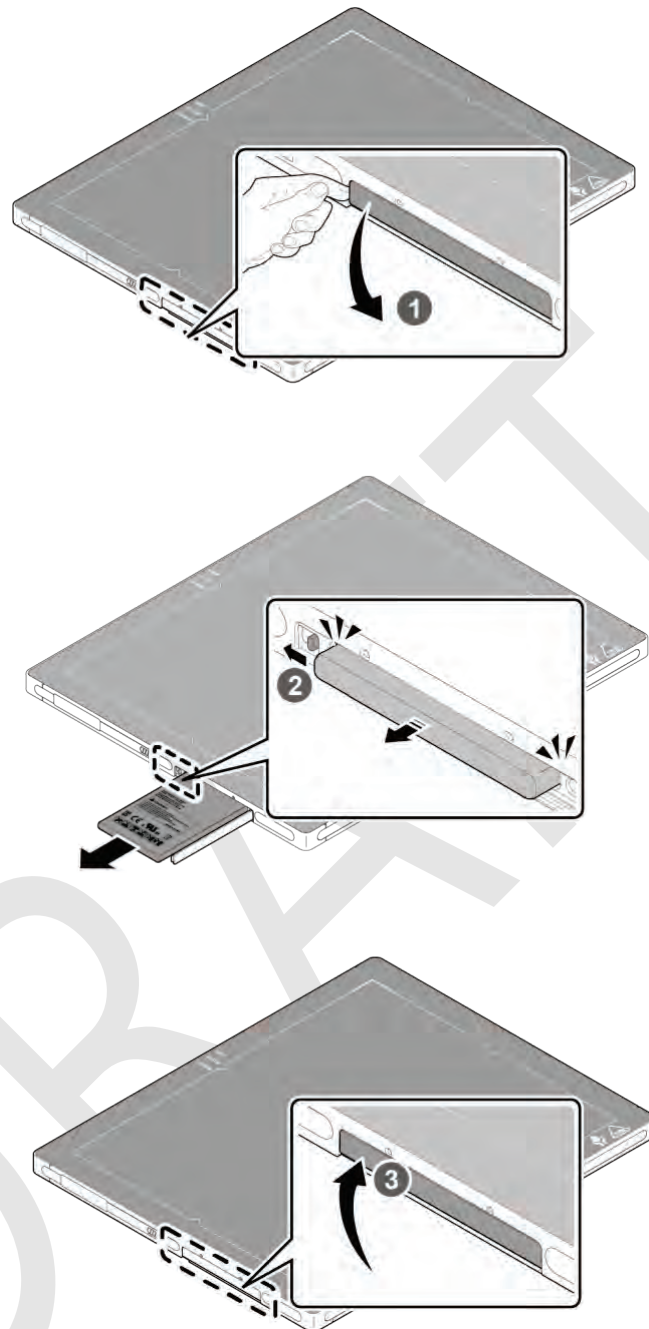

- 1 Open the battery cover.
- 2 Push the lever to the left for taking out the battery.
- 3 Close the battery cover.



- Make sure to turn off the detector by pressing and hold the power button for 3 seconds before detaching a battery pack. All status LED lamps are off and then the detector is turned off.



### 4.1.3 How to charge a battery pack

The detector is battery-operated when it is connected wirelessly. Charge the battery pack fully before inserting it to the detector.

#### Charging type 1

Supply power to the charger with the power adapter before charging a battery. When the power LED is turned to green, it means that the power is permitted.

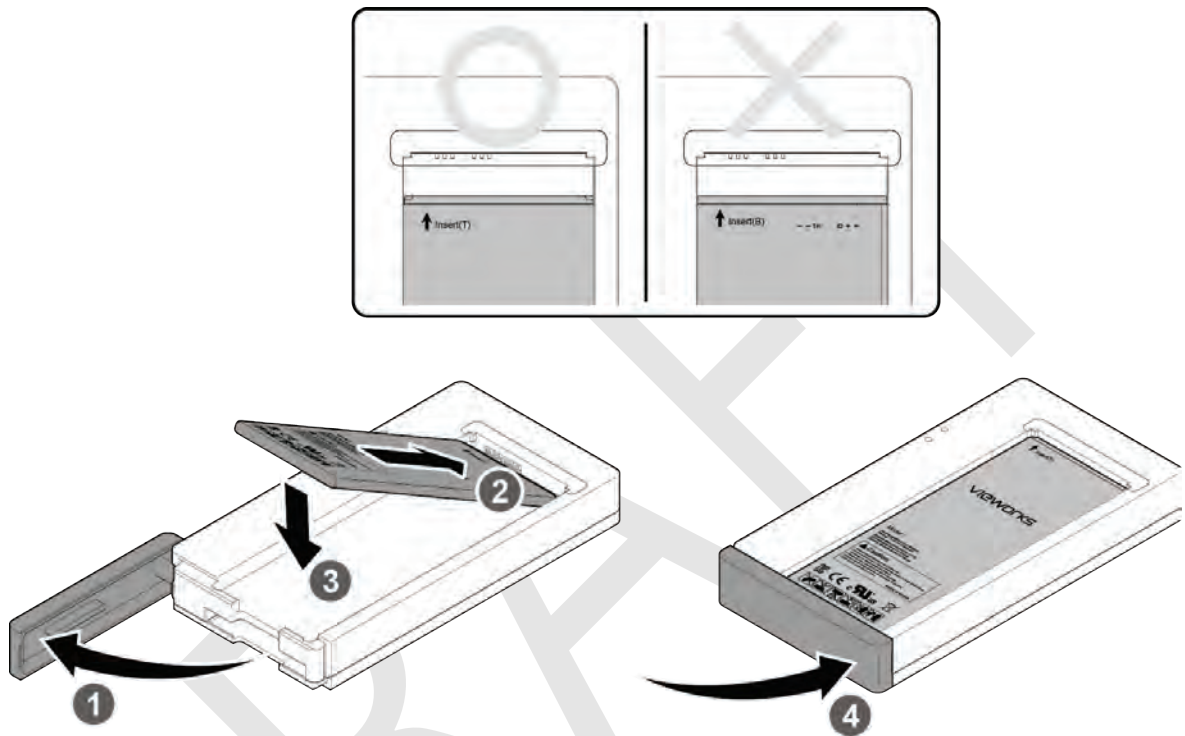

- 1 Open the cover at the lower side of charger.
- 2 Put the battery on the top of charger in the right direction.
- 3 Push the battery down until it is fixed in the charging part.
- 4 Close the cover at the lower side of charger.

	Simultaneous charging	Charging time
<b>Battery charger</b>	2 battery packs	3 hrs
<b>Tether interface cable</b>	1 battery pack	4 hrs

## Charging type 2

Supply power to the charger with the power adapter before charging a battery. When the power LED is turned to green, it means that the power is permitted.

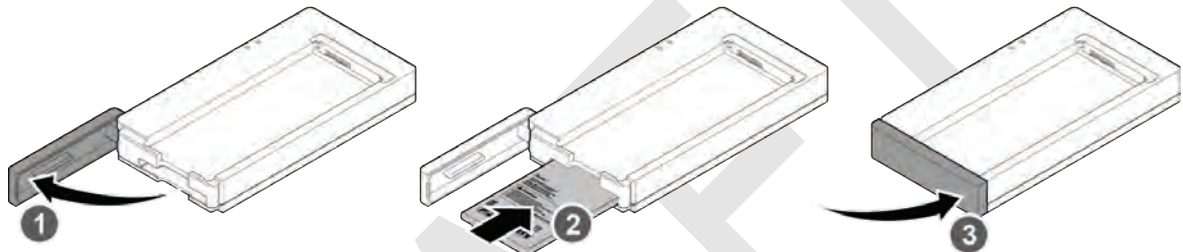
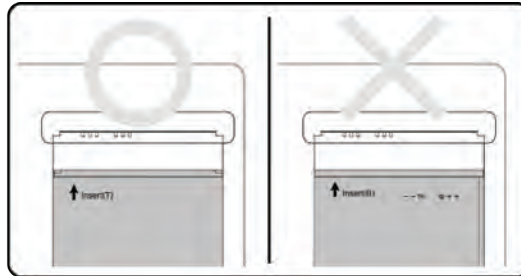

- 1 Open the cover at the lower side of charger.
- 2 Insert the battery into the slot until it clicks.
- 3 Close the cover at the lower side of charger.



- The charging time can be different depending on temperature and charging status of a battery.
- While charging a battery pack, it is available to use the detector by connecting it with a tether interface cable.



- This detector is designed to make a battery being discharged little by little during the detector is off. Therefore, remove the battery pack when the detector is not used for some time. Otherwise, over discharge may occur resulting in the shortened battery life.
- Do not use the charger around the patient.
- Charge the battery with the charger provided by Vieworks.
- Securely plug the power cord of the charger into the AC outlet. If contact failure occurs, or if dust/metal objects come into contact with the exposed metal prongs of the plug, fire or electric shock may result.
- Stop charging the battery when status LED of the charger turns to green as exceeding the specified charging time. Otherwise, the battery pack is overcharged and it causes smoke. If the battery pack is overheating, it can be exploded and a fire may occur.
- Use only a power adapter complying with IEC 60601-1 or IEC 60950-1.

## 4.2 Product Installation

### 4.2.1 Connecting Devices



- Installation of this equipment should be made by licensed and authorized personnel by Vieworks.
- This equipment must only be connected to the power with protective earth.

#### SCU Basic (FXRS-02A)

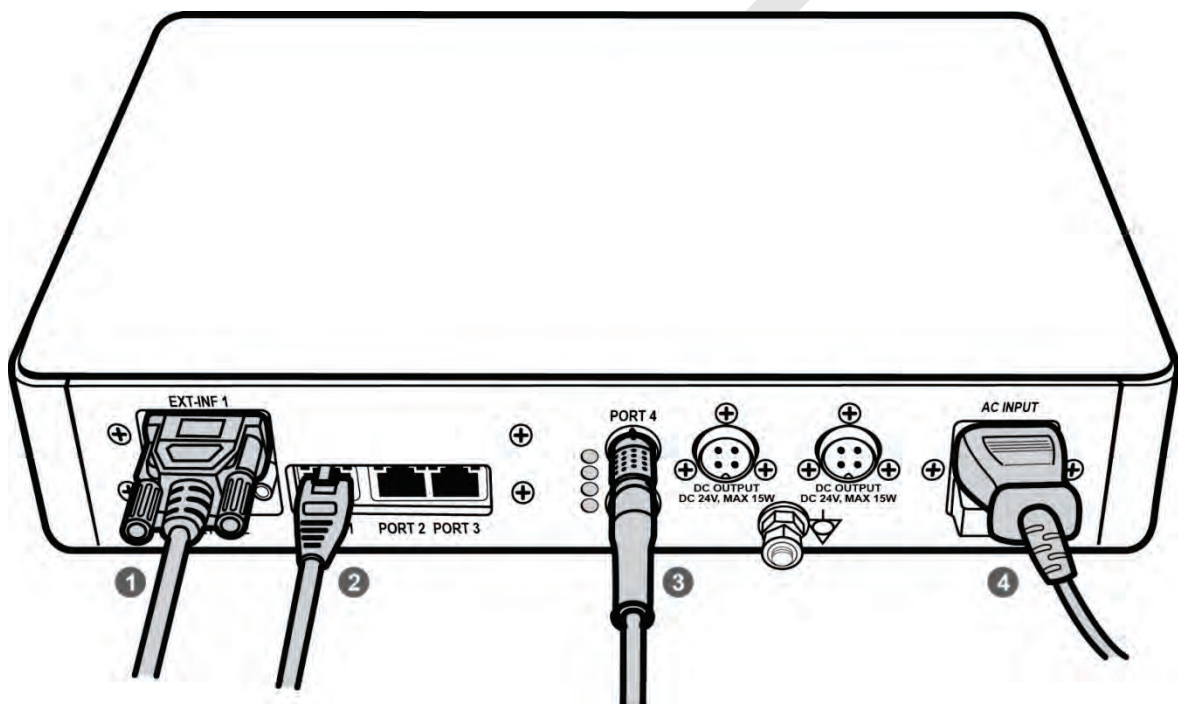

- 1 If you use the **DR Trigger** mode, connect the one end of generator interface cable to the **EXT\_INF** port of SCU, and the other to the X-ray generator.



- If you use the AED mode, a generator interface cable is not needed as the detector operates by detecting X-ray automatically.

- 2 Connect one end of the LAN cable to one of the LAN ports of SCU, and the other to the LAN Card Connector of workstation assigned for data transfer.
- 3 Connect the one end of the Tether Interface cable to the **Port 4** or **Port 5** of SCU and the other to the detector.
- 4 To supply power, connect the AC power cable to the AC power input port of SCU.

## SCU Basic (FXRS-03A)

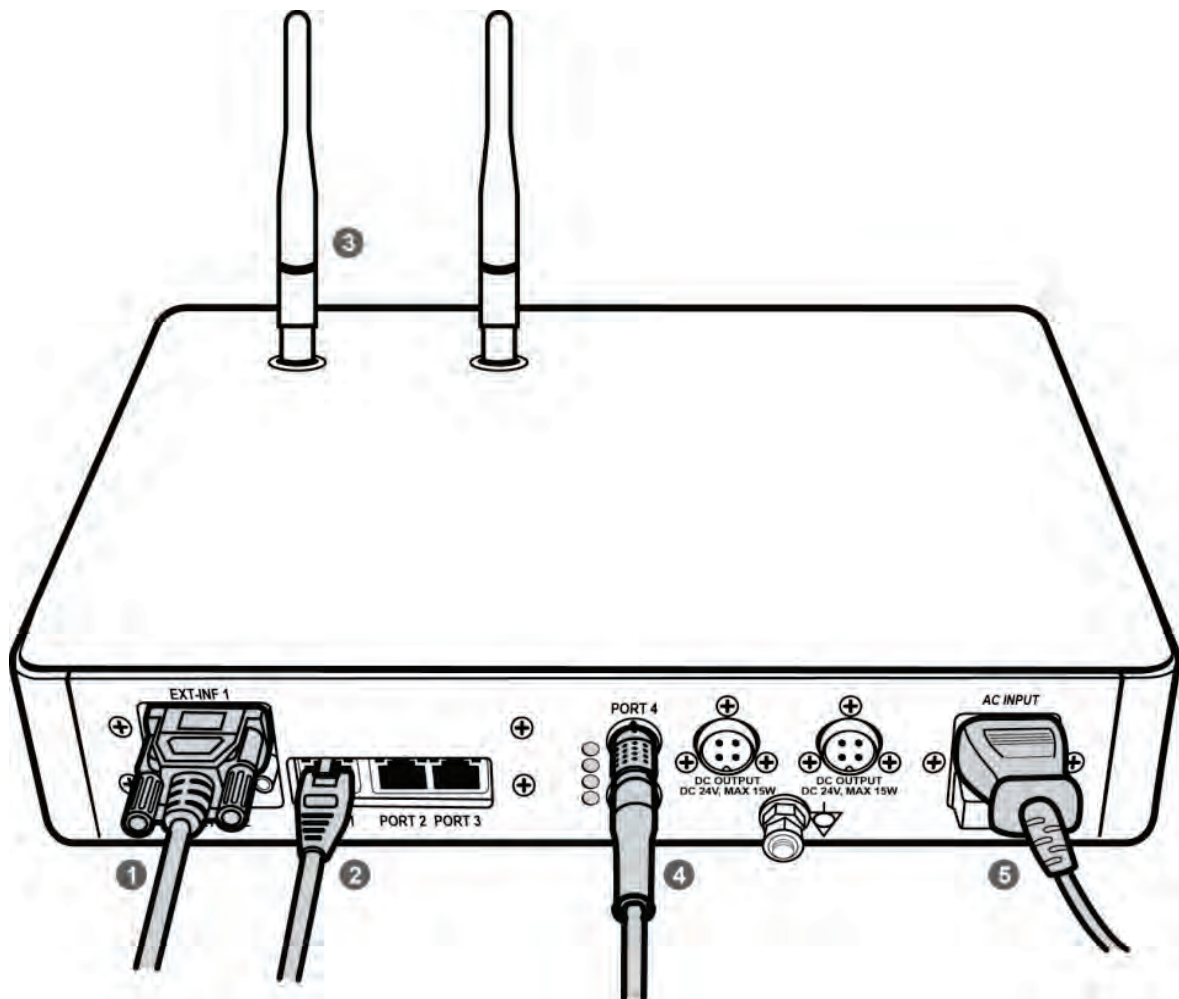

- 1 If you use the **DR Trigger** mode, connect the one end of generator interface cable to the **EXT\_INF** port of SCU, and the other to the X-ray generator.



- If you use the AED mode, a generator interface cable is not needed as the detector operates by detecting X-ray automatically.

- 2 Connect one end of the LAN cable to one of the LAN ports of SCU, and the other to the LAN Card Connector of workstation assigned for data transfer.
- 3 Stand the antenna of SCU upright.
- 4 To transmit image data using a Tether Interface, connect the one end of the Tether Interface cable to the **Port 4** or **Port 5** of SCU and the other to the detector.



- If you use the wireless communication method, a tether interface cable is not needed as the image is transmitted wirelessly.

- 5 To supply power, connect the AC power cable to the AC power input port of SCU.

## VIVIX SCU mini (FXRS-04A)

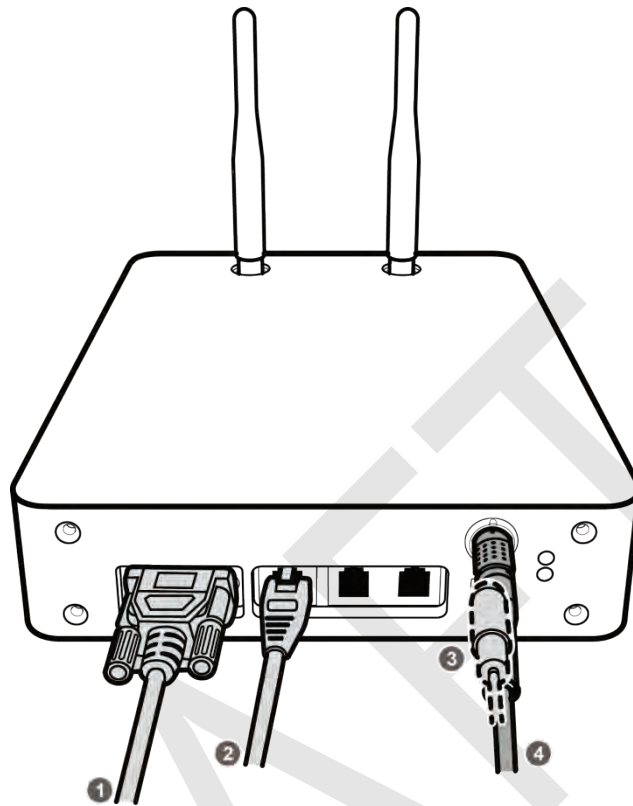

- 1 If you use the **DR Trigger** mode, connect the one end of generator interface cable to the **EXT\_INF** port of SCU mini, and the other to the X-ray generator.



- If you use the AED mode, a generator interface cable is not needed as the detector operates by detecting X-ray automatically.

- 1 Connect one end of the LAN cable to one of the LAN ports of SCU mini, and the other to the LAN Card Connector of workstation assigned for data transfer. Stand the antenna of SCU mini upright.
- 2 To transmit image data using a tether interface, connect the one end of the tether interface cable to the port of VIVIX SCU mini and the other to the detector.



- If you use the wireless communication method, a tether interface cable is not needed as the image is transmitted wirelessly.

- 3 To supply power, connect the DC power cable to the DC power input port of SCU mini.

## 4.2.2 Booting up SCU

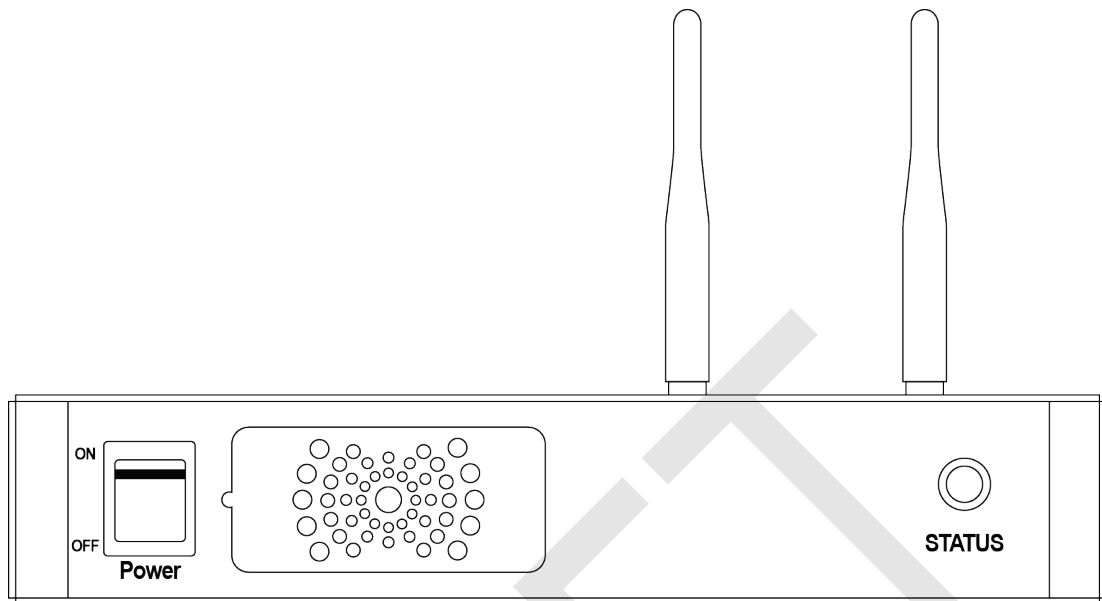

- 1 Turn on the power switch at the front side of SCU.
- 2 Check if the power switch of SCU lights up green.
- 3 Check if the status indicator is blinking in green after the power switch of SCU is permitted.
- 4 Check if the status indicator of SCU is blinking in green and turns to light up in the same color.



- When the power switch lights up green, it means that the power is applied normally.
- When the status indicator is blinking in green, the SCU is booting.
- If the status indicator lights up green, it indicates that the SCU is being operated normally after booting up.
- If the status indicator lights up blue, SCU's preparation for communication is completed.

## 4.2.3 Booting up the Detector



- The procedures in this chapter are explained according to the default setting status of a detector (factory reset) and the use of wireless connection.
- Refer to <7.4 Product Initialization> for the detailed information about the default setting status of a detector.

- 1 Attach a charged battery pack to the detector.
- 2 Press the power button of the detector for 1 second until the power LED is turned on.
- 3 When the power LED is on, check if it is lit green.
- 4 Check if the active LED is lit orange on the detector.



- If the power LED lights up green, the DC power is permitted normally.
- If the active LED lights up orange, the detector is completed to boot up normally.

## 4.2.4 Checking Status LED of Detector

### Power LED

- The power LED indicates the power status information which is permitted to the detector in green.
- The power LED lights up when the power is permitted normally.
- If the detector is connected with a tether interface, the power LED lights up when power is permitted to SCU because the detector is supplied power from SCU.

### Active LED

- The active LED indicates status information about the possibility that the detector can be used normally or not in orange.
- The active LED is blinking when the detector is completed to boot up normally.
- The Power LED is blinking when the detector turns to sleep mode.
- The active LED is blinking when the wireless communication is being initialized.















### Data LED

- The data LED indicates status information of data processing in blue.
- The data LED lights up when the detector is available to make data communication.
- The data LED is blinking while the detector transmits or saves data.
- If the detector AP is on, the LED blinks for 5 times right after the booting.





### Detector AP LED

- The AP LED lights up in blue when the detector AP is on.
- The AP LED is blinking in blue when the detector switches the AP status.
- The AP LED is blinking in orange while the detector is synchronizing the wireless settings.
- The communication status of detector is indicated when the detector AP is off.
  - Wireless communication: Green LED at the 3<sup>rd</sup> level or higher / Orange LED under 2<sup>nd</sup> level.
  - Wired communication: Green LED in case of 1Gbps / Orange LED in case of 100Mbps connection.

### Summary List of Detector Status LED

Information	Power LED	Status LED	Data LED
In process of booting after the power permission	 Blink	OFF	OFF
Bootng completed (Abnormal)	 ON	-	-
Bootng completed (Normal)	 ON	 ON	OFF
Ready for communication	 ON	 ON	 ON
Sleep Mode	 ON	 Blink	OFF
In process of wireless initialization	 ON	 Blink	OFF
Data Communication (Send or Store)	 ON	 ON	 Blink
Power OFF	OFF	OFF	OFF

### Summary list of the Detector AP LED

Information	Detector AP LED
Detector AP OFF (Communication status: Good) <ul style="list-style-type: none"> <li>• Wireless communication: 3<sup>rd</sup> level or higher</li> <li>• Wired communication: 1000Mbps</li> </ul>	 ON
Detector AP OFF (Communication status: Normal) <ul style="list-style-type: none"> <li>• Wireless communication: Under 2<sup>nd</sup> level</li> <li>• Wired communication: 100Mbps</li> </ul>	 ON
Detector AP ON	 ON
Switching the status of detector AP	 Blink
The wireless setting is being synchronized	 Blink
Power OFF	OFF



- If the LED blinks abnormally, refer to <8 Troubleshooting> to check if communication or system error is occurred.



### 4.3 Software Installation

This section gives information about how to install the software on the workstation (PC) and how to configure the environment for software operation and communication.



- Check suitability of acquiring, processing and adjusting of images by referring to the recommended workstation specifications before the software installation.

#### 4.3.1 Software Classification

Vieworks provides clients who purchase our detector system with software as below. You can choose and use one of our softwares below.

Software	Description
<b>VXvue</b>	<ul style="list-style-type: none"> <li>• A program for acquiring and adjusting images developed by Vieworks.               <ul style="list-style-type: none"> <li>▫ Used for <b>ViVIX-S</b> detectors only.</li> </ul> </li> <li>• Unnecessary to develop a separate viewer program.</li> </ul>
<b>VIVIX Setup</b>	<ul style="list-style-type: none"> <li>• A program for setting and managing the detector and SCU.</li> </ul>
<b>VXvue (Viewer)</b>	<ul style="list-style-type: none"> <li>• Software for acquiring, adjusting and managing the image.</li> </ul>
<b>XIPL</b>	<ul style="list-style-type: none"> <li>• Image processing program</li> </ul>
<b>Document</b>	<ul style="list-style-type: none"> <li>• VXvue Operation Manual</li> <li>• XIPL User Manual</li> </ul>
<b>VIVIX SDK</b>	<ul style="list-style-type: none"> <li>• Software development kit for <b>ViVIX-S</b> detector only, provided by Vieworks.</li> <li>• You can develop your own software dedicated to <b>ViVIX-S</b> by using this kit.</li> </ul>
<b>SDK Package</b>	<ul style="list-style-type: none"> <li>• Development package</li> </ul>
<b>VIVIX Setup</b>	<ul style="list-style-type: none"> <li>• A program for acquiring, adjusting and managing the image.</li> </ul>
<b>Document</b>	<ul style="list-style-type: none"> <li>• VIVIX SDK Developer Manual</li> </ul>

#### 4.3.2 Software Installation

- For a client who uses **VXvue**, install the **VXvue** program after reading **VXvue Operation Manual** carefully.
- For a client who uses **VIVIX SDK**, install the **Setup** program after reading **VIVIX SDK Developer Manual**.



- Be sure to install the software first with reading this manual before configuring Windows environment.



- Apart from the detector and SCU, the software can be installed separately.

## 4.4 Windows Environment Setting

This section gives information about configuring Windows to communicate with the detector and SCU after installing the **Setup** program or Viewer.



- The contents in this chapter are made on the basis of **Windows 7**.
- Configuration environment can be different depending on network adaptor manufacturer or models.

### 4.4.1 Network Configuration



- Communication disruption between the detector (Or SCU) and workstation occurs unless the network adaptor is properly set, it may cause serious repercussion to the product and image quality.

#### Selecting Network Adaptor

- 1 Click **Start** → **Control Panel** → **Network and Internet** → **Network and Sharing Center** → **Change Adapter Setting**.
- 2 Choose the network adaptor for communicating with the detector and SCU, and then rename it.

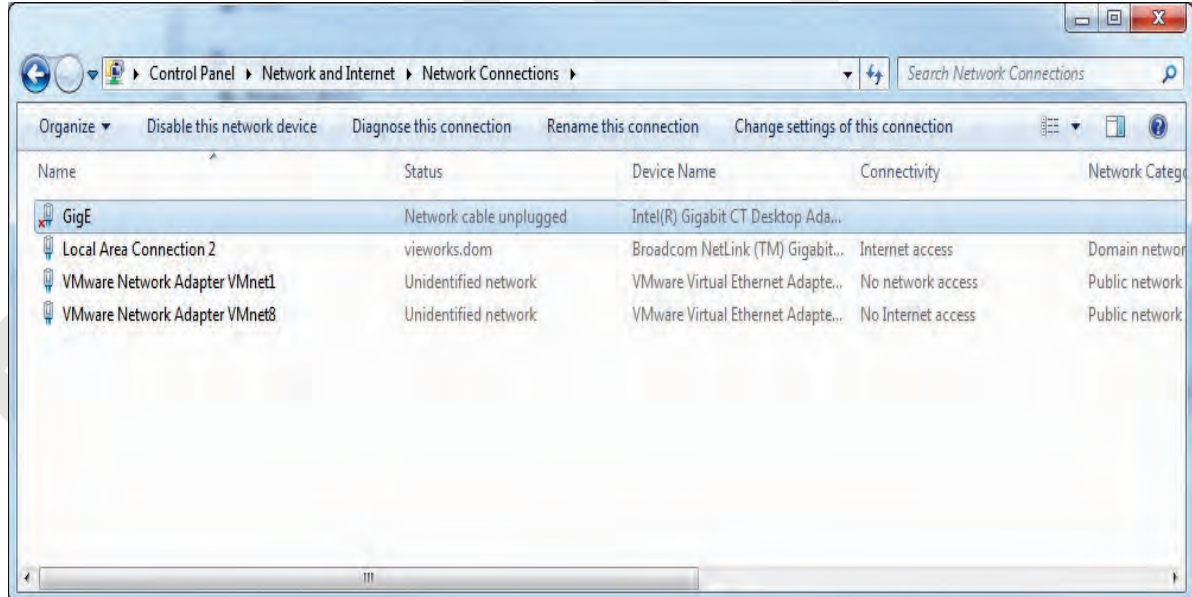

- It is recommended to change the name of network adaptor to distinguish it from other connection names.
- Even though the name is changed, it will not affect to the operation and communication performance of the equipment.

- 3 Click the chosen network adaptor with the right mouse button and click **Properties** to display the **Properties** window.

## Setting Network Adaptor

- 1 Click **Configure** button to open the following dialog box, and then go to the **Advanced** tab.
- 2 Set **Jumbo Packet** to the maximum value. (Recommended value: 9014 Bytes)

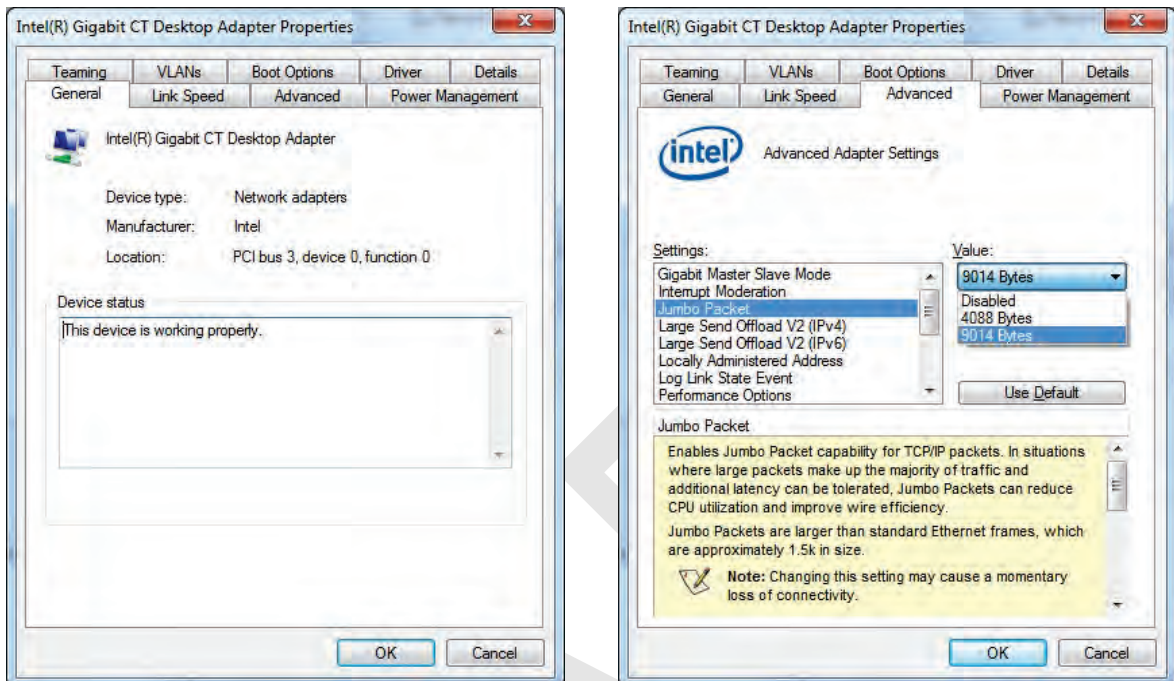

- 3 Choose **Performance Options** in the list of **Settings** and click **Properties** button on the right.
- 4 Choose **Flow Control** in the list of **Settings** and select **Rx & Tx Enabled** on the **Value** list as shown below.

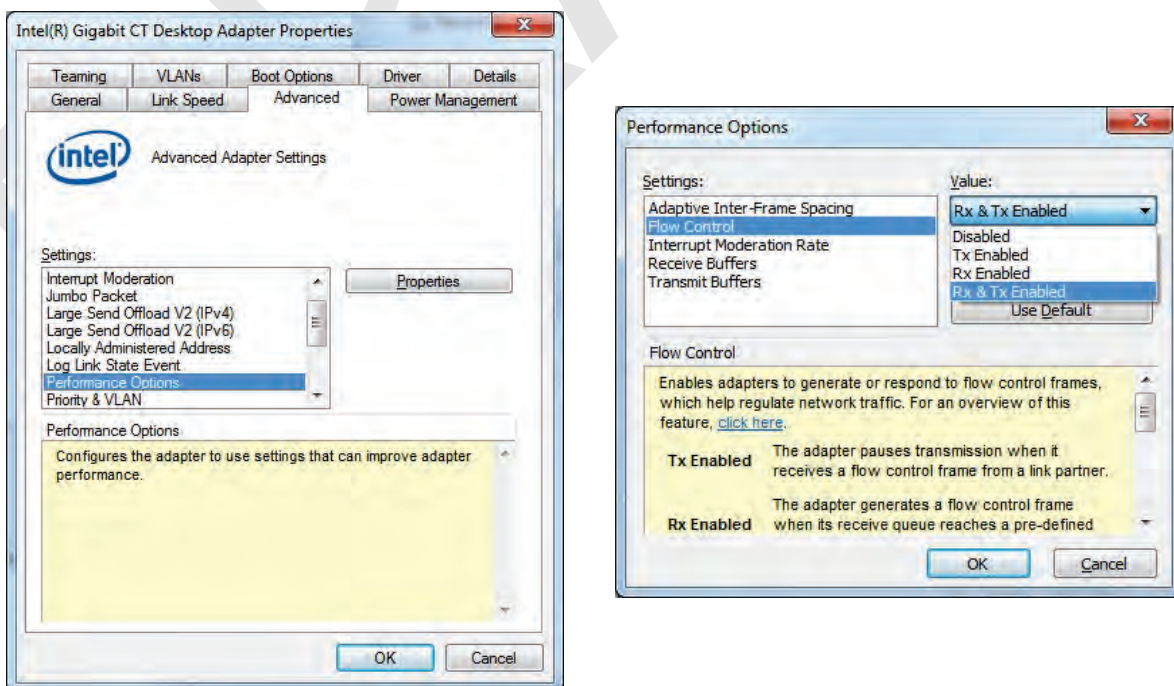

- 5 Choose **Interrupt Moderation Rate** in the list of **Settings** and select **Extreme** on the **Value** list as shown below.
- 6 Choose **Receive Buffers** and set it to the maximum value.
- 7 Click **OK** button.

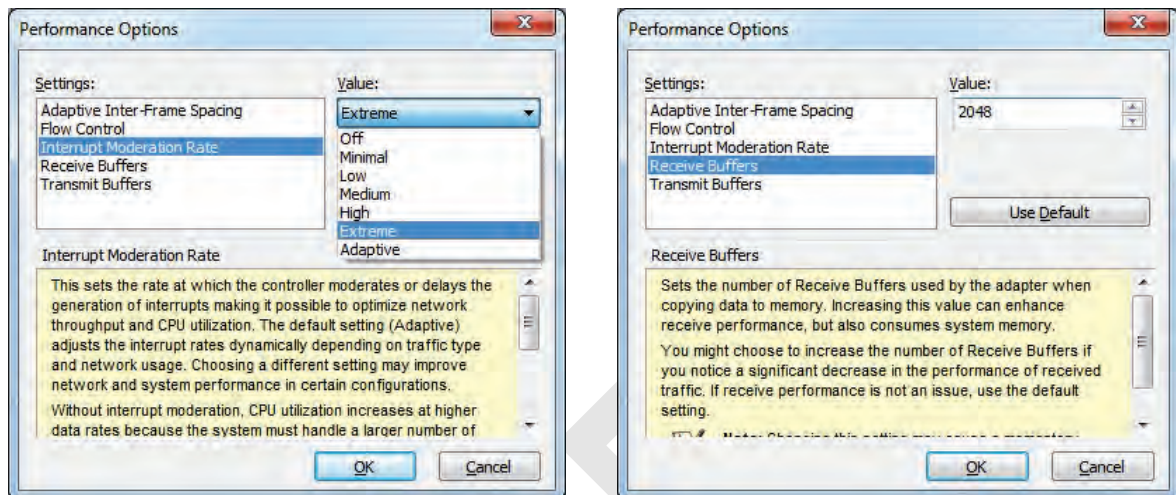

### Deactivate Power-Saving Mode on Network Adaptor

- 1 Click the **Power Management** tab and uncheck **Allow the computer to turn off this device to save power**.
- 2 Click **OK** button.

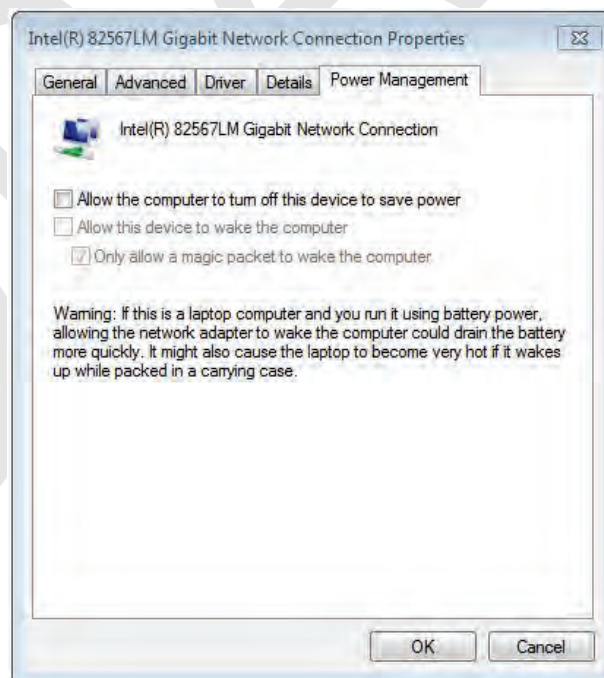

- Viewer may not work normally if the power save mode is activated.
- Deactivate the power save mode of all the installed network adaptors.



### Protocol Selection and IP Address Setting

- 1 Choose **Internet Protocol Version 4 (TCP/IPv4)** and click **Properties** button.
- 2 Input the IP address and subnet mask as shown below, and then click **OK** button.

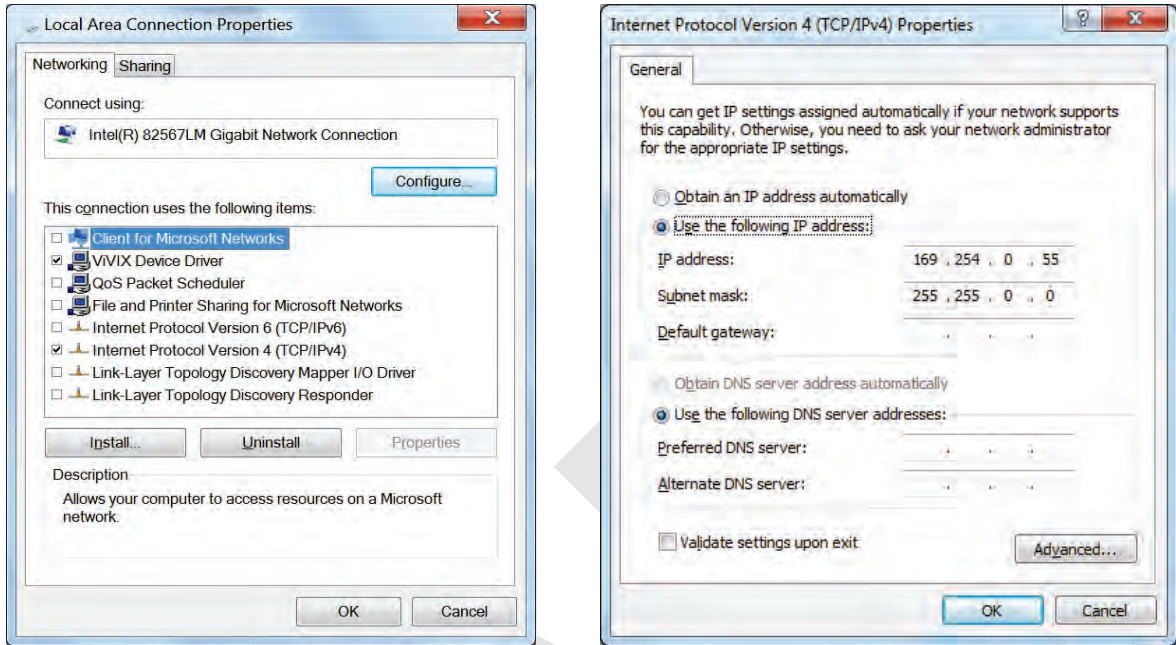

- **ViVIX Device Driver** is the image filter driver for acquiring images from a detector.
- It is recommended to uncheck the other items on the list except for **ViVIX Device Driver** and **Internet Protocol Version 4(TCP/IPv4)**, since they are not related with the detector communication.

### Summary of Network Configuration

Item	Value
Jumbo Packet	Maximum or 9014 Bytes
Flow Control	Rx & Tx Enabled
Interrupt Moderation Rate	Extreme
Receive Buffers	Maximum
Allow the computer to turn off this device to save power	Unchecked
IP Address	169.254.0.(50 ~ 254)
Subnet Mask	255.255.0.0

- It is recommended to set the IP address and subnet mask within the range presented in this document.
- If you use IP address and subnet mask out of the suggested range, it could be difficult to identify and resolve the cause of communication disorder.

## 4.4.2 Disabling Sleep Mode of Monitor



- If you use the sleep mode, viewer may not work normally.

- 1 Click **Start** → **Control Panel** → **Power Options** and then move to the **Choose when to turn off the display** tab.
- 2 Set **Put the computer to sleep** to **Never** to disable the sleep mode.
- 3 Click **Save changes** button.

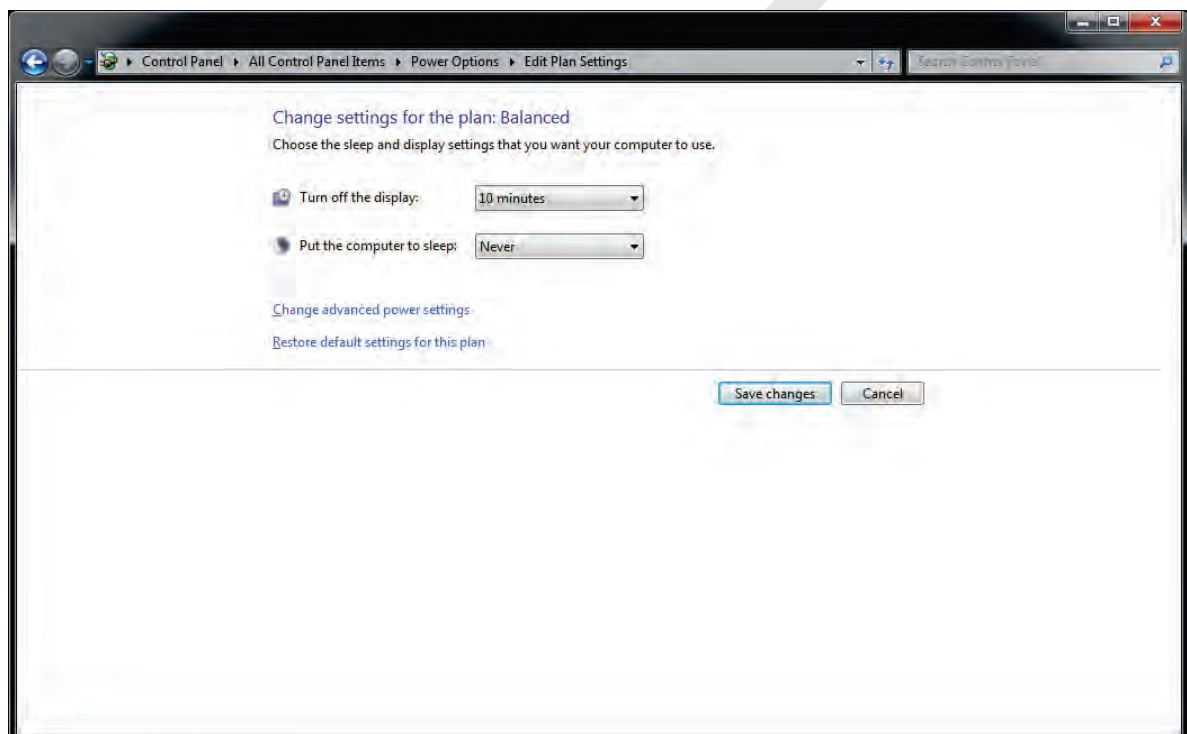

---

## 5. Setting

---

This section gives information about the product setting with using the Setup program.

Start Setting

SCU Setting

Detector Setting

Changing the Wireless Setting

## 5.1 Start Setting

### 5.1.1 Setup Program

The **VIVIX Setup** program provides functions for setting and managing the internal data to make **VIVIX-S 1012N** wireless detector and SCU work normally. In addition, The **VIVIX Setup** program has diagnostic function for checking performance and abnormality of the devices as well as the image calibration function for improving the image quality.

### 5.1.2 Checking Devices

- Check information of the detector and SCU displayed on the **Discovery** list.

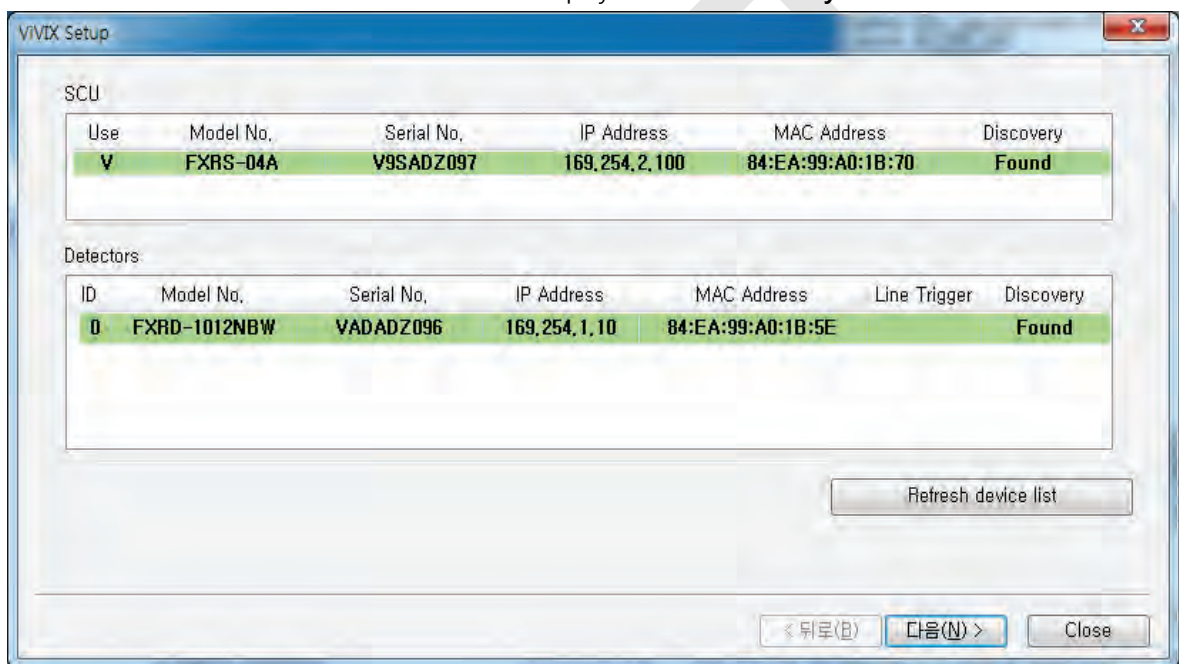

- Click **Refresh Device List** button to make the **VIVIX Setup** program search all detectors and SCU connected with the same network again. If devices are not displayed, check the power connection of the detector and click **Refresh Device List** button again.

#### List Information

List	Description
<b>SCU</b>	Displays discovered list of SCU devices.
<b>Use</b>	Double-click the option to decide whether to use SCU or not. 'V' is displayed when it is able to be used.
<b>Discovery</b>	Displays whether SCU is found out or not.
<b>Detectors</b>	Displays discovered list of detectors. (Max. 4)
<b>ID</b>	ID of detector(sequence to distinguish registered detector)
<b>Line Trigger</b>	Selects a pin group when using Line Trigger.
<b>Discovery</b>	Displays whether the detector is discovered or not.



Common	
<b>Model No.</b>	Model name of SCU or detector
<b>Serial No.</b>	Serial number of SCU or detector
<b>IP Address</b>	IP Address of SCU or detector
<b>MAC Address</b>	MAC Address of SCU or detector



- The default IP address of SCU is 169.254.2.100.
- The default IP address of detector is 169.254.1.10.
- You can change the IP Address of detector or SCU. Refer to **Change Configuration** on the next page.
- MAC address is a unique identifier of the network device. Do not change it randomly.
- To change order of registered detectors' ID, select an item and click ↑/↓ buttons.



- If detectors which have same IP address are connected at the same time, the address is changed automatically to prevent address collision.

### Color and Font

Information	Description
<b>Green background</b>	Registered status. Available to get into the device.
<b>White background</b>	Non-registered status. Unavailable to get into the device.
<b>Bold font</b>	Connected status. The device is connected.
<b>Gray background / font</b>	Disconnected status. The device has been connected, but is disconnected now.



- The device is changed to the registered or non-registered status by double-clicking the device name or clicking **Select** or **Release** button.

### Change Configuration

Select the SCU or detector name and click the right mouse button to change its setting.

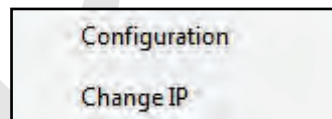

Menu	Description
<b>SCU</b>	-
<b>Configuration</b>	Changes the setting information of SCU.
<b>Change IP</b>	Changes IP address of SCU.
<b>Detector</b>	-
<b>Release</b>	Releases the detector to non-registered status.
<b>Change IP</b>	Changes IP address of the detector.

### 5.1.3 Getting into the Devices

Click **Next** button to enter the registered SCU and detector. You can use SCU and the detector normally when the **Status** of SCU is **Connected** and the **Status** of detector is **Initialization OK**.

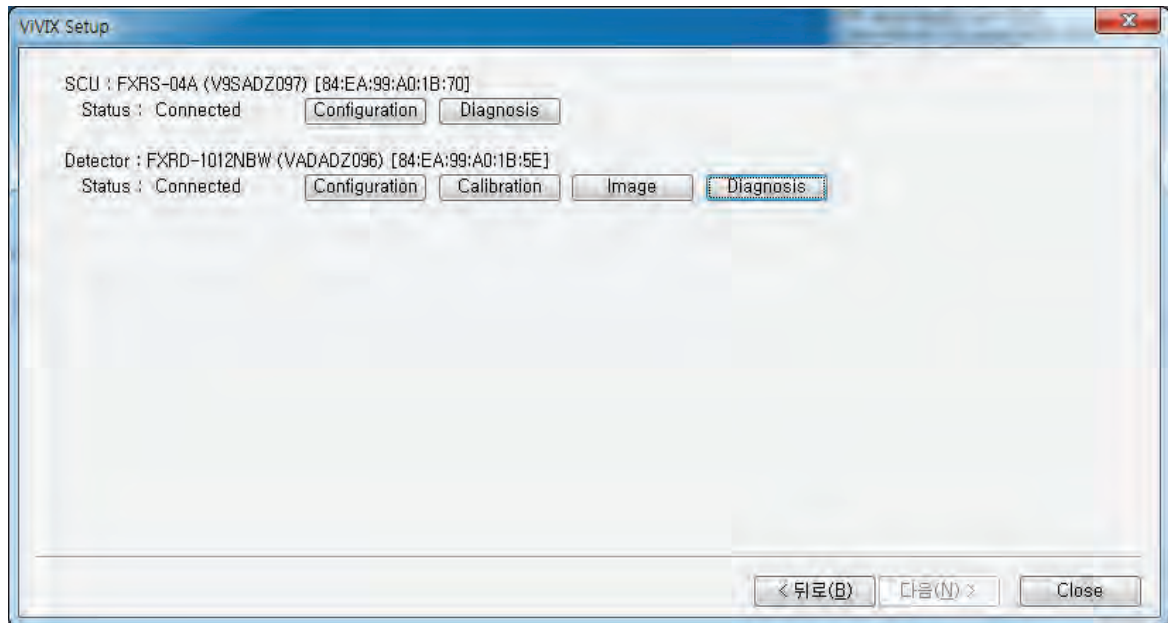

#### Button

Button	설명
<b>SCU</b>	
<b>Configuration</b>	Checks and sets information of SCU setting.
<b>Diagnosis</b>	Checks information of wireless AP on SCU and performs the self-diagnosis.
<b>Detector</b>	
<b>Configuration</b>	Checks and changes the information of detector settings.
<b>Calibration</b>	Checks and calibrates the detector calibration data.
<b>Image</b>	Checks and diagnoses the detector and acquired image.
<b>Diagnosis</b>	Checks the information of detector and tests the wireless transmission function as well as performs the self-diagnosis.

## 5.2 SCU Setting

### 5.2.1 SCU Configuration

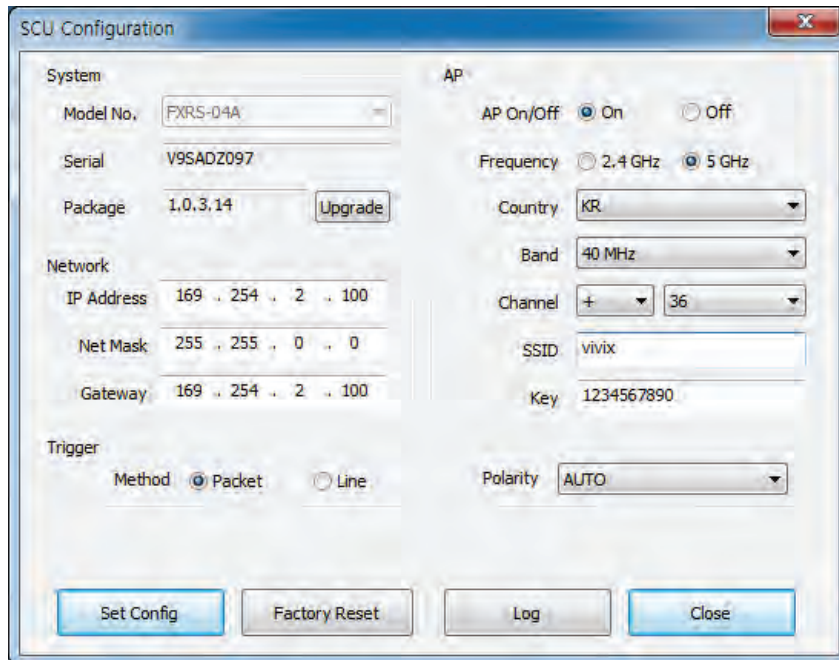

#### System

Checks and sets system information of SCU.

Item	Description
Model No	SCU model name
Serial No	SCU serial numbers
Package	Version information of SCU firmware package

#### Network

Checks and sets network information of SCU.

Item	Description
IP Address	IP address of SCU.
Net Mask	Subnet Mask of SCU.
Gateway	Gateway of SCU.

**AP**

Checks and sets AP (Access Point) information of SCU.

Item	Description
<b>AP On / Off</b>	Selects whether to use SCU AP (Access Point) mode or not.
<b>On</b>	Turns on SCU AP
<b>Off</b>	Turns off SCU AP
<b>Frequency</b>	Frequency channel of wireless network.
<b>2.4 GHz</b>	Uses 2.4 GHz Frequency. (13 channels)
<b>5 GHz</b>	Uses 5 GHz Frequency. (8 channels)
<b>Country</b>	Country code of using wireless network. (KR, US, EU, JP, CN)
<b>Band</b>	Wireless network bandwidth.
<b>20 MHz</b>	Default frequency band.
<b>40 MHz</b>	Expands bandwidth through channel bonding.
<b>Channel</b>	Wireless communication channel
<b>SSID</b>	Unique ID for wireless communication
<b>Key</b>	Unique key for wireless communication (Applied to the password only.)



- **13** channels can be used in 2.4 GHz Frequency.
- **8** channels can be used in 5 GHz Frequency
- The number of serviceable channels is different according to the configured country.
- Channel bonding is used for enhancing transmission speed. However, the speed may be slowed down due to the interference of surrounding channels, even if the channels have been bonded.
- Channel items (+/-) will be activated in case of using **40MHz** frequency bandwidth. You can set whether to bond channels with the above or below one.
- **SSID** and **Key** values of the detector communicated with SCU should be set as the same.



- Set **SSID** and **Key** values not to be duplicated with those of the peripheral system.
- **SSID** and **Key** values should be input as capital / small alphabet letters, numeric characters and only "-", "\_" among special letters up to **20**.
- Wireless network setting should be done by an engineer who understands the wireless communication and its related technique. Unless the network is set properly, a communication error would occur or the image quality would be affected.

## Trigger

Configures trigger information for integration between SCU and X-ray generator.

Item	Description
<b>Method</b>	Trigger mode
<b>Packet</b>	Software Trigger mode
<b>Line</b>	Hardware Trigger mode
<b>Polarity</b>	Polarity of trigger signal
<b>Auto (Default)</b>	Recognizes polarity automatically and handles it. (Default value)
<b>Active High</b>	Handles polarity of Active High
<b>Active Low</b>	Handles polarity of Active Low



- Configuration value of trigger is applied only when Exposure mode is set **DR Trigger**. Configuration value of trigger is not applied when using **AED** mode.



- The setting of Trigger should be done by an engineer who understands about the x-ray generator device well. Unless the device and detector are set correctly, an integration error of x-ray generator would occur or the system operation would be affected.

## Command Buttons

Item	Description
<b>Set Config</b>	Updates by transmitting current setting values to SCU.
<b>Factory Reset</b>	Resets SCU to factory default settings.
<b>Log</b>	Checks the logs of SCU.
<b>Close</b>	Closes the window of <b>SCU Configuration</b> . If <b>Set Config</b> is not performed, the changed setting value is not transmitted to SCU.

## 5.2.2 SCU Diagnosis

### Self Diagnosis

You can perform self diagnosis to check operational status of the parts in SCU. Refer to <7.2 Product Inspection> for the corrective measures on the result of each item.

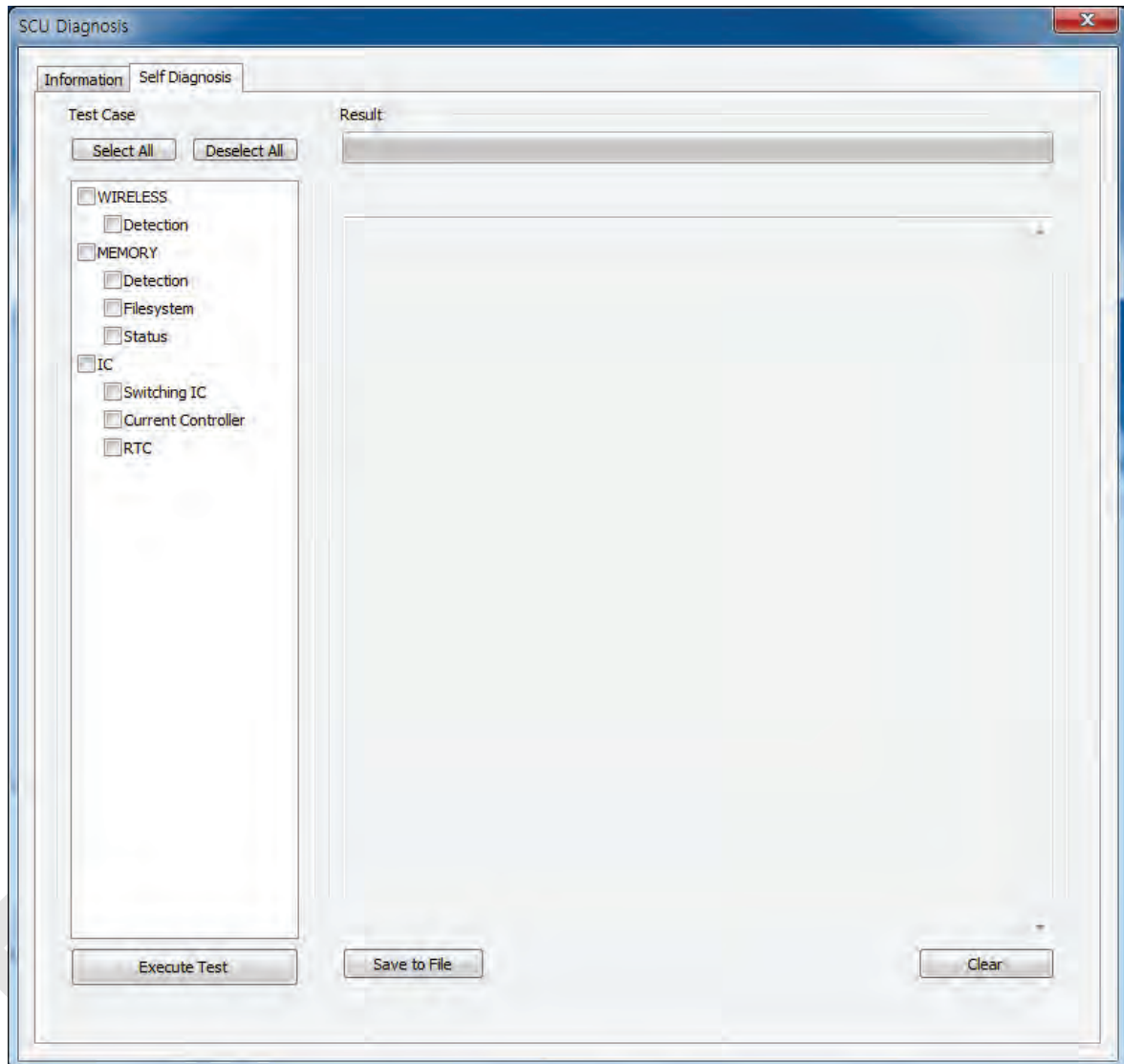

## 5.3 Detector Setting

### 5.3.1 Detector Configuration

The screenshot shows the 'Detector Configuration' window with the following settings:

- System:** Model No. FXRD-1012NBW, Serial VADADZ096, Package 1.0.3.14 (Upgrade button).
- Network:** IP 169.254.1.10, NetMask 255.255.0.0, Gateway 169.254.2.100.
- WNetwork:** SSID vivix, Key 1234567890.
- Wireless Only:** Off.
- Image:** Timeout 20 sec, Preview Disable.
- AP:** AP Off, Frequency 5 GHz, Country KR, Band 40 MHz, Channel 36, SSID vivix\_ap, Key 1234567890.
- Power Mode:** Sleep Off, Sleep after 10, Shut Down Off, Shut Down after 30.
- Power Control:** by Detector.

Buttons at the bottom: Set Config, Factory Reset, Log, Close.

#### System

Checks and sets system information of the detector.

Item	Description
<b>Model No</b>	Detector model name
<b>Serial No</b>	Detector serial numbers
<b>Package</b>	Version information of the detector firmware package

#### Network

Checks and sets network information of the detector.

Item	Description
<b>IP Address</b>	IP address of the detector
<b>Net Mask</b>	Subnet Mask of the detector
<b>Gateway</b>	Gateway of the detector

## WNetwork

Sets AP (Access Point) information of wireless communication from the detector.

Item	Description
<b>SSID</b>	Configures wireless network ID AP from the detector.
<b>Key</b>	Configures wireless network key value of AP from the detector.
<b>Wireless Only</b>	Configures the wireless communication method of the detector.
<b>On</b>	The detector is operated in a wired way when a tether interface cable is connected.
<b>Off</b>	The detector is operated in a wireless way when a tether interface cable is not connected.

## AP

Checks and sets AP (Access Point) of detector information.

Item	Description
<b>AP On / Off</b>	Decides whether to run the detector on AP (Access Point) mode.
<b>On</b>	Turns on the detector AP
<b>Off</b>	Turns off the detector AP
<b>Frequency</b>	Frequency channel of wireless network
<b>2.4 GHz</b>	Uses 2.4 GHz Frequency. (Up to 13 channels)
<b>5 GHz</b>	Uses 5 GHz Frequency. (Up to 8 channels)
<b>Country</b>	Country code of wireless network (KR, US, EU, JP, CN)
<b>Band</b>	Wireless network bandwidth
<b>20 MHz</b>	Basic Frequency Band
<b>40 MHz</b>	Expands bandwidth through channel bonding.
<b>Channel</b>	Wireless network channel
<b>SSID</b>	Wireless network ID
<b>Key</b>	Wireless network key value (Applied to the password only.)



- **13** channels can be used in 2.4 GHz Frequency.
- **8** channels can be used in 5 GHz Frequency
- The number of serviceable channels is different according to the configured country.
- Channel bonding is used for enhancing transmission speed. However, the speed may be slowed down due to the interference of surrounding channels, even if the channels have been bonded.
- Channel items (+/-) will be activated in case of using **40MHz** frequency bandwidth. You can set whether to bond channels with the above or below one.
- **SSID** and **Key** values of the detector for communicating with SCU wirelessly (WNetwork) should be set as the same.





- Set **SSID** and **Key** values not to be duplicated with those of the peripheral system.
- **SSID** and **Key** values should be input as capital / small alphabet letters, numeric characters and only "-", "\_" among special letters up to **20**.
- Wireless network setting should be done by an engineer who understands the wireless communication and its related technique. Unless the network is set properly, a communication error would occur or the image quality would be affected.

## Image

Checks and sets the time limit of image transmission as well as decides whether to use the **Preview** item.

Item	Description
<b>Time (sec.)</b>	The limited time of completing image transmission.
<b>Preview (Enable / Disable)</b>	Sets whether to use the wireless communication way for sending preview images.



- After starting image transmission, the detector ignores the information of image re-transmission request if the following conditions are fulfilled.
  - If the time limit of image transmission does not exceed.
  - If the image is not transmitted completely.

## Power Mode

Checks and sets the management information about the power of detector.

Item	Description
<b>Sleep</b>	Decides whether to use the sleep mode function of the detector. ( <b>On / Off</b> )
<b>Sleep after (min.)</b>	If the detector is not used for the specific setting time, it is turned to the sleep mode. This mode activates only when the sleep mode is set. (10 / 15 / 20 / 25 / 30 min.)
<b>Shut Down</b>	Sets whether to use the shut down function in the detector. ( <b>On / Off</b> )
<b>Shut Down after (min.)</b>	The power of detector is off if it is not used within the setting time. This menu is activated while the Shut Down function is used. (30 / 60 / 90 / 120 min.)
<b>Power Control</b>	Sets standards of power supply to the detector.
<b>by Detector</b>	The detector is operated by power from SCU and battery. If the power from SCU and battery is blocked, the detector is turned off.
<b>by SCU</b>	The detector is operated by power from SCU with connecting a tether cable. If the power from SCU is blocked, the detector is turned off.



- You can prevent unnecessary battery consumption by using the **Sleep** function.
- When SCU supplies power to the detector with connecting a tether interface cable, the **Shutdown** function cannot be operated.
- If **Power Off** is set to **by Detector** and the tether interface cable is disconnected, you can keep using the detector by the power of battery. In this case, you can turn off the detector by pressing the power button for 3 seconds.



- If **Power Off** is set to **by SCU**, the battery cannot supply power to the detector. In this case, you should connect the tether interface cable to supply power of SCU to the detector.
- Wireless network setting should be done by an engineer who understands the wireless communication and its related technique. Unless the network is set properly, a communication error would occur or the image quality would be affected.

### 5.3.2 Detector Power Save Function

The consumption of a battery pack can be reduced by using the power save function.



- The power save function is operated only when the battery supplies power to the detector. In other words, the power save function cannot be operated if a tether interface cable supplies power to the detector.

#### Mode

Mode	Meaning
<b>Normal</b>	The detector can be operated and take an image at any time.
<b>Sleep</b>	The detector cannot be operated. User can take an image by disabling the Sleep mode.
<b>Shut Down</b>	The detector has been turned off. User can take an image after the detector is rebooted.

#### Entry Condition of Power Save Mode

Mode	Meaning
<b>Normal</b>	-
<b>Sleep</b>	The detector turns to sleep mode if not used for the setting time (Sleep after). The detector is turned off if not used for the setting time (Shutdown after) under the sleep mode. However, if the detector is not used for the setting time (Shutdown after) under the sleep off state, the detector is turned off.
<b>Shut Down</b>	

#### Checks Power Save Mode

Mode	Meaning
<b>Normal</b>	All LED lamps are turned on. Power LED (Green) is blinking.
<b>Sleep</b>	VXvue (Vieworks Viewer) indicates the state of sleep mode. VIVIX SDK indicates the state of sleep mode.
<b>Shut Down</b>	All LED lamps are turned off.

### Setting Items of Power Save Function

Mode	Meaning
Normal	-
Sleep	Selects the function <b>On</b> (use) or <b>Off</b> (not use).
Sleep after (min.)	Sleep mode is activated if the detector is used during the setting time.
Shut Down	Selects the function <b>On</b> (use) or <b>Off</b> (not use).
Shutdown after (min.)	The detector is turned off if it is not used during the setting time. This menu is activated while the Shut Down function is used. (30 / 60 / 90 / 120 min.)

### Disabling Power Save Function

Mode	Meaning
Normal	-
Sleep	Turns off sleep mode from VXvue (Vieworks Viewer). Calls the function from VIVIX SDK to turn off sleep mode.
Shut Down	Reboots the detector by pressing a power button on the detector.

### Other Information

Mode	Default value	Turnaround time	Power consumption
Normal	-	-	24V, 300mA (Standby) 24 V, 600mA (While taking images)
Sleep	OFF / 10min.	Approx. 10 sec.	24V, Max. 150mA
Shut Down	OFF / 30min.	Approx. 15 sec.	-

## 5.4 Changing the Wireless Setting

### 5.4.1 Switching to the Detector AP Mode

You can change the detector mode as AP by following the two ways.

- Choose the AP option as **On** or **Off** from the **Detector Configuration** dialog in **VIVIX Setup** program.

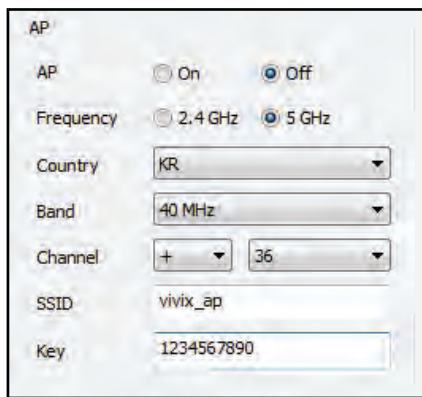

- Press the **AP** button on the detector for 5 seconds to set the **Detector AP** mode. The LED of detector AP blinks in a blue color while the mode is being switched, and turns on blue after the mode is completed to be set.

### 5.4.2 Synchronizing the Wireless Setting

Synchronize the wireless setting with a tether interface cable as follows.

- 1 Connect the detector and SCU with a tether interface cable.
- 2 Press the detector AP button for 5 seconds after the detector is turned on.
- 3 The LED of detector AP blinks while processing synchronization.
- 4 The sync information is saved automatically after it is transmitted to the detector where SSID and KEY of SCU are connected.
- 5 The detector is switched to the wireless communication mode.

---

## 6. Calibration

---

This chapter gives information about the calibration methods after installing a detector.

Calibration Dialogue

Detector Configuration

Calibration Guide

Calibrating by Loading the Calibration Data

Direct Calibration

## 6.1 Calibration Dialogue

Use the following menus to configure the system and process calibrations.

Menu	Description
<b>System Configuration</b>	Configures the exposure mode, exposure-related time and Gain type.
<b>Offset Calibration</b>	Processes Offset calibration.
<b>Defect Calibration</b>	Processes calibration for defect data of the detector.
<b>Gain Calibration</b>	Processes calibration for image sensitivity.
<b>Detector Configuration</b>	Configures the detector information related to calibration and image.



- The menu status is displayed as **Done** when each calibration is finished. You cannot operate the detector if the status is not displayed as **Done**.

### 6.1.1 System Configuration Dialogue

Configure the generator interface information from **System Configuration in Step**.

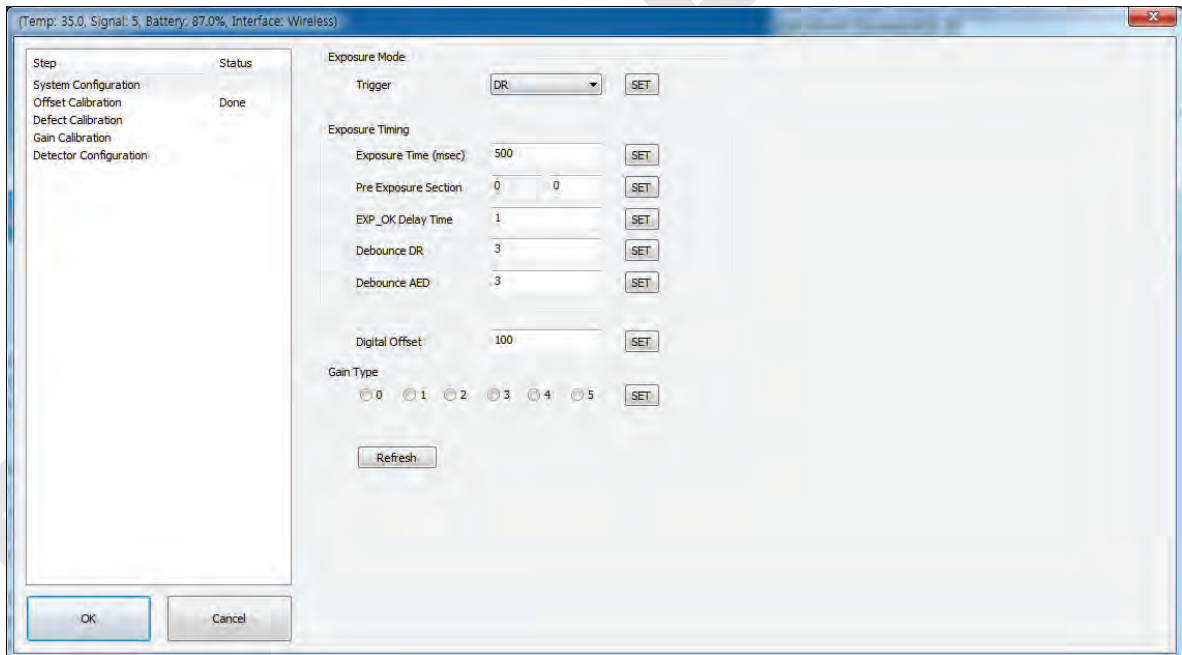

#### Exposure Mode

The **VIVIX-S 1012N** detector provides two types of mode for taking images as follows.

Mode	Description
<b>AED</b>	Detects X-ray automatically without connecting the detector to X-ray generator. The detector acquires images after the automatic detection.
<b>DR Trigger</b>	Detects the X-ray exposure signal of X-ray generator in advance by connecting the detector to X-ray generator with a generator interface cable. The detector acquires images after preparing exposure with the exposure signal.

### Exposure Timing

- To take images exactly, set the timing information for exposure.
- The information can be different depending on the characteristics of the X-ray generator.

**Exposure Timing**

Exposure Time (msec)

Pre Exposure Section

EXP\_OK Delay Time

Debounce DR

Debounce AED

### Exposure Timing Diagram

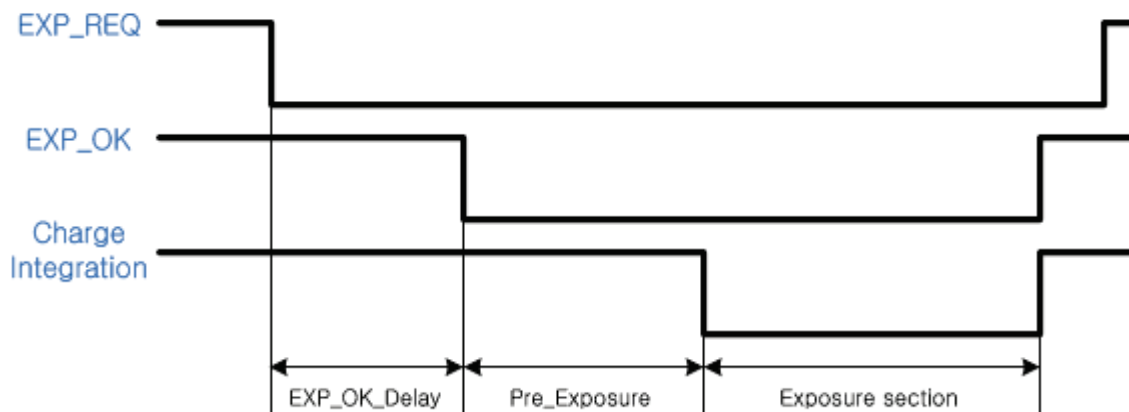

### Exposure Timing Items

Item	Default	Description
<b>Exposure section</b>	500ms	Time to acquire X-ray by the detector.
<b>Pre Exposure section</b>	0ms	Standby time after the detector sent EXP_OK signal to the generator.
<b>EXP OK Delay section</b>	1ms	The delayed time to receive EXP_OK signal from the detector after the generator sent EXP_REQ signal to the detector.
<b>Debounce_DR</b>	3ms	The required time to check signals from the generator for preventing image acquisition from external noise. It can be used when DR Trigger mode is selected only.
<b>Debounce_AED</b>	3ms	The required time to check sensor signal from X-ray to prevent image acquisition from external noise. It can be used when AED mode is selected only.



- **Exposure section** should be set longer than the maximum exposure time to prevent X-ray loss.



- When **Exposure section** is changed, make sure to create new calibration data by processing Offset calibration and Gain calibration to get optimized images.



- **Pre Exposure section** can be used when the time delays until the generator receives **EXP-OK** signal from the detector and generates X-ray. Although **Pre Exposure section** is set as **0ms** normally, it is recommended to measure and set the actual delay time of X-ray generation to achieve the best performance of the detector. The detector sends **EXP\_OK** signal to the generator, then acquires X-ray after the setting time in **Pre Exposure section**.



- **EXP OK Delay section** is the delayed time between the detection time of exposure request signal (**EXP\_REQ**) from the X-ray generator and the time before sending exposure respond signal (**EXP\_OK**) to the X-ray generator. Some X-ray generators need time to prepare detecting **EXP\_OK** signal after sending **EXP\_REQ** signal. This time is determined according to the specifications of X-ray generator.



- **Debounce\_DR** is used for removing the trigger signal due to external noise when the exposure mode is set as **DR Trigger**. If the value is set to less than **3ms**, the detector may acquire undesirable images.



- **Debounce\_AED** is used for removing trigger signals due to external noise when the exposure mode is set as **AED**. If the **Debounce\_AED** value is set longer than the X-ray exposure time, the detector cannot acquire images. If unwanted images are acquired without X-ray exposure while the equipment is operated, set **Debounce\_AED** with **1ms** increments. However, we recommend you not to set the value more than **10ms**.

## Gain Type

You can select the Gain Type to adjust sensitivity of the detector for acquiring X-ray images with desired brightness according to the specifications of X-ray generator or the object type.

The following table describes the sensitivity ratio of each **Gain Type**.

Gain Type	0	1	2	3	4	5
<b>1012NA(W) (CsI)</b>	0.96	1.2	1.44	1.6	1.8	3.6
<b>1012NB(W) (Gadox)</b>	0.82	1.0	1.29	1.5	1.8	3.0



- To acquire the optimized images, carry out the Offset calibration and Gain calibration again after changing **Gain Type**.



## 6.1.2 Offset Calibration Dialogue



- Vieworks provides the Defect Map data stored in the detector. However, we recommend you to carry out the Offset calibration by yourself as the detector condition can be different by the operating method or use environment.

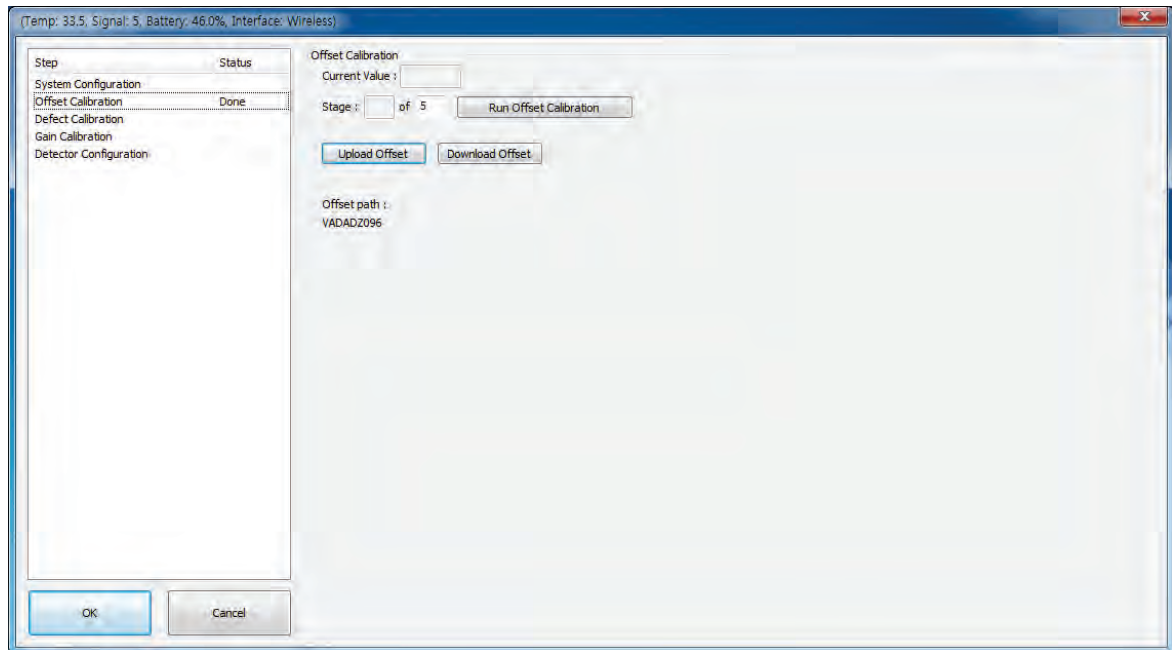

### Offset Calibration

Item	Description
<b>Current value</b>	Shows value when performing the manual Offset calibration.
<b>Stage</b>	Selects the performance frequency of manual Offset calibration and shows each calibration stage.
<b>Run Pre-offset Calibration</b>	Performs the manual Offset calibration.
<b>Load Pre-offset</b>	Downloads the Offset data stored in the detector.
<b>Offset Path</b>	Shows the path of the applied Offset data.

### 6.1.3 Defect Calibration Dialogue



- Vieworks provides the Defect Map data stored in the detector. However, you should download the data as the calibration cannot be performed in the detector automatically.
- This Defect Map data has been generated through stringent test in the production stages of detector. However, new defect may be newly formed while using the detector. In this case, make sure to calibrate defects in person and generate a new defect map.

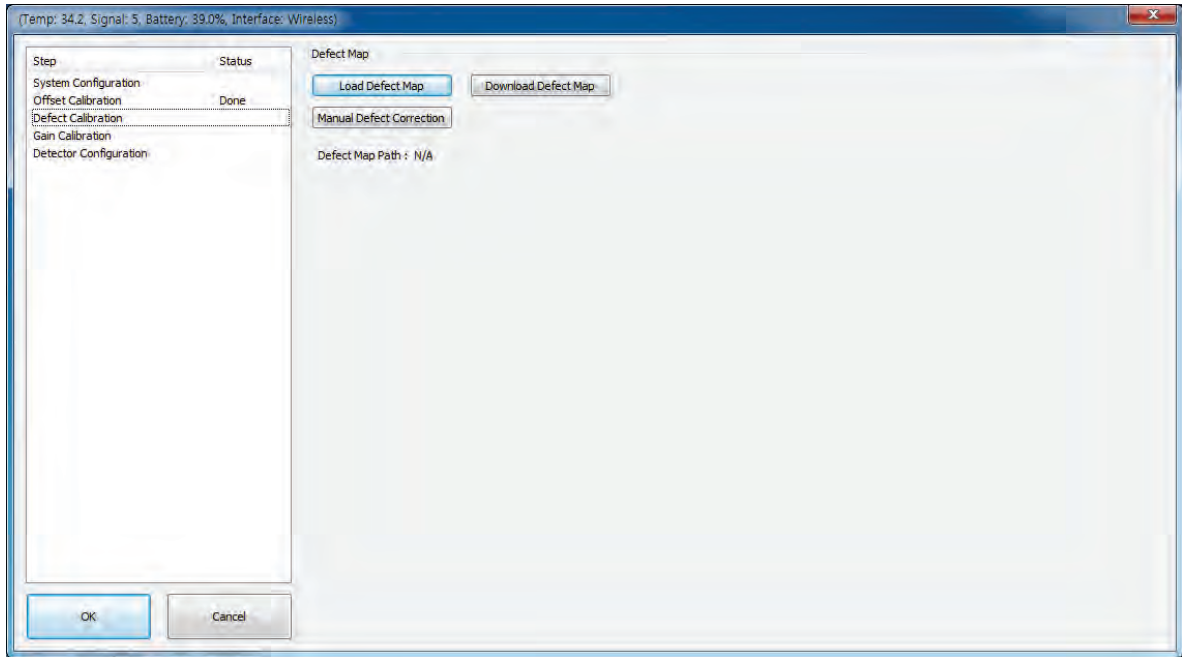

#### Defect Map

Item	Description
<b>Load Defect Map</b>	Loads the Defect Map calibration data located in the defect map path.
<b>Download Defect Map</b>	Downloads the Defect Map calibration data stored in the detector.
<b>Manual Defect Correction</b>	Calibrates the defect manually.
<b>Defect Map Path</b>	Shows the path of applied Defect Map data.

### 6.1.4 Gain Calibration Dialogue



- Vieworks provides the Gain data stored in the detector. However, you should download the data as the calibration cannot be performed in the detector automatically.
- This data is provided in case the Gain calibration cannot be performed. You should do the Gain calibration in person as the detector condition can be different by the operating method or use environment.

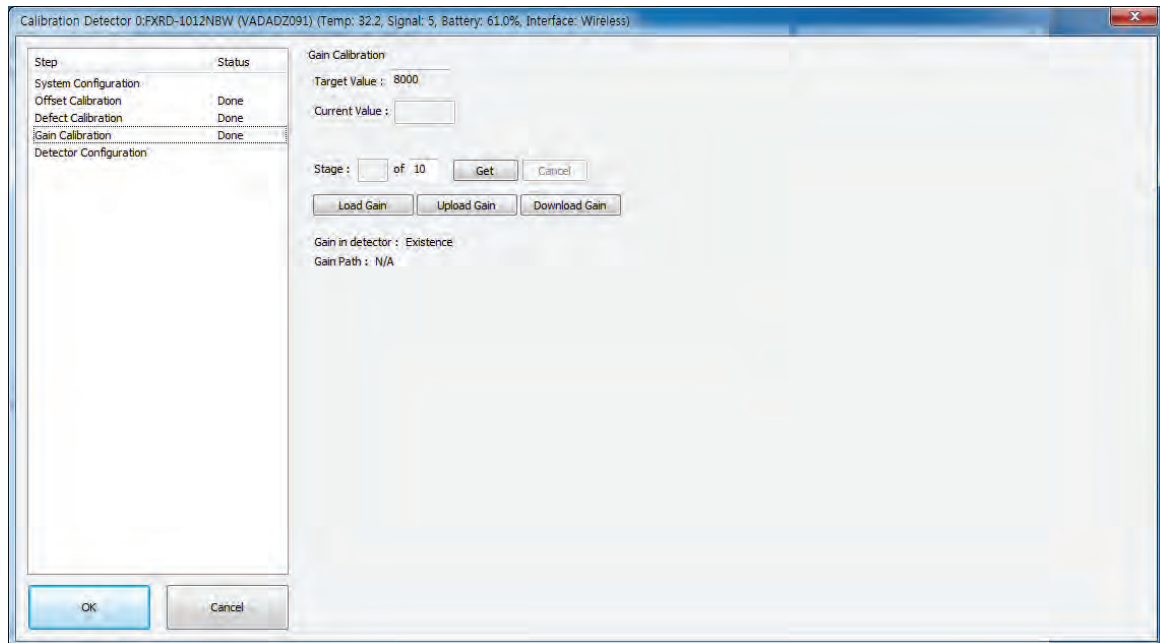

#### Gain Calibration

Item	Description
<b>Target Value</b>	Shows the target value of Gain calibration. (Recommended : <b>8000</b> or higher)
<b>Current Value</b>	Shows value after the exposure when processing the manual Gain calibration.
<b>Stage</b>	Selects the number of manual Gain calibration and shows each calibration stage.
<b>Get</b>	Starts the manual Gain calibration.
<b>Cancel</b>	Cancels the manual Gain calibration.
<b>Load Gain</b>	Loads the Gain calibration data located in the Gain path.
<b>Upload Gain</b>	Uploads the Gain calibration data to the detector for using portable mode.
<b>Download Gain</b>	Downloads the Gain calibration data stored in the detector.
<b>Gain Path</b>	Shows the path of applied Gain data.

## 6.2 Detector Configuration

From the **Detector Configuration** dialog, you can configure the detector and check the images before or after doing calibration.

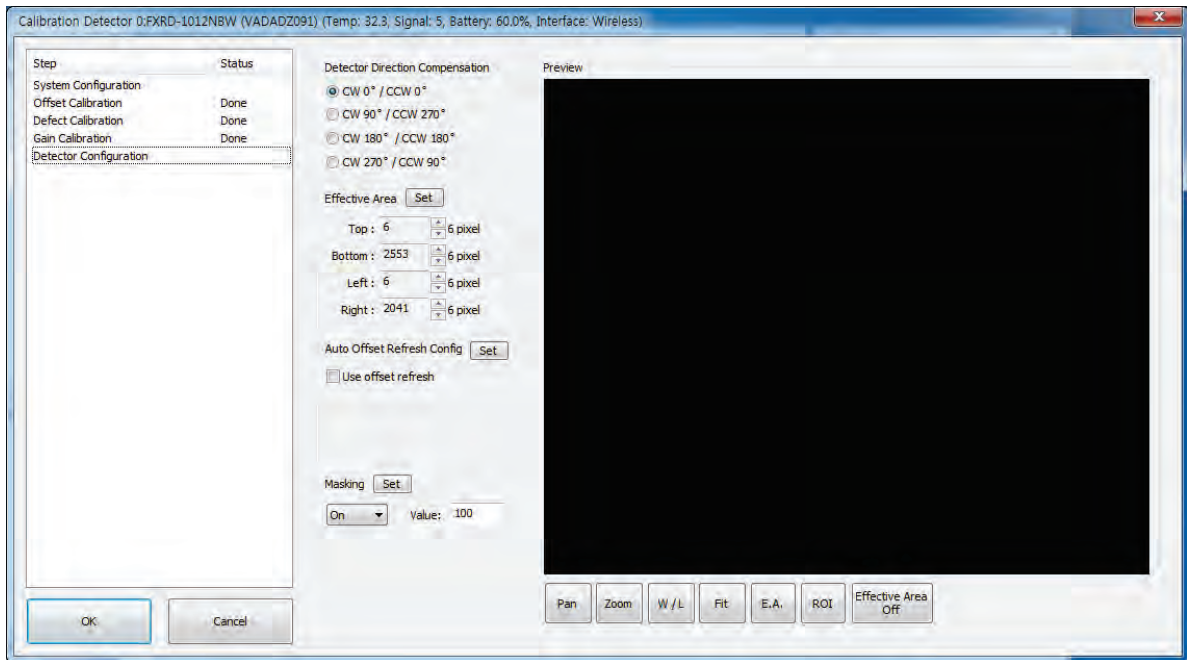

Function	Description
<b>Detector Direction Compensation</b>	Sets the displayed direction of image.
<b>Effective Area</b>	Sets effective area of an image.
<b>Offset Refresh Setting</b>	Sets conditions of automatic Offset Refresh.
<b>Time Interval (min.)</b>	Checks cycle of temperature change
<b>Temperature Interval (°C)</b>	Difference of over-temperature.
<b>Number of shot</b>	Number of Offset Refresh.
<b>Masking (On / Off)</b>	Sets outside of the effective area to specific values.
<b>OSF</b>	Chooses whether to use OSF or not.
<b>Set</b>	Saves the setting values to the detector.
<b>Pan</b>	Moves an image to the desired location.
<b>Zoom</b>	Extends or contract an image.
<b>W/L</b>	Adjusts window level of an image.
<b>Fit</b>	Displays an image by adjusting it to the screen.
<b>E.A.</b>	Sets the effective area of an image with a mouse.
<b>ROI</b>	Sets the image area of interest.
<b>E.A (Effective Area)</b>	Displays effective area of an image only.



- You can only change the displayed direction of an image from **Detector Direction Compensation**. The direction of an original image cannot be changed.



- **Effective Area** can be changed within the effective range which has been configured at the time of the first shipment of detector.



- Once **Use offset refresh** is used, the offset refresh is processed automatically as follows.
  - Checks temperature difference of the detector between current temperature and the previous one at the time of offset refresh in every setting time from **Time Interval**.
  - If the temperature difference is more than the one set in **Temperature Interval**, the offset refresh is carried out a number of times set in **Number of shot**.
  - If you use **VXvue**, a pop-up message will be displayed before the offset refresh.
  - Auto offset refresh will be performed by clicking **OK** button.



- **OSF** is the auxiliary function for stabilizing pixel value of an image to the default value rapidly.
- The pixel value can be displayed equally by using **OSF** under the environment where the pixel value of X-ray image is required to display.
- Whether to use **OSF** or not does not affect the X-ray image quality.

### 6.3 Calibration Guide

The different installation environment of each detector and unique features of the X-ray generator device can affect the acquired images. Therefore, the certified engineer from Vieworks should do the detector calibration after installing it. Otherwise, the image quality can be affected seriously.

Vieworks provides two types of calibration for performing calibration.

- Performing calibration by loading the calibration data CD provided by Vieworks.
- The service engineer proceeds calibration and generate calibration data.



- We strongly recommend the service engineer to carry out the calibration in person since the detector condition and image quality can be different by the operation method or use environment.

## 6.4 Calibrating by Loading the Calibration Data



- Vieworks provides the calibration data stored in the detector. Although the Offset calibration is performed automatically, you need to download both Defect and Gain calibration data since their calibration cannot be performed in the detector automatically.

### 6.4.1 Preparing Calibration Data

Among the three types of calibration data stored in the detector, download the Defact Map and Gain calibration data to local HDD.

- It is not necessary to download the Offset calibration data since the data is used in the detector.

File	Description
Offset	Detector Offset data
Gain	Calibration data for image sensitivity
Defect Map	Defect calibration map data

### 6.4.2 Loading Defect Calibration Data

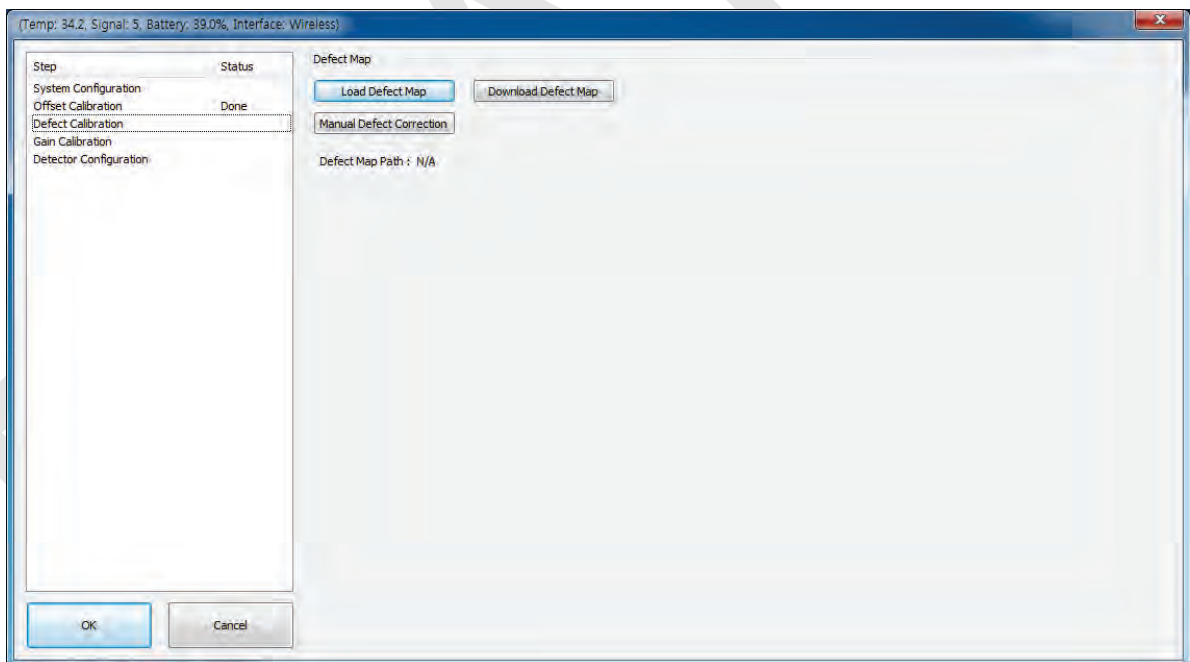

- 1 Select **Defect Calibration** from the Step list.
- 2 Click **Download Defect Map** button to assign the path of local HDD, and download the Defect Map calibration data.
- 3 Click **Load Defect Map** button to load the calibration data.



- The calibration menu status is displayed as **Done** when the Defect calibration data is loaded completely.



- Be sure to select the Defect Map data file provided with a detector. If the file has a wrong serial number or you select a wrong file, an error message will be displayed.



- Vieworks provides the Defect Map data stored in the detector. However, you should download the data as the calibration cannot be performed in the detector automatically.
- This Defect Map data has been generated through stringent test in the production stages of detector. However, new defect may be newly formed while using the detector. In this case, make sure to calibrate defects in person and generate a new defect map.

### 6.4.3 Loading Gain Calibration Data

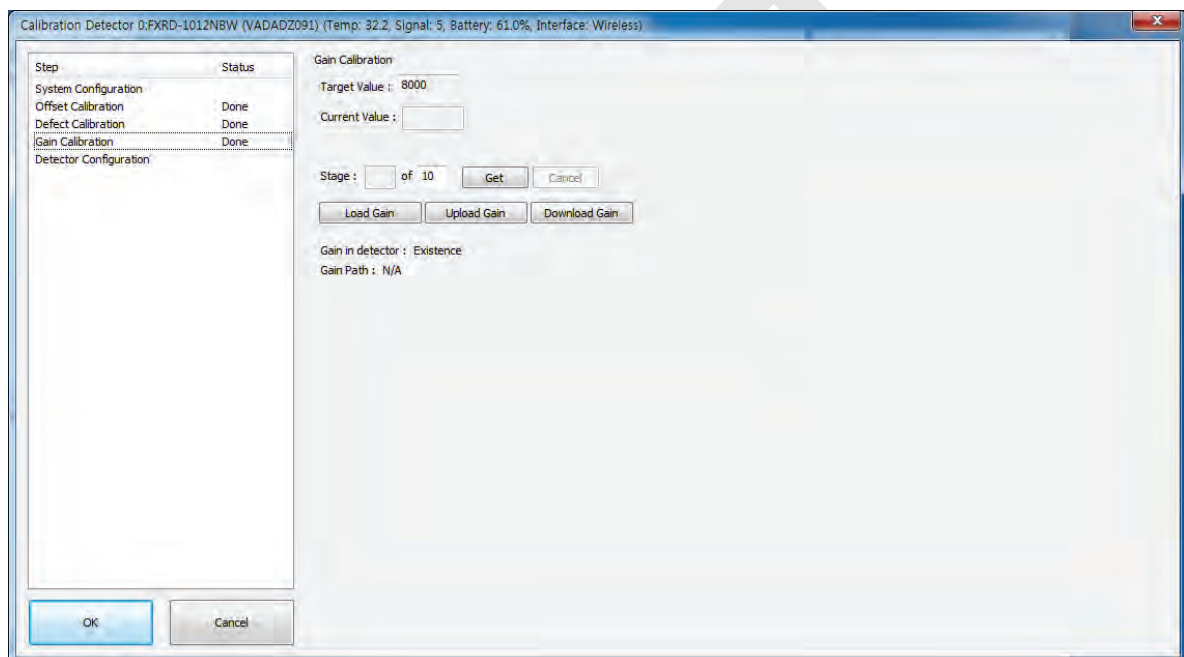

- 1 Select **Gain Calibration – Normal** from the Step list.
- 2 Click **Download Gain** button to assign the path of local HDD, and download the Gain calibration data.



- The calibration menu status is displayed as **Done** when the Gain calibration data is completed to be loaded.



- Be sure to select the Gain calibration data file provided with a detector. If the file has a wrong serial number or you select a wrong file, an error message will be displayed.



- Vieworks provides the Gain calibration data stored in the detector. However, you should download the data as the calibration cannot be performed in the detector automatically.
- This data is provided in case the Gain calibration cannot be performed. You should do the Gain calibration in person as the detector condition can be different by the operating method or use environment.



## 6.5 Direct Calibration

### 6.5.1 Prepration

- Precheck the state of X-ray generator and console.
- Precheck the state of X-ray tube.



• It is recommended you to check if X-ray dose value of the generator is exact by using the device like a dose meter.



• Make sure to preheat the detector for 30 minutes before starting calibration. The result of measurement can be incorrect if the detector is not preheated sufficiently.

### 6.5.2 Offset Calibration

Step	Status
System Configuration	
Offset Calibration	Done
Defect Calibration	
Gain Calibration	
Detector Configuration	

Offset Calibration

Current Value :

Stage :  of

Offset path :  
VADADZ096

- 1 Set the number of **Stage** as 5 in the **Offset Calibration** area.
- 2 Click **Run Offset Calibration** button and progress the **Offset** calibration.

### 6.5.3 Gain Calibration

- 1 Put a collimator on center of the detector, and open the collimator completely.
- 2 Adjust **SID** as **130cm ~ 150cm** to make X-ray exposure range include the detector.
- 3 Remove any objects or foreign materials between the tube and the detector.

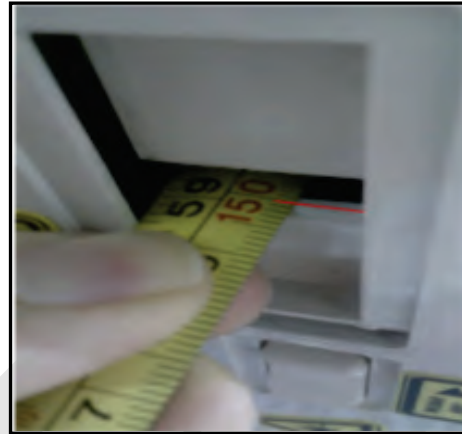
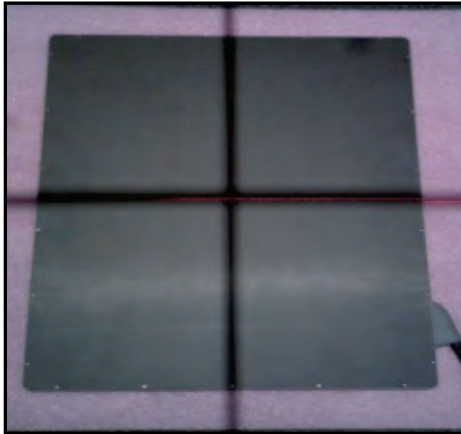

- 4 Choose **Gain Calibration -Normal**.
- 5 Set the tube voltage of X-ray generator as **70kV ~ 80kV**.
- 6 While acquiring images, adjust the X-ray dose condition (**mA** or **ms**) until **Current Value** of the **Gain Calibration** area is formed between **8000±200**.
- 7 Set the exposure number of **Stage** as **10** when the adjustment of exposure condition is completed.
- 8 Click **Get** button, and keep making an X-ray exposure at **15 sec** intervals.
- 9 Save the **Gain Calibration** data as a file.

Step	Status
System Configuration	
Offset Calibration	Done
Defect Calibration	Done
Gain Calibration	Done
Detector Configuration	

Gain Calibration

Target Value :

Current Value :

Stage :  of 10

Gain in detector : Existence

Gain Path : N/A



- Make sure to progress **Gain Calibration** again if the cases below are applicable.
  - When the settings of **Exposure Section** or **Gain Type** is changed from the **VIVIX Setup** program.
  - When the exposure devices like X-ray generator are repaired.
  - When the exposure environment is changed.
  - When the service engineer decides that it is need to progress Gain Calibration.

## 6.5.4 Auto Defect Correction



- While operating the detector, defect pixels may appear on the image. In this case, use the defect auto correction to calibrate the defect pixels.



- Be sure to check the followings before acquiring the FLAT image.
  - Preheat the detector for **30 minutes** or more.
  - The recommend **SID** is **150 cm** (distance between X-ray tube and detector)
  - Open the collimator of X-ray tube completely.
  - Align the center of the detector with the center of collimator.
  - Keep everything away from the detector surface.

- 1 Make an exposure of FLAT images from the **Image** dialog box.
- 2 Click **Save Image** button to save images to the user-defined folder. (saved as a raw file.)

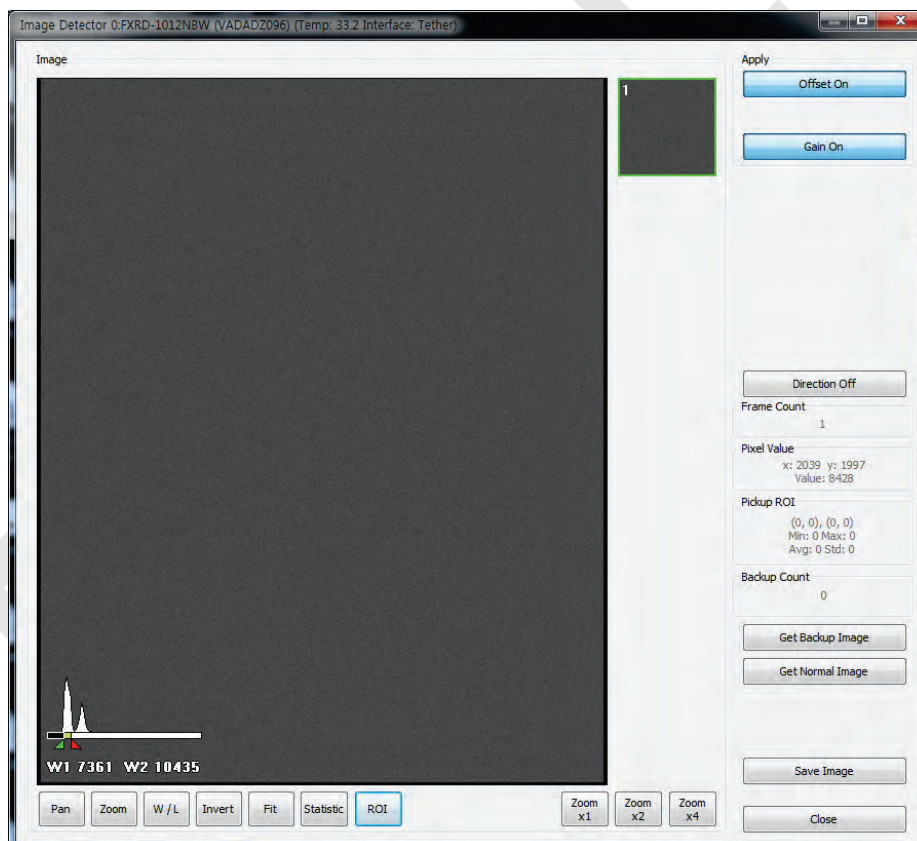

- 3 Close the **Image** dialog box, and open the **Calibration** dialog box.
- 4 Choose **Defect Calibration** as follows and click **Manual Defect Correction** button.

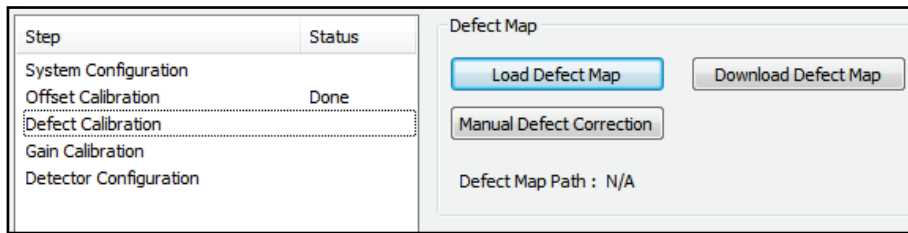

- 5 Move to the folder where the raw file is saved and select the file.

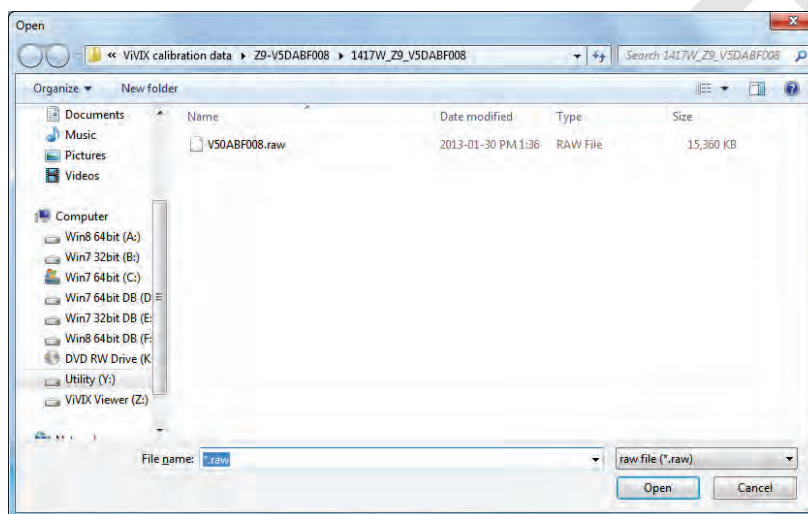

- 6 The **Manual Defect Detection** screen will be displayed.
- 7 Click **Show** and **Apply** buttons on the top left and then click **Auto Defect Finder** button.

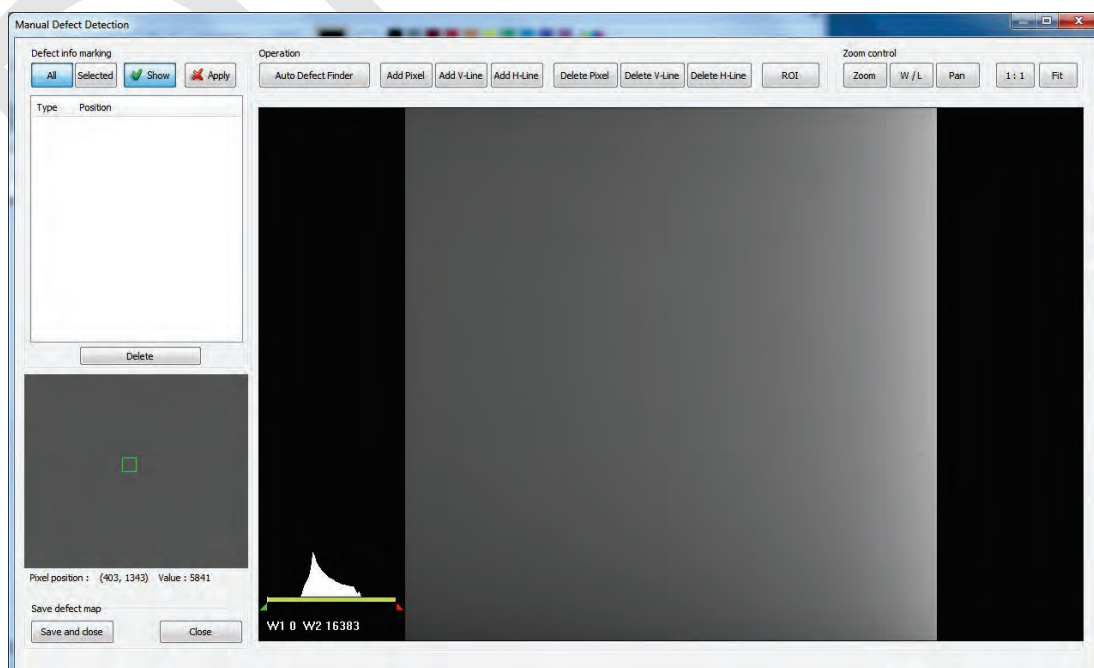

- 8 Input **15%** for **Threshold**, and **100** for **Offset** at the bottom of the **Pixel List** screen.
- 9 Click **Search** button at the bottom of the screen. The coordinates of defect pixels and Gray level values are displayed on **Pixel list**.
- 10 While pressing the **Ctrl** or **Shift** key, select the coordinate of defect pixels to be added to **Defect Map**.

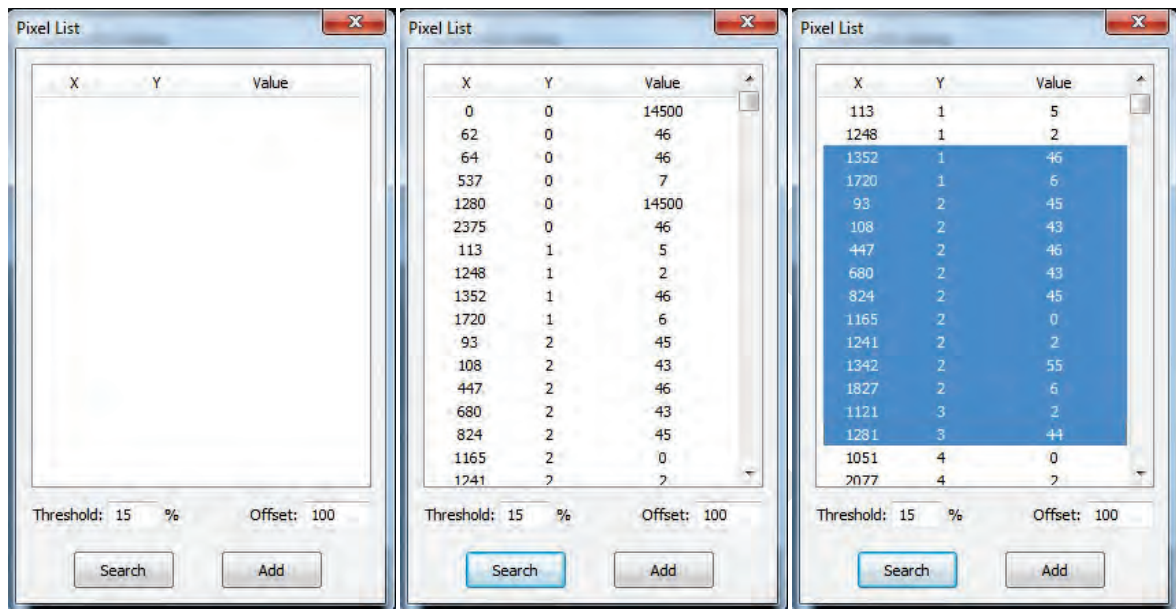

- 11 Click **Add** button to add the selected items to **Pixel List** in **Manual Defect Detection**.
- 12 Check if the selected defect pixels are added to the pixel list on the left.

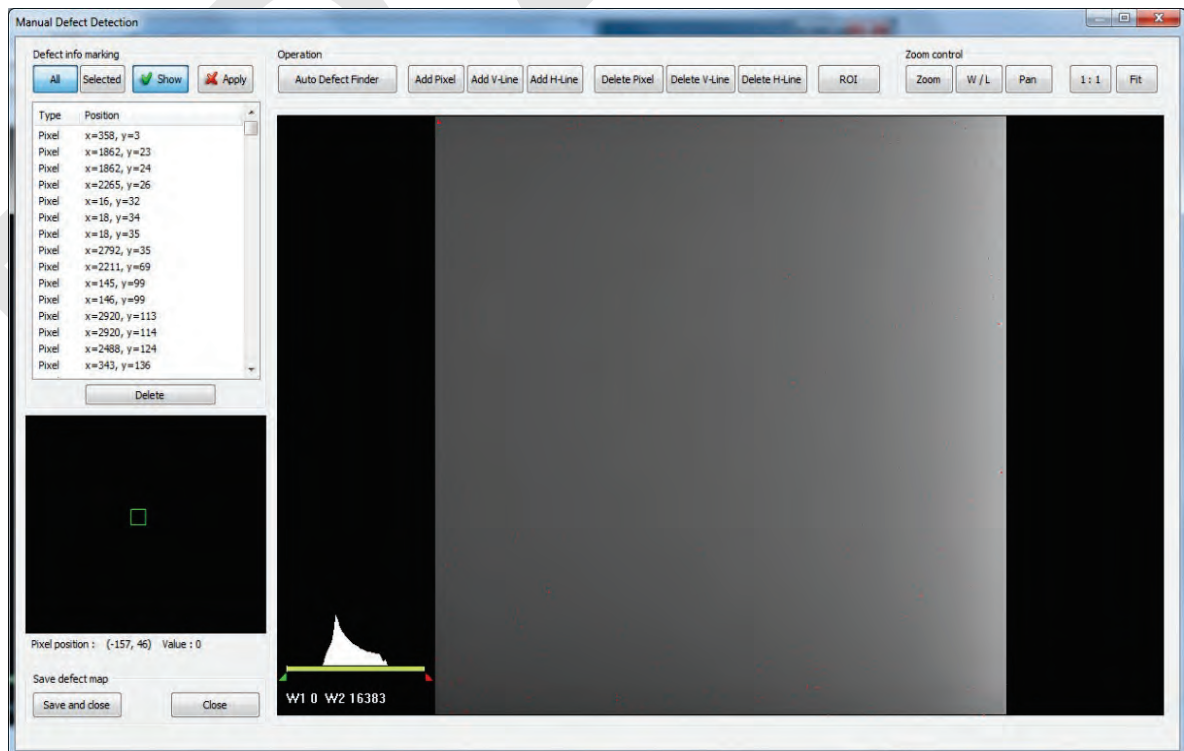

- 13 Click **Save and Close** button at the left bottom.



- 14 Save the newly generated Defect Map data to the path where the Calibration data has been stored.

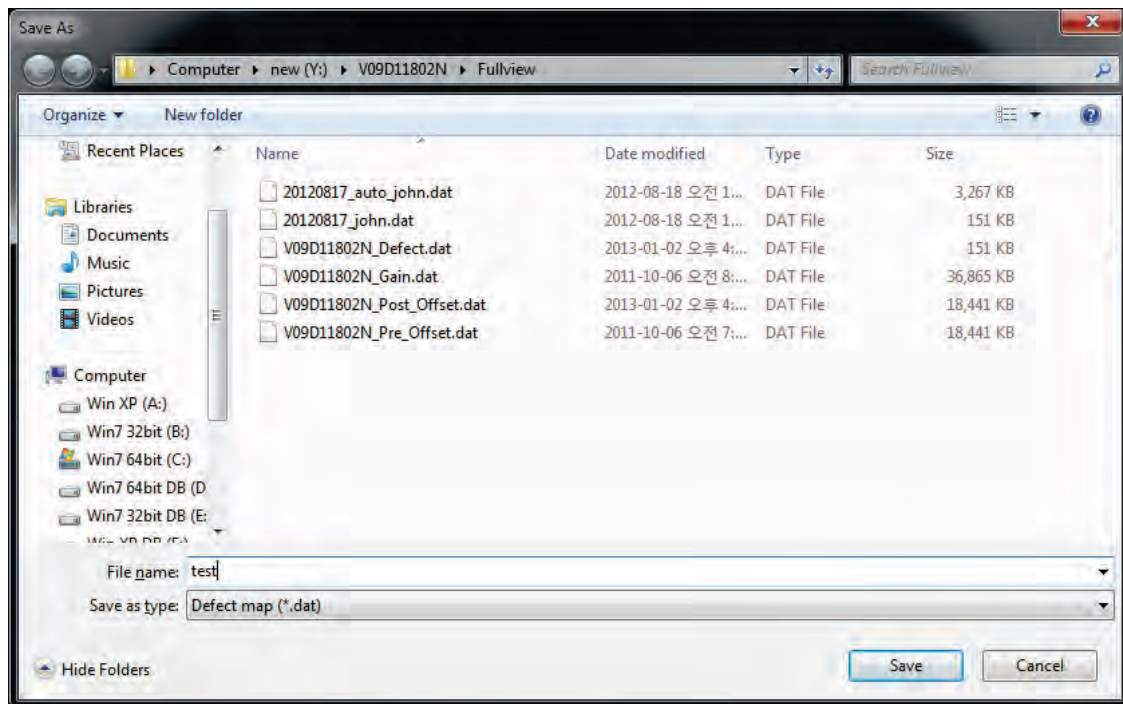

- It is recommended to save the newly generated Defect Map data with a different name to preserve the past Defect Map data.

## 6.5.5 Manual Defect Correction



- Execute **Manual Defect Detection** when the defect pixels are visible to the naked eye even the automatic defect correction is processed. **Manual Defect Detection** is divided into the pixel type and line type.

### Manual Defect Correction in Pixel Type

- 1 Make sure to carry out the automatic defect correction from 1 to 14 steps first.
- 2 Click **Show** and **Apply** buttons on the left top of **Manual Defect Detection**.
- 3 Press and hold the right mouse button and move it to left/right/top/ bottom in the FLAT image to adjust the brightness until you can verify the image with the naked eyes.
- 4 Click **Add Pixel** Button.
- 5 Use the **Zoom** or **Pan** function properly to find and click the location of defect pixel. Red point will be displayed and coordinate of the pixel will be added on the Detect Map List on the left upper.
- 6 Click **Save and Close** button to save the Defect Map data with a new name.



- If a selected pixel has a difference in the brightness or gray level value (more than 15%) compared to the adjacent pixels, the pixel may be regarded as a defect pixel.
- A window located on the left top will magnify and display the pixel where the mouse pointer is located. The coordinate and Gray level value of the pixel will be displayed under the window.

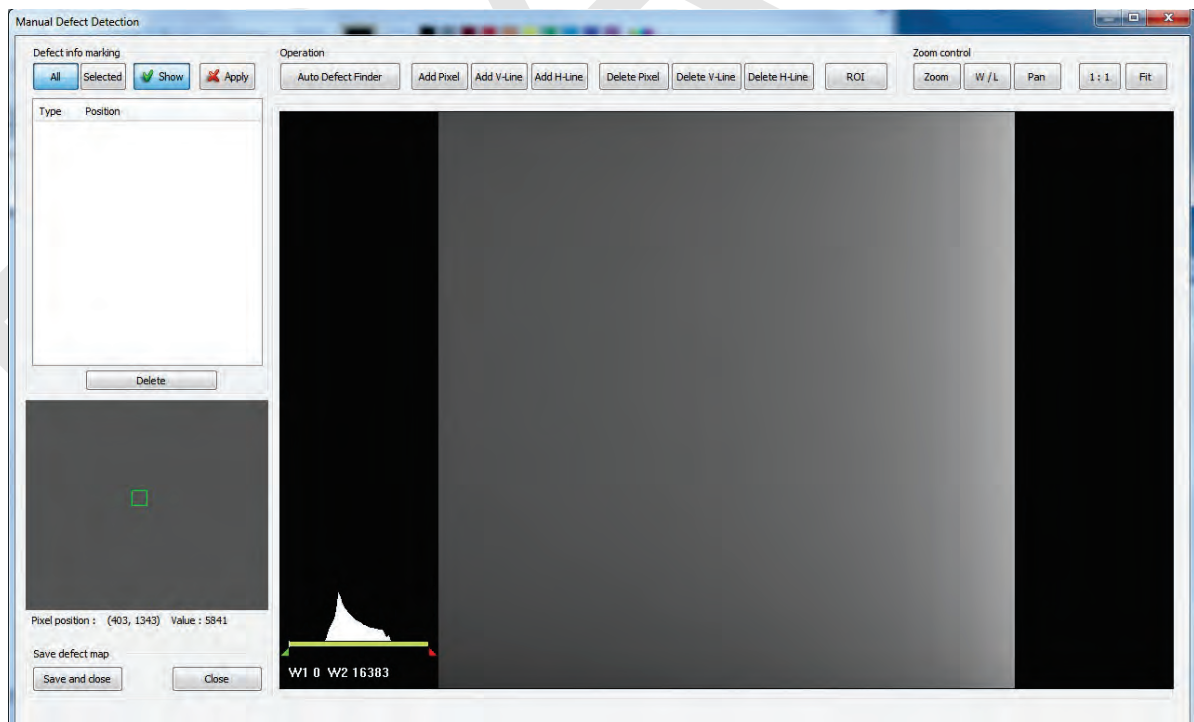

## Manual Defect Correction in Line Type

- 1 Make sure to carry out the automatic defect correction from 1 to 12 steps first.
- 2 Click **Show** and **Apply** buttons on the left top of **Manual Defect Detection**.
- 3 Press and hold the right mouse button and move it to left/right/top/bottom in the FLAT image to adjust the brightness until you can verify the image with the naked eyes.
- 4 Find and move to the start point of defect lines (line type) on the image.
- 5 Click **Add V-Line** or **Add H-Line** button.
- 6 Press and hold the left mouse button on the first defect pixel, move the mouse to the opposite direction and release the mouse button on the last pixel of Line Defect pixel.
- 7 A red line will be displayed on the image and check if pixels on the line are added to the Defect Pixel list.
- 8 Click **Save and Close** button to save the newly generated Defect Map data with a new name.

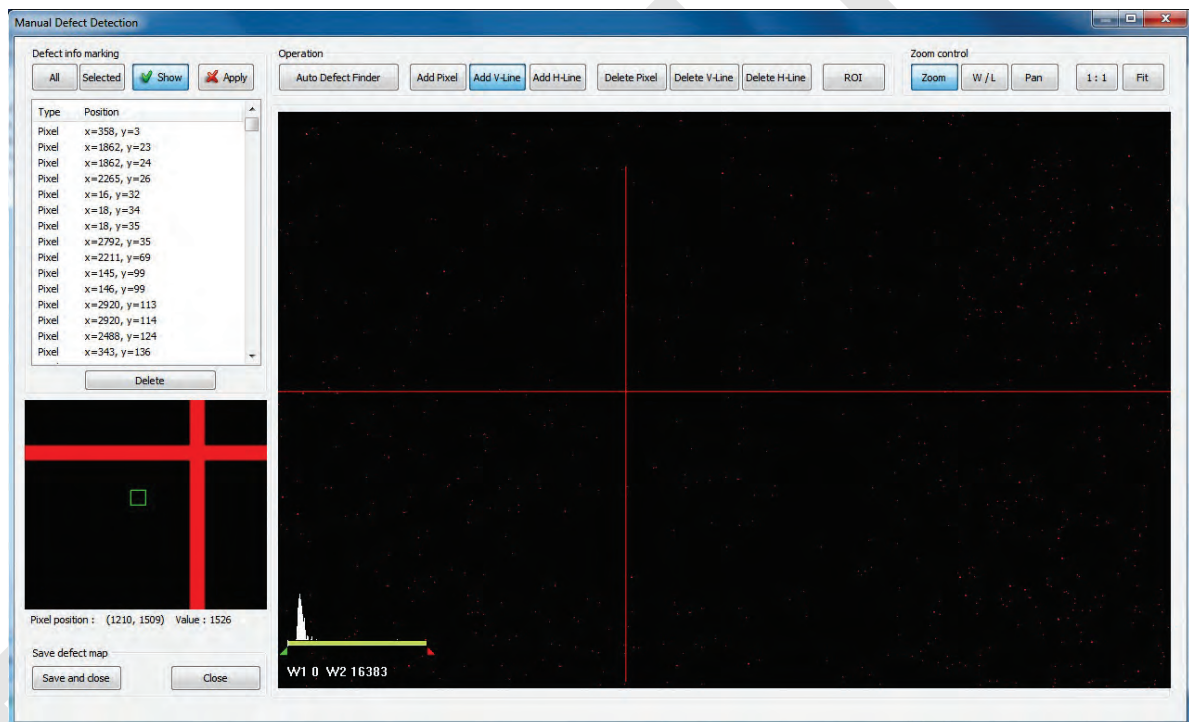

- If a selected pixel has a difference in the brightness or gray level value (more than 15%) compared to the adjacent pixels, the pixel may be regarded as a defect pixel.
- A window located on the left top will magnify and display the pixel where the mouse pointer is located. The coordinate and Gray level value of the pixel will be displayed under the window.



- If there are pixels existed without defect correction even though you conduct the manual defect correction, get technical support from the person in charge of Vieworks or a certified engineer by Vieworks.



### Functions of Manual Defect Detection

Function	Description
<b>Show</b>	Decides whether to indicate the selected defect on the image
<b>Apply</b>	Decides whether to apply Defect in the list to the calibrated image.
<b>All</b>	Applies to all coordinates of defects added to the list
<b>Selected</b>	Applies to relevant coordinates of the selected defects from the list only.
<b>Auto Defect Finder</b>	Performs the auto defect correction.
<b>Delete</b>	Deletes the selected items from the list.
<b>Add Pixel</b>	Adds one defect pixel to Defect Map List.
<b>Add V-Line</b>	Adds vertical line type of defect pixels to Defect Map List
<b>Add H-Line</b>	Adds horizontal line type of defect pixels to Defect Map List.
<b>Delete Pixel</b>	Deletes the defect pixel of a point on list of Defect Map.
<b>Delete V-Line</b>	Deletes the defect pixel of vertical line on list of Defect Map.
<b>Delete H-Line</b>	Deletes the defect pixel of horizontal line on list of Defect Map.
<b>ROI</b>	Marks the area of interest.
<b>Zoom</b>	Zoom in or out the image.
<b>W/L</b>	Adjusts the window level of the image to change the brightness.
<b>Pan</b>	Moves the image to a desired location.
<b>1:1</b>	Displays the image as 1:1 ratio.
<b>Fit</b>	Displays the image as fitting it on the screen.
<b>Save and Close</b>	Saves the changed defect pixel information as Defect map data.
<b>Close</b>	Closes the window without saving the changed defect pixel information

---

## 7. Diagnosis, Inspection and Maintenance

---

This section gives information about diagnosis, inspection & maintenance of the product.

Diagnosis  
Product Inspection  
Cleaning and Disinfection  
Product Initialization  
Replacing the Fuse of SCU

## 7.1 Diagnosis

### 7.1.1 Image Diagnosis



- Check the image quality through Diagnosis tools after installing the detector or before usage. If the problems with regard to products or image occur during diagnosis, try to do a calibration again. If the problems are not solved, consult the sales representative in Viewworks or a service engineer.

You can acquire and review an image from the **Diagnosis** window in **VIVIX Setup** program.

- You can review images by acquiring them through real exposure or getting Dark image by clicking **Get Normal Image** button.
- The number of images, pixel value and ROI value will be displayed.
- The effective area or whole area of an image can be checked.
- It is also available to check the image by changing its direction.
- Save the reviewed image as a raw one to analyze.
- You can acquire an image either applying Offset / Gain data or not.

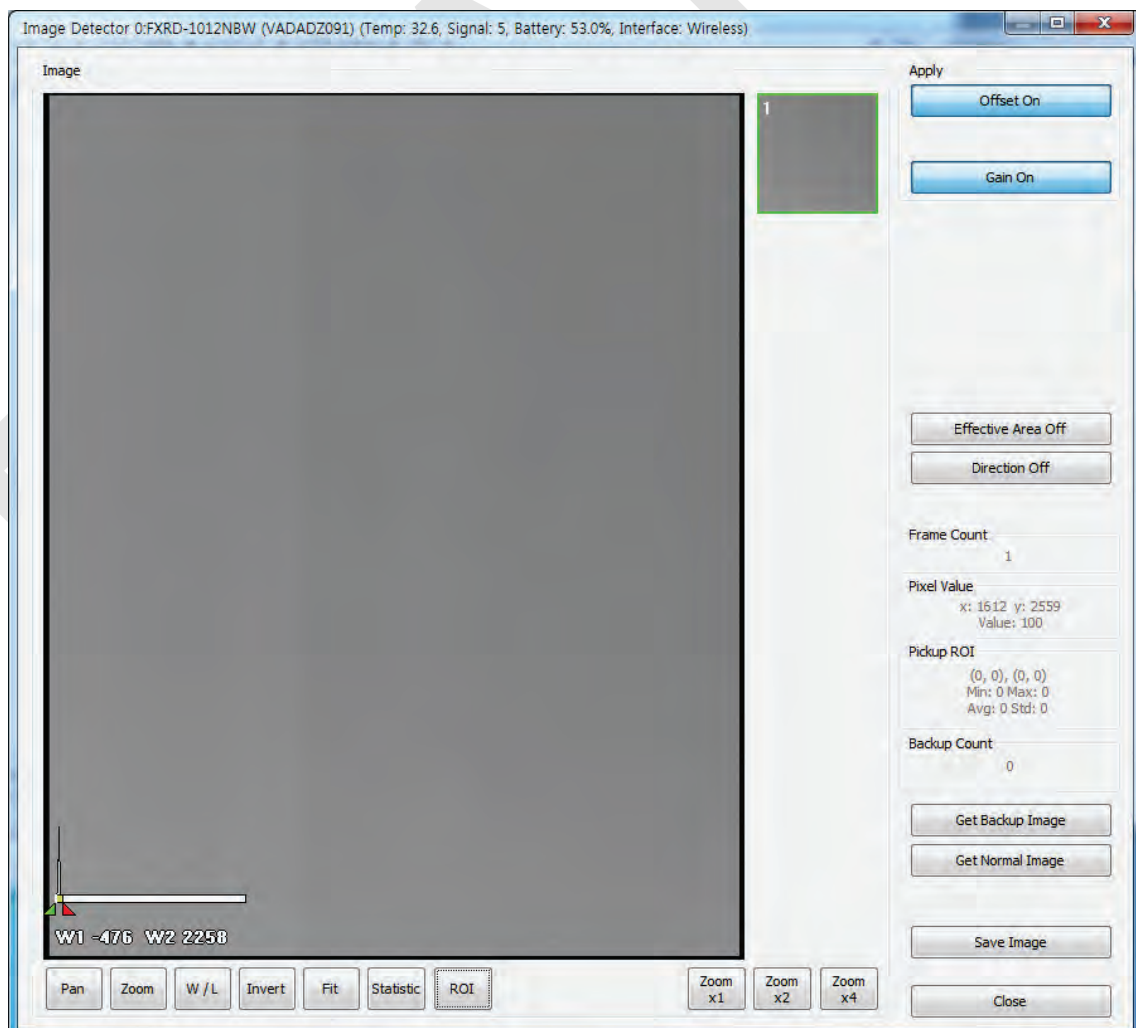

## Dignostic Functions

Item	Description
<b>Pan</b>	Press and drag a mouse button to move the image to the desired position.
<b>Zoom</b>	Press and hold a mouse button to move the image upwards or downwards for expanding / reducing the image.
<b>W/L</b>	Press and hold a mouse button to move the image to up/down/right/left for adjusting its window level. This function can be used without clicking W/L button, but with the right mouse button basically.
<b>Fit</b>	Sets the image to the center, which was moved by using Pan function.
<b>Statistic</b>	Clicks and drags the left mouse button to set arbitrary area. The coordinate, min/max value, average and standard deviations are displayed on <b>Pickup ROI</b> at the left side of image.
<b>ROI</b>	Clicks and drags the left mouse button to set window level automatically on a basis of min/max value of the configured area.
<b>Zoom (X1 / X2 / X4)</b>	Expands the image (2 times / 4 times / 16 times)
<b>Effective Area</b>	Applicability of <b>Effective Area</b> in <b>Detector Configuration</b> dialog.
<b>On</b>	Applies effective area of the detector to the image.
<b>Off</b>	Applies whole area of the detector to the image.
<b>Offset</b>	Applicability of Offset data
<b>On</b>	Acquires an image with applying Offset data.
<b>Off</b>	Acquires an image without applying Offset data.
<b>Gain</b>	Applicability of Gain data
<b>On</b>	Acquires an image with applying Gain data.
<b>Off</b>	Acquires an image without applying Gain data.
<b>Direction</b>	Applicability of Detector Direction Compensation in Detector Configuration dialog.
<b>On</b>	The image is displayed according to the configured direction.
<b>Off</b>	The image is displayed as a default direction. The image starting point (0,0) is located on the left top of the image.
<b>Get Normal Image</b>	Acquires a dark image without X-ray shooting.
<b>Save Image</b>	Saves the image as a raw one.
<b>Close</b>	Closes the <b>Diagnosis</b> dialog.



- You can only change the displayed direction of an image in **VIVIX Setup** program from **Detector Direction Compensation**. The direction of an original image cannot be changed.

### 7.1.2 Battery Pack Diagnosis



- Install the battery pack to the detector and check the voltage and remaining amount of the battery pack. Furthermore, always check the remaining amount of the battery pack during use of the detector. If performance of the battery pack has some problems, consult the sales representative in Vieworks or a relevant engineer.



- The battery pack belongs to consumables which performance will be decreased as time passed. Make sure to check the battery life during usage.

#### Check remaining amount of battery pack

The battery remains is noticed as a level or percentage (%), and you can check the remains from **VXvue** (Vieworks Viewer) or **VIVIX SDK**. It is also available to check the battery remains from the LED on the side of detector.

- If the remaining of battery is under 30% or at the 1<sup>st</sup> level:
  - The related warning message is displayed from **VXvue**.
  - The related warning message is displayed from **VIVIX SDK**.
  - The detector LED for noticing battery remains is changed from green to orange color.
- If the remaining of battery is under 10%:
  - The detector LED for noticing battery remains blinks in orange color.
- You can check the battery status from the **Diagnosis** dialogue in **VIVIX Setup** program.

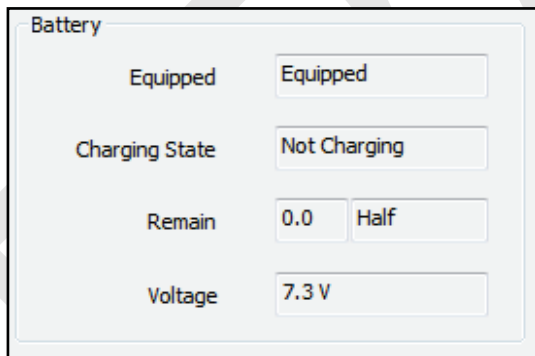

#### Display of Battery Remains

Level	Value	Battery Remains	LED Display
Full	5	81% ~ 100%	5 <sup>th</sup> level
Half Quarter	4	61% ~ 80%	4 <sup>th</sup> level
Half	3	51% ~ 60%	3 <sup>rd</sup> level
Quarter	2	31% ~ 50%	2 <sup>nd</sup> level
Low	1	11% ~ 30%	1 <sup>st</sup> level
		1% ~ 10%	Blink
Unknown	0		Off



- If the remaining of battery is under 30% or at the 1<sup>st</sup> level, the system warns low battery and the detector will be turned off automatically if the battery is being consumed for a specific period of time. Therefore, it is recommended to change the battery when a warning message or indicator is displayed.

### 7.1.3 Wireless Communication Diagnosis



- In case of using the detector with wireless communication way, make sure to check the status of wireless communication before starting to use. If the status of wireless communication is bad, the speed of acquiring images will be very slow or failed to acquire images. Try to check the surrounding wireless communication status not to occur communication interference. If wireless communication module in the detector has problems, consult the sales representative in Vieworks or a relevant engineer.

#### Check the Connection Status

User can check the connection status of wired or wireless detector through **VXvue** or **VIVIX SDK**.

#### Check the Strength of Wireless Communication Signal

The signal strength of wireless communication is provided as 5 stages or percentage (%), user can check it through **VXvue** (Vieworks Viewer) and **VIVIX SDK**.

Level	Level	Link Quality	Meaning
<b>Very Good</b>	5	66 ~ 70	The communication is running smoothly, and it ensures performace of the image acquisition.
<b>Good</b>	4	56 ~ 65	
<b>Normal</b>	3	41 ~ 55	The communication status is normal, but it does not ensure performace of the image acquisition.
<b>Bad</b>	2	31 ~ 40	The communication status can become unstable.
<b>Very Bad</b>	1	1 ~ 30	Impossible to communicate normally.
<b>Unknown</b>	0	0	The communication is disconnected.

- You can check the wireless communication state from the **Diagnosis** dialogue in **VIVIX Setup** program.

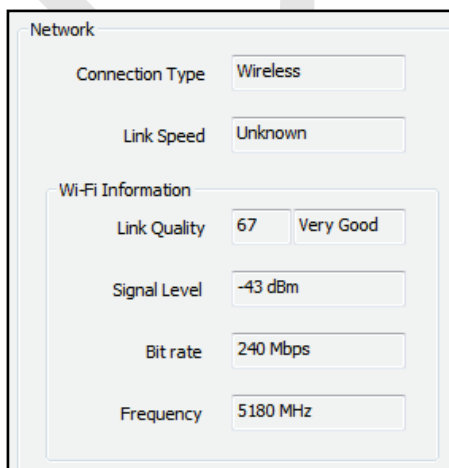

Item	Description
Connection Type	Indicates the connection mode. (Wireless / Tether)
Link Speed	Connection status in the wired mode. (1000Mbps / 100Mbps)
Link Quality	Link Quality (Status of the connection quality) value
Signal-level	Signal strength
Bit rate	Transmission / reception speed
Frequency	Frequency of the connected AP (Access Point)



- The communication is not running smoothly when the strength of wireless communication is under the 2<sup>nd</sup> stage. Therefore, it is required to check the surrounding wireless communication status.

### 7.1.4 Communication Speed Diagnosis

The communication speed can be diagnosed from the **Diagnosis** dialogue in **VIVIX Setup** program.

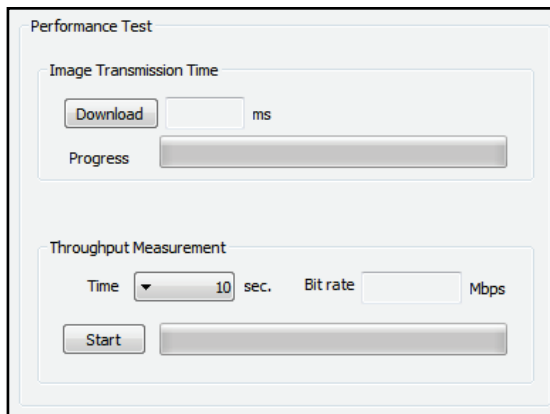

Item	Description
<b>Image Transmission Time</b>	Image transfer rate test
<b>Download</b>	Download speed of the image (Detector → Workstation)
<b>Throughput Measurement</b>	Transmission measuring test
<b>Time</b>	Transmission time
<b>Bit rate</b>	Transmission rate

## 7.2 Product Inspection



- To use products safely, make sure to check the products before use. If problems occur during inspection or the product is impossible to repair, consult the sales representative in Vieworks or a relevant engineer.

### 7.2.1 Daily Inspection

Before or after using the detector and other surrounding devices, check below items daily.

Item	Description
	<ul style="list-style-type: none"> <li>• Ensure that there are no loose screws or breaks.</li> </ul>
<b>Detector</b>	<ul style="list-style-type: none"> <li>• Ensure that there is no dust or foreign matter on the battery bay connector.</li> <li>• Ensure that there are no breaks or short-circuits in the battery bay connector.</li> </ul>
<b>SCU</b>	<ul style="list-style-type: none"> <li>• Check if the antenna is damaged.</li> </ul>
	<ul style="list-style-type: none"> <li>• Ensure that cables are not damaged and cable jackets are not torn.</li> </ul>
<b>Cable</b>	<ul style="list-style-type: none"> <li>• Ensure that the power cord plugs are securely connected to both AC inlet and AC outlet of the equipment.</li> </ul>

### 7.2.2 Performance Inspection

Check the detector and other devices periodically as follows.

Item	Period	Description
<b>Self-Diagnosis</b>	Half-yearly	<ul style="list-style-type: none"> <li>• Conduct <b>Self-Diagnosis</b> of the <b>VIVIX Setup</b> program for the internal devices of the detector and check the status.</li> </ul>
<b>Resolution</b>	Half-yearly	<ul style="list-style-type: none"> <li>• Check the resolution of the detector through resolution chart or using a phantom.</li> </ul>
<b>Sensitivity</b>	Half-yearly	<ul style="list-style-type: none"> <li>• Evaluate the characteristic of the detector through checking gray value of the images made by X-ray dose amount reaching to the surface of the detector.</li> </ul>
<b>Calibration</b>	Half-yearly	<ul style="list-style-type: none"> <li>• Updating calibration data. (Offset → Gain → Defect)</li> <li>• Proceed to calibrate when X-ray Generator, Tube, Collimator or exposure environment are changed.</li> </ul>



- Self-diagnosis and resolution can be conducted by a user or a service engineer.
- Sensitivity and calibration should be conducted by an authorized service engineer who Vieworks grants.



### Self Diagnosis

You can perform self diagnosis of the detector or SCU from the Diagnosis window in the **VIVIX Setup** program.

- 1 Choose a desired item to diagnose.
- 2 Click **Execute Test** button located at the bottom of the **Test Case** window.
- 3 Check the progress and result of diagnosis for each item in the **Result** window.
- 4 Click **Save to File** to save the diagnosis result as a file when the self diagnosis is completed.



- Self diagnosis and resolution can be conducted by a user or a service engineer.
- Sensitivity and calibration should be conducted by an authorized service engineer granted by Vieworks.

### Self-Diagnosis Items of Detector

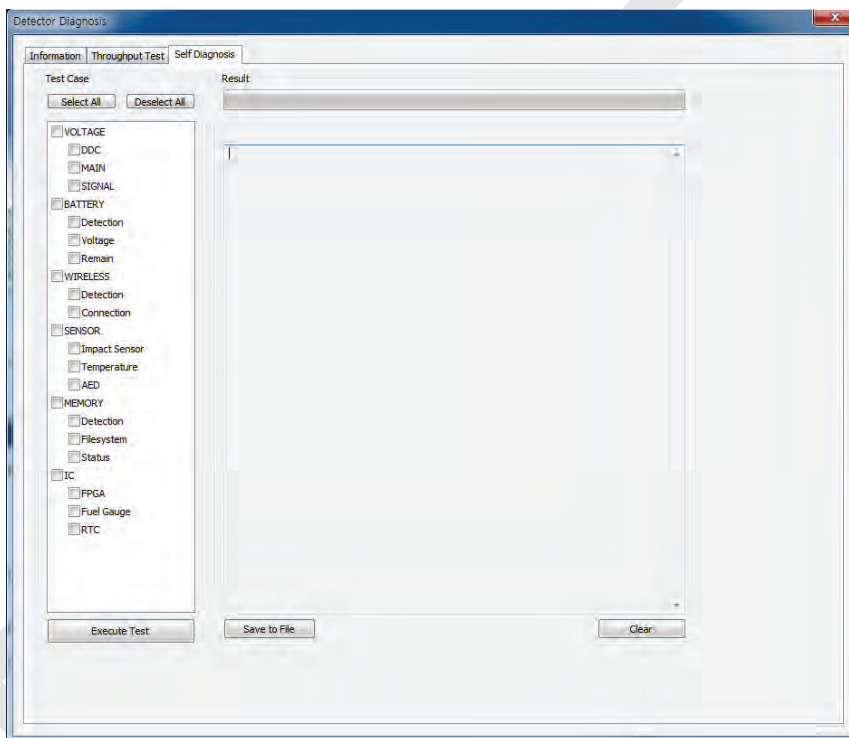

Category	Item	Form	Expected problem	Action
<b>Voltage</b>	DDC	Decision	Poor condition of a tether interface cable. Poor power supply to the wired operation mode.	Change a tether cable. Contact a service engineer.
	MAIN	Decision	Poor power supply to the processor.	Contact a service engineer.
	SIGNAL	Decision	Poor power supply to FPGA	Contact a service engineer.
<b>Battery</b>	Detection	Decision	Unattached battery	Check if a battery is inserted.
			Defective circuit connected to a battery pack.	Contact a service engineer.

	Voltage	Information	N/A	N/A
	Remain	Information	N/A	N/A
<b>Wireless</b>	Detection	Decision	Defective wireless module	Contact a service engineer.
	Connection	Decision	Inconsistent environment of the wireless communication Defective wireless module	Check obstacles and distance between a detector and SCU. Contact a service engineer.
<b>Sensor</b>	Impact Sensor	Decision	Defective shock sensor	Contact a service engineer.
	Temperature	Decision	Defective temperature sensor	Contact a service engineer.
	AED	Decision	Defective AED sensor	Contact a service engineer.
<b>Memory</b>	Detection	Decision	The calibration data is inapplicable. Not available to save backup images. Not available to save logs.	Contact a service engineer.
	File System	Decision	The calibration data is inapplicable. Not available to save backup images. Not available to save logs.	Contact a service engineer.
	Status	Information	N/A	N/A
<b>IC</b>	FPGA	Decision	Not available to take images fomr the detector.	Contact a service engineer.
	Fuel Gauge	Decision	Not available to check the remaining of a battery pack.	Contact a service engineer.
	RTC	Decision	Errors in log acquisition time.	Contact a service engineer.

### Self-Diagnosis Items of SCU

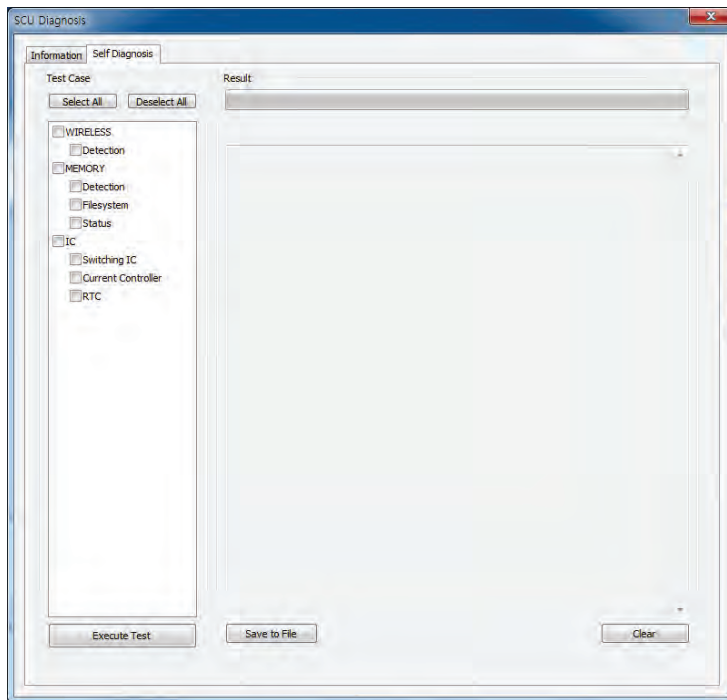

Category	Item	Form	Expected problem	Action
<b>Wireless</b>	Detection	Decision	Defective wireless module	Contact a service engineer.
	Detection	Decision	Not available to save logs.	Contact a service engineer.
<b>Memory</b>	File System	Decision	Not available to save logs.	Contact a service engineer.
	Status	Decision	N/A	N/A
<b>IC</b>	Switching IC	Decision	Not available to connect the detector and PC.	Contact a service engineer.
			Not available to block	
	Current Controller	Decision	overcurrent when using the wired mode.	Contact a service engineer.
	RTC	Decision	Errors in log acquisition time.	Contact a service engineer.

## 7.3 Cleaning and Disinfection

After using the detector and peripheral equipments for examination, use germicidal disinfecting wipes or cloth with mild diluted disinfectant detergent to clean surfaces of the product.

### Recommended Detergent Foam

- Recommended disinfectant wipe
  - **Wip' anios** manufactured by **Anios**
  - **Sani-cloth Active Wipes** by **PDI**
- Recommended disinfectant product
  - **Sulfa'safe**
  - Storage temperature: **5°C ~ 35°C**

### How to Use Detergent Foam

- 1 Prepare the disinfectant detergent and a clean and dry non-woven cloth.
- 2 Use the spray bottle to spray detergent to the cloth and clean the equipment.
- 3 After it has been cleaned, leave the equipment un-used for 15 minutes.
- 4 Conduct cleaning once a week or in case of contamination.



- Do not re-use wipes.
- Be careful to use disinfectant detergent which can cause irritation to eyes and skin.
- Use in well-ventilated areas, and wear gloves at all times.
- Do not clean the equipment with its power on.
- Do not use abrasive brush and scraper to clean the product.
- Be careful not to make liquid soak when cleaning battery bay and the connector on the side of products.



- Other Disinfectant detergent compliant to conditions listed below may be used following proper procedures according to its own manual.
  - European Biocidal Products designed for surface disinfection (Directive 98/8/EC)
  - Detergent with composition of Didecyldimethylammonium chloride, polyhexamethylene biguamide hydrochloride.

## 7.4 Product Initialization

If the connection status of system is not stable or setting value is not correct, user can initialize the products.

### 7.4.1 SCU Initialization

- 1 Click Configuration button of SCU after running the **VIVIX Setup** program.
- 2 Click **Factory Reset** button in **Configuration** dialogue.
- 3 Wait for SCU to be initialized and rebooted automatically.
- 4 Check whether SCU initialization is completed.

#### Default value of SCU initialization

Item	Default Value
<b>Network</b>	
IP Address	169.254.2.100
Subnet Mask	255.255.0.0
Gateway	169.254.2.100
<b>AP</b>	
AP On/Off	ON
Frequency	5GHz
Country	KR
Band	40MHz
Channel	+36
SSID	vivix
Key	1234567890
<b>Test Mode</b>	
On/Off	
Period	
<b>Trigger</b>	
Method	Packet
Polarity	Auto

## 7.4.2 Detector Initialization

- 1 Click Configuration button of Detector after running the **VIVIX Setup** program.
- 2 Click **Factory Reset** button in **Configuration** dialogue.
- 3 Wait for Detector to be rebooted automatically.
- 4 Check whether detector initialization is completed.

### Default value of detector initialization

Item	Default Value
<b>Network</b>	
IP Address	169.254.1.10
Subnet Mask	255.255.0.0
Gateway	169.254.2.100
<b>WNetwork</b>	
SSID	vivix
Key	1234567890
AP Scan	OFF
<b>AP</b>	
AP On/Off	OFF
Frequency	5GHz
Country	KR
Band	40MHz
Channel	+36
SSID	vivix_ap
Key	1234567890
Test Pattern Type	20 sec.
Image Timeout Time	Disable
<b>Power Management</b>	
Sleep	OFF
Sleep After	10 min.
Shut Down	OFF
Shut Down after	30 min.
Power Off	By Detector
Wireless Only	OFF

### 7.4.3 Wireless Initialization of Detector

- 1 Turn off the detector.
- 2 Press and hold both the power button and AP button over 3 seconds.
- 3 Initialization will be conducted when orange LED is flickering, after that, the detector will be turned off automatically.
- 4 Turn on the detector and check whether detector initialization is completed.

#### Default value of wireless initialization

Item	Default Value
<b>Network</b>	
IP Address	169.254.1.10
Subnet Mask	255.255.0.0
Gateway	169.254.2.100
<b>WNetwork</b>	
SSID	vivix
Key	1234567890
Wireless Only	OFF
<b>AP</b>	
AP On/Off	OFF
Frequency	5GHz
Country	KR
Band	40MHz
Channel	+36
SSID	vivix_ap
Key	1234567890



- When processing the wireless initialization of a detector, only the detector's network information is initialized as a default value.

## 7.5 Replacing the Fuse of SCU (SCU Basic only)

There are 2 fuses attached on the standard SCU for the purpose of electrical accident precaution, in case of over current from external power input. Stop using the SCU immediately when the fuse is blown.



### Fuse Information

Item	Specifications
Model	Littelfuse® 218002 (2EA)
Type	Time Lag Cartridge Fuse
Amp Rating	2A
Voltage Rating	250V



- Pull the plug out and turn all the devices off before changing the fuse.
- First, resolve the cause why the fuse is blown. Replace the fuse to the one provided as an option (1 set / 2 ea) or to the one with same specifications when the fuse is out.
- Be careful not to touch both the patient and the fuse holder at the same time or let the patient touch the fuse holder.

### How to Replace the Fuse

No.	Description
1	 <p>Separate the fuse from the holder located power input port on the back side of standard SCU by pulling the fuse holder.</p>
2	 <p>After checking, replace the fuse with correct specifications in case of need.</p>
3	<p>-</p> <p>Insert the fuse holder again.</p>



---

## 8. Troubleshooting

---

This section gives information about troubleshooting.

DRAFT

## 8.1 Troubleshooting

When you encounter problems while using the equipment, search for the table below for the problem or error messages and try the solutions. If the problem persists, turn off the detector and consult your sales representative or a distributor. Please refer to the details of the following symptoms or error messages.



- Troubleshooting must be performed by service engineer who is authorized by Vieworks. If an unqualified person performs troubleshooting on the system resulting in damaging the detector, software or hardware, then the Vieworks or its representative is not responsible for the detector repair regardless of remain warranty. For more detailed information, refer to <Warranty>.

### 8.1.1 Failed to Turn the Detector On

#### Symptom

- Failed to turn on the power of the detector.

#### Expected Causes

- Not installing battery pack well
- Dead battery pack
- Battery pack or Detector is broken down

#### Solutions

- 1 Install battery pack
- 2 Charge battery pack
- 3 Check the result after getting rid of the battery pack and connecting the tether cable.
- 4 Replace other battery packs and check the result of it.
- 5 Replace other Detectors and check the result of it.
- 6 Replace corresponding devices.

### 8.1.2 The Power Switch of SCU or Status LED is not worked

#### Symptom

- The power switch of Basic SCU or SCU mini is not working.
- The status LED of SCU is not responding.

#### Expected Causes

- Power cable is broken down.
- Errors in the fuse
- Internal circuit is broken down.

#### Solutions

- 1 Check the connection between AC power cable and SCU Basic.

- 2 Check the connection between DC power cable and SCU mini.
- 3 Turn off the power switch and turn on again and then check the fan or status of back side.
- 4 Replace another SCU and check the result of it
- 5 Replace the fuse of standard SCU. (refer to Change fuse of SCU)
- 6 Replace corresponding devices.

### 8.1.3 Communication Test is failed

#### Symptom

- Transmission error is occurred, failure of communication test is occurred.

#### Expected Causes

- Network connection problem
- Network setting problem
- PC environment setting problem
- Wireless environment environment problem
- Devices failure

#### Solutions

- 1 Check the connection of network cable between Workstation and SCU.
- 2 Check if the accurate network cable is used or not. (CAT 5E or 6)
- 3 Set the network information of Workstation, SCU and detector again.
- 4 Check whole workstation environment again such as firewall setting and release the power save mode.
- 5 Check surrounding wireless communication environment.
- 6 Boot up detector and SCU again by processing initialization. (Refer to <7.4 Product Initialization>.)
- 7 Replace other SCU and Detectors and check the result of it
- 8 Replace corresponding devices.

### 8.1.4 The Active LED and Data LED of the Detector are blinking

#### Symptom

- The active LED and data LED is blinking when power LED is ON.

#### Expected Causes

- Detector registration error
- Data transmission error

#### Solutions

- 1 Turn on SCU again
- 2 Check the network cable connection
- 3 Check the workstation environment and network information again
- 4 Check if the surrounding wireless communication is good
- 5 Check cable connection again when connected with tether interface cable
- 6 Replace other devices and check the result of it

- 7 Replace corresponding devices.

### 8.1.5 Errors in Detector LED

#### Symptom

- All LED lamps of detector are blinking.
- 2 LED lamps of detector are blinking and remaining is blinking slowly.

#### Expected Causes

- Internal hardware errors of the detector.

#### Solutions

- 1 Boot up the detector again and check the result of it
- 2 Replace the detector.

### 8.1.6 Rapid Consumption of Battery

#### Symptom

- Consumption of fully charged battery pack is fast.

#### Expected Causes

- Performance decrease caused by usage of long time.
- Usage of battery pack in low temperature environment.

#### Solutions

- 1 Replace to new battery pack if the battery pack has been used for a long time. (Battery pack is consumables)
- 2 Use battery pack in room temperature environment. Charging capacity of battery pack in low temperature environment will be decreasing.

### 8.1.7 Battery Pack or Installation Part of Battery is Getting Hot

#### Symptom

- Battery pack or compartment for installation of battery pack is getting hot.

#### Expected Causes

- Battery pack failure
- Detector Failure

#### Solutions

- 1 Do not use battery pack
- 2 Consult with service engineers of Vieworks.

---

## 9. Regulatory Information

---

This section gives explanation about the regulatory information and standard related to the products

Medical Equipment Safety Standards

Radio Frequency Compliance Information

Labels and Symbols

Guidance and Manufacturer Declaration for EMC

## 9.1 Medical Equipment Safety Standards

### 9.1.1 Medical Equipment Classification

Item	Description
Type of protection against electrical shock	Class I equipment Internally powered
Degree of protection against electrical shock	Type B applied parts
Degree of protection against ingress of water	IPX0
Operation mode	Continuous operation
Flammable anesthetics	NOT suitable for use in the presence of a flammable anesthetic mixture with air or with oxygen or nitrous oxide.

### 9.1.2 Product Safety Standard

#### South Korea

전기, 기계적 안전성에 관한 시험: IEC 60601-1과 식품의약품안전청고시 제 2009-137호에 따른다.  
전자파장해방지에 관한 시험: IEC 60601-1-2에 따른다.

#### 전자파 간섭 (EMI)

전자파 전도	식품의약품안전청 고시 2009-54호 1종 A급 기기로서 별표 1의 5.1 식품의약품안전청 고시 2009-54호 별표 1의 전자파장해 (간섭)
전자파 방사	식품의약품안전청 고시 2009-54호 1종 A급 기기로서 별표 1의 5.2 식품의약품안전청 고시 2009-54호 별표 1의 전자파장해(간섭)

#### 전자파 내성 (EMS)

정전기방전(ESD) 시험	식품의약품안전청 고시 2009-54호 별표 2의 36.202/36.202.2/ KN61000-4-2
방사성 RF 전자기장 시험	식품의약품안전청 고시 2009-54호 별표 2의 36.202/36.202.3/ KN61000-4-3
전기적 빠른 과도현상 (EFT) 시험	고시 2009-54호 별표 2의 36.202/36.202.4/ KN61000-4-4
서지(Surge) 시험	고시 2009-54호 별표 2의 36.202/36.202.5/KN61000-4-5
전도성 RF 전자기장 시험	식품의약품안전청 고시 2009-54호 별표 2의 36.202/36.202.6/ KN61000-4-6
전원주파수자기장 시험	고시 2009-54호 별표 2의 36.202/36.202.8/ KN61000-4-8
전원공급 입력선의 전압 강하, 순간정전 및 전압변동 시험	식품의약품안전청 고시 2009-54호 별표 2의 36.202/36.202.7/KN61000-4-11
전원주파수 변동	IEC 60601-1:2007(ed.3) 10.2.2 power supply 및 식품의약품안전청 고시 2009-54호 별표 2의 36.202.14

**U.S.A / Canada**

Item	
<b>IEC 60601-1(ed.2 am1+ am2+ co1)</b>	Medical electrical equipment- Part1: General requirements for safety
<b>UL 60601-1(ed.2)</b>	-
<b>CSA-C22.2 No. 601-1-M90 (R2006)</b>	Medical electrical equipment – Part 1: General requirements for safety (adopted amendment 2:1995 to IEC60601-1)
<b>IEC 60601-1-2: 2007 (ed.3)</b>	Medical electrical equipment-Part 1-2: Collateral standard: Electromagnetic compatibility
<b>IEC 60601-1-4: 2000 (ed.1.1)</b>	Medical electrical equipment- Part 1-4: Collateral Standard: Programmable electrical medical systems
<b>IEC 62304:2006</b>	Medical device software-software life cycle processes
<b>ISO 14971:2012</b>	Medical Device- Application of risk management to medical devices

**European Union**

Item	
<b>MDD (Medical Device Directive)</b>	93/42/EEC as amended by 2007/47/EC
<b>EN ISO 13485:2012</b>	Medical devices – Quality Management systems – Requirements for regulatory purposes
<b>EN 60601-1: 2007(ed.3)</b>	Medical electrical equipment- Part1: General requirements for safety
<b>IEC 60601-1-2: 2007(ed.3)</b>	Medical electrical equipment-Part 1-2: Collateral Standard : Electromagnetic compatibility-Requirements and tests
<b>IEC 60601-1-4: 2000(ed.1.1)</b>	Medical electrical equipment- Part 1-4: Collateral Standard : Programmable electrical medical systems
<b>IEC 62304:2006</b>	Medical device software-Software life cycle processes
<b>ISO 14971: 2012</b>	Medical device – Application of risk management to medical devices.

## 9.2 Radio Frequency Compliance Information

Country	Item
U.S.A	<ul style="list-style-type: none"> <li>FCC Part 15.107 Subpart (b) / 15.109(g) Subpart B</li> </ul>
	<ul style="list-style-type: none"> <li>FCC Part 15 Subpart E 15.407</li> </ul>
	<ul style="list-style-type: none"> <li>FCC Part 15 Subpart C 15.247</li> </ul>
European Union	<ul style="list-style-type: none"> <li>ETSI EN 301 489-1 V1.8.1 (EMC)</li> </ul>
	<ul style="list-style-type: none"> <li>ETSI EN 301 489-17 V2.1.1 (EMC)</li> </ul>
	<ul style="list-style-type: none"> <li>EN 300 328 V.1.7.1; EN 301 893 V1.6.1 (RF)</li> </ul>
	<ul style="list-style-type: none"> <li>EN 62311:2008 (RF Exposure)</li> <li>ETSI EN 300 328 V1.7.1; EN 301 893, V1.5.1 (Radio Spectrum)</li> </ul>
South Korea	<ul style="list-style-type: none"> <li>Clause 3, Article 58-2 of Radio Waves Act</li> </ul>
	<ul style="list-style-type: none"> <li>Clause 2, Article 58-2 of Radio Waves Act</li> </ul>
Japan	<ul style="list-style-type: none"> <li>Article 2-1-19, 2-1-19-3, 2-1-19-3-2 of the Radio law (MIC)</li> </ul>

### 9.2.1 FCC Compliance

- This equipment has been tested and found to comply with the limits for a Class B digital device, pursuant to part 15 of **FCC Rules**. These limits are designed to provide reasonable protection against harmful interference in a residential installation.
- Operation is subject to the following conditions.
  - This device may not cause harmful interference.
  - This device must accept any interference received, including interference that may cause undesired operation.
- This equipment generates, uses, and can radiate radio frequency energy and, if not installed and used in accordance with the instruction, may cause harmful interference to radio communications. However, there is no guarantee that interference will not occur in a particular installation. If this equipment does cause harmful interference to radio or television reception, which can be determined by turning the equipment off and on, the user is encouraged to try to correct the interference by one or more of the following measure.
  - Reorient or relocate the receiving antenna.
  - Increase the separation between the equipment and receiver.
  - Connect the equipment into an outlet on a circuit different from where the receiver is connected.
  - Consult the distributor or an experienced radio/TV technician for help.



- Change or modification which is not expressly approved by the party responsible for compliance could void the user's authority to operate the equipment.
- 5.15-5.35GHz band is restricted to indoor operations only.



- The **SAR** limit set by the FCC is 1.6 W/kg.
  - The highest **SAR** value for this model when tested for use at the front is 0.568 W/kg.
- The front side of a detector should be used for image acquisition.



### 9.2.2 FCC SAR

- OET Bulletin 65, Supplement C (Edition 01-01)

### 9.2.3 CE R&TTE SAR

Item	
<b>EN 62311:2008</b>	Assessment of electronic and electrical equipment related to human exposure restrictions for electromagnetic fields. (0 Hz - 300 GHz)
<b>EN 62209-1:2006</b>	Human exposure to radio frequency fields from hand-held and body-mounted wireless communication devices – Human models, instrumentation, and procedures. <ul style="list-style-type: none"> <li>• Part 1: Procedure to determine the specific absorption rate (SAR) for hand-held devices used in close proximity to the ear (frequency range of 300 MHz to 3 GHz).</li> </ul>
<b>EN 62209-2:2010</b>	Human Exposure to Radio Frequency Fields from Handheld and Body-Mounted Wireless Communication Devices – Human models, Instrumentation, and Procedures. <ul style="list-style-type: none"> <li>• Part 2: Procedure to determine the specific absorption rate(SAR) for mobile wireless communication devices used in close proximity to the human body (frequency range of 300 MHz to 6 GHz).</li> </ul>

### 9.3 Labels and Symbols

The **VIVIX-S 1012N** detector and relevant components have labels attached on them. The contents and locations of each label are indicated below.

#### 9.3.1 Label

##### VIVIX-S 1012NA / 1012NB (Wired Detector)

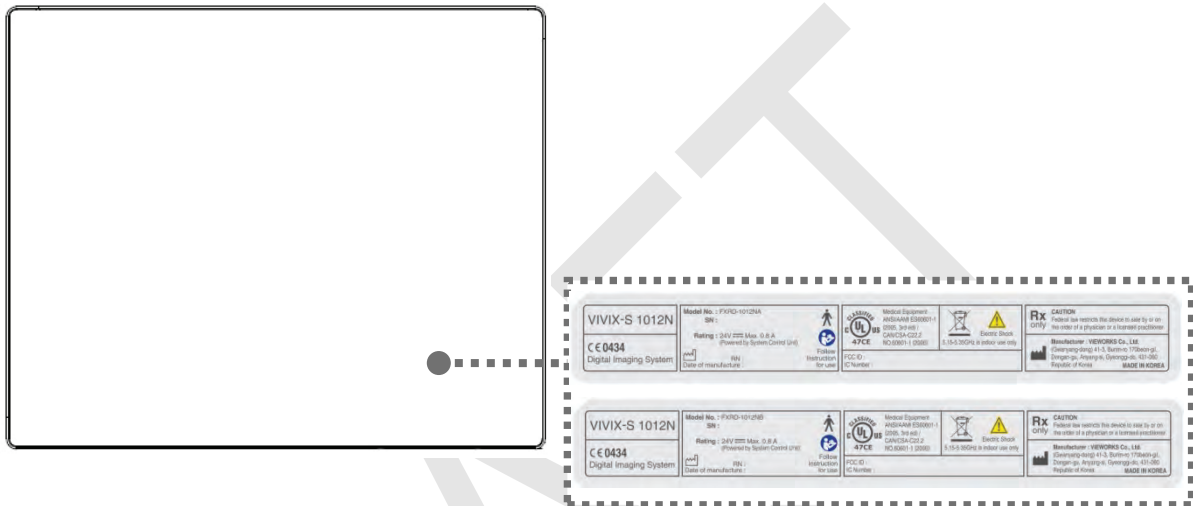

##### VIVIX-S 1012NAW / 1012NBW (Wireless Detector)

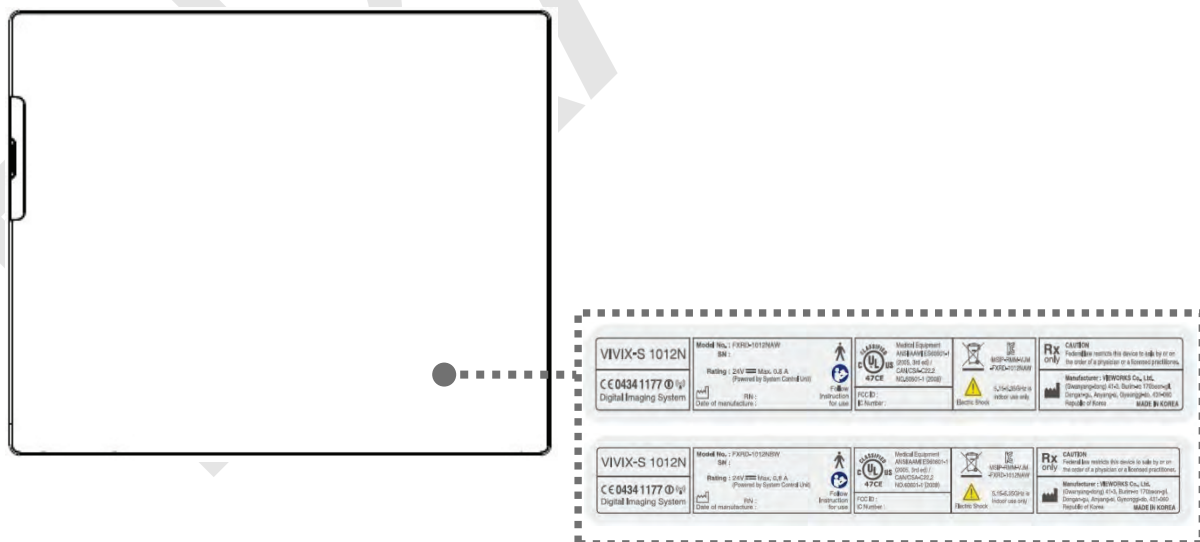

Battery





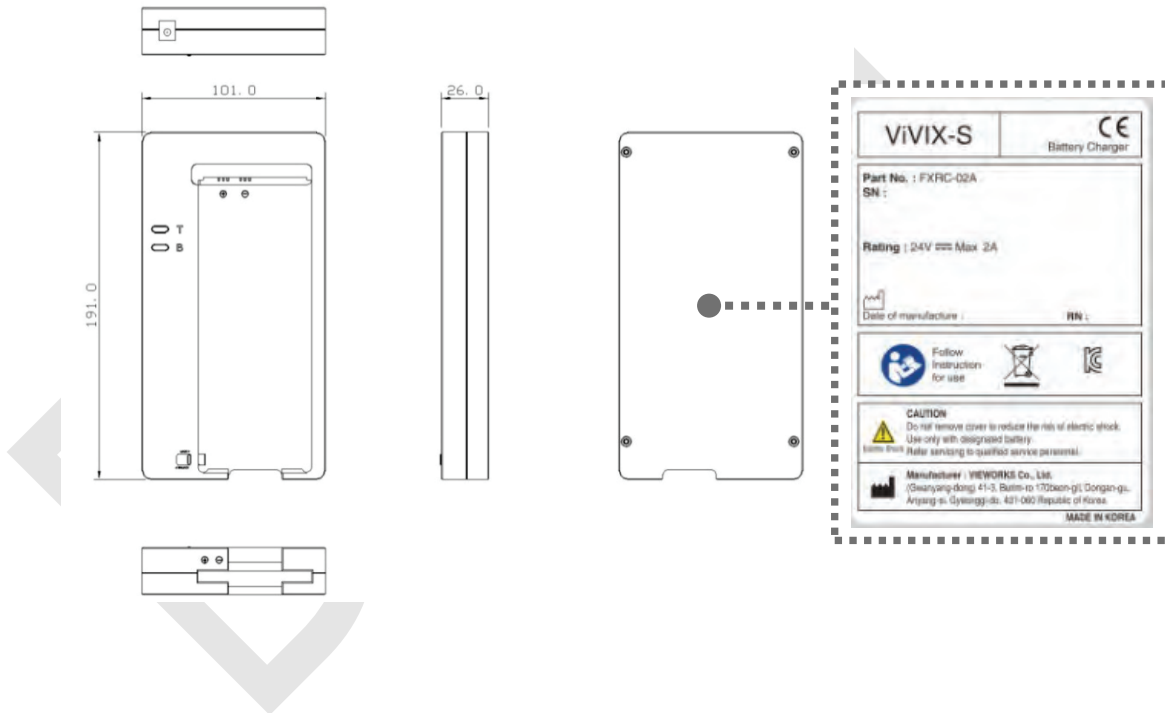

Battery Charger

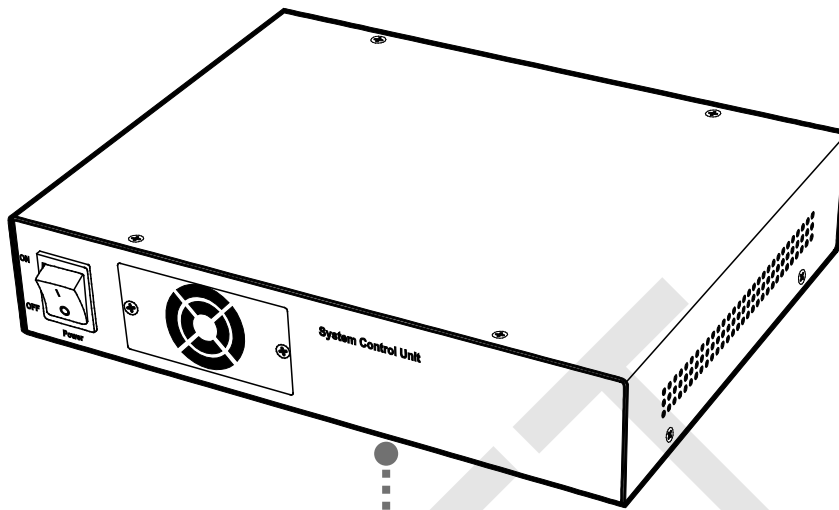

SCU Basic (FXRS-02A)



<b>VIVIX-S</b>		<b>CE</b> System Control Unit
<b>Model No. : FXRS-02A</b> <b>SN :</b>		 Follow Instruction for use
<b>Rating : 100 - 240 V~, 50/60 Hz, 2.0-0.8 A</b>		
 Date of manufacture :		<b>RN :</b>
		 Electric Shock
FCC ID : IC Number :		 5.15-5.35GHz is indoor use only
Manufacturer : VIEWWORKS Co., Ltd. (Gwanyang-dong) 41-3, Burim-ro 170beon-gil, Dongan-gu, Anyang-si, Gyeonggi-do, 431-060 Republic of Korea <p style="text-align: right;"><b>MADE IN KOREA</b></p>		

SCU Basic (FXRS-03A)

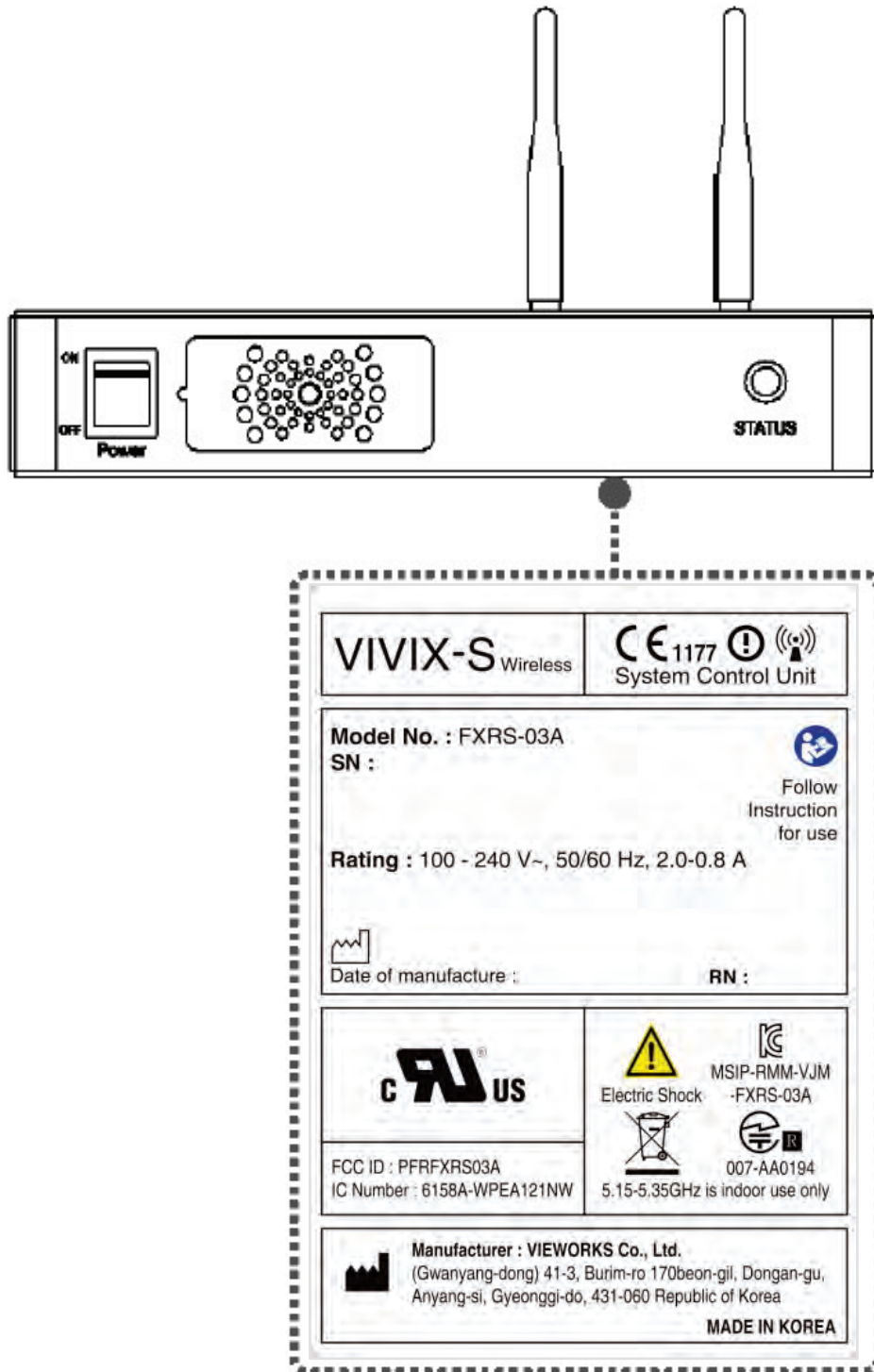

SCU mini (FXRS-04A)

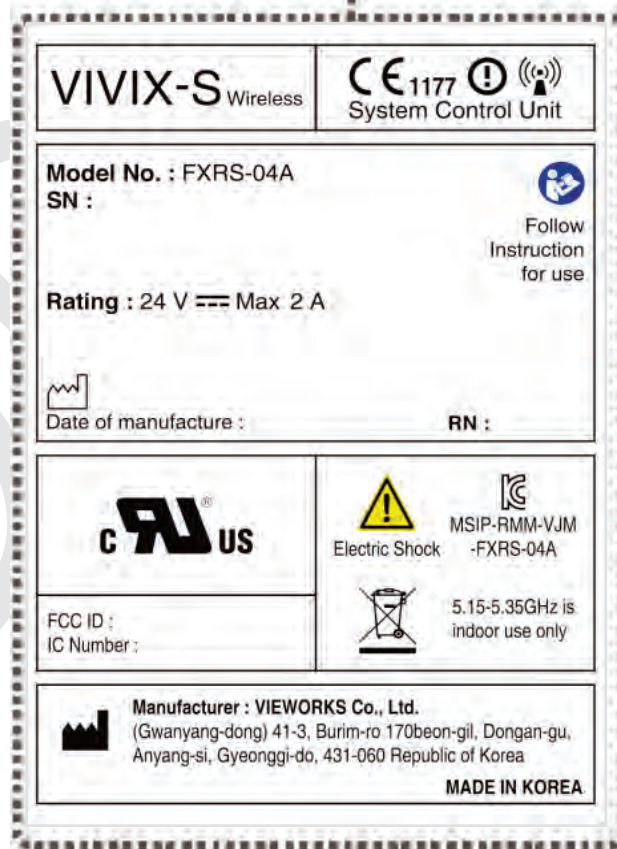
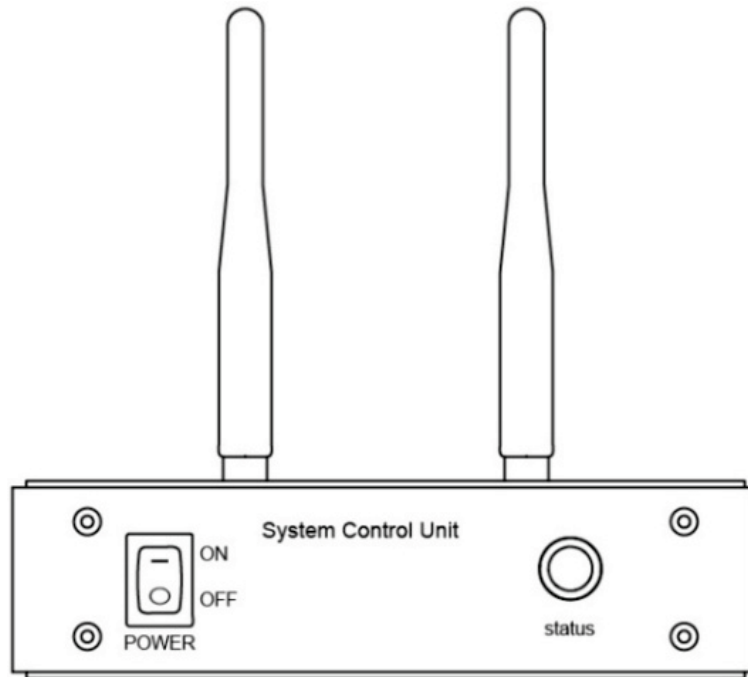

Outer Box



[TBD]

### 9.3.2 Product Serial Number

#### Serial Number Composition

The serial numbers for each product or accessory are composed as follows.

V	1	D	A	B	J	0	0	1
Item	Composition			Year	Month	Serial number		



- Revision will be updated in case of follows.
  - Mass production or a large amount of order.
  - Exterior alteration.
- Item code will be produced based on internal management standard of vieworks.
- Composition code is like follows.
  - D: Detector
  - S: SCU
  - C: Battery Charger
- Range of Serial Number is 001 ~ 999.

#### Initial Per Year

11	12	13	14	15	16	17	18	19	20
AA	AB	AC	AD	AE	AF	AG	AH	AI	BJ

















#### Initial Per Month

1	2	3	4	5	6	7	8	9	10	11	12
A	B	C	D	E	F	U	V	W	X	Y	Z

#### Composition of Serial Number for Each Item

Model	Composition	Serial Number
1012NA	Detector	VCDAEA001
1012NB	Detector	VDDAEA001
1012NAW	Detector	VADAEA001
1012NBW	Detector	VBDAEA001
FXRC-02A	Battery Charger	VACAEA001
FXRS-03A	SCU Basic	VCSAEA001
FXRS-04A	SCU mini	VASAEA001

### 9.3.3 Product Symbols

Symbol	Description
	Direct current
	Direct current
	Alternating current
	Protective earth (Ground)
	Equipotentiality
	Power on
	Power on for part of the equipment
	Power off
	Power off for part of the equipment
	Attention, consult accompanying documents
	General warning sign
	Warning sign for electricity
	This Mark shows compliance with both Canadian and U.S. safety requirements. With Respect to electric shock, fire, and mechanical hazards only. In accordance with UL60601-1 and CAN/CSA C22.2 No. 601.1.
	This mark shows compliance of the essential requirement and other relevant provisions of Directive 93/42/EEC as amended by 2007/47/EC.
	Non-ionizing radiation
	Read and understand all instructions and warning labels in the product documentation before using the equipment. Keep manual for future reference.
	Dealing with a medicine that can only be given by a prescription from a doctor and you should use a certain medication that a doctor recommended.
	General mandatory action sign
	This mark indicates that this equipment must be handled with care.
	Do not jolt or apply excessive load to the equipment.
	This is a Type B Applied Part according to UL 60601-1 and EN 60601-1.
	This mark indicates that the equipment must be collected separately under the Directive on Waste Electrical and Electronic Equipment 2002/96/EC (WEEE) in the European Union. (For European Union)
	This mark indicates that the battery must be collected separately under the Directive on Waste Electrical and Electronic Equipment 2002/96/EC (WEEE) in the European Union. (For European Union)



## 9.4 Guidance and Manufacturer's Declaration for EMC



This device has been tested for EMI/EMC compliance, but interference can still occur in an electromagnetically noisy location. Attempt to maintain a suitable distance between electrical devices to prevent malfunction.

### 9.4.1 Electromagnetic Emissions

The Equipment Under Test (EUT) is intended for use in the electromagnetic environment specified below. The customer or user of the EUT should assure that it is used in such an environment.

Immunity test	Compliance	Electromagnetic Environment
<b>RF Emissions (CISPR 11)</b>	Group 1	The EUT uses RF energy only for its internal function. Therefore, its RF emissions are very low and are not likely to cause any interference in nearby electronic equipment.
<b>RF Emissions (CISPR 11)</b>	Class B	
<b>Harmonic emissions (IEC 61000-3-2)</b>	Class A	The EUT is suitable for use in all establishments other than domestic and those directly connected to the public low-voltage power supply network that supplies buildings used for domestic purposes.
<b>Voltage fluctuations/ Flicker emissions (IEC 61000-3-3)</b>	Complies	

### 9.4.2 Electromagnetic Immunity

The ViVIX-S 1012N system is intended for using in the electromagnetic environment specified below. The user of this system should assure that it is used in the following environment.

#### Electrostatic Discharge (ESD) IEC 61000-4-2

Item	Description
<b>Immunity test</b>	• Electrostatic discharge (ESD) IEC 61000-4-2
<b>IEC 60601 test condition</b>	• Contact $\pm 6\text{kV}$ • Air $\pm 8\text{kV}$
<b>Compliance Level</b>	• Contact $\pm 6\text{kV}$ • Air $\pm 8\text{kV}$
<b>Electromagnetic Environment - Guidance</b>	• Floors should be wood, concrete or ceramic tile. • If floors are covered with synthetic material, the relative humidity should be at least 30%.

**Electrical Fast Transient/Burst IEC 61000-4-4**

Item	Description
<b>Immunity test</b>	<ul style="list-style-type: none"> <li>Electrical fast transient/burst IEC 61000-4-4</li> </ul>
<b>IEC 60601 test condition</b>	<ul style="list-style-type: none"> <li>Power supply lines <math>\pm 2\text{kV}</math></li> <li>Input / output lines <math>\pm 1\text{kV}</math></li> </ul>
<b>Compliance Level</b>	<ul style="list-style-type: none"> <li>Power supply lines <math>\pm 2\text{kV}</math></li> <li>Input / output lines <math>\pm 1\text{kV}</math></li> </ul>
<b>Electromagnetic Environment - Guidance</b>	<ul style="list-style-type: none"> <li>Main power quality should be that of a typical commercial or hospital environment.</li> </ul>

**Surge IEC 61000-4-5**

Item	Description
<b>Immunity test</b>	<ul style="list-style-type: none"> <li>Surge IEC 61000-4-5</li> </ul>
<b>IEC 60601 test condition</b>	<ul style="list-style-type: none"> <li>Differential mode <math>\pm 1\text{kV}</math></li> <li>Common mode <math>\pm 2\text{kV}</math></li> </ul>
<b>Compliance Level</b>	<ul style="list-style-type: none"> <li>Differential mode <math>\pm 1\text{kV}</math></li> <li>Common mode <math>\pm 2\text{kV}</math></li> </ul>
<b>Electromagnetic Environment - Guidance</b>	<ul style="list-style-type: none"> <li>Main power quality should be that of a typical commercial or hospital environment.</li> </ul>

**Voltage Dips, Short Interruptions/Voltage Variations on Power Supply Input Lines IEC 61000-4-11**

Item	Description
<b>Immunity test</b>	<ul style="list-style-type: none"> <li>Voltage dips, short interruptions and voltage variations on power supply input lines IEC 61000-4-11</li> </ul>
<b>IEC 60601 test condition</b>	<ul style="list-style-type: none"> <li><math>&lt; 5\% U_T</math> (<math>&gt; 95\%</math> dip in <math>U_T</math>) for 0.5 cycle.</li> <li><math>40\% U_T</math> (60% dip in <math>U_T</math>) for 5 cycles.</li> <li><math>70\% U_T</math> (30% dip in <math>U_T</math>) for 25 cycles.</li> <li><math>&lt; 5\% U_T</math> (<math>&lt; 95\%</math> dip in <math>U_T</math>) for 5 sec.</li> </ul>
<b>Compliance Level</b>	<ul style="list-style-type: none"> <li><math>&lt; 5\% U_T</math> (<math>&gt; 95\%</math> dip in <math>U_T</math>) for 0.5 cycle.</li> <li><math>40\% U_T</math> (60% dip in <math>U_T</math>) for 5 cycles.</li> <li><math>70\% U_T</math> (30% dip in <math>U_T</math>) for 25 cycles.</li> <li><math>&lt; 5\% U_T</math> (<math>&lt; 95\%</math> dip in <math>U_T</math>) for 5 sec.</li> </ul>
<b>Electromagnetic Environment - Guidance</b>	<ul style="list-style-type: none"> <li>Main power quality should be that of a typical commercial or hospital environment.</li> <li>If the user of the EUT image intensifier requires continued operation during power mains interruptions, it is recommended that the EUT image intensifier be powered from an uninterruptible power supply or a battery.</li> </ul>



$U_T$  is the AC power prior to approving the test level voltage.

**Power Frequency (50/60 Hz) Magnetic Field IEC 61000-4-8**

Item	Description
Immunity test	• Power frequency (50/60 Hz) magnetic field IEC 61000-4-8
IEC 60601 test condition	• 3 A/m
Compliance Level	• 3 A/m
Electromagnetic Environment - Guidance	• Power frequency magnetic fields should be at levels characteristic of a typical location in a typical commercial or hospital environment.

**Conducted RF IEC 61000-4-6 / Radiated RF IEC 61000-4-3**

Item	Description
Immunity test	• Conducted RF IEC 61000-4-6 • Radiated RF IEC 61000-4-3
IEC 60601 test condition	• 3 Vrms 150 kHz to 80 MHz • 3 V/m 80 MHz to 2.5 GHz
Compliance Level	• 3 Vrms 150 kHz to 80 MHz • 3 V/m 80 MHz to 2.5 GHz

- Portable and mobile RF communications equipment should be used no closer to any part of the EUT, including cables, than the recommended separation distance calculated from the below equations applicable to the frequency of the transmitter.

$$d = \left[ \frac{3.5}{V_1} \right] \sqrt{P} \quad d = \left[ \frac{3.5}{V_1} \right] \sqrt{P} \text{ 80 MHz to 800 MHz} \quad d = \left[ \frac{7}{E_1} \right] \sqrt{P} \text{ 80 MHz to 800 MHz}$$

**Electromagnetic Environment - Guidance**

- P is the maximum output power rating of the transmitter in watts (W) according to the transmitter manufacturer and d is the recommended separation distance in meters (m).
- Field strengths from fixed RF transmitters, as determined by an electromagnetic site survey, should be less than the compliance level in each frequency range b.
- Interference may occur in the vicinity of equipment marked with the symbol.



- At 80 MHz and 800 MHz, the higher frequency range applies.
- These guidelines may not apply in all situations. Electromagnetic propagation is affected by absorption and reflection from structures, objects and people.



- Field strengths from fixed transmitters, such as base stations for radio (cellular/cordless) telephones and land mobile radios, amateur radio, AM and FM radio broadcast and TV broadcast cannot be predicted theoretically with accuracy. To assess the electromagnetic environment due to fixed RF transmitters, an electromagnetic site survey should be considered. If the measured field strength in the location in which EUT is used exceeds the applicable RF compliance level above, EUT should be observed to verify normal operation. If abnormal performance is observed, additional measures may be necessary, such as reorienting or relocating EUT.
- Over the frequency range 150 kHz to 80 MHz, field strengths should be less than [V1] V/m.

---

## 10. Information

---

This section gives overview information for service and warranty of the product.

Service Information

Warranty

Revision History

## 10.1 Service Information

### 10.1.1 Product Lifetime

The estimated product lifetime may be up to five (5) years under the appropriate regular inspection and maintenance.

### 10.1.2 Regular Inspection and Maintenance

In order to ensure the safety of patients, operating personnel and third parties, and to maintain the performance and reliability of the equipment, be sure to perform regular inspection at least once a year. If necessary, clean up the equipment, make adjustments, or replace consumables.

There may be cases where overhaul is recommended depending on the conditions. Contact your sales representative or distributor for regular inspections or maintenance.

### 10.1.3 Repair

If a problem cannot be solved even after taking the measures indicated in Troubleshooting and contact your sales representative or a distributor for repairs. Please refer to the name label and provide the following information.

- Model name
  - **FXRD-1012NA / FXRD-1012NB**
  - **FXRD-1012NAW / FXRD-1012NBW**
- Serial number
  - 9 digit-number on the product label
- Explanation of problem
  - Describe as detailed as possible.

### 10.1.4 Replacement Parts Support

Performance parts (parts required to maintain the functioning of the product) of this product will be stocked for seven years after discontinuance of production, to allow for repair.

### 10.1.5 Consumables

The following consumable can deteriorate because of its characteristics and structure. For purchase of consumables, contact your sales representative or distributor.

- Battery pack: **FXRB-03A**

## 10.2 Warranty

Vieworks warrants that this product will be free from defects in materials and workmanship for a period of 24 months from the date of delivery. If any such product proves defective during this warranty period, Vieworks at its option, either will repair the defective product without charge for parts and labor, or will provide a replacement in exchange for the defective product. In order to obtain service under this warranty, Customer must notify Vieworks of the defect before the expiration of the warranty period and make suitable arrangements for the performance of service. Customer shall be responsible for packaging and shipping the defective product to the service center designated by Vieworks with shipping charges prepaid.

Vieworks shall pay for the return of the product to customer if the shipment is to a location within the country in which Vieworks designated service center is located. Customer shall be responsible for paying all shipping charges, duties, taxes, and any other charges for products returned to any other locations.

This warranty shall not apply to any defect, failure, or damage caused by improper or inadequate maintenance and care. Vieworks shall not be obligated to furnish service under this warranty to repair damage resulting from attempts by personnel other than Vieworks or its representatives to install, repair, or service this product, to repair damage resulting from improper use or connection to incompatible equipment or power source; or to service a product that has been modified or integrated with other products when the effect of such modification or integration increases the time or difficulty of servicing the product.

**THIS WARRANTY IS GIVEN BY VIEWORKS WITH RESPECT TO THIS PRODUCT IN LIEU OF ANY OTHER WARRANTIES, EXPRESS OR IMPLIED. VIEWORKS AND ITS VENDOR DISCLAIM ANY IMPLIED WARRANTIES OF MERCHANTABILITY OR FITNESS FOR A PARTICULAR PURPOSE. VIEWORKS RESPONSIBILITY TO REPAIR OR REPLACE DEFECTIVE PRODUCTS IS THE SOLE REMEDY PROVIDED TO THE CUSTOMER FOR BREACH OF THIS WARRANTY. VIEWORKS AND ITS VENDORS WILL NOT BE LIABLE FOR ANY INDIRECT, SPECIAL, INCIDENTAL, OR CONSEQUENTIAL DAMAGES IRRESPECTIVE OF WHETHER VIEWORKS OR THE VENDOR HAS ADVANCE NOTICE OF THE POSSIBILITY OF SUCH DAMAGES.**

There are no warranties which extend beyond the description mentioned in this document

### 10.3 Revision History

Version	Date	Descriptions
1.0	2015-02-??	• Initial Release



**VIEWWORKS**

---

**Vieworks Co., Ltd.**

(Gwanyang-dong) 41-3, Burim-ro 170beon-gil, Dongan-gu, Anyang-si,  
Gyeonggi-do, 431-060 Republic of Korea



Telephone: +82-70-7011-6161

Fax: +82-31-386-8631

Homepage: <http://www.vieworks.com>

**European representative: DONGBANG ACUPRIME**

1 Forrest Units, Hennock Road East, Marsh Barton, Exeter EX2 8RU, UK



Telephone: +44(0)-1392-829500

Homepage: <http://www.acuprime.com>

---