



**Pacific Northwest**  
NATIONAL LABORATORY

***Radiological Security Program***

**Wireless Optic Fiber Seal**  
**WOFS**  
**Installation Guide**

## Table of Contents

1	Introduction .....	3
2	Concept of Operation.....	3
3	Installation of the WOFS Receiver Hardware.....	4
4	Connecting the Receiver to the iRMS Using the Smart Digital Interface .....	6
5	Connecting the Receiver to an Alarm Panel or Other External Device .....	7
6	Receiver Antenna .....	8
7	Determining if a Device Requires a Normally Open, or Normally Closed State .....	9
8	Installation of the WOFS Transmitter Hardware .....	11
9	Installing or Changing Transmitter Batteries.....	12
10	Mounting Transmitter on Wall or Secured Surface.....	13
11	Setting up the Fiber Loop.....	14
12	Pairing a WOFS Transmitter to a WOFS Receiver.....	16
13	Unpairing a WOFS Transmitter to a WOFS Receiver .....	17
14	Receiver Status Lights .....	18
15	Transmitter Status Lights and Checking Transmitter Status .....	19
16	Regulatory Compliance .....	20

## 1 Introduction

The Wireless Optic Fiber Seal (WOFS) has been developed to support the Global Threat Reduction Initiative mission of securing radioactive material. Once installed, WOFS will prevent unmonitored access to essential equipment or materials. This guide provides installation and maintenance instructions for the WOFS system.

## 2 Concept of Operation

The WOFS system consists of a WOFS Receiver (see Figure 1) in wireless communication with a WOFS Transmitter (see Figure 2). The Transmitter is connected to a loop of fiber optic cable that will be wrapped around or through the object to be sealed. Sealed objects can include equipment racks, panels, doors, or drawers.

If the fiber optic cable is broken, WOFS will trigger an alarm indicating that the seal has been compromised. The WOFS is also equipped with a security features to resist attempts to “spoof” the optical signal.



Figure 1 - WOFS Receiver



Figure 2 - WOFS Transmitter

### 3 Installation of the WOFS Receiver Hardware

The WOFS Receiver can communicate with up to eight Transmitters (see Figure 3). The Receiver is typically connected to an alarm panel or to the Integrated Remote Monitoring System (iRMS).

- When the WOFS Receiver is integrated with an iRMS, WOFS supports a user interface at an operator security station that shows WOFS health, location of alarm, camera video, and the iRMS can send email and text message notifications.

*NOTE: Connecting the WOFS to an alarm panel or to an iRMS will be covered in Section 5. The functionality of the LEDs and buttons will be covered in Section 14.*

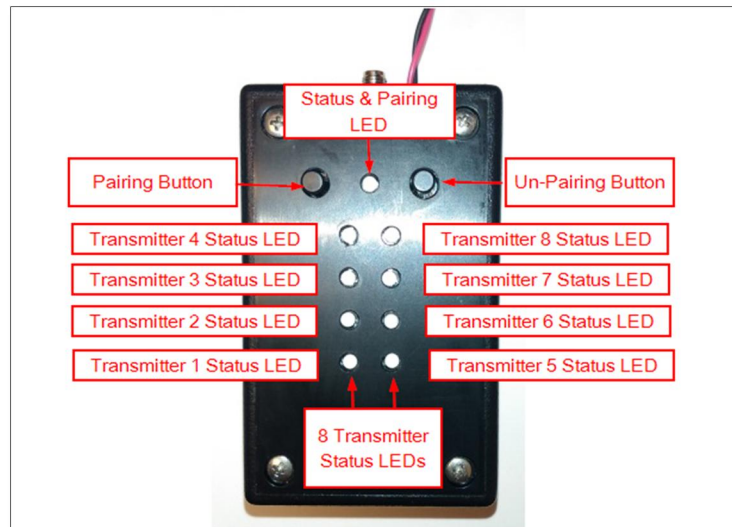

**Figure 3 - WOFS Receiver**

## Connecting Power

The Receiver is powered by +12 VDC supplied by the facility where the Receiver is installed.

1. Connect power to the terminals by removing the 4 recessed, Phillips-head screws and open the case to access the terminal blocks.
2. Turn off the source of the facility's +12VDC
3. Connect +12 VDC wire and ground wire to Receiver's DC Power terminals. Run the wires across the Strain Relief Zip ties, and through the hole next to the SMA antenna connector (see yellow-highlighted boxes in Figure 4).

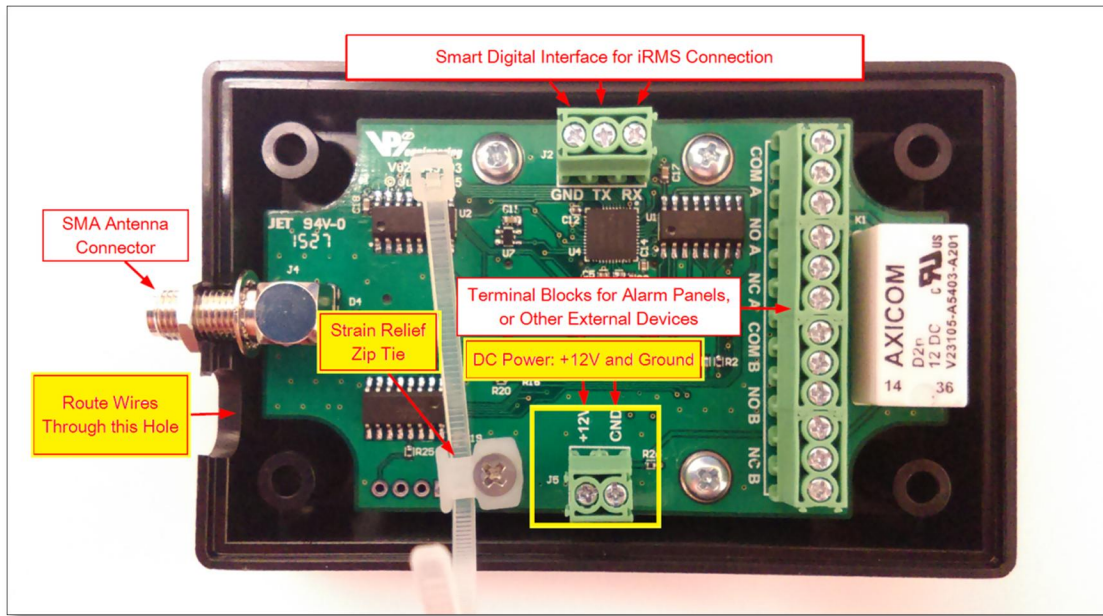

Figure 4 - Receiver PC board and terminal blocks

4. Connect the +12VDC wire and ground wire to the facility's power source, following NEC guidelines.  
**NOTE: Do NOT turn on the power source until all of the wiring process is complete, as instructed later in this manual.**

## 4 Connecting the Receiver to the iRMS Using the Smart Digital Interface

1. On the WOFS Receiver, attach a Ground wire to the Smart Digital Interface (SDI) Terminal Block to the location labeled GND (see yellow boxes in Figure 5).

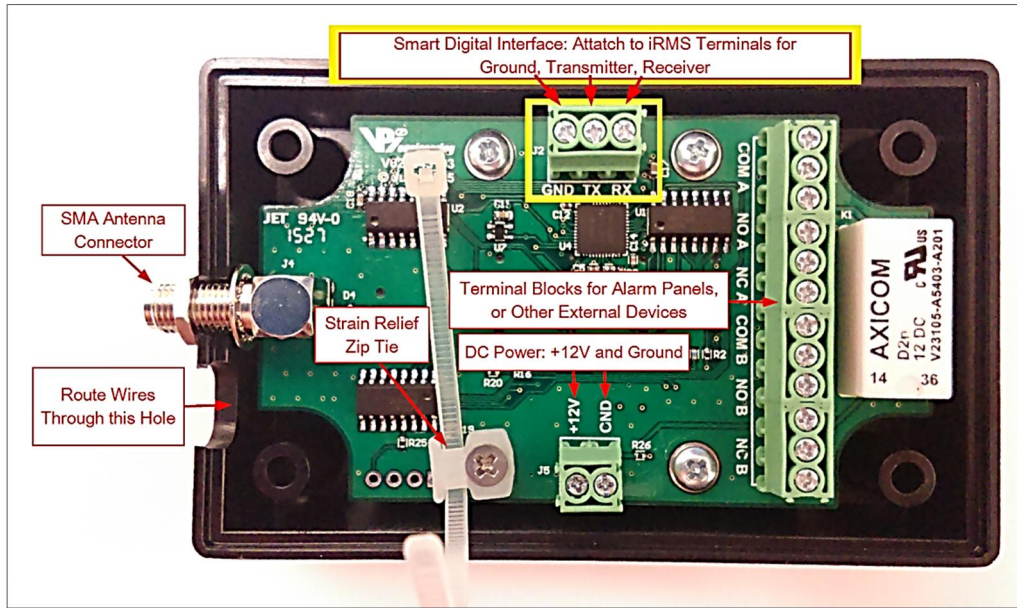

Figure 5 - Smart Digital Interface terminal block

2. Open the iRMS unit.
3. Attach the other end of the Ground wire to Terminal Block J8, at location screw #14 (see Figure 6). For more information, refer to the CHCT manual.

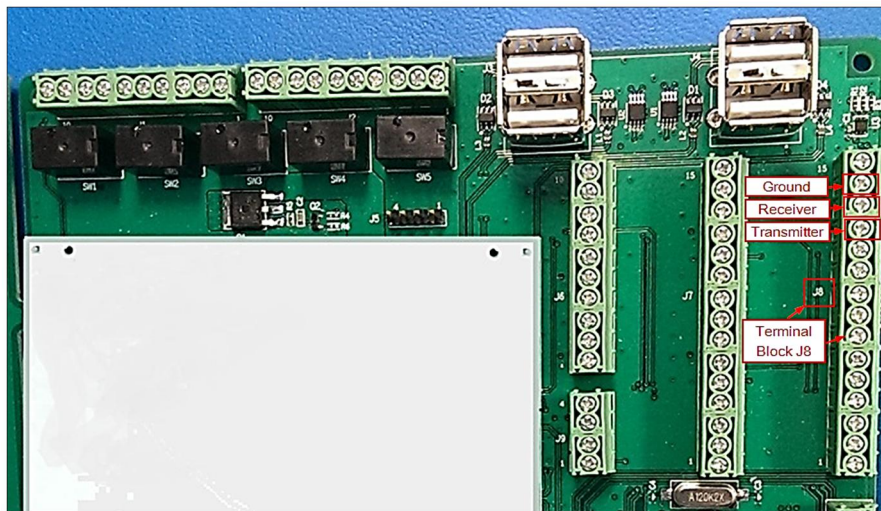

Figure 6 - iRMS terminal Block J8



4. On the WOFS Receiver, attach the Receiver wire to the Smart Interface Terminal Block to the location labeled RX (see previous Figure 5).
5. Attach the other end of the Receiver wire to the iRMS Terminal Block J8, at screw #13 (see previous Figure 6).
6. On the WOFS Receiver, attach the Transmitter wire to the Smart Interface Terminal Block to the location labeled TX (see previous Figure 5).
7. Attach the other end of the Receiver wire to the iRMS Terminal Block J8, at screw #12 (see Figure previous 6).

## 5 Connecting the Receiver to an Alarm Panel or Other External Device

The Receiver can also be integrated with an alarm panel or another external device. The Receiver terminal block has relay terminals for two different devices (device A, and device B), as shown in Figure 8.



**Figure 7 - Receiver's main terminal block, wire access point, zip tie for wires**

The PC board labels mean the following:

- COM is the common terminal.
- NC is the normally closed relay contact (for instances when the relay is not energized).
- NO is the normally open relay contact.

### To connect external devices to the Receiver:

1. Connect the relay terminal wires inside the WOFS Receiver to the alarm panel (or other device), following the manufacturer's directions, using NEC guidelines.

- Use the terminal jacks that are either Normally Open (N/O) or Normally Closed (N/C), depending on the configuration of the alarm panel (see section 7 of this manual for more information on the N/O or N/C requirements).
2. Route the wires from the Receiver terminal block through the hole next to the SMA antenna connector (see previous Figure 8).
    8. Use the zip tie to secure the wires in order to reduce the strain on the terminal block wires (see previous Figure 8).
    9. Reassemble the WOFS Receiver case, and then reattach the Phillips-head screws.
    10. Turn on the +12VDC supply to the Receiver.

## 6 Receiver Antenna

The Receiver has a female SMA connector at the top of the case to connect the 2.4 GHz antenna, which communicates with the Transmitters. Attach the Receiver Antenna to the Receiver by placing the antenna carefully on the SMA connector (see previous Figure 8), lining up the center pin, and turn the antenna clockwise until the antenna is securely attached to the Receiver.

*NOTE: The iRMS unit has an antenna external to the iRMS case and can receive transmissions for the Receiver, or from the Transmitters, using its own iRMS antenna.*



## 7 Determining if a Device Requires a Normally Open, or Normally Closed State

Before connecting the Receiver to an alarm panel or other external device, the user must determine if the alarm system panel (or other device) requires a Normally Open (N/O) or Normally Closed (N/C) state.

*Note: For the rest of this section, it will be assumed that the device being connected is an alarm panel, but the theory and steps are the same for a different external device.*

The external device, such as an alarm panel, when used to connect to the WOFS will dictate either the use of Normally Closed or Normally Open TID configuration. In some cases, this may be configurable in the alarm panel.

- In the N/C case, a high voltage at the alarm panel indicates an alarm (one or more of the TIDs has opened) or the wiring has been cut. A low voltage at the alarm panel indicates the wiring has been shorted.
  - Conversely, in the N/O case, a high voltage indicates a wiring fault (wire has been cut) and a low voltage indicates an alarm or wire short.
1. In configuring the connection between the WOFS Receivers, and an alarm panel or iRMS, end-of-line (EOL) resistors are used at the termination of protected loops or “zones” to allow for differentiation between an active alarm and secure states, in addition to wiring faults or wire tampering.
  2. As shown in the Figures 9-11, an EOL resistor is used in series with a resistor internal to the alarm panel to create a voltage divider. Intermediary voltage values indicate a secure (non-alarming state), high or low voltages indicate an alarm or fault – the actual alarm or fault state being dictated by whether the Normally Closed (N/C) or Normally Open (N/O) configuration of the Tamper Indicating Device (TID) is used. The value of the selected EOL resistor is dependent upon the alarm panel’s specifications.

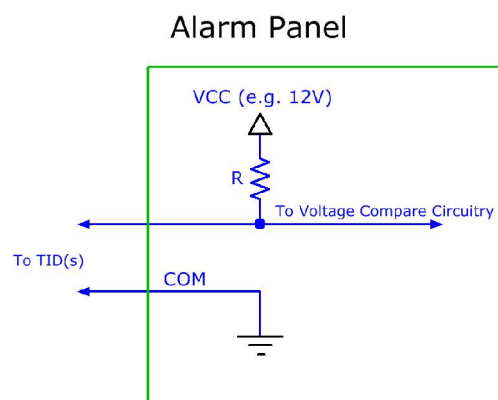
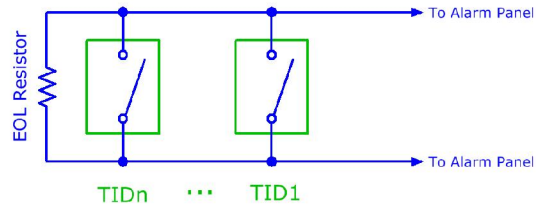

Figure 8 - Alarm Panel

Normally Open (NO)



**Figure 9 - Normally Open configuration**

Normally Closed (NC)

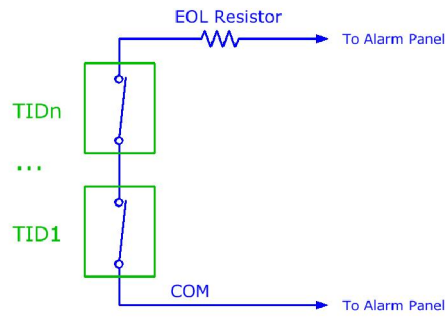

**Figure 10 - Normally Closed configuration**

## 8 Installation of the WOFS Transmitter Hardware

Installation of the WOFS Transmitter Hardware requires three steps:

- Installation of the batteries
- Mounting the Transmitter to a secured surface
- Setting up the Fiber Optic Loop

The WOFS Transmitter is powered by 2 AA-sized batteries. The battery power level is monitored by the WOFS Receiver.

The Transmitter uses a fiber optic cable to wrap around (or through) the object to be sealed. The Transmitter is designed to be attached to a flat or cylindrical (minimum 12 inch radius) secured surface, adjacent to the protected object. In this manner, if an attempt is made to remove the entire protective enclosure (containing the radioactive material or protected equipment), the Transmitter will also have to be removed from where it is mounted, and this will send an alarm to the Receiver.

### Tools and Parts Required for Installing the WOFS

- Phillips screwdriver
- Fiber optic cable: 1mm diameter, with a 2.2mm diameter polyethylene (PE) jacket (e.g. Industrial Fiber Optics SH4001 Eska series p/n 810004 or equivalent)
  - Cable length must be sufficient to secure the protected device, AND allow enough cable to attach the Transmitter to a nearby, secured surface. Additionally, the length must include enough cable to allow the cable to be inserted into the cable terminals at the top of the Transmitter (see Figure 12). The user will provide the fiber optic cable.
- Adhesive mounting tape (included with Transmitter)

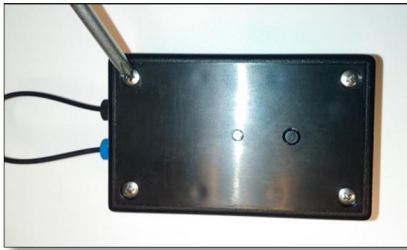

Figure 11 - Transmitter with fiber optic loop (back side)

## 9 Installing or Changing Transmitter Batteries

Before mounting the Transmitter to a wall or secured surface, install 2 AA-sized alkaline batteries using the steps below:

1. Remove the 4 recessed, Phillips-head screws and open the Transmitter case to access the battery compartment (see Figure 13).
  - Remove the old batteries, if applicable.
2. Insert 2 AA-sized alkaline batteries matching the polarity pictured in the battery holder (see Figure 14).
3. Reassemble the case and reattach the Phillips-head screws.



**Figure 12 - Removing the four screws to open the case**

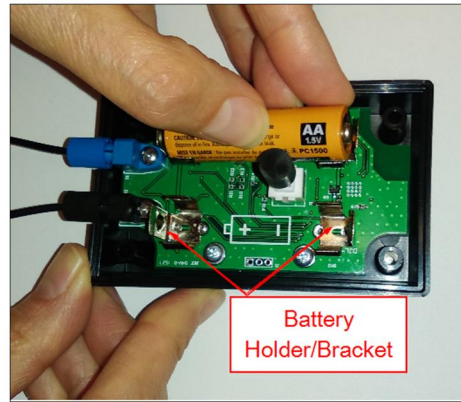

**Figure 13 - Inserting or removing batteries: Push the battery into the battery bracket**

*NOTE: The Transmitter is equipped with a Tamper Identification Device (TID) which will send an alarm when the Transmitter box is opened or removed from the secured surface (see Figure 15). If the user is changing batteries, the user should notify the Monitor Station(s) that changing batteries will trigger an alarm.*



**Figure 14 - Transmitter's Tamper Identification Device (TID)**

## 10 Mounting Transmitter on Wall or Secured Surface

Before the WOFS unit is mounted to a secured surface, the user should have determined how the fiber optic loop is going to be secured around the device to be monitored.

- Ensure that the fiber loop surrounding the protected asset can be securely wrapped around the section necessary to protect, and still reach the WOFS fiber optical cable terminals.
- The Transmitter must be mounted so that the fiber connections to the seal are inserted and oriented to minimize the strain on the fiber connections.
- The Transmitter contains an RF radio and should not be separated from the Receiver by metal walls or more than 30 ft. Walls or large machinery between the Transmitter and Receiver will reduce the communication range between the two devices.

It is recommended to use the included mounting tape, which includes a hole for the TID to protrude. If using mounting tape included with the WOFS unit, do the following:

1. Locate the back of the WOFS unit. The back of the unit box has four holes for the recessed hex nuts, and a Tamper Identification Device (TID) button (See Figure 16). The back can be differentiated from the front of the Transmitter box, which has Phillips-head screws, and an LED light (see Figure 17).

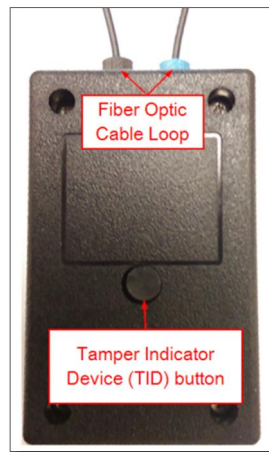

Figure 15 - Back of Transmitter with TID button



Figure 16 - Front with Status button & Status Led

2. Peel the paper off one side of the mounting tape.
3. Press the mounting strip onto the back of the Transmitter, making sure to line up the TID hole on the WOFS unit with the hole in the mounting tape (see Figure 18).
4. Peel the paper from the second side of the mounting tape.
5. Press the WOFS unit onto the pre-determined, secured surface.



Figure 17 - Mounting tape applied to the back of WOFS unit

## 11 Setting up the Fiber Loop

The WOFS Transmitter is designed to work with polyethylene-jacketed, 1mm diameter, fiber optic cable with a 2.2mm diameter jacket, such as Industrial Fiber Optics SH4001 Eska series (part number 810004 or the equivalent).

The Transmitter has been designed for fiber optic connectors that do not require fiber polishing. However, if many splices are incorporated in a long fiber loop, polishing will improve optical transmission and reliability. Polishing may be accomplished using an Industrial Fiber Optics Polishing Puck (part number 41 0156) along with Polishing Slurry (part number IF 370060).

1. Determine the length of fiber optic loop needed to secure the selected device, **AND** allow enough cable to attach the Transmitter to a secured surface. Additionally, provide enough cable to allow the cable to be inserted into the cable terminals at the top of the Transmitter.
2. Cut the cable using a fiber optic cutter such as the Omron E39-F4 cutter (see Figure 19). Use Industrial Fiber Optics IF-C-S4 or equivalent splice connectors to splice cable together, if needed.



Figure 18 - Fiber optic cutter  
(Omron E39-F4)



2. Insert one end of the fiber optic cable into the Transmitter screw terminal until fully seated (see Figure 20).
3. Turn the screw terminal clockwise to secure the cable (see Figure 21). Secure the protected object (i.e. radioactive material container) with the optic fiber cable, and then secure other end of the fiber optic loop into the other screw terminal. Either end of the fiber optic loop can be installed in either screw terminal.

After both ends of the fiber optic loop are connected to the Transmitter, press the Status button on the Transmitter.

*NOTE: If the Transmitter has been paired with a Receiver, and the fiber optic cable is inserted, the LED light on the Transmitter will turn green for a few seconds. If the Transmitter status light is red, review the installation process, and make the adjustments needed to correctly install the fiber optic cable.*

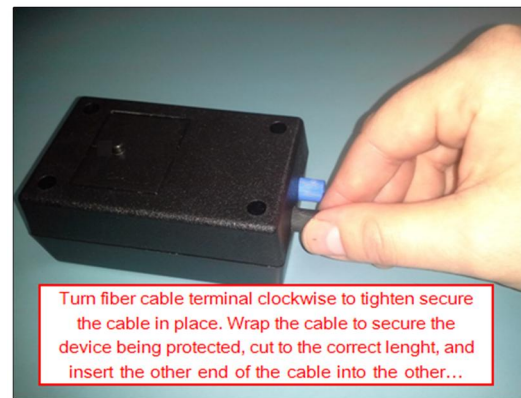
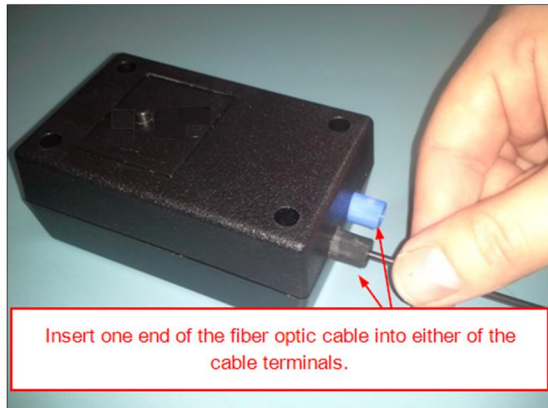

**Figure 19 - Screwing terminal clockwise to secure cable**      **Figure 20 - Inserting fiber optic cable into terminal**

## 12 Pairing a WOFS Transmitter to a WOFS Receiver

A Transmitter needs to be paired to a Receiver only once, at the time of installation. The pair will remain paired thereafter, even after power loss, or during battery replacement. One Receiver can be paired with (and can monitor) up to 8 Transmitters.

To pair a Transmitter and Receiver:

1. On the Receiver, press and hold the pairing button for 3 seconds. The status LED will start flashing blue indicating “discovery” mode.
2. On the unpaired Transmitter (be sure the batteries have been installed), press and hold the Status button for 3 seconds.
  - On a previously-paired Transmitter, press and hold the Status button on the Transmitter for more than 20 seconds, until the status LED rapidly flashes blue, then continue with step two above.
3. Upon successful pairing, the Transmitter’s status LED and the corresponding Status LED on the Receiver (number 1, or 2, 3, ... through 8) will turn green or red (which indicates successful pairing and current Transmitter status).
  - Repeat this process to pair the next Transmitter.
  - When pairing of the Transmitters is complete, press and hold the Receiver’s Pair button for 3 seconds to take the Receiver out of “discovery” mode.
    - **Caution: If the Transmitter is blinking slowly (1 flash every 2 seconds), the Transmitter is trying to pair with a different Receiver. The Transmitter must first be unpaired with its previous Receiver. Follow the process for unpairing the Transmitter from the first Receiver (see Section 13), and try pairing again with the second Receiver.**
4. It is possible to pair several Transmitters to the Receiver in a more streamline method. Follow the steps below:
  - Hold the Receiver’s Pair button down for at least 3 seconds to enter “discovery” mode.
  - Press and hold the Status button on the Transmitter that will be known as Transmitter #1. Wait at least 5 seconds for the corresponding status LED to change color.
  - Press and hold the Status button on the Transmitter that will be known as Transmitter #2. Wait at least 5 seconds for the corresponding status LED to change color.
  - Press and hold the Status button on the Transmitter that will be known as Transmitter #3. Wait at least 5 seconds for the corresponding status LED to change color.
  - Continue this process until all of the Transmitters are successfully paired. Then, Press the Receiver’s Pair button for 3 seconds. This will turn off the Receiver’s “discovery” mode.
  - Each paired Transmitter should now have a lit LED on the Receiver, associated with its Transmitter pair. To check that each have been properly assigned, open and close the fiber optic loop, and see if the Receiver shows a changing green-to-red-to-green LED next to the correct number for that transmitter. This will also validate that the fiber optic loop has been installed correctly.

## 13 Unpairing a WOFS Transmitter to a WOFS Receiver

On occasion, the need may arise to unpair a transmitter from its paired receiver. This can be necessitated when any of the following happens:

- A Transmitter may need to be moved to a different location, and paired with a different Receiver.
- A transmitter may not be functioning correctly, and the user may choose to replace one Transmitter with another.
- A Receiver may not be functioning properly, and it will be replaced.

There are several ways to unpair a Transmitter from a Receiver: 1) Use the Receiver to unpair only one Transmitter, 2) Use the Receiver to unpair all of the Receivers, 3) Use the Transmitter to unpair from the Receiver. The following instructions explain how to complete each of these unpairing functions.

### 1. To unpair **ONE** Transmitter from a Receiver:

- Hold the Receiver's Unpair button for 15 seconds.
- Press the Pair button. At this point, the 1st Transmitter's Status LED will turn solid blue.
- Release the Unpair button.
- Press the Pair button multiple times. This will cause the next Transmitter Status light to turn solid blue. Continue pressing the Pair button until the desired Transmitter LED turns solid blue.
- Press the Receiver's Unpair button again for 5 seconds, and the solid blue light will go out, and the Transmitter is successfully unpaired.

### 2. To unpair **ALL** Transmitters from a Receiver:

- Hold the Receiver's Unpair button for at least 30 seconds.
- After 30 seconds, the Status LED on the Receiver will flash blue, and then change to green, and will stay green. All of the other lights on the Receiver will be unlit, because the Transmitters are no longer paired to the Receiver.

### 3. To unpair one Transmitter from a Receiver:

- Hold down the Transmitter button for more than 20 seconds.
- The Status LED on the Transmitter will flash blue rapidly and then will not be lit.
- The Transmitter is unpaired from its current Receiver. This can be verified because Receiver's Pair Status LED for that particular location will turn red, because it is looking for a Transmitter.

*Caution: Unpairing by using the Transmitter to initiate the process will cause an alarm, because the Receiver believes the Transmitter has disabled or disturbed.*

## 14 Receiver Status Lights

The Receiver's Status light is on at all times (after correct installation). Any Receiver that has been paired with a Transmitter will also have its Transmitter Status lights constantly showing for each paired set.

The Status of a Transmitter paired to the first location on the Receiver is indicated by the LED labeled 1, the Transmitter paired to the second location is shown by the LED labeled 2, and so on. LED lights for unused pairs will remain off (see Figure 22).

Receiver Status Light (See Figure 22):

- A green light shows the Receiver is functioning correctly.
- A red light shows a Transmitter is sending an alarm.
- A yellow light shows that a Transmitter is sending an alert, such as a low battery.
- A flashing blue light indicates the Receiver is in "discoverable mode" (activated by pressing the Pairing button).

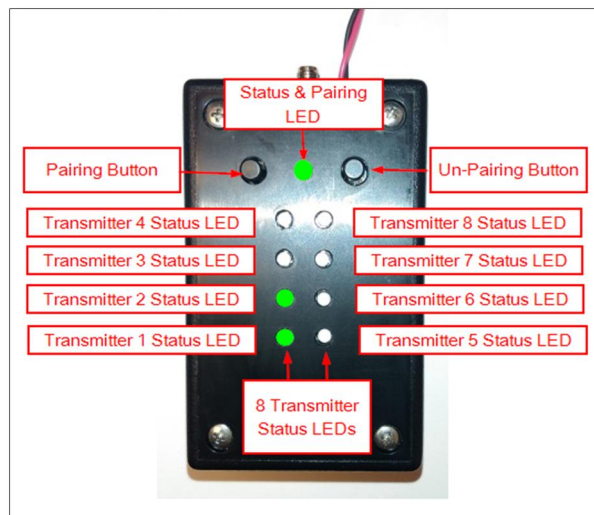

**Figure 21 - Receiver pair status LEDs and buttons**

## 15 Transmitter Status Lights and Checking Transmitter Status

The Transmitter is designed with a Status Button and an LED light to indicate the Transmitter's status (see Figure 23). If the Transmitter has been paired with Receiver (and is within range) the Status button on the Transmitter can be pressed at any time to check the Transmitter's status, lighting up the LED.

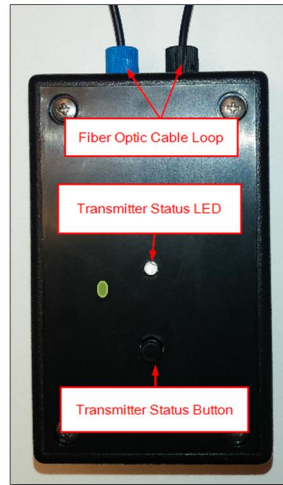

Figure 22 - Transmitter Status button and Status LED

Transmitter Status Lights (see Figure 24):

- A green light indicates the Transmitter is functioning correctly, and the optic cable is intact.
- A red light indicates the Transmitter is sending an alarm (the fiber loop has been compromised or the tamper indication button has been activated).
- A yellow light indicates the Transmitter is sending a low battery alert.
- A flashing blue light indicates the Transmitter is searching for a receiver to complete pairing. There are two different LED states of flashing blue.
  - A fast flash (4 flashes per second) shows that the Transmitter is in “open” pairing mode and can pair to any discoverable Receiver.
  - If the LED is blinking slowly (1 flash every two seconds), the Transmitter will only pair with the Receiver with which it has previously been paired.



Figure 23 - Transmitter Status Lights – in Discovery mode

---

## 16 Regulatory Compliance

### FCC Declaration of Conformance

This device complies with part 15 of the FCC rules. Operation is subject to the following two conditions: (1) This device may not cause harmful interference, and (2) this device must accept any interference received, including interference that may cause undesired operation. Any changes or modifications not expressly approved by manufacturer could void the user's authority to operate the equipment.

IMPORTANT! Any changes or modifications not expressly approved by the party responsible for compliance could void the user's authority to operate this equipment.

### FCC Class B Information

NOTE: This equipment has been tested and found to comply with the limits for a Class B digital device, pursuant to part 15 of the FCC Rules. These limits are designed to provide reasonable protection against harmful interference in a residential installation. This equipment generates, uses and can radiate radio frequency energy and, if not installed and used in accordance with the instructions, may cause harmful interference to radio communications. However, there is no guarantee that interference will not occur in a particular installation. If this equipment does cause harmful interference to radio or television reception, which can be determined by turning the equipment off and on, the user is encouraged to try to correct the interference by one or more of the following measures:

- Reorient or relocate the receiving antenna.
- Increase the separation between the equipment and receiver.
- Connect the equipment into an outlet on a circuit different from that to which the receiver is connected.
- Consult the dealer or an experienced radio/TV technician for help.

### FCC Radiation Exposure Statement

This equipment complies with FCC radiation exposure limits set forth for an uncontrolled environment. This equipment should be installed and operated with minimum distance 20cm between the radiator and your body.

### CE Conformity

This equipment complies with the essential requirements and other relevant provisions of Directive 2006/95/EC.