

DISCOVERY QUAD MCW

Wireless PowerCode Quad PIR Detector



Installation Instructions

1. FEATURES

- Employs a real quad element low-noise pyroelectric sensor
- Includes a fully supervised PowerCode transmitter
- Patented sophisticated motion analysis algorithm - True Motion Recognition (TMR™)
- Two-position vertical adjustment for coverage pattern
- Integral swivel bracket for wall or ceiling installation
- Programmable motion event counter - ON or OFF (default)
- Front and back tamper switches for improved tamper protection
- Full stabilization achieved 30 seconds after power up
- After detection, the detector disables itself to save battery power. It reverts to the ready state if there is no subsequent detection throughout the following 2-minute period

- Automatic termination of walk-test after 15 minutes
- Low current consumption
- Microprocessor-controlled temperature compensation
- Sealed chamber protects the optical system
- White light protection
- Elegantly styled, sturdy case
- Keyhole-shaped slot for easy removal of PCB



Figure 1. External View

2. SPECIFICATIONS

OPTICAL

Detector Type: Quad element low-noise pyroelectric sensor.

Detection Pattern: 90° wide angle lens with 19 quad zones in 3 detection layers. Max. coverage is 15 x 15 m (50 x 50 ft).

Adjustment: 2-position vertical adjustment scale: FAR and NEAR.

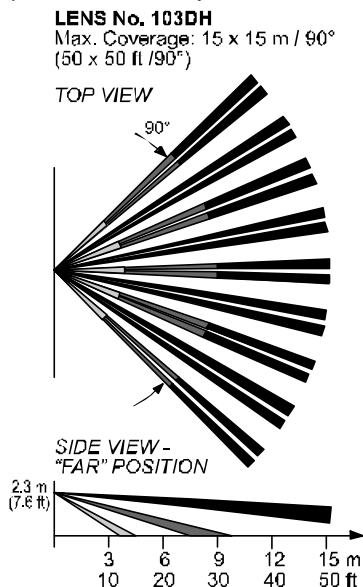

Figure 2. Coverage Pattern

ELECTRICAL

Internal Battery: 3 V Lithium battery, Panasonic CR-2 or equivalent

Nominal Battery Capacity: 750 mAh

Standby Current Drain: 0.015 mA

Transmit Current Drain: 20 mA (including LED)

Battery Life Expectancy: 3 years (for typical use)

Battery Supervision: Automatic reporting of battery status with each alarm and with periodic supervision message.

FUNCTIONAL

True Motion Event Verification: 2 position selector - 1 (OFF) or 2 (ON) motion events.

Alarm Period: 3 seconds.

Visual Indications:

LED lights for about 3 seconds upon transmission of alarm & tamper messages and upon each motion detection in the walk test mode.

LED flashes during the power-up stabilization period, or after restoring (pressing) the tamper switch.

LED does not light upon transmission of supervision messages.

Rearm Timer: Rearms the detector 2 minutes after the last alarm. Timer disabled in the walk test mode.

WIRELESS

Frequency (MHz): 315, 433.92, 868.95, 869.2625 or other frequencies according to local requirements.

Transmission Sequence: 3 data bursts at variable intervals within 3 seconds.

Encoding: 24-bit ID, over 16 million possible combinations.

Total Message Length: 36 bits.

Tamper Alert: Reported when a tamper event occurs and in any subsequent message, until the tamper switch is restored.

Supervision Message: Once per 15 minutes, 60 minutes or according to local standards.

MOUNTING

Height:

With bracket : Up to 3.6 m (12 ft)

Without bracket: 2 - 2.6 m (6.5 - 8.5 ft)

Installation Options:

With bracket: Surface or ceiling

Without bracket: Surface or corner

Bracket Adjustment: 20° downward, 20° left and right.

ENVIRONMENTAL

RFI Protection: >30 V/m up to 1000 MHz.

Operating Temperatures: -10°C to 50°C (14°F to 122°F).

Storage Temperatures: -20°C to 60°C (-4°F to 140°F).

Compliance with Standards: Designed to meet FCC Part 15 and Directive 1999/5/EC of the European Parliament.

PHYSICAL

Dimensions (H x W x D): 117 x 65 x 47 mm.

(4-5/8 x 2-9/16 x 1-7/8 in.).

Weight: 92 g (3.25 oz) without bracket, 107 g (3.75 oz) with bracket.

Color: White

PATENTS: U.S. Patent No. 5,693,943

3. INSTALLATION

3.1 Installation Hints

To minimize false alarms:

| | |
|---|--|
| <p>Do not aim at heat sources</p> | <p>Mount on solid, stable surfaces</p> |
| <p>Do not expose to air draughts</p> | <p>Do not install outdoors</p> |
| <p>Prevent direct sunlight from reaching the detector</p> | <p>Keep wiring away from electrical power cables</p> |
| <p>Do not install behind partitions</p> | <p>2.0 to 2.6 meters (6.5 to 8.5 ft)</p> |

3.2 Battery Insertion

It is recommended to power up the detector and let the target receiver "learn" the transmitter's ID before actual installation. This can be done only after battery installation.

1st. Remove the front cover as shown in Figure 3.

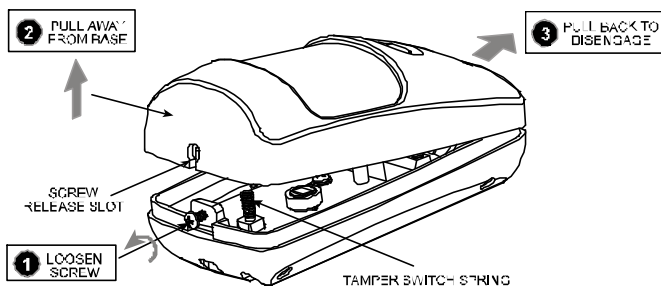

Figure 3. Cover Removal

2. Insert the battery into the battery clip - observe polarity (see Figure 4).

3rd. Press the tamper switch once and release it. This will perform the reset necessary for smooth power up.

4th. Put the cover on and observe the LED. It will flash until the detector stabilizes (within about 30 seconds).

3.3 Enrolling the Transmitter ID

Refer to the target receiver's installation instructions and follow the procedure given there for "teaching" the transmitter's ID. It is much easier to carry out this operation in close proximity to the receiver.

3.4 Mounting without Swivel Bracket

1st. Remove the front cover as shown in Figure 3.

2nd. Loosen the vertical adjustment screw, slide the PCB down and remove it via the "keyhole" (see Figure 4).

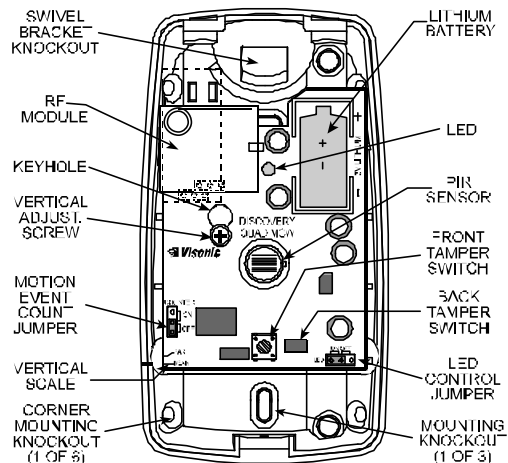

Figure 4. Inside View

3rd. Punch out the mounting knockouts at the base (for surface mounting) or mounting knockouts at the angled sides of the base (for corner mounting).

Attention! The unit has a special tamper switch under the PCB. As long as the PCB is seated firmly within the base, the switch lever will be pressed against a special break-away base segment that is loosely connected to the base (Figure 5). Be sure to fasten the break-away segment to the wall. If the detector unit is forcibly removed from the wall, this segment will break away from the base, causing the tamper switch to open. It is advisable to pierce the anti-tamper knockouts from within the base outward, while pressing the rear surface of the break-away segment against a piece of wood.

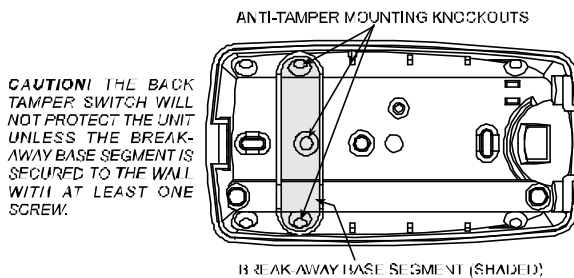

Figure 5. Anti-Tamper Break-Away Base Segment

4th. Hold the base against the wall at the selected location, mark the drilling points, drill the holes and attach the base to the wall.

5th. Return the PCB to its place: align the "keyhole" with the head of the vertical adjustment screw, press the PCB against the base, slide the PCB up and temporarily tighten the screw.

3.5 Mounting with Swivel Bracket

1st. Remove the front cover as shown in Figure 3.

2nd. Loosen the vertical adjustment screw, slide the PCB down and remove it via the "keyhole" (see Figure 4).

3rd. Punch out the large knockout in the round bulge at the top part of the base (see Figure 6).

4th. Assemble the bracket as shown in Figure 6.

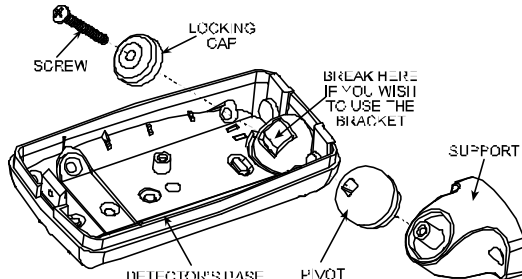

Figure 6. Attaching the Bracket

5th. Rotate the bracket to the desired position (see Figure 7) but do not yet tighten the screw fully.

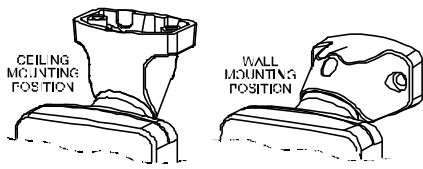

Figure 7. Wall and Ceiling Positions of Bracket

6th. Mark the points for drilling through the two mounting holes of the bracket. Attach the bracket to the mounting surface.

G. Tilt down or swivel the detector to face the desired direction. Figure 8 shows the tilt/swivel possibilities.

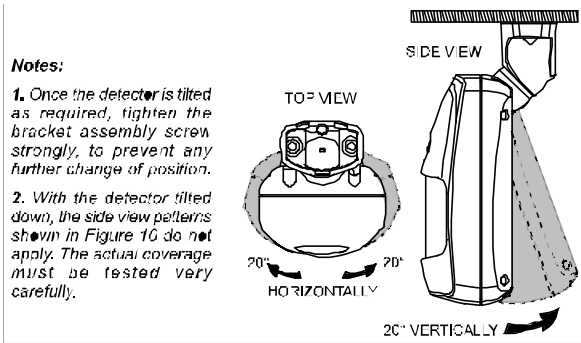

Figure 8. Tilt/Swivel Limits

3.6 Setting the Motion Event Counter

The location of the motion event jumper is shown in Figure 4. Refer to Figure 9 below and mount the jumper as desired.

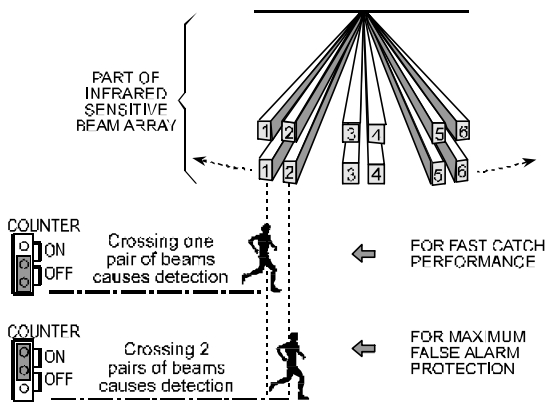
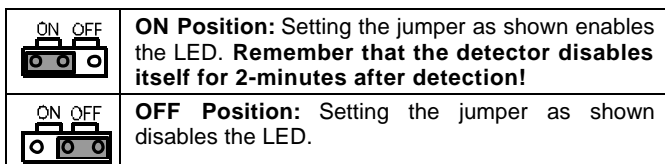

Figure 9. Motion Event Counter Setting Options

3.7 Setting the LED Control Jumper



Note: At power up or reset, the LED flashes for 30 seconds

regardless of the jumper position and then enters walk-test mode. After 15 minutes the detector enters normal mode in which the LED functions according to the LED control jumper position.

3.8 Vertical Adjustment

Refer to Figure 10. Loosen the vertical adjustment screw and slide the printed circuit board up or down to obtain the desired coverage. When done, tighten the screw well.

| SCALE POSITION | RESULTANT PATTERN | |
|-----------------|--|---------------------------------------|
| FAR | Mounting height: 2.0 - 2.6 m (6.5 - 8.5 ft) | Room length: 8 - 15 m (24 - 50 ft) |
| | | |
| NEAR | Mounting height: 2.0 - 2.6 m (6.5 - 8.5 ft) | Room length: 3 - 8 m (10 - 24 ft) |
| | | |

Figure 10. Vertical Adjustment

3.9 Walk Testing

Upon battery insertion or closing of the cover (which results in closing of the tamper switch) the detector goes into walk-test mode and automatically exits the mode after 15 minutes.

- Set the motion event counter as required (see Paragraph 3.6).
- Adjust the vertical angle as desired (see Paragraph 3.8).
- Remount the cover and fasten the case closure screw. This results in the resetting of the detector and the start of walk-test mode.
- Wait until the LED stops flashing (about 30 seconds).
- Walk-test the entire protected area by walking slowly across the detector's field of view, observing the LED. Pause for 5 seconds after each detection to allow the detector to complete its 3-transmission sequence (see Appendix A); the LED will light for about 3 seconds.
- When the walk-test is completed (after 15 minutes), the detector's setting automatically changes according to the LED control jumper setting.

Notes:

- The OFF setting is recommended to prevent unauthorized people from tracing the detector's coverage pattern.
- If the LED is disabled, you may use the control panel's visual and audible indicators to verify proper function of the detector.

Attention! To assure proper function of the detector, the range and coverage area should be checked at least twice a year. Furthermore, the user should be instructed to perform a walk test at the far end of the coverage pattern to assure an alarm signal prior to each time the alarm system is armed.

4. MISCELLANEOUS COMMENTS

4.1 Product Limitations

Visonic Ltd. wireless systems are very reliable and are tested to high standards. However, due to their low transmitting power and limited range (required by FCC and other regulatory authorities), there are some limitations to be considered:

- Receivers may be blocked by radio signals on or near their operating frequencies, regardless of the code selected.
- A receiver can only respond to one transmitted signal at a time.

- Wireless equipment should be tested regularly to determine whether there are sources of interference and to protect against faults.

4.2 Frequency Allocations for Wireless Devices in European (EU) Countries

- 433.92 MHz has no restriction in any EU member state.
- 315 MHz is not allowed in any EU member state.

- **868.95 MHz** (wide band) is allowed in all EU member states.
- **869.2625 MHz** (narrow band) is not restricted in any EU member state.

4.3 Compliance with Standards

This device complies with the essential requirements and provisions of Directive 1999/5/EC of the European Parliament and of the Council of 9 March 1999 on radio and telecommunications terminal equipment.

The 315 MHz model of this device complies with Part 15 of the FCC Rules. Operation is subject to the following two conditions: (1) This device may not cause harmful interference, and (2) this device must accept any interference that may be received, including interference that may cause undesired operation.

The user is cautioned that changes or modifications to the unit, not expressly approved by the party responsible, could void the user's FCC authority to operate the equipment.

APPENDIX A. THE VISONIC LTD. POWERCODE SYSTEM

A-1. The PowerCode Message Format

The PowerCode message transmitted by the DISCOVERY QUAD MCW includes the 24-bit ID and a status report (see Fig. A1).

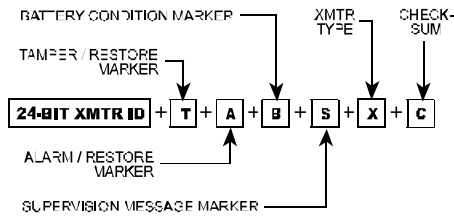

Figure A1. Transmitted Data

A message includes the following data:

- **Detector's ID:** Any message transmitted starts with the 24-bit ID assigned to the particular detector unit.
- **Tamper / Restore:** Upon removal of the unit's front cover, a message will be transmitted with a "tamper marker" ON. If the unit's cover is put back, a message will be transmitted with the tamper marker OFF ("Tamper Restore").
- **Alarm:** Once the detector is in alarm, a message will be transmitted with an "alarm marker" ON.
- **Low Battery:** A special battery condition marker is used to report the battery status in any message. The battery is tested once an hour and if found low, the "low battery marker" is set to ON in all following messages.
- **Supervision Message:** A special "supervision message marker", when set to ON, identifies the periodic supervision

messages transmitted automatically at 1 hour or 15 minute intervals. This marker will be OFF in all other messages.

- **Transmitter Type:** A special marker indicates the type of the transmitter:
 - Supervised or non-supervised
 - Reports or does not report restorals after alarm

The DISCOVERY QUAD MCW does not report restorals after alarms.

- **Checksum:** Checksum bits at the end of the message allow the receiver to determine whether an incoming message is valid (error-free). This feature considerably enhances the reliability of the wireless communication link.

A-2. Anti-Collision

To overcome message collisions at the receiving end, PowerCode transmitters transmit 3 data bursts at random intervals, with 6 repetitions of the same message in each burst (Fig. A2). This redundancy improves the probability of reception.

Note: Periodic supervision messages are an exception to this rule - they consist of a single 6-message burst.

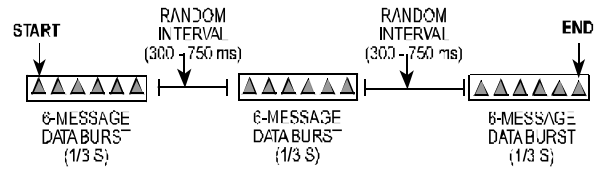

Figure A2. Anti-Collision Transmission Sequence

WARRANTY

Visonic Ltd. and/or its subsidiaries and its affiliates ("the Manufacturer") warrants its products hereinafter referred to as "the Product" or "Products" to be in conformance with its own plans and specifications and to be free of defects in materials and workmanship under normal use and service for a period of twelve months from the date of shipment by the Manufacturer. The Manufacturer's obligations shall be limited within the warranty period, at its option, to repair or replace the product or any part thereof. The Manufacturer shall not be responsible for dismantling and/or reinstallation charges. To exercise the warranty the product must be returned to the Manufacturer freight prepaid and insured.

This warranty does not apply in the following cases: improper installation, misuse, failure to follow installation and operating instructions, alteration, abuse, accident or tampering, and repair by anyone other than the Manufacturer.

This warranty is exclusive and expressly in lieu of all other warranties, obligations or liabilities, whether written, oral, express or implied, including any warranty of merchantability or fitness for a particular purpose, or otherwise. In no case shall the Manufacturer be liable to anyone for any consequential or incidental damages for breach of this warranty or any other warranties whatsoever, as aforesaid.

This warranty shall not be modified, varied or extended, and the Manufacturer does not authorize any person to act on its behalf in the modification, variation or extension of this warranty. This warranty shall apply to the Product only. All products, accessories or attachments of others used in conjunction with the Product, including batteries, shall be covered solely by their own warranty, if any. The Manufacturer shall not be liable for any damage or loss whatsoever, whether directly, indirectly, incidentally, consequentially or otherwise, caused by the malfunction of the Product due to products, accessories, or attachments of others, including batteries, used in conjunction with the Products.

The Manufacturer does not represent that its Product may not be compromised and/or circumvented, or that the Product will prevent any death, personal and/or bodily injury and/or damage to property resulting from burglary, robbery, fire or otherwise, or that the Product will in all cases provide adequate warning or protection. User understands that a properly installed and maintained alarm may only reduce the risk of events such as burglary, robbery, and fire without warning, but it is not insurance or a guarantee that such will not occur or that there will be no death, personal damage and/or damage to property as a result.

The Manufacturer shall have no liability for any death, personal and/or bodily injury and/or damage to property or other loss whether direct, indirect, incidental, consequential or otherwise, based on a claim that the Product failed to function. However, if the Manufacturer is held liable, whether directly or indirectly, for any loss or damage arising under this limited warranty or otherwise, regardless of cause or origin, the Manufacturer's maximum liability shall not in any case exceed the purchase price of the Product, which shall be fixed as liquidated damages and not as a penalty, and shall be the complete and exclusive remedy against the Manufacturer.

Warning: The user should follow the installation and operation instructions and among other things test the Product and the whole system at least once a week. For various reasons, including, but not limited to, changes in environmental conditions, electric or electronic disruptions and tampering, the Product may not perform as expected. The user is advised to take all necessary precautions for his/her safety and the protection of his/her property.



VISONIC LTD. (ISRAEL): P.O.B 22020 TEL-AVIV 61220 ISRAEL. PHONE: (972-3) 645-6789, FAX: (972-3) 645-6788
 VISONIC INC. (U.S.A.): 10 NORTHWOOD DRIVE, BLOOMFIELD CT. 06002-1911. PHONE: (860) 243-0833, (800) 223-0020 FAX: (860) 242-8094
 VISONIC LTD. (UK): FRASER ROAD, PRIORY BUSINESS PARK, BEDFORD MK44 3WH. PHONE: (0870) 730-0800 FAX: (0870) 730-0801
 INTERNET: www.visonic.com

