

KP-140 PG2/KP-141 PG2

Portable Remote Wireless 2-Way Keypad



Visonic®

User's Guide

1. INTRODUCTION

KP-140 PG2 and KP-141 PG2 are 2-way PowerG wireless keypads for the PowerMaster family control panels. The KP-141 PG2 is the same as the KP-140 PG2 but also includes a built-in proximity RFID tag reader. Both keypads enable most common everyday user functions:

- Arm and Disarm the alarm system.
- Initiate Emergency, Fire and Panic alarms.
- Control X-10 devices and PGM output.
- Perform one of the AUX (auxiliary) predefined functions.
- Review system Status.

When authorization is required, for example, to arm or disarm the system, the user can enter his PIN Code via the built-in numerical keypad or alternatively present a valid proximity tag to the built-in tag reader (only with KP-141PG2) located at "N" in Figure 1.

In addition, the KP-140 PG2/KP-141 PG2 keypad supports panels featuring Partitions. Partitioning allows you to have up to three controllable areas; each partition can be armed and disarmed independently regardless of the status of the other two partitions by the same or different users (see buttons marked "E" in Figure 1).

The keypads can be wall mounted using the supplied bracket or be used as portable units. For compliance with various international standards, the keypads are equipped with two tamper switches that can be configured to detect when the cover of the battery compartment is removed or when the unit is removed from its mounting bracket.

Other features of the KP-140 PG2/KP-141 PG2 keypad include:

- Status, alarm memory, trouble and Ready / Not-Ready indications.
- Automatic reporting of low battery voltage.
- Keypad back lighting.
- Exit/entry beeps
- Tag reader can also be used to enroll proximity tags into the panel.
- Long-life 4-5 years battery life expectancy (for typical use), 3 VDC lithium battery.

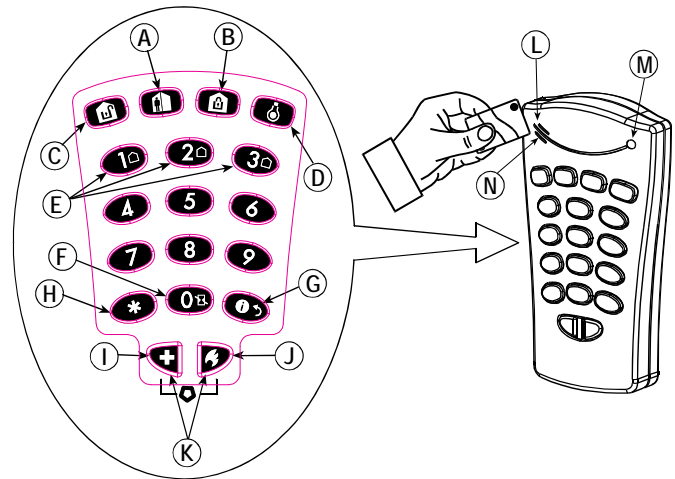

- A. ARM HOME
- B. ARM AWAY
- C. DISARM
- D. X-10 / PGM
- E. PARTITION SELECTION
- F. ARM INSTANT
- G. STATUS / ESCAPE
- H. AUX / ENROLLMENT
- I. EMERGENCY ALARM
- J. FIRE ALARM
- K. PANIC ALARM
- L. BUZZER INDICATOR
- M. LED INDICATOR
- N. TAG READER

Figure 1 - External View

2. INSTALLATION

2.1 Mounting and Battery Replacement

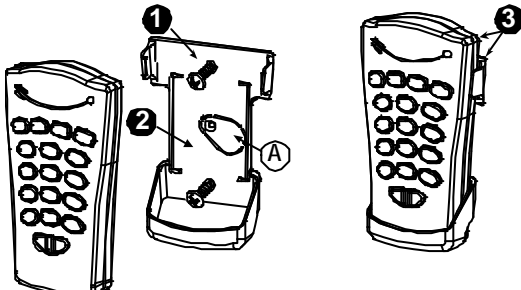

1. Drill 2 holes in mounting surface, insert wall anchors and fasten the bracket with 2 screws.
 2. Place the "Visual Indications" sticker within the frame.
 3. Slide the keypad into the bracket.
- A. Magnet (activates back tamper when bracket is removed from the wall).

Figure 2 - Mounting

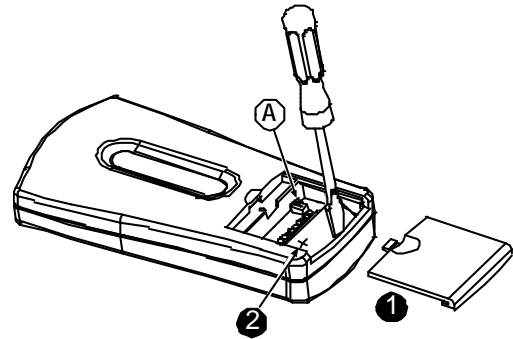

1. Slide out the cover.
 2. Replace the battery (verify proper polarity) and close the cover.
- A. Battery compartment tamper switch

Figure 3 - Battery Replacement

2.2. ENROLLMENT

Refer to the PowerMaster panel's Installer Guide and follow the procedure under the "02:ZONES/DEVICES" option of the Installer Menu a general description of which is provided in the following flow chart.

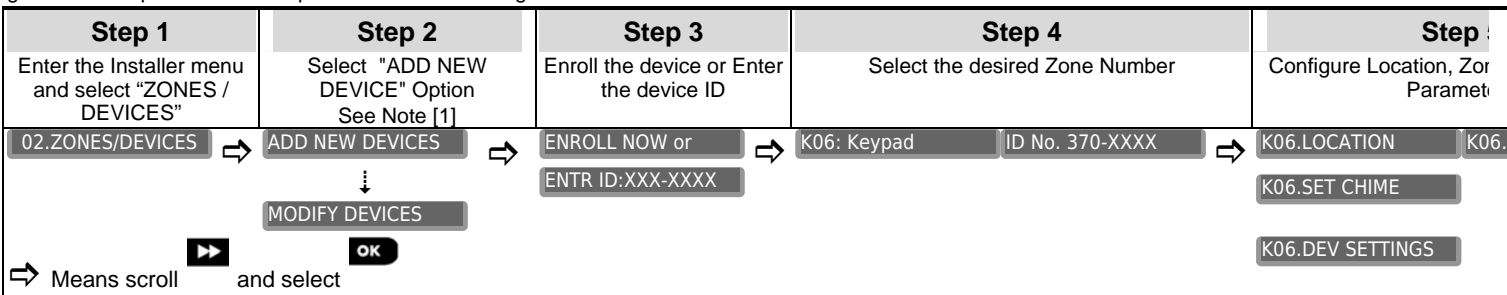

Notes:

[1] If the keypad is already enrolled you can configure the keypad parameters via the "Modify Devices" option – see Step 2.

[2] Select the "Device Settings" option and refer to section 2.3 to configure the keypad parameters.





2.3. Configuring the Keypad Parameters

Enter the **DEVICE SETTINGS** menu and follow the configuration instructions for the KP-140 PG2/KP-141 PG2 keypad as described in the following table.

Option	Configuration Instructions
TAMPERS	Here you determine which of the two tampers (i.e. battery compartment cover and wall tamper) will be active. Optional settings: Disabled (default); Wall only ; Battery only .
SUPERVISION	Here you determine whether or not the control panel will monitor supervision messages sent by the keypad or not (see Note). Optional settings: ON (default) or OFF . Note: Every 5 minutes the keypad performs a communication test session with the control panel (i.e. "Supervision signal") to check the integrity and quality of the Radio link. If the keypad does not report a supervision signal at least once within a predefined time window, a "MISSING" trouble alert is initiated. Therefore, if you intend to take the keypad out of the protected premises you must switch the Supervision OFF to avoid the trouble alert.
EXIT-ENTRY Beeps	Here you determine whether the keypad will sound the exit and entry beeps, or not, or whether the keypad will sound the beeps only when the system is armed AWAY and not when it is armed HOME. Optional settings: ON ; OFF (default) and OFF @ Home .
BUTTON (*)	Here you select the function of the (AUX) button  . Four options are offered: Not used: No function assigned to AUX button. Stop Beeps: Pressing the AUX button will cause the control panel and other devices in the system (such as keypads, sirens etc.) to stop beeping (for example during exit or entry delays). Skip exit delay: Pressing the AUX button will immediately stop the exit delay. PGM: Pressing the AUX button will activate the PGM output. The functions of the PGM output is configured at the corresponding sections of the control panel's Installer Guide (see "OUTPUTS" menu) and User Guide (see "SCHEDULER" menu). Optional settings: Not Used (default); Stop Beeps ; Skip exit delay ; and PGM .





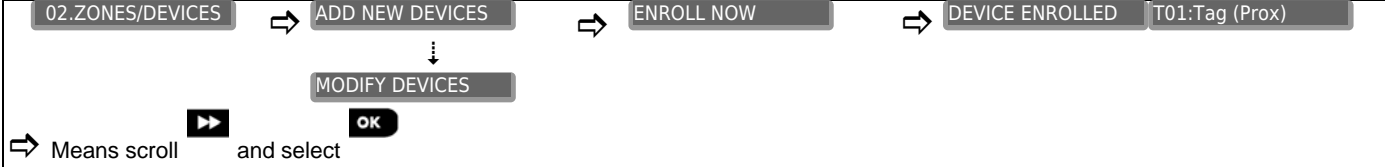



2.4 Enrollment of Proximity Tags

The built-in proximity tag reader of the KP-141PG2 can be also used to enroll proximity tags into the PowerMaster panel via the keypad as described in the corresponding section of the control panel's User or Installer Guide, or as explained in the general description provided below.

Step 1	Step 2	Step 3	Step 4
Enter the Installer menu of the control panel and select the "02:ZONES/DEVICES"	Select the "ADD NEW DEVICES" option	When "ENROLL NOW" is displayed, press the AWAY button () on the KP-141 PG2 keypad - the AWAY button begins to blink	Present the proximity tag to the KP-141 PG2 keypad within the timeout period. If the enrollment is successful the display reads "DEVICE ENROLLED" and then shows the device details
			
			

3. USING THE KEYPAD

3.1 Arming and Disarming the System

Step	Basic Arming	User Actions	Keypad & Panel Response
1	Select a PARTITION ⁽¹⁾ (when Partition is enabled)	 or  or 	The selected button lights.
2	Arm AWAY		The selected button starts blinking and prompts you to enter your "User Code" or present your Tag. See step 3.
	Arm HOME		
	Disarm (OFF)		
	Quick arm AWAY ⁽²⁾	 (~ 2 sec.)	The keypad's LED blinks red once to indicate transmission of the arming command to the control panel. The control panel's response is then indicated on the keypad via the LED and
	Quick arm HOME ⁽²⁾	 (~ 2 sec.)	

Step	Basic Arming	User Actions	Keypad & Panel Response
3	Enter USER CODE or present Proximity TAG. ⁽³⁾ ⁽⁴⁾	[USER CODE] or [present TAG] [DURESS CODE] (2580 by default) ⁽⁵⁾	the buzzer – see “Panel Response to Keypad Commands” section 3.5 below.
4	INSTANT	(After arming HOME/ AWAY) ⁽⁶⁾ ⁽⁸⁾	The keypad's LED blinks red once to indicate transmission of the command to the control panel. The control panel's response is then indicated on the keypad via the LED and the buzzer – see “Panel Response to Keypad Commands” in section 3.5 below.
	LATCHKEY	(After arming AWAY) ⁽⁷⁾ ⁽⁸⁾	

Notes:

1. If Partition is disabled at the control panel, skip Step 1.
2. The Quick arm functions only if enabled at the control panel.
3. If Quick arm is selected in Step 2, skip Step 3.
4. (a) Pressing a non-valid code causes the control panel to reject the transmission.
(b) If the action is not completed while the selected arming button is blinking, the desired function will not be executed.
5. To use the Duress Code refer to the respective section in the control panel's User Guide.
6. Press the INSTANT button within maximum 8 seconds timeout period after completing the previous step. This will delete the entry delay for the current arming session.
7. Press the AWAY button TWICE within maximum 8 seconds timeout period after completing the previous step. To use the LATCHKEY arming refer to the respective section in the control panel's User Guide.
8. You can perform the LATCHKEY and INSTANT functions, one after the other. The order is not important.

3.2 Automation

The functions of the PGM and X-10 outputs is configured at the corresponding sections of the control panel's Installer Guide (see “OUTPUTS” menu) and User Guide (see “SCHEDULER ” menu).

Output Function	Actions	Response
X-10 or PGM device ON	[PGM → 00] or [X-10→ 01 to 15]	The keypad's LED blinks red once to indicate transmission of the command to the control panel. The control panel's response is indicated on the keypad via the LED and the buzzer – see “Panel Response to Keypad Commands” in section 3.5 below.
X-10 or PGM device OFF	[PGM → 00] or [X-10→ 01 to 15]	
X-10 or PGM device TOGGLE	[PGM → 00] or [X-10→ 01 to 15]	

Note: Long press (more than 2 sec.) of the button initiates the X-10 function. Short press of the button initiates the PGM function.

3.3 Initiating Alarms

Alarm	Actions	Response
Emergency alarm	(≈ 2 sec.)	See section 3.5.
Fire alarm	(≈ 2 sec.)	See section 3.5.
Panic alarm	(≈ 2 sec.)	See section 3.5.

3.4 Other Functions

Function	User Actions	Response
AUX Function ⁽¹⁾		See section 3.5.
STATUS indication		See section 3.6

Note: The function of the AUX button is configured in section 2.3 above

3.5 Panel Response to Keypad Commands

When executing a command, the keypad's LED ("M" in Figure 1) blinks red once to indicate transmission of the command to the control panel. If the operation is **successfully completed**, the green LED lights momentarily and a "happy tune" is heard. If the operation **fails or cannot be completed**, for example, when the system is "not ready", the red LED lights steadily and a "sad tune" is heard. If a trouble or alarm memory condition exists in the system, or when the system is not-ready to arm, the Status button (G in Figure 1) flashes for several seconds prompting you to press it to retrieve the status information from the control panel.

Panel Response	Buzzer Indication	LED Indication	Problem Indication
Success: Operation is successfully completed	Happy (success) beep	Momentary GREEN	If the panel is Not-Ready or if a Trouble or Alarm Memory conditions exit, the Status button (G in Fig.1) flashes for few seconds. To identify the reason, press the button to retrieve the Status indication - refer to section 3.6 for further information.
Fail: Operation failed	Sad (failure) beep	Momentary RED	
No communication: Control panel does not respond.	None	None	

3.6 Retrieving and Displaying System Status

Step	Status Request	User Actions	Keypad & Panel Response
1	Request Status		The keypad's LED blinks red once to indicate transmission of the status request to the control panel.
2	Look at status		The panel's status is indicated on the keypad via the LED and the Arming Keys and Partition Keys – see below

Arming Status

The system Arming Status is indicated via the respective arming/disarming buttons' LED that light for several seconds. For example, if the system is armed AWAY, the button will light and if the system is disarmed, the button will also light.

If Partition is enabled, the arming Status of the first partition is displayed concurrently with the corresponding first partition button LED , then the second partition Status is displayed concurrently with the second partition button LED and then the third partition Status is similarly displayed.

Indication of Ready/Not Ready & Trouble Status

The Ready/Not Ready, Alarm Memory and Trouble indications are provided via the keypad LED (see "M" in Figure 1) as follows:

LED Indication [1]	System Status [2]	What it Means
Green	System READY	You can arm the system
Red	System NOT- READY	One of the zones is not secured. You can not arm the system before the zone is secured or bypassed. [3]
Yellow	Trouble or Alarm Memory	There was an alarm or there is trouble situation that need to be reviewed and cleared. [3]
Yellow blinking	Keypad Low-Battery	The battery of the keypad must be replaced as shown in section 2.1.

[1] The LED indication is displayed after the first red blink indicating the status request.

[2] If there is more than one status indication, the LED will display them consecutively.

[3] See respective sections in the control panel's User and Installer's Guides.

APPENDIX: SPECIFICATIONS

Frequency Band (MHz) Europe and rest of world: 433-434, 868-869

USA: 912-919

PowerG

Communication Protocol

Battery type

3V, CR123A type.

Caution!

Risk of explosion if battery is replaced by an incorrect type. Dispose of used battery according to manufacturer's instructions.

Battery Life Expectancy

4-5 years (for typical use).

Operating Temperature

0°C to 49°C (32°F to 120°F)

Dimensions (LxWxD)

127x70x24mm (5 x 2-3/4 x 31/32 in)

Weight (including battery)

107g (3.4 oz)

Color

White

Compliance with Standards

Europe: EN 300220-1, EN 50130-4, EN 50131-1 Grade 2 Class II, EN 50131-3, EN 301489.

USA: This device complies with FCC Rules Part 15 and with Industry Canada licence-exempt RSS standard(s).

Operation is subject to two conditions: (1) This device may not cause harmful interference, and (2) this device must accept any interference that may be received or that may cause undesired operation.

This equipment complies with FCC and IC RF radiation exposure limits set forth for an uncontrolled environment.

The digital circuit of this device has been tested and found to comply with the limits for a Class B digital device, pursuant to Part 15 of the FCC Rules. These limits are designed to provide reasonable protection against harmful interference in residential installations. This equipment generates, uses and can radiate radio frequency energy and, if not installed and used in accordance with the instructions, may cause harmful interference to radio and television reception. However, there is no guarantee that interference will not occur in a particular installation. If this device does cause such interference, which can be verified by turning the device off and on, the user is encouraged to eliminate the interference by one or more of the following measures:

- Re-orient or re-locate the receiving antenna.
- Increase the distance between the device and the receiver.
- Connect the device to an outlet on a circuit different from the one which supplies power to the receiver.
- Consult the dealer or an experienced radio/TV technician.

Changes or modifications not expressly approved by Visonic Ltd. could void the user's authority to operate the equipment.



W.E.E.E. Product Recycling Declaration

For information regarding the recycling of this product you must contact the company from which you originally purchased it. If you are discarding this product and not returning it for repair then you must ensure that it is returned as identified by your supplier. **This product is not to be thrown away with everyday waste.** Directive 2002/96/EC Waste Electrical and Electronic Equipment.

The technical documentation as required by the European Conformity Assessment procedure is kept at:
UNIT 6 MADINGLEY COURT CHIPPENHAM DRIVE KINGSTON MILTON KEYNES MK10 0BZ. Telephone number: 0870 7300800, Fax number: 0870 7300801



VISIONIC LTD. (ISRAEL): P.O.B 22020 TEL-AVIV 61220 ISRAEL. PHONE: (972-3) 645-6789, FAX: (972-3) 645-6788

VISIONIC INC. (U.S.A.): 65 WEST DUDLEY TOWN ROAD, BLOOMFIELD CT. 06002-1376. PHONE: (860) 243-0833, (800) 223-0020.

FAX: (860) 242-8094

VISIONIC LTD. (UK): UNIT 6 MADINGLEY COURT CHIPPENHAM DRIVE KINGSTON MILTON KEYNES MK10 0BZ. TEL: (0870) 7300800

FAX: (0870) 7300801. TEL: (0870) 7300800 FAX: (0870) 7300801 **PRODUCT SUPPORT: (0870) 7300830**

VISIONIC GmbH (D-A-CH): KIRCHFELDSTR. 118, D-40215 DÜSSELDORF, TEL.: +49 (0)211 600696-0, FAX: +49 (0)211 600696-19

VISIONIC IBERICA: ISLA DE PALMA, 32 NAVE 7, POLÍGONO INDUSTRIAL NORTE, 28700 SAN SEBASTIÁN DE LOS REYES, (MADRID), ESPAÑA.

TEL (34) 91659-3120, FAX (34) 91663-8468. www.visonic-iberica.es

INTERNET: www.visonic.com

©VISIONIC LTD. 2011 KP-140 PG2/KP-141 PG2 D 303015 (Rev 3, 4/11) Refer to separate Warranty statement

