

Table of Contents

1. INTRODUCTION.....	2
2. INSTALLATION.....	3
2.1 Inserting Battery.....	3
2.2 Closing Battery Compartment Cover.....	3
2.3 Wall Mounting Options.....	4
2.4 Enrolling the KP-160 PG2.....	6
2.5 Configuring the KP-160 PG2 Parameters.....	6
2.6 Enrolling Proximity Tags.....	8
3. USING THE TOUCH SCREEN KEYPROX.....	9
3.1 Arming and Disarming the System.....	9
3.2 Initiating Alarms.....	10
3.3 System Status and Indications.....	10
3.4 Bypassing Zones.....	14
3.5 Controlling Home Automation Devices.....	14
3.6 Other Functions.....	15
APPENDIX A: SPECIFICATIONS.....	15
APPENDIX B: COMPLIANCE WITH STANDARDS.....	16

1. INTRODUCTION

KP-160 PG2 is a 2-way wireless PowerG touch screen keyprox for the PowerMaster family control panels. The KP-160 PG2 enables most common everyday user functions:

- Arm and Disarm the alarm system.
- Initiate Emergency, Fire and Panic alarms.
- Control home automation devices.
- Review system status.
- Perform programmable predefined functions.

KP-160 PG2 is operated by proximity tags. When authorization is required the user presents a valid proximity tag to the built-in tag reader

In addition, the KP-160 PG2 supports panels featuring Partitions. Partitioning allows you to select up to three controllable areas; each partition can be armed and disarmed independently regardless of the status of the other two partitions by the same or different users (see keys marked "7" in the "Icon and Key Indications" Figure).

The KP-160 PG2 can be wall-mounted using the supplied bracket or be used as a portable unit. For compliance with various international standards, the KP-160 PG2 is equipped with two tamper switches that can be defined to detect when the cover of the battery compartment is removed or when the unit is removed from its mounting bracket.

Other features of the KP-160 PG2 include:

- Easy-to-use intuitive graphical touch user interface
- Proximity-tag operated, no need for user to remember codes
- Allows all users' every day actions
- Panel can be installed in hidden location
- 8 or 32 per system (depending on the control panel), suitable for any installation
- Status, Alarm, Memory, Trouble and Ready indications.
- Automatic reporting of low battery.
- Back lighting.
- Exit/entry beeps
- Enrollment of proximity tags directly into control panel or via tag reader.
- Long battery life expectancy (for typical use).

2. INSTALLATION

2.1 Inserting Battery

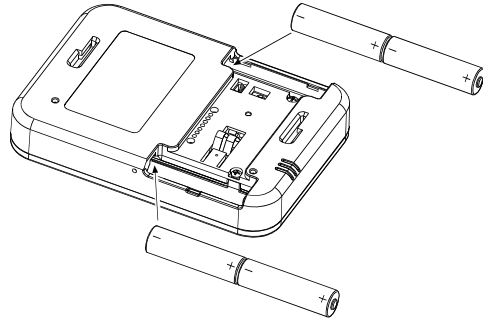

CAUTION!

Risk of explosion if battery is replaced by an incorrect type. Dispose of used battery according to manufacturer's instructions.

Figure 1 – Battery Insertion

Insert two 1.5V batteries in each slot while ensuring battery polarity.

2.2 Closing Battery Compartment Cover

Portable Installation (Using Battery Cover without Tamper Hole)

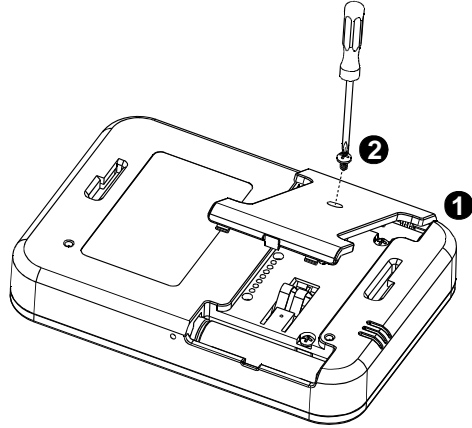

Figure 2 - Battery Cover Mounting (part a)
Wall-mounted Installation (Using Battery Cover without Tamper Hole - see "A")

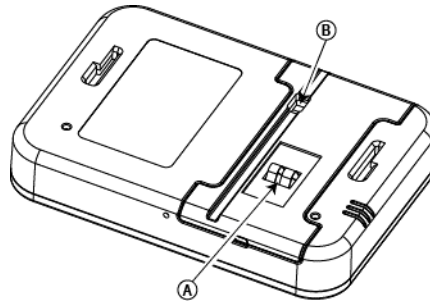

Figure 3 - Battery Cover Mounting (part b)

A. Tamper B. DC Power Connection

2.3 Wall Mounting Options

The KP-160 PG2 unit mounting options are illustrated in the following drawings.

Wall Mounting

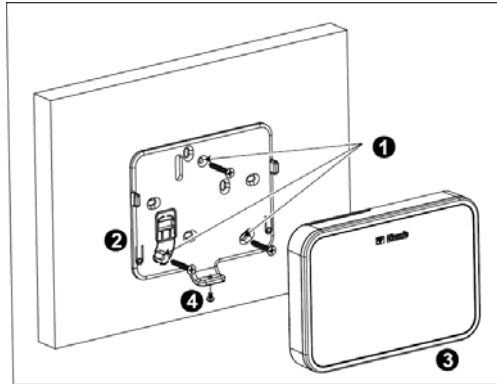

Figure 4a - Wall Mounting

1. Drill 3 mounting holes
 2. Position the bracket and secure with 3 screws
 3. Attach the unit to the bracket
 4. Secure the unit with the screw
- 4

Wall Mounting with External Electrical Connector

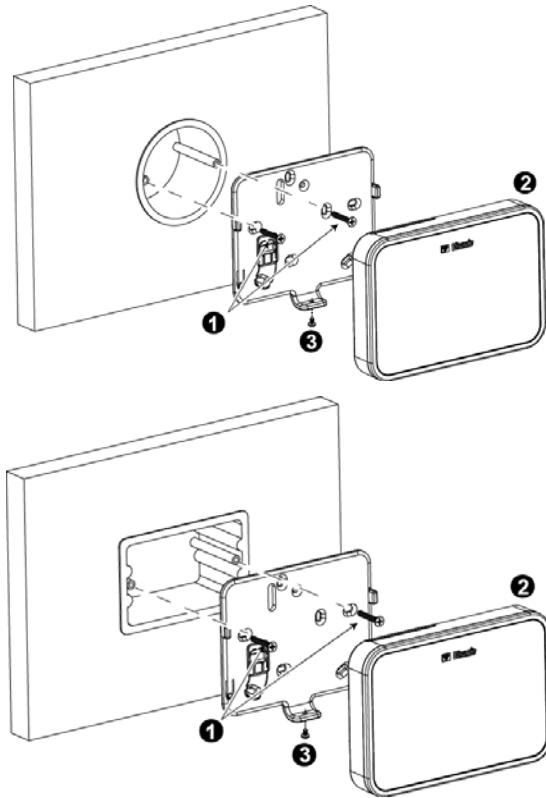

Figure 4b – Wall Mounting with External Electrical Connector

1. Secure bracket with 2 screws as shown in the two drawings above.
2. Attach the unit to the bracket.
3. Secure the unit with the screw

2.4 Enrolling the KP-160 PG2

Refer to the PowerMaster panel's Installer Guide and follow the procedure under the "02:ZONES/DEVICES" option of the Installer Menu. A flowchart of the procedure is provided below.

Step	Action	LCD Display
1	Enter the Installer menu and select "02:ZONES/DEVICES"	02.ZONES/DEVICES →
2	Select "ADD NEW DEVICE" Option See Note	ADD NEW DEVICES → ↓ MODIFY DEVICES
3	Enroll the device or enter the 7-digit code that appears on the device's sticker.	ENROLL NOW or → ENTR ID:XXX-XXXX
4	Select the desired keyprox Number	K07: LCD Keypad → ID No. 374-XXXX
5	Configure the settings of the device	K07.DEV SETTINGS
6	Configure the Keyprox	See section 2.5

⇒ means scroll  and select 

Note: If the KP-160 PG2 is already enrolled, you can configure the KP-160 PG2 parameters via the "Modify Devices" option – see Step 2.

2.5 Configuring the KP-160 PG2 Parameters

Enter the **K07.DEV SETTINGS** main menu in the PowerMaster control panel, choose the number of the touch screen keyprox device to configure and follow the configuration instructions for the KP-160 PG2 touch screen keyprox.

Option	Configuration Instructions
TAMPERS	Define the active tamper. Optic settings: Disabled (default); All Tamper and Battery Cover
SUPERVISION	Define whether or not the control panel will monitor supervision messages sent by the keyprox (see Note). Optic settings: ON (default) or OFF .

Note Every 5 minutes the keyprox performs a communication test session with the control panel (i.e. "Supervision signal") to check the integrity and quality of the Radio link. If the keyprox does not receive a supervision signal at least once within a predefined time, a "M. SING" trouble alert is initiated. Therefore, if you take the keyprox out of the protected premises, switch the Supervision OFF to avoid the trouble alert.

EXIT-ENTRY Beeps

Define whether or not the keyprox will sound the exit and entry beeps or whether the keyprox will sound the beeps only when the system is armed AWAY and not when it is armed HOME.

Optic settings: **ON**; **OFF** (default) and **OFF @ Home**.

Trouble Beeps

Under trouble conditions, the panel sounder emits a series of 3 short reminder beeps once per minute. Here you determine whether to enable or disable this reminder beeping or just disable it at night. The "night" hours are defined in the factory but are usually from 8 PM (20:00) until 7:00 AM.

Optic settings: **ON**; **OFF** (default) and **OFF @ night**.

Sounder Volume

Define the volume level of the sounder.

Optic settings: **Medium** (default); **Maximum** and **Minimum**

Screen Saver

Enabling the function will turn off the display if no key is pressed for more than several seconds.

Optic settings: **Disabled** (default) and **Enabled**.

Note

1) When the "SCREEN SAVER" menu on the PowerMaster control panel is configured as "refresh by key", touching the right side of the screen on the KP-160 PG2 device will return the device to normal display (refer to the PowerMaster Installer Guide, section 3.5.6).

2) When the "SCREEN SAVER" menu on the PowerMaster control panel is configured as "refresh by code", touching the right side of the screen on the KP-160 PG2 device and then presenting the proximity tag to the tag reader will return the device to normal display (refer to the PowerMaster Installer Guide, section 3.5.6).

BUTTON (*)

Select the function of the (AUX) key  when pressed:

Not used: No function assigned to AUX key.

Status: Control panel displays and announces* the system status.

Stop Beeps: Control panel and other devices in the system (such as keyproxs, sirens etc.) will stop beeping during the exit delay.

Skip exit delay: Stop the exit delay immediately.

X-10 (PGM): Activate the appliance controlled by the chosen X-10

unit(s) or the device wired to the PGM output. For more details on configuring the X-10/PGM output functions, see the corresponding sections of the control panel's Installer Guide ("OUTPUTS" menu) and User Guide ("SCHEDULER" menu).

Optic settings: **Not Used, Status** (default); **Stop Beeps, Skip exit delay**; and **X-10 (PGM)**.

* Applicable only to control panels that support the voice option.

AC POWER Connect

Define whether or not to report power failure.

Optic settings: **NOT Connected** (default) and **Connected to AC**.

2.6 Enrolling Proximity Tags







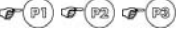

You can enroll proximity tags in the PowerMaster panel either via the KP-160 PG2 touch screen keyprox, as described below, or through the PowerMaster control panel, as described in the corresponding section of the control panel's User or Installer Guide.

Each proximity tag corresponds to its User Code. Therefore, be sure that a corresponding User Code is programmed for each enrolled proximity tag (code "0000" is not allowed). For example, "T02:Tag <Prox>" must be assigned to User Code 2 and "T14:Tag <Prox>" must be assigned to User Code 14. Partition authorization of each proximity tag is identical to that of the corresponding User Code. For example, if User Code 3 is set to Partitions 1 and 3, "T03:Tag <Prox>" will also be set to Partitions 1 and 3.

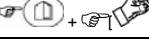
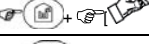
Step	Action	LCD Display
1	Enter the Installer menu of the control panel and go to " 02:ZONES/DEVICES "	02.ZONES/DEVICES →
2	Select "ADD NEW DEVICE" Option	ADD NEW DEVICES → ↓ MODIFY DEVICES
3	When " ENROLL NOW " is displayed, press the AWAY key (⏏) on the KP-160 PG2. The AWAY key and the Present Prox Tag key (🏠) begin to blink	ENROLL NOW or →
4	Present the proximity tag to the KP-160 PG2 within the timeout period. If the enrollment is successful the display reads " DEVICE ENROLLED " and then shows the device details	DEVICE ENROLLED T01:Tag (Prox)

3. USING THE TOUCH SCREEN KEYPROX

3.1 Arming and Disarming the System



Step	Operation	User Actions	Keyboard & Panel Response
Optional	1 Select a PARTITION ⁽¹⁾ (if Partition is enabled)	Any combination of 	The selected key blinks.
	2 Arm AWAY Arm HOME Disarm (OFF)	 (4)  (4)  (4)	The selected key and the "Present Prox Tag" icon  begin to blink and prompt you to present your Tag.
Optional	3 Quick arm AWAY ⁽³⁾ (If Quick Arm is enabled) Quick arm HOME ⁽³⁾ (If Quick Arm is enabled)	 (≈ 2 sec.)  (≈ 2 sec.)	The keyprox's LED blinks red once to indicate transmission of the arming command to the control panel.
Optional	4 INSTANT LATCHKEY	(After arming HOME/ AWAY)  (5) (7) (After arming AWAY)  (6) (7)	The LED and the buzzer then indicate the control panel's response – see "System Status and Indications" section 3.3.

Notes:

1. If Partition is disabled at the control panel, skip Step 1.
2. If Partition is enabled at the control panel and a partition was not selected in Step 1, Step 2 will activate all of the partitions assigned to the user.
3. The Quick arm functions only if enabled at the control panel.
4. If the action is not completed while the selected arming key is blinking, the desired function will not be executed.
5. Press the INSTANT key within maximum 8 seconds timeout period after completing the previous step. This will delete the entry delay for the current arming session.
 - INSTANT is available only if supported in the PowerMaster control panel (refer to the PowerMaster Installer Guide).

6. For LATCHKEY activation, press the LATCHKEY key within maximum 8 seconds timeout period after completing the previous step.
7. LATCHKEY is available only if the LATCHKEY feature is enabled in the PowerMaster control panel (see PowerMaster Installer Guide). You can perform the LATCHKEY and INSTANT functions, one after the other. The order is not important.
 - LATCHKEY and INSTANT functions can be operated only during exit delay.
 - While in INSTANT / LATCHKEY, the small circle icon on the upper right side of the INSTANT / LATCHKEY icon lights.

3.2 Initiating Alarms

Alarms	Actions	Response	Notes
Emergency alarm	 (≈ 2 sec.)	See section 3.3.	When pressing the Fire or Emergency icons, the KP-160 PG2 starts beeping. After pressing the button for approx. 2 seconds, the KP-160 PG2 sends the command.
Fire alarm	 (≈ 2 sec.)	See section 3.3.	
Panic alarm	 (≈ 2 sec.)	See section 3.3.	When pressing the Fire and Emergency icons together, the KP-160 PG2 starts beeping. After pressing the button for approx. 2 seconds, the KP-160 PG2 sends the Panic command.

3.3 System Status and Indications

When executing a command, the keyprox's LED ("30" in the "Icon and Key Indications" Figure) blinks red once to indicate transmission of the command to the control panel. If the operation is **successfully completed**, the green LED lights momentarily and a "happy tune" sounds. If the operation **fails or cannot be completed**, for example, when the system is "Not Ready", the red LED lights steadily and a "sad tune" sounds.

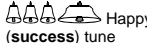
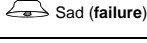

Buzzer Indication	LED Indication	Panel Response
 Happy (success) tune	Momentary GREEN	Success: Operation is successfully completed
 Sad (failure) tune	Momentary RED	Fail: Operation failed or invalid key press
None	None	No communication: Control panel does not respond.

Arming Indications

The table below lists the Arming indication keys and their definition.



Icon/Key Indications	Arming Indication
	ARM AWAY











Icon/Key Indications	Arming Indication
	ARM HOME
	DISARM
Each icon appears one after the other	EXIT DELAY
+ The "Present Prox Tag" icon and DISARM key blink simultaneously	ENTRY DELAY

If Partition is enabled, the arming indication of the first partition is displayed concurrently with the corresponding first partition key LED , then the second partition indication is displayed concurrently with the second partition key LED  and then the third partition indication is similarly displayed.

General Indications

The Ready/Not Ready, Alarm Memory, Trouble and Low Battery indications are provided via the indications in the following table:

Number	Indication ⁽¹⁾	What it Means
1		Instructs the user to display the RFID proximity tag in order to initiate a command.
2		Volume control mode.
3		System is NOT READY; one of the zones is not secured. You cannot arm the system before the zone is secured or bypassed.
		System is READY but one or more zones are bypassed.
	No indication	System is READY and all zones are secured.
4		Bypassed () or Open () Zone number
		Selected PGM or X-10 unit number.
		Volume level

Number	Indication ^[1]	What it Means
5		PGM/X-10 control mode.
11		System is armed in LATCHKEY mode.
12		Exit beeps are shut off. This mode disables when the exit delay is over. ^[2]
16		System is armed in the INSTANT mode.
22		A message is waiting in the system.
23		The control panel is presently in "INSTALLER MODE" or "USER SETTINGS".
24		Memory / Alarm in partition or system.
25		The partition / system has an active trouble status that needs to be reviewed and cleared. ^[3]
26		AC failure.
27		Communication failure: KP-160 PG2 is out of range of the control panel or did not get an acknowledge signal of a command from the control panel.
28		Indicates that the KP-160 PG2 device's battery is low and must be replaced (see section 2.1).

[1] The key indication is displayed after the first red LED blinks indicating the status request.

[2] Operates only during Exit Delay.

[3] See respective sections in the control panel's User and Installer's Guides.

[4] If there is more than one status indication at a single time, the keys are displayed simultaneously.

Zone Status Indications

To view the zone numbers of enrolled detectors that are in NOT READY () or

BYPASSED state () , repeatedly press the  key. Upon each press of the  key, the next zone number appears on the Zone # display (marked "4" in the "Icon and Key Indications" Figure).

To view the zone numbers that are assigned to a Partition, press the desired Partition

number (P1) (P2) (P3) followed by the key. Upon each press of the key, the next zone number assigned to the pressed Partition number appears on the Zone # display.



Notes:

A zone which is **BYPASSED** and **NOT READY** is shown as **BYPASSED** ().

When "00" appears on the Zone # display, this indicates a **NOT READY** state in the alarm system that is not related to any detector, for example, "tamper open" in a keypad or control panel.

If all zones are **READY** and "not bypassed", the  button is disabled.











3.4 Bypassing Zones



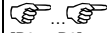
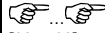
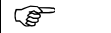

A zone can be bypassed by pressing the  key until the zone number is shown on the zone # display (marked "4" in the "Icon and Key Indications" Figure) followed by the  key.

Note: Zone bypassing on the KP-160 PG2 unit can be operated only if Bypass was enabled via the control panel (see PowerMaster Installer Guide, section 3.5.2 "Configuring Arming/Disarming and Exit/Entry Procedures").



3.5 Controlling Home Automation Devices

To configure the PGM and X-10 output functions, see the corresponding sections of the control panel's Installer Guide ("OUTPUTS" menu) and User Guide ("SCHEDULER" menu).

Step	X-10 device ON	PGM device ON	X-10 or PGM device OFF	X-10 or PGM device TOGGLE
1	 (~2sec)			
2	 [P0 to P9]	 [00 to 99]	 [PGM → P0 to P9] or [X-10 → 01 to 99]	 [PGM → P0 to P9] or [X-10 → 01 to 99]
3				

Note: Long press (more than 2 sec.) of the  button initiates the X-10 function and the PGM/X-10 display (marked "4" in the "Icon and Key Indications" Figure) will read "01". Short press of the  button initiates the PGM function and the PGM/X-10 display will read "P0" with the  key. This number is incremented by 1 upon each press of the  key.

3.6 Other Functions

Output Function	Actions	Response
AUX Function		<p>Enrollment: Long key press (more than 5 sec.) until green LED lights and then release key.</p> <p>Back to Factory: Long key press (more than 7 sec.) to reset the KP-160 PG2 device to factory default settings.</p> <p> Cancels current operation: Short key press</p>
Volume control		<p>Changes the volume level upon each key press.</p> <p>Volume level alternates between 1, 2, 3, 0</p>
Mute exit beeps		<p>Mutes the exit beeps; small circle key will appear above the key. Press button again to cancel mute.</p> <p>Note: Operates only per Exit Delay duration. Upon next Exit Delay, the exit beeps will not be muted.</p>

APPENDIX A: SPECIFICATIONS

Frequency Band (MHz)	Europe and rest of world: 433-434, 868-869 USA: 912-919
Communication Protocol	PowerG
Battery type	Four 1.5V AA Alkaline batteries
Battery Life Expectancy	4 years (for typical use).
Power source (optional)	5-12VDC
Back light	Blue/white or black/white
Operating Temperature	0°C to 55°C (32°F to 131°F)
Dimensions (WxLxD)	150x100x20mm (5-7/8 x 3-7/8 x 13/16 in)
Weight (including battery and bracket)	379 g (13 oz).
Mounting	Wall-mounted or portable
Color	Black or White-Silver
Compliance with Standards	<p>Europe: EN 300220-1, EN 300220-2, EN300330, EN301489, EN60950, EN50131-1, EN50131-3, EN50131-6.</p> <p>USA: CFR 47 part 15</p> <p>Canada: RSS 210</p> <p>RFID Tags: ISO-18000-2 (125 kHz)</p>

APPENDIX B: COMPLIANCE WITH STANDARDS

This device complies with FCC Rules Part 15 and Industry Canada license-exempt RSS standard(s). Operation is subject to the following two conditions: (1) this device may not cause interference, and (2) this device must accept any interference, including interference that may cause undesired operation of the device.

Le présent appareil est conforme aux CNR d'Industrie Canada applicables aux appareils radio exempts de licence. L'exploitation est autorisée aux deux conditions suivantes : (1) l'appareil ne doit pas produire de brouillage, et (2) l'utilisateur de l'appareil doit accepter tout brouillage radioélectrique subi, même si le brouillage est susceptible d'en compromettre le fonctionnement.

WARNING! To comply with FCC and IC RF exposure compliance requirements, the mobile version of device should be located at a distance of at least 20 cm from all persons during normal operation. The antennas used for this product must not be co-located or operated in conjunction with any other antenna or transmitter.

The portable device version complies with FCC and IC RF radiation exposure limits set forth for an uncontrolled environment.

The digital circuit of this device has been tested and found to comply with the limits for a Class B digital device, pursuant to Part 15 of the FCC Rules. These limits are designed to provide reasonable protection against harmful interference in residential installations. This equipment generates, uses and can radiate radio frequency energy and, if not installed and used in accordance with the instructions, may cause harmful interference to radio and television reception. However, there is no guarantee that interference will not occur in a particular installation. If this device does cause such interference, which can be verified by turning the device off and on, the user is encouraged to eliminate the interference by one or more of the following measures:

- Re-orient or re-locate the receiving antenna.
- Increase the distance between the device and the receiver.
- Connect the device to an outlet on a circuit different from the one which supplies power to the receiver.
- Consult the dealer or an experienced radio/TV technician.

Changes or modifications not expressly approved by Visonic Ltd. could void the user's authority to operate the equipment.



W.E.E.E. Product Recycling Declaration

For information regarding the recycling of this product you must contact the company from which you originally purchased it. If you are discarding this product and not returning it for repair then you must ensure that it is returned as identified by your supplier. This product is not to be thrown away with everyday waste.

Directive 2002/96/EC Waste Electrical and Electronic Equipment.

The technical documentation as required by the European Conformity Assessment procedure is kept at: **UNIT 6 MADINGLEY COURT CHIPPENHAM DRIVE KINGSTON MILTON KEYNES MK10 0BZ. Telephone number: 0870 7300800, Fax number: 0870 7300801**

D-303169 KP-160 PG2 User's Guide Rev 3, 9/11