

DVR 786HD

Full HD Action Camcorder

User Manual



Vivitar[®]
go life.

© 2009-2014 Sakar International, Inc. All rights reserved.

Windows and the Windows logo are registered trademarks of Microsoft Corporation.

All other trademarks are the property of their respective companies.



CONTENTS

Introduction	2
What's Included	3
Parts of the Camcorder	4
Initial Camcorder Setup	5
Remote Control	10
Main Camcorder Modes	11
Camcorder Technical Specifications	12
Camcorder Mounts and Accessories	13
Powering On Your Camcorder	16
Changing Camcorder Mode	17
Navigating the Menus	18
Video Capture Mode	19
Photo Capture Mode	23
Playback Mode	27
Menu Options	31
Computer System Requirements	45
Installing the Software	46
Connecting the Camcorder to the Computer	47
Getting Photos and Videos from the Camcorder to the Computer	48
Getting Started!	49
Transferring Images Manually from the Camcorder to the Computer	49
Camcorder Maintenance	51
Sakar Warranty Card	53
Technical Support	54
Troubleshooting	54

Introduction

Thank you for purchasing this digital HD Action Camcorder. Everything you need to take quality digital videos and photos is included with your camcorder.

Vivitar makes capturing those special moments as easy as possible.

Please read this manual carefully first in order to get the most out of your digital camcorder.

NOTE:

- *Your digital action camcorder supports a Micro SD Memory Card (up to 32GB, Class 4 or higher).
In order to use your digital action camcorder normally, please insert the Micro SD Memory card before use.
Micro SD Memory cards are not included and need to be purchased separately.*
- *This camera is a plug and play device. You can download the pictures and videos without the software by directly accessing the memory card from your computer. We would however recommend that you install the 'Vivitar Experience Image Manager' Software to enjoy the full Vivitar experience.*

What's Included

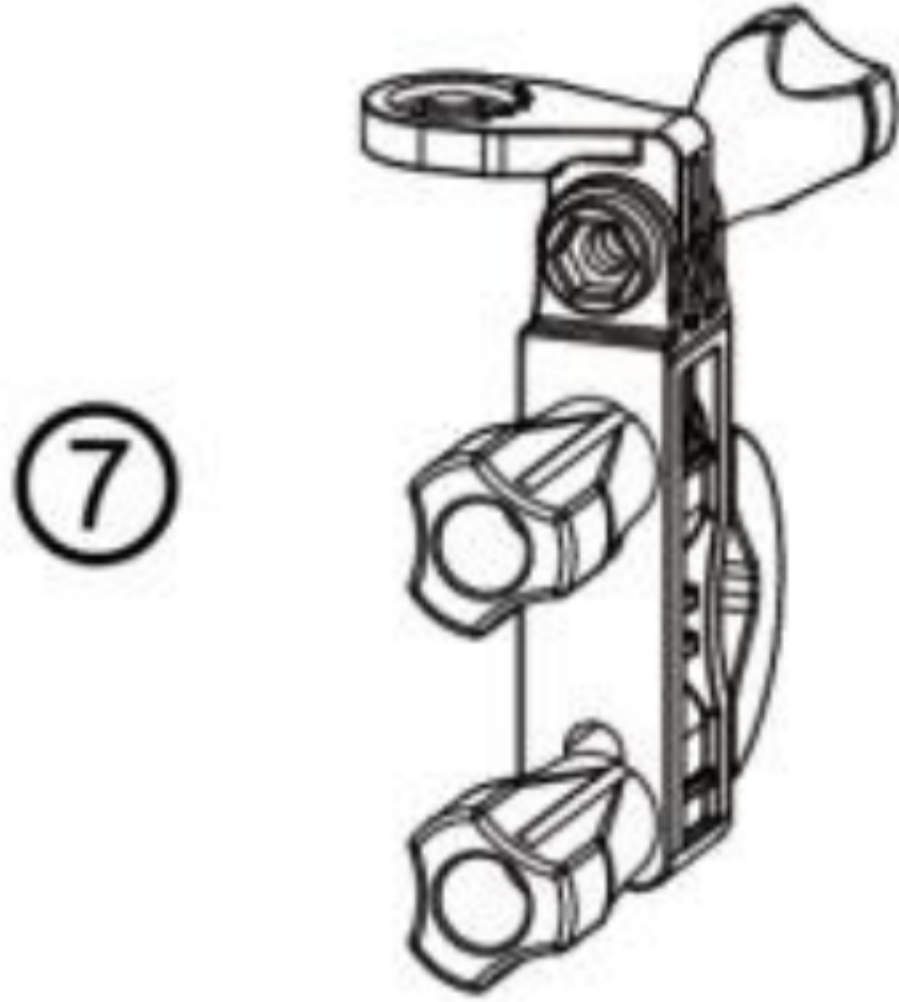
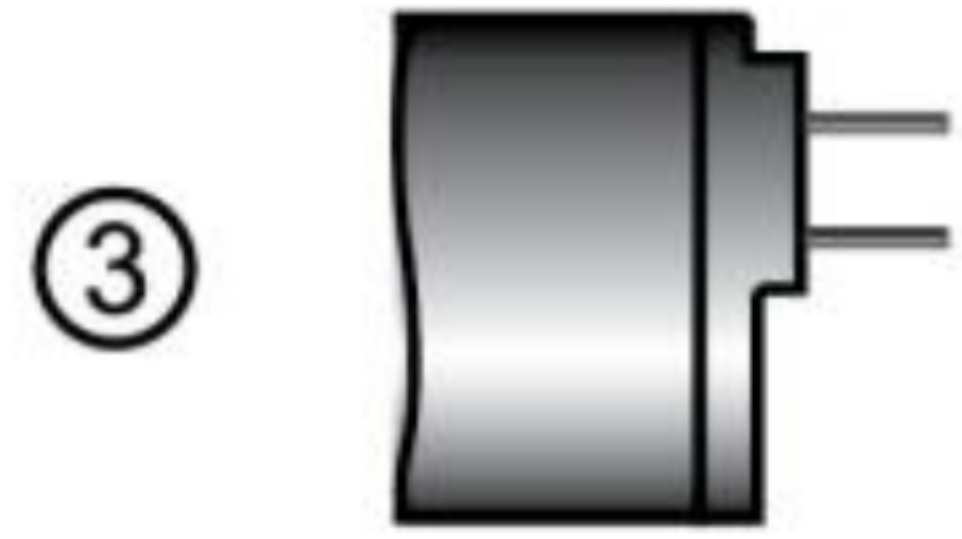

1. Action Camcorder
2. USB Cable
3. AC Adapter
4. Vivitar Experience Installation CD
5. Remote Control

6. Waterproof Casing
7. Bicycle Mount
8. Helmet Mount & Band

NOTE:

- *Camera shield and Built-in Lithium Battery included (not shown).*
- *Micro SD Card not included.*

Parts of the Camcorder

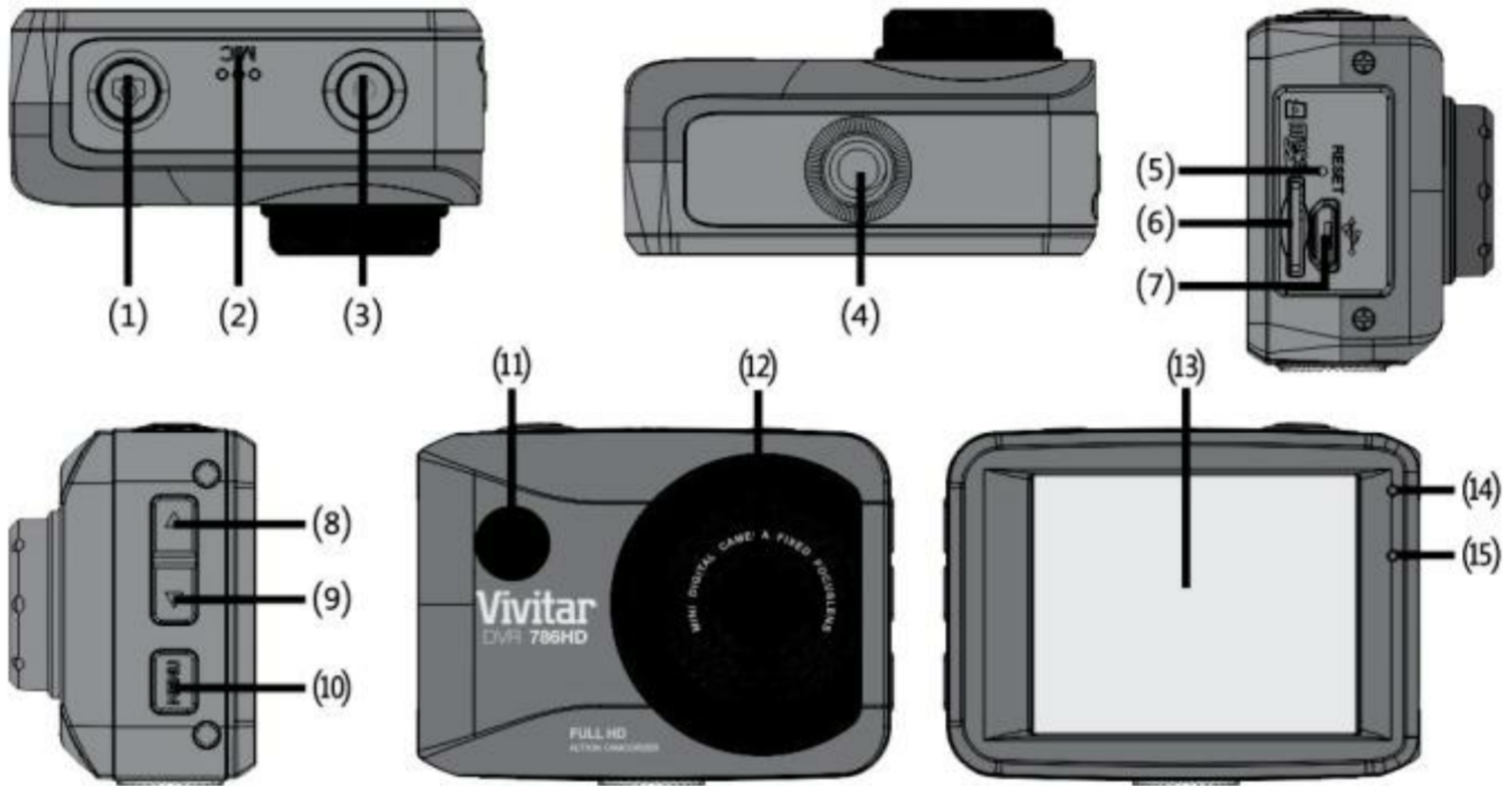

- | | |
|------------------------------|-------------------------------------|
| 1. Shutter / OK button | 9. Down / Zoom Out Button |
| 2. Microphone | 10. Menu / Back Button |
| 3. Power / Mode Button | 11. Infrared Signal Reception Light |
| 4. Tripod Mount | 12. Lens |
| 5. Reset Button | 13. LCD Screen |
| 6. Micro SD Memory Card Slot | 14. LED Charge Light Indicator |
| 7. USB Interface | 15. LED Busy Light Indicator |
| 8. UP / Zoom In Button | |

Initial Camcorder Setup

CHARGING THE BATTERY

To charge the battery, follow either one of the charging methods below:

CHARGING VIA THE COMPUTER

1. Power off the camera.
2. Use the supplied USB cable to connect the smaller end of the USB cable into the USB slot on the camcorder. Connect the other end to the USB interface of your computer.
See images below: 1 and 2.
3. The LED charge light turns on while charging is in progress. The charge light turns off when the battery is fully charged. See images below: 3 and 4.

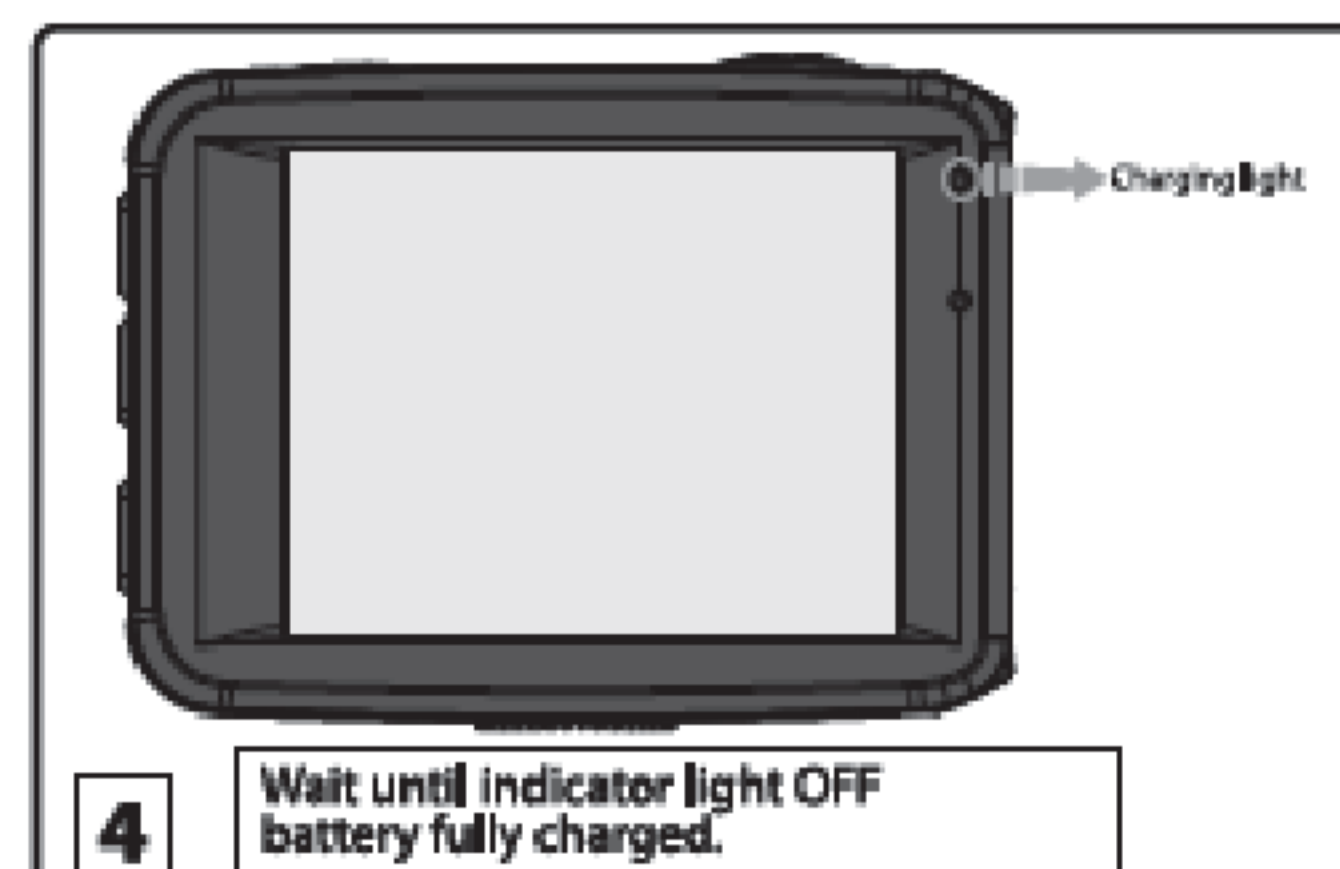
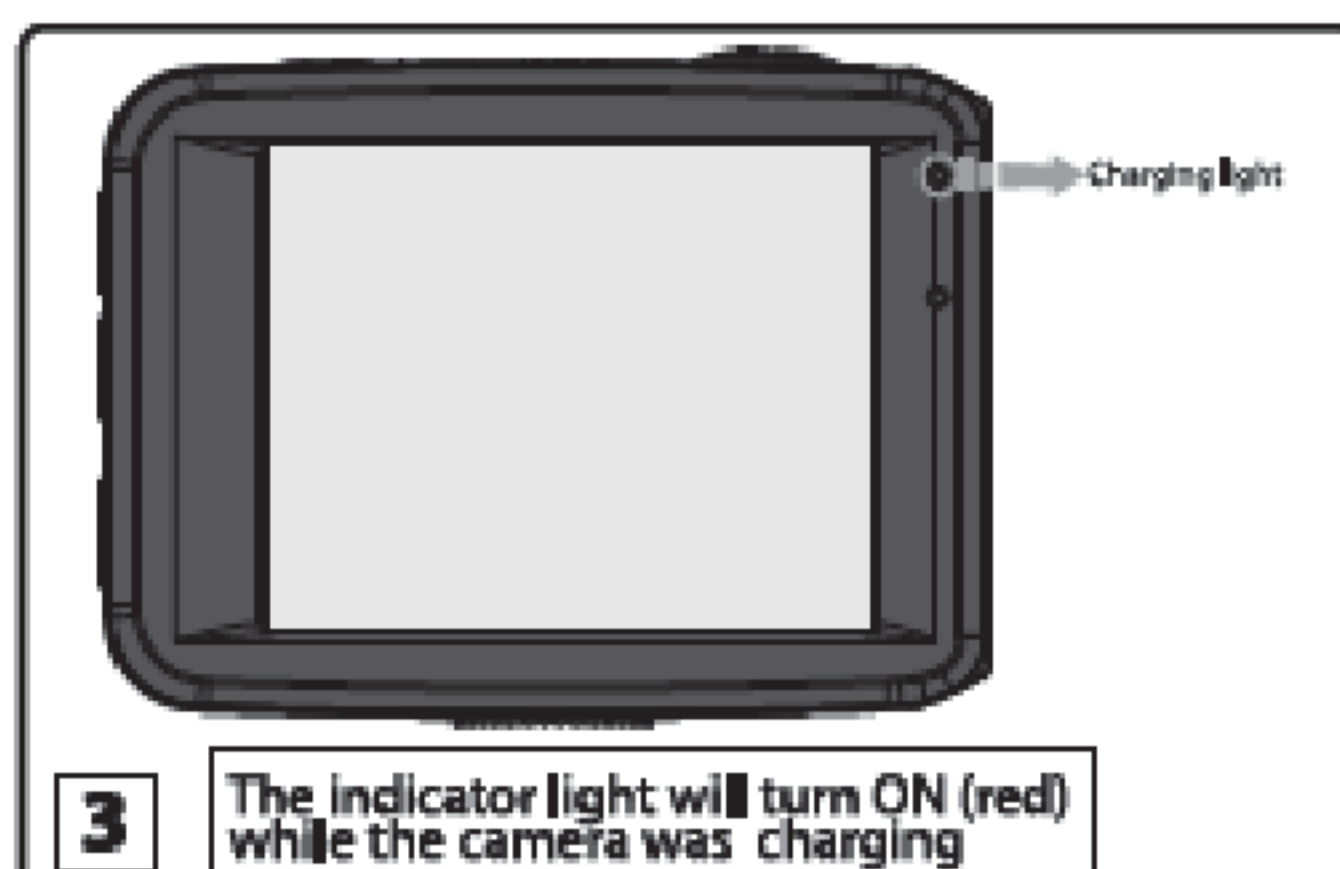
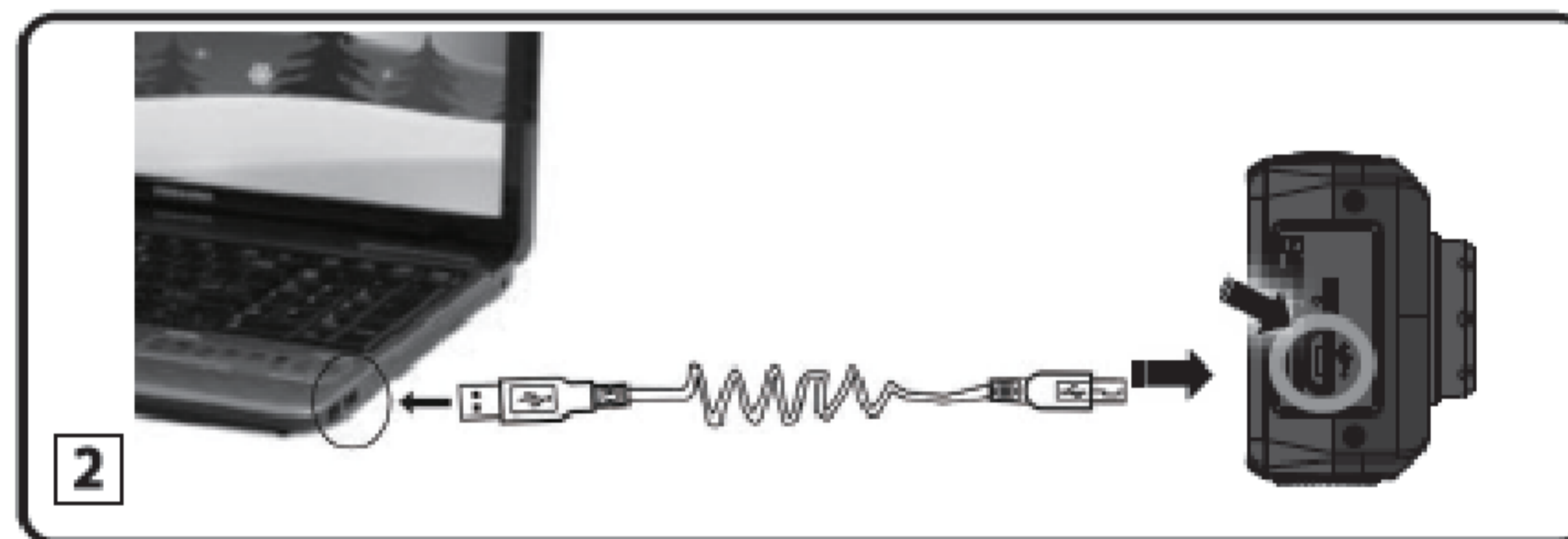

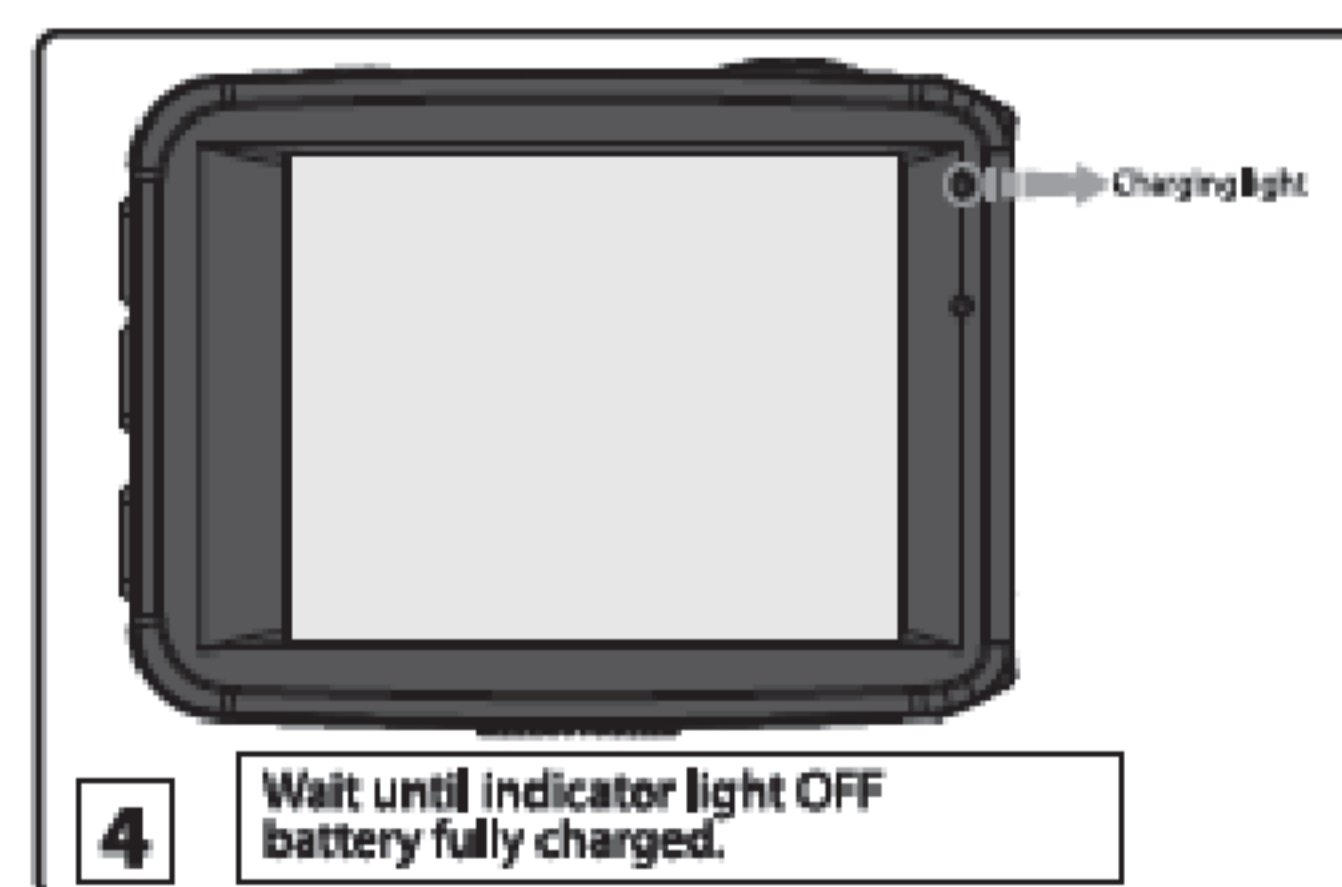
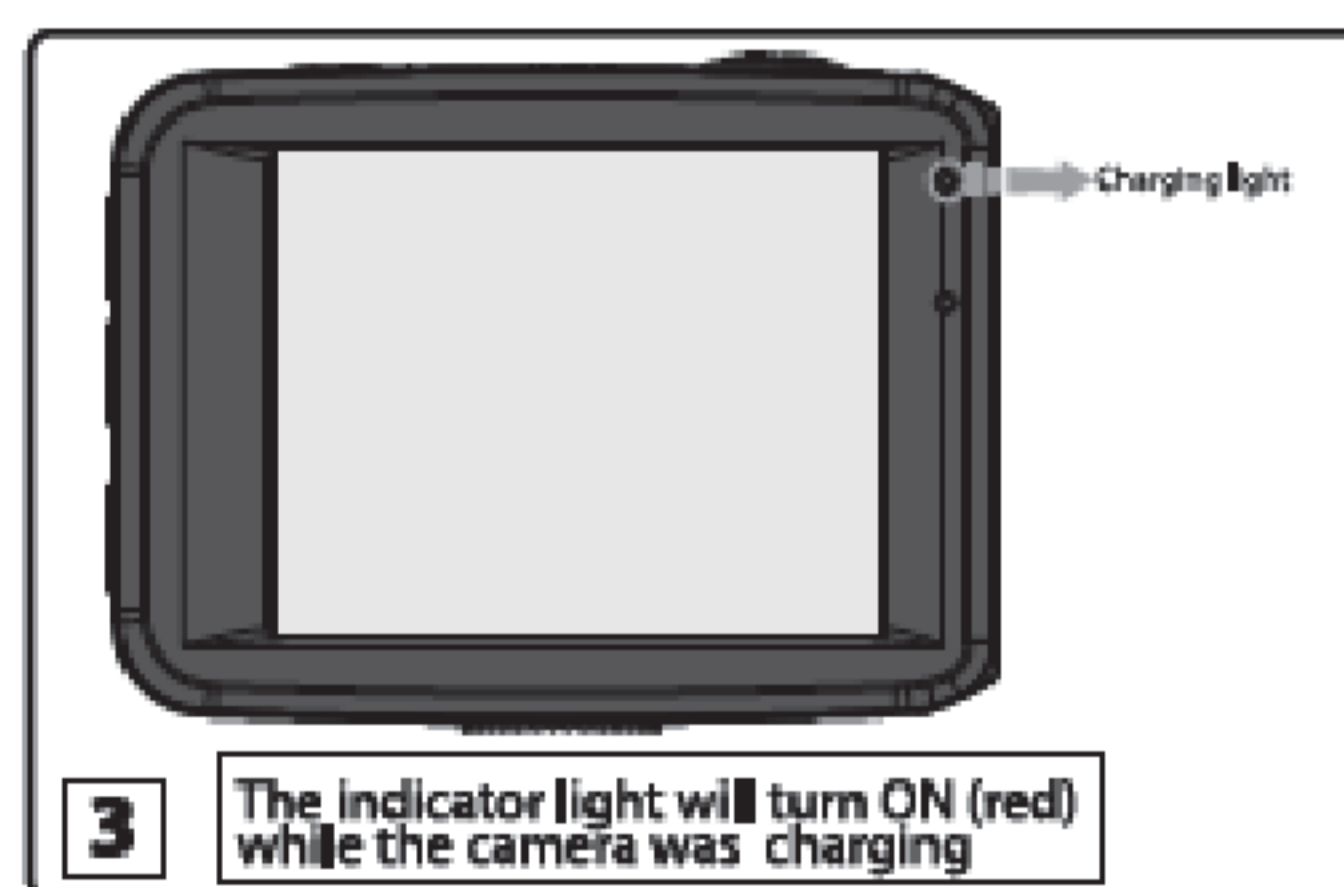
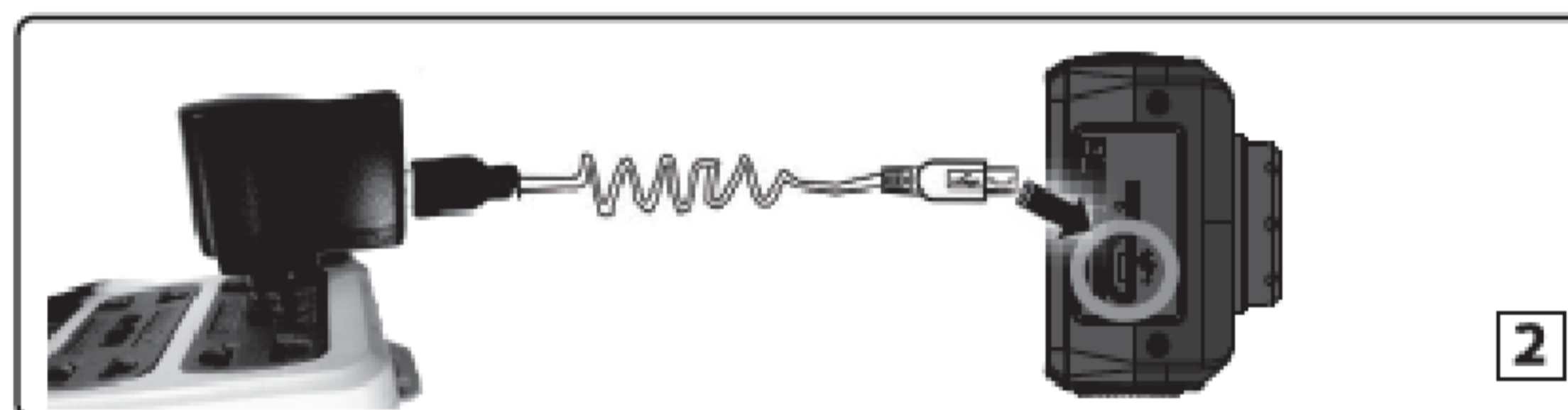

CHARGING VIA THE AC ADAPTER

1. Power off the camera.
2. Use the supplied USB cable to connect the smaller end of the USB cable into the USB slot on the camcorder. Connect the other end to the cable to the AC Adapter and then plug the AC Adapter into a power socket. See images below: 1 and 2.
3. The charge light will turn off when the battery is fully charged.
See images below: 3 and 4.



BATTERY INDICATOR

The following icons appear on the camera and indicate the status of the camera's battery power level:

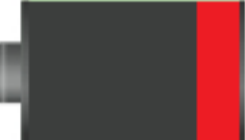
Battery Indicator	Description
	The battery level is full.
	The battery level is half.
	<p>The battery level is low, indicating to prepare for recharging the built-in lithium battery.</p> <p>Once 'Low Battery' appears on the LCD, this indicates that the battery level is completely exhausted and the camcorder automatically turns off after a few seconds.</p> <p>Please fully recharge the battery.</p>

INSTALLING THE MICRO SD MEMORY CARD

Make sure a Micro SD Memory card Class 4 or higher (up to 32 GB) has been properly inserted into your camcorder. Micro SD Memory card not included.

To properly insert the Micro SD Memory Card:

1. Power off the camcorder.
2. Insert the Micro SD Card into the Micro SD Card slot in the direction as shown on the camcorder (see SD icon by the Micro SD card slot).
3. Gently press the Micro SD Card until you hear a slight clicking sound. This indicates the memory card has been inserted correctly.
4. To remove the card, gently press on the edge of the card to release it and pull the card out.
5. If the card is inserted or removed while the camcorder's power is on, it may damage the card and/or any recorded data. Always confirm that the power is off before inserting the card into the camcorder.

NOTE: Make sure there is room on the Micro SD Memory Card to capture images. If the memory card is full, additional images cannot be captured and saved to the card.

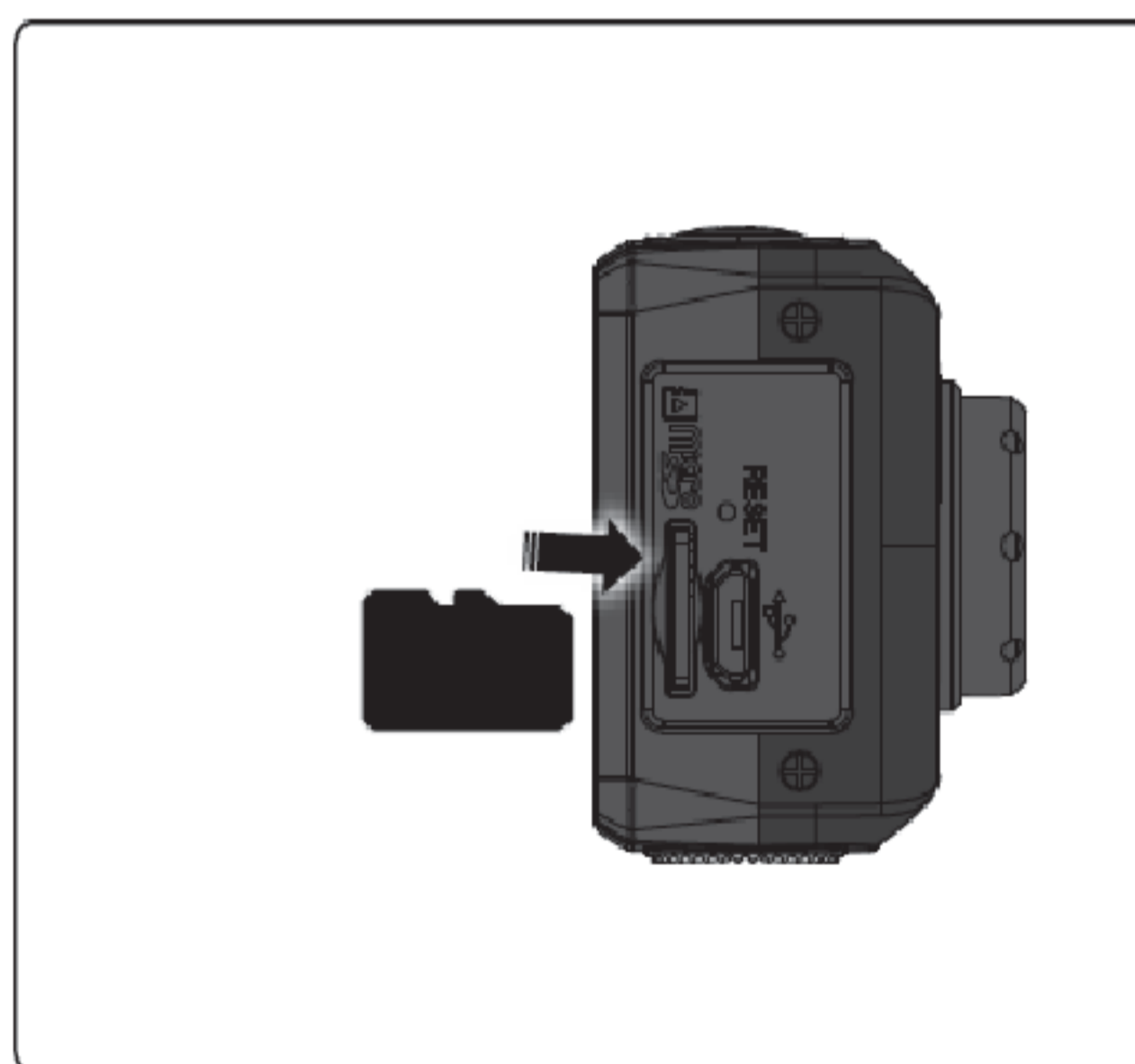

TURNING ON AND USING THE CAMERA

Press the **POWER** button, located on top of the camcorder, to turn on the camcorder.



NOTE: If the camcorder becomes unresponsive, insert a thin pin into the RESET hole and gently push the pin until you hear a slight 'click' sound. The camcorder will then reset.

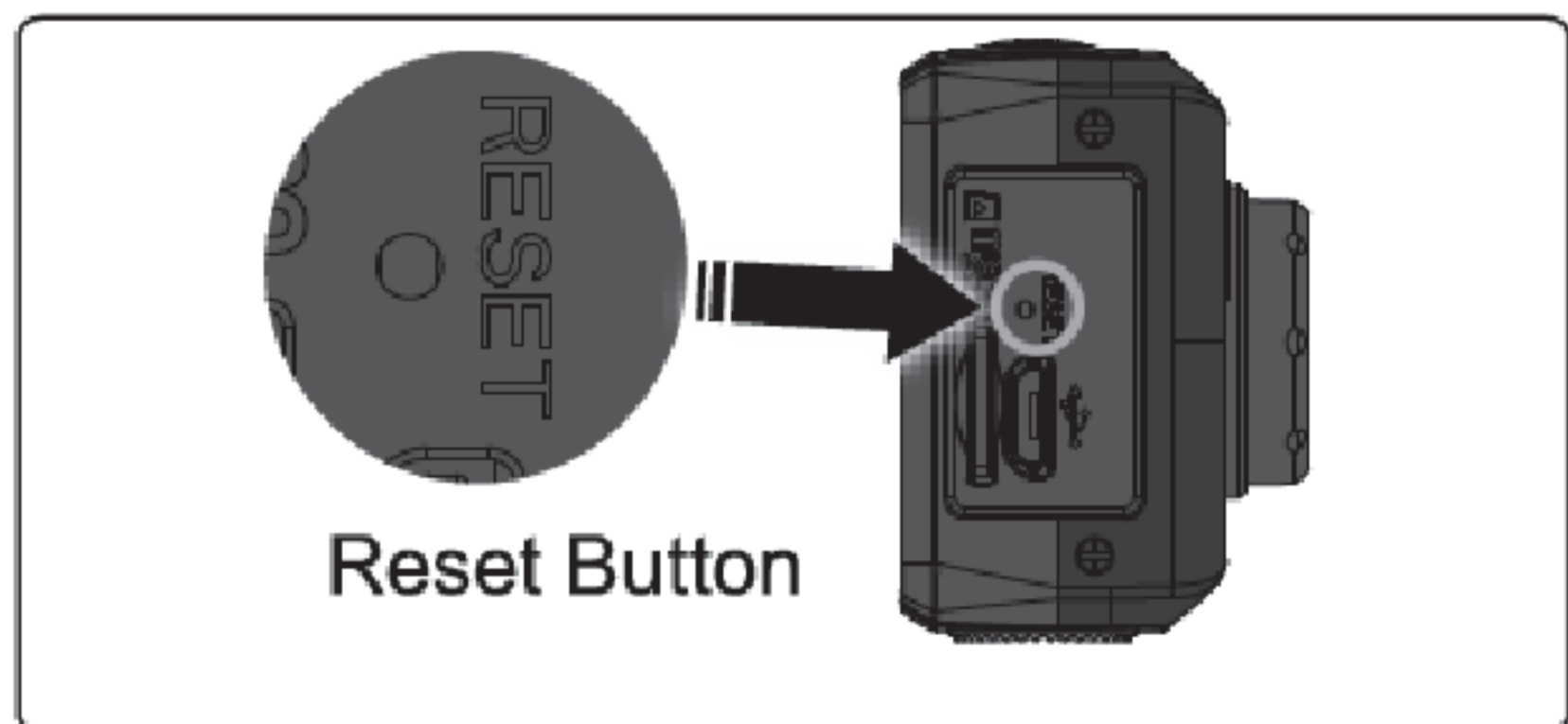

Remote Control

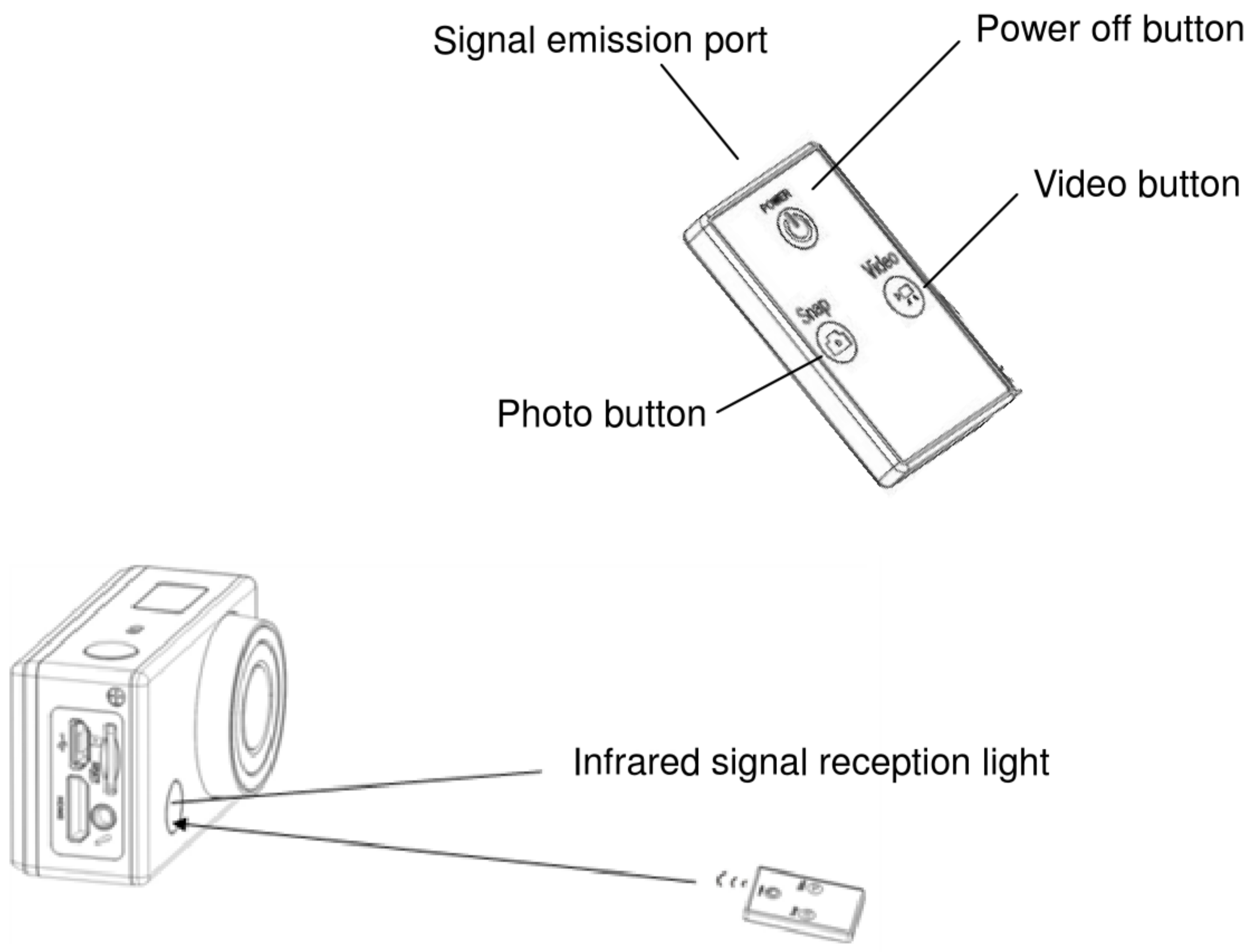

You can use the remote control to record videos, take photos and shut down the Mini Action Camcorder. When using the remote control, aim the signal emission to the port to the infrared signal reception light of the camcorder, and then press the **Video** button, **Photo (Snap)** button or **POWER OFF** button.

Remote Control Buttons:

- **Video Button**: Press the **Video** Button to start recording your video. Press the **Video** Button again to stop recording the video.
- **Photo (Snap) Button**: Press the **Photo (Snap)** Button to automatically open the Photo Capture Mode and take a Photo.
- **Power Off**: Press the **Power Off** Button to turn off your camcorder. To power on again, press the **Power** button on the camcorder.

Main Camcorder Modes



VIDEO CAPTURE MODE

Use this mode to capture videos with your digital camcorder.

Slide the **MODE** Switch to the Video Capture icon to open the Video Capture Mode.

To take a video, aim your camcorder as desired and press the **Shutter** button to start recording. A blinking, red record indicator appears on the LCD screen while the recording is in progress. To stop the recording, press the **Shutter** button again. The video is automatically saved to your camcorder's memory card.



PHOTO CAPTURE MODE

Use this mode to capture pictures with your camcorder.

Slide the **MODE** Switch to the Photo Capture icon to open the Photo Capture Mode.

To take a picture, aim your camcorder as desired and press the **Shutter** button.

The picture is automatically saved to your camcorder's memory card.



PLAYBACK MODE (PHOTOS & VIDEOS)

Use this mode to view and manage the photos and videos on your camcorder.

Slide the **MODE** Switch to the **Playback** icon to open the Playback mode for photos and videos. You can scroll through the photos and videos that you've previously taken to view or delete them as desired.

Camcorder Technical Specifications

Image Sensor	CMOS Sensor
Video Resolution	FHD (1920x1080P@30fps), HD720P (1280X720@60fps), HD720P (1280X720@30fps)
Photo Resolution	12M (4000x3000), 8M (3264x2488), 5M (2592x1944), 1M (1280x960)
File Format	AVI/MOV (Video), JPEG (Photo)
External Memory	Micro SD Memory card, Class 4 or higher, up to 32GB
LCD Display	2.0" TFT
Zoom	4X Digital Zoom
Focus Range	2.8M
White Balance	Auto, Daily, Cloudy, Fluorescent H, Tungsten
Light Exposure (Photo)	+2, +1, Auto, -1, -2
Metering	Center, Multi, Spot
Auto Power Off	Off, 1 min., 3 min., 5 min.
Languages	English, French, Spanish, Italian, Portuguese, Polish, Russian, Greek
Interface	Micro USB
System Requirements	MICROSOFT® Windows XP (SP3), Vista (SP1) or 7 MACINTOSH OSX v10.5.x and above
Battery	Built-in 700mAH Lithium Battery

Camcorder Mounts and Accessories

WATERPROOF CASE



1. Clamp
2. Shutter Release
3. Power/Mode Button
4. Tripod Mount

Your action camcorder comes with a waterproof casing for underwater action and added durability. To assemble your camera to the case, follow the instructions below:

1. To open the case: Insert a finger at the half circle of the latch by prying the latch up - away from the case.
2. Insert the camera lens forward into the case.
3. Before sealing the waterproof case, make sure the camera housing's rubber seal clean. Close the door and secure the latch.
4. While the camcorder is in the waterproof casing, press the **POWER/MODE** button to select Video Capture Mode, Photo Capture Mode or Playback Mode. Press the **Shutter** button for recording your videos and capturing your photos.

NOTE:

- *A single hair or grain of sand can cause a leak. You can test by closing the case without inserting the camera. Submerge the case completely in water for about a minute. Remove the case from the water, dry off its exterior with a towel, and then open the case. If the entire interior is dry, the case is safe for use under water.*
- *Before opening the waterproof casing and putting the device in, carefully check whether the waterproof ring of the casing is flat and smooth.*
- *After placing the device into the waterproof casing and closing the cover, carefully check whether the waterproof ring is deformed due to pressure.*
- *After every use in salt water you will need to rinse the outside of the housing with non-salt water and dry. Not doing this can eventually cause corrosion of the hinge pin and salt buildup in the seal, which can cause failure.*
- *To clean the seal, rinse in fresh water and shake dry (drying with a cloth may cause lint to compromise the seal). Re-install the seal into the grooves of the housing.*

INSTALLING THE BICYCLE MOUNT: HANDLEBAR CLAMP

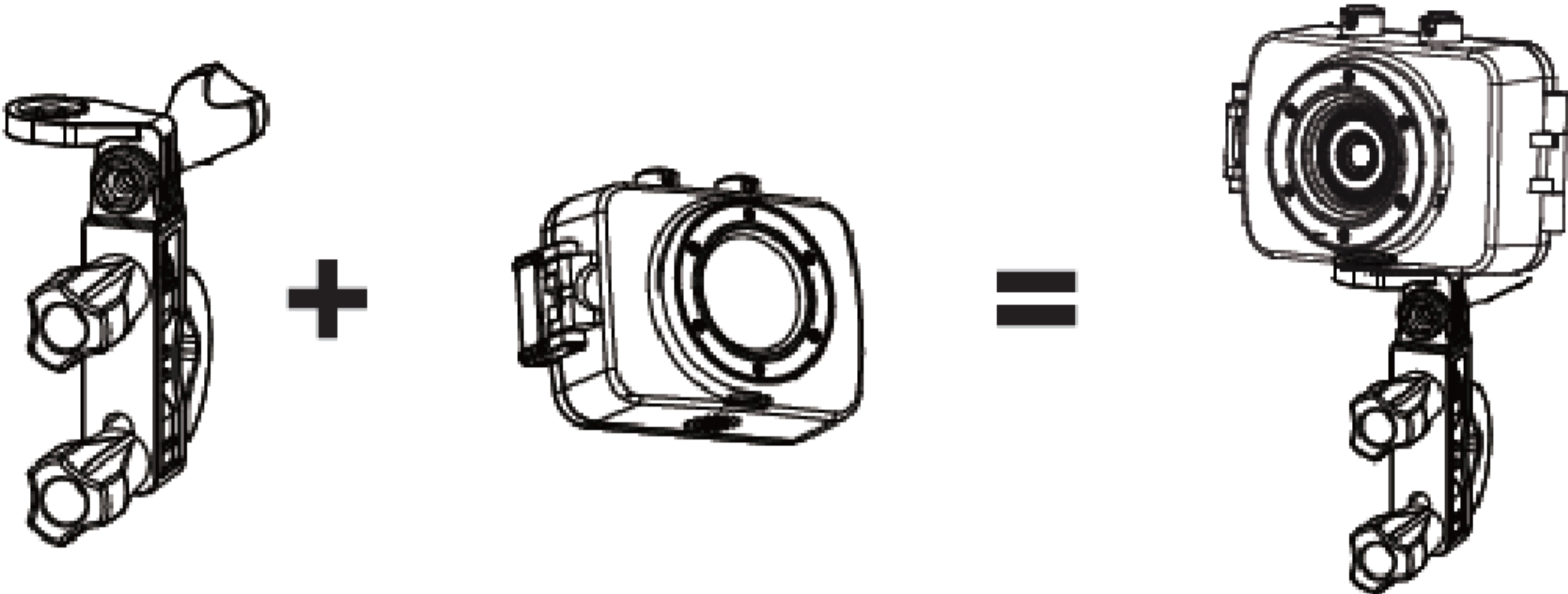

INSTALLING THE HELMET MOUNTING SYSTEM

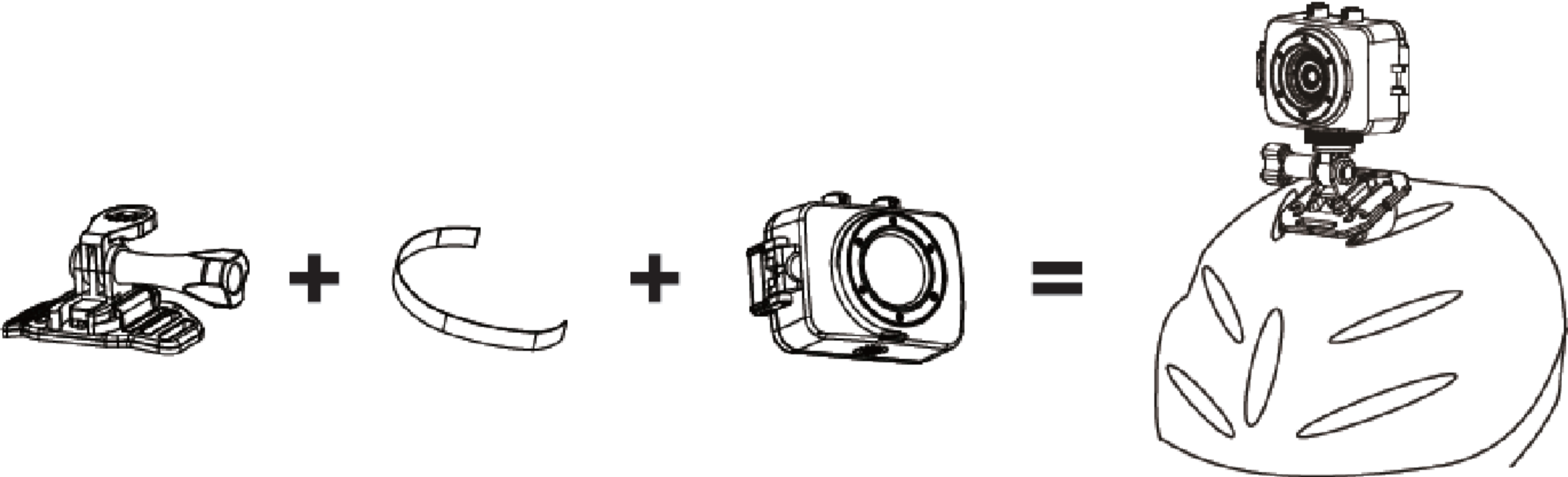

Powering On Your Camcorder

TURNING POWER ON AND OFF

1. Press and hold the **POWER** button for about 3 seconds to turn on the camcorder.
The LCD screen briefly displays the 'Vivitar' screen and opens the default Video Capture Mode. A beep can be heard from the camcorder's buzzer.
2. Press and hold the **POWER** button again for about 3 seconds to turn the power off.
The LCD screen briefly displays 'Goodbye' screen and then powers off. A beep can also be heard from the buzzer as the camcorder is being powered off.

AUTO POWER OFF – POWER SAVING FEATURE:

Your digital camcorder includes an Auto Power Off power feature that automatically turns off your camcorder after a specified time that your camcorder is left idle. The specified time can be set using the 'Power Save' menu option. Once the camcorder is automatically powered off, you can long press the **POWER** button to power on the camcorder.

Changing Camcorder Mode

THREE MAIN MODES

1. **Video Capture Mode** - Use this mode to capture videos with your camcorder.
 2. **Photo Capture Mode** - Use this mode to capture photos with your camcorder.
 3. **Playback Mode (for photos and videos)** – Use this mode to view your captured photos and videos.
- When the camera is first powered ON, the Video Capture Mode will be active.
 - The icons that appear on the LCD screen are the best default settings so that you can begin to capture and enjoy clear quality photos and videos.

SWITCHING MODES

After turning on the camcorder, you can press the **POWER/MODE** button to switch between the three modes in turn:

- In Video Capture Mode, press the **SHUTTER** button to start recording and press it again to stop.
- In Photo Capture Mode, press the **SHUTTER** button to take photo.
- In Playback Mode, press the **SHUTTER** button to play back your captured Video.



When in Video Capture Mode, this icon will display on the top-left corner of the LCD display.



When in Photo Capture Mode, this icon will display on the top-left corner of the LCD display



When in Playback Mode, this icon will display on the top-left corner of the LCD display.

Navigating the Menus

PHOTO CAPTURE, VIDEO CAPTURE AND PLAYBACK MENUS

To access the Main Menu for each Mode:

1. Press the **MENU** button to open the Main Menu for the current mode.
2. Press the **▼ DOWN** or **▲ UP** button to select a specific menu.
The selected option appears highlighted.
3. Press the **SHUTTER/OK** button to confirm and save your selection and open the options for the menu you have selected.
4. To select a specific option, press the **▼ DOWN** or **▲ UP** button and then the **SHUTTER/OK** button to save the selected option and return to the Main Menu.

NOTE:

*To go back from the submenus or exit the Main Menu, press the **MENU** button.*

GENERAL CAMCORDER SETTINGS MENUS

 To access the General Camcorder Settings Menu:

1. Press the **MENU** button while in the Photo Capture, Video Capture or Playback Mode.
2. Short press the **POWER/MODE** button to select the General Camcorder Settings icon .
3. Press the **▼ DOWN** or **▲ UP** button to select a specific menu.
4. Press the **SHUTTER/OK** button to confirm and save your selection and open the options for the menu you have selected.
5. To select a specific option, press the **▼ DOWN** or **▲ UP** button and then the **SHUTTER/OK** button to save the selected option and return to the Main Menu.

NOTE:

- *At any time you can press the **MENU** button to exit the menus and return to the previous screen.*
- *Once you change a setting, the setting is saved by your camera until you manually change the setting or restore the camera's default factory settings.*
- *After selecting your desired setting, some settings appear as an icon on the LCD screen in Capture Mode – indicating the option selected.*

Video Capture Mode

The Video Capture Mode allows you to capture videos with your digital camcorder.

When first powering on your camcorder, Video Capture Mode appears.



The Video Capture icon appears on the LCD screen.

TAKING A VIDEO

1. Selecting the Scene with the LCD Display:

While in Video Capture Mode use the LCD display to direct the camcorder at the scene you would like to capture.

NOTE: *The time available for video capture (as per the installed memory card size and selected resolution) is shown on the top right of the LCD screen.*

2. Zoom Options:

Press the **▲ UP / ZOOM IN** or **▼ DOWN / ZOOM OUT** button to better set the camcorder display if desired.

NOTE: *While using the Zoom options, the zoom magnification is indicated on the top right of the LCD screen.*

3. Changing Resolution:

If you would like to change the resolution, press the **MENU** button and then press the **▼ DOWN** button to select 'Movie Size'. Next, press the **SHUTTER/OK** button to view the Movie Size options. Press the **▲ UP / ▼ DOWN** button to select an option and then press the **SHUTTER/OK** button to confirm the option.

The Movie Size options include:

1080P - FHD 1920x1080P@30fps

720P - HD720P 1280X720@60fps

720P - HD720P 1280X720@30fps

4. Capturing the Video:

START: Press the **SHUTTER** button to start the video capture.

The camcorder's LED busy light turns on and blinks. All icons disappear and the elapsed time appears on the top right corner of the LCD screen along with a blinking '**•REC**' icon

that indicates the recording is in progress.

STOP: To stop the video recording, press the **SHUTTER** button again.

5. The video is automatically saved to the camcorder's Micro SD Memory card.

NOTE:

- *When using the Waterproof Case, make sure to set the zoom and camcorder settings before placing it into the case.*
- *While capturing your video, after approximately one minute of video capture, the LCD display turns off in order to save power. The busy LED light remains on and the video continues to be captured. Press the **SHUTTER** button to reactivate the LCD display.*

VIDEO CAPTURE MODE BUTTONS

Button	Description
SHUTTER/OK	<ul style="list-style-type: none">• START/STOP: Starts and stops the video capture.• ENTERS and SAVES SELECTION: Within the Menu, enters and saves the selected Menu Option.
MENU	Opens and exits the menu options for Video Capture Mode and General Camera Settings. NOTE: Use the UP/DOWN/POWER buttons to navigate.
POWER / MODE	<ul style="list-style-type: none">• LONG PRESS: Powers the camcorder on/off.• SHORT PRESS:<ul style="list-style-type: none">- Standby Mode: Toggles between the Video Capture Mode, Photo Capture Mode and Playback Mode.- Menu Mode: Toggles between the current mode menu and the camcorder setting menus.
▲ UP	<ul style="list-style-type: none">• ZOOM: Zooms IN• NAVIGATES MENU: Navigates within the Menus.
▼ DOWN	<ul style="list-style-type: none">• ZOOM: Zooms OUT• NAVIGATES MENU: Navigates within the Menus.

VIDEO CAPTURE MODE LCD ICON STATUS DESCRIPTION

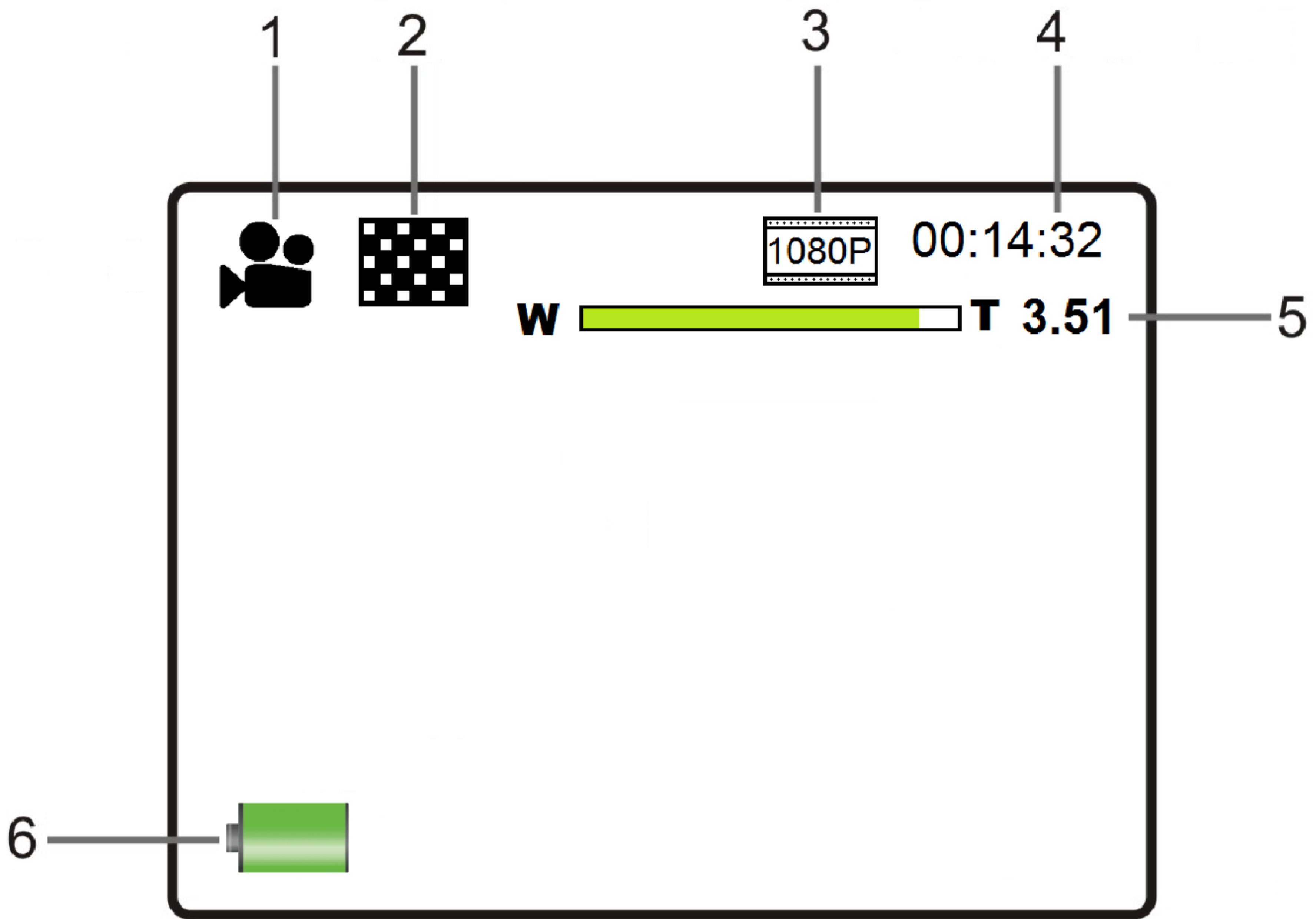

The following icons appear on the LCD screen and indicate the selected menu options and camera status.

Item	Function	Description
1	Mode Selection	Displays the current selected Mode:  Video Capture Mode
2	Video Quality	Displays the selected Video Quality Setting. The Video Quality options include: Super Fine, Fine, Normal
3	Video Resolution Selection	Displays the selected Resolution Setting. The Resolution options include:



		<p>1080P - FHD 1920x1080P@30fps</p> <p>720P - HD720P 1280X720@60fps</p> <p>720P - HD720P 1280X720@30fps</p>
4	Video Counter / Record Indicator	<ul style="list-style-type: none"> • Standby Mode: Displays the amount of time available for video capture as per selected video resolution and memory card size. • Record Mode: Displays the elapsed time as the video is being recorded and a blinking '•REC' icon appears. Note that all Standby icons do not appear while recording is in progress.
5	Zoom Indicator	Displays the zoom magnification amount as you press Zoom In and Zoom Out. x1.0 – x4.0
6	Battery Indicator	<p>Displays the current status of the battery level.</p> <p> The battery level is full.</p> <p> The battery level is empty. Indication to recharge the battery.</p>

Photo Capture Mode

The Photo Capture Mode allows you to capture photos with your digital camcorder.

To enter Photo Capture Mode, power on the camcorder and then short press the **POWER/MODE** button once.

 The Photo Capture icon appears on the LCD screen.

TAKING A PICTURE

1. Selecting the Scene with the LCD Display:

While in Photo Capture Mode use the LCD display to direct the camcorder at the scene you would like to capture.

2. Zoom Options:

Press the **▲ UP / ZOOM IN** or **▼ DOWN / ZOOM OUT** button to better set the camcorder display if desired.

***NOTE:** While using the Zoom options, the zoom magnification is indicated on the top right of the LCD screen.*

3. Changing Resolution:

If you would like to change the resolution, press the **MENU** button and then press the **▼ DOWN** button to select 'Resolution'. Next, press the **SHUTTER/OK** button to view the Resolution options. Press the **▲ UP / ▼ DOWN** button to select an option and then press the **SHUTTER/OK** button to confirm the option.

The Resolution options include:

12M (4000x3000)

8M (3264x2488)

5M (2592x1944)

1M (1280x960)

4. Press the **SHUTTER** button to capture the photo.

The amount of photos that can be captured with the available memory and selected resolution appears on the top, right corner of the LCD screen.

5. The photo is automatically saved to the camcorder's Micro SD Memory card.

NOTE:

When using the Waterproof Case, make sure to set the zoom and camcorder settings before placing it into the case.

PHOTO CAPTURE MODE BUTTONS

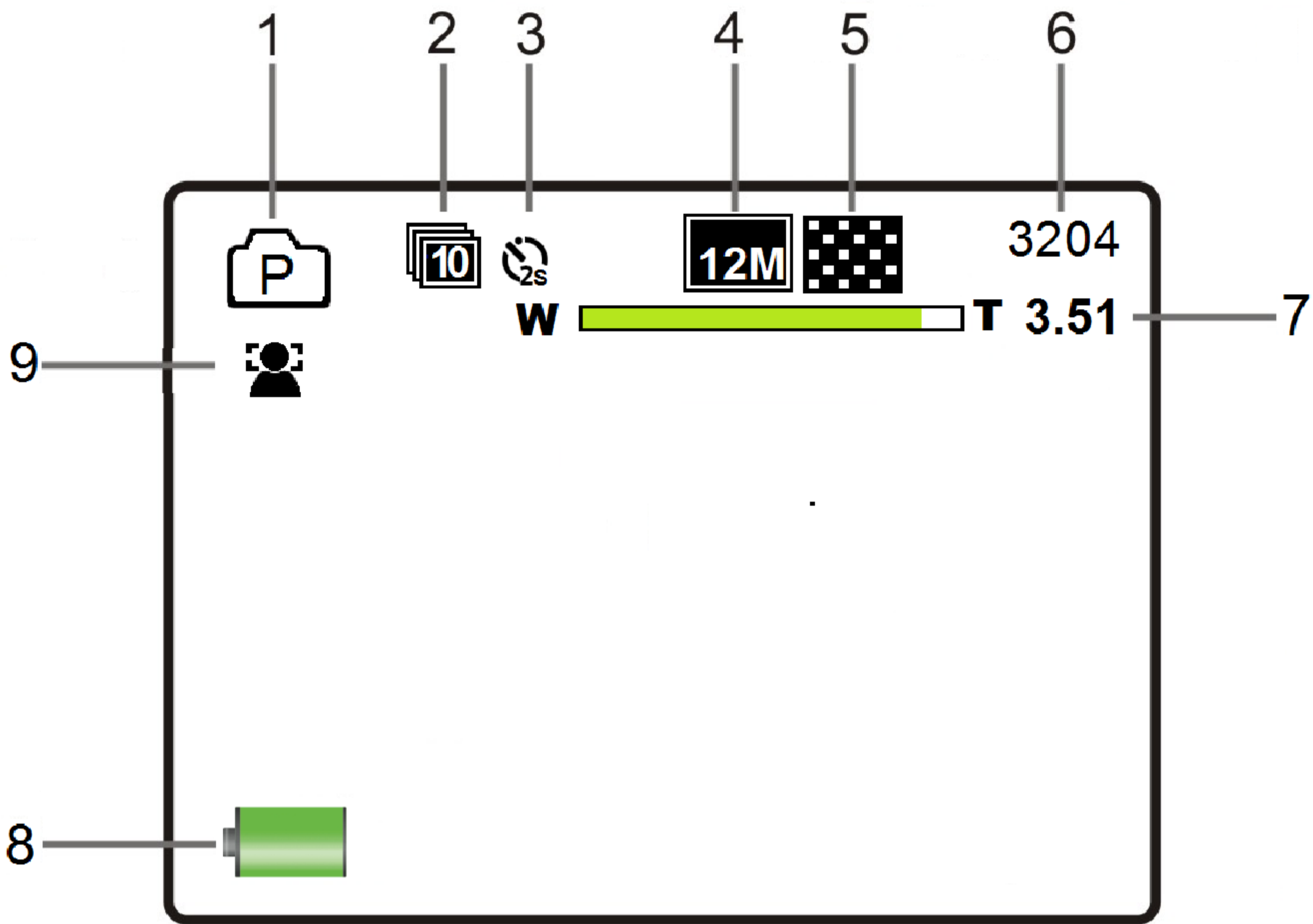

Button	Description
SHUTTER/OK	<ul style="list-style-type: none">• PHOTO CAPTURE: Press to take the picture.• ENTERS and SAVES SELECTION: Within the Menu, enters and saves the selected Menu Option.
MENU	Opens and exits the menu options for Photo Capture Mode and General Camera Settings. NOTE: Use the UP/DOWN/POWER buttons to navigate.
POWER / MODE	<ul style="list-style-type: none">• LONG PRESS: Powers the camcorder on/off.• SHORT PRESS:<ul style="list-style-type: none">- Standby Mode: Toggles between the Video Capture Mode, Photo Capture Mode and Playback Mode.- Menu Mode: Toggles between the current mode menu and the camcorder setting menus.
▲ UP	<ul style="list-style-type: none">• ZOOM: Zooms IN• NAVIGATES MENU: Navigates within the Menus.
▼ DOWN	<ul style="list-style-type: none">• ZOOM: Zooms OUT• NAVIGATES MENU: Navigates within the Menus.

PHOTO CAPTURE MODE LCD ICON STATUS DESCRIPTION



The following icons appear on the LCD screen and indicate the selected menu options and camera status.

Item	Function	Description
1	Mode Selection	Displays the current selected Mode:  Photo Capture Mode
2	Burst Mode	Displays the selected Burst Mode setting: The Burst Mode options include: OFF (no icon), 3 photos , 5 photos , 10 photos
3	Self-Timer	Displays the selected Self-Timer setting: The Self-Timer options include: OFF (no icon), 2 seconds , 10 seconds

4	Photo Quality	Displays the selected Quality Setting. The Quality options include: Super Fine, Fine, Normal
5	Photo Resolution Selection	Displays the selected Resolution Setting. The Resolution options include: 12M (4000x3000), 8M (3264x2488), 5M (2592x1944), 1M (1280x960)
6	Photo Counter / Record Indicator	Displays the amount of photos available for photo capture as per selected photo resolution and memory card size.
7	Zoom Indicator	Displays the zoom magnification amount as you press Zoom In and Zoom Out. x1.0 – x4.0
8	Battery Indicator	Displays the current status of the battery level.  The battery level is full.  The battery level is empty. Indication to recharge the battery.
9	Detection	Displays the selected Detection setting. The Detection options include: OFF (no icon), Face Tracking, Smile Detect

NOTE:

- *Some icons appear only when the selected setting is ON as per the selected option. These settings include: **Burst Mode, Self-Timer, Detection***
- *If the selection is set to OFF: No icon is displayed on the LCD.*

Playback Mode

The Playback mode allows you to review and delete photos and videos that you've captured with your camcorder.

To enter Playback Mode, power on your camcorder and then short press the **POWER/MODE** button twice.



The Playback Mode icon appears on the LCD screen.

VIEWING CAPTURED IMAGES

While in Playback mode, you can scroll through your captured images to view each image.

1. Press the ▼ **DOWN** button to view the next image.
2. Press the ▲ **UP** button to view the previous image.

NOTE:

- *Videos appear with the Video icon displayed on the bottom, left corner of the LCD screen. Photos appear without an icon.*
- *The numbered sequence of captured images is shown on the top, right of the LCD screen.*

PLAYING CAPTURED VIDEOS ON YOUR CAMCORDER

1. Scroll through your captured images to select the video you would like to play.
2. VIDEO CONTROLS:
 - **PLAY/PAUSE:** To play the selected video, press the **SHUTTER/OK** button. While the video is playing the elapsed time is displayed on the top right. The video controls are displayed on the bottom:
PLAY/: To play the selected video, press the **SHUTTER/OK** button.
 - **REWIND:** Press the ▲ **UP** button to fast **REWIND** the video.
 - **PAUSE:** Press the **OK** button to **PAUSE** the video and press again to continue playing

the video.

- **FORWARD:** Press the ▼ **DOWN** button to fast **FORWARD** the video.
- **STOP:** Press the **MENU** button to **STOP** the video playback.

NOTE: Your camcorder does not include a speaker. In order to hear the sound of the captured video you must view the file on your computer. Connect your camcorder via the supplied USB cable to your computer and then you can either download or view directly from the camcorder on your computer. See the following sections for more information:

- 'Getting Photos and Videos from the Camera to the Computer'
- 'Transferring Images Manually from the Camcorder to the Computer'

DELETING CAPTURED IMAGES

While in the Playback mode, you can delete captured videos and photos saved to the Micro SD Memory card in your camcorder using the Playback menu.

1. Enter the Playback Mode.

The last captured image (video or photo) appears.

2. Select the image you would like to delete.
3. Press the **MENU** button to enter the Playback Mode menu options.

NOTE: To exit the menu options, press the **MENU** button.

4. Press the ▲ **UP** or ▼ **DOWN** button to select and highlight the 'Delete...' menu option.
5. Press **OK** to enter the 'Delete' menu options.

The following options appear:

- **Single:** This option deletes the selected image.
- **All:** This option deletes all unlocked images (videos and photos).

Press the ▲ **UP** or ▼ **DOWN** button to select an option and then press the **OK** button to confirm.

6. A window then appears to confirm your selected 'Delete' option.

The following options appear:

- **Yes:** This option deletes the selected file (if **Single** was selected) or all files (if **All** was

selected).

- **No**: This option returns to the previous 'Delete' menu screen without deleting the image(s).





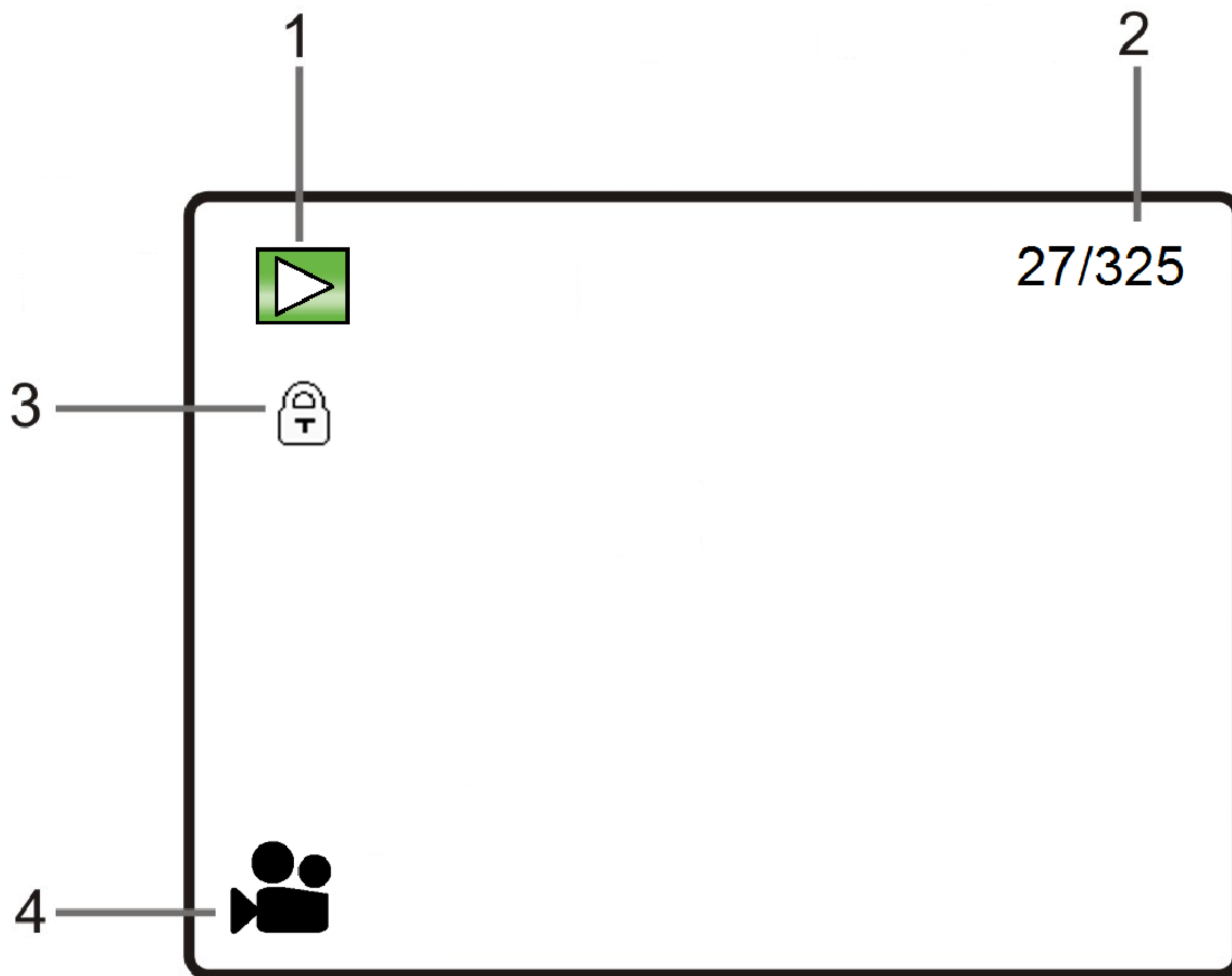

Press the **▲ UP** or **▼ DOWN** button to select an option and then press the **OK** button to confirm.

Caution: Please use the 'Delete' feature with care. Once images are deleted they are permanently deleted from the Micro SD Memory card. Please make sure that you only use this feature once you have downloaded and saved all the images you wish to your computer.

PLAYBACK MODE LCD ICON STATUS DESCRIPTION



The following icons appear on the LCD screen and indicate the selected menu options and camera status.

Item	Function	Description
1	Mode Selection	Displays the current mode:  Playback Mode
2	Image Counter ; Elapsed Time	<ul style="list-style-type: none"> Preview Mode: Displays number of the current image / Total number of captured images (both photos and videos) Video Playback Mode: Displays elapsed time of playing video.
3	Protect/Lock	 The lock symbol indicates the image is locked. Image without the lock symbol indicates the image is not locked.
4	Video File & Video Controls	<p>Video icon displays only when there is a captured video shown in Playback Mode.</p> <p>When a photo is displayed in the Playback Mode, no icon is shown on the LCD.</p> <p>The following video controls are displayed on the bottom of the screen only during video playback:</p> <p>SHUTTER/OK:  Play and  Pause</p> <p>UP:  Rewind</p> <p>DOWN:  Fast Forward</p> <p>MENU:  Stop</p>

Menu Options

NAVIGATING THE MENUS

PHOTO CAPTURE, VIDEO CAPTURE AND PLAYBACK MENUS

To access the Main Menu for each Mode:

1. Press the **MENU** button to open the Main Menu for the current mode.
2. Press the **▼ DOWN** or **▲ UP** button to select a specific menu.
The selected option appears highlighted.
3. Press the **SHUTTER/OK** button to confirm and save your selection and open the options for the menu you have selected.
4. To select a specific option, press the **▼ DOWN** or **▲ UP** button and then the **SHUTTER/OK** button to save the selected option and return to the Main Menu.

NOTE:

*To go back from the submenus or exit the Main Menu, press the **MENU** button.*

GENERAL CAMERA SETTINGS MENUS

 To access the General Camera Settings Menu:

1. Press the **MENU** button while in the Photo Capture, Video Capture or Playback Mode.
2. Short press the **POWER/MODE** button to select the General Camera Settings icon .
3. Press the **▼ DOWN** or **▲ UP** button to select a specific menu.
4. Press the **SHUTTER/OK** button to confirm and save your selection and open the options for the menu you have selected.
5. To select a specific option, press the **▼ DOWN** or **▲ UP** button and then the **SHUTTER/OK** button to save the selected option and return to the Main Menu.

NOTE:









- *At any time you can press the **MENU** button to exit the menus and return to the previous screen.*
- *Once you change a setting, the setting is saved by your camera until you manually change the setting or restore the camera's default factory settings.*
- *After selecting your desired setting, some settings appear as an icon on the LCD screen in Capture Mode – indicating the option selected.*











VIDEO CAPTURE MODE MENUS

To open the Video Capture menu options, press the **MENU** button while in Video Capture Mode.

The following menus appear:

Movie Size, Video Quality, Seamless, White Balance, Metering, Effect

Menu Name and Description	Menu Options	Menu Options Details
<p>Movie Size</p> <p><i>The Movie Size menu allows you to choose the desired size of the video taken by your camera. Keep in mind that videos with a higher resolution will also take up more of your camera's memory.</i></p>	1080P (Default)	FHD 1920x1080P@30fps
	720P	HD720P 1280X720@60fps
	720P	HD720P 1280X720@60fps
<p>Video Quality</p> <p><i>The Video Quality menu allows you to select the desired quality level of the images taken by your camera. Keep in mind that images with a higher image quality level will also take up more memory on your camera.</i></p>	 Super Fine  Fine (Default)  Normal	
<p>Seamless</p> <p><i>The Seamless feature is a circulative function which is can be used as a CAR Cam. Select the setting to a desired time and the video will be saved atomically as per the setting.</i></p> <p>NOTE: <i>If the memory card is full, the current video being recorded will replace previously recorded videos.</i></p>	Off (Default) 1 Minute 3 Minutes 5 Minutes	
<p>White Balance</p> <p><i>The White Balance feature allows your camera to adjust the coloring of the captured images depending on the type of light source in the current environment.</i></p> <p><i>Properly adjusting the White Balance setting to match your current environment will allow the camera to properly balance the colors in the images that are taken with your camera.</i></p>	 Auto (Default)	Automatic white balance.
	 Daylight	White balance selected for daylight surrounding.
	 Cloudy	White balance selected for cloudy surrounding.
	 Fluorescent H	White balance selected for fluorescent surrounding.
	 Tungsten	White balance selected for tungsten lighting.

<p>Metering</p> <p><i>The Metering setting will affect how your camera focuses when capturing an image. Depending on your selection, the camera will be more sensitive to focusing on particular areas in the display and adjust the image color and lighting accordingly.</i></p>	 Center  Multi (Default)  Spot	<p>Center – Averages the light metered from the entire frame, but giving greater weight to the subject in the center</p> <p>Multi – Used in standard conditions the camera divides and adjusts the settings of the image into several zones for light metering such as complex light conditions, position of subject, brightness, background, direct light and scenes</p> <p>Spot – Meters the area within the spot point frame at the center of the LCD to set the exposure on the subject in the center of the monitor.</p>
<p>Effect</p> <p><i>The Effect menu allows you to select a unique effect that can create an interesting look to your photo.</i></p>	 Normal (Default)  B&W  Sepia  Negative  Red  Green  Blue	<p>Displays the selected color effect on the LCD screen as you capture your images with the selected special effect.</p>

NOTE:

Some setting icons appear only when the selected setting is ON:







-  **Face Detect:** *The Face Detect icon appears on the left below the Video Capture Mode icon when selected setting is ON*





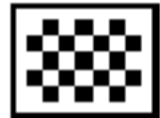















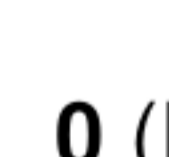

PHOTO CAPTURE MODE MENUS















To open the Photo Capture menu options, press the **MENU** button while in Photo Capture Mode.



The following menus appear:

Resolution, Quality, Metering, White Balance, ISO, Exposure, Self-Timer, Burst Mode, Sharpness, Effect, Date Stamp, Detection, Digital Zoom

Menu Name and Description	Menu Options	Menu Option Details
<p>Resolution</p> <p><i>The Resolution menu allows you to choose the desired size of the images taken by your camera. Keep in mind that images with a higher resolution will also take up more of your camera's memory.</i></p>	<p>12M pixel resolution</p> <p>8M pixel resolution</p> <p>5M pixel resolution (Default)</p> <p>1M pixel resolution</p>	<p>4000x3000</p> <p>3264 x 2448</p> <p>2592x1944</p> <p>280x960</p>
<p>Quality</p> <p><i>The Quality menu allows you to select the desired quality level of the images taken by your camera. Keep in mind that images with a higher image quality level will also take up more memory on your camera.</i></p>	<p> Super Fine (Default)</p> <p> Fine</p> <p> Normal</p>	<p>Displays the picture Quality setting.</p>
<p>Metering</p> <p><i>The Metering setting will affect how your camera focuses when capturing an image. Depending on your selection, the camera will be more sensitive to focusing on particular areas in the display and adjust the image color and lighting accordingly.</i></p>	<p> Center</p> <p> Multi (Default)</p> <p> Spot</p>	<p>Center – Averages the light metered from the entire frame, but giving greater weight to the subject in the center</p> <p>Multi – Used in standard conditions the camera divides and adjusts the settings of the image into several zones for light metering such as complex light conditions, position of subject, brightness, background, direct light and scenes</p> <p>Spot – Meters the area within the spot point frame at the center of the LCD to set the exposure on the subject in the center of the monitor.</p>

<p>White Balance</p> <p><i>The White Balance feature allows your camera to adjust the coloring of the captured images depending on the type of light source in the current environment.</i></p> <p><i>Properly adjusting the White Balance setting to match your current environment will allow the camera to properly balance the colors in the images that are taken with your camera.</i></p>	 Auto (Default)	Automatic white balance.
	 Daylight	White balance selected for daylight surrounding.
	 Cloudy	White balance selected for cloudy surrounding.
	 Fluorescent H	White balance selected for fluorescent surrounding.
	 Tungsten	White balance selected for tungsten lighting.
<p>ISO</p> <p><i>The ISO menu allows you to set the level of sensitivity that your camera has to light in the surrounding environment. When the ISO level is increased, the image sensor in your camera will be more sensitive to light and allow you to capture images in lower-light situations. The higher sensitivity to light however, may reduce the quality of the images that are taken.</i></p> <p><i>When the ISO is reduced, the image sensor in your camera will be less sensitive to light and will optimize the image quality in environments with bright lighting.</i></p>	 Auto (Default)	Displays the Sensitivity setting.
	 50	
	 100	
	 200	
	 400	
<p>Exposure</p> <p><i>The Light Exposure setting helps you control the amount of light that enters your camera's lens. This setting should be adjusted when the environment is lighter or darker than normal.</i></p> <p><i>When the environment has more light than is needed, reduce the exposure setting (by using the negative - count) to reduce the amount of light allowed into the lens by your camera.</i></p> <p><i>If the environment has less light (darker) than is needed, increase the exposure setting (by using the positive + count) to increase the amount of light allowed into the lens by your camera.</i></p>	  ±2.0	Displays selected EV± value.
	  ±1.7	
	  ±1.3	
	  ±1.0	
	  ±0.7	
	  ±0.3	
	 0 (Default)	
<p>Self Timer</p> <p><i>The Self Timer menu allows you to set a delay between the time that the camera's Shutter button is pressed and the actual</i></p>	OFF (Default) - no icon	OFF – The photo is taken as soon as you press the Shutter button.
	 2S	

<p>capture of the picture. This is an optimal feature if you don't just want to take the picture but would also like to be in the picture yourself. Just set the Self Timer, press the Shutter button on your camera and position yourself in front of the camera as desired.</p>	 10S	<p>2S - Set a 2-second delay from when you press the Shutter button until the photo is taken.</p> <p>10S - Set a 10-second delay from when you press the Shutter button until the photo is taken.</p>
<p>Burst Mode</p> <p>When enabled, the 'Burst Mode' feature allows you to take rapid snapshots in a row with a single click of the Shutter button. This feature can be effective when trying to capture a particular moment in a sporting event or other scenes with quick movements.</p>	<p>OFF</p>  3  5  10	<p>OFF - Normal image capture - one photo at a time (Default). No icon appears on the screen.</p> <p>3 - Captures three continuous photos.</p> <p>5 - Captures five continuous photos.</p> <p>10 - Captures ten continuous photos.</p>
<p>Sharpness</p> <p>You can set the level of sharpness in the images taken with your camera. The sharpness level dictates if the edges of objects in the image are more or less distinct.</p>	 Hard  Normal (Default)  Soft	<p>Displays Sharpness setting.</p>
<p>Effect</p> <p>The Effect menu allows you to select a unique effect that can create an interesting look to your photo.</p>	 Normal (Default)  B&W  Sepia  Negative  R Red  G Green  B Blue	<p>Displays the selected color effect on the LCD screen as you capture your images with the selected special effect.</p>
<p>Date Stamp</p> <p>When you capture an image with your camera, the image can include a time stamp with the date and time that the image was taken.</p>	<p>Off (Default)</p> <p>Date</p> <p>Date & Time</p>	<p>Off – The date stamp will not appear on captured images.</p> <p>Date – The date stamp will appear on captured images.</p> <p>Date & Time - the Date and time stamp will appear on captured images.</p>

<p>Detection</p> <p><i>This feature allows your camera to use the subject of your photo to create an optimum image.</i></p>	<p>OFF - Default</p> <p> Face Tracking</p> <p> Smile Detect</p>	<p>Off – No detection used and no icon appears on the LCD.</p> <p>Face Tracking – Allows the camera to use a subject’s face as the basis for balancing the other colors and focus in the camera’s display. This feature is meant to ensure that the color and focus of your pictures will be consistently sharp and high-quality.</p> <p>Smile Detect -Allows the camera to automatically take a picture when it detects that a subject in the picture is smiling.</p>
<p>Digital Zoom</p> <p><i>The Digital Zoom feature allows you to enable and disable the zoom capability of your camera.</i></p>	<p>OFF</p> <p>ON (Default)</p>	<p>Off – This setting disables the zoom function of the camera.</p> <p>On – This setting enables the digital zoom to function.</p>

PLAYBACK MODE MENUS

To open the Playback menu options, press the **MENU** button while in Playback Mode.

VIDEO PLAYBACK MENUS

The following menus appear when a video is selected:

Protect, Delete

Menu Name and Description	Menu Options	Menu Option Details
<p>Protect</p> <p><i>Pictures and videos taken with your camcorder can be protected or “locked” to prevent any deletion or alteration being made</i></p>	<p>Single</p> <p>Protect All</p> <p>Unprotect All</p>	<p>Single - Protects/locks or unlocks the selected image (video or photo).</p>





<p>to the files. First select the image you would like to protect or unprotect and then select the appropriate menu option to either lock/protect or unlock/unprotect one image or all images.</p>		<p>Protect All - Protects/locks all images (videos and photos) saved to the memory card.</p> <p>Unprotect All - Unlocks all images (videos and photos) saved to the memory card.</p> <p>NOTE:</p> <ul style="list-style-type: none"> •  Protected/locked images appear with a protect/lock icon while viewing the image in Playback Mode. Images that are not locked do not display the lock icon. • Protected/locked images cannot be deleted. You must first unlock the image(s) and then select the 'Delete File' menu option.
<p>Delete</p> <p>While in the Playback Mode, you can delete pictures from your camera through the 'Delete' menu. You can delete a single photograph / video clip, or delete all images saved to the SD card.</p> <p>IMPORTANT: Keep in mind that deleting will permanently remove the selected images on your camera's memory card.</p>	<p>Single</p> <p>All</p>	<p>Single – Deletes the one selected file (photo/video).</p> <p>All – Deletes all the photos and videos.</p> <p>NOTE:</p> <ul style="list-style-type: none"> • Images that are protected/locked cannot be deleted. First unlock the image(s), and then proceed with deletion. • It is highly recommend first to save and download your images before deleting.





PHOTO PLAYBACK MENUS

The following menus appear when a photo is selected:

Protect, Delete, Slideshow, Photo Effect, Rotate, Resize

Menu Name and Description	Menu Options	Menu Option Details
<p>Protect <i>Pictures and videos taken with your camcorder can be protected or “locked” to prevent any deletion or alteration being made to the files.</i> <i>First select the image you would like to protect or unprotect and then select the appropriate menu option to either lock/protect or unlock/unprotect one image or all images.</i></p>	<p>Single Protect All Unprotect All</p>	<p>Single - Protects/locks or unlocks the selected image (video or photo).</p> <p>Protect All - Protects/locks all images (videos and photos) saved to the memory card.</p> <p>Unprotect All - Unlocks all images (videos and photos) saved to the memory card.</p> <p>NOTE:</p> <ul style="list-style-type: none"> •  <i>All protected images appear with a protect/lock icon while viewing the image in Playback Mode. Images that are not locked do not display the lock icon.</i> • <i>Protected/locked images cannot be deleted. You must first unlock the image(s) and then select the ‘Delete File’ menu option.</i>
<p>Delete <i>While in the Playback Mode, you can delete pictures from your camera through the ‘Delete’ menu. You can delete a single photograph / video clip, or delete all images saved to the SD card.</i></p>	<p>Single All</p>	<p>Single – Deletes the one selected file (photo/video).</p> <p>All – Deletes all the photos and videos.</p>

<p>IMPORTANT: Keep in mind that deleting will permanently remove the selected images on your camera's memory card.</p>		<p>NOTE:</p> <ul style="list-style-type: none"> • Images that are protected/locked cannot be deleted. First unlock the image(s), and then proceed with deletion. • It is highly recommend first to save and download your images before deleting.
<p>Slideshow</p> <p>You can view a Slideshow of all the pictures taken with your camera while in Playback Mode. The Slideshow menu allows you to set the interval length of time that each picture displays during the Slideshow, the transition that appears between photos and the looping of the Slideshow.</p> <p>The Slideshow menu appears active only when a photo is selected in Playback Mode.</p>	<p>Start</p> <p>Interval</p> <p>Transition</p> <p>Repeat</p>	<ul style="list-style-type: none"> • START: Select 'Start' and press the SHUTTER/OK button to begin the Slide Show. The pictures saved to the Micro SD Memory card will be displayed in sequence automatically. <ul style="list-style-type: none"> - To PAUSE: Press the UP button. - To STOP: Press the MENU button. • INTERVAL: Select 'Interval' and press the POWER/MODE button to select an interval time of 1 to 10 seconds between each photo. • TRANSITION: Select 'Transition' and press the POWER/MODE button to select the transition between each photo. • REPEAT: Select 'Repeat' and press the POWER/MODE button to select 'No' to play the Slideshow once or 'Yes' to continuously loop the playing of the Slideshow.
<p>Photo Effect</p> <p>The Photo Effect feature allows you to add special effects to your captured photos.</p>	<p> Normal (Default)</p> <p> B&W</p>	<p>Changes the photo to your selected Photo Effect. The effect is automatically</p>

	 Sepia  Negative  Red  Green  Blue	<p>applied to the photo and saved as a new, separate photo.</p>
<p>Rotate</p> <p><i>Use the 'Rotate' menu to rotate the pictures that you've taken with your camera.</i></p>	<p>Rotate</p> <p>Save</p> <p>Back</p>	<p>Rotate – Select 'Rotate' and press the SHUTTER/OK button to rotate the photo 90 degrees clockwise. Each time you select Rotate, it rotates 90° CW.</p> <p>Save – Select 'Save' and press the SHUTTER/OK button to save the rotated image.</p> <p>Back – Select 'Back' to exit the Rotate menu without saving.</p>
<p>Resize</p> <p><i>The Resize feature allows you to change the resolution of your captured image to a smaller resolution and save it as a separate image.</i></p>	<p>8M</p> <p>5M</p> <p>3M</p> <p>1M</p>	<p>NOTE: <i>You can only resize your photo to a smaller resolution size than the original photo. All resolutions above the original photo resolution are inactive.</i></p>

CAMCORDER SETTINGS MENUS

 To access the General Camcorder Settings Menu:

1. Press the **MENU** button while in the Photo Capture, Video Capture or Playback Mode.
2. Short press the **POWER/MODE** button to select the General Camcorder Settings icon .
3. Press the **▼ DOWN** or **▲ UP** button to select a specific menu.
4. Press the **SHUTTER/OK** button to confirm and save your selection and open the options for the menu you have selected.
5. To select a specific option, press the **▼ DOWN** or **▲ UP** button and then the **SHUTTER/OK** button to save the selected option and return to the Main Menu.

NOTE:

- *At any time you can press the **MENU** button to exit the menus and return to the previous screen.*
- *Once you change a setting, the setting is saved by your camera until you manually change the setting or restore the camera's default factory settings.*

The following menus appear:

Auto Review, Power Frequency, Video format, Media Format, Power Save, Date & Time, Language, Format, Reset All

Menu Name and Description	Menu Options	Menu Options Details
<p>Auto Review <i>The 'Auto Review' menu allows you to set the time the preview of the photo is shown on the LCD screen after the photo has been captured. After the preview of the photo, the camcorder returns to standby Photo Capture Mode.</i></p>	<p>Off 1S (Default) 3S 5S</p>	<p>Off – No preview image is shown on the LCD.</p> <p>1S – The preview image is shown for 1 second on the LCD after the photo has been captured.</p> <p>3S – The preview image is shown for 3 seconds on the LCD after the photo has been captured.</p> <p>5S – The preview image is</p>

		shown for 5 seconds on the LCD after the photo has been captured.
<p>Power Frequency</p> <p><i>The options in the Frequency menu represent the frequency of the electrical current in fluorescent lighting sources in your locale. If your camcorder is set to a frequency that does not match your country's electric current, you may see waves on the images taken by your camcorder.</i></p>	<p>50HZ</p> <p>60HZ (Default)</p>	<p>Selects power frequency in your location:</p> <p>50Hz: UK, Europe and Australia</p> <p>60Hz: US, Canada and South America</p>
<p>Video Format</p>	<p>MJPG</p> <p>H.264</p>	Selects the Video Format.
<p>Media Format</p>	<p>AVI</p> <p>MOV</p>	Selects the Video Media / File Format.
<p>Power Save</p> <p><i>You can use the 'Power Save' feature in order to conserve you camcorder's battery life. The designated time represents when your camcorder will automatically power off. When the camcorder sits idle for the designated period of time, the camcorder will shut off completely and will need to be powered on again with the power button before the next use.</i></p>	<p>Off</p> <p>1 min.</p> <p>3 min. (Default)</p> <p>5min.</p>	<p>OFF - The camcorder remains on.</p> <p>1min - The camcorder powers off after 1 minute of sitting idle.</p> <p>3min - The camcorder powers off after 3 minutes of sitting idle.</p> <p>5min - The camcorder powers off after 5 minutes of sitting idle.</p>
<p>Date & Time</p> <p><i>The 'Date & Time' menu allows you to set your camcorder's date and time. This date and time will appear on the captured images when the Date Stamp is set to be active.</i></p>	<p>YY/MM/DD</p> <p>HR:MIN.</p>	<p>To set the MM/DD/YY and Hour: Minutes:</p> <ul style="list-style-type: none"> - Press the UP/DOWN button to change each setting and specify the date and time. - Short press the POWER button to toggle and move between the time and date settings. - Press OK to save and confirm the date and time setting.

<p>Language <i>You can select your camera's language setting by selecting the desired language from the Language menu.</i></p>	<p>English French Spanish Italian Portuguese German Polish Russian Greek</p>	<p>Selects the camera display language.</p>
<p>Format <i>You can use the Format menu to delete all of the content that is currently on your camera's memory card.</i> <i>This option will automatically delete all of the content at one time. If you would like to delete individual images, use the Delete menu in the camera's Playback Mode.</i> Keep in mind that formatting the memory card will permanently delete all of the content on your camera's memory card. Please make sure you have backed up the images that you want before you proceed with the format of the memory card.</p>	<p>Yes No</p>	<p>Formats the Micro SD Memory Card.</p> <p>Yes – Automatically deletes all images on the memory card. The memory card will be completely formatted</p> <p>No – Does not delete the images on your memory card. Exits the 'Format' submenu screen without deleting all images</p>
<p>Reset All <i>Use the 'Reset All' menu to reset your camcorder settings to the Factory Default Settings.</i></p>	<p>Yes No</p>	<p>Resets the camera to the Factory Default Settings.</p> <p>Yes - Automatically resets to the Factory Default Settings.</p> <p>No - Does not reset to the Factory Default Settings. Exits the 'Reset All' submenu screen without resetting and keeps the current settings.</p>

Computer System Requirements

To be able to download videos and photos to your computer using the 'Vivitar Experience Image Manager' Software, you will need the following minimum configuration:

WINDOWS OS

- MICROSOFT® Windows XP with Service Pack 3, Windows Vista with Service Pack 1 or Windows 7
- Pentium® 4 processor (or above)
- 1 GB RAM, 250 MB available hard disk space
- 16-bit Color monitor, 1024 X 768 recommended screen resolution
- CD-ROM Drive
- QuickTime® 6 or higher
- MICROSOFT ® Internet Explorer 7 or higher
- Windows Media Player 10 or higher
- DirectX 9 or higher
- Internet connection required

MACINTOSH OS

- Intel processor running MACINTOSH OS X v10.5.x or later
- 1 GB RAM, 250 MB available hard disk space
- Display: 1024 x 768 or higher-resolution monitor
- QuickTime® 6 or higher
- CD-ROM Drive
- Internet connection required

NOTE:

- Internet connection required.
- Make sure the latest compatible Adobe® Flash® Player is installed on your computer.

Installing the Software

You must be connected to the Internet to install and run the Vivitar Experience™ Image Manager software.

1. Insert the installation CD into your CD-ROM drive. The installation screen should automatically open.



2. On WINDOWS OS: The Vivitar Experience Image Manager Installer window appears. If the window does not appear, open the application's CD/DVD drive and click on "Setup.exe" to launch the installer.
3. On MACINTOSH OS: Click the icon that appears on the desktop to install the Vivitar Experience Image Manager.
4. If you do not have internet access at the time of inserting the CD-ROM, connect to the internet and then click the "Install Vivitar Experience Image Manager" button to begin the installation.



NOTE: If you do not have internet access, you can still download media from the camcorder. Click the "How to transfer photos and videos from my camera to my computer" button for instructions.

5. If you have internet access, the "Choose your language" window opens, choose your

language and click “Next” to open the next window.

6. Select your camera model from the list and click “Next” to open the next window.
7. Click “Next” to confirm your camera model selection and to install the application.
8. Please wait while the application is being installed on your computer.
9. Please review the license terms.

On WINDOWS OS and Macintosh: Click the “I accept the terms of this license agreement” and then click “Next” to continue.

10. On WINDOWS OS only: Let the “Vivitar Experience Image Manager” installer create the folder to where the program will be installed, and then click “Install”.
11. Please wait while the application continues the installation process on your computer.
On MACINTOSH OS: If needed, please follow instructions to install the Adobe® Flash® Player. This requires Internet connection.

12. On WINDOWS OS: Click the “Close” button when the installation is complete.
Click the “Launch Vivitar Experience Image Manager” to open the application.
On MACINTOSH OS: Click the “Quit” button when the installation is complete.
Click the “Launch Vivitar Experience Image Manager” to open the application.

13. If you close the application you can run the Vivitar Experience Image Manager from the Programs (PC) or Applications (Mac) menu on your computer.



Connecting the Camcorder to the Computer

1. Use the supplied USB cable to connect your digital camcorder to your computer.
2. Power the camcorder ON.
3. The first time you connect the device to the computer you may have to wait a few seconds until the computer recognizes the device.

Getting Photos and Videos from the Camcorder to the Computer

The Micro SD Memory card needs to be inserted. Do not disconnect the cable during transfer.

Doing so will cancel the transfer of any files on their way to your computer.

1. Select the “Get Images” button from the Main menu.



2. The “Get media from device” window opens.
3. You can select to download videos.
4. Select your camera (removable disk) from the device window. If your camera is the only USB device connected then it will be selected automatically.
5. Select a location on the computer where to place the new video files.
6. Add the new video files to albums if desired.
7. Select to remove the media files from the selected device (removable disk) after the import.
8. Click the “Get Media” button to transfer the videos from your camera to your computer.
9. A media download progress bar appears on the bottom left showing the number of media files downloading to your computer. A message appears when the download is complete.
10. The video files that you selected are now downloaded to your computer to the selected folder ready for your use.

Getting Started!

Using the Vivitar Experience Image Manager you can:

- Upload and manage videos to and from the most popular photo sharing and social networking sites - Facebook, Flickr, Picasa, MySpace, Photobucket, Twitpic, Twitgoo and YouTube
- Seamlessly transfer videos from one social network to another
- Organize your images by creating offline and online albums
- Edit images using automatic and manual tools
- Use automatic “Geotagging” with built in Google Maps

For more details on how to use the Vivitar Experience Image Manager open the Help file or click the “Take a Tour” button on the application’s Home screen.

Transferring Images Manually from the Camcorder to the Computer

WINDOWS OS

1. Use the supplied USB cable to connect your camcorder to your computer’s USB port.
2. Power on the camcorder. ‘MSDC’ displays on the LCD screen.
3. A window appears on your computer with a list of options, select “Open folder to view files” and click ‘OK’.
4. Open the DCIM folder and the folder inside to view the media files.
5. Select the media and copy the files from this folder into your computer. Optionally, select the files and choose ‘Copy’ from the Edit menu. Then select a folder and choose ‘Paste’ from the Edit menu.
6. We recommend that you copy the photos into the Pictures/My Pictures folder and the videos into the Videos/My Videos folder.
7. Do not disconnect the cable during transfer. Doing so will cancel the transfer of any files on their way to your computer.

MACINTOSH OS

1. Use the supplied USB cable to connect your camcorder to your computer's USB port.
2. Power on the camcorder. 'MSDC' displays on the LCD screen.
3. The camcorder's device icon appears on the desktop.
4. Click on the device icon and open the DCIM folder and the folder inside to view the media files.
5. Select the files and drag them into your computer. Optionally, select the files and choose 'Copy' from the Finder's Edit menu. Then select a folder and choose 'Paste' from the Edit menu.
6. We recommend that you copy the photos into the Pictures folder and the videos into the Movies folder.
7. Do not disconnect the cable during transfer. Doing so will cancel the transfer of any files on their way to your computer.

TRANSFERRING PHOTOS AND VIDEOS: APPLE IPAD

NOTE: Please check your device packaging for compatibility with the iPad.

APPLE IPAD CAMERA CONNECTION:

For models that are compatible with the iPad, photos and videos can be imported from your digital camcorder to your iPad by following either one of the options below:

1. Connecting your digital camcorder to your iPad using an iPad Camera Connector:

Plug the Camera Connector into the dock connector port on your iPad, then attach your digital camcorder using a USB cable (included) to the Camera Connector.

NOTE: iPad Camera Connector not included. This may be purchased separately.

2. Using an iPad SD Card Reader:

Connect the SD Card Reader to your iPad, then insert your digital camcorder's Micro SD Memory card into the slot to import photos and videos directly from your camera's SD card.

NOTE: iPad SD Card Reader not included. This may be purchased separately.

After you make the connection, your iPad automatically opens the Photos application. This allows you choose which photos and videos to import, then organizes them into albums.

Camcorder Maintenance

Please read the information below carefully before using your camcorder for proper and safe operation, so as to use the camcorder to its fullest and maintain its performance.

MEMORY CARD MAINTENANCE:

- For the first time of using a new memory card, or when there is unrecognized data for the camera or images with other cameras in the memory card, please make sure to firstly format the memory card.
Note: Please back up the data if the memory card inside has been previously used. After that, format the memory card of this video camera.
- Please power the camera off before inserting in or taking out the memory card.
- Keep the memory card clean and prevent it from contacting liquid. In case of liquid contacted, clean and dry it with a piece of soft cloth.
- In case of idle use, please keep the memory card in a guard staple.
- Please note that the memory card will get hot after long-term use. This is normal.
- It is recommended to backup the important data from your memory card to other media such as soft disk, hard disk or CD.
- To ensure image quality, minimum Class 4 High-Speed card is needed.
- The following situations may cause loss or damage of the data on your memory card:
 1. Improper use of the memory card.
 2. The memory card has been bent, dropped or collided.
 3. The memory card has been placed under high temperature or moist environment or expose to sunshine directly.
 4. Electrostatic or electromagnetic field exists around the memory card.
 5. The memory card has been taken out or the power supply interrupted while the camera or computer is connected to the memory card (i.e. during reading, writing and formatting).
 6. Taking out the memory card while powering off, while recording, deleting (formatting) or reading.
 7. The service life of the memory card has expired (please replace the memory card regularly).

DEVICE MAINTENANCE:

- Take good care of the video camera and prevent water or sand particles from entering the video camera when it is used on the beach or near water. Please note that water, sand particles, dust or component containing salt may damage the video camera.
- Keep the video camera free of dust and chemical materials. Place it in a cool, dry and well ventilated place. Do not place the video camera in a high temperature, moist or dusty place.
- If dirt or stains accumulate on the video camera or on its lens, use a soft, clean and dry rag to wipe it away gently. If the video camera or its lens is stained with sand particles, blow them away gently. Do not use cloth to wipe arbitrarily. Otherwise, it may scratch the surface of video camera or its lens.
- Do not touch the lens surface with fingers.
- If it is required to clean the camera surface, first blow away the sand dust accumulated on the surface, and then wipe the camera gently with a rag or tissue appropriate for optical equipment. Please use a cleaning agent specifically for a video camera when wiping if necessary. Do not use organic solvent to clean the video camera.
- The digital camcorder is a delicate device:
 1. Please handle your camcorder with care to avoid damaging it.
 2. Do not expose your camcorder to heat sources.
 3. Do not use you camcorder in wet or moist conditions without the waterproof casing.
 4. Use proper protective cover to avoid lens and display from being scratched.

Sakar Warranty Card

This warranty covers for the original consumer purchaser only and is not transferable. Products that fail to function properly **UNDER NORMAL USAGE**, due to defects in material or workmanship will be repaired at no charge for parts or labor for a period of one year from the time of purchase.

What Is Not Covered By Warranty:

Damages or malfunctions not resulting from defects in material or workmanship and damages or malfunctions from other than normal use, including but limited to, repair by unauthorized parties, tampering, modification or accident.

What to Do When Service Is Required:

When returning your defective product (postage pre-paid) for service, your package should include:

3. Copy of **original** bill of sale.
4. A detailed written description of the problem.
5. Your return address and telephone number (Daytime).

MAIL TO ADDRESS BELOW:

<u>Sakar US</u> Sakar International Attention: Service Department 195 Carter Drive Edison, NJ 08817	<u>Sakar UK/Europe</u> Attention: Service Department 2D, Siskin Parkway East 4020 Middlemarch Business Park Coventry, CV3 4PE	<u>Sakar Australia</u> Return faulty camera to the Refund Counter at the store where purchased
--	---	--

Technical Support

For technical support issues please visit our website at www.vivitar.com. You can find manuals, software and FAQ's at the website. Can't find what you are looking for? E-mail us at support@vivitar.com and one of our technical support team members will answer your questions. For phone support in the US please call 1-800-592-9541, in the UK call 0800 917 4831, in Australia call 1800-006-614. If you would like to call from anywhere else, please visit www.vivitar.com for your local toll free number.

Troubleshooting

Q: I have taken photos and selected the “Get Images” button. I get a message that the images were successfully transferred but the photos do not appear on my computer.

What do I do?

First ensure that you have in fact taken photos. Press the Shutter button to take some sample photos or videos and then try downloading them again.

If the photos are saved to the SD memory card then all the photos should appear.

Q: How do I make sure I don't lose important pictures?

This camcorder requires a Micro SD card for normal use. If the camera powers off nothing will happen to the images stored on the memory card. We recommend always downloading your photos and videos to your computer as soon as possible to prevent unintentional data loss.

Q: I deleted images using the Vivitar Experience Image Manager. The images were also deleted from my computer. How do I recover images that I accidentally deleted?

All images deleted using the Vivitar Experience Image Manager are sent to your computer's Recycle or Trash Bin and can be retrieved from there.