



Dear VIZIO Customer,

Congratulations on your new VIZIO VW32L HDTV40A High Definition LCD Television purchase. Thank you for your support. For maximum benefit of your set, please read these instructions before making any adjustments, and retain them for future reference. We hope you will experience many years of enjoyment from your new VIZIO VW32L HDTV40A.

For assistance, please call (949) 698 - 4946 or e-mail us at techsupport@vizio.com.

To purchase or inquire about accessories and installation services for your VIZIO LCD HDTV, please visit our website at www.VIZIO.com or call toll free at **888-VIZIOCE (888-849-4623)**.

We recommend you register your VIZIO VW32L HDTV40A either at our website www.VIZIO.com or fill in your registration card and mail it in. For peace of mind and to protect your investment beyond the standard warranty, VIZIO offers on-site extended warranty service plans. These plans give additional coverage during the standard warranty period. Visit our website or call us to purchase a plan.

Write down the serial number located on the back of your VIZIO VW32L HDTV40A. _____

Purchase Date _____

*VIZIO is a registered trademark of VIZIO, Inc. dba V, Inc.
HDMI logo and "High Definition Multimedia Interface" are
registered trademarks of HDMI Licensing LLC.*

Manufactured under license from Dolby Laboratories.

Dolby and the double-D symbol are trademarks of Dolby Laboratories.

THE TRADEMARKS SHOWN HEREIN ARE THE PROPERTY OF THEIR RESPECTIVE OWNERS; IMAGES USED ARE FOR ILLUSTRATION PURPOSES ONLY. BRAVO, VIZIO AND THE V LOGO AND WHERE VISION MEETS VALUE AND OTHER VIZIO TRADEMARKS ARE THE INTELLECTUAL PROPERTY OF VIZIO INC. PRODUCT SPECIFICATIONS ARE SUBJECT TO CHANGE WITHOUT NOTICE OR OBLIGATION. © 2008 VIZIO INC. ALL RIGHTS RESERVED.



Important Safety Instructions

This product is designed and manufactured to operate within defined design limits, and misuse may result in electric shock or fire. To prevent the product from being damaged, the following rules should be observed for the installation, use and maintenance of the product. Read the following safety instructions before operating the display. Keep these instructions in a safe place for future reference.

- To reduce the risk of electric shock or component damage, switch off the power before connecting other components to the VW32L HDTV40A.
- Unplug the power cord before cleaning the VW32L HDTV40A LCD. A damp cloth is sufficient for cleaning the VW32L HDTV40A. Do not use a liquid or a spray cleaner for cleaning the product. Do not use abrasive cleaners.
- Always use the accessories recommended by the manufacturer to insure compatibility.
- When moving the VW32L HDTV40A from an area of low temperature to an area of high temperature, condensation may form on the housing. Do not turn on the VW32L HDTV40A immediately after this to avoid causing fire, electric shock or component damage.
- Do not place the VW32L HDTV40A on an unstable cart, stand, or table. If the VW32L HDTV40A falls, it can injure a person and cause serious damage to the appliance. Use only a cart or stand recommended by the manufacturer or sold with the VW32L HDTV40A.
- A distance of at least 3 feet should be maintained between the VW32L HDTV40A and any heat source, i.e. radiator, heater, oven, amplifier etc. Do not install the product close to smoke. Operating the product close to smoke or moisture may cause fire or electric shock.
- Slots and openings in the back and bottom of the cabinet are provided for ventilation. To ensure reliable operation of the VW32L HDTV40A and to protect it from overheating, be sure these openings are not blocked or covered. Do not place the VW32L HDTV40A in a bookcase or cabinet unless proper ventilation is provided.
- Never push any object into the slot on the VW32L HDTV40A cabinet. Do not place any objects on the top of the product. It could short circuit parts causing a fire or electric shock. Never spill liquids on the VW32L HDTV40A.
- The VW32L HDTV40A should be operated only from the type of power source indicated on the label. If you are not sure of the type of power supplied to your home, consult your dealer or local power company.
- The power cable must be replaced when using different voltage from that specified in the User Manual. For more information, contact your dealer.
- The VW32L HDTV40A is equipped with a **three-pronged grounded plug, a plug with a third (grounding) pin**. This plug will fit only into a grounded power outlet as a safety feature. If your outlet does not accommodate the three-wire plug, have an electrician install the correct outlet, or use an adapter to ground the appliance safely. **Do not defeat the safety purpose of the grounded plug.**
- When connected to a power outlet, power is always into your HDTV. To totally disconnect the power, unplug the power cord.
- Use only with the cart, stand, tripod, bracket or table specified by manufacturer, or sold with the apparatus. When a cart is used, use caution when moving the cart/apparatus combination to avoid injury from tip-over.



- The lightning flash with arrowhead symbol, within an equilateral triangle, is intended to alert the user to the presence of not isolated dangerous voltage within the inside of the product that may be sufficient magnitude to constitute a risk of electric shock to persons.
- The exclamation point within an equilateral triangle is intended to alert the user to the presence of important operating and servicing instructions in the literature accompanying the appliance.

- Do not overload power strips and extension cords. Overloading can result in fire or electric shock.
- The wall socket shall be installed near the equipment and shall be easily accessible.
- Only the marked power source can be used for the product. Any power source other than the specified one may cause fire or electric shock.
- Do not touch the power cord during lightning. To avoid electric shock, avoid handling the power cord during electrical storms.
- Unplug the unit during a lightning storm or when it will not be used for long period of time. This will protect the VW32L HDTV40A from damage due to power surges.
- Do not attempt to repair or service the product yourself. Opening or removing the back cover may expose you to high voltages, the risk of electric shock, and other hazards. If repair is required, please contact your dealer and refer all servicing to qualified service personnel.
- Keep the product away from moisture. Do not expose this appliance to rain or moisture. If water penetrates into the product, unplug the power cord and contact your dealer. Continuous use in this case may result in fire or electric shock.
- Do not use the product if any abnormality occurs. If any smoke or odor becomes apparent, unplug the power cord and contact your dealer immediately. Do not try to repair the product yourself.
- Avoid using dropped or damaged appliances. If the product is dropped and the housing is damaged, the internal components may function abnormally. Unplug the power cord immediately and contact your dealer for repair. Continued use of the product may cause fire or electric shock.
- Do not install the product in an area with heavy dust or high humidity. Operating the product in environments with heavy dust or high humidity may cause fire or electric shock.
- Follow instructions for moving the product. Ensure that the power connector and any other cables are unplugged before moving the product.



- Hold the power connector when removing the power cable. Pulling the power cable itself may damage the wires inside the cable and cause fire or electric shock. When the product will not be used for an extended period of time, unplug the power connector.
- To reduce risk of electric shock, do not touch the connector with wet hands.
- Insert batteries in accordance with instructions. Incorrect polarities may cause damage and leakage of the batteries, operator injury and contamination the remote controller.
- If any of the following occurs please contact the dealer:
 - The power connector fails or frays.
 - Liquid sprays or any object drops into the VW32L HDTV40A.
 - The Display is exposed to rain or other moisture.
 - The Display is dropped or damaged in any way.
 - The performance of the Display changes substantially.
- Operating environment. Temperature: 40°F ~ 95°F, Humidity: 20% ~ 80% non-condensing, Altitude: 0 ~ 6500ft (0 ~ 2000m)

Television Antenna Connection Protection

External Television Antenna Grounding

If an outside antenna/satellite dish or cable system is to be connected to the TV, make sure that the antenna or cable system is electrically grounded to provide some protection against voltage surges and static charges.

Article 810 of the National Electrical Code, ANSI/NFPA 70, provides information with regard to proper grounding of the mast and supporting structure, grounding of the lead-in wire to an antenna discharge unit, size of the grounding conductors, location of antenna discharge unit, connection to grounding electrodes, and requirements of the grounding electrode.

Lightning Protection

For added protection of the High Definition TV during a lightning storm or when it is left unattended or unused for long periods of time, unplug the TV from the wall outlet and disconnect the antenna or cable system.

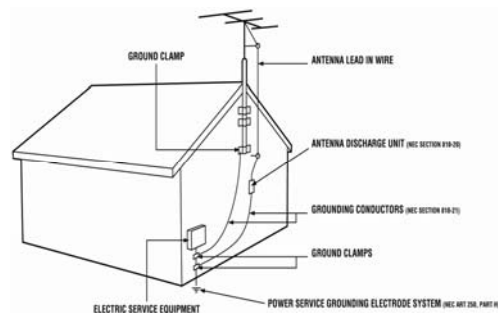

Power Lines

Do not locate the antenna near overhead light or power circuits, or where it could fall into such power lines or circuits.

Remember, the screen of the coaxial cable is intended to be connected to earth in the building installation.

FCC Bulletin for New TV Owners

After February 17, 2009, a television receiver with only an analog broadcast tuner will require a converter box to receive full power over-the-air broadcasts with an antenna because of the Nation's transition to digital broadcasting. Analog-only TVs should continue to work as before to receive low power, Class A or translator television stations and with cable and satellite TV services, gaming consoles, VCRs, DVD players, and similar products.

Information about the DTV transition is available from <http://www.DTV.gov> or this manufacturer at 877 MY VIZIO (877-698-4946), and from <http://www.dtv2009.gov> or 1-888-DTV-2009 for information about subsidized coupons for digital-to-analog converter boxes.

Your VIZIO TV comes with a built-in tuner capable of processing digital broadcasts, making it easier for you, the end user, to receive this type of signal without the need of an extra converter box.



Opening the Package

Your VIZIO VW32L HDTV40A and its accompanying accessories are carefully packed in a cardboard carton that has been designed to protect it from transportation damage. Now you have opened the carton check that the VW32L HDTV40A is in good condition and that all of the accessories are included.

The VW32L HDTV40A weighs approximately 31lbs and is over 31" wide and we advise that you take sensible lifting precautions when you unpack and install the HDTV.

The screen can easily be scratched or broken so please handle the product gently and never place the HDTV with the glass facing downwards on a surface without protective padding.

IMPORTANT: Save the carton and packing material for future shipping.

Package Contents

VIZIO VW32L HDTV40A

Removable VIZIO Stand Base and Instructions

VIZIO Remote Control VR2

2 (Double A) Batteries for the Remote Control

Power Cord

Quick Setup Guide

Registration Card

VIP Services Brochure



IMPOTANT: Do not apply pressure or throw any object into the screen display area which may compromise the integrity of the display. The manufacturer's warranty does not cover user abuse or improper installations.



Additional Certified Accessories for the VIZIO VW32L HDTV40A are sold separately

Wall Mounts
High Definition Cables
Extra or replacement Remote

VIZIO also offers Installation Services and Extended Warranty Services for your VIZIO VW32L HDTV40A

To purchase or inquire about additional accessories and services for your VIZIO product, visit our web site at www.VIZIO.com or call us toll free at 888-VIZIOCE (888-849-4623)

Installation Preparation

Please read this user manual carefully before installing your VIZIO HDTV.

The power consumption of the High Definition TV is about 104W (Avg), please use the power cord designated for TV. When an extension cord is required, use one with the correct power rating. The cord must be grounded and the grounding feature must not be defeated.

The TV should be installed on a flat surface to avoid tipping. For proper ventilation, you must allow space between the back of the High Definition TV and the wall. If you would like to mount your TV on the wall, please see below 'Preparing Your LCD HDTV for Wall Mounting' for additional information. Avoid installing the TV in places with high humidity, dust or smoke so as not to shorten the service life of the electronic components.

Install the TV in landscape orientation; any 90° clockwise or counter-clockwise installation may induce poor ventilation and excessive component damage.

VIZIO offers professional installation services. Please contact VIZIO for more information on these services at 888-VIZIOCE (888-849-4623) or www.VIZIO.com.



Preparing Your LCD HDTV for Wall Mounting

The VIZIO VW32L HDTV40A can either be kept on the stand base or mounted on the wall for viewing. If you choose to mount the VW32L HDTV40A on the wall, please follow the instructions below for removing the stand base.

To remove the stand base

1. Unplug all of the cables and cords from your VIZIO VW32L HDTV40A.
2. Place the VW32L HDTV40A face down on a soft and flat surface (blanket, foam, cloth, etc) to prevent any damage to the TV.
3. Remove the eight (8) screws holding the base to the VW32L HDTV40A.
4. Carefully remove the stand base.



Now, the VW32L HDTV40A can fit securely to a mount (sold separately) by utilizing the mounting holes in the center of the back panel of the High Definition TV. Please make sure to read the instructions of your specific mount to properly hang the VW32L HDTV40A. The pitch of the mounting holes is 420mm horizontally and 200mm vertically. The screw type required is metric M8, 1.25mm pitch. The length of the screws will depend on the thickness plate being attach to the TV set, our brackets come with different length screws.

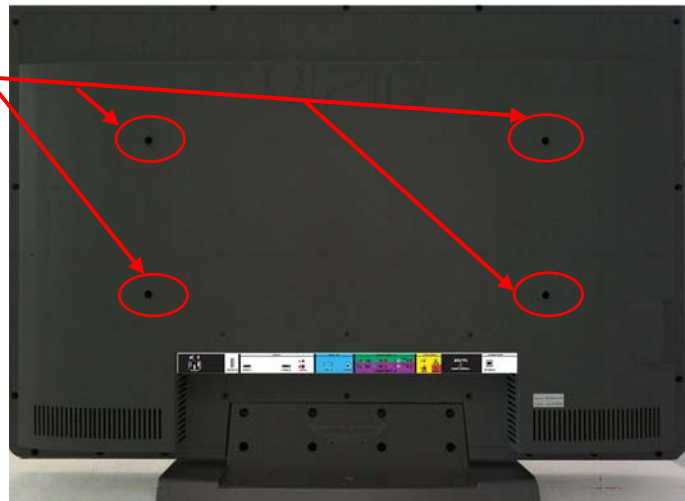

To find the perfect mount for the VIZIO VW32L HDTV40A, browse VIZIO's certified mount selection at www.VIZIO.com or call directly 888-VIZIOCE (888-849-4623).



Table of Contents

Chapter 1 Basic Controls and Connections	9
1.1 Front Panel.....	9
1.2 Right Side Panel Controls	9
1.3 Rear Panel Connections	10
1.4 VIZIO Remote Control.....	11
1.4.1 Insertion of Batteries in the Remote Control	12
1.4.2 Remote Control Range	12
1.4.3 VIZIO Remote Control Precautions	12
Chapter 2 Connecting Equipment	13
2.1 Which Video Connection Should I Use?.....	13
2.2 Connecting Coaxial (RF)	14
2.2.1 Using Your Antenna or Digital Cable for DTV /TV	14
2.2.2 Using the Antenna or Cable through your VCR	14
2.3 Connecting Your HDTV Set-Top Box	15
2.3.1 Using HDMI	15
2.3.2 Using Component Video.....	17
2.4 Connecting Your Basic Set-Top Box.....	18
2.4.1 Using Composite Video	18
2.4.2 Using Coax (RF).....	18
2.5 Connecting Your DVD Player.....	19
2.5.1 Using HDMI	19
2.5.2 For DVD Players with DVI:	20
2.5.3 Using Component Video.....	21
2.5.4 Using S-Video (AV).....	22
2.5.5 Using Composite (AV) Video	22
2.6 Connecting Your VCR or Video Camera	23
2.7 Connecting an external Receiver/Amp	24
2.7.1 Optical Output of Audio received with HD Programs	24
2.8 Connecting a PC Computer	25
2.8.1 Preset PC Resolutions.....	26
2.9 Setting Up to Watch Television	27
2.10 Basic LCD HDTV Start Up	27
2.11 Watching a TV Program	33
2.12 Adjusting Basic HDTV Settings	34
2.13 Program Information.....	34
Chapter 3 Advanced Adjustment of HDTV.....	35
3.1 Using the On Screen Display (OSD)	35
3.2 DTV / TV Input Picture Adjustment.....	36
3.2.1 Picture Mode	36
3.2.2 Backlight.....	37
3.2.3 Brightness.....	37
3.2.4 Contrast.....	38
3.2.5 Color	38
3.2.6 Tint.....	38
3.2.7 Sharpness	39
3.2.8 Color Temperature.....	39
3.2.9 Advanced Video	40
3.3 DTV / TV Input Audio Adjustment.....	42
3.3.1 Volume	42
3.3.2 Bass.....	42
3.3.3 Treble	43
3.3.4 Balance.....	43
3.3.5 Surround.....	43
3.3.6 Digital Audio Out.....	44
3.3.7 Speakers	44
3.3.8 Lip Sync.....	44
3.4 DTV / TV Tuner Setup.....	45
3.4.1 Tuner Mode	45



3.4.2 Auto Search	45
3.4.3 Skip Channel	45
3.4.4 MTS	46
3.4.5 Time Zone	46
3.4.6 Daylight Saving	46
3.5 DTV / TV Input Setup	47
3.5.1 Language	47
3.5.2 Sleep Timer	47
3.5.3 Wide	47
3.5.4 Input Naming	48
3.5.5 Closed Caption (CC)	49
3.5.6 Digital Closed Caption Style (Digital CC Style)	49
3.5.7 System Reset	50
DTV / TV Input Parental Control	51
3.5.8 Channel Block	51
3.5.9 US TV Rating	52
3.5.10 US Movie Rating (For US)	53
3.5.11 Canadian English Rating	53
3.5.12 Canadian French Rating	54
3.5.13 DTV Rating	54
3.5.14 Blocked Unrated Programming	55
3.5.15 Change the Password	55
3.6 HDMI Input Picture Adjustment	56
3.7 HDMI Input Audio Adjustment	56
3.8 HDMI Input Setup	56
3.9 Video Input Picture Adjustment	57
3.10 Video Input Audio Adjustment	57
3.11 Video Input Setup	58
3.12 Video Input Parental Control	58
3.13 PC Input Picture Adjustment	59
3.13.1 Auto Adjust	59
3.13.2 Backlight	59
3.13.3 Brightness	60
3.13.4 Contrast	60
3.13.5 Color Temperature	61
3.13.6 H-SIZE	61
3.13.7 H-Position	61
3.13.8 V. Position	62
3.13.9 Fine Tune	62
3.14 PC Input Audio Adjustment	62
3.15 PC Input Setup	62
3.16 Understanding Viewing Features	63
3.16.1 Viewing Modes	63
3.17 Using a Cable or Satellite Remote	64
Chapter 4 Maintenance and Troubleshooting	64
4.1 Maintenance	64
4.2 TV and Stand Base Assembly	65
4.3 Troubleshooting Guide	66
4.4 Telephone & Technical Support	67
4.5 Compliance	68
4.6 FCC Class B Radio Interference Statement	68
Chapter 5 Miscellaneous Information	69
5.1 Specifications	69
5.2 Glossary – Standard Definitions	70
5.3 Index	71



Chapter 1 Basic Controls and Connections

1.1 Front Panel

Power 'VIZIO' light – The VIZIO name lights white when powered on and orange when powered off.

Remote Control Sensor – This is the window through which all of the remote control signals pass to the sensor. Point the remote control directly at this window for the best response to the remote signal.

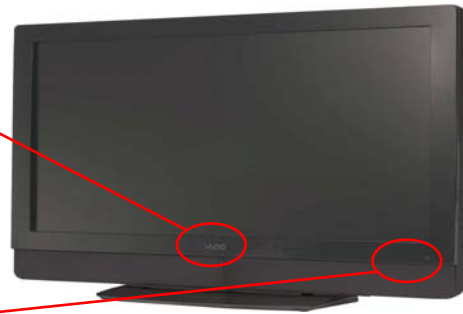

1.2 Right Side Panel Controls

Power (⏻) – Switch the VW32L HDTV40A on by pressing the button once. Press the button again to the VW32L HDTV40A off.

Menu – This button activates the On Screen Display (OSD). Pressing it a second time will select the first option or feature of the OSD. If an option or feature which requires the display of the slide bar is selected, pressing this button will toggle between displaying the slide bar and the last OSD menu.

Channel +/- – Use these buttons to step up or down the TV channels. While the OSD is active, these buttons function as up and down controls in the OSD menus.

Volume +/- – Use these buttons to increase or decrease to the speaker volume. While the OSD is active, these buttons function as left and right controls in the OSD menus.

Input – Repeated pressing of this buttons steps through the input sources in the following sequence: TV, AV (S-VIDEO), COMP1, COMP2, RGB, HDMI1 and HDMI2. Once you have stepped through the entire sequence, you will return to the beginning. When the OSD is on, if a sub-menu is active, pressing this button will return to the previous menu level.

Input
TV
AV
COMPONENT1
COMPONENT2
RGB
HDMI1
HDMI2

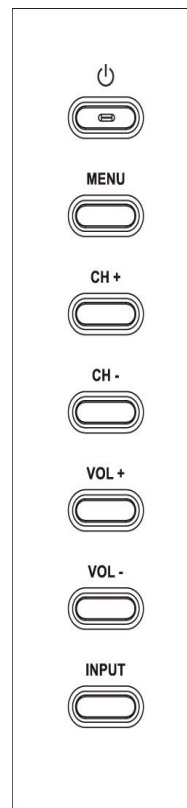

1.3 Rear Panel Connections

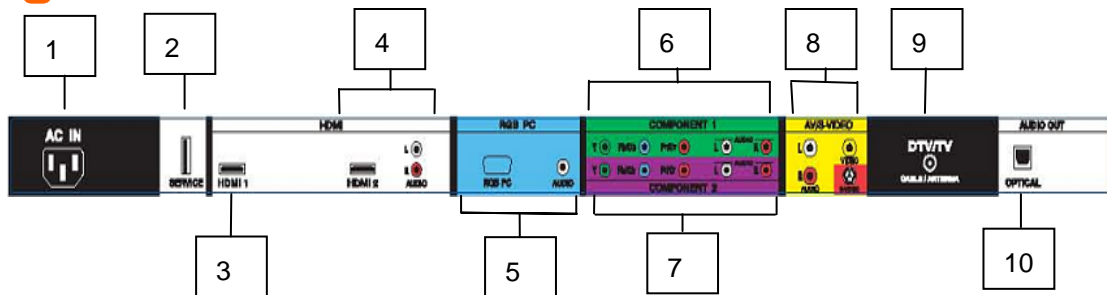

1. **AC IN** – Plug-in the supplied AC Power Cord here.
2. **SERVICE** – This custom communication port is for factory service only. **Use of this input for any purpose other than factory authorized service will void the manufacturer's warranty of this equipment.**
3. **HDMI 1** – Connect the primary source for digital video such as a DVD multimedia player or set top box through this all digital connector. The white color band on the rear of the High Definition TV indicates this connection.
4. **HDMI 2** – Connect the secondary source for digital video such as a DVD multimedia player or set top box through this all digital connector. The white color band on the rear of the High Definition TV indicates this connection. For users who want to connect to a DVI enabled device, use a DVI-HDMI cable and connect the Analog Audio output of the device to the L+R AUDIO here. Your VIZIO Certified HDMI and HDMI-DVI cables are available for purchase from www.VIZIO.com or by calling 888-VIZIOCE (888-849-4623).
5. **RGB PC** – Connect the video and audio from a computer here. The blue color band on the rear of the High Definition TV indicates this connection. A 1/8" plug stereo cable is needed to connect the audio out from the computer to the 1/8" jack connector in the rear of the High Definition TV.
6. **COMPONENT 1 (YPb/CbPr/Cr with Audio L/R)** – Connect the primary source for component video devices such as a DVD Player or set top box here. From left to right, use green for Y, blue for Pb (or Cb), red for Pr (or Cr), white for left audio and red for right audio inputs. The green color band on the rear of the High Definition TV indicates this connection.
7. **COMPONENT 2 (YPb/CbPr/Cr with Audio L/R)** – Connect the secondary source for component video devices such as a DVD Player or set top box here. From left to right, use green for Y, blue for Pb (or Cb), red for Pr (or Cr), white for left audio and red for right audio inputs. The purple color band on the rear of the High Definition TV indicates this connection.
8. **AV/S-VIDEO** – Connect the source for composite video devices, such as a VCR or video game. Use the white and red connectors to connect the external audio from the same source. This connection is on rear side of the High Definition TV. The signal being carried by the S-Video cable and connector; if connected, will take priority over the video (yellow connector) RCA connector. Keep in mind that if audio is needed then left (white connector) and right (red connector) must be connected to the signal source using the RCA audio patch cables.
9. **DTV/TV** – Connect to an antenna or digital cable (no Cable Box) for Digital TV.*
10. **OPTICAL DIGITAL AUDIO OUT** – When a digital audio signal is associated with an input which is selected for viewing, the digital audio associated with digital programming will be available on this SPDIF Optical connector for connection to your home theatre system. The white color band on the rear of the TV indicates this connection.

* For digital TV stations in your area visit www.antennaweb.org.



1.4 VIZIO Remote Control

GUIDE – This button displays program information. Press this button once and the information of the program being viewed is shown.

POWER – Press this button to turn the TV on from the Standby mode. Press it again to return to the Standby mode.

TV – Press this button to select TV.

AV – Press this button to select the Audio Video input. Pressing this button repeatedly will get you to the AV input. Keep in mind that if S-Video cable is being used, then AV will show the signal going through this input as the S-video takes priority.

COMPONENT – Press this button to select the Component (YPbPr) input. Pressing this button repeatedly will take you through the Component (Component 1 and component 2) inputs.

HDMI – Press this button to select the HDMI input. Pressing this button repeatedly will get you through the HDMI (HDMI1, and HDMI 2) different inputs

MENU – Use this button for the On-Screen Display (OSD) menus. When use within the OSD menus, pressing this key will make the selection of an option.

 - These buttons navigate the On-Screen Display (OSD).

MUTE – This button turns the sound on and off.

LAST – This button recalls the previously viewed channel when it is used in TV mode; meaning that the TV unit has control over the signal or program being watched. This button also has different functions when being used in conjunction with the On-Screen Display (OSD) menu.

VOL (+ or -) – These buttons turn the volume up or down.

CH (+ or -) – These buttons change the channels up or down.

Number Button Pad – Use these buttons to select a channel or enter a password.

INPUT – This button allows the user to cycle through the inputs. Repeatedly pressing of this button will step you through the input sources in the following sequence: TV, AV (S-Video), COMP1, COMP2, RGB, HDMI1 and HDMI2. Once you have stepped through the entire sequence, you will return to the beginning.

- **(DASH)** – When selecting a digital channel directly, use this button for the separation of main and sub-channels. For example, channel 28-2 would be selected by the button sequence 2 8 --2.

Input
TV
AV
COMPONENT1
COMPONENT2
RGB
HDMI1
HDMI2



1.4.1 Insertion of Batteries in the Remote Control

Press and slide out the battery cover by following the direction shown by the molded arrow on the surface of the cover.

Insert two AA batteries into the remote control. Make sure that you match the (+) and (-) symbols on the batteries with the (+) and (-) symbols inside the battery compartment.

Press and slide the battery cover back into place.

Precautionary Tips for Inserting the Batteries:

Only use the specified AA batteries.

Do not mix new and old batteries. This may result in cracking or leakage that may pose a fire risk or lead to personal injury.

Inserting the batteries incorrectly may also result in cracking or leakage that may pose a fire risk or lead to personal injury.

Dispose of the batteries in accordance with local laws and regulations.

Keep the batteries away from children and pets.



1.4.2 Remote Control Range

Point the remote control at the remote control sensor to transmit the commands.

Do not place any obstacles between the remote control and the receiver window.

The effective range of the remote control is approximately 30 feet (10 meters) from the front of the receiver window, 30° to the left and right, 20° up and down.

1.4.3 VIZIO Remote Control Precautions

The remote control should be kept dry and away from heat sources. Avoid humidity.

If the TV responds erratically to the remote control or does not respond at all, check the batteries. If the batteries are low or exhausted, replace them with fresh batteries.

When not using the remote control for a long period of time, remove the batteries.

Do not take the batteries apart, heat them, or throw them into a fire.

Do not subject the remote control to undue physical stress, such as striking or dropping it.







Do not attempt to clean the remote control with a volatile solvent. Wipe it with a clean, damp cloth.



Chapter 2 Connecting Equipment

2.1 Which Video Connection Should I Use?

The VIZIO VW32L HDTV40A has six different ways to connect your video equipment from a basic connection to the most advanced for digital displays.

Connection Quality (type)	Connector	Rear Panel Color Codes	Description
Best (digital)		White	HDMI (High-Definition Multimedia Interface) - It is the first and only industry-supported, uncompressed, all-digital audio/video interface. HDMI provides an interface between any audio/video source, such as a set-top box, DVD player, or A/V receiver and an audio and/or video monitor, such as a digital television (DTV), over a single cable.
Best (digital) ----- Good (analog)		Black	DTV Coaxial RF. When used for MPEG2 encoded bit streams from ATSC broadcast programming, this input takes advantage of the High Definition content. ----- TV Coaxial RF. This is the connection for standard NTSC TV using antenna or cable.
Best (analog)		Blue	RGB PC (VGA) – This video input has separate red, green and blue color components. The signal carries horizontal and vertical sync information on the green signal. This is most commonly used for PC input.
Better (analog)		Green and Purple	Component - The video signal is separated into three signals, one containing the black-and-white information and the other two containing the color information. This enhancement over S-Video takes advantage of the superior picture provided by progressive scan DVD players and HDTV formats.
Good (analog)	 	Yellow and Red	Composite (AV) - The complete video signal is carried through this single (yellow) pin connector. This is the most commonly used video connection. S-Video (AV) - The video signal is separated into two signals, one containing the black-and-white information and the other containing the color information. Separating the color in this way avoids 'cross color' effects where closely spaced black and white lines are erroneously displayed in color. It also enables text to be displayed more sharply.

Note: For more info refer to the Quick Start Guide



2.2 Connecting Coaxial (RF)

2.2.1 Using Your Antenna or Digital Cable for DTV /TV



1. Turn off the power to the HDTV.
2. Connect the coaxial (RF) connector from your antenna or digital cable (out-of-the-wall, not from the Cable Box) to the DTV/TV CABLE/ANTENNA connector.
3. Turn on the power to the HDTV.
4. Select DTV using the INPUT button on the remote or side of the High Definition TV, or directly by pressing the TV button on the Remote Control.

Note:

- a) Not all digital TV broadcasts are High Definition (HD). Refer to the program guides, or consult your cable, satellite or TV station operator.
- b) Digital broadcasts are not available in all areas. Refer to www.antennaweb.org for detailed information.
- c) Make sure the antenna and coaxial cable are correctly grounded.
- d) For Professional installation contact us at www.VIZIO.com or call 1-888-VIZIOCE (1-888-849-4623).

2.2.2 Using the Antenna or Cable through your VCR

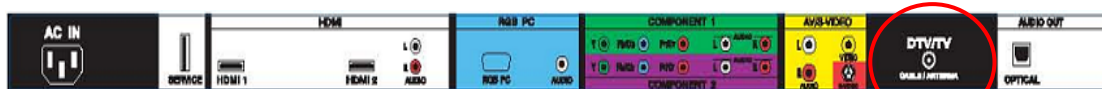

1. Turn off the power to the HDTV and VCR.
2. Connect the “Output to TV”, “RF Out” or “Antenna Out” connector on the rear of your VCR to the DTV/TV CABLE/ANTENNA connector at the rear of the High Definition TV.
3. Turn on the power to the HDTV and VCR.
4. Select TV using the INPUT button on the remote or side of the High Definition TV, or directly by pressing the TV button on the Remote Control.

Note: If you have an off-air antenna or cable TV, connect it to the “Antenna In” connector on the rear of your VCR.



2.3 Connecting Your HDTV Set-Top Box

2.3.1 Using HDMI

HDTV Set-Top Boxes that have a HDMI digital interface should be connected to the HDMI input of the LCD HDTV for optimal results.

Note: To maintain the display quality, use a VIZIO certified HDMI. Length is available up to 10 meters. See www.VIZIO.com or call 1-888-VIZIOCE (1-888-849-4623) for details.

Connecting your HDTV Set-Top Box (Best):

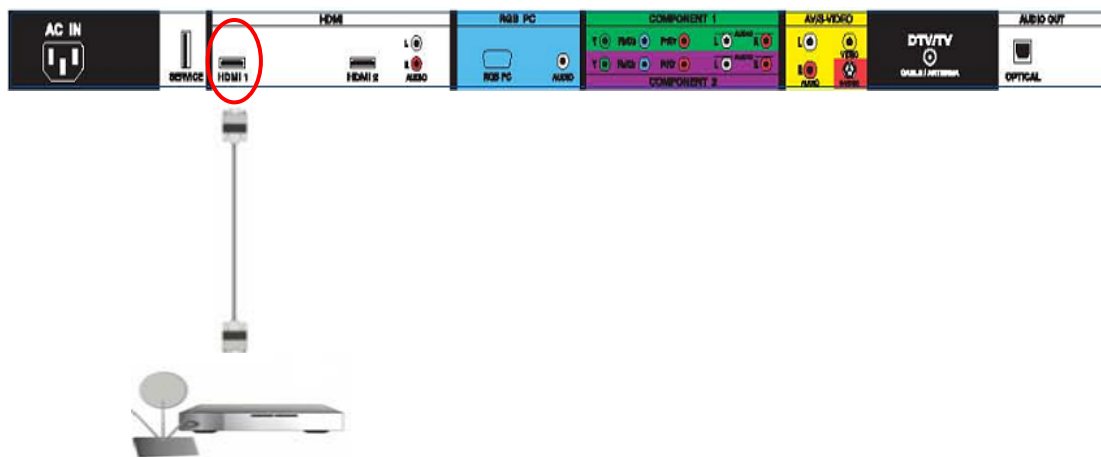

1. Turn off the power to the HDTV and HDTV Set-Top Box.
2. Connect a HDMI cable to the HDMI output of your HDTV Set-Top Box and the other end to the HDMI Input (white color area) at the rear of the High Definition TV.
3. Turn on the power to the HDTV and HDTV Set-Top Box.
4. Select HDMI 1 using the INPUT button on the remote or side of the High Definition TV, or directly by pressing the HDMI button on the Remote Control.
5. If HDMI 1 is being used, used HDMI 2 as the input and follow steps 1 through 3; and then select HDMI 2 in step 4.

Note:

- a) The HDMI input on the HDTV supports High-bandwidth Digital Content Protection (HDCP). HDCP encrypts the transmission between the video source and the digital display for added security and protection.
- b) Refer to your HDTV Set-Top Box user manual for more information about the video output requirements of the product or consult your cable or satellite operator.



For HDTV Set-Top Boxes with DVI:

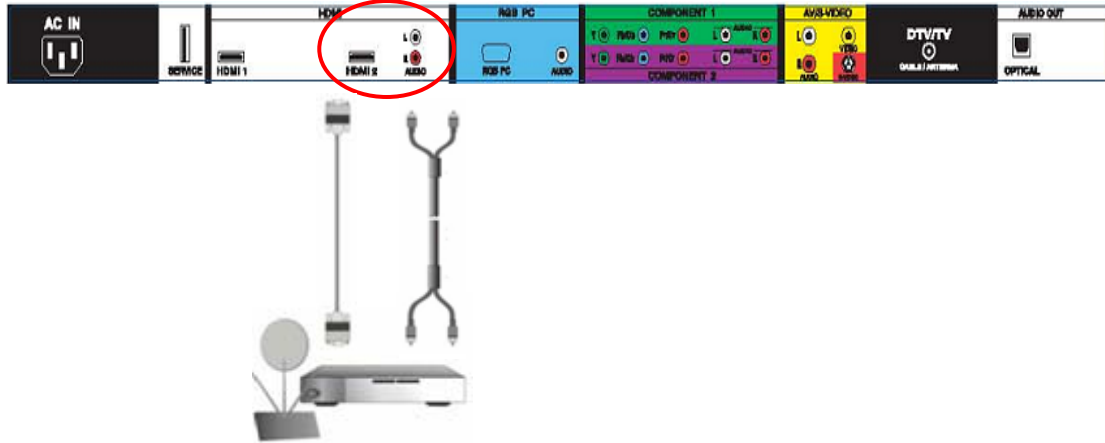

1. Turn off the power to the HDTV and HDTV Set-Top Box.
2. Using a HDMI-DVI cable, connect the DVI end to your HDTV Set-Top Box and the HDMI end to the HDMI Input (white color area) at the rear of the High Definition TV.
3. Using an audio cable (white and red connectors), connect the cable to the audio output connectors associated with the DVI output on your HDTV Set-Top Box and connect the other end to the audio connectors associated with the HDMI input (white area) at the rear of the High Definition TV.
4. Turn on the power to the HDTV and HDTV Set-Top Box.
5. Select HDMI using the INPUT button on the remote or side of the High Definition TV, or directly by pressing the HDMI button on the Remote Control.

Note: The HDMI Input is for HD Video and using HDMI-DVI will only support 640x480 at 60Hz from a PC. Use the RGB PC input for a greater selection of PC formats.

Note:

- a) The HDMI input on the HDTV supports High-bandwidth Digital Content Protection (HDCP). HDCP encrypts the transmission between the video source and the digital display for added security and protection.
- b) Refer to your HDTV Set-Top Box user manual for more information about the video output requirements of the product or consult your cable or satellite operator.



2.3.2 Using Component Video

Connecting your HDTV Set-Top Box (Better):

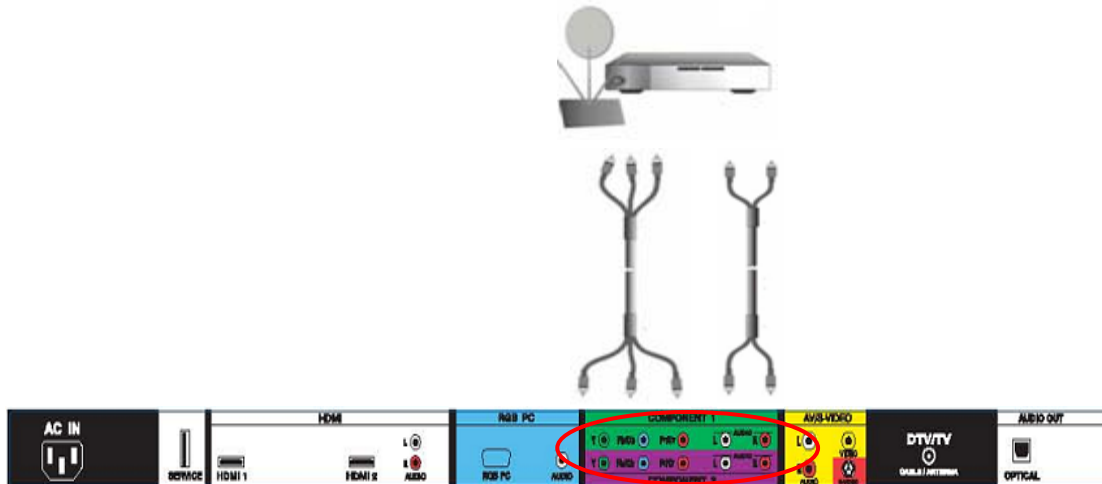

1. Turn off the power to the HDTV and HDTV Set-Top Box.
2. Connect the Y (green color) connector on your HDTV Set-Top Box to the corresponding Y (green color) connector in the Component 1 group (green color area - row of connectors nearest to you when viewing from the rear of the High Definition TV) at the rear of the High Definition TV.
3. Connect the Pb (blue color) connector on your HDTV Set-Top Box to the corresponding Pb (blue color) connector in the Component 1 group (green color area - row of connectors nearest to you when viewing from the rear of the High Definition TV) at the rear of the High Definition TV.
4. Connect the Pr (red color) connector on your HDTV Set-Top Box to the corresponding Pr (red color) connector in the Component 1 group (green color area - row of connectors nearest to you when viewing from the rear of the High Definition TV) at the rear of the High Definition TV.
5. Using an audio cable (white and red connectors), connect the cable to the audio output connectors associated with the Component output on your HDTV Set-Top Box and connect the other end to the audio connectors associated with the Component 1 input (green color area) at the rear of the High Definition TV.
6. Turn on the power to the HDTV and HDTV Set-Top Box.
7. Select Component 1 using the INPUT button on the remote or side of the High Definition TV, or directly by pressing the Component button on the Remote Control.
8. If Component 1 input is being used, use Component 2 as the input and follow the steps 1 through 6; and then select Component 2 in step 7.

Note:

Refer to your HDTV Set-Top Box user manual for more information about the video output requirements of the product or consult your cable or satellite operator.



2.4 Connecting Your Basic Set-Top Box

2.4.1 Using Composite Video

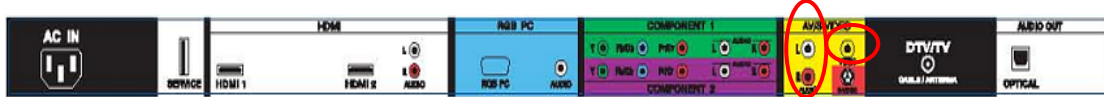

1. Turn off the power to the HDTV and Set-Top Box.
2. Using the AV Cable, connect the Video (yellow color) connector on your Set-Top Box to the corresponding Video (yellow color) connector in the AV group (yellow color area) at the rear of the High Definition TV.
3. Using the white and red connectors, connect the cable to the audio output connectors associated with the Video output on your Set-Top Box and connect the other end to the audio connectors associated with the AV input (yellow color area) at the rear of the High Definition TV.
4. Turn on the power to the TV and Set-Top Box.
5. Select AV using the INPUT button on the remote or side of the High Definition TV, or directly by pressing the AV button on the Remote Control.



2.4.2 Using Coax (RF)



1. Turn off the power to the HDTV and Set-Top Box.
2. Using a Coax (RF) cable, connect one end to the TV OUT (RF) on your Set Top Box and the other end to the DTV/TV input at the rear of the High Definition TV.
3. Turn on the power to the HDTV and Set-Top Box.
4. Select TV using the INPUT button on the remote or side of the High Definition TV, or directly by pressing the TV button (below the GUIDE button) on the Remote Control.



Note: Refer to your Set Top Box user manual for more information about selecting the video or RF output of the product.



2.5 Connecting Your DVD Player

You have several options for connecting your DVD player to your VIZIO VW32L HDTV40A; HDMI, Component, AV (S-Video or Composite) inputs. Based on your configuration, you can decide which option is right for you.

2.5.1 Using HDMI

DVD players that have a digital interface such as HDMI (High Definition Multimedia Interface) should be connected to the HDMI input of the VIZIO VW32L HDTV40A for optimal results.

Note: To maintain the display quality, use a VIZIO certified HDMI. Length is available up to 10 meters. See www.VIZIO.com or call 1-888-VIZIOCE (1-888-849-4623) for details.

Connecting your DVD Player (Best):

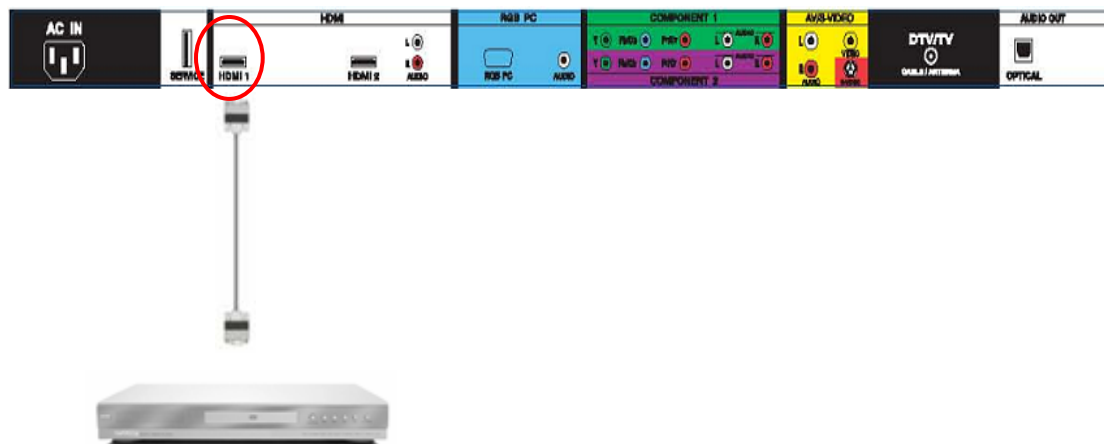

1. Turn off the power to the High Definition TV and DVD player.
2. Connect a HDMI cable to the HDMI output of your DVD player and the other end to the HDMI Input (white color area) at the rear of the High Definition TV.
3. Turn on the power to the High Definition TV and DVD player.
4. Select HDMI 1 using the INPUT button on the remote or side of the High Definition TV, or directly by pressing the HDMI button on the Remote Control.
5. If HDMI 1 is being used, connect to HDMI 2 as the input and follow steps 1 through 3; and then select HDMI 2 in step 4.



2.5.2 For DVD Players with DVI:

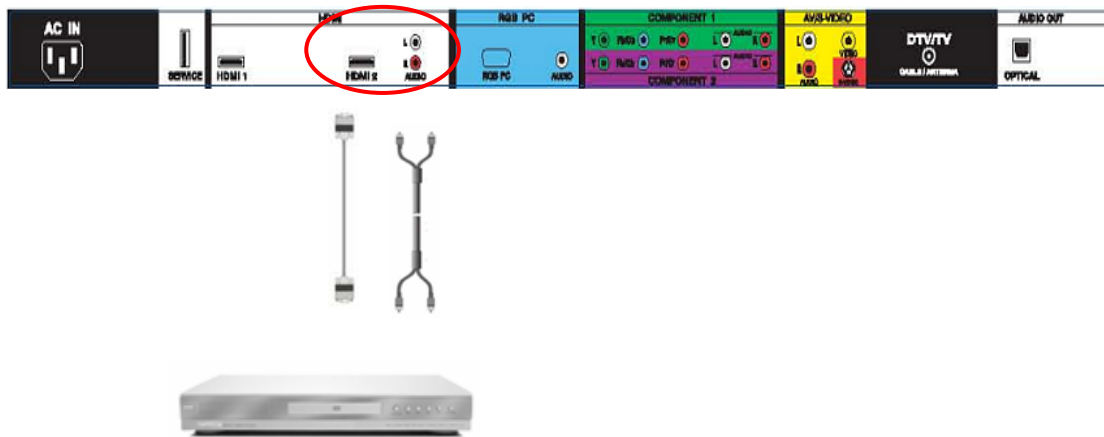

1. Turn off the power to the High Definition TV and DVD player.
2. Using a HDMI-DVI cable, connect the DVI end to your DVD player and the HDMI end to the HDMI Input (white color area) at the rear of the High Definition TV.
3. Connect an audio cable (white and red connectors) to the audio output connectors associated with the DVI output of the DVD player and connect the other end to the audio connectors by the HDMI input (white area) at the rear of the High Definition HDTV.
4. Turn on the power to the High Definition TV and your DVD player.
5. Select HDMI 2 using the INPUT button on the remote or side of the High Definition TV, or directly by pressing the HDMI button on the Remote.

Note: Refer to your DVD player user manual for more information about the video output requirements of the product.



2.5.3 Using Component Video

Connecting your DVD Player (Better):

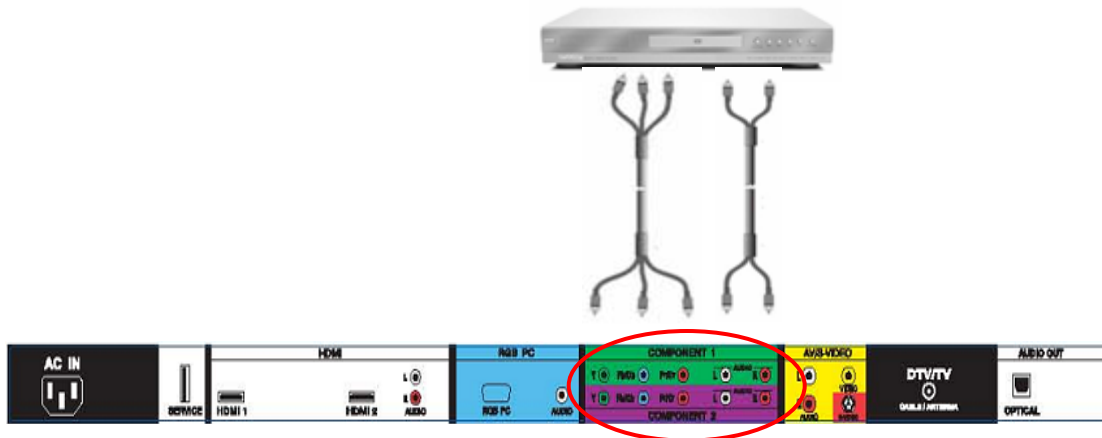

1. Turn off the power to the High Definition TV and DVD player.
2. Connect the Y (green color) connector on your DVD player to the corresponding Y (green color) connector in the Component 1 group (green color area - row of connectors nearest to you when viewing from the rear of the High Definition TV) at the rear of the High Definition TV.
3. Connect the Pb (blue color) connector on your DVD player to the corresponding Pb (blue color) connector in the Component 1 group (green color area - row of connectors nearest to you when viewing from the rear of the High Definition TV) at the rear of the High Definition TV.
4. Connect the Pr (red color) connector on your DVD player to the corresponding Pr (red color) connector in the Component 1 group (green color area - row of connectors nearest to you when viewing from the rear of the High Definition TV) at the rear of the High Definition TV.
5. Using an audio cable (white and red connectors), connect the cable to the audio output connectors associated with the Component output on your DVD player and connect the other end to the audio connectors associated with the Component 1 input (green color area) at the rear High Definition TV.
6. Turn on the power to the High Definition TV and DVD player.
7. Select Component 1 using the INPUT button on the remote or side High Definition TV, or directly by pressing the Component button on the Remote Control.
8. If Component 1 input is being used, use Component 2 as the input and follow the steps 1 through 6; and then select Component 2 in step 7.

Note: Refer to your DVD player user manual for more information about the video output requirements of the product.



2.5.4 Using S-Video (AV)

Connecting your DVD Player (Good):

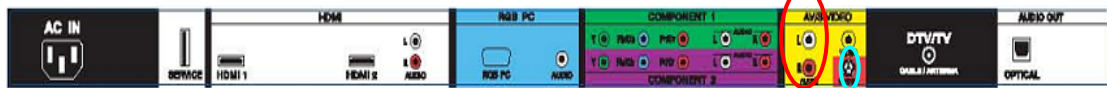

1. Turn off the power to the HDTV and DVD player.
2. Connect the S-Video jack on the rear of your DVD player to the S-Video jack in the AV/S-VIDEO group (yellow/red color area) on the back High Definition TV.
3. Connect an audio (white and red connector cables) cable to the audio output connectors associated with the S-Video output on your DVD player and connect the other end to the audio connectors associated with the AV/S-VIDEO input on the back side High Definition TV.
4. Turn on the power to the TV and DVD player.
5. Select AV using the INPUT button on the remote or side High Definition TV, or directly by pressing the AV button on the Remote Control.



2.5.5 Using Composite (AV) Video

Connecting your DVD Player (Good)



1. Turn off the power to the HDTV and DVD player.
2. Connect the Video (yellow color) connector on your DVD player to the Video (yellow color) connector in the AV group (yellow/red color area) at rear of the High Definition TV.
3. Connect the R (red color) and L (white color) audio connectors on your DVD player to the corresponding R (red color) and L (white color) audio input connectors in the AV group (yellow/red color area).
4. Turn on the power to the TV and DVD Player.
5. Select AV using the INPUT button on the remote or side of the High Definition TV, or directly by pressing the AV button on the Remote Control.



Note:

Refer to your DVD player user manual for more information about the video output requirements of the product.



2.6 Connecting Your VCR or Video Camera

1. Turn off the HDTV and VCR or Video Camera.
2. Connect the S-Video jack on the rear of your VCR or Video Camera to the S-Video jack in the AV group on the rear side of the High Definition TV.
3. Connect an audio (white and red connector cables) cable to the audio output connectors associated with the S-Video output on your VCR or Video Camera and connect the other end to the audio connectors associated with the AV input on the back side of the High Definition TV.
4. Turn on the power to the HDTV and VCR or Video Camera.
5. Select AV using the INPUT button on the remote or side of the High Definition TV.

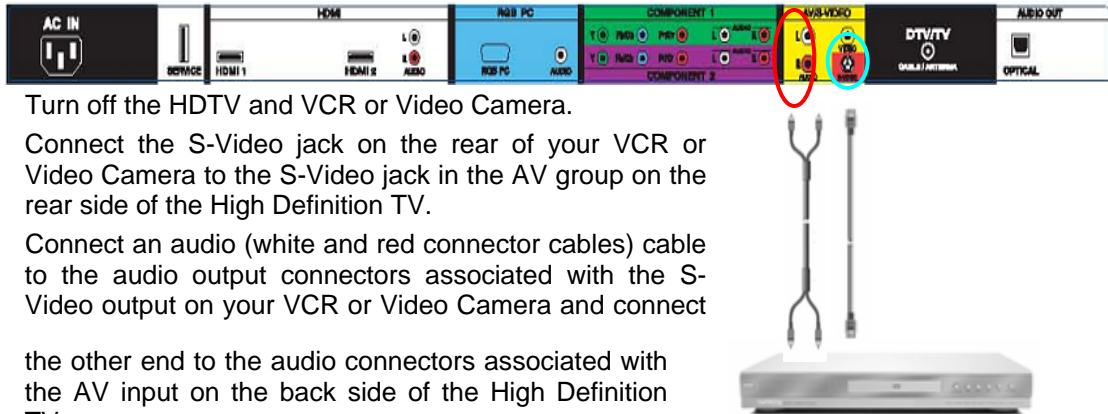

Note:

Refer to your VCR or Video Camera user manual for more information about the video output requirements of the product.



2.7 Connecting an external Receiver/Amp

2.7.1 Optical Output of Audio received with HD Programs

If your sound system has a SPDIF (optical) digital audio input you can connect it to the optical DIGITAL AUDIO OUT (white area) at the rear of the LCD HDTV. This is active when receiving audio with the program being viewed no matter what input is being used.

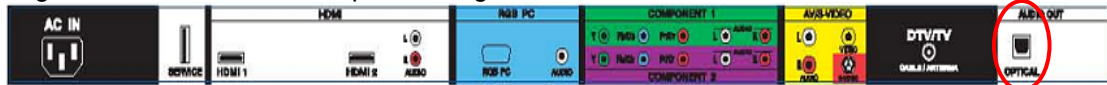

1. Turn off the power to the LCD HDTV and Receiver/Amp.
2. Using an audio cable (optical cable), connect the cable to the audio input connector on the Receiver/Amp and connect the other end to the OPTICAL OUT (white area) audio connector at the rear of the LCD HDTV.
3. Turn on the power to the LCD HDTV and Receiver/Amp.
4. Then press the **MENU** button on the remote control to open the On-Screen Display (OSD) menu.
5. Press the on the remote control to select the Audio menu.
6. Press the on the remote control to select SPEAKERS.
7. Press the on the remote control to select OFF so that the sound from the LCD HDTV will now be routed through your Receiver/Amp system.



Press the **LAST** key once to return to the previous screen or repeatedly to return to your program if task has been completed.

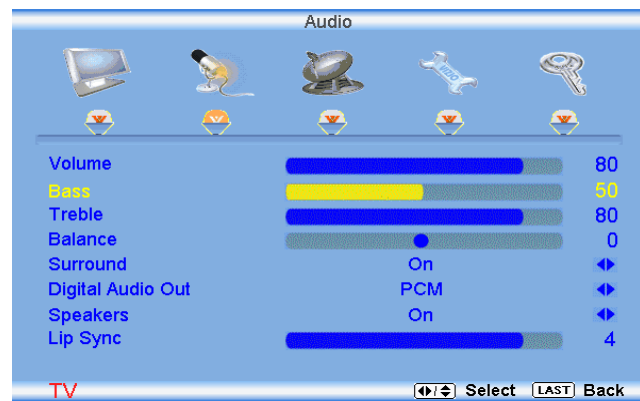

Note:

- a) Refer to your Receiver/Amp user manual to select the corresponding audio input.
- b) The audio output can not be connected directly to external speakers.



2.8 Connecting a PC Computer

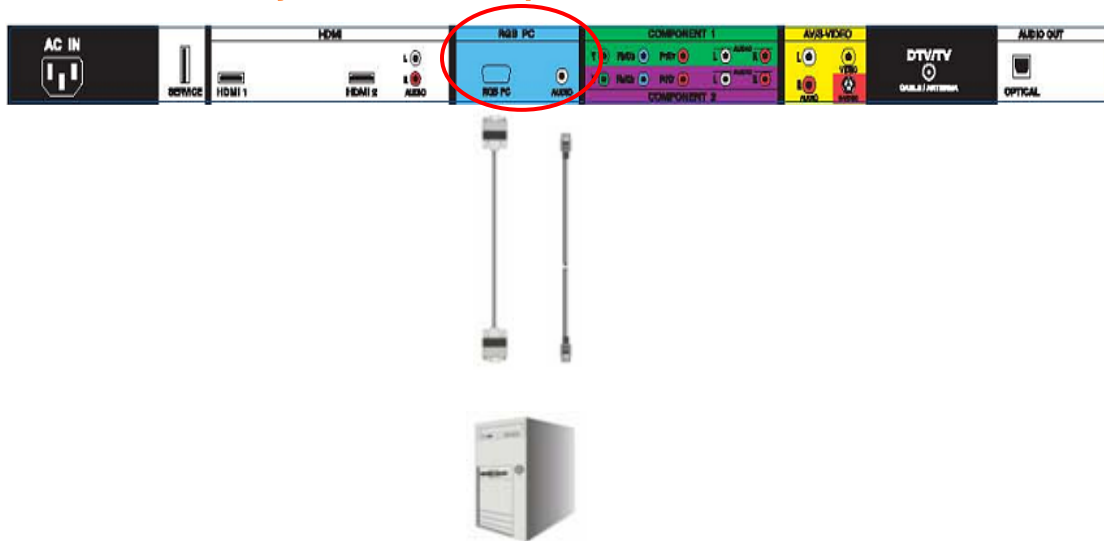

1. Turn off the power to the High Definition TV and PC Computer.
2. Connect a 15-pin D-Sub RGB (VGA) cable to the RGB output of your pc computer and the other end to the RGB PC input (blue area) at the rear of the High Definition TV.
3. Connect the Audio Out on your pc computer to the RGB PC Audio (this connection will require an 1/8" stereo mini plug at the end which goes into the TV) input (blue area) at the rear of the High Definition TV.
4. Turn on the HDTV and PC Computer.
5. Select RGB using the INPUT button on the remote or side of the High Definition TV.

Note:

- a) For the best picture quality when connecting a pc computer through RGB PC, set your pc computer timing mode to VESA 1366 x 768 at 60Hz. Please refer to the pc or graphic card's user guide for additional information on how to set the timing mode and the video output requirements of the product.
- b) A RGB (VGA) cable and stereo mini jack cable are not included and can be purchased at an electronics store.



2.8.1 Preset PC Resolutions

If connecting to a PC through the RGB PC input, set the TV timing mode to VESA 1366x768 at 60Hz for best picture quality (refer to the graphic card's user guide for questions on how to set this timing mode). Please see the table below for the factory preset resolutions.

Resolution	Refresh (Hz)	H-Freq (kHz)	V-Freq (Hz)	H-Sync	V-Sync	Pixel Freq (MHz)
640x480	60	31.47	59.94	N	N	25.18
640x480	75	37.50	75.00	N	N	31.50
720x400	70	31.46	70.08	N	P	28.32
800x600	60	37.88	60.32	P	P	40.00
800x600	72	48.08	72.19	P	P	50.00
800x600	75	46.88	75.00	P	P	49.50
1024x768	60	48.36	60.00	N	N	65.00
1024x768	70	56.48	70.07	N	N	75.00
1024x768	75	60.02	75.03	P	P	78.75
*1366X768	60	47.55	59.81	P	P	85.50

NOTES: N = Negative, P = Positive, * = Primary Mode





2.9 Setting Up to Watch Television

For 'Preparing Your LCD HDTV for Wall Mounting', see page 6.

2.10 Basic LCD HDTV Start Up

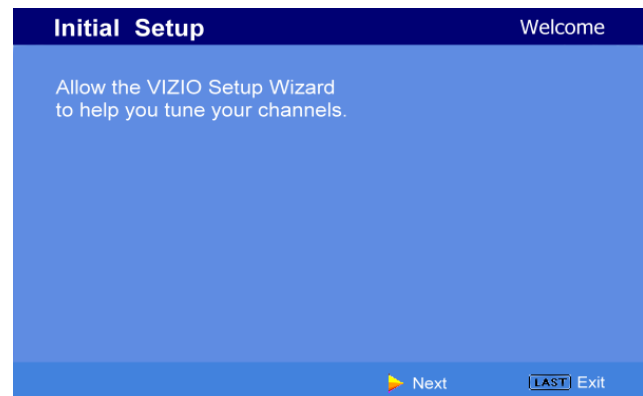
1. **Connecting the Power Cable**
Connect the power cord to the power cord connector on the back of the High Definition TV, and then plug the power cord into an AC wall socket.
2. **Connect Audio and Video Cables to the HDTV**
(see pages 13 ~ 25 for detailed steps)
3. **Turning Power On**
Once all the components are connected, press the Power ON button on the side of the High Definition TV, or press the Power ON (Red) button on the remote control.
4. **Initial Setup**
After powering on the TV set, the Initial Setup screen will come up; please press the  button on the remote control.



- a. The Language choice screen will be displayed; the default English option is highlighted. If you wish to change the OSD language to Español or Français, press the  button on the remote control to select the language you want.

Press the  button on the remote to go to the next screen.

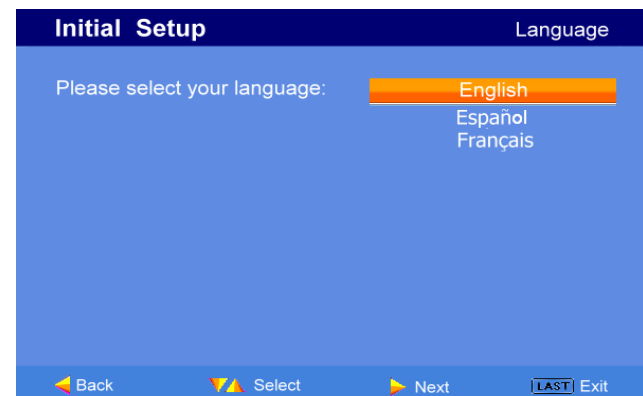

The next screen will display the options to select between Home Mode and Retail Mode, selecting Home Mode will give you an opportunity to save energy.

Press the  button on the remote to go to the next screen.

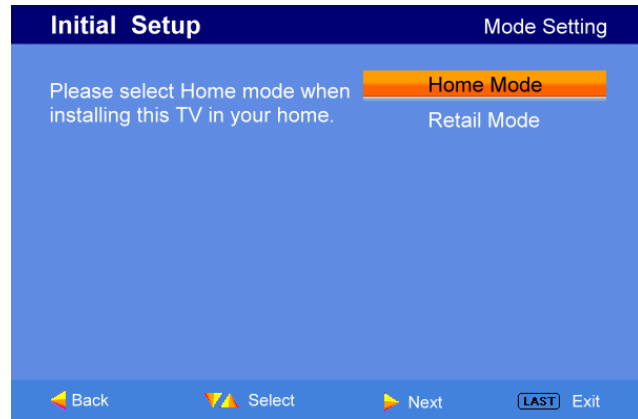

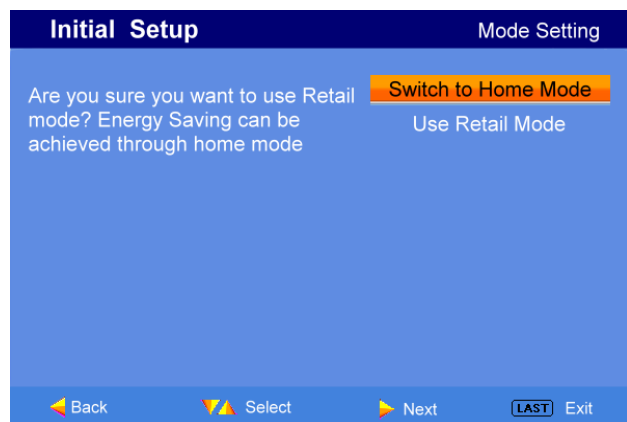

If Retail Mode is selected by mistake; the next option will allow you to switch your selection back to Home Mode.

Press the  button on the remote to go to the next screen.



Note: At this point, if a Set-Top Box from your Local Cable or Satellite Service Company or other equipment is being used; please press the **LAST** key on the remote control and go to Step 5. If this is not your case, please continue at Step b.

- b. The Tuner screen will be displayed; default choice is Antenna. If you are using Cable (No Box) Service, press the  button on the remote control to highlight CABLE.

Press the  button on the remote to go to the next screen.

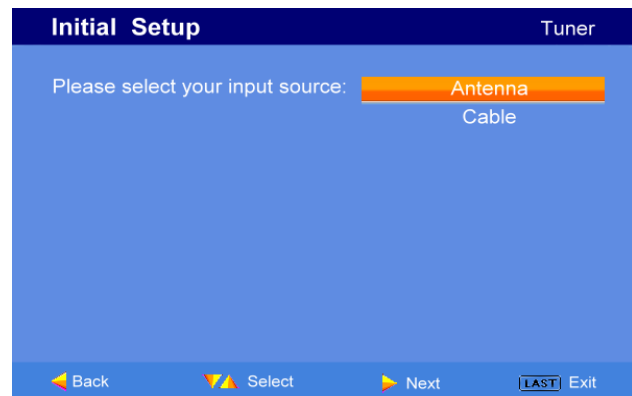

- c. The Channel Scan screen will be displayed; default choice is Scan. Press the  button on the remote control to commence the search for available channels to be stored into memory.

If you do not want to scan for channels at this time, press the **LAST** key on the remote control.

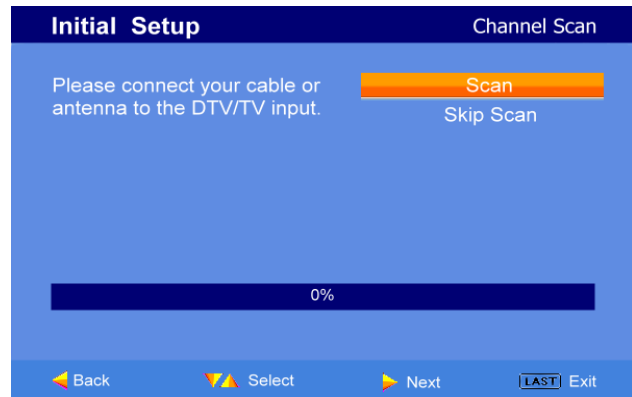

Note: If you select to skip this step by pressing the **LAST** key, next time that you decide to complete this procedure; you will need to select the TV as input (through the Input key) and then go through the Menu option to select the Tuner setup to get the option of scanning the channels again.

- d. The screen will now change to show the progress of the search for Analog (NTSC) and Digital (ATSC) channels.

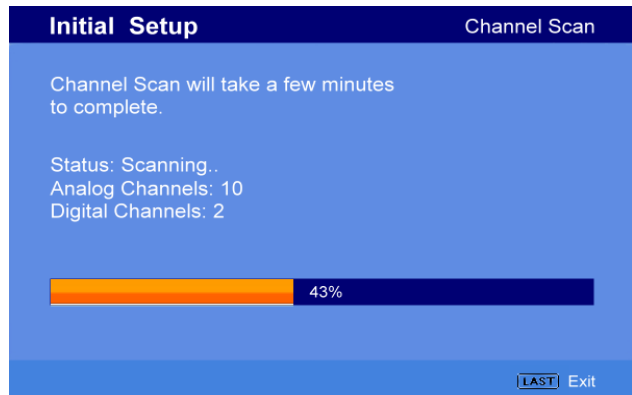

Note: DTV digital broadcast is not available in all areas. Refer to www.antennaweb.org to get information about availability in your area, type of antenna and in which direction to point your antenna. The channel availability through cable depends upon which channels your cable operator supplies in Clear QAM; consult your cable operator for more information.



- e. When finished, the Complete screen will be displayed to inform you that the HDTV has completed the Initial Setup.

Press the  button on the remote control to exit and begin watching TV.

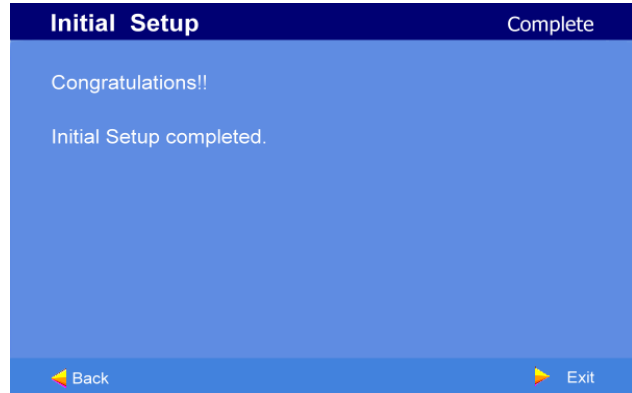

5. Select Input Source

Select the Input Source for the HDTV by pressing the INPUT button on the side of the High Definition TV or using the Input button on the remote control. Pressing this button will cycle you through the following options: TV, AV (S-VIDEO), Component1, Component2, RGB, HDMI1 and HDMI2.

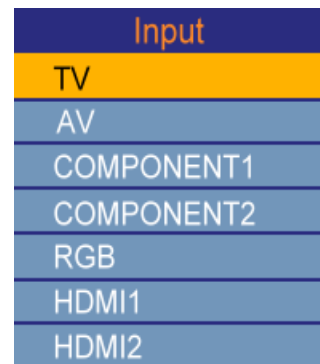

Now follow the procedure below to display channels from a different signal (External TV Tuner, VCR, Cable Box or Satellite Receiver) source, using different inputs at the back of your TV set.

- a. Select the correct input connection; RF (DTV/TV) connector, Composite (Yellow, Red and White) connectors, Component (Red, Green, Blue plus Red and White) connectors, HDMI connectors or Separate-Video (S-Video) plus Red and White connectors (if applicable). Make the physical connection or hook up.
- b. If you have an HD service you must use the HDMI (best) or Component connection.

Note: Composite (AV) and S-Video (AV) Cables can only be used for SD (480i) pictures.

c. Turn on your Cable Box, VCR, External TV Tuner or Satellite Receiver and you will see a picture on your TV set. If there is not picture, make sure you have selected the correct input on the TV set.

d. If the selected input is RF, you should be aware that the TV set needs to be on either channel 3 or channel 4 matching the channel which has been selected on the back of the VCR, Cable Box, External TV Tuner or Satellite Receiver; please refer to Owner or User's Manual of such equipment for details.





Note: The TV set will be displaying any television station or program selected by the Cable Box, VCR, External Tuner or Satellite Receiver. The TV set will not be able to change programs or channels; this is controlled by the equipment sending the signal. **If the service being used is the one which setup includes a box with two different outputs for two different (distant) rooms, then scanning channels would help you to find the signal. Be aware that the channel to be selected varies from provider to provider; meaning that, you may have to call your provider company so they could provide you the specific channel when using high definition made TV sets. Some examples of these channels are: 105, 106, 115 and 116.**

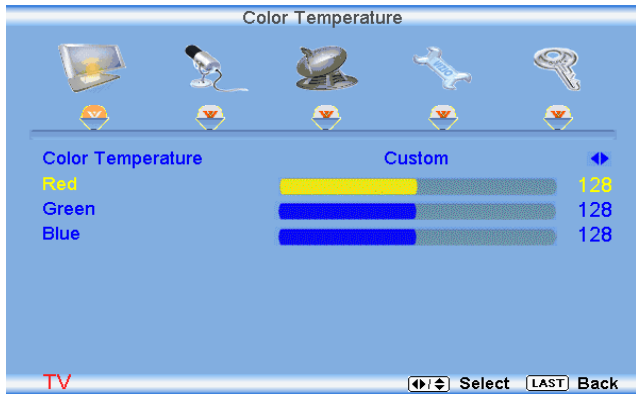
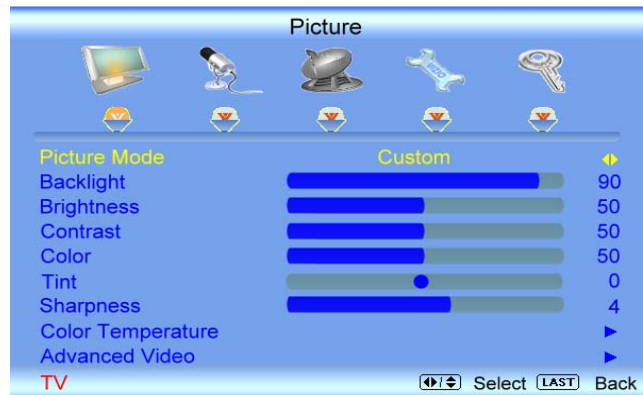

6. Fine Tuning your TV set for Home Use.

After completing Procedure 4 or Procedure 5; please follow the steps below to optimize your TV set display:

a. Press the **MENU** button to bring up the Menu display. Use the  or  button to scroll to the Color Temperature option.



b. Press the  button to select it.

c. Press either  or  button to change setting to Normal, and then press the **LAST** key again to go back to previous screen.

d. Press either  or  button to select the Picture Mode option.

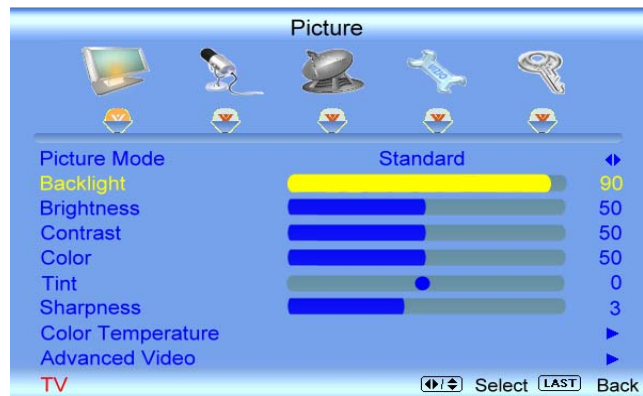

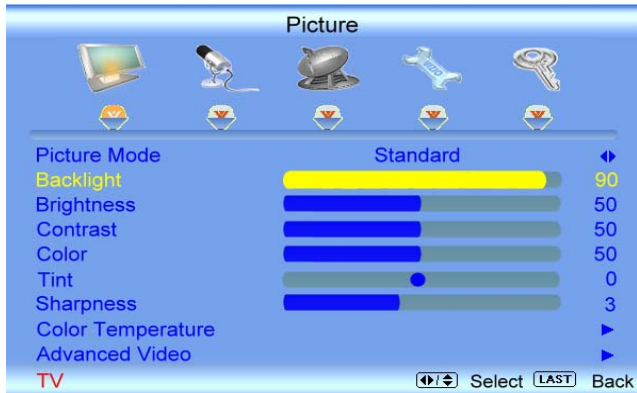



e. Press either  or  button to change the Picture Mode option to Standard.



f. Press the **LAST** key repeatedly to exit the on screen display Menu.

Note: If Procedure 4 had been done, you would like to do the following to ensure that the correct program times are shown when pressing the Guide key:

Press the **MENU** button, this will bring up the picture mode menu.

Pressing either  or  button scroll across to the icon showing the little satellite dish or antenna. The next screen will appear showing Time Zone.

Using either  or  button selects it.

Press either  or  button to choose the proper Time Zone of your area.

Press the **LAST** key once to return to the previous screen or repeatedly to return to your program if task has been completed.



Your new TV set is now ready to automatically reproduce the best picture quality out of the input signal which is been fed into it. Enjoy your TV watching!!



2.11 Watching a TV Program

Before you start watching TV, please make sure that any cable, satellite or off-air antenna connections are secure. Also, verify that the power cord is plugged into a correctly grounded electrical outlet or surge protector.

1. Press the power button on the remote or on the side of the High Definition TV. The VIZIO logo on the front will change from orange to white.
2. There are 3 options for selecting your programming:
 - a. If you are using an antenna or cable connected through the DTV/TV CABLE/ANTENNA input, you can select TV directly by pressing the TV button on the remote, or by pressing the INPUT button on the remote or on the side of the High Definition TV.
 - b. If you are watching broadcasts through a cable or satellite set-top box connected by an HDMI cable, select HDMI directly by pressing the HDMI button on the remote, or by pressing the INPUT button on the remote or on the side of the High Definition TV.
 - c. If you are watching broadcasts through a cable or satellite set-top box connected by a Component (YPbPr) cable, select Component directly by pressing the Component button on the remote, or by pressing the INPUT button on the remote or on the side of the High Definition TV.

Note: You should be able to see a picture. If you do not, make sure that all of the HDTV connections are secure and you have selected the correct video input source.

3. When using option 2a, press the Channel buttons on the remote or the CH+ / CH- buttons on the side of the High Definition TV to change the channel. Note: The Channel buttons, on the side of the High Definition TV and on the remote, control will not work if you are watching a program using HDMI, Component and AV inputs.



2.12 Adjusting Basic HDTV Settings



Volume

To adjust the volume, press and hold the VOL+ or VOL- button on the side of the LCD HDTV or remote control until the desired level is reached.

TV Channels

To step up or down through the available TV channels, press the CH+ or CH- button on the side of the HDTV or remote control once for the next or previous channel, or hold it depressed until the desired channel is reached.
 Note: Channel up and down will only operate in DTV and TV modes.

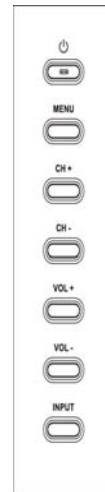

Wide

Using this feature, you can watch video content in different size modes on the HDTV. Press the **MENU** button on the remote control to bring up the OSD screen.

Press either the or button to select Setup (wrench look alike icon) options.

Press the button scroll down to Wide and select it.

Press either the or button to select among the modes.

For more information see Section 3.16.1 – Viewing Modes, on page 63.

2.13 Program Information

When you change TV channels or inputs or when the GUIDE key is pressed, an Information Banner is displayed for a few seconds to tell you the status of the LCD HDTV.

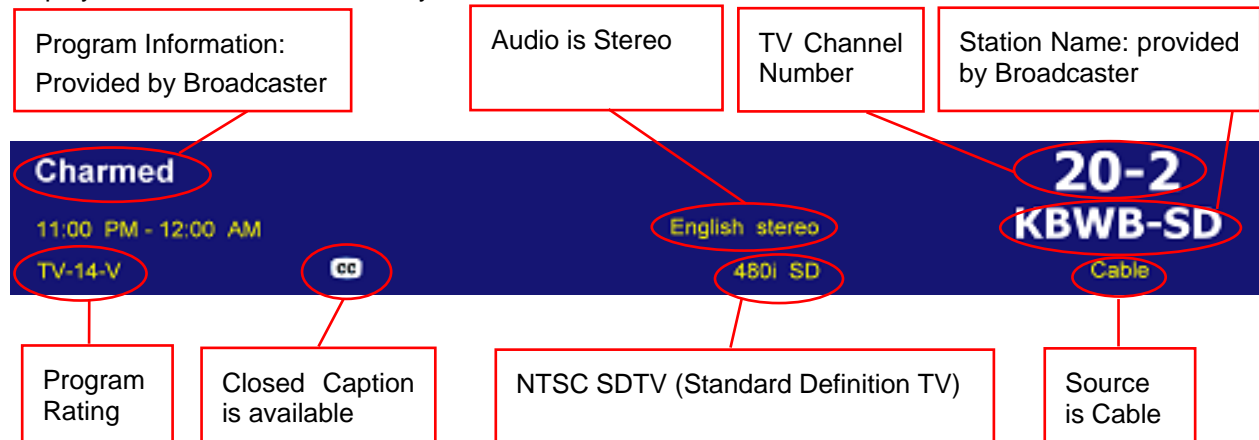



Chapter 3 Advanced Adjustment of HDTV

3.1 Using the On Screen Display (OSD)

The remote control or the control buttons on the right hand side of the High Definition TV can control all the function settings. The On Screen Display (OSD) allows you to adjust the save contrast, brightness and other settings. The TV will save changes made to the settings, even if the TV is turned off.

The OSD consists of several menu options: Picture Adjust, Audio Adjust, Setup, TV Tuner Setup and Parental Controls. The main menu options may vary depending on your selected input source.

Note: Some of the main menu options may have additional submenus, i.e. the TV Rating submenu for Parental Controls.

1. Press the **MENU** button on the remote control or the side of the High Definition TV and the Picture menu will be shown on the screen.
2. Press the  or  button on the remote control or the VOL + or VOL – button on the side of the High Definition TV to select one of the other menu options.

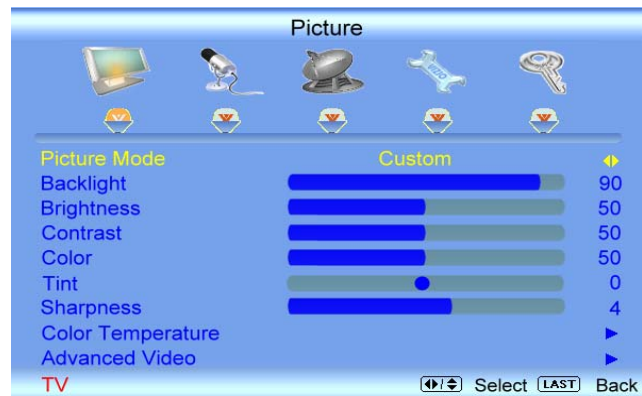

Picture Adjust Audio Adjust TV Tuner Setup Setup Parental Controls

3. Once the menu option is displayed, press the **MENU** button on the remote control or the CH + or CH – button on the side of the High Definition TV to select one of the items to adjust.



4. Press the  button on the remote control or the VOL – button on the side of the High Definition TV to begin adjustment of the item.
5. Press **MENU** button when finished.
6. Repeat steps 2 through 5 to adjust additional options within this menu.



Press the **LAST** key once to return to the previous screen or repeatedly to return to your program if task has been completed.



3.2 DTV / TV Input Picture Adjustment

3.2.1 Picture Mode

When the **MENU** button is pressed, the On Screen Display (OSD) appears on the PICTURE adjustment page. Press the  button to highlight the Picture Mode selection.

Use the  or  button to choose from Custom, Standard, Movie and Game.

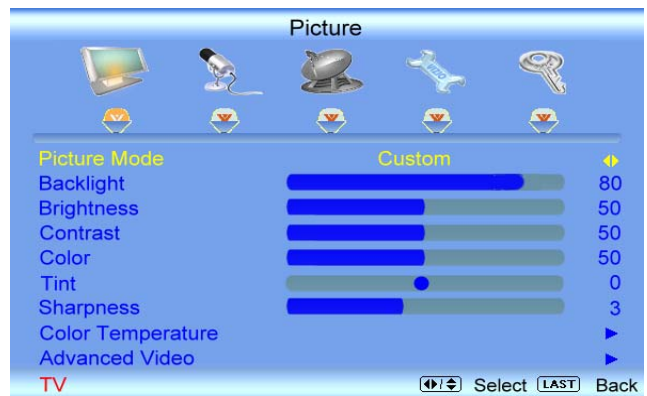

If Standard, Movie or Game is chosen for the Picture Mode, still the Picture adjustments are available for you to set or adjust them to your preferred settings.

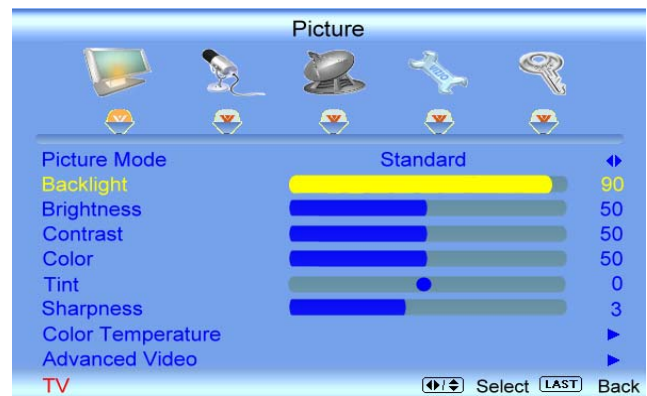



Press the **LAST** key once to return to the previous screen or repeatedly to return to your program if task has been completed.



3.2.2 Backlight

Press the  button to highlight the Backlight selection.

Press the  button to start adjusting the brightness of the Backlight and the menu page will disappear and be replaced by a small Backlight Indicator Bar so you can see the light level between the minimum and maximum available levels.

Use the  or  button to adjust the level.

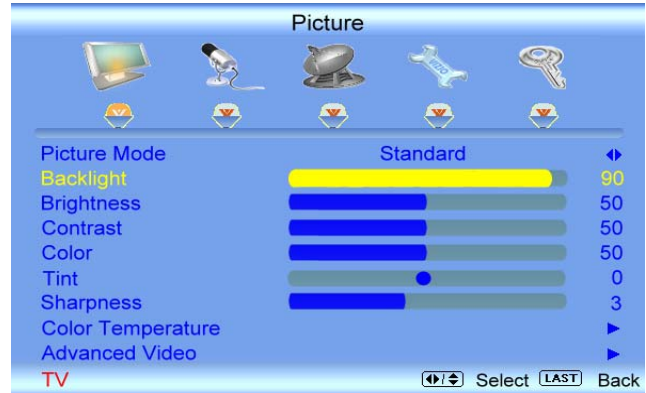

The Backlight level does not affect the Brightness (black level) or Contrast (white level) of the picture, it adjusts the lamp current and this affects the overall brilliance of the picture.

Press the **LAST** key once to return to the previous screen or repeatedly to return to your program if task has been completed.

Reminder: If display shows “Not Available” when trying to adjust the Backlight, please scroll down to Advance Video and select the DCR option to be OFF.

3.2.3 Brightness

Press the  button to highlight the Brightness selection.

Press the  button to start adjusting the brightness and the menu page will disappear and be replaced by a small Brightness Indicator Bar so you can see the brightness level between the minimum and maximum available levels.

Use the  or  button to adjust the level.



The Brightness adjusts the black levels in the picture. If the brightness is too low you will not be able to see the detail in darker parts of the picture and if the brightness is too high the picture will look washed out.

Press the **LAST** key once to return to the previous screen or repeatedly to return to your program if task has been completed.



3.2.4 Contrast

Press the  button to highlight the Contrast selection.

Press the  button to start adjusting the contrast and the menu page will disappear and be replaced by a small Contrast Indicator Bar so you can see the contrast level between the minimum and maximum available levels.

Use the  or  button to adjust the level.



The Contrast adjusts the white levels in the picture. If the contrast is too low the picture will look washed out and if the contrast is too high you will not be able to see any detail in the bright parts of a picture.

Press the **LAST** key once to return to the previous screen or repeatedly to return to your program if task has been completed.

3.2.5 Color

Press the  button to highlight the Color selection.

Press the  button to start adjusting the color and the menu page will disappear and be replaced by a small Color Indicator Bar so you can see the color level between the minimum and maximum available levels.

Use the  or  button to adjust the level.



The Color adjusts the amount of color in the picture.

Press the **LAST** key once to return to the previous screen or repeatedly to return to your program if task has been completed.

3.2.6 Tint

Press the  button to highlight the Tint selection.

Press the  button to start adjusting the tint and the menu page will disappear and be replaced by a small Tint Indicator Bar so you can see the tint adjustment to the left or right of the nominal position.

Use the  or  button to adjust the level.



The Tint adjusts the hue of the picture. The easiest way to set tint is to look at flesh tones and adjust for a realistic appearance. In most cases, the default middle position is correct. If people's faces look too orange try reducing the level of color first as the case of this is often too much color.

Press the **LAST** key once to return to the previous screen or repeatedly to return to your program if task has been completed.



3.2.7 Sharpness

Press the  button to highlight the Sharpness selection.

Press the  button to start adjusting the sharpness and the menu page will disappear and be replaced by a small Sharpness Indicator Bar so you can see the sharpness level between the minimum and maximum available levels.

Use the  or  button to adjust the level.



The Sharpness adjusts the sharpness of the picture.

Press the **LAST** key once to return to the previous screen or repeatedly to return to your program if task has been completed.

3.2.8 Color Temperature

Press the  button to highlight the option for Color Temperature selection.

The default is COOL; this is the 9300K setting.

Press the  or  button if you want to choose the Normal, Warm or Custom option.

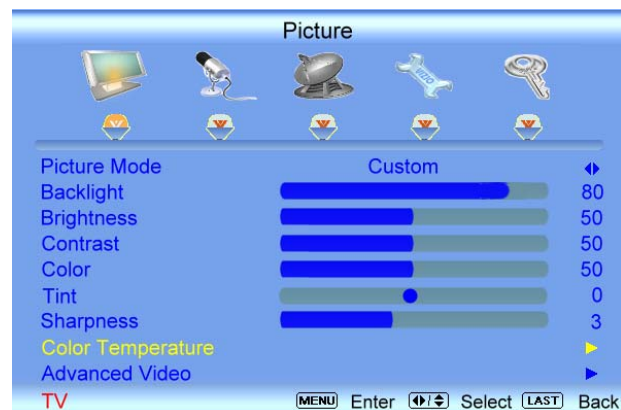

If you choose the Custom option, then a new menu will be displayed showing the primary color items, Red, Green and Blue. Press the  button to highlight the color you wish to adjust.

Press the  button to start adjusting the color and the menu page will disappear and be replaced by a small Color (Red, Green or Blue) Indicator Bar as before.

Use the  or  button to adjust the color.

Repeat the procedure to adjust the other colors if desired.

Press the **LAST** key once to return to the previous screen or repeatedly to return to your program if task has been completed.

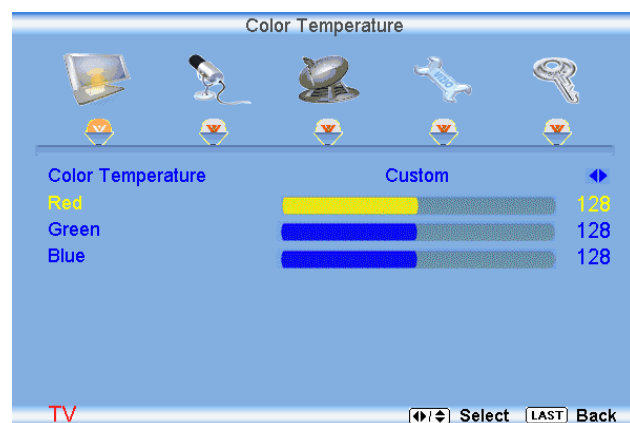



3.2.9 Advanced Video

Press the  button to highlight the option for Advanced Video selection.

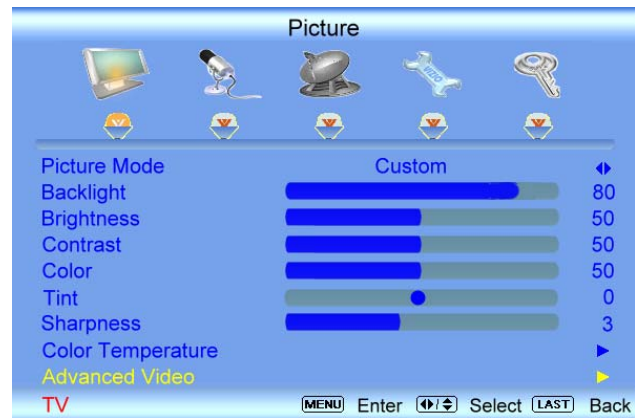
Press the **MENU** button. A new menu will be displayed showing the advanced functions available for fine tuning of the picture.



DNR

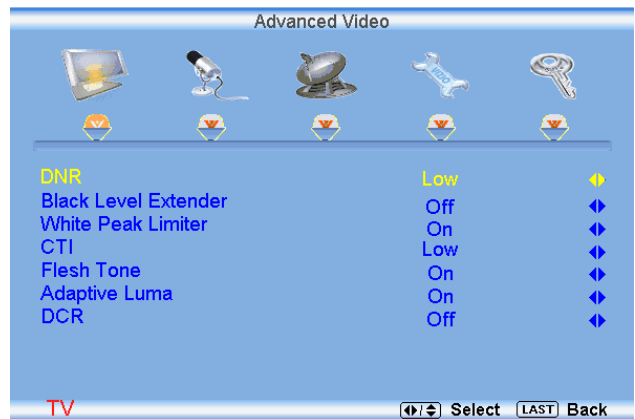

Press the  button to highlight DNR (Dynamic Noise Reduction). Use this feature to diminish picture artifacts caused by the digitizing of image motion content that may be present in the picture. Press the  or  button to choose from the Off, Low, Medium or Strong setting.

Press the **LAST** key once to return to the previous screen or repeatedly to return to your program if task has been completed.



Black Level Extender

Press the  button to highlight Black Level Extender. Use this feature to increase the picture reproduction performance in the dark areas of the picture.



Press the  or  button to turn this feature On or Off.

Press the **LAST** key once to return to the previous screen or repeatedly to return to your program if task has been completed.



White Peak Limiter

Press the  button to highlight White Peak Limiter. Use this feature to limit excessive white in bright areas of the picture, caused by a lower sync level for a channel being received from the antenna or cable.



Press the  or  button to turn this feature On or Off.

Press the **LAST** key once to return to the previous screen or repeatedly to return to your program if task has been completed.



CTI



Press the  button to highlight CTI (Color Transient Improvement). This feature can be used to reduce the time taken to transition from one color to another. The effect will be seen as sharpening the border between colors.

Press the  or  button to choose from the Off, Low, Medium or Strong setting.

Press the **LAST** key once to return to the previous screen or repeatedly to return to your program if task has been completed.

Flesh Tone

Press the  button to highlight Flesh Tone. In some cases, activation of this feature can result in a more pleasing production of sky and flesh color.



Press the  or  button to turn this feature On or Off.

Press the **LAST** key once to return to the previous screen or repeatedly to return to your program if task has been completed.





Adaptive Luma

Press the  button to highlight Adaptive Luma. Large areas of darkness in a picture will result in a lower Average Picture Level (APL) and the overall picture will look too dark; activation of this feature will raise the APL to counteract this effect.

Press the  or  button to turn this feature On or Off.

Press the **LAST** key once to return to the previous screen or repeatedly to return to your program if task has been completed.

DCR (Dynamic Contrast Ratio)

Press the  button to highlight the DCR (Dynamic Contrast Ratio). This feature can be set to On or Off to allow the TV set to display the supplied image, dark and bright scenes; with a more vivid or intense quality. ON implies that the dark would be accentuated and OFF would intensify the brightness. Press the  or  button to turn this On or Off. Having this feature in the ON mode will disable the Backlight adjustment.





3.3 DTV / TV Input Audio Adjustment

3.3.1 Volume

When the **MENU** button is pressed, the On Screen Display (OSD) appears on the PICTURE adjustment page. Press the  button to display the AUDIO ADJUST page.

Press the  button to highlight the Volume selection.

Press the  button to start adjusting the volume and the menu page will disappear and be replaced by a small Volume Indicator Bar so you can see the volume level between the zero and maximum available levels.

Use the  or  button to adjust the level.





The Volume Indicator Bar will also appear when watching a program on your TV is the Volume button on the remote or the side of the High Definition TV is pressed.

Press the **LAST** key once to return to the previous screen or repeatedly to return to your program if task has been completed.

3.3.2 Bass

Press the  button to highlight the Bass selection.

Press the  button to start adjusting the bass and the menu page will disappear and be replaced by a small Bass Indicator Bar, as before, so you can see the bass level between the zero and maximum available levels.

Use the  or  button to adjust for bass boost or attenuation.





Press the **LAST** key once to return to the previous screen or repeatedly to return to your program if task has been completed.



3.3.3 Treble

Press the  button to highlight the Treble selection.

Press the  button to start adjusting the treble and the menu page will disappear and be replaced by a small Treble Indicator Bar, as before, so you can see the treble level between the zero and maximum available levels.

Use the  or  button to adjust for treble boost or attenuation.





Press the **LAST** key once to return to the previous screen or repeatedly to return to your program if task has been completed.

3.3.4 Balance

Press the  button to highlight the Balance selection.

Press the  button to start adjusting the balance and the menu page will disappear and be replaced by a small Balance Indicator Bar, as before, so you can see the balance adjustment to the left or right of the nominal position.

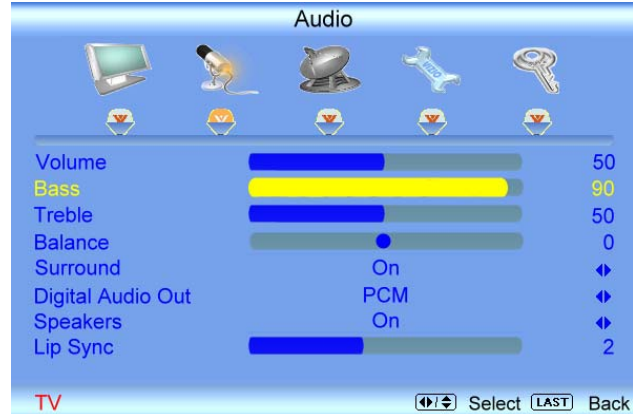

Use the  or  button to adjust the left/right balance.



Press the **LAST** key once to return to the previous screen or repeatedly to return to your program if task has been completed.

3.3.5 Surround

Press the  button to highlight the Surround selection.

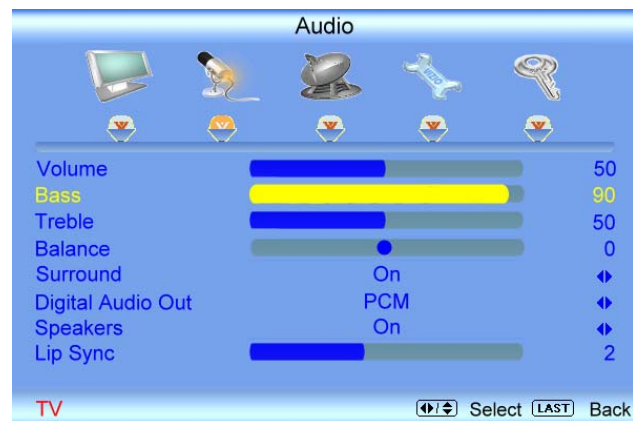

Press the  or  button to select for the simulated surround sound feature to be On or Off.

Press the **LAST** key once to return to the previous screen or repeatedly to return to your program if task has been completed.



3.3.6 Digital Audio Out



Press the  button to highlight the Digital Audio Out selection.

Press the  or  button to make the proper selection. The options being Dolby Digital, PCM and OFF.

Press the **LAST** key once to return to the previous screen or repeatedly to return to your program if task has been completed.

3.3.7 Speakers

Press the  button to highlight the Speakers selection.



Press either  or  button to turn the internal speakers On or Off. You may want to turn-off the internal speakers when listening to the audio through your Home Theatre System.

Press the **LAST** key once to return to the previous screen or repeatedly to return to your program if task has been completed.

3.3.8 Lip Sync

Included with the advanced technology of your TV, a feature which will compensate the shortcomings of signal transmission called audio sync (Lip Sync). Lip Sync is designed to adjust the audio of the program being viewed so that it matches the movement of the lips of someone talking on the screen. This feature is built into your set, and it can be applied to all inputs. To use this feature, follow the steps below.

Press the **MENU** button to bring up the OSD.

Using either the  or  button scroll across to the microphone icon, the Audio menu will be displayed.

Press either  or  button to scroll either up or down to Lip Sync.

Press either  or  button to make the appropriated adjustment.

Press the **LAST** key once to return to the previous screen or repeatedly to return to your program if task has been completed.

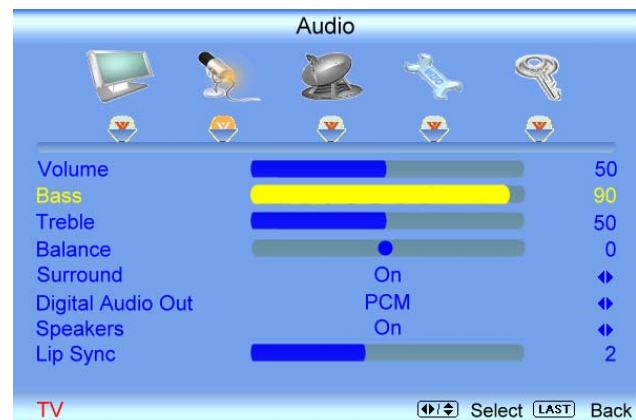



3.4 DTV / TV Tuner Setup

When you first used your VIZIO VW32L HDTV40A you will have setup your TV for DTV / TV channels using the Initial Setup screens. If you did not do this or if your setup has changed, you can do this from the TV TUNER SETUP menu.

3.4.1 Tuner Mode

When the **MENU** button is pressed, the On Screen Display (OSD) appears on the PICTURE adjustment page. Press the  button to display the TV page.

Press the  button to highlight the Tuner Mode selection.

Press either  or  button to choose Cable or Air (Antenna) depending upon which equipment you have attached to the DTV / TV Input.



3.4.2 Auto Search

Press the  button to highlight the Auto Search selection.

Press the  button to Auto Search for TV channels available. The TV will automatically search for analog and digital channels.



3.4.3 Skip Channel

After the TV has stored all of the available DTV channels in memory you will find that some channels will be too weak to watch comfortably or they may be channels you do not want to see. Select the channel you wish to remove.

Press the **MENU** and  buttons to open the TV TUNER SETUP menu.

Press the  button to highlight SKIP CHANNEL.

Press the  button to select this channel to be skipped when using the CH+ or CH- button. You will still be able to select this channel using the number buttons on the remote control.



Press the **LAST** key once to return to the previous screen or repeatedly to return to your program if task has been completed.



3.4.4 MTS

This feature allows you, the user to select the different languages in which the signal provider or broadcaster is transmitting the audio with the program you are watching. This signal is usually or in most cases Spanish language.

Press the  button as many times as it takes to scroll down to this option and get it highlighted.



Press either  or  button to go through the settings of this feature to make your selection.

Press the **LAST** key once to return to the previous screen or repeatedly to return to your program if task has been completed.

3.4.5 Time Zone

Setting the correct Time Zone for your area will ensure that the correct program times are shown after pressing the GUIDE button on the remote control.

Press the  button to highlight the Time Zone selection.

Press either  or  button to select your area.

Press the **LAST** key once to return to the previous screen or repeatedly to return to your program if task has been completed.



3.4.6 Daylight Saving

As for Time Zone, setting the daylight saving time for your area will ensure that the correct program times are shown after pressing the GUIDE button on the remote control.

Press the  button to highlight the Daylight Saving selection.

Press either the  or  button to select On or Off.

Press the **LAST** key once to return to the previous screen or repeatedly to return to your program if task has been completed.





3.5 DTV / TV Input Setup

3.5.1 Language

When the **MENU** button is pressed, the On Screen Display (OSD) appears on the PICTURE adjustment page. Press the  button until the SETUP page is displayed.

Press the  button to highlight the Language selection. The default is English.



Press either  or  button to select Español or Français.

Press the **LAST** key once to return to the previous screen or repeatedly to return to your program if task has been completed.



3.5.2 Sleep Timer

Press the  button to highlight the Sleep Timer selection.

Press either  or  button to select the timer to turn-off the TV in 30, 60, 90 or 120 minutes.



Press the **LAST** key once to return to the previous screen or repeatedly to return to your program if task has been completed.



3.5.3 Wide

The Wide option is the feature which allows you to select how your display would be size wise. When in TV mode; the selections are Normal, Wide, Stretch and Panoramic views.

Press the  button as many times as it takes to scroll down to this option and highlight it.

Press either  or  button to make the correct selection, you will see the screen adjusting to the different sizes which apply to this feature.

Press the **LAST** key once to return to the previous screen or repeatedly to return to your program if task has been completed.



3.5.4 Input Naming

This feature has been added to facilitate you, the user in identifying or label the input and signal which is being watched. You could use up to 8 characters; either letters or numbers or combinations of both.



Press  button to highlight this option.

Press  button to obtain the next screen which shows the different inputs.

Press  button to select the desired input which you want to label or name (Examples: VCR, DVD,..., etc.) it with any name which will make easier for you to recognize it.

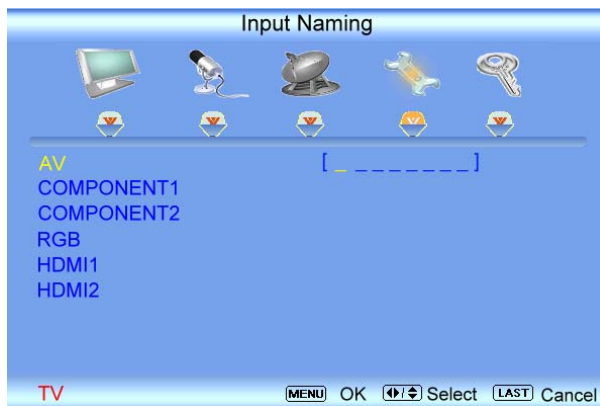
Press the **MENU** button to go to the first space () in the bracket.



Press either the  or  button and select either the letter or number belongs to this place.

Press the  button to go to the next space () and again

Using either the  or  button select the second character of the name given to this Input.

Repeat the last previous two steps until the name of the input is completed.

Press the **MENU** button to accept the name of the input or the **LAST** key to cancel the setting. .

Press the **LAST** key when you have finished to go to the previous menu.

Since you are already in this feature; it is recommendable to name all the Inputs which are being used as well as these for which you have an idea what their name is going to be.





Press the **LAST** key once to return to the previous screen or repeatedly to return to your program if task has been completed.



3.5.5 Closed Caption (CC)

When watching regular analog (NTSC) TV, the Analog CC feature is available in the Setup menu.

Press the  button to highlight the Analog CC selection.

Press the  button to select CC1, CC2, CC3 or CC4.

Press the **LAST** key once to return to the previous screen or repeatedly to return to your program if task has been completed.

Closed Caption for regular TV is usually CC1 or CC2.





3.5.6 Digital Closed Caption Style (Digital CC Style)

When watching DTV, the Digital CC Style feature is available in the Setup menu.

Press the  button to highlight the Digital CC Style selection.

Press the  button to go to the next screen.

Press either  or  button to toggle between the two options; As Broadcaster and Custom.

If Custom is selected then you will have the control to customize the way Closed Caption will be displayed by changing these different parameters to your like: **Font Size** (letters size), **Font Color** (letters color) **Font Opacity** (transparency of the letters), **Background Color** (color of the background area where Closed Caption is going to be displayed), **Background Opacity** (allows to either see through at the scene being played or it could be a solid screen), **Window Color** (it allows you to change the color to the area where characters will be displayed on) and finally **Window Opacity** (allows the area surrounding characters to be changed). There are no recommendations of setting these parameters since you, the user would have your own taste or like of them.





Press the **LAST** key once to return to the previous screen or repeatedly to return to your program if task has been completed.



3.5.7 System Reset

Press the  button to highlight the System Reset.

Press the  button to go to next screen.

Press the  button to select either Setup Wizard or Reset All Settings.

Selecting Setup Wizard brings up the Initial Setup procedure described on pages 28 through 30.

Selecting Reset All Settings brings the TV up the settings of all features and options to manufacturer's values.



Press either the **MENU** button to return to the previous menu display or the **LAST** key to return to your program if task has been completed.



Note: Neither Setup Wizard nor Reset All Settings will reset the Parental Control password.



DTV / TV Input Parental Control

3.5.8 Channel Block

If you want to restrict certain channel and program viewing, you can do this by turning on the Parental Control. Selected programs, movies and channels can then be made available only after an authorized password has been entered and accepted by the TV.

When the **MENU** button is pressed, the On Screen Display (OSD) appears on the PICTURE adjustment page. Press the  button to display the PARENTAL page.

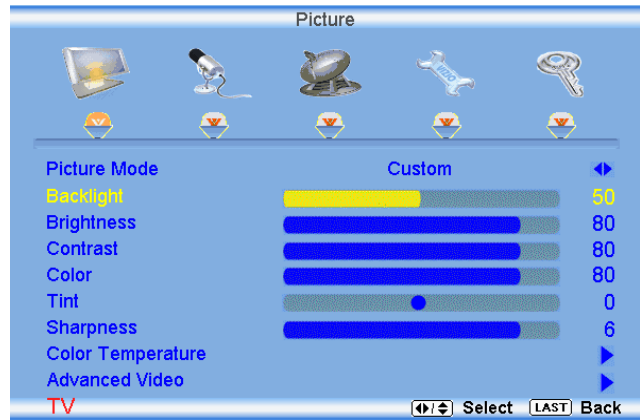

The Password must be entered before the TV will continue with Parental settings. The default password set in the factory is 0 0 0 0. If you are going to use the Parental Control feature you should change the password.

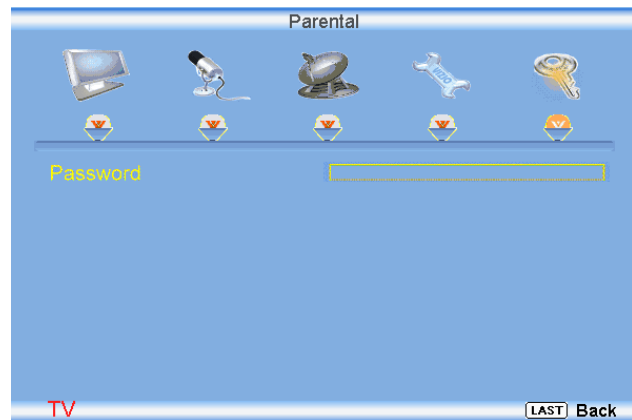

Note: Make sure you write down and store the new password in a secure place. The Reset All Settings feature (see page 51) does NOT reset the password.



Press the button to highlight the Channel Block selection.

Press the button to go to the next screen.

Press the **LAST** key once to return to the previous screen or repeatedly to return to your program if task has been completed.

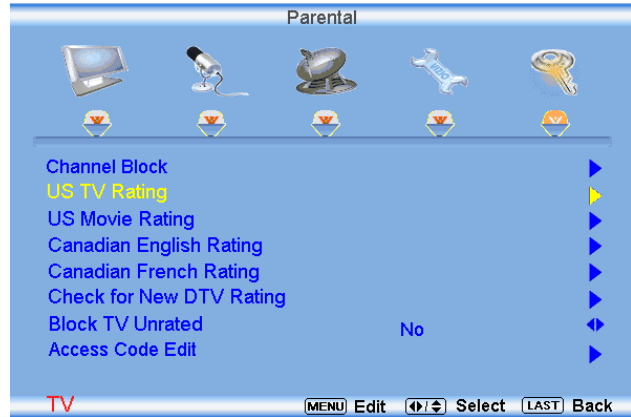

3.5.9 US TV Rating

Follow the procedure in the previous section 3.5.8 to display the Parental Control menu and then press the button to highlight the TV Rating selection.

Press the button and the Block TV Rating panel will be displayed.

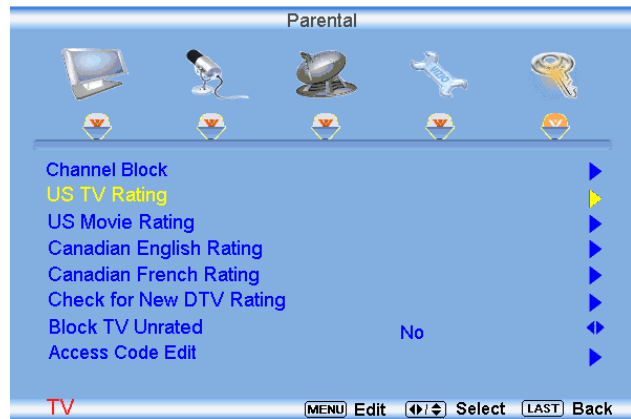

In the Block TV Rating panel you can customize the program blocking of the following TV ratings:

- Y – All children
- Y7 – Older children
- G – General audience
- PG – Guidance suggested
- 14 – Strongly cautioned
- MA – Mature audience

You can also customize the TV ratings for the following content:

- A – All sub-ratings
- D – Sexual dialog
- L – Adult language
- S – Sexual situations
- V - Violence
- FV – Fantasy violence

Press the or button to navigate through the TV rating options. Press the **MENU** button to block (locked) or allow (unlocked).

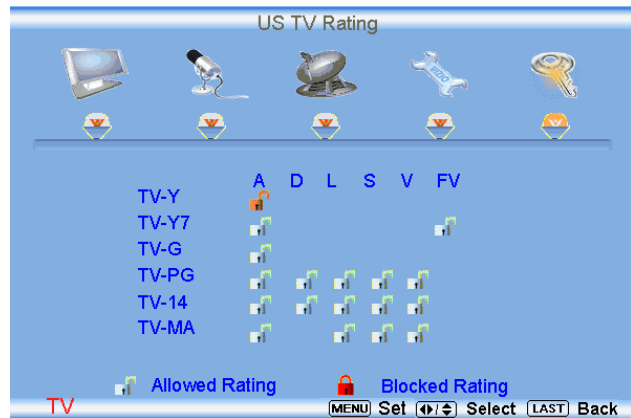

Press the **LAST** key once to return to the previous screen or repeatedly to return to your program if task has been completed.



3.5.10 US Movie Rating (For US)



Press the  button to highlight the US Movie Rating selection.

Press the  button and the Block Movie Rating panel will be displayed.

In the Block Movie Rating panel you can customize the program blocking of the following Movie ratings:

- G – General audience
- PG – Parental guidance suggested
- PG-13 – Recommended for children 13 years of age or older
- R – Mature audience
- NC-17 – No one under 17 years of age
- X – No one under 17 years of age



Press the  or  button to navigate through the Movie rating options.

Press the MENU button to block (locked) or allow (unlocked).



3.5.11 Canadian English Rating

Press the  button to highlight the Canadian English Rating selection.

Press the  button and the Block Canadian English Rating panel will be displayed.

In the Block Canadian English Rating panel you can customize the program blocking of the following ratings:

- C – Children
- C8+ – Children 8 years or older
- G – General Programming, suitable for all audiences
- PG – Parental guidance
- 14+ – Viewers 14 years or older
- 18+ – Adult programming

Press the  or  button to navigate through the Movie rating options.

Press the MENU button to block (locked) or allow (unlocked).



3.5.12 Canadian French Rating

Press the button to highlight the Canadian French Rating selection.

Press the button and the Block Canadian French Rating panel will be displayed.

In the Block Canadian French Rating panel you can customize the program blocking of the following ratings:

- G – General audience
- 8 ans+ – General – not recommended for young children
- 13 ans+ – Not suitable for children under 13 years of age
- 16 ans+ – Not suitable for under 16 years of age
- 18 ans+ – Adults only

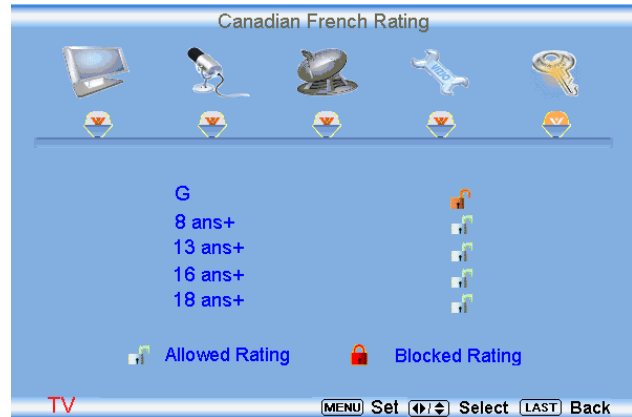

Press the or button to navigate through the Movie rating options.

Press the **MENU** button to block (locked) or allow (unlocked).

3.5.13 DTV Rating

This option is designed to update the TV or Movie table of different ratings for programs being viewed in your local or regional area. It will allow the parental guidance control feature in your TV to have the most current parental control database for a digital signal. This option may be available in the future for activation. This option works as follows: Whenever you decide to use the Parental Control feature and this option has been activated in your area, the Check for New DTV Rating will be a solid color indicating that an update is available for the TV Rating or Movie Rating table. After entering the password, the Parental menu will appear on the screen, and then do the following.

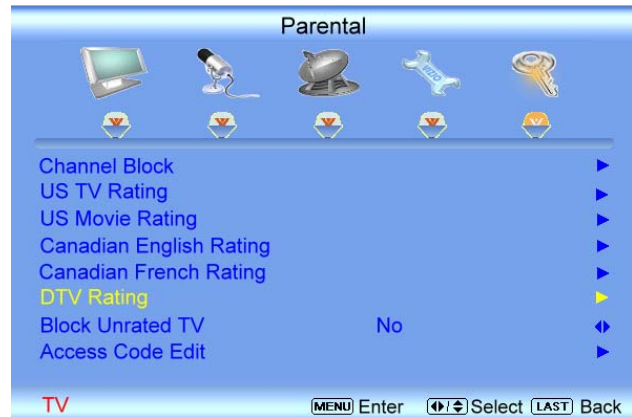

Observe the status of the **DTV Rating**. If option is faded out, no update is available (the option is not activated in your area). If it is not faded out,

press either or button to select this option.

Press button to execute this operation. Please follow the on screen instructions to complete this procedure.



Press either or button to select and then adjust any other option in this menu.

Press the **LAST** key once to return to the previous screen or repeatedly to return to your program if task has been completed.



3.5.14 Blocked Unrated Programming

Follow the procedure in the previous section 3.5.8 to display the Parental Control menu and then press the  button to highlight the Block Unrated TV selection.

Press either  or  button to select **YES** or **NO** to block programs that do not have a rating.

Press the **LAST** key once to return to the previous screen or repeatedly to return to your program if task has been completed.



3.5.15 Change the Password

Press the  button to highlight the Access Code Edit selection.

Press the  button and the new Password panel will be displayed.

Enter the new, 4-digit password using the number buttons on the remote. Enter it a second time to confirm you entered it correctly.

Press the **LAST** key once to return to the previous screen or repeatedly to return to your program if task has been completed.

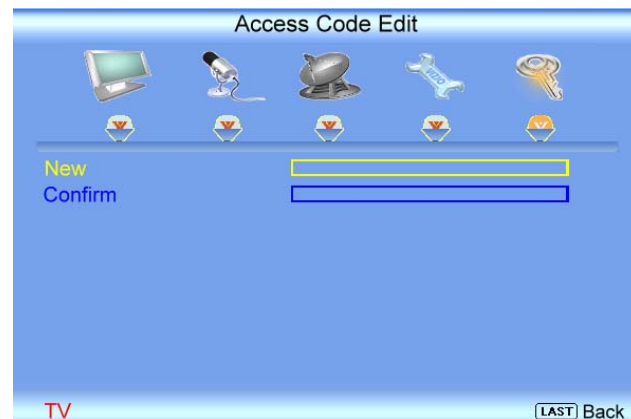

Note: Make sure you write down and store the new password in a secure place. The Reset All Settings feature (see page 51) does NOT reset the password.



3.6 HDMI Input Picture Adjustment

The Picture Adjust menu operates in the same way for the HDMI Input as for the DTV / TV input in section 3.3. The menu difference is that there is no icon along the top for DTV / TV or Parental Control adjustments.

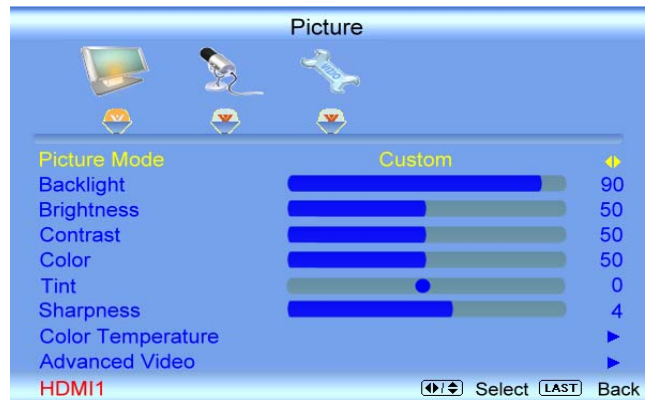

3.7 HDMI Input Audio Adjustment

The Audio Adjust menu operates in the same way for the HDMI Input as for the DTV / TV input in section 3.3. The menu difference is that there is no icon along the top for DTV / TV or Parental Control adjustments.

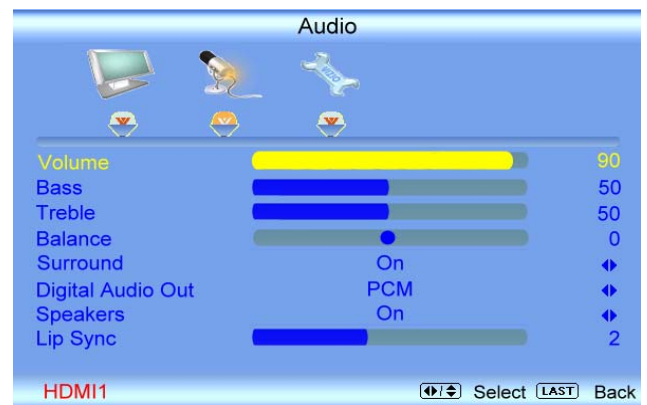

3.8 HDMI Input Setup

The Setup menu operates in the same way for the HDMI Input as for the DTV/TV input in section 3.3. The menu difference is that there is no icon along the top for DTV / TV or Parental Control adjustments.



3.9 Video Input Picture Adjustment

The Picture Adjust menu operates in the same way for Video Inputs (Component and AV) as for the DTV / TV input in section 3.23. The menu difference is that there is no icon along the top for DTV / TV adjustments.

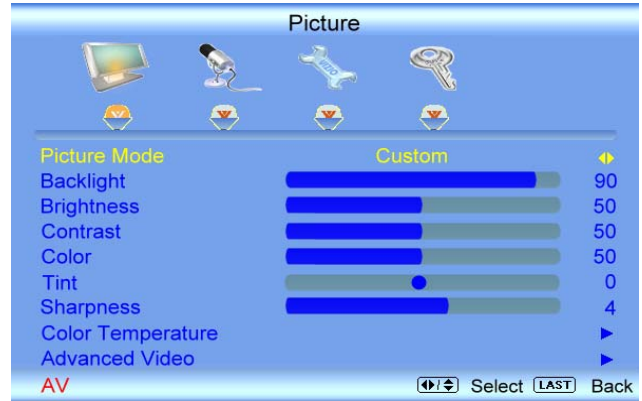

3.10 Video Input Audio Adjustment

The Audio Adjust menu operates in the same way for Video Inputs (Component and AV) as for the DTV / TV input in section 3.3. The menu difference is that there is no icon along the top for DTV / TV adjustments.

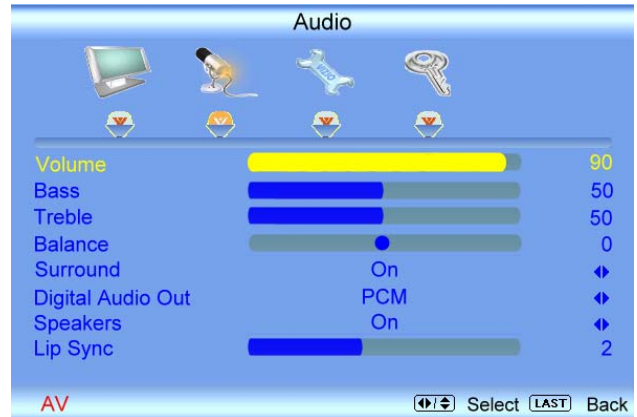

3.11 Video Input Setup

The Setup menu operates in the same way for Video Inputs (Component and AV) as for the DTV/TV input in section 3.3. The menu difference is that there is no icon along the top for TV adjustments.



3.12 Video Input Parental Control

The Parental Control menu operates in the same way for Video Inputs (Component and AV) as for the DTV / TV input in section 3.5. The menu difference is that there is no icon along the top for DTV / TV adjustments.



3.13 PC Input Picture Adjustment

The Picture Adjust menu operates in the same way for the PC Input as for the DTV / TV input in section 3.2 for Backlight, Contrast, Brightness and Color Temperature.

3.13.1 Auto Adjust

When the **MENU** button is pressed, the On Screen Display (OSD) appears on the PICTURE adjustment page. Press the  button to highlight the Auto Adjust selection.

Press the  button for the LCD HDTV to adjust to the PC signal timing automatically.

Press the **LAST** key once to return to the previous screen or repeatedly to return to your program if task has been completed.

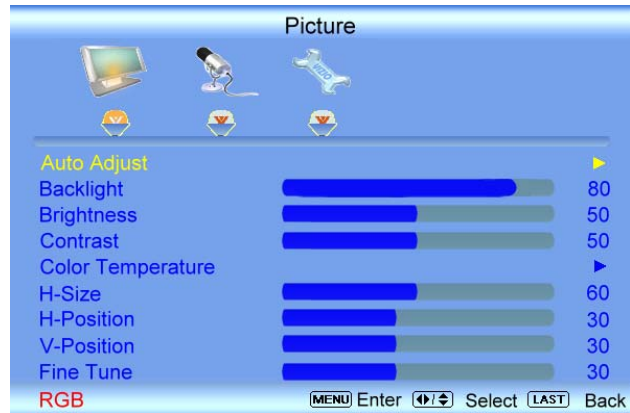

3.13.2 Backlight

Press the  button to highlight the Backlight selection.

Press the  button to start adjusting the brightness of the Backlight and the menu page will disappear and be replaced by a small Backlight Indicator Bar so you can see the light level between the minimum and maximum available levels.

Use the  or  button to adjust the level.

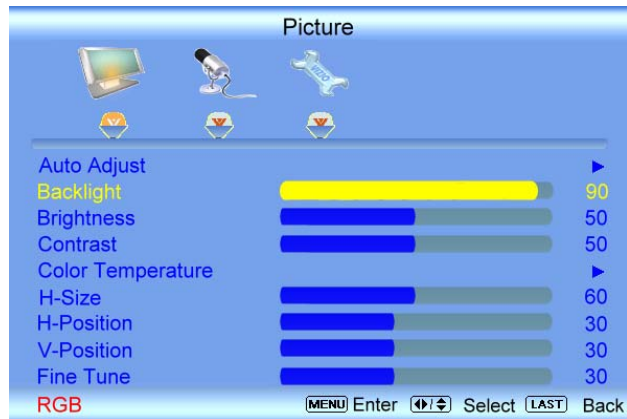

The Backlight level does not affect the Brightness (black level) or Contrast (white level) of the picture, it adjusts the lamp current and this affects the overall brilliance of the picture.



Press the **LAST** key once to return to the previous screen or repeatedly to return to your program if task has been completed.



3.13.3 Brightness

Press the  button to highlight the Brightness selection.

Press the  button to start adjusting the brightness and the menu page will disappear and be replaced by a small Brightness Indicator Bar so you can see the brightness level between the minimum and maximum available levels.

Use the  or  button to adjust the level.

Press the **LAST** key once to return to the previous screen or repeatedly to return to your program if task has been completed.





The Brightness adjusts the black levels in the picture. If the brightness is too low you will not be able to see the detail in darker parts of the picture and if the brightness is too high the picture will look washed out.

Press the **LAST** key once to return to the previous screen or repeatedly to return to your program if task has been completed.

3.13.4 Contrast

Press the  button to highlight the Contrast selection.

Press the  button to start adjusting the contrast and the menu page will disappear and be replaced by a small Contrast Indicator Bar so you can see the contrast level between the minimum and maximum available levels.

Use the  or  button to adjust the level.



The Contrast adjusts the white levels in the picture. If the contrast is too low the picture will look washed out and if the contrast is too high you will not be able to see any detail in the bright parts of a picture.



Press the **LAST** key once to return to the previous screen or repeatedly to return to your program if task has been completed.



3.13.5 Color Temperature

Press the  button to highlight the option for Color Temperature selection.

The default is COOL; this is the 9300K setting.

Press the  or  button if you want to choose the Normal, Warm or Custom option.

If you choose the Custom option, then a new menu will be displayed showing the primary color items, Red, Green and Blue.

Press the  button to highlight the color you wish to adjust.

Press the  button to start adjusting the color and the menu page will disappear and be replaced by a small Color (Red, Green or Blue) Indicator Bar as before.

Use the  or  button to adjust the color.

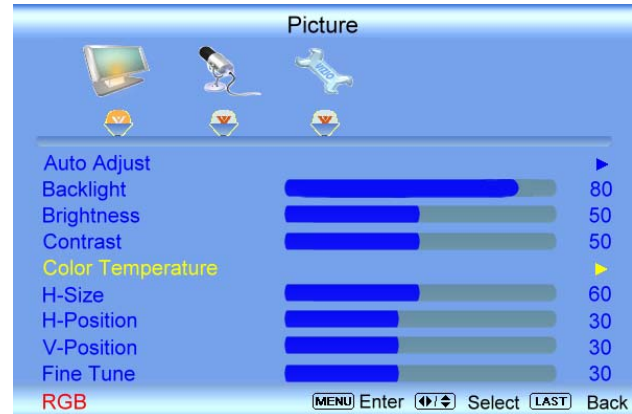

Press the **LAST** key once to return to the previous screen or repeatedly to return to your program if task has been completed.



3.13.6 H-SIZE

Press the  button to highlight the H-Size selection.

Press the  button to start adjusting the horizontal size of the picture.

Use the  or  button to adjust the horizontal size.

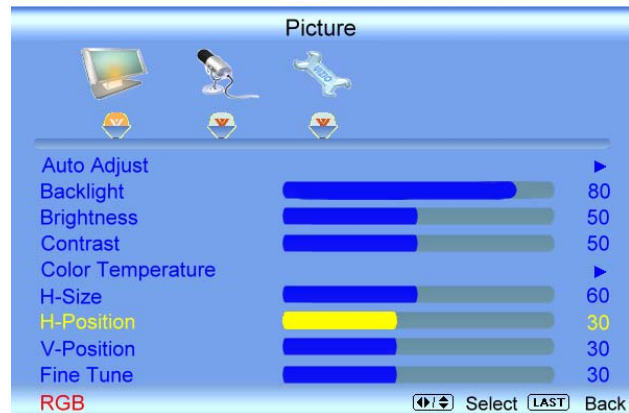

Press the **LAST** key once to return to the previous screen or repeatedly to return to your program if task has been completed.



3.13.7 H-Position

Press the  button to highlight the Horizontal Shift selection.





Press the  button to start adjusting the horizontal position of the picture.

Use the  or  button to adjust the horizontal position.





Press the **LAST** key once to return to the previous screen or repeatedly to return to your program if task has been completed.



3.13.8 V. Position

Press the  button to highlight the Vertical Shift selection.
 Press the  button to start adjusting the vertical position of the picture.
 Use the  or  button to adjust the vertical position.
 Press the **LAST** key once to return to the previous screen or repeatedly to return to your program if task has been completed.

3.13.9 Fine Tune

Press the  button to highlight the Fine Tune selection.
 Press the  button to start tuning the to the PC signal.
 Use the  or  button to adjust the tuning.
 Press the **LAST** key once to return to the previous screen or repeatedly to return to your program if task has been completed.

3.14 PC Input Audio Adjustment

The Audio Adjust menu operates in the same way for the PC Input as for the DTV / TV input in section 3.3. The menu difference is that there are no icons along the top for DTV / TV and Parental Control adjustments.

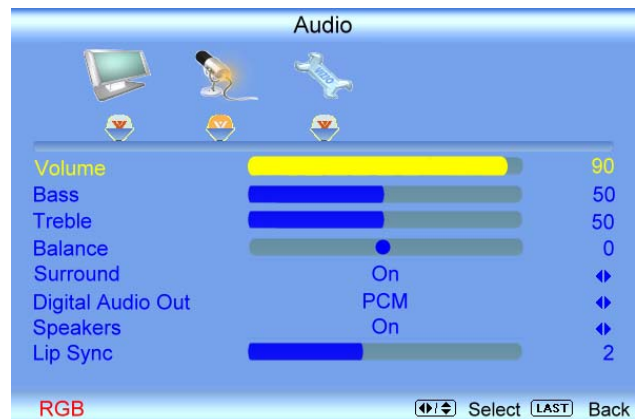

3.15 PC Input Setup

The Setup menu operates in the same way for the PC Input as for the DTV / TV input in section 3.4. The menu difference is that there is no icon along the top for TV adjustments and no Closed Caption.



3.16 Understanding Viewing Features

Your HDTV features the following viewing modes, see page 34 for details.

3.16.1 Viewing Modes

Normal Mode

The original 4:3 aspect ratio (1.33:1 source) is preserved, so black bars are added to the left and right of the display image. Standard TV broadcasts are displayed with a 4:3 Aspect Ratio. Movies in 4:3 Aspect Ratio may be referred to as pan-and-scan or full frame. These movies were originally filmed in 16:9 (widescreen), and then modified to fit a traditional TV screen (4:3).

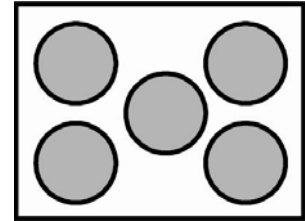

Wide Mode

When watching a standard broadcast or full-frame movie in this mode, the display image is stretched proportionately to fill the TV screen.

When watching a widescreen (1.78:1 source) program or movie, the display image fills the TV screen. If you are watching a widescreen (1.85:1 or 2.35:1 source) program or movie, there will still be black bars at the top and bottom.

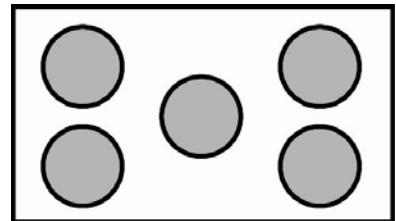

Stretch Mode

When watching a widescreen program (1.78:1 source) with black bars on the sides, the display image will stretch to fill the TV screen. If you are watching a widescreen (1.85:1 or 2.35:1 source) program or movie, there will still be black bars at the top and bottom.

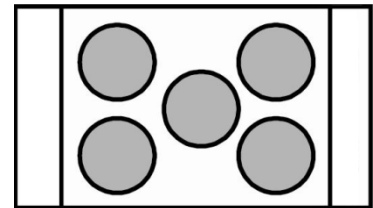

This mode is available only when watching a widescreen program.

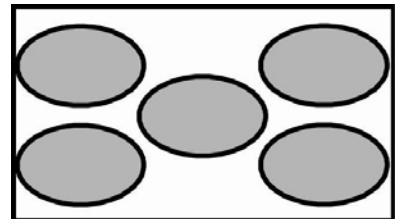

When watching a standard definition 4:3 aspect ratio (1.33:1 source) the picture will fill the screen but will be stretched horizontally; people will look fatter than they are.

Panoramic Mode

When watching a standard broadcast or full frame movie in this mode, the 4:3 Aspect Ratio (1.33:1 source) display image is stretched horizontally on the left and right sides to fill the TV screen. The center of the image is not stretched.

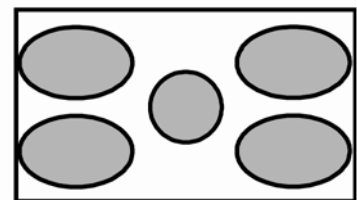

3.17 Using a Cable or Satellite Remote

Your VIZIO remote uses codes 11758 and 10178 to work your LCD HDTV. To use a cable or satellite remote to work the LCD HDTV, refer to your cable or satellite remote user guide for more information on how to program the remote. If your cable or satellite remote uses a 5-digit code (like most Direct TV units), first try 11758 and then, if that does not work, 10178. If your cable or satellite remote uses a 4-digit code, try 1758 and then 0178 as an alternative. If your cable or satellite remote uses a 3-digit code (EchoStar or Dish Network for example), use code 627.

Note: Some buttons may not function as expected on your cable or satellite remote. Typically power, volume and mute will work.

Chapter 4 Maintenance and Troubleshooting

4.1 Maintenance

Important

1. Make sure that the power cable is removed from the socket before cleaning the TV.
2. Do not use volatile solvent (such as toluene, rosin and alcohol) to clean the TV. Such chemicals may damage the housing, screen glass and remote control, and cause paint to peel.

Cleaning the Housing and Remote Control

1. Use a soft cloth for cleaning.
2. If the housing or remote control is seriously contaminated, use a soft cloth moistened with diluted neutral cleaner to clean the display. Wring water out of the cloth before cleaning to prevent water from penetrating into the housing. Wipe the display with a dry cloth after cleaning.

Cleaning the Screen

1. Use a soft cotton cloth to gently clean the screen.
2. The screen glass is very fragile. Do not scrape it with any sharp object. Do not press or tap the screen to avoid cracking. When the screen is seriously contaminated, use a soft cloth moistened with diluted neutral cleaner to clean the display. Wring water out of the cloth before cleaning to prevent water from penetrating into the housing. Wipe the display with a dry cloth after cleaning.



4.2 TV and Stand Base Assembly

If the original instructions had been misplaced or lost, the following steps are a duplicate of such document, removing the Stand Base may be the only steps to be done at this point.

NOTE: It is strongly recommended that two people perform the setup and assembly due to the weight and size of the TV.

To unpack the TV and stand base

The following steps are required to assemble the two parts:

1. Remove the remote control, batteries, and power cord from the foam end caps.
2. Remove the two top foam end caps.
3. Remove the stand base under foam end cap.
4. Remove the TV from the box and lay it face down on a clean, flat surface.

Stand Neck

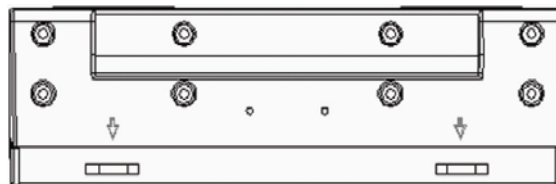

Note: Make sure that the surface is free of debris to prevent the TV screen from getting scratched.

Stand Base

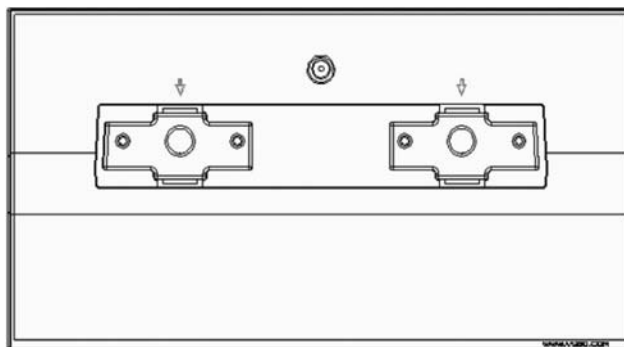

To attach the TV stand base:

1. Line up the arrows on the stand neck (attached to the TV) with the arrows on the stand base.
2. Push the stand base onto the stand neck until you hear them click together.
3. On the bottom of the base, insert the four included screws and tighten them up.
4. Move the TV into an upright position.

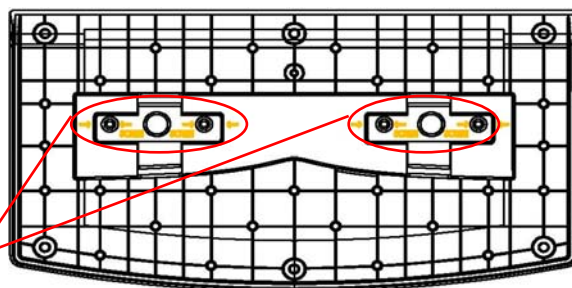

To remove the stand base

1. Remove the four screws from the stand base.
2. Pull the stand base away from the stand neck.



4.3 Troubleshooting Guide

If the TV fails or the performance changes dramatically, check the display in accordance with the following instructions. Remember to check the peripherals to pinpoint the source of the failure. If the display still fails to perform as expected, contact the VIZIO for assistance by calling 1-(877) 698-4946 or e-mail us at techsupport@vizio.com.

Problem	Solution
No power.	<p>Make sure the power button is ON (White VIZIO Logo).</p> <p>Make sure AC power cord is securely connected to the AC socket.</p> <p>Plug another electrical device (like a radio) to the power outlet to verify that the outlet is supplying the proper voltage.</p>
No sound.	<p>Check your audio connection</p> <p>Press MUTE on the remote control, so that mute symbol disappears from the screen</p> <p>Check your audio settings, your TV audio may be set to SAP, min or speakers off</p> <p>Press the Volume + (Up) key on your remote control</p> <p>Make sure that headphones are not connected</p>
If the screen is black.	Check your input connections.
Power is ON but no screen image.	<p>Make sure the video cable supplied with the TV is secured to the correct video output port on the back of the VCR and the TV. Make any cable you have attached to the TV is secured to the correct output your Set-Top Box, DVD, etc.</p> <p>Adjust brightness and contrast.</p> <p>Check Source settings.</p>
Wrong or abnormal colors appear.	If any colors (red, green, or blue) are missing, check the video cable to make sure it is securely connected.
Control buttons do not work.	Press only one button at a time.
Remote Control does not work.	<p>Make sure batteries are inserted correctly</p> <p>Batteries could be weak.</p>
There appears to be image quality issues.	For best image quality, view HD wide screen programs where possible. If HD content is not available view "Standard Definition" from a digital source. Standard, analog TV will always be noticeably inferior to HD because your digital flat panel TV has video that is many times better than old TV's and so you can see interference and deficiencies you did not know you had.
You cannot see a picture.	<p>Make sure that the power cord is plugged into a grounded electrical outlet.</p> <p>Make sure that the power button is turned on.</p> <p>Make sure that the selected input source is connected to a working input source.</p> <p>If your TV is connected to your computer in RGB or HDMI mode, press any key on your keyboard to "wake" your computer.</p>
You see a distorted picture or hear unusual sound.	You may be getting interference from electrical appliances, cars, motorcycles, or fluorescent lights. If you have not mounted it on the wall, try moving your TV to another location to see if this is the cause of the problem.
The picture has abnormal patterns.	<p>Make sure that the input source cable is attached securely and correctly to the back of your TV.</p> <p>Make sure that the video input source is within the range of your TV. Compare the video input source's specifications with your TV specifications.</p>
The display image does not cover the entire screen.	If you are using RGB mode, make sure that H Size and V Position in the On Screen Display (OSD) are set correctly.



Problem	Solution
	If you are using TV, AV-C, AV-S or Component with 480i input, follow steps on page 33 on how to set the WIDE screen modes.
You can see a picture but you cannot hear sound.	Make sure that the volume is not turned down. Make sure that the sound is not muted. Make sure that your audio input source cables are connected securely and correctly.
The TV has pixels that are always dark or colored.	Your LCD HDTV is manufactured using an extremely high level of precision technology, however, sometimes some pixels of your LCD HDTV may not display. Pixel defects within industry specifications are inherent to this type of product and do not constitute a defective product.
You see "noise" or "trash" on the screen.	When your LCD HDTV's digital capabilities exceed a digital broadcast signal, the signal is up-converted (increased) to match your TV's display capabilities. Up-converting can cause noise or trash.
You switch to a different input and the volume changes.	The TV remembers the volume level from the last time you adjusted it. If the sound level is higher or lower from another source, then the loudness will change.
You switch to a different input and the screen size changes.	The TV remembers the viewing mode from the last time you used a particular input (AV, Component, HDMI and TV).
Tips for High-Definition Users.	The LCD HDTV is an ideal platform for viewing High Definition Content. Best Image Quality will be achieved by the HDMI Input, then YPbPr, then RGB. However, due to variances in broadcast practices, it is possible some image distortions can occur.
Tips for Letterbox Content Users.	Letterboxed (or "Widescreen") versions of DVD movies are most commonly formatted for standard 4:3 Televisions. The LCD HDTV has the capability of expanding this content so the entire screen is filled at the expense of image accuracy. To use this function follow the instructions given in page 34.

4.4 Telephone & Technical Support

Products are often returned due to a technical problem rather than a defective product that may result in unnecessary shipping charges billed to you. Our trained support personnel can often resolve the problem over the phone. For more information on warranty service or repair, after the warranty period, please contact our Support Department at the number below.

Customer support and quality service are integral parts of VIZIO's commitment to service excellence.

For technical assistance contact our VIZIO Technical Support Department via email or phone.

E-mail: techsupport@vizio.com

Tel: (877) 698-4946 Fax: (949) 585-9563

Hours of operations:

6:00am – 9:00pm PST Monday – Friday

8:00am – 4:00pm PST Saturday – Sunday

Please have your VIZIO model number, serial number and date of purchase available before you call.

VIZIO

39 Tesla, Irvine, CA 92618. USA

Tel: (949) 428-2525 Fax: (949) 585-9514

Web: www.VIZIO.com



4.5 Compliance

Caution: Always use a power cable that is properly grounded. Please use the AC cords listed below for each area.

USA	UL
Canada	CSA
Germany	VDE
UK	BASE/BS
Japan	Electric Appliance Control Act

4.6 FCC Class B Radio Interference Statement

NOTE: This equipment has been tested and found to comply with the limits for a Class B digital device, pursuant to Part 15 of the FCC Rules. These limits are designed to provide reasonable protection against harmful interference in a residential installation. This equipment generates, uses and can radiate radio frequency energy, and if not installed and used in accordance with the instructions, may cause harmful interference to radio communications. However, there is no guarantee that interference will not occur in a particular installation. If this equipment does cause harmful interference to radio or television reception, which can be determined by turning the equipment off and on, the user is encouraged to try to correct the interference by one or more of the following measures:

1. Reorient or relocate the receiving antenna.
2. Increase the separation between the equipment and receiver.
3. Connect the equipment into an outlet on a circuit different from that to which the receiver is connected.
4. Consult the dealer or an experienced radio/TV technician for help.

Notice:

1. The changes or modifications not expressly approved by the party responsible for compliance could void the user's authority to operate the equipment.
2. Shielded interface cables and AC power cord, if any, must be used in order to comply with the emission limits.
3. The manufacturer is not responsible for any radio or TV interference caused by unauthorized modification to this equipment. It is the responsibilities of the user to correct such interference.



Chapter 5 Miscellaneous Information

5.1 Specifications

Specifications	Product specifications may change without notice or obligation.
Panel	32" (31.5" Diagonal viewing area), 16:9 Aspect Ratio
Resolution	1366 x 768 pixels
Pixel (Dot) Pitch	0.5107mm (H) x 0.5107mm (V)
Display Compatibility	720P (HDTV)
Colors	16.7 Million (8-bit)
Brightness	500 cd/m ² (typical)
Contrast	1100:1 (typical), 5500:1 (w/ DCR)
Response Time	8ms (typical)
Viewing Angle	Up to 178° (horizontal and vertical)
Inputs	1x Co-axial RF (ATSC/QAM/NTSC), 2x HDMI™ (v1.3) with HDCP (plus 1x Stereo Audio RCA for DVI source), 2x Component YPbPr plus Stereo Audio, 1x RGB PC plus Stereo Audio, 1x S-Video (AV) plus Stereo Audio, 1x Composite Video (AV)
Outputs	1x Digital Optical Audio
Features	HDMI v1.3, 720P HDTV, Dynamic Contrast Ratio technology, Noise reduction, MTS stereo decoder, Dolby Digital for ATSC/QAM, Channel skip, Video/input naming capability, Closed caption, Parental control/V-Chip 2.0, Virtual surround sound, ATSC/Clear QAM tuner, NTSC video decoding via RF or Composite video, 3:2 or 2:2 reverse pull-down, Motion adaptive de-interlace, Progressive video scan via Component video/VGA/HDMI, HDTV via HDMI or Component video, Color temperature adjustments of 5400K/6500K/9300K, Independent Red/Green/Blue adjustments for color temperature fine tuning, TV Signal Compatibility 480i (SDTV), 480P (EDTV), 720P (HDTV), 1080i (HDTV) and 1080P (FHDTV), Computer support at 640x480/800x600/1024x768/1366x768 via VGA/HDMI
Speakers	Built-in, 10W x 2
Panel Life	50,000 hours to half the original brightness
Power	
Input	IEC Connector for direct power line connection
Voltage Range	120VAC at 50/60Hz
Power Consumption	104W (Avg) <0.4W standby.
Environmental Conditions	
Operating	Temperature: 5°C~35°C, Relative Humidity: 20~80%, Altitude: 0~14,000 ft
Non-Operating	Temperature: -20°C~50°C, Relative Humidity: 10~90%, Altitude: 0~40,000 ft
Dimensions	31.38" W x 23.54" H x 8.96" D (797mm x 598mm x 228mm) with stand; 31.38" W x 22.13" H x 3.94" D (797mm x 562mm x 100mm) without stand
Net Weight	30.64 lbs (13.9kg) with stand; 28.51 lbs (12.9kg) without stand
Gross Weight	37.70lbs (17.1kg)
Certifications	CSA/CSA-US, FCC Class B



5.2 Glossary - Standard Definitions

Analog TV: Today's TV system using radio frequency waves to transmit and display pictures and sound.

Aspect Ratio (4x3): Traditional TV "aspect ratio", that is, the screen's width as compared to its height. For example, a "32 inch TV screen" would be 25 inches wide and 19 inches tall.

Aspect Ratio (16x9): "Wide screen TV" aspect ratio which is more like a movie screen than a traditional TV. For example, a "32 inch TV screen" would be 28 inches wide and 16 inches tall.

Digital TV (DTV): Television delivered and displayed using radio frequency waves that contain information that is digitally encoded for improved quality and efficiency.

Enhanced Definition TV (EDTV): A better digital television transmission than SDTV with at least 480P, in a 16x9 or 4x3 display and Dolby digital surround sound. 480P is the quality used by most DVD players. EDTV provides 300-400,000 pixels.

HDTV Monitor (sometimes called HDTV Ready): A set that can display HDTV programming if you have a separate HDTV tuner, HD Cable Set-Top Box or HD Satellite Set-Top-Box Receiver.

HDTV Tuner (also decoder, receiver, set-top box): A device capable of receiving and outputting HDTV signals for display. It may be stand-alone or integrated in the set.

High-Definition Television (HDTV): The best quality picture, wide screen (16x9) display with at least 720 progressively scanned lines (720P) or 1080 interlaced lines (1080i) and Dolby digital surround sound. HDTV provides 900,000-2.1 million pixels.

Integrated HDTV: An HDTV that has the digital tuner built into the set. It does not need a separate set-top box to receive over-the-air DTV signals.

Interlace Scan: A way to scan vertical lines onto a TV picture by scanning all the odd lines first, then filling the in the even lines (this happens instantaneously).

Plug-and-Play or Digital Cable Ready: A DTV or other device for digital cable consumers that plugs directly into the cable jack and does not require a separate set-top box. Plug-and-Play TV owners must obtain a Cable CARD from their cable company in order to view scrambled programming services.

Progressive Scan: A way to scan vertical lines onto a TV picture by scanning all the lines consecutively (progressively).

Standard Definition TV (SDTV): Basic digital television transmission that may be displayed with fewer than 480 progressively scanned lines (480P) in 16 x 9 or 4 x 3 format. 480 interlaced (480i) is the quality of today's analog TV system.

Source: Buying a Digital Television, CEA, HDTV Guide, 2005

Note: The Federal Communications Commission (FCC), the Consumer Electronics Association (CEA) and the Consumer Electronics Retailers Coalition (CERC) have made a new tip sheet available for digital television (DTV) retailers to reproduce and distribute to consumers on the sales floor. The file may be downloaded online at www.dtv.gov. While you're there, check out the other useful information in the FCC is making available to consumers interested in learning more about the analog to digital transition.



5.3 Index

A

- Accessories, 4, 5
- Adjustments
 - Channel, 9, 11
 - Channels, 34
 - Selecting the Screen Size, 34, 64, 71
 - Volume, 9, 11, 34, 67
 - Volume, 43
- Advanced Video Features
 - Adaptive Luma, 42
 - Black Level Extender, 41
 - CTI (Color Transient Improvement), 42
 - DNR (Dynamic Noise Reduction), 41
 - Dynamic Contrast Ratio (DCR), 42
 - Flesh Tone, 42
 - White Peak Limiter, 41

C

- Cleaning your VIZIO TV, 65
- Coax (RF)
 - Connecting for DTV, 14
 - Connecting your Basic Set Top Box, 18
- Component
 - Connecting your DVD Player, 21
 - Connecting your HDTV Set-Top Box, 17
- Composite (AV)
 - Connecting your Basic Set-Top Box, 18
 - Connecting your DVD Player, 22
- Controls
 - Front Panel, 9
 - Side Panel, 9

D

- DTV
 - Audio Adjustment, 43
 - Input Setup, 48
 - Parental Control, 52
 - Picture Adjustment, 37
 - Tuner Setup, 46
- DTV Audio Adjust
 - Balance, 44
 - Bass, 43
 - Digital Audio Out, 45
 - Lip Sync, 45
 - Simulated Surround Sound, 44
 - Speakers On/Off, 45
 - Treble, 44
 - Volume, 43
- DTV Input Setup
 - Closed Caption, 50
 - Language, 48
 - Reset, 51
 - Sleep Timer, 48

- DTV Picture Adjust
 - Advanced Video, 41
 - Backlight, 38, 60
 - Brightness, 38, 61
 - Color, 39
 - Color Temperature, 40, 62
 - Contrast, 39, 61
 - Picture Mode, 37
 - Sharpness, 40
 - Tint, 39
- DTV Tuner Setup
 - Auto Search, 46
 - Daylight Saving, 47
 - Skip Channel, 46
 - Time Zone, 47
 - Tuner Mode, 46
- DVI
 - Connecting your DVD Player, 20
 - Connecting your HDTV Set-Top Box, 16

G

- Glossary, 71

H

- HDMI
 - Connecting your DVD Player, 19
 - Connecting your HDTV Set-Top Box, 15
- HDMI Input
 - Audio Adjustment, 57
 - Picture Adjustment, 57
 - Setup, 57

I

- Inputs
 - Antenna, 3
 - Connectors, 13
 - Rear Label, 10
- Installation
 - Base removal, 6
 - Preparation, 5
 - Wall Mounting, 5, 6, 27

O

- OSD
 - Brightness Adjustment, 70
 - Color Adjustment, 13
 - Contrast Adjustment, 70
- Outputs
 - Using 5.1 Surround with a Home Theatre System, 24



P

- Parental Control
 - Block Unrated Programming, 56
 - Canadian English Rating, 54
 - Canadian French Rating, 55
 - Channel Block, 52
 - Check for New DTV Rating, 55
 - Movie Rating, 54
 - Password change, 56
 - TV Rating, 53
- PC Input
 - Audio Adjustment, 63
 - Picture Adjustment, 60
 - Setup, 63
- PC Picture Adjust
 - Auto Adjust, 60
 - Fine Tune, 63
 - Horizontal Position, 62
 - Horizontal Size, 62
 - Vertical Position, 63
- PC Resolutions, 26

R

- Remote, 11
 - Batteries, 12
 - Range, 12
- Remote Control
 - Using your Cable or Satellite Remote to Operate your VIZIO TV, 65
- RGB
 - Connecting your PC, 25

S

- Screen Size explanation, 64
- S-Video
 - Connecting your DVD Player, 22
 - Connecting your VCR, 23
 - Connecting your Video Camera, 23

T

- Technical Specifications, 70, 71
- Troubleshooting Guide, 67
- TV
 - Audio Adjustment, 43
 - Input Setup, 48

- Parental Control, 52
- Picture Adjustment, 37
- TV Audio Adjust
 - Balance, 44
 - Bass, 43
 - Digital Audio Out, 45
 - Simulated Surround Sound, 44
 - Speakers On/Off, 45
 - Treble, 44
 - Volume, 43
- TV Input Setup, 48
 - Closed Caption, 50
 - Input Naming, 49
 - Sleep Timer, 48
 - Wide, 48
- TV Picture Adjust
 - Advanced Video, 41
 - Backlight, 38, 60
 - Brightness, 38, 61
 - Color, 39
 - Color Temperature, 40, 62
 - Contrast, 39, 61
 - Picture Mode, 37
 - Sharpness, 40
 - Tint, 39
- TV Special Features
 - System Reset, 51
- TV Tuner Setup, 46
 - Auto Search, 46
 - Skip Channel, 46
 - Tuner Mode, 46

V

- Video Input
 - Audio Adjustment, 58
 - Parental Control, 59
 - Picture Adjustment, 58
 - Setup, 59

W

- Watching TV
 - Basic Adjustments, 34
 - Basic connections, 27
 - First Startup, 27
 - Getting your Programs, 33
 - Program Information, 35
 - Status Information, 35



VIZIO LIMITED PRODUCT WARRANTY

VIZIO provides a "ONE-YEAR LIMITED WARRANTY" against manufacturing defects in materials and workmanship to the original purchaser of a new VIZIO display purchased from an authorized VIZIO U.S. reseller and used in the fifty (50) United States or Puerto Rico.

VIZIO's Responsibility

VIZIO displays purchased new from an authorized VIZIO U.S. reseller and that are used in the fifty (50) United States or Puerto Rico are warranted to be free from manufacturing defects in materials and workmanship for one (1) year from the date of the original retail purchase. If the display fails to conform to this limited warranty, VIZIO will, at its option and sole discretion, repair or replace the display.

Labor

During the one-year limited warranty period, VIZIO will provide, when needed, service labor to repair a manufacturing defect. Repairs required on displays which are thirty (30) inches and larger generally will be made "on-site" where the display is installed. The determination for performing the on-site repair is dependent upon the manufacturing defect and is at VIZIO's option and sole discretion. Repairs required on displays which are less than thirty (30) inches generally will be performed at a VIZIO service center.

Parts

Repairs may be made with new or recertified parts, or the entire unit may be replaced with a new or recertified unit, at VIZIO's option and sole discretion. Replacement parts or replacement units provided under this limited warranty are warranted for the remaining portion of the original warranty period, or for ninety (90) days from warranty service or replacement, whichever is later.

How to Obtain Warranty Service

To obtain warranty service, contact VIZIO Technical Support via email at TechSupport@VIZIO.com, via phone at 877-MYVIZIO (877-698-4946), or via postal mail at VIZIO Technical Support, 39 Tesla, Irvine, CA 92618. You must provide the model, serial number, and date of purchase. VIZIO Technical Support is available from 6:00AM to 9:00PM Pacific Time, Monday through Friday, and 8:00AM to 4:00PM Pacific Time, Saturday and Sunday. Please note that holiday hours may vary. For up to date information, please visit www.VIZIO.com.

VIZIO reserves the right to assess all warranty claims and to determine if defects or damages are covered by this limited warranty. In case of a claim that is not covered by this warranty, you will be contacted to determine whether VIZIO should repair the damage for a fee or whether the product should be returned to you as received by the service technician or service center.

Parts and service labor that are VIZIO's responsibility under this limited warranty will be provided without charge. All other service is at the customer's expense. VIZIO reserves the right to charge the customer for any service call for anything not covered by this limited warranty. Before you ask for warranty service, please review your User Manual. You may avoid a service call and a service charge.

Please refer to the reverse side of this page for additional information regarding how to obtain warranty service.

PLEASE DO NOT RETURN YOUR UNIT TO VIZIO WITHOUT PRIOR AUTHORIZATION.

What Is Not Covered

This limited warranty does not cover the following: cosmetic defects; damage, malfunctions or failures resulting from shipping or transit, improper or faulty installation, abuse, operation contrary to furnished instructions, operation on incorrect power supplies, products not supplied by VIZIO, modification, alteration, improper servicing or tampering; damage from fire, water, lightning, power surges, abnormal environmental conditions or other acts of nature; normal wear and tear; unsatisfactory visual or audio performance not caused by a manufacturing defect; or displays with a missing or unreadable serial number. Operation of the



display for commercial purposes or in applications or uses for which the display is not intended is not covered by this limited warranty. "Image Sticking", caused by static images on the screen for extended periods and or excessive brightness and contrast levels, is not covered by this limited warranty. Installation, removal, transportation and reinstallation of a display, and routine maintenance and cleaning, are not covered by this limited warranty.

THERE ARE NO EXPRESS WARRANTIES OTHER THAN THOSE LISTED OR DESCRIBED ABOVE. ANY IMPLIED WARRANTIES, INCLUDING ANY IMPLIED WARRANTY OF MERCHANTABILITY AND FITNESS FOR A PARTICULAR PURPOSE, SHALL BE LIMITED IN DURATION TO THE PERIOD OF TIME SET FORTH ABOVE. VIZIO'S TOTAL LIABILITY FOR ANY AND ALL LOSSES AND DAMAGES RESULTING FROM ANY CAUSE WHATSOEVER, INCLUDING VIZIO'S NEGLIGENCE, ALLEGED DAMAGE, OR DEFECTIVE GOODS, WHETHER SUCH DEFECTS ARE DISCOVERABLE OR LATENT, SHALL IN NO EVENT EXCEED THE PURCHASE PRICE OF THE DISPLAY. VIZIO SHALL NOT BE RESPONSIBLE FOR LOSS OF USE, COMMERCIAL LOSS, LOST REVENUE OR LOST PROFITS, OR OTHER INCIDENTAL OR CONSEQUENTIAL DAMAGES. SOME STATES DO NOT ALLOW LIMITATIONS ON HOW LONG AN IMPLIED WARRANTY LASTS OR THE EXCLUSION OR LIMITATION OF INCIDENTAL OR CONSEQUENTIAL DAMAGES, SO THE ABOVE LIMITATIONS OR EXCLUSIONS MAY NOT APPLY TO YOU.

This warranty gives you specific legal rights, and you may also have other rights, which vary from state to state. This is the only warranty applicable; no one is authorized to extend or modify it or to grant any other warranty on VIZIO's behalf.

Owner's Responsibility

To ensure warranty service, keep the dated bill or sales receipt as evidence of the purchase date and location. This limited warranty applies only to original purchaser and is non-transferable.

Warranty service conditions are subject to change. For the latest Warranty Terms and Conditions and additional information regarding VIZIO's Limited Product Warranty, please see complete details online at www.VIZIO.com.



VIZIO RETURN POLICY

VIZIO's return policy allows for products purchased directly from VIZIO to be returned by the original purchaser during the initial thirty (30) day period following the date of purchase. A VIZIO return authorization number must first be obtained as provided below. The refund will be the purchase price actually paid by the purchaser less a ten percent (10%) restocking fee per each item returned. Shipping and handling are not refundable.

The return authorization number must first be obtained from VIZIO's Customer Service by emailing CustomerSupport@VIZIO.com or by calling 949-428-2525, 6:00AM to 9:00PM Pacific Time, Monday through Friday, and 10:00AM to 2:00PM Pacific Time, Saturday and Sunday. Please note that holiday hours may vary. For up to date information, please visit www.VIZIO.com.

Products must be returned to the address specified by VIZIO Customer Service and must be shipped in the original packaging, with freight prepaid to VIZIO, and must be received in new and unused condition. The return authorization number must be included in the packaging. VIZIO reserves the right to assess fees for any damaged or missing parts in addition to the ten percent (10%) restocking fee.

Return authorization numbers are valid for only fifteen (15) days from issuance. The customer is responsible for and must prepay all shipping charges and shall assume all risk of loss or damage to the product while in transit to VIZIO. If the product is returned to VIZIO (i) without a VIZIO return authorization number, and/or (ii) beyond the fifteen (15) day period, and/or (iii) without proper packaging, VIZIO retains the right to refuse delivery of such return or may return the unit to the customer at the customer's expense and with no refund issued. This return policy does not apply to defective products. Please read VIZIO's Limited Product Warranty for warranty terms and conditions.

ON-SITE WARRANTY REPAIR PROCEDURE

On-Site Warranty Repair generally is performed on repairable displays which are 30 inches and larger.

If VIZIO Technical Support determines that a problem with a display unit may be within the terms and conditions of the VIZIO Limited Product Warranty and that an on-site repair may be performed, the customer will be provided with an on-site repair authorization number and on-site repair instructions. The determination for performing the on-site repair may be dependent upon the manufacturing defect and is at VIZIO's option and sole discretion. Proof of purchase is required to confirm the product is within the one-year limited warranty period and meets the terms and conditions of the VIZIO Limited Product Warranty.

On-site repair service is requested through VIZIO's third-party service provider. After VIZIO provides the customer with the on-site repair (OSR) authorization number, the third-party service provider will contact the customer and will schedule the repair at the customer's location. The total approximate time for the repair process, which includes the repair diagnosis, dispatching the technician, shipping the replacement part(s), and arranging the appointment with the customer, is completed within approximately 3 to 5 business days, pending availability of these factors.

If it is determined the product can not be repaired on-site, the customer will be required to ship the unit to VIZIO's service center, per the below warranty replacement procedure.

VIZIO is not responsible for the de-installation or re-installation of the product. However, some standard installation may be performed during the on-site repair, at VIZIO's option and sole discretion. Please read VIZIO's Limited Product Warranty for warranty terms and conditions.

WARRANTY REPLACEMENT PROCEDURE



Warranty Replacement generally is performed on displays which are determined to be economically unrepairable.

If VIZIO Technical Support determines that a problem with a display unit may be within the terms and conditions of the VIZIO Limited Product Warranty and that a repair is not economically possible, based on certain manufacturing defects in materials and/or workmanship, and/or at VIZIO's option and sole discretion, the customer will be provided with a return authorization number and replacement instructions. Proof of purchase is required to confirm the product is within the one-year limited warranty period and meets the terms and conditions of the VIZIO Limited Product Warranty.

For displays forty-two inches (42") and larger, VIZIO will generally cover the transportation charges to perform an on-site swap of the original unit with the replacement unit. For displays under forty-two inches (42"), the customer is responsible for the transportation charges to VIZIO's service center. VIZIO will be responsible for the return transportation charges from the service center to the customer. Please read VIZIO's Limited Product Warranty for warranty terms and conditions.

MAIL-IN WARRANTY REPAIR PROCEDURE**Mail-In Warranty Repair generally is performed on displays which are smaller than 30 inches.**

If VIZIO Technical Support determines that a problem with a display unit may be within the terms and conditions of the VIZIO Limited Product Warranty and that a mail-in repair may be performed, the customer will be provided with a return authorization number and mail-in repair instructions. Proof of purchase is required to confirm the product is within the one-year limited warranty period and meets the terms and conditions of the VIZIO Limited Product Warranty.

The customer will be provided with instructions for packing and shipping the unit to the VIZIO service center. The original carton box and packing material, or an equivalent as designated by VIZIO, must be utilized. The cost of shipping to VIZIO's service center is at the customer's expense. After the product is repaired and tested, the VIZIO service center will ship the unit back to the customer at VIZIO's expense. VIZIO is not responsible for the de-installation or re-installation of the product. Please read VIZIO's Limited Product Warranty for warranty terms and conditions.

PLEASE DO NOT RETURN YOUR UNIT TO VIZIO WITHOUT PRIOR AUTHORIZATION.

