

VocoPro

ULTIMATE CHOICE OF KARAOKE ENTERTAINMENT

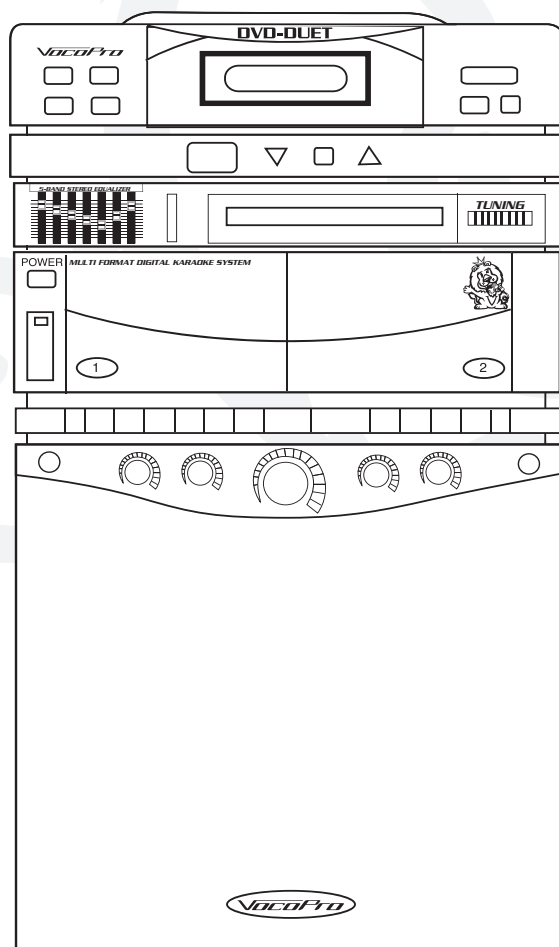

o w n e r ' s m a n u a l

DVD-DUET

Digital Key Control DVD/CD/CDG
Dual Cassette Karaoke System

CONTENTS

INTRODUCTION

Safety Instructions	3
FCC Information	4
Welcome	5
Listening for a Lifetime.....	6
Before Getting Started	7
Front Panel Descriptions	8-9
Rear/Top Panel Descriptions	10
Remote Operations.....	11
Audio Controls	12
Cassette deck operations.....	13
Cassette Tape/Deck Maintenance	14
Connecting to external components	15-17
System setup menu.....	18
Language/audio/video setup menus.....	19
Troubleshooting	20
Specifications	21

FEATURES:

- **40W + 40W Maximum Power Output**
- **Top Loading Digital Shock Resistant DVD/CD/CDG Player**
- **Dual Casstee Decks Tto Play and Record Live Performances Mixes from CD or Cassette**
- **AM/FM Stereo Tuner**
- **12-Step Digital Key Controller (half-steps)**
- **Professional Digital Echo**
- **Two Microphone inputs with Individual Volume Controls**
- **5-Band Graphic Equalizer**
- **Stereo 4-Speaker System**
- **PAL/NTSC Switchable**
- **+/- Pitch Control for Customizing CD+G and Tape Playback Speeds, allowing You to Perform at Your Own Pace**



VocoPro

ULTIMATE CHOICE OF KARAOKE ENTERTAINMENT

Safety Instructions



CAUTION RISK OF SHOCK



CAUTION: To reduce the risk of electric shock, do not remove cover (or back). No user-serviceable parts inside. Only refer servicing to qualified service personnel.

Explanation of Graphical Symbols



The lightning flash & arrowhead symbol, within an equilateral triangle, is intended to alert you to the presence of danger.



The exclamation point within an equilateral triangle is intended to alert you to the presence of important operating and servicing instructions.

WARNING

To reduce the risk of fire or electric shock, do not expose this unit to rain or moisture.

1. Read Instructions - All the safety and operating instructions should be read before the appliance is operated.

2. Retain Instructions - The safety and operating instructions should be retained for future reference.

3. Heed Warnings - All warnings on the appliance and in the operating instructions should be adhered to.

4. Follow Instructions - All operating and use instructions should be followed.

5. Attachments - Do not use attachments not recommended by the product manufacturer as they may cause hazards.

6. Water and Moisture - Do not use this unit near water. For example, near a bathtub or in a wet basement and the like.

7. Carts and Stands - The appliance should be used only with a cart or stand that is recommended by the manufacturer.

7 A. An appliance and cart combination should be moved with care. Quick stops, excessive force, and uneven surfaces may cause an overturn.



8. Ventilation - The appliance should be situated so its location does not interfere with its proper ventilation. For example, the appliance should not be situated on a bed, sofa, rug, or similar surface that may block the ventilation slots.

9. Heat - The appliance should be situated away from heat sources such as radiators, heat registers, stoves, or other appliances (including amplifiers) that produce heat.

10. Power Sources - The appliance should be connected to a power supply only of the type described in the operating instructions or as marked on the appliance.

11. Grounding or Polarization - Precautions should be taken so that the grounding or polarization means of an appliance is not defeated.

12. Power-Cord Protection - Power-supply cords should be routed so that they are not likely to be walked on or pinched by items placed upon or against them, paying particular attention to cords at plugs, convenience receptacles, and the point where they exit from the appliance.

13. Cleaning - Unplug this unit from the wall outlet before cleaning. Do not use liquid cleaners or aerosol cleaners. Use a damp cloth for cleaning.

14. Power lines - An outdoor antenna should be located away from power lines.

15. Nonuse Periods - The power cord of the appliance should be unplugged from the outlet when left unused for a long period of time.

16. Object and Liquid Entry - Care should be taken so that objects do not fall and liquids are not spilled into the enclosure through openings.

17. Damage Requiring Service - The appliance should be serviced by qualified service personnel when:

- A. The power supply cord or plug has been damaged; or
- B. Objects have fallen into the appliance; or
- C. The appliance has been exposed to rain; or
- D. The appliance does not appear to operate normally or exhibits a marked change in performance; or
- E. The appliance has been dropped, or the enclosure damaged.

18. Servicing - The user should not attempt to service the appliance beyond that described in the operating instructions. All other servicing should be referred to qualified service personnel.

Note:

To CATV system installer's (U.S.A.): This reminder is provided to call the CATV system installer's attention to Article 820-40 of the NEC that provides guidelines for proper grounding and, in particular, specifies that the cable ground shall be connected as close to the point of cable entry as practical.

FCC INFORMATION (U.S.A.)

1. IMPORTANT NOTICE: DO NOT MODIFY THIS

UNIT!: This product, when installed as indicated in the instructions contained in this manual, meets FCC requirements. Modifications not expressly approved by Vocopro may void your authority, granted by the FCC, to use this product.

2. IMPORTANT: When connecting this product to accessories and/or another product use only high quality shielded cables. Cable(s) supplied with this product **MUST** be used. Follow all installation instructions. Failure to follow instructions could void your FCC authorization to use this product in the U.S.A.

3. NOTE: This product has been tested and found to comply with the requirements listed in FCC Regulations, Part 15 for Class "B" digital devices. Compliance with these requirements provides a reasonable level of assurances that your use of this product in a residential environment will not result in harmful interference with other electronic devices. This equipment generates/uses radio frequencies and, if not installed and used according to the instructions found in the owner's manual, may cause interference harmful to the operation of other electronic devices. Compliance with FCC regulations does not guarantee that interference will not occur in all installations. If this product is found to be the source of interference, which can be determined by turning the unit "Off" and "On", please try to eliminate the problem by using one of the following measures:

Relocate either this product or the device that is being affected by the interference.

Use power outlets that are on different branch (circuit breaker or fuse) circuits or install AC line filter(s).

In the case of radio or TV interference, relocate/reorient the antenna. If the antenna lead-in is 300-ohm ribbon lead, change the lead-in to coaxial type cable.

If these corrective measures do not produce satisfactory results, please contact your local retailer authorized to distribute Vocopro products. If you can not locate the appropriate retailer, please contact Vocopro, 1728 Curtiss Court, La Verne, CA 91750.

CAUTION:

READ THIS BEFORE OPERATING YOUR UNIT

1. To ensure the finest performance, please read this manual carefully. Keep it in a safe place for future reference.
2. Install your unit in a cool, dry, clean place - away from windows, heat sources, and too much vibration, dust, moisture or cold. Avoid sources of hum (transformers, v motors). To prevent fire or electrical shock, do not expose to rain and water.
3. Do not operate the unit upside-down.
4. Never open the cabinet. If a foreign object drops into the set, contact your dealer.
5. Place the unit in a location with adequate air circulation. Do not interfere with its proper ventilation; this will cause the internal temperature to rise and may result in a failure.
6. Do not use force on switches, knobs or cords. When moving the unit, first turn the unit off. Then gently disconnect the power plug and the cords connecting to other equipment. Never pull the cord itself.
7. Do not attempt to clean the unit with chemical solvents: this might damage the finish. Use a clean, dry cloth.
8. Be sure to read the "Troubleshooting" section on common operating errors before concluding that your unit is faulty.
9. This unit consumes a fair amount of power even when the power switch is turned off. We recommend that you unplug the power cord from the wall outlet if the unit is not going to be used for a long time. This will save electricity and help prevent fire hazards. To disconnect the cord, pull it out by grasping the plug. Never pull the cord itself.
10. To prevent lightning damage, pull out the power cord and remove the antenna cable during an electrical storm.
11. The general digital signals may interfere with other equipment such as tuners or receivers. Move the system farther away from such equipment if interference is observed.

NOTE:

Please check the copyright laws in your country before recording from records, compact discs, radio, etc. Recording of copyrighted material may infringe copyright laws.

CAUTION

The apparatus is not disconnected from the AC power source so long as it is connected to the wall outlet, even if the apparatus itself is turned off. To fully insure that the apparatus is indeed fully void of residual power, leave unit disconnected from the AC outlet for at least fifteen seconds.

Voltage Selector (General Model Only)

Be sure to position the voltage selector to match the voltage of your local power lines before installing the unit.

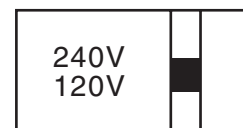



Welcome...



And Thank you for purchasing the DVD-DUET from VocoPro, your ultimate choice in Karaoke entertainment! With years of experience in the music entertainment business, VocoPro is a leading manufacturer of Karaoke equipment, and has been providing patrons of bars, churches, schools, clubs and individual consumers the opportunity to sound like a star with full-scale club models, in-home systems and mobile units. All our products offer solid performance and sound reliability, and to reinforce our commitment to customer satisfaction, we have customer service and technical support professionals ready to assist you with your needs. We have provided some contact information for you below.

VocoPro

1728 Curtiss Court
La Verne, CA 91750
Toll Free: 800-678-5348
TEL: 909-593-8893
FAX: 909-593-8890

VocoPro Company Email Directory

Customer Service & General Information

info@vocopro.com

Tech Support

techsupport@vocopro.com

Remember Our Website

Be sure to visit the VocoPro website **www.vocopro.com** for the latest information on new products, packages and promos. And while you're there don't forget to check out our Club VocoPro for Karaoke news and events, chat rooms, club directories and even a KJ Service directory!

We look forward to hearing you sound like a PRO, with VocoPro, your ultimate choice in Karaoke entertainment.

FOR YOUR RECORDS

Please record the model number and serial number below, for easy reference, in case of loss or theft. These numbers are located on the rear panel of the unit. Space is also provided for other relevant information

Model Number _____

Serial Number _____

Date of Purchase _____

Place of Purchase _____

Listening For A Lifetime

Selecting fine audio equipment such as the unit you've just purchased is only the start of your musical enjoyment. Now it's time to consider how you can maximize the fun and features your equipment offers. VocoPro and the Electronic Industries Association's Consumer Electronics Group want you to get the most out of your equipment by playing it at a safe level. One that lets the sound come through loud and clear without annoying blaring or distortion and, most importantly, without affecting your sensitive hearing.

Sound can be deceiving. Over time your hearing 'comfort level' adapts to a higher volume of sound. So what sounds 'normal' can actually be loud and harmful to your hearing. Avoid this by setting your equipment at a safe level BEFORE your hearing adapts.

To establish a safe level:

- Start with your volume control at a low setting.
- Slowly increase the sound until you can hear it comfortably and clearly, and without distortion.

Once you have established a comfortable sound level:

- Set the dial and leave it there.
- Pay attention to the different levels in various recordings and adjust when necessary.

Taking a minute to do this now will help to prevent hearing damage or loss in the future. After all, we want you listening for a lifetime.

Used wisely, your new sound equipment will provide a lifetime of fun and enjoyment. Since hearing damage from loud noise is often undetectable until it is too late, this manufacturer and the Electronic Industries Association's Consumer Electronics Group recommend you avoid prolonged exposure to excessive noise. This list of sound levels is included for your protection.

Some common decibel ranges:

Level	Example
30	Quiet library, Soft whispers
40	Living room, Refrigerator, Bedroom away from traffic
50	Light traffic, Normal Conversation
60	Air Conditioner at 20 ft., Sewing machine
70	Vacuum cleaner, Hair dryer, Noisy Restaurant
80	Average city traffic, Garbage disposals, Alarm clock at 2 ft.

The following noises can be dangerous under constant exposure:

Level	Example
90	Subway, Motorcycle, Truck traffic, Lawn Mower
100	Garbage truck, Chainsaw, Pneumatics drill
120	Rock band concert in front of speakers
140	Gunshot blast, Jet plane
180	Rocket launching pad

-Information courtesy of the Deafness Research Foundation

Before Getting Started: Things to Consider

It is very important to read the following instructions prior to first use of your DVD-DUET. Doing so will ensure proper operation and may save you some time as well.

Protect Against Power Surges

- Connect all external components before you plug any of their power cords into the wall outlet.
- Turn off the DVD-Duet before you connect or disconnect any cables.
- Make sure all cables are properly grounded.

Protect Components from Overheating

- Don't block ventilation holes. Arrange any components so that air can circulate freely.
- Don't stack components.
- If you place the DVD-Duet on a stand, make sure you allow adequate ventilation.

Position Cables Properly to Avoid Audio Interference

- Insert each cable firmly into the designated jack.
- If you place components above the DVD-DUET, route all cables down the side of the back of the DVD-DUET instead of straight down the middle of the back of the DVD-DUET.

Important Stand and Base Safety Information

Choose the location for your DVD-DUET carefully. If the DVD-DUET is placed on a stand or base, ensure that it is of adequate size and strength to prevent it from being accidentally tipped over, pushed off, or pulled off. This could cause personal injury and/or damage to the DVD-DUET.

You should have received the following items:

ITEMS:

DVD-DUET
SEMI-PRO Microphones
Microphone Cables
RCA Patch cable
Remote Control

QUANTITY:

(1)
(2)
(2)
(1)
(1)

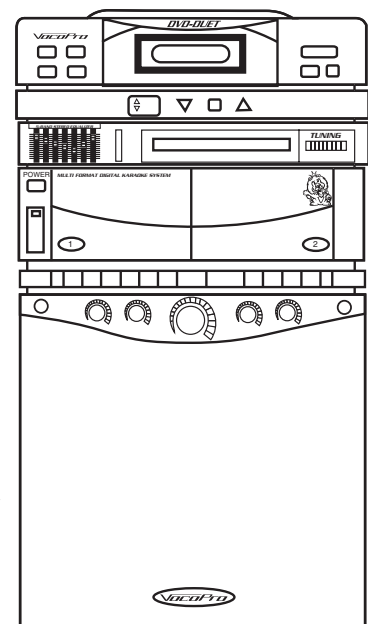
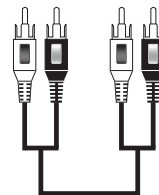
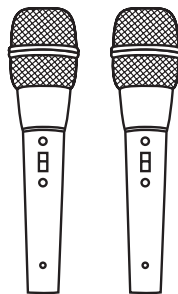
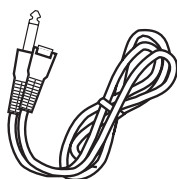
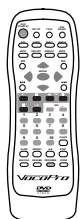

Front Panel Descriptions

1. **POWER** - Press to turn the system ON, press again and release to turn the system OFF.

2. CASSETTE CONTROLS.

RECORD - Press to RECORD. Refer to "Recording Cassettes".

PLAY - Press to PLAY tape. Refer to "Playing Cassettes".

REW/REV - Press to REWIND tape.

FF/CUE - Press to rapidly ADVANCE tape.

STOP/EJECT - Press to STOP cassette. (Cancels any depressed cassette button except PAUSE). Press again to OPEN cassette door.

PAUSE - Press to temporarily PAUSE the tape movement in PLAY or RECORD MODE. Press and release to start the tape moving again.

3. **GRAPHIC EQUALIZER** - Adjust these controls to provide the sound quality that you prefer. Refer to "Audio Controls."

4. **FUNCTION SELECTIONS** - Select the INPUT source by sliding knob to choose the desired function.

AM - for AM reception.

FM - for FM reception.

TAPE - for cassette operation.

DISC - for all disc operation.

5. **TUNING** - Turn the knob to choose the AM or FM station you want.

6. **MIC 1 INPUT** - Connect 1/4" microphone cable here.

7. **MIC 1 VOL** - Turn clockwise to increase volume control and counter-clockwise to decrease.

8. **MIC 2 VOL** - Turn clockwise to increase volume control and counter-clockwise to decrease.

9. **MASTER VOL** - Adjust the control for desired VOLUME level. Turn clockwise to increase and counter-clockwise to decrease.

10. **DIGITAL ECHO** - Adjust the control for desired ECHO effect level. Turn clockwise to increase and counter-clockwise to decrease.

11. **BALANCE** - Adjust the control for desired MUSIC /VOCAL and LEFT/RIGHT balance/. Turn clockwise to send balance to right channel and counter-clockwise to send balance to left channel.

12. **MIC 2 INPUT** - Connect 1/4" microphone cable here.

DISC CONTROLS

13. **PLAY/PAUSE** - Press button to initiate disc playback. To stop disc playback momentarily, press PLAY/PAUSE again. With DVDs and other video discs, the scene in which you paused remains on-screen. To resume playing the disc, press the PLAY/PAUSE button again.

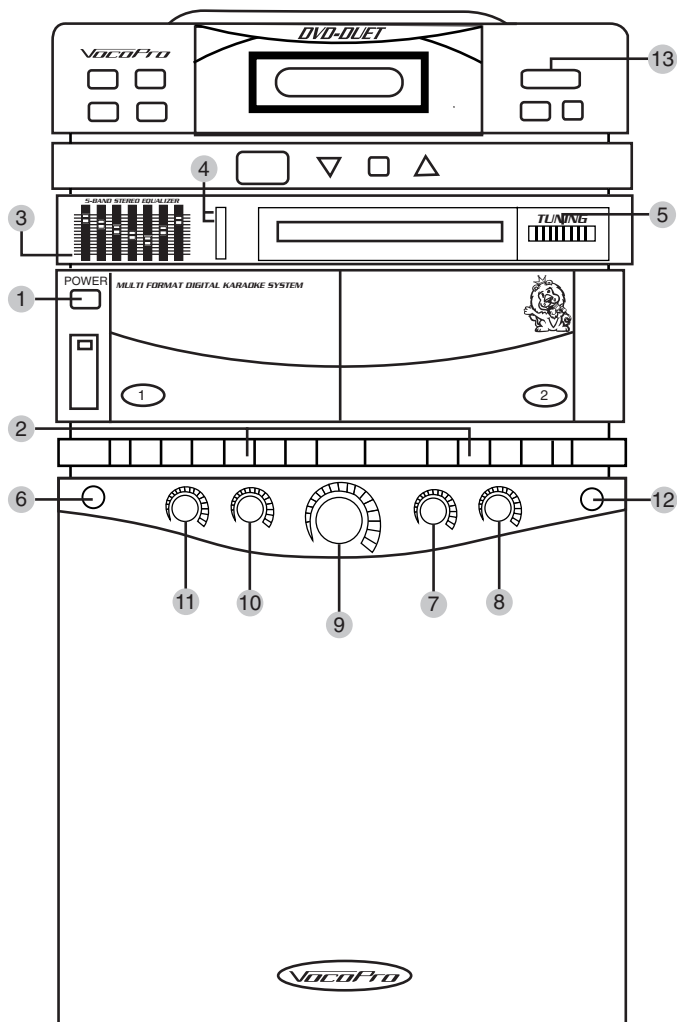

Front Panel Descriptions

DISC CONTROLS CONTINUED

14. **STOP** - Press once to put player on standby in "PRE-STOP" mode. With DVDs, VCDS and other video discs, this standby STOP mode will not send disc output to your monitor (VocoPro screen will appear instead), until PLAY is pressed to resume playback. With many types of discs, playback will resume at the point when PRE-STOP was initiated. Pressing STOP again will completely stop the player without saving a time marker. With some CDGs, STOP completely cancels playback.
15. **F.F. ►►** - To advance the CD to the beginning of the next track, press and release this button. Continue pressing to advance to subsequent tracks.
16. **REW ◀◀** - To reverse the CD to the beginning of the last track, press and release the button. The player will skip back to the beginning of the track. Continue pressing the button if you want to REWIND to the beginning of previous tracks.
17. **REPEAT** - Press the REPEAT button once and the REPEAT symbol (↺) will appear on the disc display. The disc player will repeat the track currently playing until the STOP button is pressed. If you want to repeat play of an entire disc indefinitely, press the REPEAT button twice and the "ALL" will light on the display next to the REPEAT symbol. The player will repeat playing the disc continuously until the STOP button is pressed.
18. **DISPLAY** - Press DISPLAY button to display the track number that is playing, elapsed time, number of remaining tracks, and duration of disc that is being played.
19. **MULTIPLEX** - Switch between STEREO, MONO L or MONO R output with MULTIPLEX media for adding/removing guide vocals.
20. **DIGITAL KEY CONTROLLER** - Raises or lowers the key of the disc output in half-step increments without changing the tempo to match the natural range of your singing voice. Operate by pushing the desired + (UP/#/SHARP) or - (DOWN/b/FLAT) while disc is playing, until the desired key is reached. Pressing the center square button will return music to its original or "NATURAL" key.
NOTE : Key Controller is inoperable when AM, FM or TAPE is selected.
21. **REMOTE CONTROL SENSOR**

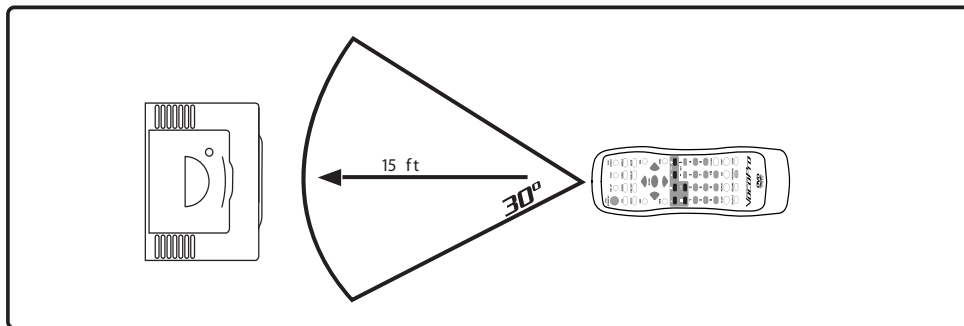
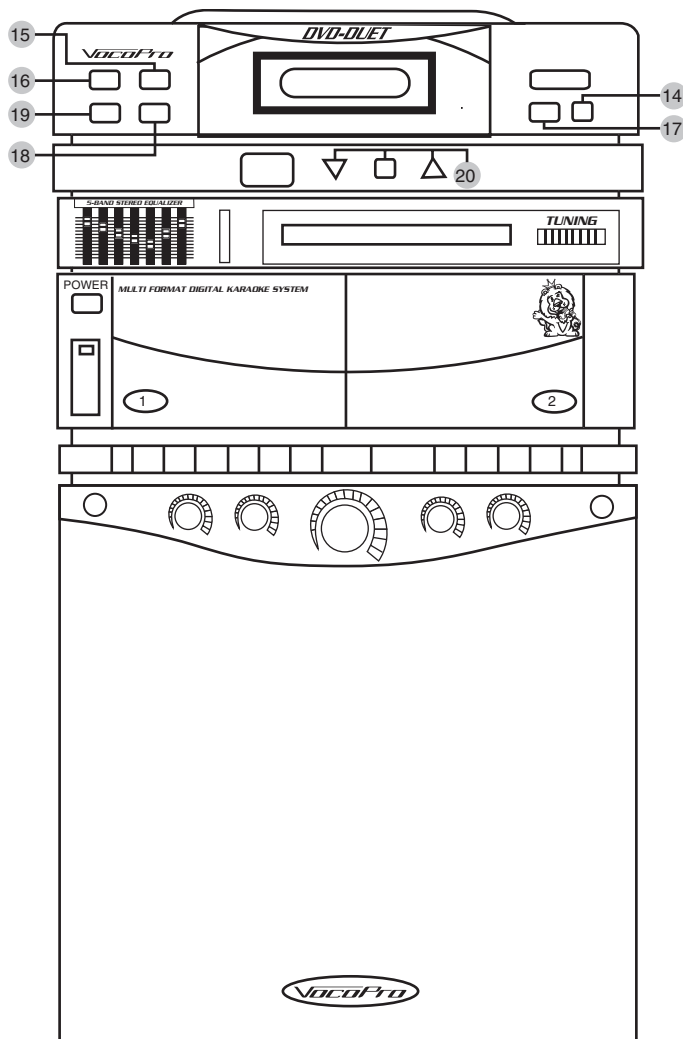

Rear/Top Panel Descriptions

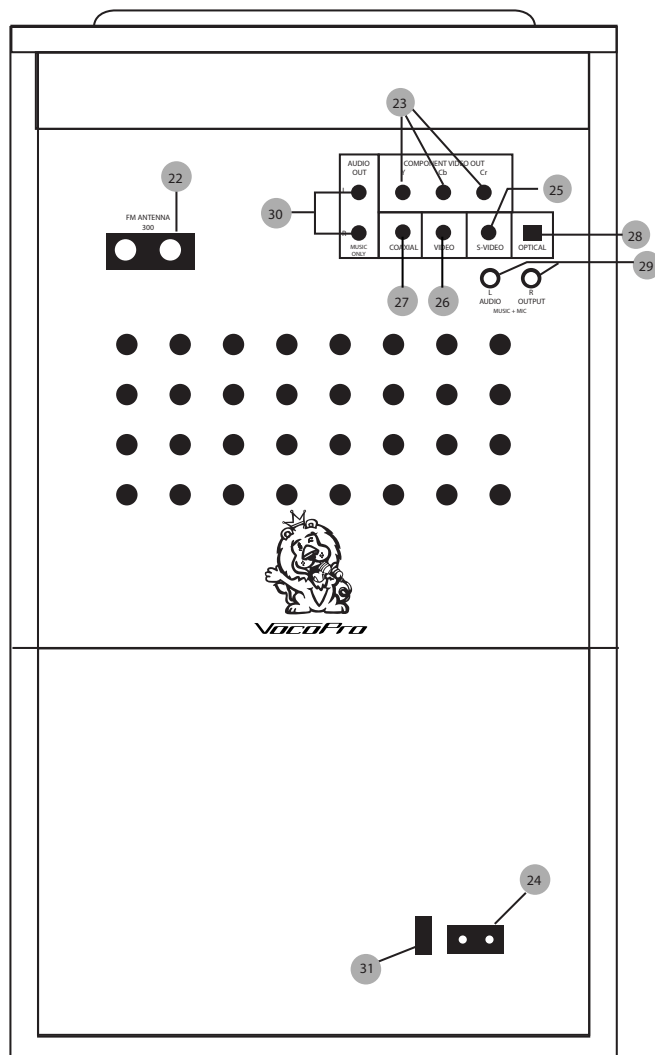
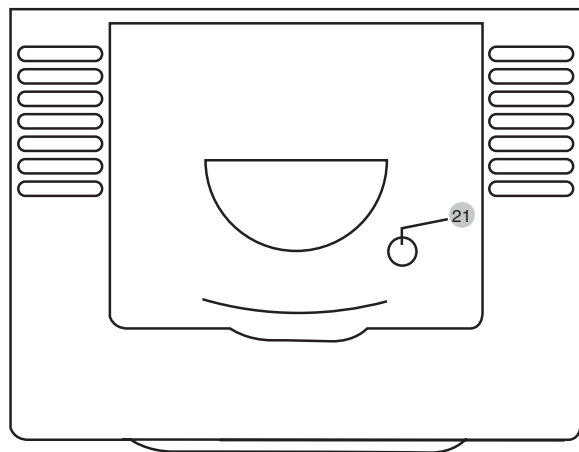

21. **OPEN/CLOSE** – Press the OPEN/CLOSE point to open the CD compartment. Close CD compartment by pressing this button again.
22. **FM ANT TERMINAL** – Connect the FM ANTENNA wire for optimal reception.
23. **COMPONENT VIDEO OUTPUT** – Connect jack to component VIDEO IN of TV.
24. **AC CORD** – Plug AC power cord into compatible AC wall outlet.

WARNING: PLUGGING THIS UNIT INTO AN AC OUTLET WITH A POWER RATING DIFFERENT FROM THAT SELECTED ON THE VOLTAGE SELECTOR CAN SEVERELY DAMAGE THE UNIT, AND MAY VOID YOUR PRODUCT WARRANTY.

25. **S-VIDEO-CONNECT** Jack to S-VIDEO-IN of your TV
26. **VIDEO OUTPUT**- Connect to standard VIDEO-IN on TV
27. **COAXIAL**- Connect to DOLBY DIGITAL AC-3 or DTS receiver/decoder
28. **OPTICAL**– Use this jack only when AC power is not available. Be sure to use a UL or CE approved car adapter or a UL or CE approval AC/DC adapter.
29. **AUDIO PRE-OUT** – NTSC/PAL system select switch. Switch to NTSC for U.S. TV systems. Switch to PAL for European TV systems.
30. **DVD AUDIO OUTPUT** – Connect this jack to the AUX input or CD input of your home audio system. The DVD player can be listened to through your own stereo system or larger external system.
31. **VOLTAGE SELECTOR**– Selects between 120V-240V power settings. Ensure that the Voltage Selector is set to match the power rating of your AC outlet before powering on the unit. Select 120V for North American-based power settings and 240V for European-based power settings.

Remote Operations

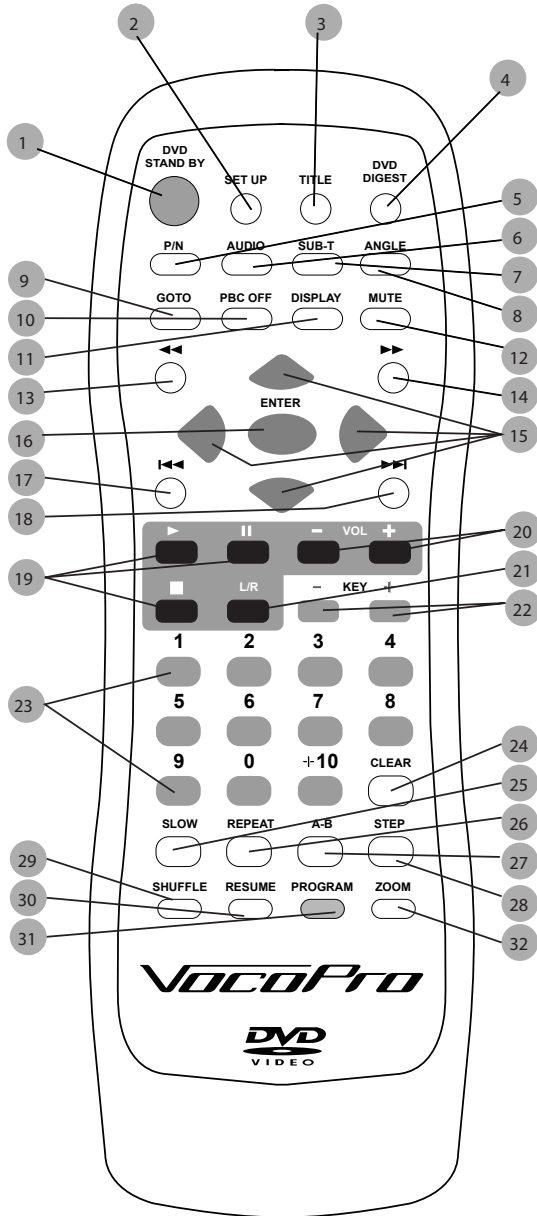

- 1 **DVD STANDBY** will return to the beginning of disc and until hold until button is released
- 2 Displays **SYSTEM SETUP** menu
- 3 **TITLE** manual select for DVDs
- 4 With DVDs, returns to main **DVD DIGEST** menu
- 5 **P/N** toggles between PAL and NTSC video formats
- 6 With DVDs, selects **SOUNDTRACK** mode
- 7 **SUB-T** displays **SUBTITLES** menu for selection
- 8 **ANGLE** selects between different viewing angles with compatible discs for theatrical performances, sports events or other live recordings
- 9 **GOTO** is used to input CHAPTER, SCENE or TIME with DVDs

- 10 Enables/disables **PBC** (playback control) mode. If PBC is ON, you have direct access to tracks/scenes by using NUMBER pad with compatible discs only. If discs are incompatible with this feature, pressing PBC button will cause disc playback to stop and restart.
- 11 Selects On Screen **DISPLAY** language or TRACK/TIME information depending on disc type and disc options
- 12 To **MUTE** all audio output
- 13 To **FAST REVERSE** a TRACK/SCENE. Press repeatedly to increase speed 2X, 4X, 8X up to 20X
- 14 To **FAST FORWARD** a TRACK/SCENE. Press repeatedly to increase speed 2X, 4X, 8X, up to 20X
- 15 **DIRECTION** keys for navigating through menus
- 16 **ENTER** to confirm menu selections
- 17 To **TRACK REVERSE** to previous TRACK/SCENE
- 18 To go **TRACK FORWARD** to next TRACK/SCENE
- 19 Disc **PLAY**, **PAUSE** and **STOP** function keys. When a DVD is stopped, the VocoPro screen appears and player first enters PRE-STOP mode, allowing playback at the same point when PLAY or RESUME (see #30) is pressed. Pressing STOP again will cancel this standby mode and completely stop the disc player.
- 20 **VOLUME** controls + (up) /- (down) for disc audio output
- 21 **L/R** key selects between MONO L/R (duplicates either side in both channels) for use with Multiplex media or STEREO audio output for standard
- 22 **KEY CONTROL** allows you to adjust source music 12 steps + (#) or - (b) from Natural (♩) note
- 23 Disc program/track selection **NUMBER PAD**; For double-digit track numbers, use +10 key plus addition numeral where applicable.
- 24 To **CLEAR** selections made in menus
- 25 Allows you to **SLOW** playback speed 1/2, 1/3, 1/4, 1/5, 1/6 up to 1/7 of original speed
- 26 You can choose **REPEAT 1** track or **REPEAT ALL** tracks using this button.
- 27 **A-B** is used to repeat a specific portion of a disc as a loop for practice or fun. Press A-B once to select starting point, then press A-B again to set end point of your loop. The loop you have created will play indefinitely until you press A-B a final time to cancel.
- 28 **STEP** allows you to pause view and advance frame-by-frame for detailed viewing.
- 29 With **SHUFFLE**, you can toggle RANDOM ON/OFF.
- 30 To **RESUME** playback after PRE-STOP/standby mode (see #19)
- 31 To **PROGRAM** CHAPTERS or TRACKS for playback; With videos, enter TITLE:CHAPTER(s) desired using DIRECTION keys and NUMBER PAD, then arrow down to PLAY and press ENTER. For audio, enter TRACK numbers in order desired.
- 32 Allows you to **ZOOM** 2X, 3X, 4X, 1/2, 1/3, or 1/4 the size of original picture

Audio Controls

Graphic EQ Settings

After choosing the program source you want; adjust the GRAPHIC EQUALIZER controls as follows:

1. Adjust the VOLUME control for the desired listening level.
2. Set the GRAPHIC EQUALIZER controls to match the sound characteristics of your listening room. With each of the five controls of the GRAPHIC EQUALIZER, it is possible to control a narrow, distinct section of the audio band by up to +/-10dB. The frequency bands controlled by the slide controls have been chosen to give you the best possible control action within the audio spectrum.

100 Hz -Is very useful for enhancing low bass notes (as in organ music, kick drum, etc.) or making corrections when a deficiency in bass exists. Or you can use this to reduce rumble, acoustic feed back, and other low frequency aberrations.

300 Hz -Will allow you to vary the upper bass frequencies. An over-accentuated, upper bass will give a muddy, boom quality to music while the system shy of upper bass will sound hollow and thin.

1 kHz - Lies in range of frequencies where the ear is most sensitive to tonal balance. This is often called "presence", since adjusting this control brings the vocalist out to the front or back into ensemble.

3 kHz -Speaker designers often boost output in this range to effect a quality of presence to the music. Too much energy on the other hand, sounds overbearingly harsh and stringent.

10 kHz -Adjustment affects the brilliance of music with too much boosts in high frequencies (can be an unpleasant and piercing quality). You may use this to add a little more dimension to the high-shelf sound or use it as a very high frequency noise filter.

Using Your Radio

AM or FM - Press the POWER button ON. Slide the FUNCTION SELECTOR to AM or FM. Rotate the tuning knob to the desired listening station.

Cassette Handling

Operating Tips

1. High quality tapes will give you better recordings. Tapes of the following types are suggested: Low noise, high density, high output or extended range with a play or record time up to 90 minutes.



NOTE: Cassette with a time of 120 minutes (C120) are not recommended because they contain thinner and longer tapes which are more likely to jam or tangle in the player/recorder.

2. For best results in playing or recording, it is necessary for the head to be clean. Refer to cleaning instructions. Keep cassettes away from excessive heat or cold.

3. If the tape is loose in the cassette, tighten it before putting it in.

To do so, put a pencil into the hub and turn it to the right

(Shown in Fig. 1)

(Fig. 1)

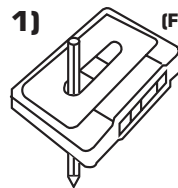

4. A leader tape begins each side of a cassette. You cannot play or record on this part of the tape. You have to let the tape run for about five seconds so this leader tape is past the heads.



NOTE: When you start the tape, be sure the tape take-up reel is moving.

If the reel is not moving stop the machine at once; if you don't the tape could become tangled in the player/recorder. If this does happen, carefully remove the cassette and correct it as shown above.

Cassette Deck Operations

Follow the steps bellow for any tape deck operations:

1. Press the POWER switch ON.
2. Slide the FUNCTION SELECTOR to TAPE.
3. Press the STOP/EJECT button, the cassette door will open.
4. Put the cassette into the holder, open end down, and gently close the cassette door.
5. Press the PLAY button. The system will play the cassette till the end of that side is reached. To play the other side, hit the STOP/EJECT button and remove the cassette, turn it around and put it back in, close the door and press the PLAY button.

Extended play

Extended listening is possible by using the two cassette decks as follows:

1. Press the POWER switch ON.
2. Slide the FUNCTION knob to TAPE.
3. Load a cassette into both decks.
4. First, press the PLAY button on the Deck 2, and then press the PAUSE and PLAY buttons on Deck 1 (in that order). Deck 2 will play its cassette first and stop at its end, at that time, Deck 1 will automatically begin playback.

Recording Cassettes

1. Press the POWER button ON.
2. Select your master source signal to be recorded by sliding the FUNCTION SELECTOR control to AM, FM, CD or TAPE. You will (through internal connections) record the source you are listening to. The recording level is not affected by the master volume control.
3. Press the STOP/EJECT button on the Deck 1; the cassette door will open.
4. Put the cassette into the holder open the end down and gently close the cassette door.
5. With a partially recorded tape, use the FAST FORWARD and REWIND controls to find your starting point.
6. Remember to advance past the leader when using a new tape.
7. Press the PAUSE button.
8. Press the RECORD button firmly.
9. When you are ready to start your recording, press and release the PAUSE button.
10. The system will record the entire cassette and shut off unless you desire to stop it by pressing the STOP/EJECT or PAUSE button.
11. Press the PAUSE button to stop the tape for a time while you change your recording selection, cue a record or retune a radio station. Press and then release PAUSE when you are ready to continue recording.
12. While you are recording, you may monitor the program by listening to the speakers. Adjust the VOLUME control for your best listening level. It will not affect the record level.

Sync Dubbing

1. Press the POWER button ON.
2. Press the STOP/EJECT button; the cassette door will open.
3. Load a blank tape into Deck 1. Gently close the cassette door. First press PAUSE, and then press RECORD.
4. Load the tape to be copied into Deck 2. Gently close the cassette door.
5. Press the PLAY button on Deck 2. The PAUSE button on Deck 1 will release and recording will begin.

Adjusting CD/Tape Playback Speeds

If you desire to either slow down or speed up playback of a track on a CD or cassette, you simply need to adjust the CD/TAPE PITCH control. To slow down playback, turn the control counter-clockwise towards SLOW. To speed up playback, turn the control clockwise towards FAST.

Cassette Tape/Deck Maintenance

Erase Protection

Every cassette can be protected against accidental erasing of pre-recorded material. On the back of a cassette are two breakout tabs. These must be in place before the RECORD button will depress. If these tabs have been removed, such as on pre-recorded cassette you buy, the RECORD button will not depress. To record using a cassette which has the breakout tabs removed, place a piece of tape over the exposed holes, this will allow the interlocking device to engage

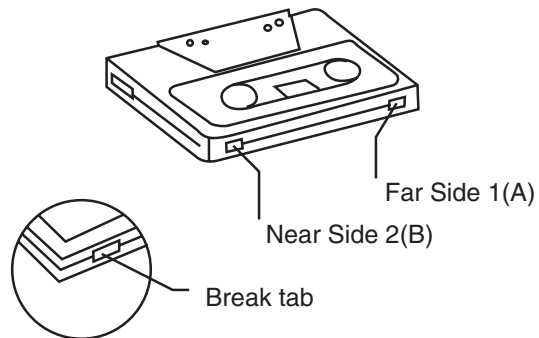

Once you have made a recording, you can prevent an accidental erasing by breaking out and removing the tabs. With side 1(A) facing you, erasing is prevented by breaking out the tab on the right, and side 2(B) by the tab on the left (see drawing).

Cleaning



To prevent fire or shock hazard, disconnect your stereo system from the AC power plug when cleaning.

- The finish on our stereo may be cleaned with a dust cloth and cared for as other furniture. Be careful when cleaning and wiping the plastic parts. Mild cleaners, such as dishwashing detergent, with dampened (not wet) cloth may be used on the front panel.

Tape Deck Cleaning

- To get the best sound from your tapes, the pressure roller, capstan, play/record and erase heads should be cleaned regularly. The build up of iron oxide particles is often severe with inferior tapes and will reduce the performance of the system. After every 100 hours of use, or more often if playback has become poor, clean the play/record and erase heads, capstan and pressure roller. To clean them, wipe dry with a soft, clean cloth.

Cassette Record/Playback

Cassette Playback

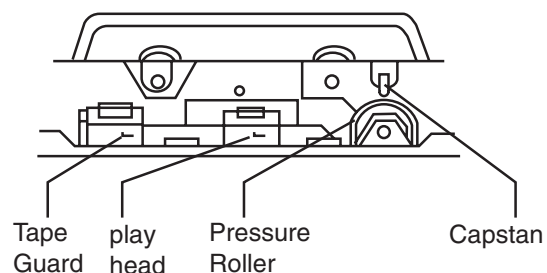
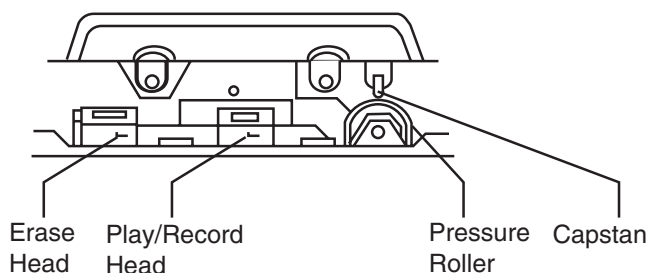

NOTE: Never use any metal objects on or near the tape head. Do not allow any cleaning material to fall into tape assembly. Do not use carbon tetrachloride as a cleaning agent.

Getting Connected to External Components

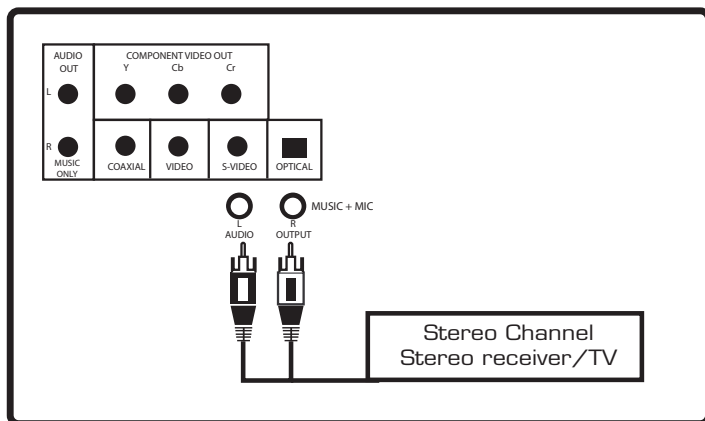

Connecting to an analog amplifier/ 2-channel stereo receiver/mixer

Using the supplied RCA patch cable, connect one set of red & white RCA plugs to the RCA AUDIO OUTPUT jacks on the DVD-DUET. Connect the other set of red & white RCA plugs to the AUDIO INPUT jacks on your stereo receiver/TV. Depending on the stereo receiver/TV, the audio input jacks may be labeled AUDIO, LINE, AUX, VIDEO 1/2/3.

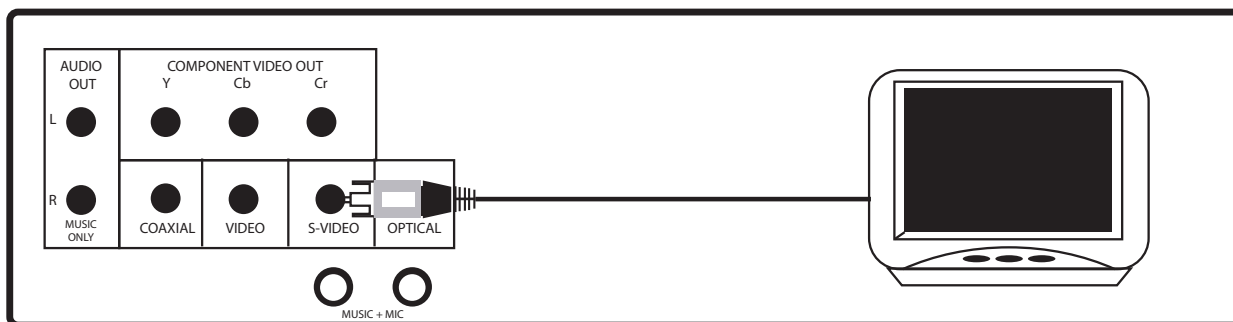

Connecting to a TV with an RCA Connection

Using either the yellow-ended RCA plug from the included RCA patch cable or a separate RCA patch cable, connect one end to the RCA VIDEO OUTPUT jack on the DVD-DUET and connect the other end to the VIDEO INPUT jack on our TV or monitor device.

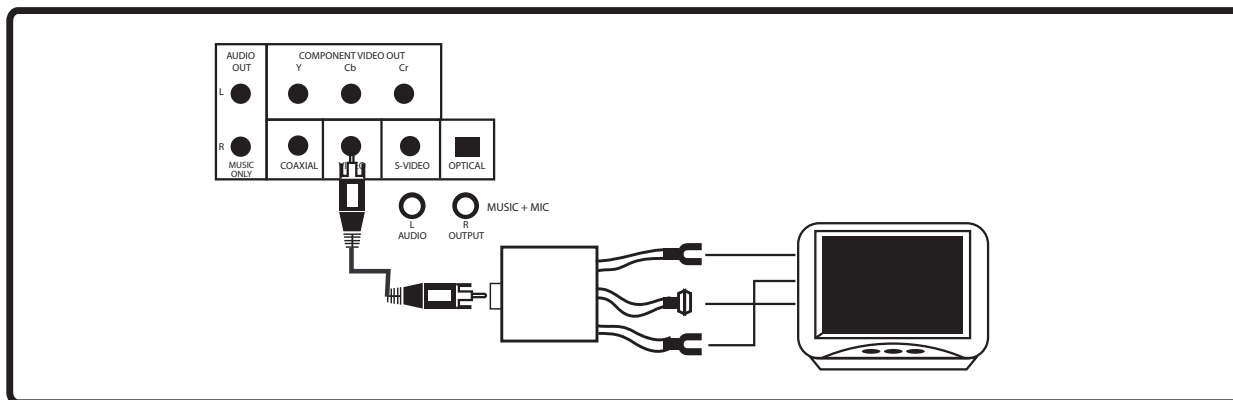

Connecting to a TV with an RF Modulator

If your TV has only a RF-style Jack, such as Antenna In or 75 ohm, and no RCA video input jack, you can connect video with a RF modulator (not supplied). Ask your dealer for details on RF modulator availability and compatibility. Follow the instructions provided with the RF modulator to connect the DVD-DUET to your TV.

Getting Connected to External Components

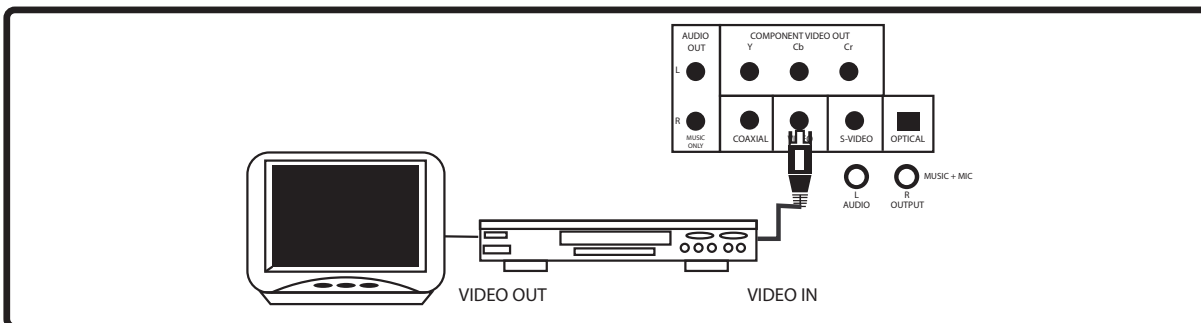

Connecting to a TV with a VCR

You can also use a VCR to connect video to a TV with no RCA video input. You will need an RCA cable and a 75-ohm Coaxial type cable. Using the RCA video cable, connect one end to the VIDEO OUTPUT jack on the DVD-DUET and connect the other end of the cable to the VIDEO INPUT of a VCR. Then, using the 75-ohm Coaxial type cable, connect one end to the RF OUTPUT of the VCR, and connect the other end to the 75-ohm TV ANTENNA INPUT jack.

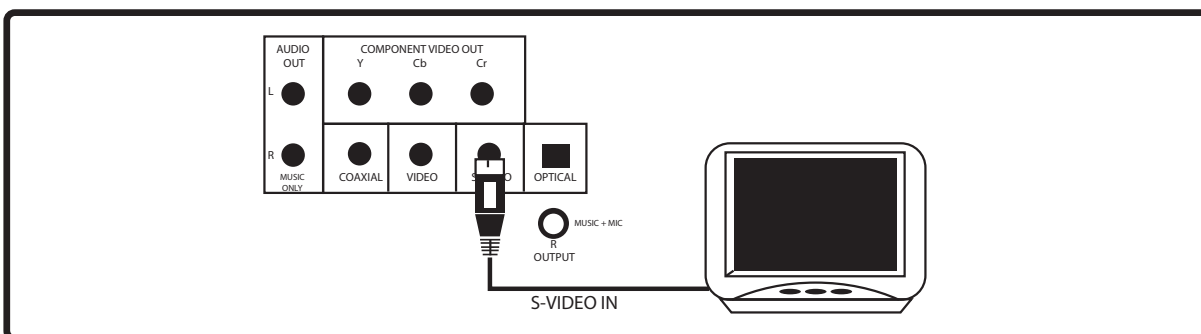

Connecting to a TV with S-Video

Using an S-Video cable, connect one end to the DVD-DUET's S-VIDEO OUTPUT jack and connect the other end to the S-VIDEO IN jack on your television. See the Video preferences directions under System Setup menu to select video output

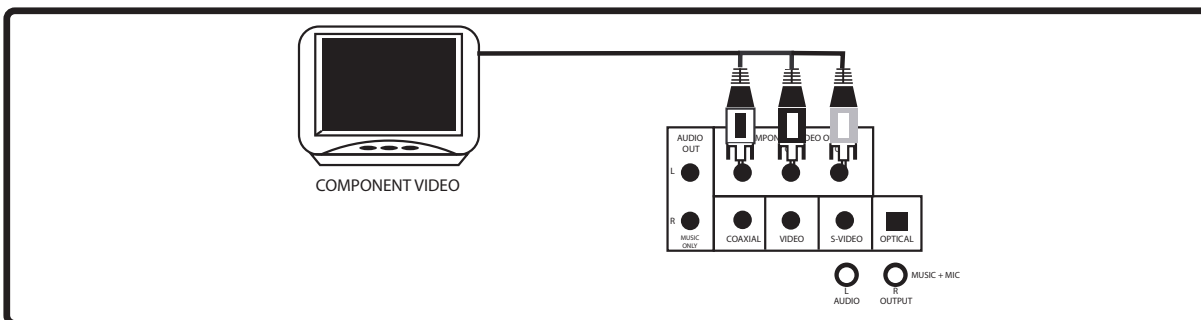

Connecting to a TV with Component Video

Using 3 appropriate Component Video cables (usually color coded red, blue and green), connect a set of plugs to the COMPONENT VIDEO OUT jacks (Y Cb Cr) on the DVX-680K and plug the other set of plugs to your COMPONENT VIDEO IN jacks (Y Cb Cr) on your television. On some TVs the component video input jacks may be labeled (Y Pb Pr). See the Video preferences directions under System Setup menu to select video output.

Getting Connected to External Components

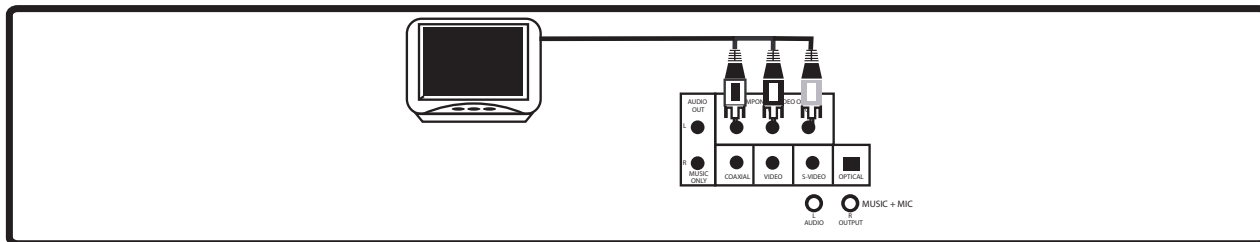

Connecting to a HDTV or video monitor

To connect video to a HDTV you can use the same connections as for TV with Component Video. See Video preferences under System Setup menu for selecting video output type.

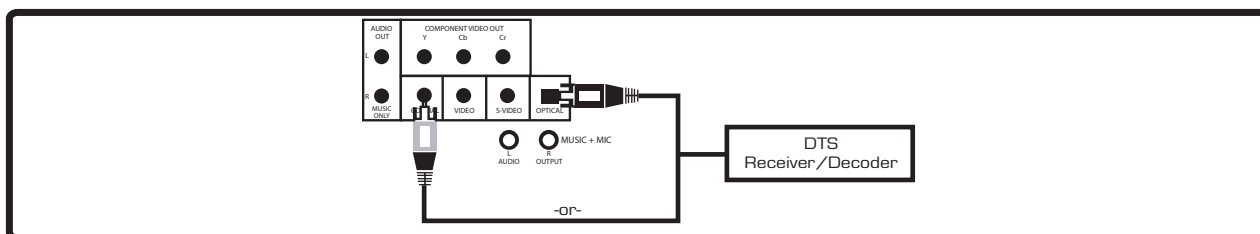

Connecting to a DTS Receiver/Decoder

Using either an RCA type COAXIAL cable for digital audio or an OPTICAL cable, connect one end to the respective Coaxial or Optical jack of the DUET and the other end to the appropriate jack on the DTS receiver. If you have both coaxial and optical inputs on your DTS decoder/receiver, it is recommended to use an optical connection as those cables eliminate the possibility of Electromagnetic Interference.

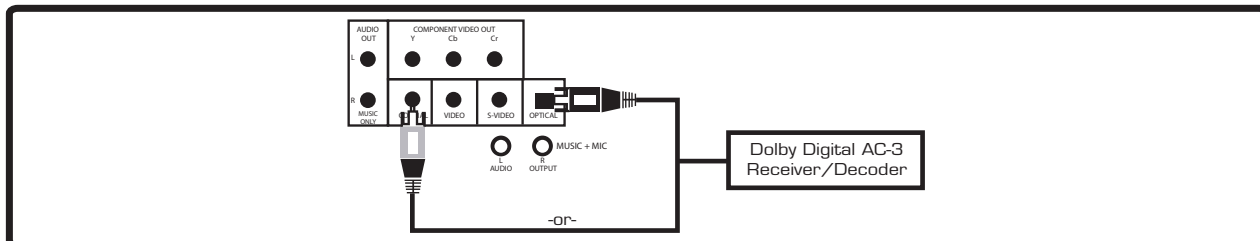

Connecting to a Dolby Digital AC-3 Receiver/Decoder

Using either an RCA type COAXIAL cable for digital audio or an OPTICAL cable, connect one end to the respective Coaxial or Optical jack of the DUET and the other end to the appropriate jack on the DTS receiver. If you have both coaxial and optical inputs on your DTS decoder/receiver, it is recommended to use an optical connection as those cables eliminate the possibility of Electromagnetic Interference.

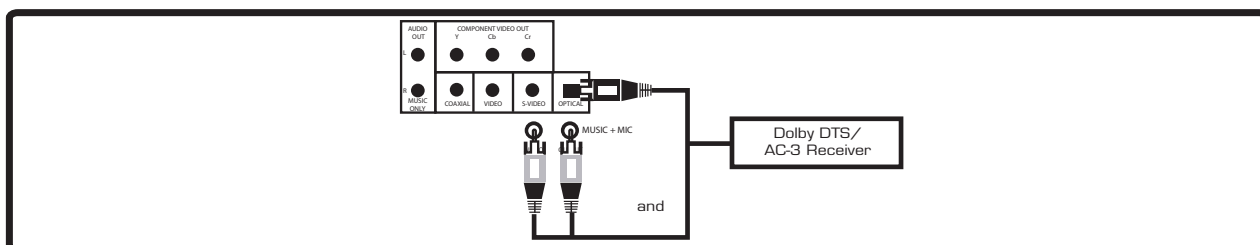

Connecting both Analog and Digital Audio

To do this you will need a Dolby Digital DTS/AC-3 receiver with analog audio inputs. Use optical for video and digital audio and L/R RCA audio for Karaoke features.

System Setup Menu

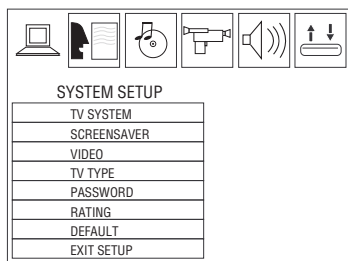

SYSTEM SETUP SCREEN

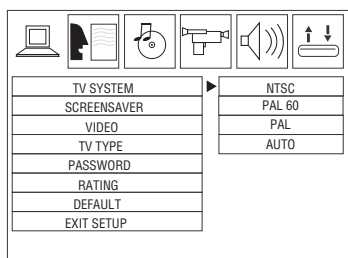

TV SYSTEM

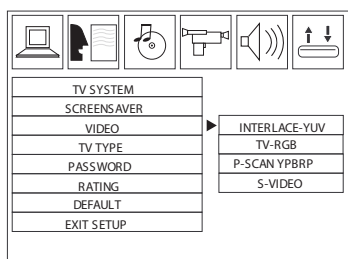

VIDEO

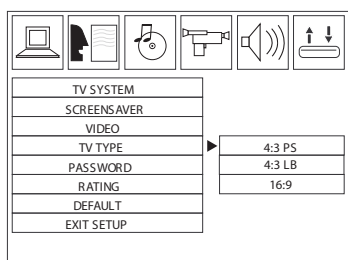

TV TYPE

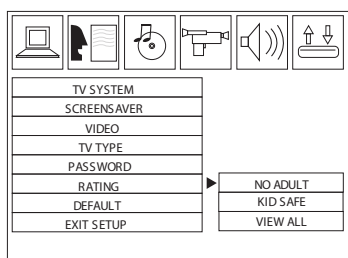

RATING

SYSTEM SETUP MENU

To access your preferences settings, use the SETUP button on your remote. Use the DIRECTION keys to navigate within this menu for the specific subdirectory desired and press ENTER. The icon file tabs at the top of the screen indicate which menu is highlighted.

1. TV SYSTEM

Use this menu to set your system preferences for regional TV system types NTSC, PAL60, PAL, or AUTO to have your DVD-DUET automatically find any compatible TV system.

2. SCREEN SAVER

The DVD screen saver can be toggled ON/OFF to suit your preference for display during periods of player inaction when power remains on. Use DIRECTION keys to make your selection.

3. VIDEO

Refer to your TV manual to determine which type of video it supports. You can choose between INTERLACE-YUV, TV-RGB, P-SCAN YPBRP or S-VIDEO.

4. TV TYPE

This menu actually refers to TV display mode. Choose between 4:3PS for Panoramic Screen, 4:3LB for Letterbox, or 16:9 based on your viewing preference.

5. PASSWORD

The password to lock or unlock RATING setting is 0000. If you are a parent and want to limit the types of DVDs viewed with the DVD-DUET, type this password using the NUMBER keys on the remote, and press ENTER. You will see the padlock icon either open or close, affecting the ability of the user to make a selection in the RATING mode.

6. RATING

Choose between NO ADULT, KID SAFE, or VIEW ALL to designate which types of DVDs you want users to be able to access playback for.

7. DEFAULT

Select this mode if you choose to return to all system preferences DEFAULT settings.

8. EXIT SETUP

Highlight this option and press ENTER at any time to exit these menus and return to previous operations

Language Setup, Audio Setup, Video Settings

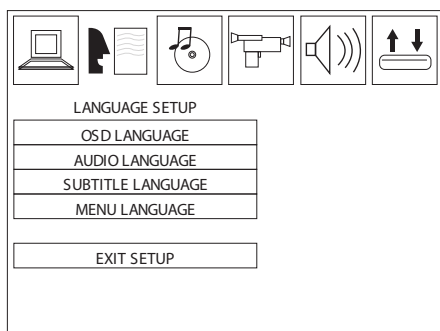

LANGUAGE SETUP SCREEN

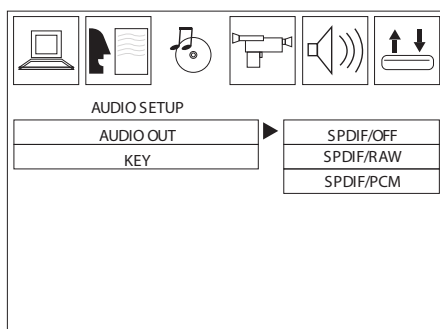

AUDIO OUT

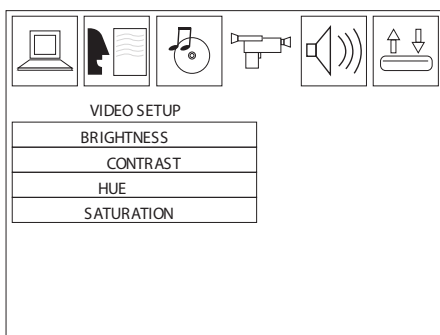

VIDEO SETUP

LANGUAGE SETUP

Use this menu to set language preferences for each of these functions. Use the DIRECTION keys to make a selection and press ENTER to confirm your choice.

1. **OSD** (On Screen Display) LANGUAGE for remote functions, etc. Choose between English or Chinese.
2. **AUDIO LANGUAGE**. This feature is dependent on the options included with each individual disc. Choose from the list provided.
3. **SUBTITLE LANGUAGE**. This feature is dependent on the options included with each individual disc. Choose from the list provided.
4. **MENU LANGUAGE**. This feature is dependent on the options included with each individual disc. Choose from the list provided.

AUDIO SETUP

1. AUDIO OUT

With the DVD-DUET, you can output standard analog audio simultaneous with digital output by using the RCA L/R outputs and Coaxial output. When connecting the DVD-DUET to an external sound system with digital inputs, choose between a) SPDIF/OFF to completely bypass digital audio, SPDIF/RAW for Dobby 5.1 or SPDIF/PCM for digital, high fidelity stereo (2-channel) output depending on your external audio components and connections.

2. KEY CONTROL

This feature functions exactly the same as the KEY CONTROL buttons on the remote control, but with a virtual vertical "fader" instead of a left-right display. Use the DIRECTION keys to locate the fader bar, raise (#/sharp) or lower (b/flat) the output of the disc in half-step increments.

VIDEO SETUP

Use the DIRECTION keys to locate the virtual fader and raise/lower the fader bar for each of the following video preference settings:

1. **BRIGHTNESS**
2. **CONTRAST**
3. **HUE**
4. **SATURATION**

Troubleshooting

If your stereo system fails to operate, carefully read these instructions. Many problem situations are caused by improper use. Listed below are the most common ones.

Problems	Solutions	
Power switched on, but no sound and no light on the POWER LED.	Poor AC power plug connection to wall outlet.	Connect AC correctly. Old wall-outlets sometimes cause power loss Plug must fit snugly in outlet.
The POWER LED system is on but no sound Poor FM reception	VOLUME control is at "0" position. Antenna not placed for best reception.	Adjust the VOLUME control to a proper sound level. Move antenna wire around to obtain best reception.
System turned on and PLAY pressed, but no sound from TAPE.	FUNCTION SELECTOR set improperly for tape playback. PAUSE button pressed in. Unrecorded tape inserted.	Slide FUNCTION SELECTOR to TAPE. Press and release the PAUSE button. Insert recorded tape.
Poor playback sound.	Dirty heads. Cassette tape is badly stretched. Heads have become magnetized.	Clean heads. See TAPE DECK Cleaning. Replace the cassette. Degauss the play and record head with a tape head demagnetizer every 100 hours of use.
RECORD button cannot be pressed in. Poor recording.	Cassette without erase protection tabs is inserted. Dirty heads.	Try another cassette, or place a piece of tape over the breakout tab holes. Clean heads. See Tape Deck Cleaning.
	Heads have become magnetized. Microphone defective Microphone cable broken or intermittent.	Degauss the play and record head with a tape head demagnetizer every 100 hours of use. Replace microphone or microphone cord.
Tape speed is erratic.	Dirty capstan and/or pressure roller.	Clean the capstan and pressure roller.
Cannot copy from DECK 2 to DECK 1.	Unrecorded tape inserted into DECK 2. PLAY/RECORD function selector is in wrong position.	Insert recorded tape. Set to the proper position.
CD Player does not work properly.	Disc is inserted upside down. Disc is dirty. Disc is scratched. Disc seriously warped. A nonstandard disc is inserted. Moisture has formed inside the CD deck.	Insert disc correctly. Wipe clean with soft cloth. Use a new disc. Use a new disc. Use only brand name disc. Wait about 20 to 30 minutes to let it dry.
NO song lyrics appear on screen.	Video cable is not connected properly to the TV. Source selector on TV is not set to VIDEO. TV does not have video line input.	Connect the video cable to the Duet-II VIDEO OUT and to the TV VIDEO IN. Using your TV Remote to select VIDEO or AUX input. Connect from VIDEO OUT of the Duet-II to the AUX IN of your VCR or Connect to an RF Modulator and then to the TV cable input.

Specifications

RADIO SECTION

Frequency range AM: 530 - 1719KHz

Frequency range FM: 87.5 - 108MHz

AUDIO SECTION

Output power (THD 10%): 40W + 40W peak

Output impedance: 8 Ohms

Graphic Equalizer controls: ± 10 dB

CASSETTE SECTION

Frequency response: 125Hz - 8 KHz

Wow and Flutter: 0.35%

Tape speed: 4.75 cm/sec

AC Input Power: AC 120/240V; 50Hz/60KHz; 60W

CD PLAYER SECTION

Frequency response: 125Hz - 8KHz

Signal to Noise Ratio: 50dB

Wow and Flutter: immeasurable

D/A conversion: 16-bit linear

Sampling system: 2 times over sampling

DIGITAL KEY CONTROL SECTION

12 steps in half-step increments

SPEAKER SECTION

Stereo two way, four speaker system with two 4" woofers and two 1/4" tweeters

VocoPro

ULTIMATE CHOICE OF KARAOKE ENTERTAINMENT



© Vocopro 2004
V 1.0

WWW.VOCOPRO.COM