



VOLVO V70 & XC70

OWNER'S MANUAL



WEB EDITION

DEAR VOLVO OWNER

THANK YOU FOR CHOOSING VOLVO

We hope you will enjoy many years of driving pleasure in your Volvo. The car has been designed for the safety and comfort of you and your passengers. Volvo is one of the safest cars in the world. Your Volvo has also been designed to satisfy all current safety and environmental requirements.

In order to increase your enjoyment of the car, we recommend that you familiarise yourself with the equipment, instructions and maintenance information contained in this owner's manual.





00 Introduction

Important information	6
Environment	8

00



01 Safety

Safety in the passenger compartment.....	12
Safety mode.....	25
Child safety	26

01



02 Locks and alarm

Remote control key/key blade	38
Privacy locking*.....	43
Battery replacement, remote control key/ PCC*	44
Keyless drive*.....	45
Locking/unlocking.....	47
Child safety locks.....	50
Alarm*	51

02



03 Your driving environment

- Instruments and controls..... 56
- Ignition positions 65
- Seats 66
- Steering wheel..... 70
- Lighting..... 71
- Wipers and washing 80
- Windows, rearview and door mirrors..... 82
- Power sunroof* 86
- Starting the engine 88
- Gearboxes 91
- All Wheel Drive – AWD (All Wheel Drive)* ... 95
- Foot brake 96
- Hill Descent Control (HDC) 97
- Parking brake..... 98



04 Comfort and driving pleasure

- Menus and messages 104
- Climate control 109
- Audio system 120
- Trip computer 130
- Compass* 132
- DSTC –Stability and traction control system 133
- Adapting driving characteristics 134
- Cruise control* 135
- Adaptive cruise control* 136
- Collision warning system with brake support* 140
- Parking assistance* 143
- BLIS* –Blind Spot Information System 146
- Comfort inside the passenger compartment 149
- Built-in phone* 153



05 During your journey

- Recommendations during driving 160
- Refuelling..... 163
- Fuel..... 164
- Loading 166
- Cargo area..... 170
- Warning triangle 173
- Driving with a trailer..... 174
- Towing 180



06 Maintenance and specifications

Engine compartment	184
Lamps	189
Wiper blades and washer fluid.....	195
Battery.....	197
Fuses.....	200
Wheels and tyres.....	205
Car care.....	217
Type designations	221
Specifications	222



07 Index

07





Important information

Reading the Owner's Manual

Preface

A good way of getting to know your new car is to read the owner's manual, ideally before your first journey. This will give you the opportunity to familiarise yourself with new functions, to see how best to handle the car in different situations, and to make the best use of all the car's features. Please pay attention to the safety instructions contained in the manual.

The equipment described in the owner's manual is not present in all cars. In addition to standard equipment, this manual also describes options (factory fitted equipment) and certain accessories (retrofitted extra equipment).

Volvo cars are adapted for the varying requirements of different markets, as well as for national or local legal requirements and regulations.

The specifications, design features and illustrations in this owner's manual are not binding. We reserve the right to make modifications without prior notice.

© Volvo Car Corporation

Option

All types of options are marked with an asterisk * in the Owner's Manual.

Certain functionality and equipment can be purchased as options when a new car is ordered. The range of options may apply to all cars or sometimes only to certain variants and/or certain markets.

Contact your authorised Volvo dealer for more information.

Special texts



WARNING

Texts marked with WARNING advise of risk of personal injury.



IMPORTANT

Texts marked with IMPORTANT advise of risk of material damage.



NOTE

Texts marked with NOTE give advice or tips that facilitate use of features and functions for example.

Footnote

There is footnote information in the Owner's Manual that is located at the bottom of the page or directly adjacent to a table. This information is an addition to the text that it refers to via a number.

Message texts

There are displays in the car that show text messages. These text messages are highlighted in the Owner's Manual by means of the text being slightly larger and printed in grey. Example **DIM text**.

Procedure lists

Procedures where action must be taken in a certain sequence are numbered in the Owner's Manual.

- 1 When there is a series of illustrations for step-by-step instructions each step is numbered in the same way as the corresponding illustration.
- ➔ Arrows appear numbered and unnumbered and are used to illustrate a movement.

If there is no series of illustrations for step-by-step instructions then the different steps are numbered with normal numbers.

**Important information****Position lists**

① Red circles containing a number are used in overview images where different components are pointed out. The number recurs in the position list featured in connection with the illustration that describes the item.

Step lists

A list of steps is used when there is a numbered sequence in the Owner's Manual.

Example:

- Coolant
- Engine oil

Recording data

One or more of the computers in your Volvo are capable of recording detailed information. This information is intended for use in research to enhance safety and for diagnosing faults in some of the in-car systems. The data may include details regarding seatbelt use by the driver and passengers, the functions of various vehicle systems and modules, and status information about the engine, throttle, steering, brakes and other systems. This data can also include details of the way the car is driven. This type of information can include, without being limited to, specific details such as vehicle speed, the use of the brake and accelerator pedals and steering wheel position. This latter type of data can be stored for a limited period while the car is being driven and subsequently during a collision or a near-collision. Volvo Car Corporation will not disclose the stored information without consent. However, Volvo Car Corporation may be forced to disclose the information due to national legislation. Volvo Car Corporation and its authorised workshops may also read and use the information.

Accessories and extra equipment

The incorrect connection and installation of accessories can negatively affect the car's electrical system. Certain accessories only function when their associated software is installed in the car's computer system. Always contact an authorised Volvo workshop before installing accessories which are connected to, or affect, the electrical system.



Environment

Volvo Cars' environmental philosophy



Environmental care, safety and quality are the three core values which influence all operations of the Volvo Car Corporation. We also believe that our customers share our consideration for the environment.

Your Volvo complies with strict international environmental standards and is also manufactured in one of the cleanest and most resource-efficient plants in the world. Volvo Car Corporation has global ISO certification, which includes the environmental standard (ISO 14001) covering factories, central functions, as well as several of our other units. We also set requirements for our partners so

that they work systematically with environmental issues.

EPI (Environmental Product Information) is supplied for all Volvo models. Here you can see how the environment is affected during the entire lifecycle of the car.

Read more at www.volvocars.com/EPI

Fuel consumption

Volvo cars have competitive fuel consumption in each of their respective classes. Lower fuel consumption generally results in

lower emission of the greenhouse gas, carbon dioxide.

It is possible for the driver to influence fuel consumption. For more information read under the heading, **Reducing environmental impact** below.

Efficient emission control

Your Volvo is manufactured following the concept "Clean inside and out" – a concept that encompasses a clean interior environment as well as highly efficient emission control. In many cases the exhaust emissions are well below the applicable standards.

Clean air in the passenger compartment

A passenger compartment filter prevents dust and pollen from entering the passenger compartment via the air intake.

A sophisticated air quality system, IAQS* (Interior Air Quality System) ensures that the incoming air is cleaner than the air in the traffic outside.

The system consists of an electronic sensor and a carbon filter. The incoming air is monitored continuously and if there is an increase in the level of certain unhealthy gases such as carbon monoxide then the air intake is closed. Such a situation may arise in heavy traffic, queues and tunnels for example.

The entry of nitrous oxides, ground-level ozone and hydrocarbons is prevented by the carbon filter.

Textile standard

The interior of a Volvo is designed to be pleasant and comfortable, even for people with contact allergies and for asthma sufferers. Extreme attention has been given to choosing environmentally-compatible materials. This means that they also fulfil the requirements in the Öko-Tex 100 standard¹, a major advance towards a healthier passenger compartment environment.

¹ More information on www.oekotex.com

Öko-Tex certification covers seatbelts, carpets and fabrics for example. The leather in the upholstery undergoes chromium-free tanning with natural plant substances and fulfils the certification requirements.

Volvo workshops and the environment

Regular maintenance creates the conditions for a long service life with low fuel consumption for your car. In this way you contribute to a cleaner environment. When Volvo's workshops are entrusted with the service and maintenance of your car it becomes part of our system. We make clear demands regarding the way in which our workshops are designed in order to prevent spills and discharges into the environment. Our workshop staff have the knowledge and the tools required to guarantee good environmental care.

Reducing environmental impact

You can easily help reduce environmental impact, for example, by driving economically, by purchasing eco-labelled car care products and by servicing and maintaining the car according to the instructions in the owner's manual.

The following advice will help you to do your bit for the environment: (for further advice on how you can protect the environment and drive economically, see page 160):

- Decrease fuel consumption by choosing ECO tyre pressure, see page 215.
- A roof load and ski box increase air resistance, leading to higher fuel consumption. Remove them directly after use.
- Remove unnecessary items from the car. The greater the load the higher the fuel consumption.
- If the car is equipped with an engine block heater use it for a few hours before starting from cold. This reduces fuel consumption and exhaust emissions.
- Drive gently and avoid braking too hard.
- Drive in the highest gear possible. Low engine speeds result in lower fuel consumption.
- Use engine braking to slow down.
- Avoid letting the engine idle. Pay attention to local regulations. Switch off the engine when stationary for longer periods.
- Always dispose of environmentally hazardous waste, such as batteries and oils, in an environmentally safe manner. If uncertain about disposal, consult an authorised Volvo workshop for advice.
- Service your car regularly.
- High speed increases consumption considerably due to increased wind resistance. A doubling of speed increases wind resistance four times.

These hints will help reduce fuel consumption without increasing travel time or lessening the enjoyment of driving. Apart from being kind to your car, you'll be saving money - and the Earth's resources.



Safety in the passenger compartment.....	12
Safety mode.....	25
Child safety	26

SAFETY



01



Safety in the passenger compartment

Always use seatbelts



Heavy braking can have serious consequences if the seatbelts are not used. Ensure that all passengers use their seatbelts.

It is important that the seatbelt lies against the body so it can provide maximum protection. Do not lean the backrest too far back. The seatbelt is designed to protect in a normal seating position.

Putting on a seatbelt

Pull the seatbelt out slowly and secure it by pressing the buckle into the lock. A loud "click" indicates that the seatbelt has locked.

The buckles only fit the intended lock in the rear seat.¹

¹ Certain markets

Releasing the seatbelt

Press the red lock button and then let the seatbelt retract. If the seatbelt does not retract fully, feed the seatbelt in by hand so that it does not hang loose.

The seatbelt locks and cannot be withdrawn:

- if it is pulled out too quickly.
- during braking and acceleration.
- if the car leans heavily.

Keep in mind the following:

- do not use clips or anything else that can prevent the seatbelt from fitting properly.
- ensure that the seatbelt is not twisted or caught on anything.
- the hip strap must be positioned low down (not over the abdomen).
- tension the hip strap over the lap by pulling the diagonal shoulder belt as illustrated.

WARNING

The seatbelts and airbags interact. If a seatbelt is not used or is used incorrectly, this may diminish the protection provided by the airbag in the event of a collision.

WARNING

Each seatbelt is designed for only one person.

WARNING

Never modify or repair the seatbelts yourself. Contact an authorised Volvo workshop.

If a seatbelt has been subjected to a major load, such as in conjunction with a collision, the entire seatbelt must be replaced. Some of the protective characteristics of the seatbelt may have been lost, even if it appears to be undamaged. In addition, replace the seatbelt if the belt is worn or damaged. The new seatbelt must be type-approved and intended for installation in the same position as the replaced seatbelt.



Safety in the passenger compartment

Seatbelts and pregnancy



The seatbelt should always be worn during pregnancy. But it is crucial that it be worn in the correct way. The diagonal section should wrap over the shoulder then be routed between the breasts and to the side of the abdomen.

The lap section should lay flat over the thighs and as low as possible under the abdomen. – It must never be allowed to ride upward. Remove all slack from the seatbelt and ensure that it fits close to the body. In addition, check that there are no twists in the seatbelt.

As the pregnancy progresses, pregnant drivers should adjust their seats and steering wheel such that they can easily maintain control of the vehicle as they drive (which means that they must be able to easily operate the

foot pedals and steering wheel). They should strive to position the seat with as large a distance as possible between their abdomen and the steering wheel.

Seatbelt reminder¹



An audio signal and indicator lamp remind anyone not wearing a seatbelt to use one. The audio reminder is speed dependent, and in some cases time dependent. The visual reminder is located in the roof console and the combined instrument panel.

Child seats are not covered by the seatbelt reminder system.

Rear seat

The seatbelt reminder in the rear seat has two subfunctions:

- To provide information on which seatbelts are being used in the rear seat. The message is shown on the information display when the seatbelts are being used or

¹ Certain markets



Safety in the passenger compartment

when the rear doors are opened. The message is automatically cleared after approx. 30 seconds or it can be acknowledged manually by pressing the **READ** button.

- Provides a warning if one of the rear seatbelts is unfastened during travel. This warning takes the form of a message on the information display along with the audio/visual signal. The warning stops when the seatbelt is re-fastened, or it can also be acknowledged manually by pressing the **READ** button.

The message on the information display showing which seatbelts are in use is always available. Press the **READ** button to see stored messages.

Certain markets

An audio signal and indicator lamp remind the driver if not wearing a seatbelt to use one. At low speed, the audio reminder will sound for the first six seconds.

Seatbelt tensioner

All the seatbelts are equipped with belt tensioners. A mechanism in the seatbelt tensioner tightens the seatbelt in the event of a sufficiently violent collision. The seatbelt then provides more effective restraint for the occupants.

Warning symbol on the combined instrument panel

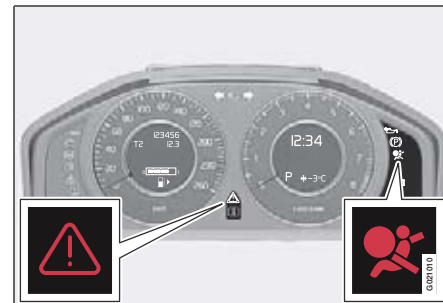

The airbag system is continually monitored by the system's control module. The warning symbol on the combined instrument panel illuminates in ignition position **II** or **III**. The symbol goes out after approx. 6 seconds provided the airbag system is fault-free.



WARNING

If the warning symbol for the airbag system remains illuminated or illuminates while driving, it means that the airbag system does not have full functionality. The symbol indicates a fault in the seatbelt tensioner system, SIPS, IC system or some other fault in the SRS system. Contact an authorised Volvo workshop urgently.



Safety in the passenger compartment

As well as the warning symbol, a message may appear on the information display in appropriate cases. If the warning symbol malfunctions, the warning triangle illuminates and the message **SRS Airbag Service required** or **SRS Airbag Service urgent** appears on the display. contact an authorised Volvo workshop urgently.

Airbag (SRS) on the driver's side

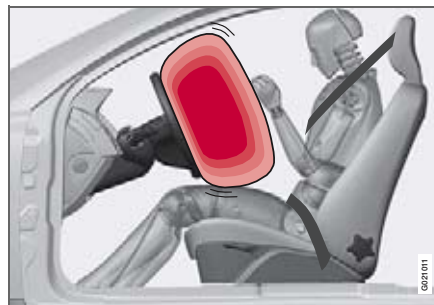

The car has an SRS airbag (Supplemental Restraint System) on the driver's side to supplement the protection afforded by the seatbelt. This airbag is fitted into the centre of the steering wheel. The steering wheel is marked **SRS AIRBAG**.

WARNING

The seatbelts and airbags interact. If a seatbelt is not used or is used incorrectly, this may diminish the protection provided by the airbag in the event of a collision.

Passenger airbag (SRS)

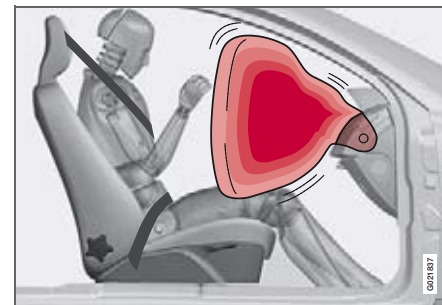

The car has an airbag to supplement the protection afforded by the seatbelt on the passenger side. This airbag is folded up into a compartment above the glovebox. The cover panel is marked **SRS AIRBAG**.

WARNING

To minimise the risk of injury if the airbag deploys, passengers must sit as upright as possible with their feet on the floor and backs against the backrest. Seatbelts must be secured.

WARNING

Do not put objects in front of or above the dashboard where the passenger airbag is located.



Safety in the passenger compartment

WARNING

Never place a child in a child seat or on a booster cushion in the front seat if the airbag is activated.¹

Never allow a child to stand or sit in front of the front passenger seat. No one shorter than 140 cm should ever sit in the front passenger seat if the airbag is activated.

Failure to follow the advice given above can endanger the life of the child.

¹For information on how to activate/deactivate the airbag, see page 18.

Airbag system

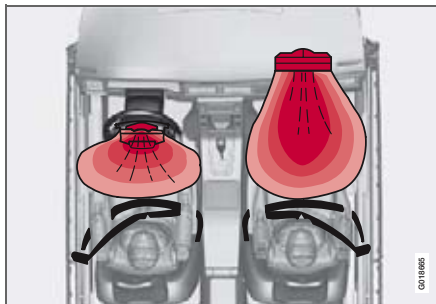

SRS system, left-hand drive

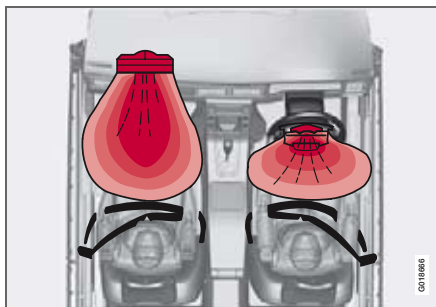

SRS system, right-hand drive

The SRS system consists of airbags and sensors. A sufficiently violent collision trips the sensors and the airbag(s) are inflated with hot

gas. To cushion the impact, the airbag deflates when compressed. When this occurs, smoke escapes into the car. This is completely normal. The entire process, including inflation and deflation of the airbag, occurs within tenths of a second.

WARNING

Repairs must only be performed by an authorised Volvo workshop. Any interference in the airbag system could cause malfunction and result in serious personal injury.

NOTE

The sensors react differently depending on the course of the collision and whether or not the seatbelts on the driver and passenger side are used.

It is therefore possible that only one (or none) of the airbags may inflate in a collision. The airbag system senses the force of the collision on the car and adapts accordingly so that one or more airbags is deployed.

The capacity of the airbags is also adapted to the collision force to which the vehicle is subjected.

**Safety in the passenger compartment**

01



Location of the front passenger airbag in a left-hand drive car



Location of the front passenger airbag in a right-hand drive car



Safety in the passenger compartment

PACOS*



Indicator in the roof console showing that the passenger airbag (SRS) is deactivated.

The airbag (SRS) for the front passenger seat can be deactivated if the car is equipped with a switch, PACOS (Passenger Airbag Cut Off Switch). For information on how to activate/deactivate, see page 19.

Messages

A text message and a symbol in the roof panel indicate that the airbag for the front passenger seat is deactivated (see illustration above).

A warning symbol in the roof panel indicates that the airbag for the front passenger seat is activated (see illustration below).



Indicator in roof console showing that the passenger airbag (SRS) is activated.

NOTE

When the remote control key is turned to ignition position II or III the warning symbol for the airbag is shown in the combined instrument panel for approx. 6 seconds (see page 14).

Following which, the indicator in the roof console is illuminated showing the correct status for the front passenger seat airbag. For more information on the different ignition positions, see page 65.

Activating/deactivating

The switch for the passenger airbag (PACOS) is located on the passenger end of the instrument panel and is accessible when the passenger door is open, (see under the heading, Switch – PACOS below). Check that the switch is in the required position. Volvo recommends that the key blade be used to change position.

For information on the key blade, see page 42. (Other items with a shape similar to a key can also be used.)

WARNING

Failure to follow the advice given above could endanger the life of passengers in the car.

WARNING

If the car is equipped with a front passenger airbag, but has no switch (PACOS, Passenger Airbag Cut Off Switch), then the airbag is always activated.

WARNING

Never place a child in a child seat or on a booster cushion in the front seat if the airbag is activated and the symbol in the roof console is illuminated. Failure to follow this advice could endanger the life of the child.



Safety in the passenger compartment

WARNING

Do not allow anyone to sit in the front passenger seat if the message in the roof panel (see page 18) indicates that the airbag is deactivated and if the warning symbol for the airbag system is also displayed in the combined instrument panel. This indicates that there has been a severe malfunction. Contact an authorised Volvo workshop immediately.

Switch – PACOS

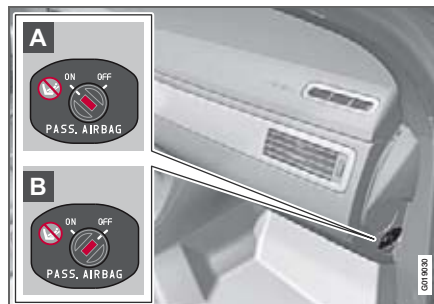

Switch location.

- A** The airbag is activated. With the switch in this position, persons taller than 140 cm can sit in the front passenger seat, but never children in a child seat or on a booster cushion.
- B** The airbag is deactivated. With the switch in this position, children in a child seat or on a booster cushion can sit in the front passenger seat, but never persons taller than 140 cm.

WARNING

Activated airbag (passenger seat):

Never place a child in a child seat or on a booster cushion on the front passenger seat when the airbag is activated. This applies to everyone shorter than 140 cm.

Deactivated airbag (passenger seat):

No one taller than 140 cm should ever sit in the front passenger seat when the airbag is deactivated.

Failure to follow the advice given above could endanger life.



Safety in the passenger compartment

Side airbags – SIPS bags



A large proportion of the collision force is transferred by the SIPS (Side Impact Protection System) to beams, pillars, the floor, the roof and other structural parts of the body. The side airbags at the driver's and front passenger seats protect the chest area and the hip and are an important part of the SIPS. The SIPS bag system consists of two main components, side airbag and sensors. The

side airbags are located in the front seat backrests.

WARNING

Repairs must only be performed by an authorised Volvo workshop.
Any interference in the SIPS bag system could cause malfunction and result in serious personal injury.

WARNING

Do not put objects in the area between the outside of the seat and the door panel, since this area is required by the side airbag.

WARNING

Use only seat covers approved by Volvo. Other seat covers may impede the operation of the side airbags.

WARNING

The side airbag is a supplement to the seatbelts. Always use a seatbelt.

Child seats and side airbags

The side airbag does not diminish the protection provided by the car to children seated in a child seat or on a booster cushion.

A child seat/booster cushion can be placed on the front passenger seat provided that the car does not have an activated¹ passenger airbag.

¹ For information on how to activate/deactivate the airbag, see page 18.



Safety in the passenger compartment

SIPS bags

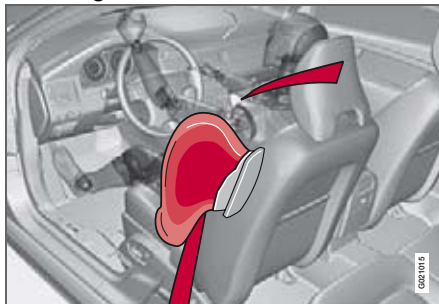

Driver's seat, left-hand drive

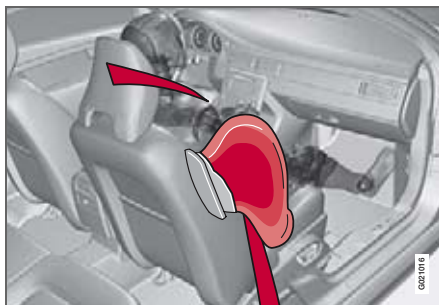

Front passenger seat, left-hand drive

The SIPS bag system consists of side airbags and sensors. A sufficiently violent

collision trips the sensors and the side airbags are inflated. The airbag inflates between the occupant and the door panel and thereby cushions the initial impact. The airbag deflates when compressed by the collision. The side airbag is normally only deployed on the side of the collision.

SIPS bag decal

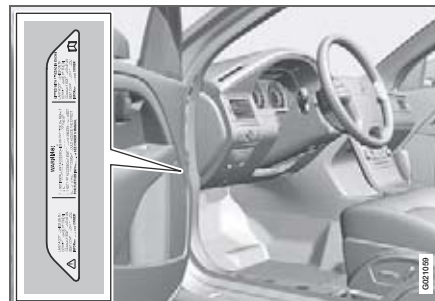

The SIPS airbag decal is located on the door pillar

Inflatable Curtain – IC



The inflatable curtain IC (Inflatable Curtain) is a supplement to the SIPS and SRS airbags. It is fitted in the headlining along both sides of the roof and protects all of the vehicle's outer seats. A sufficiently violent collision trips the sensors and the inflatable curtain is inflated. The inflatable curtain helps to prevent the driver and passengers from striking their heads on the inside of the car during a collision.



Safety in the passenger compartment

WARNING

Never hang or attach heavy items onto the handles in the roof. The hook is only designed for light clothing (not for solid objects such as umbrellas for example).

Do not screw or install anything onto the car's headlining, door pillars or side panels. This could compromise the intended protection. Only ever use Volvo genuine parts that are approved for placement in these areas.

WARNING

Do not load the car higher than 50 mm under the top edge of the side windows. Otherwise, the intended protection of the inflatable curtain, which is concealed in the headlining, may be compromised.

WARNING

The inflatable curtain is a supplement to the seatbelts.
Always use a seatbelt.

Protection against whiplash injury – WHIPS

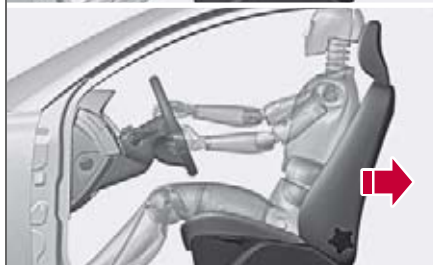
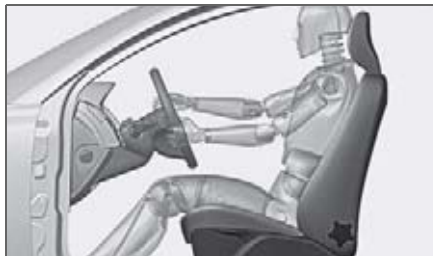

The whiplash protection system (WHIPS) consists of energy absorbing backrests and specially designed head restraints in the front seats. The system is actuated by a rear-end collision, where the angle and speed of the collision, and the nature of the colliding vehicle all have an influence.

WARNING

The WHIPS system is a supplement to the seatbelts. Always use a seatbelt.

Properties of the seat

When the WHIPS system is deployed, the front seat backrests are lowered backward to alter the seating position of the driver and front seat passenger. This reduces the risk of whiplash injury.

WARNING

Never modify or repair the seat or WHIPS system yourself. Contact an authorised Volvo workshop.

WHIPS system and child seats/booster cushions

The WHIPS system does not diminish the protection provided by the car to children



Safety in the passenger compartment

seated in a child seat or on a booster cushion.

Correct seating position

For the best possible protection, the driver and front seat passenger should sit in the centre of the seat with as little space as possible between the head and the head restraint.

WARNING

If a seat has been subjected to extreme forces, such as due to a rear-end collision, the WHIPS system must be checked by an authorised Volvo workshop.

Part of the WHIPS system's protective capacity may have been lost even if the seats appear to be undamaged. Contact an authorised Volvo workshop to have the system checked even after a minor rear-end collision.

Do not obstruct the WHIPS system



WARNING

Do not squeeze rigid objects between the rear seat cushion and the front seat backrest. Make sure you do not obstruct the function of the WHIPS system.



WARNING

If a rear seat backrest is folded down, the corresponding front seat must be moved forward so that it does not touch the folded backrest.



Safety in the passenger compartment

When the systems deploy

System	Triggered
Seatbelt tensioner, front seat	In a frontal collision and or side-impact accident and or rear-end collision
Seatbelt tensioner, rear seat	In a frontal collision
Airbags (SRS)	In a frontal collision ¹
Side airbags (SIPS)	In a side-impact accident ¹
Inflatable Curtain IC	In a side-impact accident ¹
Whiplash protection WHIPS	In a rear-end collision

¹The bodywork of the car could be greatly deformed in a collision even without airbag deployment. A number of factors such as the rigidity and weight of the object hit, the speed of the car, the angle of the collision etc. affects how the different safety systems of the car are activated.

If the airbags have deployed, the following is recommended:

- Have the car transported to an authorised Volvo workshop. Do not drive with deployed airbags.
- Let an authorised Volvo workshop replace components in the car's safety system.
- Always contact a doctor.

i NOTE

The SRS, SIPS, IC and belt tensioner systems are deployed only once during a collision.



WARNING

The airbag control module is located in the centre console. If the centre console is drenched with water or other liquid, disconnect the battery cables. Do not attempt to start the car since the airbags may deploy. Have the car transported to an authorised Volvo workshop.



WARNING

Never drive with deployed airbags. They can make steering difficult. Other safety systems may also be damaged. The smoke and dust created when the airbags are deployed can cause skin and eye irritation/injury after intensive exposure. In case of irritation, wash with cold water. The rapid deployment sequence and airbag fabric may cause friction and skin burns.



Safety mode



If the car is involved in a collision, the text **Safety mode - See manual** may appear on the information display. This means that the car has reduced functionality. Safety mode is a protective state that is enforced when the collision may have damaged any of the car's vital functions, such as the fuel lines, sensors for one of the safety systems, or the brake system.

Attempting to start the car

First, check that no fuel is leaking from the car. There must be no smell of fuel either.

If everything seems normal and you have checked for indications of fuel leakage, you may attempt to start the car.

Firstly, remove the remote control key and then reinsert it. The car's electronics will then try to reset themselves to normal mode. Then try to start the car. If the message **Safety mode** is still shown on the display then the car must not be driven or towed. Even if the car appears to be driveable, hidden damage may make the car impossible to control once moving.

Moving the car

If **Normal mode** is shown after **Safety mode** has been reset, the car can be moved carefully out of a dangerous position. Do not move the car further than necessary.

WARNING

Never attempt to repair your car or reset the electronics yourself if the car has been in safety mode. This could result in personal injury or the car not functioning as normal. Always allow an authorised Volvo workshop to check and restore the car to normal status after **Safety mode** has been displayed.

WARNING

Never, under any circumstances, attempt to restart the car if it smells of fuel when the **Safety mode** message is displayed. Leave the car at once.

WARNING

If the car is in safety mode it must not be towed. It must be transported to an authorised Volvo workshop.



Child safety

Children should sit comfortably and safely

The position of a child in the car and the choice of equipment are dictated by the child's weight and size, for more information see page 28.

i NOTE

Legislation regarding the placement of children in cars varies from country to country. Check what laws apply.

Children of all ages and sizes must always sit correctly secured in the car. Never allow a child to sit on the knee of a passenger.

Volvo's own child safety equipment is designed for your car. Use Volvo genuine equipment to best ensure that the mounting points and attachments are correctly positioned and are sufficiently strong.

i NOTE

If problems arise when fitting child safety products, contact the manufacturer for clearer instructions.

Child seats



Child seats and airbags are not compatible.

Volvo has child safety products that are designed for and tested by Volvo.

i NOTE

When using child safety products it is important to read the installation instructions included.

Do not attach the straps for the child seat to the horizontal adjustment bar, springs, rails or beams under the seat. Sharp edges can damage the straps.

Allow the back of the child seat to rest against the dashboard. This applies to cars without a passenger airbag, or where the airbag is deactivated.

Location of child seats

You may place:

- a child seat or booster cushion on the front passenger seat, provided the passenger airbag¹ is not activated.
- a rear-facing child seat in the rear seat that uses the back of the front seat as support.

Always place a child in the rear seat if the passenger airbag is activated. A child sitting on the front passenger seat could suffer serious injury if the airbag deploys.

! WARNING

Never place a child in a child seat or on a booster cushion in the front seat if the airbag (SRS) is activated.

No one shorter than 140 cm should ever sit in the front passenger seat if the airbag (SRS) is activated.

Failure to follow the advice given above can endanger the life of the child.

¹ For information on activated/deactivated airbag (SRS), see page 18.

**! WARNING**

Booster cushions/child seats with steel braces or some other design that could rest on the seatbelt buckle's opening button must not be used, as they could cause the seatbelt buckle to open accidentally.

Do not allow the upper section of the child seat to rest against the windscreen.

Airbag decal

Decal located on instrument panel end face on the passenger side.



Decal located on instrument panel end face on the passenger side (Australia only).



Child safety

Recommended child seats

Weight/Age	Front seat	Outer rear seat	Centre rear seat
Group 0 max. 10 kg (0–9 months) Group 0+ max 13 kg	Volvo Child seat – rear-facing child seat, secured with the car’s seatbelt and straps. Type approval: E5 03135	Volvo Child seat – rear-facing child seat, secured with the car’s seatbelt, straps and support legs. Type approval: E5 03135	
	Britax Baby Safe Plus – rear-facing child seat, secured with the ISOFIX fixture system. Type approval: E1 03301146	Britax Baby Safe Plus – rear-facing child seat, secured with the ISOFIX fixture system. Type approval: E1 03301146	Britax Baby Safe Plus – rear-facing child seat, secured with the car’s seatbelt. Type approval: E1 03301146
Group 1 9–18 kg (9–36 months)	Volvo Child seat – rear-facing child seat, secured with the car’s seatbelt and straps. Type approval: E5 03135	Volvo Child seat – rear-facing child seat, secured with the car’s seatbelt, straps and support legs. Type approval: E5 03135	
	Britax Freeway – rear-facing child seat, secured with the ISOFIX fixture system and straps. Type approval: E5 03171	Britax Freeway – rear-facing child seat, secured with the ISOFIX fixture system and straps. Type approval: E5 03171	
Group 2/3 15 – 36 kg (3–12 yr)	Volvo Booster cushion – with or without backrest. Type approval: E5 03139	Volvo Booster cushion – with or without backrest. Type approval: E5 03139	Volvo Booster cushion – with or without backrest. Type approval: E5 03139
		Volvo 2-stage Integrated booster cushion – available as a factory fitted option. Type approval: E.G. XXXXX	

With regard to other child seats your car should be included in the manufacturer’s enclosed list of vehicles or be universally approved in accordance with the ECE R44 legal requirement.



Child safety

Integrated two-stage booster cushions*



Correct position, the seatbelt is positioned above the shoulder.



Incorrect position, the head must not be positioned above the head restraint and the seatbelt must not be below the shoulder.

The booster cushions are specially designed to provide optimum safety. In combination with the seatbelt they are approved for children who weigh between 15 and 36 kg and who are 95 to 140 cm in height.

Check before driving that:

- the 2-stage integrated booster cushion is correctly set (see table) and in locked position
- the seatbelt is in contact with the child's body and is not slack or twisted
- the seatbelt does not lie across the child's throat or below the shoulder (see illustration above)
- the lap section of the seatbelt is positioned low over the pelvis to provide optimal protection.

	Stage 1	Stage 2
Weight	22 - 36 kg	15-25 kg
Height	115 - 140 cm	95 - 120 cm

For instructions on adjusting the booster cushion's two levels, see page 29-30.

Raising the two-stage booster cushion

Stage 1

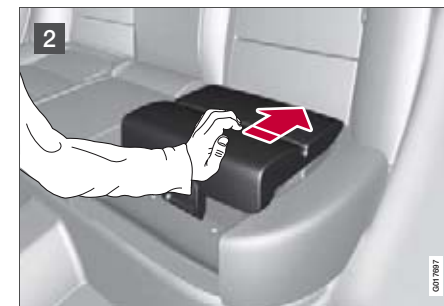

- 1 Pull the handle forward (1) and up (2) in order to release the booster cushion.
- 2 Press the booster cushion backwards to lock.



Child safety

Stage 2



- 1 Start from level 1. Press the button.
- 2 Lift the booster cushion up at the front edge (1) and press it back (2) against the backrest to lock.

WARNING

Repair or replacement should only be performed by an authorised Volvo workshop. Do not make any modifications or additions to the booster cushion. If an integrated booster cushion has been subjected to a major load, such as in conjunction with a collision, the entire booster cushion must be replaced. Even if the booster cushion appears to be undamaged, it may not afford the same level of protection. The booster cushion must also be replaced if it is heavily worn.

NOTE

It is not possible to adjust the booster cushion from stage 2 to stage 1. It must first be reset by being fully folded into the seat cushion. Refer to the heading below, Lowering the two-stage booster cushion.

Lowering the two-stage booster cushion

Lowering can take place from both the upper and lower stage to fully lowered position in the cushion. However, it is not possible to adjust the booster cushion from the upper stage to the lower stage.





Child safety

01

- 1 Pull the handle forwards to release the cushion.
- 2 Press down with your hand in the centre of the cushion in order to lock it.

WARNING

If the instructions regarding the two-stage booster cushion are not followed then this could cause serious injury to a child in the event of an accident.

IMPORTANT

Check that there are no loose objects (e.g. toys) left behind in the space under the cushion before lowering.

NOTE

The booster cushion must be lowered first when lowering the backrest.

Child safety locks, rear doors

The controls for operating the rear door power windows and the rear door opening handles can be blocked from opening from the inside. For more information, see page 50.

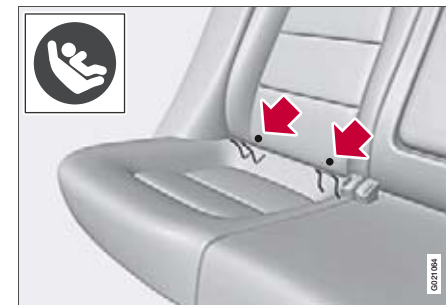
ISOFIX fixture system for child seats

Mounting points for the ISOFIX fixture system are concealed behind the lower section of the rear seat backrest, in the outer seats.

The location of the mounting points is indicated by symbols in the backrest upholstery (see illustration above).

Press the seat cushion down to access the mounting points.

NOTE

The ISOFIX fixture system is an accessory for the passenger seat.

Always follow the manufacturer's installation instructions when connecting a child seat to the ISOFIX mounting points.



Child safety

Size classes

Child seats are in different sizes – cars are in different sizes. This means that not all child seats are suitable for all seats in all car models.

Consequently a size classification has been introduced for child seats using the ISOFIX fixture system in order to assist users in choosing the correct child seat (see table below).

Size class	Description
A	Full size, front-facing child seat
B	Reduced size (alt.1), front-facing child seat
B1	Reduced size (alt.2), front-facing child seat
C	Full size, rear-facing child seat
D	Reduced size, rear-facing child seat
E	Rear-facing infant seat
F	Transverse infant seat, left-hand
G	Transverse infant seat, right-hand

**Types of ISOFIX child seat**

Type of child seat	Weight (Age)	Size class	Passenger seats for ISOFIX installation of child seats	
			Front seat	Outer rear seat
Infant seat transverse	max. 10 kg (0-9 months)	F	-	-
		G	-	-
Infant seat, rear-facing	max. 10 kg (0-9 months)	E	OK	OK
Infant seat, rear-facing	max. 13 kg (0-12 months)	E	OK	OK
		D	OK	OK
		C	-	OK
Child seat, rear-facing	9-18 kg (9-36 months)	D	OK	OK
		C	-	OK
Child seat, rear-facing	9-18 kg (9-36 months)	B	OK ¹	OK ¹
		B1	OK ¹	OK ¹
		A	OK ¹	OK ¹

¹Volvo recommends rear-facing child seats for this group.

**WARNING**

Never place a child in the passenger seat if the car is equipped with an activated air-bag.

**NOTE**

If an ISOFIX child seat has no size classification then the car model must be included on the child seat's vehicle list.

**NOTE**

Contact a Volvo dealer for Volvo recommendations on ISOFIX child seats.



Child safety

Upper mounting points for child seats

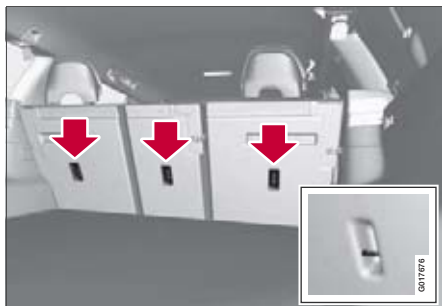

The car is equipped with upper mounting points for certain front-facing child seats. These mounting points are located on the rear of the seat.

For cars with folding head restraints on the outside seats the head restraints should be folded to facilitate the installation of this type of child seat.

For cars equipped with a cargo cover over the cargo area, the cargo cover must be removed before a child seat can be fitted in the mounting points.

The upper mounting points are primarily intended for use with front-facing child seats. Volvo recommends that small children

should sit in rear-facing child seats for as long as possible.

For detailed information on how the child seat should be tensioned in the upper mounting points, see the seat manufacturer's instructions.



WARNING

The child seat's straps must always be routed under the rear head restraints before being tensioned at the mounting point.



[Empty rectangular box]

01

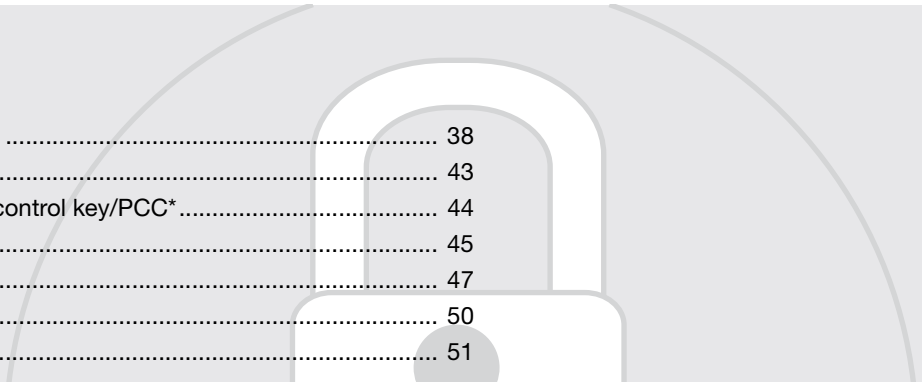

Remote control key/key blade	38
Privacy locking*	43
Battery replacement, remote control key/PCC*	44
Keyless drive*	45
Locking/unlocking	47
Child safety locks	50
Alarm*	51

LOCKS AND ALARM



02



Remote control key/key blade

General

The car is supplied with two remote control keys or PCCs (Personal Car Communicator). They are used to start the car and for locking and unlocking.

More remote control keys can be ordered – up to six can be programmed and used for the same car.

The PCC has increased functionality compared with the remote control key. Only the remote control key is referred to in the remainder of this chapter when describing functions available in both the PCC and remote control key.

WARNING

If there are children in the car: Always remember to switch off the power supply to locks, power windows and sunroof by removing the remote control key if the driver leaves the car.

Detachable key blade

A remote control key contains a detachable metal key blade for mechanical locking/unlocking of the driver's door, glovebox and tailgate (privacy locking).

For key blade functions, see page 42.

For privacy locking, see page 43.

The key blades' unique code is available at authorised Volvo workshops, who can order new key blades.

Loss of a remote control key

If you lose a remote control key then new ones can be ordered at an authorised Volvo workshop. The remaining remote control keys must then be taken to the workshop. The code of the missing remote control key must be erased from the system as a theft prevention measure.

The current number of keys registered to the car can be checked under **Car settings** → **Car key memory** → **Number of keys**. For a description of the menu system, see page 104.

Key memory – door mirrors and driver's seat*

The settings are automatically connected to each respective remote control key, see page 67 and 84.

The function can be activated/deactivated under **Car settings** → **Car key memory** → **Seat & mirror positions**. For a description of the menu system, see page 104.

For cars with Keyless drive function, see page 45.

Indicator for locking/unlocking

When the car is locked or unlocked using the remote control key, the direction indicators confirm that locking/unlocking was correctly performed:

- Locking; one flash
- Unlocking; two flashes.

After locking the indication is only given if all locks are activated once the doors have been closed.

The function can be activated/deactivated under **Car settings** → **Light settings** → **Lock confirmation light** or **Car settings** → **Light settings** → **Unlock confirmation light**. For a description of the menu system, see page 104.

Immobiliser

Each remote control key has a unique code. The car can only be started with the correct remote control key with the correct code.

The following error messages in the information display (on the combined instrument

**Remote control key/key blade**

panel) are related to the electronic immobiliser:

Message	Specification
Key error Try again	Error reading remote control key during start. Try to start the car again.
Car key Not found	Applies only to the PCC's Keyless drive function. Errors reading the PCC during starting. Try to start the car again.
Immobiliser See manual	Remote control key function error during start. Contact an authorised Volvo workshop.

For starting the car, see page 88.

Low battery in remote control key

The batteries should be replaced if;

- the information symbol illuminates and **Car key Battery low** is shown in the display
- and/or
- the locks repeatedly do not react to signals from the remote control key within 20 metres.

For changing the battery, see page 44.

Functions

Remote control key



PCC* (Personal Car Communicator)

- 1 Locking
- 2 Unlocking
- 3 Approach lighting
- 4 Tailgate
- 5 Panic function

Total airing function (global opening)

One long press (at least 4 seconds) on button **1** or **2** opens or closes all windows (also closes the sunroof).

WARNING

If the sunroof and windows are closed using the remote control key, check that no one is in danger of getting hands caught.

The function can be used to quickly air the car in hot weather for example.

Function buttons

Locking – Locks the doors and tailgate and then activates the alarm.

Unlocking – Unlocks the doors and tailgate while the alarm is deactivated.

The function can be changed from unlocking all doors simultaneously, to opening the driver's door after one press of the button and opening the remaining doors after a further press of the button (within 10 seconds).



02 Locks and alarm

Remote control key/key blade

The function is changed under **Car settings** → **Lock settings** → **Doors unlock**. For a description of the menu system, see page 104.

Approach lighting – Used to switch on the car's lighting at a distance. For more information, see page 76.

Tailgate – Unlocks the tailgate without opening it¹. For more information, see page 48.

Panic function – Used to attract attention in an emergency.

Press and hold the red button for at least 3 seconds or press it twice within 3 seconds to activate the direction indicators and the horn.

The function can be turned off with the same button once it has been active for at least 5 seconds. Otherwise the function switches off automatically after 2 minutes and 45 seconds.

Range

The remote control has a range of up to 20 m from the car.

NOTE

The remote control key functions can be disrupted by surrounding radio waves, buildings, topographical conditions etc. The car can always be locked/unlocked using the key blade, see page 42.

Unique functions PCC*



1 Information button

2 Indicator lamps

Using the information button **1** enables access to certain information from the car via the indicator lamps **2**.

Using the information button

1. Press the information button **1**.
2. All indicator lamps **2** flash for approximately 7 seconds and the light travels around on the PCC.
This indicates that the information from the car has been read. If any of the other buttons are pressed during this time then the reading is interrupted.

¹ The tailgate opens on cars with automatic tailgate control.

**Remote control key/key blade****i NOTE**

If none of the indicator lamps illuminates with repeated use of the information button and in different locations (as well as after 7 seconds and after the light has travelled around on the PCC), contact an authorised Volvo workshop.

The indicator lamps **2** provide the information shown in the following illustration.

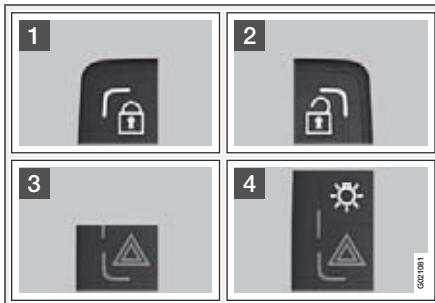

- 1** Green continuous light: The car is locked.
- 2** Yellow continuous light: The car is unlocked.
- 3** Red continuous light: The alarm has been triggered.
- 4** Red light flashing alternately in the two indicator lamps: indicates, using the HBS

(Heart Beat Sensor), that someone may be in the car. This indication is only displayed if the alarm was triggered.

Range

The PCC lock functions have a range of up to 20 m from the car.

The approach lighting, panic function and the functions controlled by the information button have a range of up to a maximum of 100 m from the car.

i NOTE

The information button functions can be disrupted by surrounding radio waves, buildings, topographical conditions etc.

Out of PCC range

If the PCC is too far away from the car for the information to be read then the status the car was last left in is shown, without the light travelling around on the PCC.

The PCC that was last used for locking/unlocking will show the correct status.

i NOTE

If no indicator lamps illuminate when the information button is used then this can be because the last communication between the PCC and the car was disrupted by surrounding radio waves, buildings, topographical conditions etc.

Heart Beat Sensor

The function **4** operates using an HBS (Heart beat sensor). HBS is a supplement to the car's alarm system and can indicate at a distance whether anybody is in the car. This indication is only displayed if the alarm was triggered.

The HBS detects an individual's heartbeat that is transmitted to the car's bodywork. For this reason the function of the HBS can be disturbed in an environment subject to noise and vibration.

Keyless drive

See page 45.



Remote control key/key blade

Detachable key blade

Using the remote control key's detachable key blade;

- the driver's door can be opened manually if central locking is not activated with the remote control key
- access to the glovebox and cargo area (privacy locking)¹ is blocked, see 43.

Removing the key blade



Slide the spring-loaded catch to the side while pulling the key blade straight out backwards .

Inserting the key blade

Carefully refit the key blade in place in the remote control key to avoid damaging it.

1. Hold the remote control key with the slot pointed up and lower the key blade into its slot.
2. Lightly press the key blade. You should hear a "click" when the key blade is locked in.

Unlocking doors with the key blade

If central locking cannot be activated with the remote control key, e.g. if the batteries are discharged, then the driver's door can be opened as follows:

1. Unlock the driver's door using the key blade in the door handle's keyhole.



NOTE

When the driver's door is unlocked using the key blade and is opened, the alarm is triggered.

2. Deactivate the alarm by inserting the remote control key in the ignition switch.

¹ Applies to certain markets

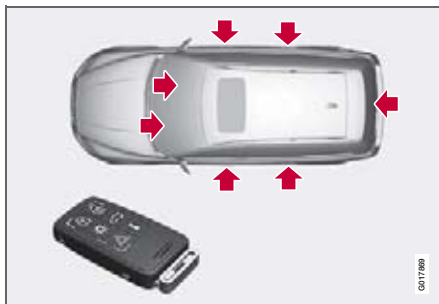

Privacy locking*

Privacy locking¹.

Active locks for remote control key, **with** key blade and privacy locking not activated.



Active locks for remote control key, **without** key blade and **with** privacy locking activated.

This function is intended for when the car is left for service, with a hotel parking valet or similar. The glovebox is then locked and the tailgate lock is disconnected from the central locking. The cargo area cannot be opened with either the central locking button in the front doors or the remote control key.

This means that the remote control key without key blade can only be used to activate/deactivate the alarm, to open the doors and to drive the car.

The remote control key is handed over without the detachable key blade which the owner then keeps.

i NOTE

Do not forget to pull out the cargo cover over the cargo area before closing the tailgate, see page 171.

Activating/deactivating



Activating privacy locking.

To activate privacy locking:

- 1** Insert the key blade in the glovebox lock.
- 2** Turn the key blade 180 degrees clockwise.
- 3** Pull out the key blade (the information display shows a message).

i NOTE

Do not reinsert the key blade into the remote control key but keep it in a safe place instead.

- Deactivation takes place in reverse order.
- For information on locking the glovebox only, see page 48.

¹ Certain markets.



Battery replacement, remote control key/PCC*

Replacing the battery

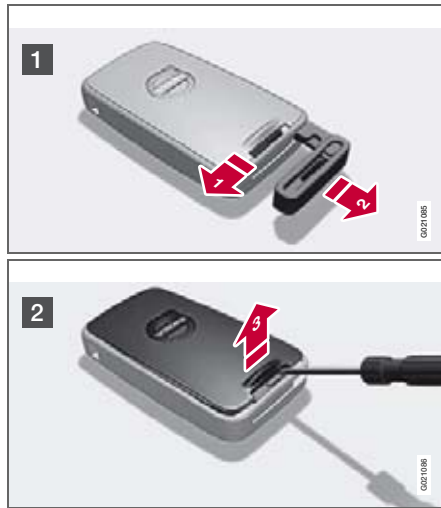

Battery type: CR2430, 3 V (one in remote control key and two in the PCC).

Opening

- 1 Slide the spring-loaded catch to the side while pulling the key blade straight out backwards .

- 2 Insert a screwdriver in the hole behind the spring-loaded catch and gently prise the remote control key up.

i **NOTE**
Turn the remote control key over with the buttons facing up, this is to avoid the batteries falling out when it is opened.

i **IMPORTANT**
Avoid touching the battery and its terminals with your fingers, as this could damage their functionality.

Battery replacement

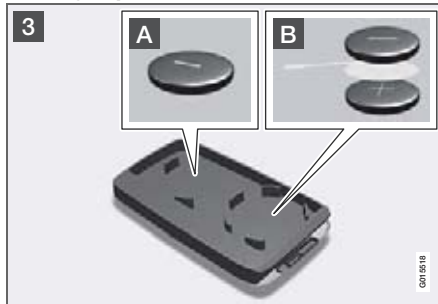

- 3 Closely study how the battery/batteries are secured on the inside of the cover, with regard to their (+) and (-) sides.

Remote control key

- A Carefully prise out the battery. Install a new one with the (+) side down.

PCC

- B Carefully prise out the batteries. First install one new one with the (+) side up. Position the white plastic tab in between and finally install a second new battery with the (+) side down.

Assembly

1. Press the remote control key together.
2. Hold the remote control key with the slot pointed up and lower the key blade into its slot.
3. Lightly press the key blade. You should hear a "click" when the key blade is locked in.

i **IMPORTANT**
Make sure that you dispose of old batteries in an environmentally-friendly way.

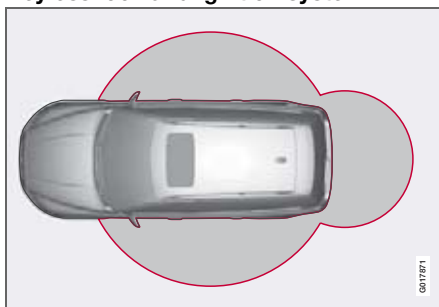
**Keyless drive*****Keyless drive (only PCC*)****Keyless lock and ignition system**

The keyless drive function in the PCC allows the car to be unlocked, driven and locked without the need for a key. You simply have to have the PCC with you. The system makes it easier and more convenient to open the car, for example when your hands are full.

The car's two PCCs incorporate the Keyless function. Additional PCCs can be ordered.

PCC range

In order to open a door or the tailgate, a PCC must be no more than approx. 1.5 metres from the car's door handle or tailgate. This means that the person who wishes to lock or unlock a door must be carrying the PCC. It is not possible to lock or unlock a door if the

PCC is on the other side of the car to the door.

The red circles in the illustration indicate the range covered by the system's antennas.

If all PCCs are removed from the car and if all doors are closed then a warning message is shown in the information display and an audio reminder signal sounds at the same time. The message disappears when a PCC is brought back to the car.

The warning message and audio reminder signal disappear when the PCC is brought back to the car after;

- a door has been opened and closed
- the PCC is inserted into the ignition switch
- the **READ** button has been pressed.

Handling the PCC safely

If a PCC with keyless drive function is left in the car, it is deactivated temporarily when the car is locked. This prevents unauthorised entry.

However, if someone breaks into the car, opens the door and finds the PCC, it can be reactivated. It is therefore important to handle all PCCs with equal care.

**IMPORTANT**

Never leave a PCC behind in the car.

Interference to PCC function

Electromagnetic fields and screening can interfere with the keyless drive system. For this reason, do not place the PCC near mobile phones or metallic objects.

If interference is experienced nonetheless, use the PCC and key blade in the normal way, see page 39.

Unlocking

Open the doors with the door handles or open the tailgate with the tailgate's handle.

Unlocking with the key blade

If the keyless drive function in the PCC is not operating, then the driver's door can be unlocked with the key blade. In this case central locking is not activated.

**NOTE**

Unlocking with the key blade triggers the alarm. For deactivation, see page 51.

Key memory – driver's seat and door mirrors***PCC memory function**

If several people with PCCs approach the car, then the settings for seat and mirrors are implemented for the person who opens the driver's door.



02 Locks and alarm

Keyless drive*

The settings are changed in two ways after the driver's door has been opened:

- From the driver's seat position: press the unlock button on the PCC, see page 39
- Press the button for seat settings, see page 67.

Locking

Lock the doors and the tailgate by pressing the lock button on one of the door handles on the outside.

All doors and the tailgate must be closed before the car can be locked. Otherwise the car will not be locked.



NOTE

On cars with automatic transmission, the gear selector must be set in the **P** position – otherwise the car cannot be locked or the alarm armed.

Lock settings

The keyless function can be adapted to specify which of the car doors are to be unlocked, under **Car settings** → **Lock settings** → **Keyless entry**. For a description of the menu system, see page 104.

Antenna location

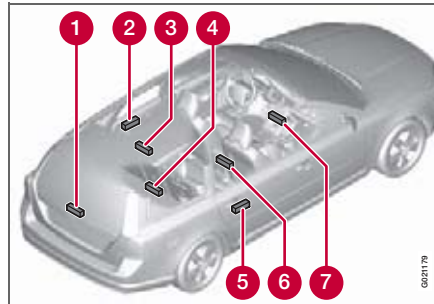

The keyless system has a number of integrated antennae located around the car:

- 1 Tailgate, by wiper motor
- 2 Door handle, left rear
- 3 Roof, above centre rear seat
- 4 Cargo area, central and furthest in under the floor
- 5 Door handle, right rear
- 6 Centre console, under the rear section
- 7 Centre console, under the front section.



WARNING

People with pacemaker operations should not come closer than 22 cm to the keyless system's antennae with their pacemaker. This is to prevent interference between the pacemaker and the keyless system.

**Locking/unlocking****From the outside**

The remote control key locks/unlocks all doors and the tailgate simultaneously. The lock buttons and door handles are disengaged during locking which also prevents opening from the inside, so-called deadlocks, see page 49 (only applies to certain markets).

The fuel filler flap can be opened when the car is unlocked. It cannot be opened if the car is locked and the alarm is armed.

NOTE

The car can be locked even if a door is open¹. It is also locked when the door is closed, and there is a risk that the remote control key will be locked in.

¹Only applies to cars in certain markets, but not to cars with Keyless drive.

WARNING

Be aware that there is a risk that you can be locked in the car if it is locked from the outside.

Automatic relocking

If none of the doors or the tailgate is opened within two minutes of unlocking, all are locked again automatically. This function prevents the car from being left unlocked unintentionally. For cars with alarms, see page 51.

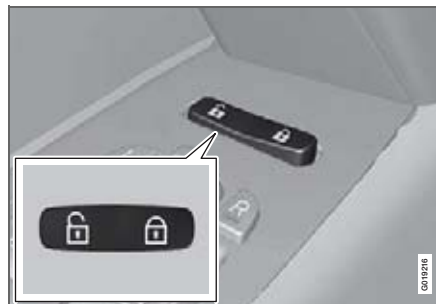
From the inside

All of the doors and the tailgate can be locked or unlocked simultaneously using the door buttons on the door panel.

Unlocking

Press the door unlock button. Press and hold to also open all windows.

Locking

Press the door lock button after the front doors are closed. Press and hold to also close all of the windows and the sunroof.

All the doors can be locked manually with their respective lock buttons after they have been closed. Pull the door handle once to unlock the door. Pull the door handle twice to open the door.

Automatic locking

The doors and tailgate can be locked automatically when the car starts to move.

This function can be activated/deactivated under **Car settings** → **Lock settings** → **Doors automatic lock**. For a description of the menu system, see page 104.



Locking/unlocking

Glovebox

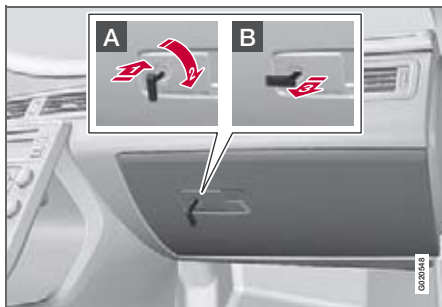

- A** Lock the glovebox by turning the key blade a quarter of a turn (90 degrees) clockwise. The keyhole is horizontal in the locked position.
- B** Unlock by carrying this out in reverse order. The keyhole is vertical in the unlocked position.

The glovebox can only be locked and unlocked with the removable key blade in the remote control key.

For information on privacy locking, see page 43.

Tailgate



Unlocking with the remote control key

Press the remote control key button to unlock the tailgate.

NOTE

On cars with the power operated tailgate option, the tailgate is opened – otherwise it is only unlocked, see page 167.

The alarm indicator on the instrument panel goes out to show that the whole car is not armed. The alarm's level and movement sensors and the sensors for opening the tailgate are automatically disconnected. The doors remain locked and armed.

When the tailgate is closed again it is then locked, and the disconnected alarm functions are reactivated.

Locking with the remote control key

Press the remote control key button for locking, see page 39.

The alarm indicator on the instrument panel starts to flash, which shows that the alarm is armed.

If the doors are locked when the tailgate is closed then it remains unlocked until the car is locked with the remote control key.

Unlocking the car from inside



Press the headlamp control panel button **1** to unlock the tailgate.



Locking/unlocking

Deadlocks¹

Deactivating with the button or display menu.

When deadlocked, the doors cannot be opened from the inside if they are locked. The deadlocks are activated with the remote control key and are set after a 10 second delay after the doors are locked.

The car can only be unlocked from a deadlock state with the remote control key. The driver's door can also be unlocked from the outside with the key blade.

Deactivating with the button

If someone is going to stay in the car but the doors must be locked from the outside, then the deadlocks function can be temporarily deactivated as follows:

1. Press the button.
Deactivation must be carried out within one minute from when the remote control key is removed from the ignition switch.
- The light in the button remains illuminated until the car is locked.
- A message is shown on the instrument panel display for 10 seconds or until the car is locked.

NOTE

If the car is equipped with an alarm: Remember that the car's alarm is armed when the car is locked. If any of the doors are opened from the inside then the alarm will be triggered.

If the car is equipped with an alarm with movement and tilt detectors*, then these are also deactivated at the same time, see page 53.

The detectors are reactivated and deadlocks re-engaged the next time the car is started.

WARNING

Do not allow anyone to remain in the car without first deactivating the deadlocks to avoid the risk of anyone being locked in.

Deactivating with the display menu

Certain cars have no button but instead deactivation takes place in the menu system. For a description of the system, see page 104.

1. Go into the menu system under **Car settings**.
 2. Select **Reduced Guard**.
An active menu option is indicated with a cross.
- Otherwise the same applies as for deactivating with the button.

¹ Applies to certain markets



Child safety locks

Manual blocking of the rear doors

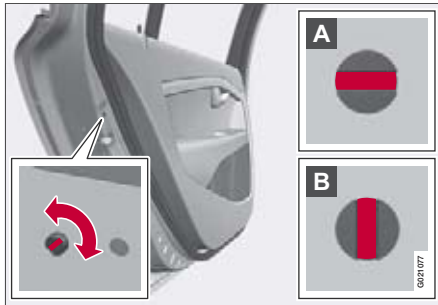

The child safety locks are located on the trailing edge of the rear doors and are only accessible when the doors are open.

1. Use the key blade to turn the lock and thus activate or deactivate the child safety lock.

- A** The door cannot be opened from inside.
- B** The doors can be opened from inside.

i NOTE

Cars with electric child safety locks do not have manual child locks.

Electrical locking of the rear doors* and power windows

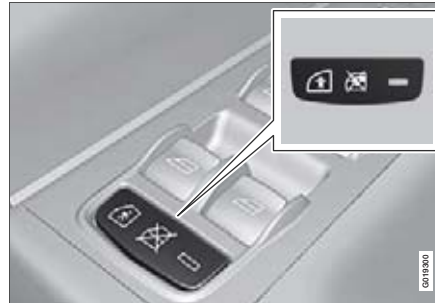

When the electric child safety lock is active;

- the rear windows can only be opened with the driver's door controls
- the rear doors cannot be opened from the inside.

1. Child safety locks are activated in ignition position **I** or **II**.
2. Press the switch on the driver's door. The information display shows a message.

The lamp on the button illuminates when the locks are activated.

! WARNING

Always keep the car unlocked during a journey. In the event of an accident, this allows the emergency services to get into the car quickly. Passengers in the rear seat cannot open the doors from inside if the child safety locks are activated.



General

The alarm is triggered if;

- a door, the bonnet or the tailgate is opened
- a non-approved key is used in the keyhole or if force is exerted on the keyhole.
- a movement is detected in the passenger compartment (if fitted with a movement detector)
- the car is raised or towed away (if fitted with a tilt detector*)
- a battery cable is disconnected.
- anyone tries to disconnect the siren.

If there is a fault in the alarm system, a message appears on the information display. Contact an authorised Volvo workshop.

i NOTE

The movement detectors trigger the alarm in the event of movements in the passenger compartment. For this reason the alarm could be triggered if the car is left with a window open or if an electric passenger compartment heater is used. To avoid this: close the windows when leaving the car and aim the air from the passenger compartment heater so that it is not directed up into the passenger compartment.

i NOTE

Do not attempt to repair or modify alarm system components. All such attempts could affect the terms of insurance.

Alarm indicator

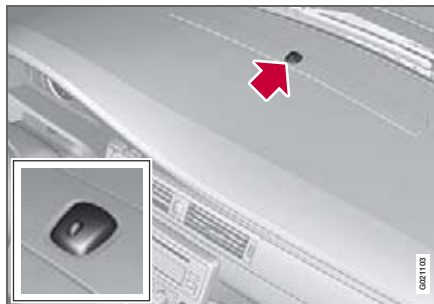

An alarm indicator on the dashboard indicates the alarm system's status:

- lamp off – the alarm is disarmed
- the lamp flashes once every other second – Alarm is armed
- the lamp flashes rapidly after disarming the alarm (and until the remote control key is inserted in the ignition switch and ignition position I is selected) – the alarm has been triggered.

Arming the alarm

Press the remote control key lock button. A long flash from the car's direction indicators confirms that the alarm is armed and that the doors are locked.

The way in which the car confirms that the alarm is armed can be adapted to your requirements under **Car settings** → **Lock settings** → **Keyless entry**. For a description of the menu system, see page 104.

Disarming the alarm

Press the remote control key unlock button. Two short flashes from the car's direction indicators confirm that the alarm is disarmed and that the doors are unlocked.

Deactivating a triggered alarm

Press the remote control key unlock button or insert the remote control key in the ignition switch. Confirmation is given by two short flashes from the direction indicators.



Alarm*

Other alarm functions

Automatic re-arming of the alarm

This function prevents the car being left with alarm disarmed unintentionally.

If the car is unlocked with the remote control key (and the alarm is disarmed) and none of the doors or the tailgate is opened within two minutes, then the alarm is automatically re-armed. The car is locked at the same time.

Alarm signals

When the alarm is triggered, the following happens:

- A siren sounds for less than 30 seconds. The siren has its own battery which is independent of the car battery.
- The direction indicators flash for five minutes or until the alarm has been deactivated.

Remote control key not working

If the remote control key is not working, the alarm can still be switched off and the car started as follows:

1. Open the driver's door with the key blade. The alarm is triggered and the siren sounds.

2. Insert the remote control key in the keyhole. The alarm is deactivated. The alarm indicator flashes quickly until the remote control key is inserted.

Reduced alarm level



Deactivating with the button or display menu.

To avoid inadvertently triggering the alarm, for example during a ferry crossing, the movement and tilt detectors* can be temporarily deactivated.



Deactivating with the button

1. Press the button.

Deactivation must be carried out within one minute from when the remote control key is removed from the ignition switch.

- The light in the button remains illuminated until the car is locked.
- A message is shown on the instrument panel display for 10 seconds or until the car is locked.

If the car is equipped with deadlocks, they are also deactivated at the same time, see page 49.

The next time the car is started the detectors are reactivated and deadlocks re-engaged.

Deactivating with the display menu

Certain cars have no button but instead deactivation takes place in the menu system. For a description of the system, see page 104.

1. Go into the menu system under **Car settings**.
2. Select **Reduced Guard**.
An active menu option is indicated with a cross.

Otherwise the same applies as for deactivating with the button.

Testing the alarm system

Testing the movement detector in the passenger compartment

1. Close all windows. Remain in the car.
2. Arm the alarm, see page 51.
3. Wait 15 seconds.
4. Trigger the alarm by moving your arms forward and back at backrest height. A siren sounds and all direction indicators flash.
5. Deactivate the alarm by unlocking the car with the remote control key.

Testing the alarm sensors in the doors

1. Arm the alarm, see page 51.
2. Wait 15 seconds.
3. Unlock the driver's door using the key blade.
4. Open the driver's door. A siren sounds and all direction indicators flash.
5. Deactivate the alarm by unlocking the car with the remote control key.

Testing the alarm sensors in the bonnet

1. Sit in the car and deactivate the alarm, see page 51.

2. Arm the alarm, see page 51. Remain in the car and lock the doors with the button on the remote control key.
3. Wait 15 seconds.
4. Open the bonnet with the handle under the dashboard. A siren sounds and all direction indicators flash.
5. Deactivate the alarm by unlocking the car with the remote control key.

Instruments and controls	56
Ignition positions	65
Seats	66
Steering wheel	70
Lighting	71
Wipers and washing.....	80
Windows, rearview and door mirrors	82
Power sunroof*	86
Starting the engine.....	88
Gearboxes	91
All Wheel Drive – AWD (All Wheel Drive)*	95
Foot brake	96
Hill Descent Control (HDC).....	97
Parking brake	98

YOUR DRIVING ENVIRONMENT



03



Instruments and controls

Instrument overview

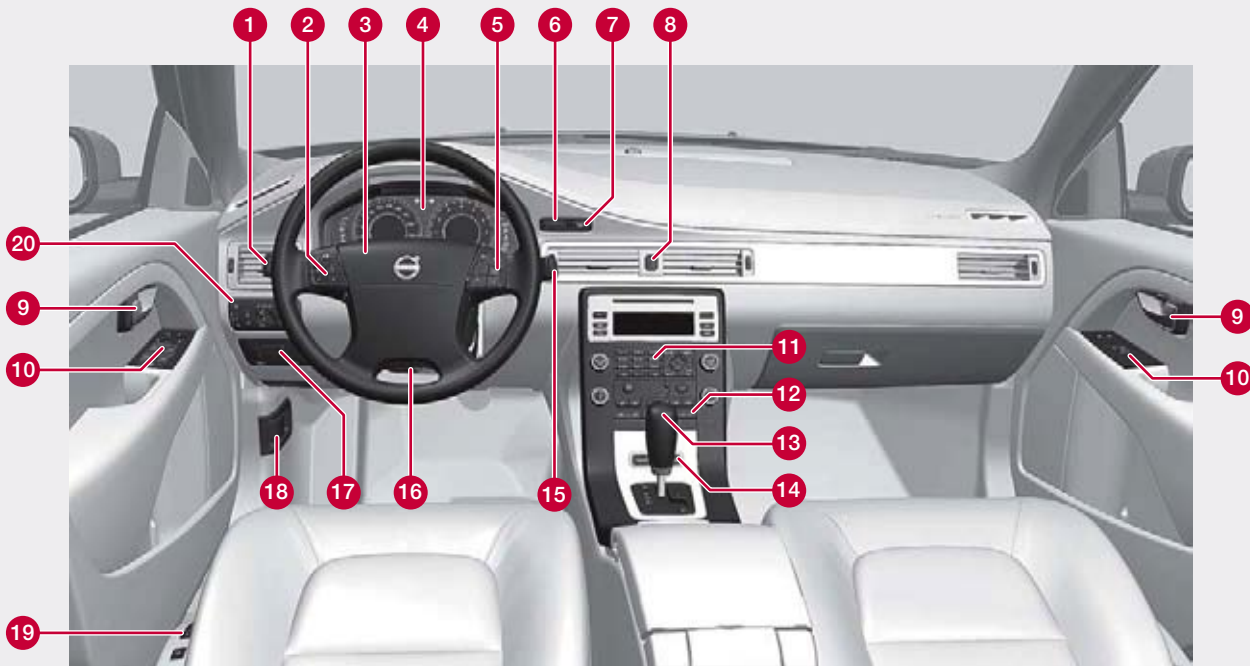

Left-hand drive

0001107



Instruments and controls

	Function	Page		Function	Page
1	Menus and messages, direction indicators, main/dipped beam, trip computer	107, 74, 72, 130	11	Menu control, climate control and audio system	104, 112, 123
2	Cruise control	135, 64	12	Climate control, ECC*	112
3	Horn, airbags	70, 15	13	Gear selector	91
4	Combined instrument panel	60, 64	14	Controls for active chassis (Four-C)*	134
5	Menu, audio and phone control	104, 120	15	Wipers and washing	80, 81
6	Ignition switch	88	16	Steering wheel adjustment	70
7	Start/stop button	65	17	Parking brake*	98
8	Hazard warning flashers	74	18	Bonnet opener	184
9	Door handle	–	19	Seat adjustment*	66
10	Control panel	82, 84, 47	20	Headlamp control, opener for fuel filler flap and tail-gate	71, 163



03 Your driving environment

Instruments and controls

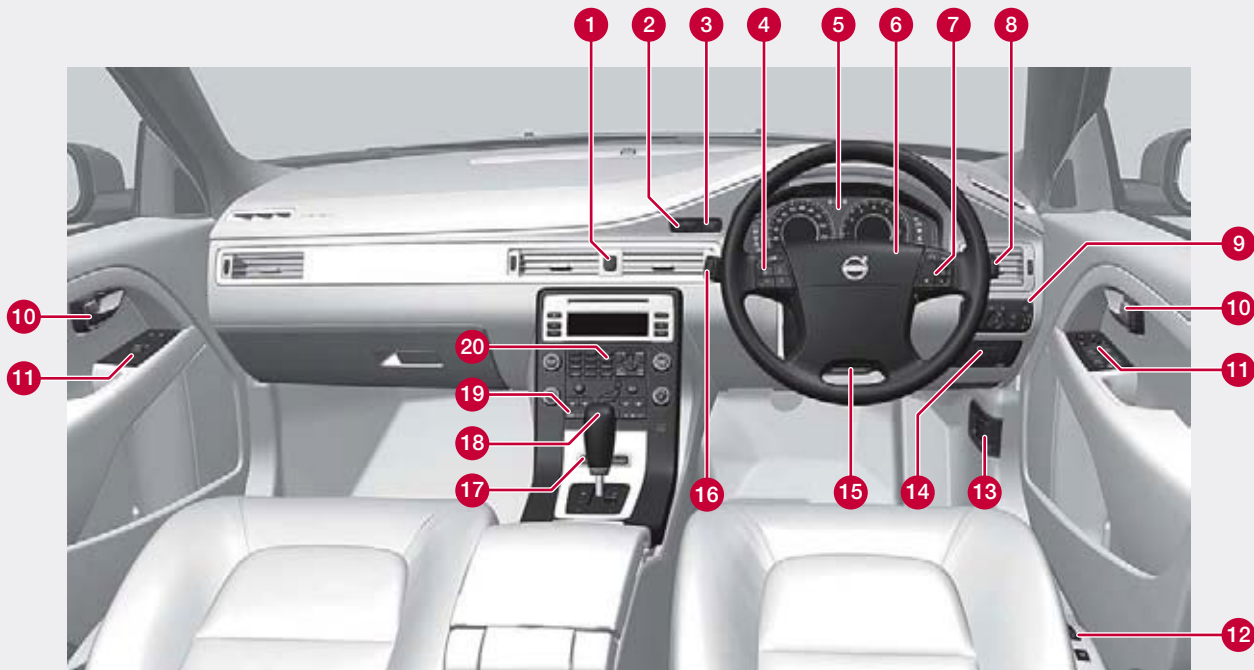

Right-hand drive

0201108



Instruments and controls

	Function	Page		Function	Page
1	Hazard warning flashers	74	11	Control panel	82, 84, 47
2	Ignition switch	65	12	Seat adjustment*	66
3	Start/stop button	88	13	Bonnet opener	184
4	Cruise control	135, 136	14	Parking brake	98
5	Combined instrument panel	60, 64	15	Steering wheel adjustment	70
6	Horn, airbags	70, 15	16	Menus and messages, direction indicators, main/dipped beam, trip computer	107, 74, 72, 130
7	Menu, audio and phone control	104, 120	17	Controls for active chassis (Four-C)*	134
8	Wipers and washing	80, 81	18	Gear selector	91
9	Headlamp control, opener for fuel filler flap and tail-gate	71, 163	19	Climate control, ECC*	112
10	Door handle	–	20	Menu control, climate control and audio system	104, 112, 123

Instruments and controls

Information displays



Information displays

The information displays show information on some of the car's functions, e.g. cruise control, trip computer and messages. The information is shown with text and symbols.

There are further descriptions under the functions that use the information displays.

Meters

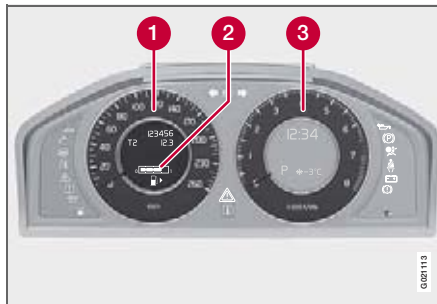

Meters in the combined instrument panel

- 1 Speedometer
- 2 Fuel gauge, see also refuelling, page 163.
- 3 Tachometer
The meter indicates engine speed in thousands of revolutions per minute (rpm).

Indicator, information and warning symbols

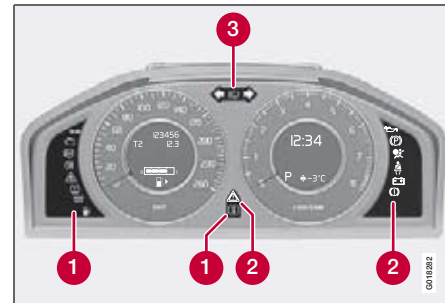

Indicator and warning symbols

- 1 Indicator and information symbols
- 2 Indicator and warning symbols¹
- 3 Main beam and direction indicator symbol

Functionality check

All indicator and warning symbols illuminate in ignition position II or when the engine is started. When the engine has started, all the symbols should go out except the parking brake symbol, which only goes out when the brake is disengaged.

¹ For certain engine variants, the symbol for low oil pressure is not used. Warnings are given via display text, see page 185.



Instruments and controls

If the engine does not start or if the functionality check is carried out in ignition position II then all symbols go out after 5 seconds except the symbol for a faults in the car's emissions system and the symbol for low oil pressure.

Indicator and information symbols

Symbol	Specification
	Direction indicators on trailer
	Fault in emissions system
	ABS fault
	Rear fog lamp
	Stability system
	Engine preheater (diesel)
	Low level in fuel tank
	Information, read display text
	Main beam On
	Left-hand direction indicators
	Right-hand direction indicators

Direction indicators on trailer

This symbol flashes when the direction indicators are used and the trailer is connected. If the symbol flashes more quickly than one of the lamps on the car or the trailer is broken.

Fault in emissions system

Drive to an authorised Volvo workshop to have the system checked.

ABS fault

If this symbol illuminates then the system is not working. The car's regular brake system continues to work, but without the ABS function.

1. Stop the car in a safe place and turn off the engine.
2. Restart the engine.
3. Drive to an authorised Volvo workshop to have the ABS checked if the symbol remains illuminated.

Rear fog lamp

This symbol illuminates when the rear fog lamp is on.

Stability system

A flashing symbol indicates that the stability system is operating. If the symbol illuminates with constant glow then there is a fault in the system.

Engine preheater (diesel)

This symbol illuminates during engine preheating. Preheating occurs when the temperature is below -2°C . The car can be started once the symbol goes out.

Low level in fuel tank

This symbol illuminates when there are approximately eight litres of fuel left in a petrol-engined car, or seven litres in a diesel-engined car.

Information, read display text

When one of the car's systems does not behave as intended, this information symbol illuminates and a text appears on the information display. The message text is cleared using the **READ** button, see page 107 or it disappears automatically after a time (time depending on which function is indicated). The information symbol can also illuminate in conjunction with other symbols.

NOTE

When a service message is shown, the symbol and message are cleared using the **READ** button, or disappear automatically after a time.

Main beam On

The symbol illuminates when main beam is on and with main beam flash



Instruments and controls

Left-hand direction indicators

Right-hand direction indicators

Both direction indicator symbols flash when the hazard warning flashers are used.

Indicator and warning symbols

Symbol	Specification
	Low oil pressure ¹
	Parking brake applied
	Airbags – SRS
	Seatbelt reminder
	Alternator not charging
	Fault in brake system
	Warning

¹ For certain engine variants, the symbol for low oil pressure is not used. Warnings are given via display text, see page 185 and 186.

Low oil pressure

If this symbol illuminates during driving then the engine's oil pressure is too low. Stop the engine immediately and check the engine oil

level, top up if necessary. If the symbol illuminates and the oil level is normal, contact an authorised Volvo workshop.

Parking brake applied

This symbol illuminates with a constant glow when the parking brake is applied. With the electric parking brake, this symbol flashes while it is being applied and then illuminates with a constant glow.

A flashing symbol means that a fault has arisen. Read the message on the information display.

NOTE

This symbol also illuminates when the mechanical parking brake is only lightly applied.

Airbags – SRS

If this symbol remains illuminated or illuminates while driving, it means a fault has been detected in the seatbelt buckle, SRS, SIPS, or IC systems. Drive immediately to an authorised Volvo workshop to have the system checked.

Seatbelt reminder

This symbol illuminates if someone in a front seat has not put on their seatbelt or if someone in a rear seat has taken off their seatbelt.

Alternator not charging

This symbol illuminates during driving if a fault has occurred in the electrical system. Contact an authorised Volvo workshop.

Fault in brake system

If this symbol illuminates, the brake fluid level may be too low. Stop the car in a safe place and check the level in the brake fluid reservoir, see page 188.

If the brake and ABS symbols illuminate at the same time, there may be a fault in the brake force distribution system.

1. Stop the car in a safe place and turn off the engine.
2. Restart the engine.
 - If both symbols extinguish, continue driving.
 - If the symbols remain illuminated, check the level in the brake fluid reservoir. See page 188. If the brake fluid level is normal but the symbols are still illuminated, the car can be driven, with great care, to an authorised Volvo workshop to have the brake system checked.

**⚠ WARNING**

If the brake fluid is under the **MIN** level in the brake fluid reservoir, do not drive further before topping up the brake fluid. The reason for the loss of brake fluid must be investigated by an authorised Volvo workshop.

⚠ WARNING

If the brake and ABS symbols are on at the same time, there is a risk that the rear end will skid during heavy braking.

⚠ Warning

The red warning symbol illuminates when a fault has been indicated which could affect the safety and/or driveability of the car. An explanatory text is shown on the information display at the same time. The symbol remains visible until the fault has been rectified but the text message can be cleared with the **READ** button, see page 107. The warning symbol can also illuminate in conjunction with other symbols.

Action:

1. Stop in a safe place. Do not drive the car further.
2. Read the information on the information display. Implement the action in accord-

ance with the message in the display. Clear the message using **READ**.

Reminder – doors not closed

If one of the doors, the bonnet¹ or tailgate is not closed properly then the information or warning symbol illuminates together with an explanatory text message in the combined instrument panel. Stop the car in a safe place as soon as possible and close the door, bonnet or tailgate, whichever is open.

 If the car is driven at a speed lower than 7 km/h then the information symbol illuminates.

 If the car is driven at a speed higher than 7 km/h then the warning symbol illuminates.

¹ Only cars with alarm*



Instruments and controls

Trip meter

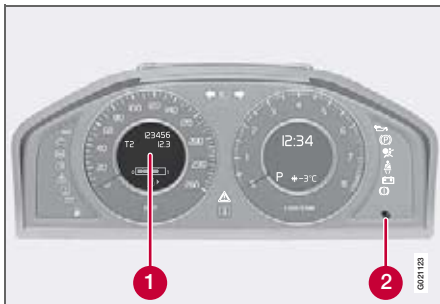

Trip meter and button

The meters are used to measure short distances.

- 1 Display for trip meter
- 2 Controls for switching between trip meter T1 and T2, as well as resetting the trip meter.

The meters are used to measure short distances. A short press on 2 switches between the two trip meters T1 and T2. A long press (more than 2 seconds) resets an active trip meter to zero. The distance is shown in the display 1.

Clock

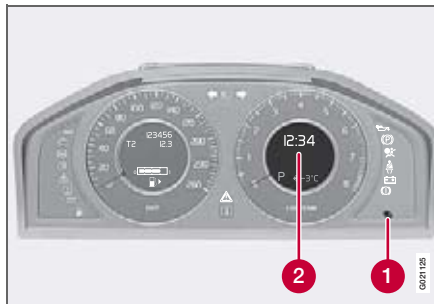

Clock and setting knob

- 1 Controls for setting the clock.
- 2 Information display for showing the time.

Turn the knob 1 clockwise/anticlockwise to set the time. The set time is shown in the information display 2.

The clock can be temporarily replaced by a symbol in conjunction with a message, see page 107.

Controls for trip meter and clock



Location of controls



Ignition positions

Functions



Ignition switch with remote control key, start/stop button

Insert and remove the remote control key

The remote control key is inserted into the ignition switch. With one gentle push the remote control key is captured into the correct position.

The remote control key is withdrawn from the ignition switch by means of one touch. The key is then ejected and can be removed. Automatic transmission* must be in position **P**.

For information on the audio system's functions with remote control key removed, see page 120.

! IMPORTANT

Foreign objects in the ignition switch can impair the function or destroy the lock.

Do not insert the remote control key backwards!
Grip the end with the detachable key blade. See page 42.

Ignition position 0

Insert the remote control key in the ignition switch.

Ignition position I

Press the remote control key into the ignition switch and press **START/STOP**.

i NOTE

The brake/clutch must not be depressed if ignition positions **I** or **II** are required.

Ignition position II

Press the remote control key into the ignition switch and press **START/STOP** for approx. 2 seconds.

Starting the engine III

Start the engine, see page 88.

Stop engine

Press **START/STOP**. (If the engine is running and the car is moving, keep the button depressed until the engine stops).

Return to ignition position 0

Press **START/STOP** to return from **I**, **II**, or **III** to ignition position **0**.

i NOTE

During towing, ignition position **II** should be used so that the lighting can be switched on.

Position	Function
0	Odometer, clock and temperature gauge are illuminated. The steering lock is deactivated. The audio system can be used.
I	Sunroof, power windows, phone, ventilation fan, ECC, windshield wipers can be used.
II	The headlamps come on. Warning/indicator lamps illuminate for 5 seconds. All equipment operates apart from heated seats and rear window defroster which only work when the engine is running.



Seats

Front seats

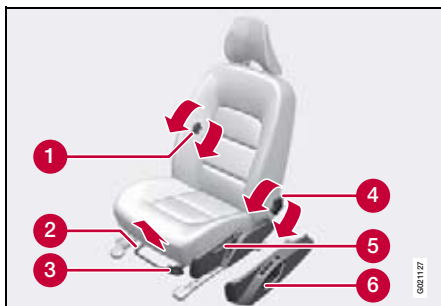

- 1 Lumbar support, turn the wheel¹.
- 2 Forward/backward: lift the handle to adjust the distance to the steering wheel and pedals. Check that the seat is locked after changing position.
- 3 Raise/lower front edge of seat cushion, pump up/down.
- 4 Adjust backrest rake, turn the wheel.
- 5 Raise/lower the seat, pump up/down.
- 6 Control panel for power seat*.



WARNING

Adjust the position of the driver's seat before setting off, never while driving. Check that the seat is locked in position.

¹ Also applies to power seat.

Lowering the front seat backrest

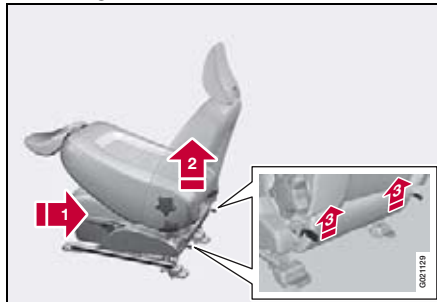

The passenger seat backrest can be folded forward to make room for long loads.

- 1 Move the seat as far back/down as possible.
- 2 Adjust the backrest to an upright position
- 3 Lift the catches on the rear of the backrest and fold it forward.

Push the seat forward so that the head restraint "locks" in under the glovebox.

Power seat*

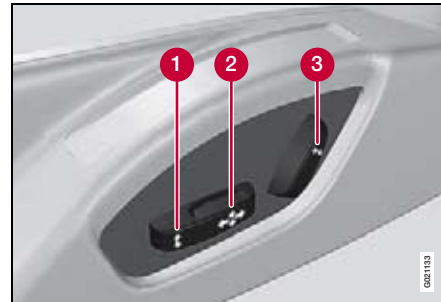

- 1 Front edge of seat cushion up/down
- 2 Seat forward/backward and up/down
- 3 Backrest rake

The power front seats have overload protection which is tripped if a seat is blocked by an object. If this happens, turn off the ignition and wait a short time before adjusting the seat again.

Only one of the electric motors can be used at a time.



Seats

Preparations

The seats can be adjusted for a certain time after unlocking the door with the remote control key without the key in the ignition switch. Seat adjustment is normally made when the ignition is on and can always be made when the engine is running.

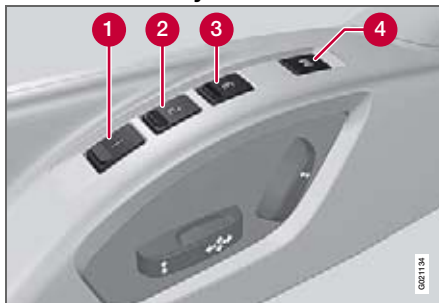
Seat with memory function***Store setting**

1. Adjust the seat and the door mirrors.
2. Press and hold the **1** button, while depressing the **2**, **3** or **4** button.

Using a stored setting

Press one of the memory buttons **1** – **3** until the seat and the door mirrors stop. If you

release the button then the movement of the seat will stop.

Key memory* in remote control key

The positions of the driver's seat and the door mirrors are stored in the key memory when the car is locked with the remote control key.



When the car is unlocked with the same remote control and the driver's door is opened the driver's seat and also the door mirrors automatically adopt the positions stored in the key memory.

NOTE

The seat and the door mirrors do not move if they are already in the relevant position.

It is also possible to use the key memory by pressing the unlock button on the remote control key when the driver's door is open.

The key memory can be activated/deactivated under **Car key memory** → **Seat & mirror positions**. For a description of the menu system, see page 104.

NOTE

The key memory in the two remote controls and the seat memory are completely independent of each other.

Seats

Emergency stop

If the seat accidentally begins to move, press one of the buttons to stop the seat.

Restarting to reach the seat position stored in the key memory is performed by pressing the unlock button on the remote control key. In this situation the driver's door must be open.

WARNING

Risk of crushing! Make sure that children do not play with the controls. Check that there are no objects in front of, behind or under the seat during adjustment. Ensure that none of the backseat passengers will be trapped.

Heated/ventilated seats*

See page 112.

Rear seats

Head restraint, centre seat, rear

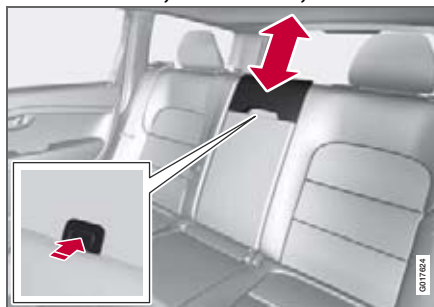

The head restraint is adjusted vertically according to the height of the passenger. The top of the head restraint is adjusted to the rear centre of the head. Slide it up as required. To lower the head restraint again, the button (located in the centre between the backrest and head restraint, see illustration) must be pressed in while the head restraint is pressed down.

Manual lowering of the outer head restraints, rear seat

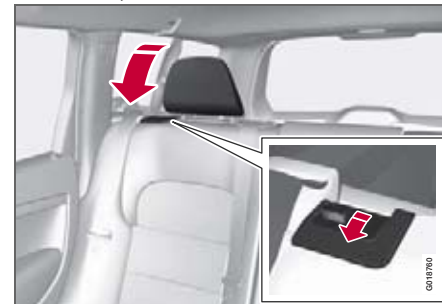

Pull the locking handle closest to the head restraint to fold the head restraint forward.

The head restraint is moved back manually until a "click" can be heard.

Lowering the rear seat backrest

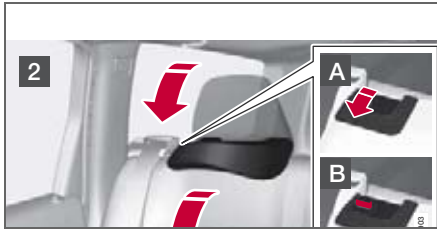

The triple-section rear seat backrest can be folded in different ways in order to facilitate loading long objects.

NOTE

The front seats may need to be pushed forwards, and/or the backrests adjusted upwards, in order that the rear backrests can be folded forward fully.

- The left-hand backrest can be folded separately.

- The centre backrest can be folded separately.
- The right-hand backrest can be folded together with the centre backrest.
- All backrests can be folded together.

- 1 If the centre backrest is being lowered - release and adjust down the centre backrest's head restraint. The outer head restraints are lowered automatically when the outer backrests are lowered.
- 2 Pull up the backrest's locking handle **A** while folding the backrest forward at the same time. A red indicator on the lock catch **B** shows that the backrest is no longer locked in place.

Raising takes place in reverse order.

NOTE

When the backrest has been raised, the red indicator should no longer be showing. If it is still showing then the backrest is not locked in place.

WARNING

Check that the backrests and head restraints in the rear seats are firmly locked after raising.



Steering wheel

Adjusting

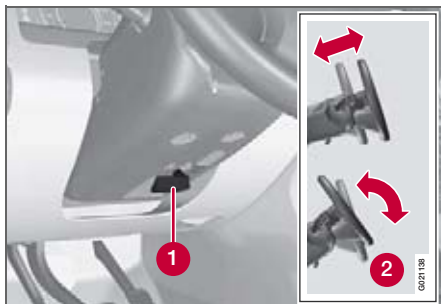

Adjusting the steering wheel

The steering wheel can be adjusted for both height and depth:

① Lever - releasing the steering wheel

② Possible steering wheel positions

1. Pull the lever towards you to release the steering wheel.
2. Adjust the steering wheel to the position that suits you.
3. Push back the lever to fix the steering wheel in place. If the lever is stiff, press the steering wheel lightly at the same time as you push the lever back.

WARNING

Adjust and secure the steering wheel before driving.

With speed related power steering* the level of steering force can be adjusted, see page 134.

Keypads*



Keypads in the steering wheel

① Cruise control, see page 135

Adaptive cruise control, see page 136

② Audio and phone control, see page 120

Horn



Horn

Press the centre of the steering wheel to signal.

Light switches

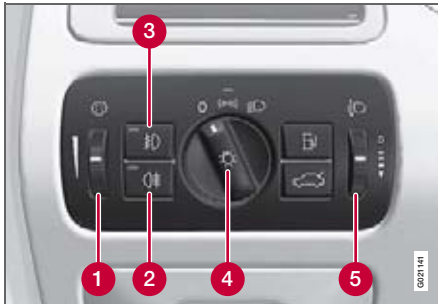

Overview, light switches

- 1 Thumbwheel for adjusting display and instrument lighting
- 2 Rear fog lamp
- 3 Front fog lamps*
- 4 Light switches
- 5 Thumbwheel for headlamp levelling

Instrument lighting

Different display and instrument lighting is switched on depending on ignition position.

The display lighting is automatically subdued in darkness and the sensitivity is set with the thumbwheel.

The intensity of the instrument lighting is adjusted with the thumbwheel.

Headlamp levelling

The load in the car changes the vertical alignment of the headlamp beam, which could dazzle oncoming motorists. Avoid this by adjusting the height of the beam. Lower the beam if the car is heavily laden.

1. Have the engine running or use ignition position I.
2. Roll the thumbwheel up/down to raise/lower beam alignment.

Cars with Bi-Xenon headlamps and Active Bi-Xenon headlamps* have automatic headlamp levelling and are not equipped with a thumbwheel.



Lighting

Main/dipped beam



Headlamp control and stalk switch

Position	Specification
0	Automatic*/deactivated dipped beam. Only main beam flash.
	Position/parking lamps
	Automatic dipped beam. Main beam and main beam flash work in this position.

i NOTE
Main beam can only be activated in position

Main beam flash

Move the stalk switch gently to position toward the steering wheel. Main beam comes on until the stalk switch is released.

Dipped beam

When the engine is started, dipped beam is activated automatically* if the headlamp control is in position . If necessary, automatic dipped beam for this position can be deactivated by an authorised Volvo workshop.

In position dipped beam is always activated automatically when the engine is running or with ignition position II.

Main beam

Main beam can only be activated when the headlamp control is in position . Activate/deactivate main beam by moving the stalk switch to the end position towards the steering wheel and release.

When main beam has been activated the symbol illuminates in the combined instrument panel.

Active Bi-Xenon Lights*



Headlamp pattern with function deactivated (left) and activated (right) respectively

If the car is equipped with active headlamps (Active Bi-Xenon Lights, ABL) the light from the headlamps follows the steering wheel movement in order to provide maximum lighting in bends and junctions and so provide increased safety.

The function is activated automatically when the car is started. The button in the centre console illuminates when the function is activated, it flashes in the event of a malfunction. The function is only active in twilight or darkness and only when the car is moving.

The function can be deactivated/activated with the button.

Position/parking lamps



Headlamp control in position for position/parking lamps

Turn the headlamp control to the centre position (number plate lighting comes on at the same time).

Rear position lamps also come on when the tailgate is opened in order to alert anybody behind.

Brake light

The brake light automatically comes on during braking.

Emergency brake light and automatic hazard warning flashers, EBL

Emergency Brake Lights, EBL are activated in the event of heavy braking or if the ABS brakes are activated. This function means that the brake light flashes to immediately alert cars travelling behind.

The system is activated if ABS is used for more than 0.5 seconds or in the event of heavy braking, however, only when braking from speeds above 50 km/h. When the speed of the car is lower than 30 km/h the brake lights shine normally again and the hazard warning flashers are switched on automatically. The hazard warning flashers remain on until the car accelerates again but can be deactivated with the button for hazard warning flashers

Front fog lamps*



Button for front fog lamps

The front fog lamps can be switched on along with main/dipped beam or position/parking lamps.

Press the button for on/off. The light in the button illuminates when the fog lamps are on.



NOTE

Regulations for using front fog lamps vary between different countries.



Lighting

Rear fog lamp



Button for rear fog lamp

The rear fog lamp consists of one rear lamp and can only be switched on in combination with main/dipped beam or the front fog lamps.

Press the button for on/off. The light in the button illuminates when the rear fog lamp is on. The rear fog lamp indicator symbol  in the combined instrument panel and the light in the button illuminate when the rear fog lamp is switched on.

The rear fog lamps are switched off automatically when the car is started.

NOTE

Regulations for using rear fog lamps vary between different countries.

Hazard warning flashers



Hazard warning flashers

Press the button to activate the hazard warning flashers. Both direction indicator symbols in the combined instrument panel flash when the hazard warning flashers are in use.

The hazard warning flashers are activated automatically when the car brakes so suddenly that the emergency brake lights (EBL) are activated and speed is below 30 km/h. They remain on when the car has stopped and are deactivated automatically when the car is driven off again or the button is depressed.

Direction indicators/flashers

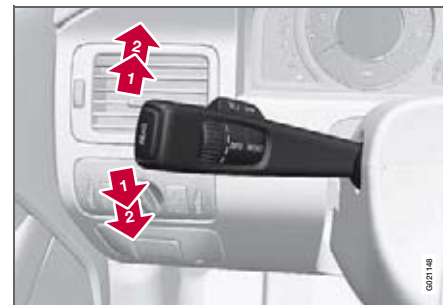

Direction indicators/flashers

Continuous flash sequence

Move the stalk switch up or down to position .

The stalk switch remains in its position and is moved back manually, or automatically by the steering wheel movement.

Short flash sequence

Move the stalk switch up or down to position  and release. The direction indicators flash three times.

Direction indicator symbols

See page 60.

Interior lighting

Front roof lighting



Controls for reading lamps and front roof lighting

- ❶ Reading lamp, left-hand side
- ❷ Reading lamp, right-hand side
- ❸ Interior lighting

The front reading lamps are controlled with the ❶ and ❷ buttons in the roof console.

The switch for passenger compartment lighting has three positions for the lighting throughout the whole of the passenger compartment.

- Off – right-hand side depressed, automatic lighting deactivated.
- Neutral position – automatic lighting activated.

- On – left-hand side depressed, passenger compartment lighting on.

Automatic lighting

The passenger compartment lighting is switched on and off automatically when the button for passenger compartment lighting is in neutral position.

The lighting comes on and remains on for 30 seconds if:

- the car is unlocked from the outside with the key or remote control
- the engine is switched off and the ignition is in position 0

The lighting switches off when:

- the engine is started.
- the car is locked from outside

The lighting comes on and remains on for two minutes if one of the doors is open.

The passenger compartment lighting can be switched on and off manually within 30 minutes from when the car is unlocked.

If the lighting is switched on manually and the car is locked then it will be switched off automatically after one minute.

Rear roof lighting



Rear roof lighting

The lamps are switched on or off by pressing each respective button.

Courtesy lighting

The courtesy lighting is switched on or off automatically when one of the front doors is opened or closed.

Glovebox lighting

The glovebox lighting is switched on or off automatically when its door is opened or closed.

Lighting

Home safe lighting

Some of the exterior lighting can be kept switched on to work as home safe lighting after the car has been locked.

1. Remove the remote control key from the ignition switch.
2. Move the left-hand stalk switch towards the steering wheel to the end position and release it. The function can be activated in the same way as with main beam flash, see page 72.
3. Get out of the car and lock the door.

When the function is activated, dipped beam, the parking lamps, direction indicator lamps, door mirror lamps, number plate lighting, inner roof lamps and courtesy lighting are switched on.

The time for which the home safe lighting can be kept switched on can be set under **Car settings** → **Light settings** → **Home safe lighting**. For a description of the menu system, see page 104.

Approach lighting

Approach lighting is switched on with the remote control key, see page 39, and is used to switch on the car's lighting at a distance.

When the function is activated with the remote control the parking lamps, direction indicator lamps, door mirror lamps, number plate lighting, inner roof lamps and courtesy lighting are switched on.

The time for which the approach lighting can be kept switched on can be set under **Car settings** → **Light settings** → **Approach lighting**. For a description of the menu system, see page 104.

Adjusting headlamp pattern

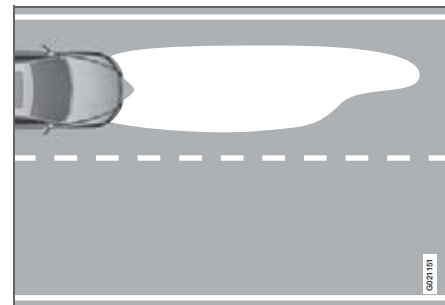

Headlamp pattern, left-hand traffic

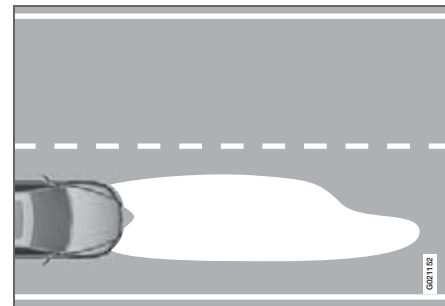

Headlamp pattern, right-hand traffic

The headlamp pattern must be adjusted to avoid dazzling oncoming motorists and be set for either right or left-hand traffic. The



correct pattern will also better illuminate the verge.

Bi-Xenon and Active Bi-Xenon headlamps*

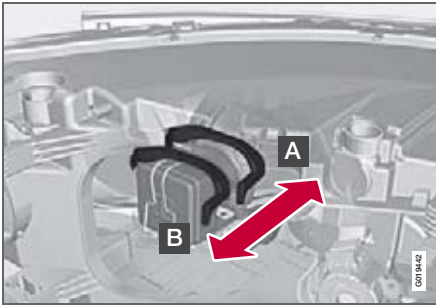

Headlamp control for adjusting headlamp pattern

- A** Normal position – the headlamp pattern is correct for the country in which the car was delivered.
- B** Adapted position – designed for opposite headlamp pattern.

WARNING

The headlamps must be handled with extreme care due to the Xenon lamp being supplied from a high-voltage unit.

The country in which the car is delivered determines whether position **A** is designed for right or left-hand traffic.

Example 1

If a car that is delivered in Sweden shall be driven in the UK then the headlamps should be set to the adjusted position, see the illustration.

Example 2

A car that is delivered in the UK is designed for left-hand traffic and is driven there with the headlamps in normal position, see the illustration.

Halogen headlamps

The headlamp pattern for halogen headlamps is readjusted by masking the headlamp lens. The headlamp pattern may not be as good.

Masking the headlamps

1. Copy the A and B templates for left-hand drive cars or the C and D templates for right-hand drive cars with a scale of 1:2, for templates, see page 79. Use a photocopier with a zoom function for example:

- A = LHD Right
- B = LHD Left
- C = RHD Right
- D = RHD Left

2. Transfer the template to a self-adhesive waterproof material and cut it out. Also mark out the red dots.
3. Position the self-adhesive templates so that the red dots correspond with the dots on the headlamp lenses that form reference points, see page 78.



Lighting

Masking the halogen headlamps

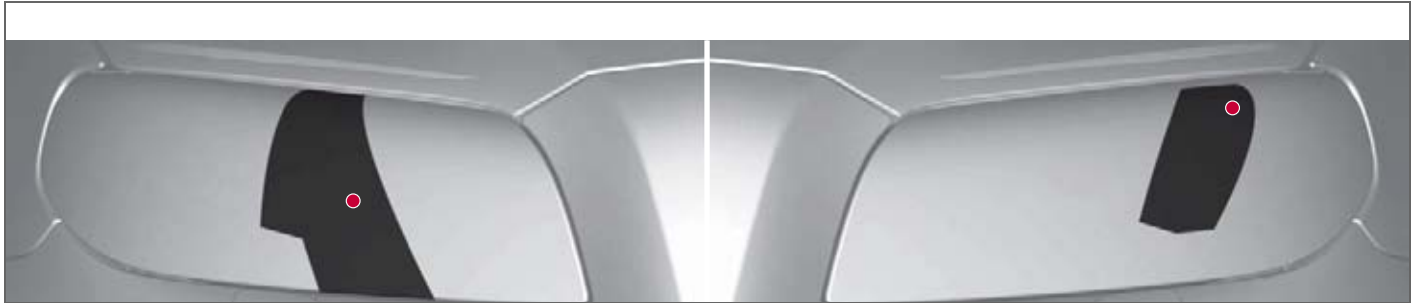

Masking left-hand drive cars



Masking right-hand drive cars

03



Lighting

Figures, halogen headlamps

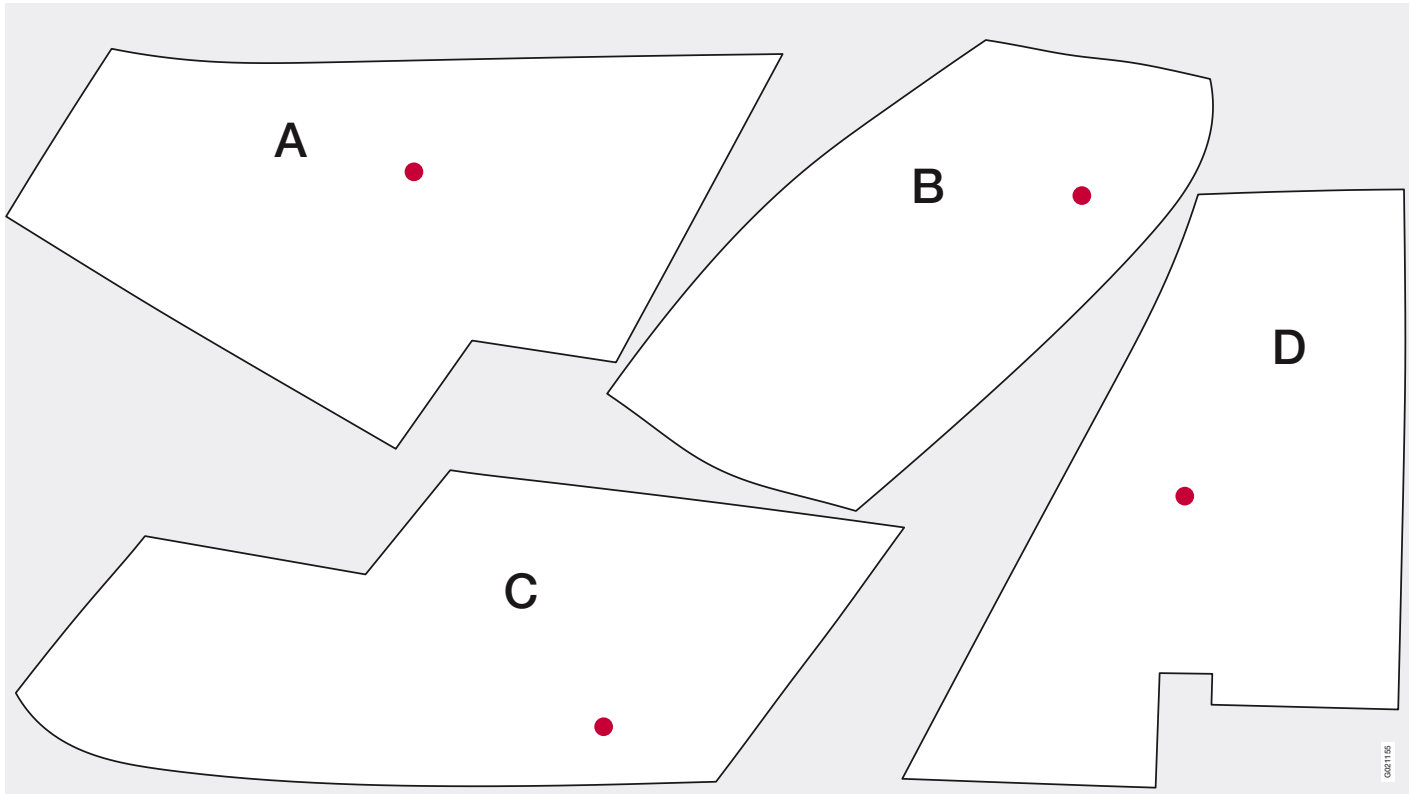

03

02/11/05



Wipers and washing

Windscreen wipers

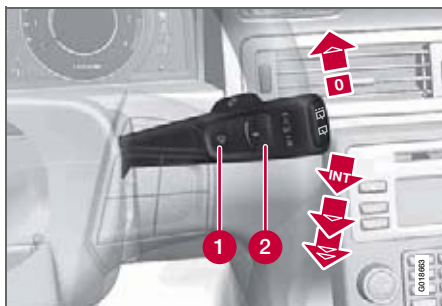

Windscreen wipers and windscreen washers

- 1 Rain sensor, on/off
- 2 Thumbwheel sensitivity/frequency

Windscreen wipers off

0 Move the stalk switch to position 0 to switch off the windscreen wipers.



Single sweep

 Raise the stalk switch and release to make one sweep.

Intermittent wiping

INT Set the number of sweeps per time unit with the thumbwheel when intermittent wiping is selected.

Continuous wiping

-  The wipers sweep at normal speed.
-  The wipers sweep at high speed.

! IMPORTANT

Before activating the wipers during winter - ensure that the wiper blades are not frozen in and that any snow or ice on the windscreen (and rear window) is scraped away.

! IMPORTANT

Use plenty of washer fluid when the wipers are cleaning the windscreen. The windscreen must be wet when the windscreen wipers are operating.

Rain sensor*

The rain sensor automatically starts the windscreen wipers based on how much water it detects on the windscreen. The sensitivity of the rain sensor can be adjusted using the thumbwheel.

When the rain sensor is activated a light in the button the rain sensor symbol  is shown in the right-hand display in the combined instrument panel.

Activating and setting the sensitivity

When activating the rain sensor, the car must be running or in ignition position I or II while the windscreen wiper stalk switch must be in position 0.

Activate the rain sensor by pressing the button . The windscreen wipers make one sweep.

Press the stalk switch up for the wipers to make an extra sweep.

Turn the thumbwheel upward for higher sensitivity and downward for lower sensitivity. (An extra sweep is made when the thumbwheel is turned upward.)

Deactivating

Deactivate the rain sensor by pressing the button  or move the stalk switch down to another wiper program.

The rain sensor is automatically deactivated when the key is removed from the ignition switch or five minutes after the ignition is switched off.

! IMPORTANT

The windscreen wipers could start and be damaged in an automatic car wash. Deactivate the rain sensor while the car is running or in ignition position I or II. The symbol in the combined instrument panel and the lamp in the button go out.



Wipers and washing

Washing the headlamps and windows



Washing function

Washing the windscreen

Move the stalk switch toward the steering wheel to start the windscreen and headlamp washers.

The windscreen wipers will make several more sweeps once the stalk switch has been released. The headlamps are washed alternately to prevent light intensity being reduced.

i NOTE

One headlamp is washed at a time.

Heated washer nozzles*

The washer nozzles are heated automatically in cold weather to prevent the washer fluid freezing solid.

High-pressure headlamp washing*

High-pressure headlamp washing consumes a large quantity of washer fluid. To save fluid, the headlamps are washed automatically at every fifth wash cycle.

Wiper and washer, rear window

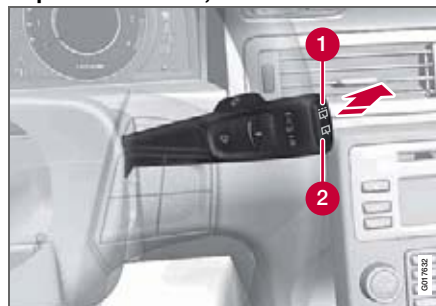

Press the stalk switch forward (see arrow above) to initiate rear window washing and wiping. The control at the end of the stalk has:

- 1** Rear window wiper – intermittent wiping
- 2** Rear window wiper – continuous speed

Wiper – reversing

Engaging reverse gear while the windscreen wipers are on initiates intermittent rear window wiping¹. The function stops when reverse gear is disengaged.

If the rear window wiper is already on at continuous speed, no change is made.

i NOTE

On cars with rain sensor, the rear window wiper is activated with reversing, if the sensor is activated and it is raining.

¹ This function (intermittent wiping for reverse) can be deactivated. Contact an authorised Volvo workshop.



Windows, rearview and door mirrors

General

Laminated glass



The glass is reinforced which provides better protection against break-ins and improved sound insulation in the passenger compartment. All windows* have laminated glass.

Water and dirt-repellent coating*



Windows are treated with a coating that improves the view in difficult weather conditions. Maintenance, see page 217.

! IMPORTANT

Do not use a metal ice scraper to remove ice from the windows. Use the defroster to remove ice from the mirrors. An ice scraper could scratch the mirror glass!

Power windows

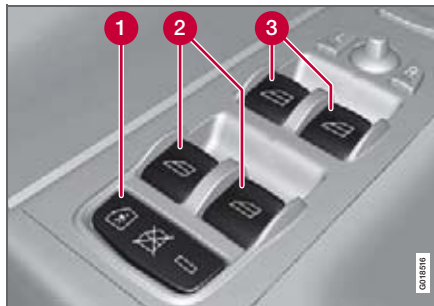

Driver's door control panel

- 1 Switch for electric child safety locks* and disengaging rear power window buttons, see page 31.
- 2 Rear window controls
- 3 Front window controls

! WARNING

Check that none of the rear seat passengers is in danger of becoming trapped in any way caught when closing the windows from the driver's door.

! WARNING

Make sure that children or other passengers are not in danger of becoming trapped in any way when closing the windows, in particular when the remote control key is used.

! WARNING

If there are children in the car, remember to always switch off the supply to the power windows by removing the remote control key if the driver leaves the car.

Windows, rearview and door mirrors

Operating



Operating the power windows

1 Operating without auto

2 Operating with auto

All power windows can be operated using the control panel in the driver's door. Each control panel in the other doors can only control its own respective power window. The power windows can only be controlled with one control panel at a time.

In order that the power windows can be used the car must be in ignition position **I** or **II**. After the car has been running the power windows can be operated for several minutes even when the remote control key has been removed, but not however after the door has been opened.

Closing of the windows is stopped and the window is opened if anything prevents its movement. It is possible to force the pinch protection when closing has been interrupted, e.g. with ice, by continuously holding the button up until the window is closed. The pinch protection is reactivated after a brief pause.

Operating without auto

Move one of the controls up/down gently. The power windows move up/down as long as the control is held in position.

Operating with auto

Move one of the controls up/down to the end position and release it. The window runs automatically to its end position.

Remote control and central locking buttons

All side windows can be opened/closed automatically with the remote control or the central locking buttons:

Press and hold the lock button until the windows start to open/close. To interrupt opening/closing, press the lock button again.

Resetting

If the battery is disconnected then the function for automatic opening must be reset so that it can work correctly.

1. Gently raise the front section of the button to raise the window to its end position and hold it there for one second.
2. Release the button briefly.
3. Raise the front section of the button again for one second.



WARNING

Resetting must be carried out to ensure that pinch protection works.



Windows, rearview and door mirrors

Door mirrors



Door mirror controls

Adjusting

1. Press the **L** button for the left-hand door mirror or the **R** button for the right-hand door mirror. The light in the button illuminates.
2. Adjust the position with the joystick in the centre.
3. Press the **L** or **R** button again. The light should no longer be illuminated.

WARNING

The mirrors are the wide angle type for optimum surveillance. Objects may appear further away than they actually are.

Retractable power door mirrors*

The mirrors can be retracted for parking/driving in narrow spaces:

1. Press down the **L** and **R** buttons at the same time.
2. Release them after approximately one second. The mirrors automatically stop in the fully retracted position.

Fold out the mirrors by pressing down the **L** and **R** buttons at the same time. The mirrors automatically stop in the fully extended position.

Storing the position*

The mirror positions are stored in the key memory when the car has been locked with the remote control key. When the car is unlocked with the same remote control the mirrors and the driver's seat adopt the stored positions when the driver's door is opened.

The function can be activated/deactivated under **Car key memory** → **Seat & mirror positions**. For a description of the menu system, see page 104.

Angling the door mirror when parking*

The door mirror can be angled down for the driver to view the side of the road when parking for example. Engage reverse gear and

press the **L** or **R** button. The door mirror resets when reverse gear is disengaged.

Automatic retraction when locking*

When the car is locked/unlocked with the remote control key the door mirrors are automatically retracted/extended.

The function can be activated/deactivated under **Car settings** → **Retract mirrors when locking**. For a description of the menu system, see page 104.

Resetting to neutral*

Mirrors that have been moved out of position by an external force must be electrically reset to the neutral position for electric retracting/extending to work.

- Retract the mirrors with the **L** and **R** buttons.
- Fold them out again with the **L** and **R** buttons.

The mirrors are now reset in neutral position.

Home safe and approach lighting

The light on the door mirrors illuminates when approach lighting or home safe lighting is selected, see page 76.



Windows, rearview and door mirrors

Rear window and door mirror defrosters



Use the defroster to quickly remove misting and ice from the rear window and the door mirrors.

Press the button once to start simultaneous rear window and door mirror defrosting. The light in the button indicates that the function is active. Defrosting is deactivated automatically and its duration is controlled by the outside temperature.

The rear window is demisted/defrosted automatically if the car is started in an outside temperature lower than +7 °C.

Defrosting can be selected under **Climate settings** → **Auto. rear defroster**. Select between **On** or **Off**.

Interior rearview mirror



not available in mirrors with automatic dimming.

Manual dimming

1 Control for dimming.

Bright light from behind could be reflected in the rearview mirror and dazzle the driver. Use dimming by means of the dimming control when lights from behind are distracting:

1. Use dimming by moving the control in towards the passenger compartment.
2. Return to normal position by moving the control towards the windscreen.

Automatic dimming*

Bright light from behind is automatically dimmed by the rearview mirror. The control is

Power sunroof*

General

The sunroof controls are located in the roof panel. The sunroof can be opened vertically and horizontally. Ignition position I or II is required for the sunroof to be opened.

Horizontal opening



Horizontal opening, backward/forward

- 1 Opening, automatic
- 2 Opening, manual
- 3 Closing, manual
- 4 Closing, automatic

Opening

For maximum sunroof opening, move the control back to position 1 and release.

Open manually by pulling the control backwards to the point of resistance 2. The sun-

roof moves to maximum open position as long as the button is kept depressed.

Closing

Close manually by pressing the control forward to the point of resistance 3. The sunroof moves to closed position as long as the button is kept depressed.

WARNING

Risk of crushing when sunroof is closed. The sunroof's pinch protection only works during automatic closing, not manual.

Close automatically by pressing the control to position 4 and then release it.

The power supply to the sunroof is switched off by removing the remote control key from the ignition switch.

WARNING

If there are children in the car: Remember to always switch off the power supply to the sunroof by removing the remote control key if the driver leaves the car.

Vertical opening

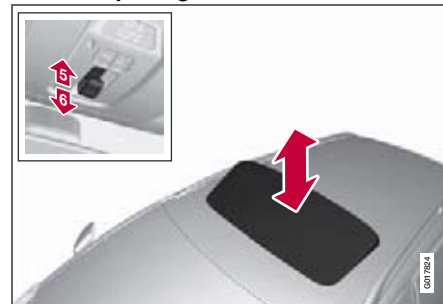

Vertical opening, raised at the rear edge

- 5 Opening: open by pressing the rear edge of the control upward.
- 6 Closing: close by pressing the rear edge of the control downward.



Closing using the remote control key or central locking button



One long press on the lock button closes the sunroof and all the windows. The doors and the tailgate are locked. To interrupt closing, press the lock button again.

WARNING

If the sunroof is closed using the remote control key, check that no one is in danger of becoming trapped in any way.

Sunscreen

The sunroof features a manual, sliding interior sunscreen. The sunscreen slides back automatically when the sunroof is opened. Grip the handle and slide the screen forward to close it.

Pinch protection

The sunroof's pinch protection function is triggered if it is blocked by an object during automatic closing. If blocked, the sunroof will stop and automatically open to the previous position.

Starting the engine

Petrol and diesel engines



Ignition switch with remote control key, start and stop button (see more information on page 65).

1. For cars with remote control key, insert the remote control key into the ignition switch. Gently push it forward until it is pulled in.

! IMPORTANT

Do not insert the remote control key backwards!
Grip the end with the detachable key blade.
See page 42.

2. Hold the clutch pedal fully depressed¹.
Depress the brake pedal in cars with automatic gearbox.

¹ If the car is moving then it is enough to press the **START/STOP** button to start the car.

3. Press the **START/STOP** button and release the button.

The starter motor works until the engine has started, but for no longer than 10 seconds (diesel up to 60 seconds). If the engine has not started after 10 seconds, try again by holding in the **START/STOP** button until the engine starts.

! WARNING

Always remove the remote control key from the ignition switch when leaving the car, especially if there are children in the car.

! WARNING

Never remove the remote control key from the ignition switch while driving or when the car is being towed. The steering lock could be activated which would mean that the car cannot be steered.

Never remove the remote control key with the keyless drive* function from the car while driving or during towing.

i NOTE

The idling speed can be noticeably higher than normal for certain engine types during cold starting. This is so that the emissions system can reach normal operating temperature as quickly as possible, which minimises exhaust emissions and protects the environment¹.

¹ If D or R position is engaged with automatic transmission, without the car being driven, then the engine speed is of course reduced, but at the same time it takes longer to reach operating temperature, so the environmental aspect is offset.

Keyless drive*

Follow steps 2–3 for starting petrol and diesel engines.

i NOTE

One precondition for starting the car is that the car's remote control keys with the keyless drive* function are located inside the passenger compartment or the cargo area.

Steering lock

The steering lock is deactivated when the remote control key is inserted into the ignition switch² and activated when the remote control key is removed from the ignition switch.



Starting the engine

Activate the steering lock when leaving the car to reduce the risk of car theft.

Diesel particle filter (DPF)

Diesel cars are equipped with a particle filter, which results in more efficient emission control. The particles in the exhaust gases are collected in the filter during normal driving. So-called "regeneration" is started in order to burn away the particles and empty the filter. This requires the engine to have reached normal operating temperature.

Regeneration of the filter takes place automatically at an interval of approximately 300–900 km depending on driving conditions. Regeneration normally takes between 10 and 20 minutes. During this time fuel consumption may increase slightly.

Regeneration in cold weather

If the car is frequently driven short distances in cold weather then the engine does not reach normal operating temperature. This means that regeneration of the diesel particle filter does not take place and the filter is not emptied.

When the filter has become approximately 80% full of particles, a yellow warning triangle illuminates on the dashboard, and a message is shown, **Soot filter full**. See manual is shown on the dashboard display.

Start regeneration of the filter by driving the car until the engine reaches normal operating temperature, preferably on a main road or motorway. The car should then be driven for approximately 20 minutes more.

When regeneration is complete the warning text is cleared automatically.

Use the parking heater* in cold weather so that the engine reaches normal operating temperature more quickly.



IMPORTANT

If the filter fills up with particles then it can be difficult to start the engine and the filter will be incapable of functioning. Then there is a risk that the filter will have to be replaced.

² On cars with Keyless drive* the steering lock is deactivated when the start button is pressed in for the first time. The steering lock is activated when the engine is switched off and the driver's door is opened.

Starting the engine

Jump starting

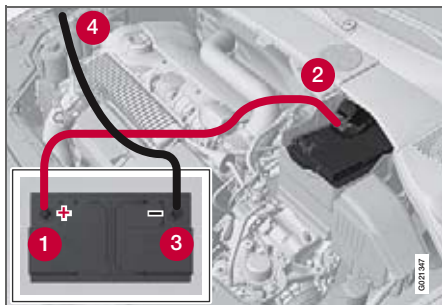

If the battery is flat then the car can be started with current from another battery.

The following points are recommended when using a donor battery in order to avoid the risk of an explosion:

1. Turn the car's ignition to position 0, see page 65.
2. Ensure that the donor battery is 12 volt.
3. If the donor battery is in another car, switch off the donor car's engine in the other car and ensure that the cars do not touch one another.
4. Connect the red jump lead to the positive terminal on the donor battery ①.

5. Open the clips on the front cover of the battery in your car and remove the cover, see page 198.
6. Connect the starter cable to the positive terminal ② on the battery in your car, located under a folding plastic cover.
7. Connect one clamp from the black jump lead to the donor battery's negative terminal ③.
8. Connect the other clamp to an earthing point, (right-hand engine mounting at the top, the outer screw head) ④. Check that the jump lead clamps are fixed securely so that there are no sparks during the starting procedure.

! IMPORTANT

Connect the start cable carefully to avoid short circuits with other components in the engine compartment.

9. Start the engine of the "donor car". Let the engine run a few minutes at a speed slightly higher than idle (1500 rpm).
10. Start the engine of the car with the flat battery. Do not touch the crocodile clips during the start procedure. There is a risk of sparks forming.
11. Remove the jump leads, first the black and then the red. Make sure that none of the clamps on the black jump lead

comes into contact with the battery's positive terminal or the clamp connected to the red jump lead.

! WARNING

The battery can generate oxyhydrogen gas, which is highly explosive. One spark, which can be generated if you connect a jump lead incorrectly, is sufficient to make the battery explode. The battery contains sulphuric acid, which can cause serious burns. If the acid comes into contact with eyes, skin or clothing, flush with large quantities of water. If acid splashes into the eyes, seek medical attention immediately.



Manual gearbox



Depress the clutch pedal fully during each gear change. Take your foot off the clutch pedal between gear changes. Follow the shifting pattern indicated.

For the best possible fuel economy, use the highest gear possible as often as possible.

Reverse gear inhibitor



Only engage reverse gear when the car is stationary.



Gearboxes

Automatic gearbox, Geartronic*



The information display shows the position of the gear selector using the following indications: P, R, N, D, S, 1, 2, 3, 4, 5 or 6. See page 60.

Gear positions

Parking position (P)

Select **P** when starting the engine or when the car is parked. The brake pedal must be depressed to disengage the gear selector from the **P** position.

The gearbox is mechanically blocked when the **P** position is engaged. Activate the elec-

tric parking brake by pressing the button, see page 98.

IMPORTANT

The car must be stationary when position **P** is selected.

Reverse (R)

The car must be stationary when position **R** is selected.

Neutral position (N)

No gear is engaged and the engine can be started. Apply the parking brake if the car is stationary with the gear selector in position **N**.

Drive (D)

D is the normal driving position. Shifting up and down takes place automatically based on the level of acceleration and speed. The car must be stationary when the gear selector is moved to position **D** from position **R**.

Geartronic* – Sport mode (S)¹

The Sport programme provides sportier characteristics and allows higher engine speed for the gears. At the same time it responds more quickly to acceleration. During active driving, the use of a lower gear is prioritised, leading to a delayed upshift.

Sport mode is obtained by moving the lever from **D** position to the right-hand end position at **M**. The information display shifts the indication from **D** to **S**.

Sport mode can be selected at any time while driving.

¹ Only on the 3.0 model.



Gearboxes

Geartronic* – manual gear positions (M)

The driver can also change gear manually using the Geartronic automatic gearbox. The car engine-brakes when the accelerator pedal is released.

Manual gearshift mode is obtained by moving the lever from position **D** to the right-hand end position at **M**. The information display shifts the indication from **D** to one of the figures **1-6**, depending which gear is engaged just then, see page 60.

Move the lever forwards towards **+** (plus) to change up a gear and release the lever, which returns to its rest position at **M**.

Pull the lever back towards **-** (minus) to change down a gear and release the lever.

The manual gearshift mode **M** can be selected at any time while driving.

To return to automatic driving mode; move the lever to the left-hand end position at **D**.

Geartronic automatically shifts down if the driver allows the speed to decrease lower than a level suitable for the selected gear, in order to avoid jerking and stalling.

i NOTE

If the gearbox has a Sport programme then the gearbox will only become manual after the lever has been moved forwards or backwards in its **M** position. The information display then shifts the indication from **S** to show which of the gears **1-6** is engaged.

Kick-down

When the accelerator pedal is pressed all the way to the floor (beyond the position normally regarded as full acceleration) a lower gear is immediately engaged. This is known as kick-down.

If the accelerator is released from the kick-down position, the gearbox automatically changes up.

Kick-down is used when maximum acceleration is needed, such as for overtaking.

Safety function

To prevent overrevving the engine, the gearbox control program has a protective down-shift inhibitor which prevents the kick-down function.

Geartronic does not permit downshifting/kick-down which would result in an engine speed high enough to damage the engine. Nothing happens if the driver still tries to shift down in this way at high engine speed – the original gear remains engaged.

When kick-down is activated the car can change one or more gears at a time depending on engine speed. The car changes up when the engine reaches its maximum speed in order to prevent damage to the engine.

Mechanical gear selector inhibitor

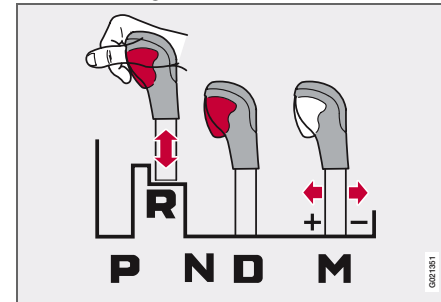

The gear selector can be moved forward and back freely between **N** and **D**. Other positions are locked with a latch that is released with the inhibitor button on the gear selector.

With the inhibitor button depressed the lever can be moved forwards or backwards between **P**, **R**, **N** and **D**.

Gearboxes

Automatic gear selector inhibitor

The automatic gearbox has special safety systems:

Keylock

To remove the remote control key from the ignition switch, the gear selector must be in the **P** position. The remote control key is locked in all other positions.

Parking position (P)

Stationary car with engine running:

Keep your foot on the brake pedal when moving the gear selector to another position.

Electric gear inhibitor – Shiftlock Parking position (P)

To be able to move the gear selector from **P** to other gear positions, the brake pedal must be depressed and the ignition must be in position **II**, see page 88.

Shiftlock – Neutral (N)

If the gear selector is in the **N** position and the car has been stationary for at least 3 seconds (irrespective of whether the engine is running) then the gear selector is locked.

To be able to move the gear selector from **N** to another gear position, the brake pedal must be depressed and the ignition must be in position **II**, see page 88.

Deactivating the automatic gear selector inhibitor



If the car cannot be driven, e.g. due to a flat battery, the gear selector must be moved from the **P** position so that the car can be moved.

- Lift away the rubber mat on the floor behind the centre console and open the hatch.
- Fully insert the key blade. Press the key blade down and keep it held down. Move the gear selector from the **P** position. For information on the key blade, see page 38.



All Wheel Drive – AWD (All Wheel Drive)*

All Wheel Drive is always engaged

All Wheel Drive means that the car is driving on all four wheels at the same time.

The power is automatically distributed between the front and rear wheels. An electronically controlled clutch system distributes the power to the wheels that have the best grip on the current road surface. This provides the best traction and prevents wheel spin. Under normal driving conditions, the majority of power is transmitted to the front wheels.

All Wheel Drive improves driving safety in rain, snow and icy conditions.



Foot brake

General

The car is equipped with two brake circuits. If one brake circuit is damaged then this will mean that the brakes engage at a deeper level and harder pressure on the pedal is needed to produce the normal braking effect.

The driver's brake pedal pressure is reinforced by a brake servo.

WARNING

The brake servo only works when the engine is running.

If the brake is used when the engine is switched off then the pedal will feel stiff and more force must be used to brake the car.

In very hilly terrain or when driving with a heavy load the brakes can be relieved by using engine braking. Engine braking is most efficiently used if the same gear is used downhill as up.

For more general information on heavy loads on the car, see page 227.

Anti-lock braking system

The car is equipped with ABS (Anti-lock Braking System) that prevents the wheels from locking during braking. This means the ability to steer is maintained and it is easier to swerve to avoid a hazard for example. Vibra-

tion may be felt in the brake pedal when this is engaged and this is normal.

After the engine has been started and the car has reached 20 km/h there is a short automatic test of the ABS system. The test may be felt as pulses in the brake pedal.

Cleaning the brake discs

Coatings of dirt and water on the brake discs may result in delayed brake function. This delay is minimised by cleaning the brake linings.

Manual cleaning is advisable with wet road surfaces, prior to long-stay parking and after the car has been washed. Carry this out by braking gently during a short period while en route.



Emergency Brake Assistance

Emergency Brake Assistance (EBA) helps to increase brake force and so reduce braking distance. The EBA system detects the driver's braking style and increases brake force as necessary. The brake force can be reinforced up to the level when the ABS system is engaged. The EBA function is interrupted when the pressure on the brake pedal is reduced.



NOTE

When EBA is activated the brake pedal lowers slightly more than usual, depress (hold) the brake pedal as long as necessary. If the brake pedal is released then all braking ceases.

Symbols in the combined instrument panel

Symbol	Specification
	Constant glow – Check the brake fluid level. If the level is low, fill with brake fluid and check for the cause of the brake fluid loss.
	Constant glow for two seconds when the engine is started – There was a fault in the brake system's ABS function when the engine was last running.

WARNING

If  and  illuminate at the same time then a fault may have arisen in the brake system. If the level in the brake fluid reservoir is normal at this stage, drive carefully to the nearest authorised Volvo workshop and have the brake system checked. If the brake fluid is under the MIN level in the brake fluid reservoir, do not drive further before topping up the brake fluid. The reason for the loss of brake fluid must be investigated.



Hill Descent Control (HDC)

General¹

HDC can be compared to an automatic engine brake. When you release the accelerator on downhill gradients the car is normally braked by means of the engine striving for low engine idling speeds, so-called engine braking. But the steeper the road and the more load there is in the car, the faster the car rolls despite engine braking. In order to then reduce speed the driver has to assist using the footbrake.

The function makes it possible to increase/reduce speed on steep downhill gradients, with a foot only on the accelerator pedal, without using the footbrake. The brake system brakes itself and automatically provides a low and even speed, so allowing the driver to fully focus on steering.

HDC is particularly helpful on steep gradients with an uneven road surface and slippery sections. E.g. when launching a boat on a trailer from a ramp.

WARNING

HDC does not work in all situations, but is instead only intended to be supplementary assistance.

The driver always has ultimate responsibility that the car is driven safely.

¹ HDC is only available on the XC70 and is standard.

Function



HDC is engaged or disengaged using a switch on the centre console. A lamp in the button illuminates when the function is engaged. When HDC is operating the  symbol illuminates and the display shows **Hill Descent Control ON**.

The function only operates in first gear position and in reverse gear. For an automatic gearbox, gear position **1** must be selected, which is shown with the figure 1 in the trip computer display, see page 93.

NOTE

HDC cannot be activated in an automatic gearbox with the gear selector in position **D**.

Operation

HDC allows the car to roll at a maximum of 10 km/h forwards with engine braking and 7 km/h backwards. However, any speed within the gear's speed register can be selected using the accelerator pedal. When the accelerator pedal is released, the car is braked quickly to 10 or 7 km/h respectively, irrespective of the hill's gradient and without the need for the footbrake.

The brake lights come on automatically when the function is operating. The driver can brake or stop the car at any time by using the footbrake.

HDC is deactivated:

- with the on/off button on the centre console
- if a gear higher than **1** is selected on a manual gearbox
- if a gear higher than **1** is selected on an automatic gearbox, or if the gear selector is moved to position **D**.

The function can be disengaged at any time. If it takes place on a steep downhill gradient then the braking effect will not release directly, but slowly instead.

NOTE

When HDC is activated, engine response during acceleration seems slower than normal.



Parking brake

Parking brake, electric*

An electric parking brake has the same applications as a manual parking brake, e.g. when starting uphill.

Function

A faint electric motor noise can be heard when the parking brake is being applied. The noise can also be heard during the automatic function checking of the parking brake.

If the car is stationary when the parking brake is applied then it only acts on the rear wheels. If it is applied when the car is moving then the normal foot brake is used, i.e. the brake acts on all four wheels. Brake function changes over to the rear wheels when the car is almost stationary.

Low battery voltage

If the battery voltage is too low then the parking brake can neither be released nor applied. Connect a donor battery if the battery voltage is too low, see page 90.

How to apply the parking brake



Parking brake control

1. Press the foot brake pedal down firmly.
2. Press the control.
3. Release the foot brake pedal and make sure that the car is at a standstill position.
4. When parking the vehicle always put the gear selector in position **1** (for manual transmission) or **P** (for automatic transmission).

The symbol  in the combined instrument panel flashes until the parking brake is fully applied. When the symbol illuminates the parking brake is applied.

In an emergency the parking brake can be applied when the vehicle is moving by holding in the control. When the control is

released or the accelerator pedal is depressed the braking is interrupted.

NOTE

In the event of emergency braking at speeds above 10 km/h a signal sounds during the braking procedure.

Parking on a hill

If the car is parked facing uphill; turn the wheels away from the kerb.

If the car is parked facing downhill, turn the wheels towards the kerb.

How to release the parking brake



Parking brake control



Parking brake

Cars with manual gearbox

Releasing manually

1. Insert the remote control key in the ignition switch.
2. Depress the brake pedal firmly.
3. Pull the control.

i NOTE

The parking brake can also be released manually by depressing the clutch pedal instead of the brake pedal. Volvo recommends the use of the brake pedal.

Releasing automatically

1. Start the engine.
2. Ease up the clutch and depress the accelerator.

! IMPORTANT

It is possible to release the parking brake automatically, even when the gear lever is in neutral position, if the engine is running.

Cars with automatic gearbox

Releasing manually

1. Put the seatbelt on.
2. Insert the remote control key in the ignition switch.
3. Depress the brake pedal firmly.
4. Pull the control.

Releasing automatically

1. Put the seatbelt on.
2. Start the engine.
3. Move the gear selector to position **D** or **R** and depress the accelerator.

i NOTE

For safety reasons, the parking brake is only released automatically if the engine is running and the driver is wearing a seatbelt. The parking brake is released immediately on cars with automatic gearbox when the accelerator pedal is depressed and the gear selector is in position **D** or **R**.

Heavy load uphill

A heavy load, such as a trailer, can cause the car to roll backward when the parking brake is released automatically on a steep incline. Avoid this by holding in the control while driving off. Release the control when the engine achieves traction.

Cars with Keyless drive* function

Release manually by pressing the **START/STOP** button, then depress the brake or clutch pedal and pull the control.

Symbols

Symbol	Specification
(P)!	Read the message on the information display
	A flashing symbol indicates that the parking brake is applied. If the symbol flashes in any other situation then this means that a fault has arisen. Read the message on the information display.

Messages





Parking brake

Parking brake not fully released – A fault is preventing the parking brake from being released. Contact an authorised Volvo workshop. A warning signal sounds if you pull away with this error message.

Parking brake not applied – A fault is preventing the parking brake from being applied. Try to apply and release. Contact a Volvo workshop if the message remains.

The message is also illuminated on cars with manual gearbox when the car is driven at low speed with the door open in order to alert the driver that the parking brake may have been unintentionally disengaged.

Parking brake Service required – A fault has arisen. Contact a Volvo workshop if the fault remains.

If the car has to be parked before the fault has been rectified then the wheels must be turned as if parking on a hill and the gear selector must be in position **1** (manual gearbox) or **P** (automatic gearbox).

Replacing the brake linings

The rear brake linings must be replaced by an authorised Volvo workshop due to the design of the electric parking brake.



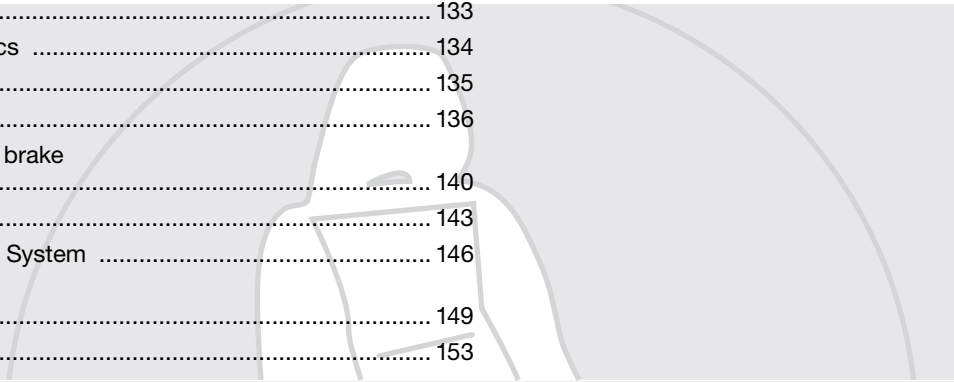

Menus and messages	104
Climate control	109
Audio system	120
Trip computer	130
Compass*	132
DSTC –Stability and traction control system	133
Adapting driving characteristics	134
Cruise control*	135
Adaptive cruise control*	136
Collision warning system with brake support*	140
Parking assistance*	143
BLIS* –Blind Spot Information System	146
Comfort inside the passenger compartment	149
Built-in phone*	153

COMFORT AND DRIVING PLEASURE



04



Menus and messages

Centre console

Some functions are controlled from the centre console via the menu system or via the keypad in the steering wheel. Each function is described under its respective section.

The current menu level is shown at the top right of the centre console's display.

Centre console controls

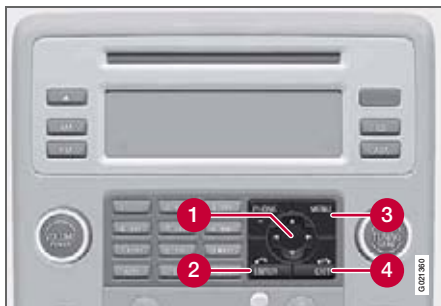

Centre console with information display and controls for menus.

- 1 Navigation button – scrolls and selects among menu options
- 2 **ENTER** – selects menu options
- 3 **MENU** – leads to the menu system

- 4 **EXIT** – leads back one step in the menu structure. A long press leads out from the menu system.

Steering wheel keypad



- 1 **ENTER***
- 2 **EXIT***
- 3 Navigation buttons – up/down.

If the steering wheel keypad has **ENTER** and **EXIT** then the buttons 1 to 3 have the same function as in the centre console.

Search paths

Access to some functions is provided directly via the function buttons and some are reached via the menu system.

Search paths to the menu system functions are stated in the form: **Car settings** → **Lock**

settings, which is on the assumption that the following is carried out beforehand:

1. Press **MENU**.
2. Scroll to **Menu** and press **ENTER**.
3. Scroll to **Submenu** and press **ENTER**.

The navigation button can be used instead of **ENTER** and **EXIT** when navigating the menu hierarchy. The right-hand arrow is equal to **ENTER** and the left-hand arrow to **EXIT**.

The menu options are numbered and can also be selected directly with the numerical keypad (only 1 – 9).



Menus and messages

Menu overview

The phone and audio sources have different main menus. The following menus are included in all main menus:

Car key memory

Seat & mirror positions*

Car settings

Fold mirr. when locking*

Collision warn. settings*

Information

Light settings

Lock settings

Reduced Guard¹

Parking camera settings*

Steering force level*

Climate control settings

Automatic blower adjust

Auto. rear defroster

Recirculation timer

Reset climate settings

Main menu AM

Audio settings²

Sound stage

Equalizer, front

Equalizer, rear

Auto. volume control

Reset the audio settings

Main menu FM

FM settings

News

TP (Traffic information)

Radio text

PTY (Programme type)

Advanced radio settings

Audio settings

Main menu CD

Random

Off

Folder³

Disc²

Single disc⁴

All discs³

CD settings

Disc text*

News

TP (Traffic information)

Audio settings

Main menu AUX

Volume, AUX input

Audio settings

¹ Certain models.

² The menu option for audio settings is available in all audio sources.

³ Only in systems that allow the playback of MP3 and WMA format audio files.

⁴ Only in systems with CD changer.



Menus and messages

Main menu, built-in phone

Call register

- Last 10 missed calls
- Last 10 received calls
- Last 10 dialled calls
- Erase list
- Call duration

Phone book

- New contact
- Search
- Copy all
- Erase SIM
- Erase phone
- Memory status

Messages

- Read
- Write new
- Message settings

Call options

- Send my number
- Call waiting
- Automatic answer

Voice mail number

Diversions

Phone settings

Network selection

SIM security

Edit PIN code

Sounds and volume

IDIS

Reset Phone settings



Menus and messages

Combined instrument panel

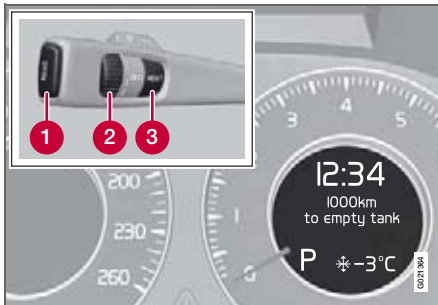

Information display and controls for menus

- 1 **READ** – access to message list and message confirmation.
- 2 Thumbwheel – browse between menu options.
- 3 **RESET** – reset the active function. Used in certain cases to select/activate a function, see the explanation under each respective function.

The menus shown on the information displays in the combined instrument panel are controlled with the left-hand stalk switch. The menus shown depend on ignition position. If a message appears then this must be acknowledged with **READ** for the menus to be shown.

Menu overview¹

To empty tank
 average
 Instantaneous
 Average speed
 Lane departure warning
 Tyre pressure Calibration
 Current speed
 Park heat timer AM/PM
 Park vent timer AM/PM
 Park timer mode
 Direct start Park heat
 Direct start Park el.heat
 Direct start Park vent
 Additional heat auto
 Rest heat start
 DSTC

¹ Certain menu options are optional

Message



Text message in the information display

When a warning, information or indicator symbol illuminates, a corresponding message appears on the information display. An error message is stored in a memory list until the fault is rectified.

Press **READ** to acknowledge and browse between the messages.

NOTE

If a warning message appears while you are using the trip computer, the message must be read (press **READ**) before the previous activity can be resumed.



04 Comfort and driving pleasure

Menus and messages

Message	Specification
Stop safely	Stop and switch off the engine. Serious risk of damage. Contact an authorised Volvo workshop.
Stop engine	Stop and switch off the engine. Serious risk of damage. Contact an authorised Volvo workshop.
Service urgent	Have the car checked by an authorised Volvo workshop immediately.
Service required	Have the car checked by an authorised Volvo workshop as soon as possible.
See manual	Read the owner's manual.
Book time for maintenance	Time to book regular service at an authorised Volvo workshop.

Message	Specification
Time for regular maintenance	Time for regular service at an authorised Volvo workshop. The timing is determined by the number of kilometres driven, number of months since the last service, engine running time and oil grade.
Maintenance overdue	If the service intervals are not followed then the warranty does not cover any damaged parts. Contact an authorised Volvo workshop for service.
Temporarily OFF	A function has been temporarily switched off and is reset automatically while driving or after starting again.
Power save mode	The audio system is switched off to save energy. Charge the battery.



General

Air conditioning

The car is equipped with Electronic Climate Control (ECC) or Electronic Temperature Control (ETC). The climate control system cools or heats as well as dehumidifies the air in the passenger compartment.

NOTE

The air conditioning can be switched off, but to ensure the best possible climate comfort in the passenger compartment and to prevent the windows from misting, it should always be on.

Actual temperature

The temperature you select corresponds to the physical experience with reference to factors such as air speed, humidity and solar radiation¹ etc. in and around the car.

The system includes a sun sensor¹ which detects the side from which the sun is shining. This means that the temperature can differ between the right and left-hand air vents despite the controls being set for the same temperature on both sides.

¹ Only applies to ECC

Sensor location

- The sun sensor is located on the top side of the dashboard.¹
- The temperature sensor for the passenger compartment is located below the climate control panel.
- The outside temperature sensor is located on the door mirror.
- The humidity sensor* is located in the interior rearview mirror.¹

NOTE

Do not cover or block the sensors with clothing or other objects.

Side windows and sunroof

To ensure that the air conditioning works optimally, the side windows, and sunroof if appropriate, should be closed.

Misting windows

Remove misting on the insides of the windows by primarily using the defroster function.

To reduce the risk of misting, clean the windows with a normal window cleaning agent.

Temporary shut-off of the air conditioning

When the engine requires full power, e.g. for full acceleration or driving uphill with a trailer,

the air conditioning could be temporarily switched off. There may then be a temporary increase in temperature.

Condensation

In warm weather, condensation from the air conditioning may drip under the car. This is normal.

Ice and snow

Remove ice and snow from the climate control system air intake (the grille between the bonnet and the windscreen).

Fault tracing and repair

Entrust fault tracing and repair of the climate control system to an authorised Volvo workshop only.

Refrigerant

The climate control system contains R134a refrigerant. This refrigerant contains no chlorine, which means that it is harmless to the ozone layer. Have an authorised Volvo workshop carry out the filling/changing of refrigerant.

Total airing function

The function opens/closes all side windows simultaneously and can be used for example to quickly air the car during hot weather, see page 39.



Climate control

Passenger compartment filter

All air entering the car's passenger compartment is cleaned with a filter. This must be replaced at regular intervals. Follow the Volvo Service Programme for the recommended replacement intervals. If the car is used in a severely contaminated environment, it may be necessary to replace the filter more often.

NOTE

There are different types of passenger compartment filter. Make sure that the correct filter is fitted.

Clean Zone Interior Package (CZIP)*

This option keeps the passenger compartment clear of allergy and asthma inducing substances. For more information, see the Clean Zone Interior brochure included when the car is purchased. The following is included:

- An enhanced fan function that means that the fan starts when the car is opened with the remote control key. The fan fills the passenger compartment with fresh air. The function starts when required and is disengaged automatically after a time or when one of the passenger compartment doors is opened. The time interval during

which the fan blows will be gradually reduced until the car is four years old.

- Interior Air Quality System (IAQS). A fully automatic system that cleans the air in the passenger compartment from contaminants such as particles, hydrocarbons, nitrous oxides and ground-level ozone.

Use of tested materials in the interior equipment.

The materials have been developed in order to minimise the quantity of dust in the passenger compartment and they contribute to making the passenger compartment easier to keep clean. The carpets in both the passenger compartment and the cargo area are removable and easy to remove and clean. Use cleaning agents and car care products recommended by Volvo, see page 219.

NOTE

In cars with the Clean Zone Interior Package the IAQS air filter must be replaced every 15 000 km or once per year. In cars without the Clean Zone Interior Package the IAQS air filter must be replaced at the normal service.

Menu settings

It is possible to change the default settings for three of the climate control system's functions via the centre console, see page 104:

- Fan speed in automatic mode¹, see page 114.
- Recirculation timer for passenger compartment air, see page 114.
- Automatic rear window defrosting, see page 85.

All climate control system functions are set to original position with **RESET** via the display.

¹ Only applies to ECC



Climate control

Air distribution

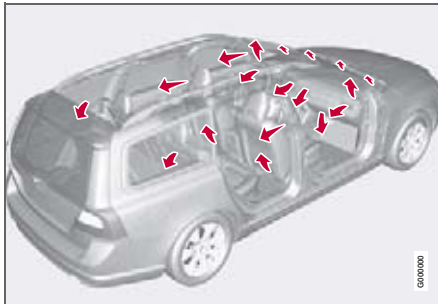

The incoming air is divided between 20 different vents in the passenger compartment.

Air distribution is fully automatic in **AUTO** mode.¹

If necessary it can be controlled manually, see page 116.

Air vents in the dashboard

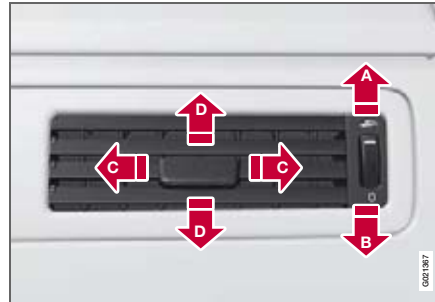

- A** Open
- B** Closed
- C** Lateral airflow
- D** Vertical airflow

Aim the outer vents at the side windows to remove misting.

A certain air flow always comes from the vents in order to maintain a good climate in the passenger compartment.

Air vents in the door pillars

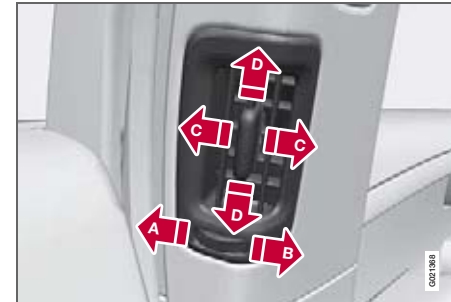

- A** Open
- B** Closed
- C** Lateral airflow
- D** Vertical airflow

Aim the vents at the windows to remove misting.

Aim the vents into the passenger compartment to maintain a comfortable climate in the rear seat.

Remember that small children may be sensitive to air flows and draughts.

¹ Only applies to ECC



Climate control

Climate control

Electronic Temperature Control, ETC

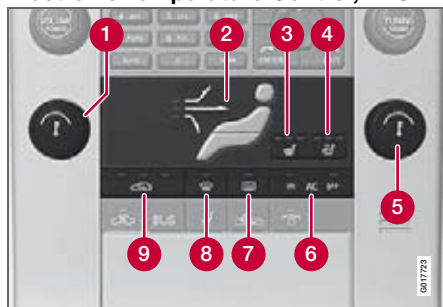

- 1 Fan
- 2 Air distribution
- 3 Heated front seats, left-hand side
- 4 Heated front seats, right-hand side
- 5 Temperature control
- 6 **AC ON/OFF** – Air conditioning On/Off
- 7 Rear window and door mirror defrosters, see page 85
- 8 Max. defroster
- 9 Recirculation

Electronic climate control, ECC*

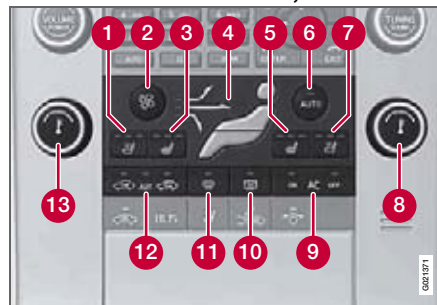

- 1 Ventilated front seats*, left-hand side
- 2 Fan
- 3 Heated front seats, left-hand side
- 4 Air distribution
- 5 Heated front seats, right-hand side
- 6 **AUTO**
- 7 Ventilated front seats*, right-hand side
- 8 Temperature control, right-hand side
- 9 **AC ON/OFF** – Air conditioning On/Off
- 10 Rear window and door mirror defrosters, see page 85
- 11 Max. defroster
- 12 Recirculation/Air quality system
- 13 Temperature control, left-hand side

Operation

Ventilated front seats*



Ventilated front seats can only be specified when ECC is installed in the car. The ventilation system consists of fans in the seats and backrests that drive air through the seat upholstery. The cooling effect increases the cooler the passenger compartment air becomes.

The ventilation is regulated from the climate control and takes seat temperature, solar radiation and outside temperature into consideration.

The ventilation can be used at the same time as seat heating. For example, the function can be used to dry damp from clothing.

The ventilation system can be activated when the engine is running. There are three comfort levels that produce different cooling and dehumidification outputs:

- Comfort level three: press the button once for maximum output – three lamps illuminate.
- Comfort level two: press the button twice for a lower output – two lamps illuminate.



Climate control

- Comfort level one: press the button three times for the lowest output – one lamp illuminates.

Press the button four times to switch off the function – no lamps illuminate.

NOTE

The seat ventilation should be used carefully by people sensitive to draughts. Comfort level one is recommended for long-term use.

IMPORTANT

The seat ventilation cannot be started when passenger compartment temperature is less than 5 °C. This is to avoid chilling anyone sitting in the seat.

Fan



Turn the knob to increase or decrease fan speed. If **AUTO**¹ is selected then fan speed is regulated automatically. The previously set fan speed is disengaged.

NOTE

If the fan is fully disengaged the air conditioning is not engaged which may result in a risk of misting windows.

Heated seats*

Front seats



- Press the button once for the highest heat level – three lamps illuminate.
- Press the button twice for a lower heat level – two lamps illuminate.
- Press the button three times for the lowest heat level – one lamp illuminates.
- Press the button four times to switch off the heat – no lamps illuminate.

Rear seats



Heat control takes place in the same way as for the front seat.

Air distribution



The figure consists of three buttons. When the buttons are pressed a lamp in front of the respective part of the figure illuminates and shows which air distribution is selected, see page 116.

¹ Only applies to ECC



Climate control

Auto*

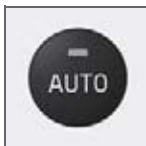

The AUTO function is only available if ECC is installed in the car. The function automatically regulates temperature, air conditioning, fan speed, recirculation and air distribution.

If you select one or more manual functions, the other functions continue to be controlled automatically. The air quality sensor is engaged and all manual settings are switched off when **AUTO** is pressed. The display shows **AUTO CLIMATE**.

Fan speed in automatic mode can be set under **Climate settings** → **Automatic blower adjust**. Choose between **Low**, **Normal** or **High**.

For a description of the menu system, see page 104.

Temperature control



ECC: The temperatures on the driver and passenger sides can be set independently.

ETC: The whole of the passenger compartment is regulated using the knob.

When the car is started, the most recent setting is resumed.

NOTE

Heating or cooling cannot be hastened by selecting a higher/lower temperature than the actual temperature required.

AC – Air conditioning on/off



ON: The air conditioning is controlled by the system's AUTO function. This way, incoming air is cooled and dehumidified.

OFF: When the defroster function is activated the air conditioning is switched on automatically (can be switched off using the **AC** button).

Defroster



Used to quickly remove misting and ice from the windscreen and side windows. Air flowing to the windows. The light in the defroster button illuminates

when the function is active.

The following also takes place in order to provide maximum dehumidification in the passenger compartment:

- the air conditioning is automatically engaged
 - recirculation is automatically disengaged.
- The air conditioning can be disengaged manually using the **AC** button. When the defroster function is switched off the climate control resumes to the previous settings.

Recirculation/Air quality system

Recirculation



When recirculation is engaged the right-hand orange light illuminates in the button¹. The function is selected to shut out bad air, exhaust gases etc. from the

passenger compartment. The air in the passenger compartment is recirculated, i.e. no outside air is taken into the car when this function is activated. If the air in the car recirculates for too long, there is a risk of misting on the insides of the windows.

Timer

With the timer function activated the system will exit manually activated recirculation mode according to a time that depends on the outside temperature. This reduces the risk of ice, misting and bad air. Activate/

¹ Only applies to ECC



deactivate the function under **Climate control settings** → **Recirculation timer**. For a description of the menu system, see page 104.

NOTE

When Defroster is selected, recirculation is always deactivated.

Air quality system*



The air quality system separates gases and particles to reduce the levels of odours and pollution in the passenger compartment. If the outside air is contaminated then

the air intake is closed and the air is recirculated. When the **AUTO** button is depressed the air quality sensor is always engaged.

Activating recirculation/air quality sensor¹



Switch between the three functions by pressing the button repeatedly.

- The left-hand orange lamp illuminates – the air quality sensor is disengaged.

- The centre green lamp illuminates – recirculation not engaged, providing it is not required for cooling in hot weather.
- The right-hand orange lamp illuminates – recirculation is engaged.

NOTE

The air quality sensor should always be engaged in order to obtain the best air in the passenger compartment. Recirculation is limited in cold weather to avoid misting. If the insides of the windows start misting up, disengage the air quality sensor, and the defroster functions for the windscreen, the side and the rear windows should also be used to demist the windows.

Activating recirculation¹



Switch between recirculation on/off by repeatedly pressing the button. The lamp illuminates when recirculation is engaged.









¹ Only applies to ETC



04 Comfort and driving pleasure

Climate control

Air distribution table

	Air distribution	Use		Air distribution	Use
	 Air to windows. Some air flows from the air vents. The air is not recirculated. Air conditioning is always engaged.	To remove ice and misting quickly.		Air to the floor and windows. Some air flows from the dashboard air vents.	To ensure comfortable conditions and good demisting in cold or humid weather.
04	 Air to windscreen and side windows. Some air flows from the air vents.	To prevent misting and icing in a cold and humid climate, (not at too low fan speed to enable this).		Air to floor and from dashboard air vents.	In sunny weather with cool outside temperatures.
	 Airflow to windows and from dashboard air vents.	To ensure good comfort in warm, dry weather.		Air to floor. Some air flows to the dashboard air vents and windows.	To warm or cool the feet.
	 Airflow to the head and chest from the dashboard air vents.	To ensure efficient cooling in warm weather.		Airflow to windows, from dashboard air vents and to the floor.	To cool the feet or provide warmer air to the upper body in cold weather or hot, dry weather.



Fuel-driven parking heater*

General information about the parking heater

The parking heater can be started immediately or set using the timer. Here, start time refers to the time the car is heated and ready. The car's electronic system calculates when heating should be started based on the outside temperature. The heater is not run if the outdoor temperature exceeds 15 °C. At temperatures from -10 °C and below, the maximum running time of the parking heater is 50 minutes. When the parking heater is running, **Park heat ON** is shown on the information display.

WARNING

The car must be outdoors when the parking heater is used.

NOTE

When the parking heater is active there may be smoke from the right-hand wheel housing which is perfectly normal.

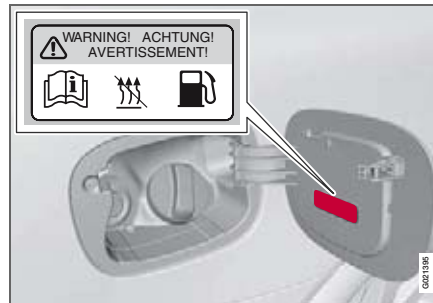

WARNING

Fuel which spills out can be ignited. Switch of the parking heater before starting to refuel. Check the information display to see that the parking heater is switched off.

Parking on a hill

If the car is parked on a steep hill, the front of the car should point downhill to ensure that there is a supply of fuel to the parking heater.

Battery and fuel

If the battery has insufficient charge or the fuel level is too low, the parking heater will be switched off automatically. A message appears on the information display. Confirm the message by pressing the **READ** button, see page 118.

IMPORTANT

Repeated use of the parking heater combined with short journeys may discharge the battery and impair starting. If the parking heater is used regularly, the car must be driven for the same time as the parking heater is run to ensure that the alternator has time to correspondingly charge the battery.



Climate control

Operation

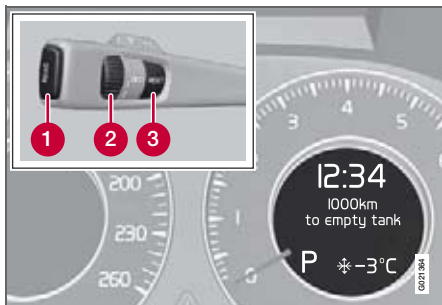

- 1 **READ** button
- 2 Thumbwheel
- 3 **RESET** button

For more information on the information display and **READ**, see page 107.

Message in the information display

When the timer settings or direct start are activated, the information symbol illuminates on the combined instrument panel and an explanatory text appears in the information display. The display also indicates which timer is active when the driver removes the remote control key from the keyhole to leave the car.

Clock/timer

If the car clock is reset the timer settings are deleted.

Direct start/shutdown

1. Use the thumbwheel 2 to scroll to **Direct start Park heat**.
2. Press **RESET** to switch between **ON** and **OFF**.
ON: The parking heater is controlled manually.
OFF: The parking heater is controlled automatically.

With direct start the parking heater will be activated for 50 minutes. Heating of the passenger compartment will begin as soon as the engine coolant has reached a temperature of 38 °C.

i NOTE

The car can be started and driven while the parking heater is still running.

Setting the timer

It is only possible to set times for the following 24 hours.

i NOTE

The engine must be switched off when setting the timer.

1. Scroll with the thumbwheel 2 to **Park heat timer**.
2. Touch **RESET** to move to the flashing hours setting.
3. Scroll with the thumbwheel 2 to the hours required.
4. Touch **RESET** to move to the flashing minutes setting.
5. Scroll with the thumbwheel 2 to the minutes required.
6. Touch **RESET** to confirm the setting.
7. Press **RESET** to activate the timer. After setting **PM** a second start time can be programmed for **AM**. Access this with the thumbwheel 2. Set the alternative start time in the same way as for **AM**.



Additional heater (diesel)*

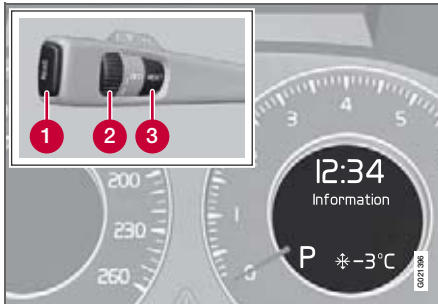

- 1 READ button
- 2 Thumbwheel
- 3 RESET button

The additional heater may be required for achieving the correct temperature in the passenger compartment during cold weather.

The additional heater starts automatically when extra heat is required and the engine is running. It is switched off automatically when the correct temperature is reached or when the engine is switched off.

NOTE

When the additional heater is active there may be smoke from the right-hand wheel housing which is perfectly normal.

Auto mode or shutdown

The additional heater can be switched off for short distances if required.

1. Use the thumbwheel 2 to scroll to Additional heat auto.
2. Press **RESET** to switch between **ON** and **OFF**.



Audio system

General

The audio system can be equipped with different options and different versions. There are three system versions: Performance, High Performance and Premium Sound. The system version is shown in the display when the audio system is started.

Dolby Surround Pro Logic II and the symbol  are trademarks of Dolby Laboratories Licensing Corporation. The Dolby Surround Pro Logic II System is manufactured under license from Dolby Laboratories Licensing Corporation.

Remote control key and ignition positions

The audio system can be used without the remote control key in the ignition switch for 15 minutes at a time.

NOTE

Remove the remote control key from the ignition switch if the audio system is used when the engine is switched off. This is to avoid discharging the battery unnecessarily.

If the audio system is active when the engine is switched off then it is activated automatically the next time the engine is started.

Overview



- 1 Input for external audio source (AUX)
- 2 Steering wheel keypad
- 3 Centre console control panel
- 4 Control panel with headphones socket*

Steering wheel keypad

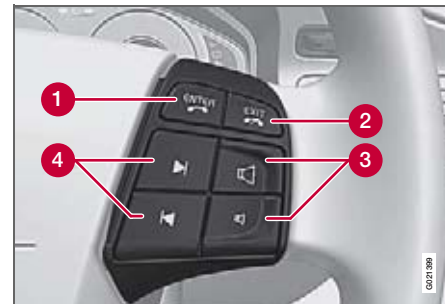

- 1 Confirm selection in menu system, accept call.
- 2 Lead up in menu system. Interrupt current function. End/refuse calls, clear entered characters.
- 3 Volume
- 4 A short press scrolls between CD tracks or preset radio stations. A long press fast-winds CD tracks or searches radio stations automatically.



Audio system

Rear control panel with headphones socket*

Headphones with an impedance of 16–32 ohm and sensitivity of 102 dB or higher are recommended for best sound reproduction.

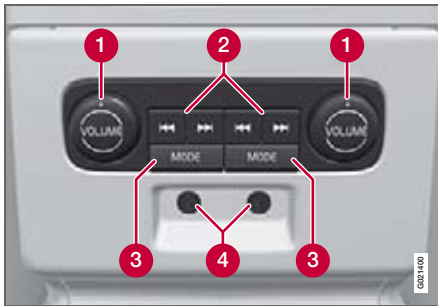

- ① Volume
- ② Scroll/search forward and backward
- ③ Audio source, activating
- ④ Headphones sockets (3.5 mm)

Activating/deactivating

The control panel is activated with **MODE** when the audio system is active. Deactivation is automatic when the audio system is deactivated or with a long press on **MODE**.

Scroll/search forward and backward

Short presses on ② are used to scroll between CD tracks or preset radio stations. Long presses are used to fast-wind CD tracks or to search for radio stations automatically.

Limitations

- The audio source (FM, AM, CD etc.) played back in the speakers cannot be controlled from the rear control panel.
- RDS messages may not appear if the radio is playing back in the headphones while another audio source is playing back in the speakers.

Menus and MY KEY¹

Some functions are controlled from the menu system in the centre console. For more information on menus, see page 104. For information on the audio system's functions together with handsfree or phone, see page 155.

Store favourite functions with MY KEY.



1. Select the function to be stored in the menu. Only a selection of the functions can be stored.
2. Hold **MY KEY** depressed for more than two seconds.
3. Activate the stored function with a short press on **MY KEY**.

¹ The MY KEY function is not available if the car is equipped with built-in phone as an option.



Audio system

The following functions can be stored
with MY KEY:

CD/CD changer

- Random (CD changer)
- News
- TP
- Track information

FM

- News
- TP
- Radio text
- Search PTY
- Show PTY text

AUDIO SETTINGS

- Sound setting
- Auto. volume control



Audio system

Audio functions

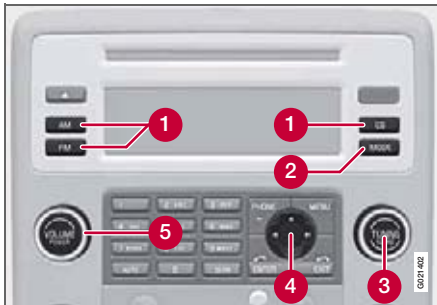

Centre console, controls for audio functions

- ❶ Internal audio sources: AM, FM and CD
- ❷ External audio source. For connection, see page 120
- ❸ Pushbutton and knob controls for adjusting the sound pattern
- ❹ Navigation button
- ❺ Volume and on/off

Audio volume and automatic volume control

The audio system compensates for disrupting noises in the passenger compartment by increasing the volume with the speed of the car. The level of compensation can be set at low, medium or high. Select the level under **Audio settings** → **Auto volume control**.



External audio source audio volume

The AUX input can be used for connecting an MP3 player for example, see page 120.

i NOTE

The audio quality may be impaired if the player is charged while the audio system is in AUX mode. In which case, avoid charging the player.

Sometimes the AUX external audio source can be heard at a different volume to the internal audio sources. If the audio volume of the external audio source is too high then the sound quality can be impaired. Prevent this by adjusting the input volume of the AUX input:

1. Set the audio system in AUX mode using **MODE** and navigate with ❹ to **Volume, AUX input**.
2. Turn the control ❸ or press  /  the navigation button.

Audio controls

Press the control ❸ repeatedly to browse among the following options. The adjustment is made by turning the control ❸.

i NOTE

Press **Menu** to access the audio settings. For more information, see page 104.

- **Bass** – Bass level.
- **Treble** – Treble level.
- **Fader** – Balance between the front and rear speakers.
- **Balance** – Balance between the right and left-hand speakers.
- **Subwoofer*** – Level for bass speaker. Turning the control ❸ anticlockwise to **MIN** deactivates the Subwoofer. The Subwoofer is located as illustrated below.

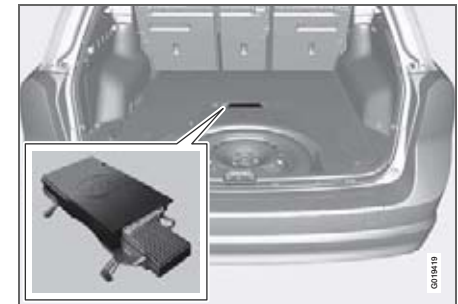



Audio system

- **Surround¹** – Surround settings.

Under **Surround** 3 channel stereo or Dolby Surround Pro Logic II can be activated by selecting **3-ch** or **Dpl2** respectively. This enables the following options:

- **Centre level¹** – Level for centre speaker.
- **Surround level¹** – Level for surround.

Equalizer

Sound levels for different frequencies can be adjusted separately using the equalizer².

1. Go to **Audio settings** and select **Equalizer Front** or **Equalizer Rear**.

The sound level for the wavelength is adjusted with **▲** / **▼** on the navigation button. Press **▶** / **◀** to select another wavelength.

2. Use **ENTER** to save or **EXIT** to close.

Sound stage³

The sound experience can be optimised for the driver's seat, both front seats or the rear seat. Select one of the options under **Audio settings** → **Soundstage**.

¹ Premium Sound

² Certain audio systems

³ Premium Sound

Optimum sound reproduction

The audio system is calibrated for optimum sound reproduction by means of digital signal processing.

This calibration takes into account loudspeakers, amplifiers, passenger compartment acoustics, listener position etc. for each combination of car model and audio system.

There is also a dynamic calibration that takes into account the position of the volume control, radio reception and vehicle speed.

The controls explained in these operating instructions, e.g. **Bass**, **Treble** and **Equalizer**, are only intended for the user to be able to adapt the sound reproduction according to personal taste.

CD functions

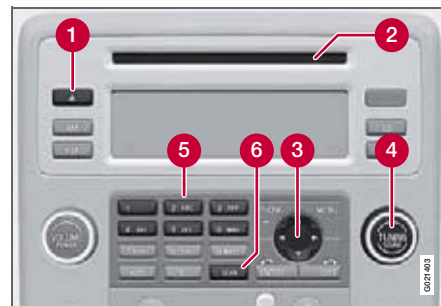

Centre console, controls for CD functions

- ❶ CD eject
- ❷ CD insert and eject slot
- ❸ Navigation button for changing CD tracks
- ❹ Fast-wind and change CD track
- ❺ CD changer position selection*
- ❻ Scan CD

Start playback (CD player)

If a music CD is in the player when **CD** is pressed then playback is started automatically. Otherwise, insert a disc and press **CD**.

**Audio system****Start playback (CD changer)**

If a CD position with a music CD is already selected when **CD** is pressed then playback starts automatically. Otherwise select a disc with the number buttons **1-6** or / on the navigation button.

Insert a CD (CD changer)

1. Select an empty position with the number buttons **1-6** or / on the navigation button.

An empty position is marked on the display. The text **Insert disc** shows that a new disc can be inserted. The CD changer can hold up to six CDs.

2. Insert a CD in the CD changer slot.

Disc eject

A CD will stay in the ejected position for approx. 12 seconds. Following which it is re-inserted in the player and playback continues.

Eject individual discs by pressing the eject button.

Eject all discs with a long press on the eject button. The entire magazine is emptied disc by disc.

Pause

If the volume is turned down completely, the CD player is stopped. The player is restarted when volume is increased.

Audio files¹

The CD player also supports MP3 and WMA format audio files.

NOTE

Some copy protected audio files may not be read by the player.

When a CD containing audio files is inserted into the player the disc's directory structure is read in. It may take a while before playback starts depending on the quality of the disc.

Navigation and playback

If a disc containing audio files is inside the CD player then **ENTER** leads to the disc's directory structure. The directory structure is navigated in the same way as the audio system's menu structure. Audio files have the symbol and directories have the symbol . Start audio file playback with **ENTER**.

When the playback of a file is finished the playback of the other files in the same directory continues. Directory change takes place automatically when all files in the current directory have been played back.

Fast-wind/change CD tracks and audio files

Short presses / on the navigation button are used to scroll between CD tracks/audio files. Long presses are used to fast-wind CD tracks/audio files. The steering wheel keypad can also be used for this purpose. Track change can also be made by turning Tuning.

Scan CD

This function plays the first ten seconds of each CD track/audio file. Press **SCAN** to activate. Interrupt with **EXIT** or **SCAN** to continue playback of the current CD track/audio file.

Random

This function plays the tracks in random order. The random CD tracks/audio files can be scrolled through in the normal way.

¹ High Performance and Premium Sound



Audio system

NOTE

It is only possible to scroll between random CD tracks on the current disc.

Different messages appear depending on which random function has been selected:

- **RANDOM** means that the tracks from only one music CD are played
- **RND ALL** means that all tracks on all music CDs in the CD changer are played.
- **RANDOM FOLDER** means that the audio files in a directory on the current CD are played.

CD player

If a normal music CD is being played, activate/deactivate under **Random**.

If a disc with audio files is being played back, activate/deactivate under **Random** → **Folder**.

CD changer

If a normal music CD is being played under **Random** → **Single disc** or **Random** → **All discs**, then the option **All discs** only applies to the music CDs in the changer.

If a CD with audio files is being played, activate/deactivate instead under **Random** → **Folder**. If you select another CD the function is deactivated.

Track information

If track information is stored on a music CD then it can be shown on the display. This also applies to MP3 and WMA files for Premium Sound and High Performance. Activate/deactivate in CD mode under **CD settings** → **Track information**.



Audio system

Radio functions

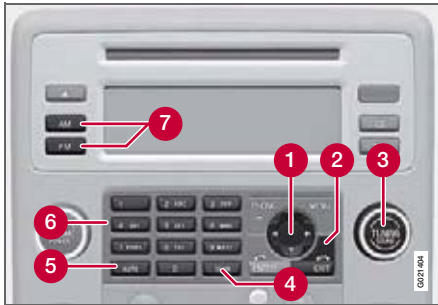

Centre console, controls for radio functions

- 1 Navigation button for tuning, automatic
- 2 Cancel function in progress
- 3 Tuning, manual
- 4 Scan wavelength
- 5 Preset storage, automatic
- 6 Preset buttons and preset storage, manual
- 7 Select wavelength AM and FM (FM1 and FM2)

Tuning, automatic

1. Select wavelength using **FM** or **AM**.
2. Press / on the navigation button.

Tuning, manual

1. Select wavelength using **FM** or **AM**.
2. Turn **TUNING**.

Preset

Ten station presets can be stored per wavelength. FM has two memories for presets: **FM1** and **FM2**. Only radio stations played through the car's speakers can be stored as presets. The stored presets are selected using the preset buttons.

Preset storage can be carried out manually or automatically.

Preset storage, manual

1. Tune into a station.
2. Hold in one of the preset buttons until the message **Channel stored** appears on the display.

Preset storage, automatic

The function is especially useful in areas where the radio stations and their frequencies are unfamiliar. The ten strongest radio stations are stored automatically in a separate memory.

1. Select wavelength using **FM** or **AM**.
2. Hold in **AUTO** until **Autostoring...** appears on the display.

Once **Autostoring...** disappears from the display, the stations are stored. The radio con-

tinues in Auto mode and **Auto** appears on the display. The automatically stored presets can now be selected using the preset buttons. Automatic preset storage can be cancelled using **EXIT**.

Auto mode is cancelled by pressing for example **AUTO** or **FM**.

Returning to Auto mode provides access to the autostored presets:

1. Press **AUTO**.
- Auto** appears on the display.
2. Press a preset button.

Scan wavelength

The function automatically searches the current wavelength for strong stations. When a station is found, it is played for approx. eight seconds before scanning is resumed. While the station is playing it can be stored as a preset as usual.

1. Select wavelength using **AM** or **FM**.
2. Press **SCAN**.

SCAN appears on the display. Close using **SCAN** or **EXIT**.

RDS functions

Radio Data System – RDS links FM transmitters into a network. An FM transmitter in such



Audio system

a network sends information that gives an RDS radio the following functions:

- Automatically switches to a stronger transmitter if reception in the area is poor.
- Searches for programme type, such as traffic information or news.
- Receives text information on current radio programme.

NOTE

Some radio stations do not use RDS or only some if its functionality.

If a required programme type is located the radio can switch stations interrupting the audio source currently in use. For example, if the CD player is in use, it is paused. The interrupting transmission is played at a pre-set volume, see page 129. The radio returns to the previous audio source and volume when the set programme type is no longer broadcast.

The programme functions alarm (ALARM), traffic information (TP), news (NEWS), and programme types (PTY) interrupt one another in order of priority, where alarm has the highest priority and programme types has the lowest. For further programme interruption settings, see EON and REG,

page 129. Press **EXIT** to return to the interrupted audio source.

Alarm

This function is used to warn of serious accidents and catastrophes. The alarm cannot be temporarily interrupted or deactivated. The message **ALARM!** appears on the display when an alarm message is transmitted.

Traffic information – TP

This function allows traffic information broadcast within a set station's RDS network to break through. The symbol **TP** shows that the function has been activated. If the set station can send traffic information then **TP** appears on the display.

Activate/deactivate under **FM settings** → **TP**.

TP from current station/all stations

The radio can interrupt with traffic information from only the set (current) station or from all stations.

Go to **FM settings** → **Advanced radio settings** → **TP** → **TP Station** to change.

News

This function allows news broadcasts within a set station's RDS network to break

through. The symbol **NEWS** shows that the function is active.

Activate/deactivate under **FM settings** → **News**.

News from current/all stations

The radio can interrupt with news from only the set (current) station or from all stations. Go to **FM settings** → **Advanced radio settings** → **News station** to change.

Programme types – PTY

The PTY function can be used to select different programme types, such as pop music and serious classic. The PTY symbol indicates that the function is active. This function allows programme types broadcast within a set station's RDS network to break through.

Activate in FM mode by selecting a programme type under **FM settings** → **PTY** → **Select PTY**.

Deactivate by clearing the PTYs under **FM settings** → **Clear all PTYs**.

PTY search

This function searches the entire wavelength for the selected programme type.

1. Select a PTY under **FM settings** → **PTY** → **Select PTY**.

**Audio system**

2. Go to **FM settings** → **PTY** → **Search PTY**.

If the radio finds any of the selected programme types then the display shows >| **To seek** . To continue searching for another broadcast of the selected programme types, press → on the navigation button.

Display of programme type

The programme type of the current station can be shown on the display.

Activate/deactivate in FM mode under **FM settings** → **PTY** → **Show PTY**

NOTE

Not all radio stations support display of programme type.

Radio text

Some RDS stations transmit information on programme content, artists, etc. This information can be shown on the display.

Activate/deactivate in FM mode under **Radio text**.

Automatic frequency update – AF

This function selects one of the strongest transmitters for a set station. The function

may need to search through the entire FM wavelength to find a strong transmitter. If this occurs, the radio mutes and **PI Seek Press Exit to cancel** appears on the display.

Activate/deactivate in FM mode under **FM settings** → **Advanced radio settings** → **AF**.

Regional radio programmes – REG

This function causes the radio to continue with a regional transmitter even if its signal strength is low. The symbol **REG** shows that the function is active.

Activate/deactivate in FM mode under **FM settings** → **Advanced radio settings** → **Regional**.

Enhanced Other Networks – EON

This function is useful in urban areas with many regional radio stations. It allows the distance between the car and the radio station transmitter to determine when programme functions should interrupt the current audio source.

Activate/deactivate in FM mode by selecting one of the options under **FM settings** → **Advanced radio settings** → **EON**:

- **Local** – interrupts only if the radio station transmitter is close.

- **Distant**¹ – interrupts if the station transmitter is far away, even if there is a lot of static.
- **Off** – no interruption for programmes from other transmitters.

Resetting RDS functions

All radio settings can be reset to the original factory settings. The reset is carried out in FM mode under **FM settings** → **Advanced radio settings** → **Reset all**.

Volume control, programme types

The interrupting programme types, e.g. **NEWS** or **TP**, are heard at the volume selected for each respective programme type. If the volume level is adjusted during the programme interruption, the new level is saved until the next programme interruption.

¹ Default/Factory setting.



Trip computer

General

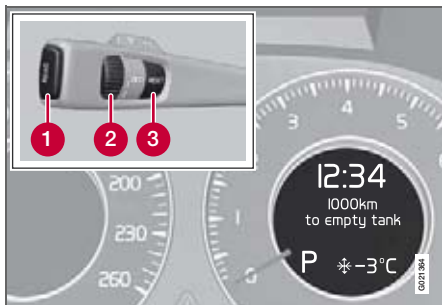

Information display and controls

- 1 **READ** – confirms
- 2 Thumbwheel – browse between menus and options in the trip computer list
- 3 **RESET** – resets

To scroll through trip computer information, turn the thumbwheel up or down in steps. Continue turning to return to the starting point.

Functions

NOTE

If a warning message appears while you are using the trip computer, this message must be acknowledged in order to revert to the trip computer function. Acknowledge by pressing **READ**.

To change unit specified for distance and speed, contact an authorised Volvo workshop.

Current speed*

Current speed is displayed in mph if the speedometer is graduated in km/h. If the speedometer is graduated in mph then the current speed is shown in km/h.

Average speed

The car calculates the average speed from the last resetting. Reset using **RESET**.

Instantaneous

Current fuel consumption is calculated every second. The information on the display is updated every couple of seconds. When the car is stationary, "----" appears on the display.

Average

The average fuel consumption since the last reset. Reset using **RESET**.

NOTE

There may be a slight error in the reading if a fuel-driven additional¹ and/or parking heater* has been used.

¹Only diesel-engined cars.

Km to empty tank

The calculation is based on the average fuel consumption over the last 30 km and the remaining driveable fuel quantity. The display shows the approximate distance that can be driven with the fuel quantity remaining in the tank. When fuel for less than 20 km remains then the display shows "----" km to empty tank.

NOTE

There may be a slight error in the reading if a fuel-driven parking heater* has been used or if driving style has been changed.

Resetting

1. Select **average speed** or **average**.



Trip computer

2. Press and hold **RESET** for approx.
1 second to reset the selected function.
If **RESET** is kept depressed for at
3 three seconds then average speed
and average are reset simultaneously.



Compass*

Operation



Rearview mirror with compass.

The upper right-hand corner of the rearview mirror has an integrated display that shows the compass direction in which the front of the car is pointing. Eight different directions are shown with English abbreviations: **N** (north), **NE** (north east), **E** (east), **SE** (south east), **S** (south), **SW** (south west), **W** (west) and **NW** (north west).

The compass is activated automatically when the car is started or in ignition position II. To deactivate/activate the compass, use a paper clip for example and press in the button on the rear side of the mirror.

Adjusting



Calibrating the compass.

The compass may need calibrating to work correctly. **CAL** is shown in the mirror's display if the compass needs calibrating.

1. Stop the car in a large open area.
2. Start the car.
3. Press and hold the button on the rear of the rearview mirror (use a paper clip or similar) until **CAL** is shown again (approx. 6 seconds).
4. Drive off as usual. **CAL** disappears from the display when calibration is complete.

Alternative calibration method:

Drive slowly in a circle at a speed of no more than eight km/h until **CAL** disappears from the display when calibration is complete.

Selecting the zone

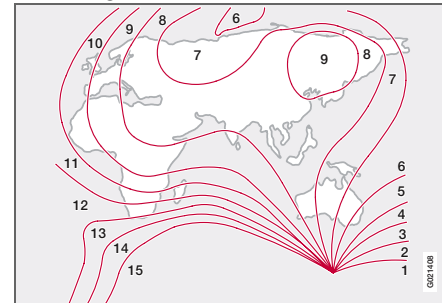

Magnetic zones.

The earth is divided into 15 magnetic zones. The correct zone must be selected for the compass to work correctly.

1. Ignition position II.
2. Press and hold the button on the rear of the rearview mirror (use a paper clip or similar) for at least 3 seconds. The number for the current area is shown.
3. Press the button repeatedly until the number for the required geographic area (1–15) is shown.
4. The display will revert to showing the compass direction after a few seconds.



DSTC – Stability and traction control system

General information on DSTC

The stability and traction control system, DSTC (Dynamic Stability and Traction Control) helps the driver to avoid skidding and improves the car's traction.

The system limits the driving and brake force of the wheels individually so that skidding can be avoided. This increases manoeuvrability and as a result safety in the event of sudden movement.

Traction is improved by means of the system distributing the driving force between the wheels. The system primarily engages at low speed on poor road surfaces.

The activation of the system during braking may be noticed as a throbbing sound. The car may accelerate slower than expected when the accelerator pedal is depressed.

Messages in the information display

DSTC Temporarily OFF



System temporarily reduced due to excessive brake disc temperature. The function is reactivated automatically when the brakes have cooled.

DSTC Service required

System disabled due to a fault.

Stop the car in a safe place and turn off the engine. If the message remains when the engine is restarted, drive to an authorised Volvo workshop.

Symbols in the combined instrument panel

If the symbols  and  are displayed at the same time, read the message on the information display.

If the symbol  appears alone then it may appear as follows:

- Flashing light means that the system is now being activated.
- Constant glow for 2 seconds means system check when the engine is started.
- Constant glow after starting the engine or while driving means system fault.

Reduced operation

System operation during skidding and acceleration can be reduced. Operation during skidding is delayed and so allows more skidding which provides greater freedom for dynamic driving. Traction in deep snow or sand is improved as traction is no longer limited.

Operation

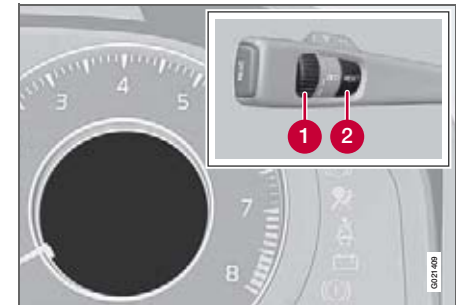

1. Turn the thumbwheel **1** until the DSTC menu is shown.

DSTC ON means that the system function is unchanged.

DSTC spin control OFF means that system operation is reduced.

2. Press and hold **RESET 2** until the DSTC menu is changed.

The system remains reduced until the engine is next started.

WARNING

The car's driving characteristics may deteriorate if the function is reduced.



Adapting driving characteristics

Active chassis (Four C)*

Active chassis, Four-C (Continuously Controlled Chassis Concept), regulates the characteristics of the shock absorbers so that the car's driving characteristics can be adjusted. There are three settings: Comfort, Sport and Advanced.

Comfort

This setting means that the car is perceived as being more comfortable and is recommended for longer journeys. Shock absorption is soft and the movement of the body is smooth and gentle.

Sport

This setting means that the car is perceived as being more sporty and is recommended for more active driving. Steering response is faster than in the Comfort mode. Shock absorption is harder and the body follows the road in order to reduce rolling during fast cornering.

Advanced

This setting is only recommended on very even and smooth road surfaces.

The shock absorbers are optimised for maximum roadholding and rolling in bends is further minimised.

Operation

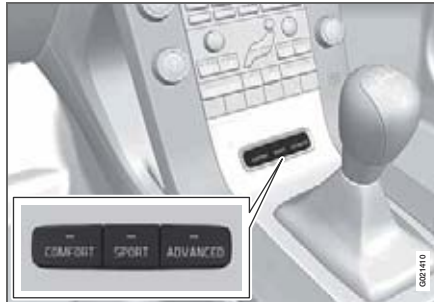

Chassis settings

Use the buttons in the centre console to change setting. The setting in use when the engine is switched off is activated next time the engine is started.

Speed related steering force*

Steering force increases with the speed of the car to give the driver enhanced sensitivity. At low speed the car is easy to steer in order to facilitate parking for example.

Steering force can be changed under **Car settings** → **Steering force level** For a description of the menu system, see page 104. This menu cannot be accessed while the car is in motion.



Cruise control*

Operation

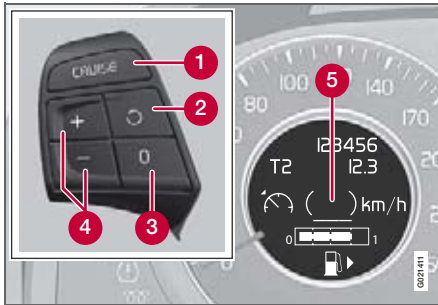



Display and controls

- 1 Standby mode
- 2 Resume set speed
- 3 Deactivating
- 4 Activate/set speed
- 5 Set speed (in brackets = standby mode)

Activating and setting the speed

In order to enable the activation of cruise control, it must first be engaged in standby mode with the **CRUISE** button 1. The symbol  illuminates in the display and the text (---) km/h 5 shows that cruise control is in standby mode.



Cruise control is then activated with  or , after which the current speed is stored

and is used as the set speed. The display text (---) km/h changes to show the set speed, e.g. 100 km/h.,

 **NOTE**

Cruise control cannot be engaged at speeds below 30 km/h.

Adjusting the set speed

In active mode the speed is adjusted with long or short presses on  or .

A temporary increase in speed using the accelerator, such as while overtaking, does not affect the cruise control setting. When the accelerator is released the car will return to the set speed.

 **NOTE**

If one of the cruise control buttons is kept depressed for more than approx. one minute then cruise control is disengaged. The engine must then be switched off in order to then reset cruise control.

Deactivation

Cruise control is disengaged with **CRUISE** or by switching off the engine. The set speed is cleared.

Temporary deactivation

Press  to disengage cruise control temporarily. The saved speed is shown in brackets in the display, e.g. (100) km/h.

Automatic temporary deactivation

Cruise control is deactivated spontaneously when the driving wheels spin or if the car's speed falls below approx. 30 km/h. Cruise control is also deactivated when the brakes are used, when the gear selector is moved to neutral position or if the accelerator pedal is depressed for a longer time (approx. 60 seconds). Cruise control then changes over to standby mode and the set speed is saved.

Resume set speed

If cruise control has been deactivated temporarily, it can be reactivated by pressing . The speed is then set to the previously set speed.

 **NOTE**

A significant increase in speed may arise after the speed has been resumed with .



Adaptive cruise control*

General

Adaptive Cruise Control – (ACC) is designed to assist the driver with support on long straight roads in steady traffic, for example on motorways and main roads.

Maintenance of cruise control components must only be performed by an authorised Volvo workshop.

WARNING

Adaptive cruise control cannot cover all driving situations and traffic, weather and road conditions.

The Function section on page 136 and after informs about limitations that the driver must be aware of before using the adaptive cruise control.

When driving you are responsible for maintaining the correct distance and speed, even when adaptive cruise control is used. You must always pay attention to the traffic conditions and intervene when adaptive cruise control is not maintaining a suitable speed or suitable distance.

Function

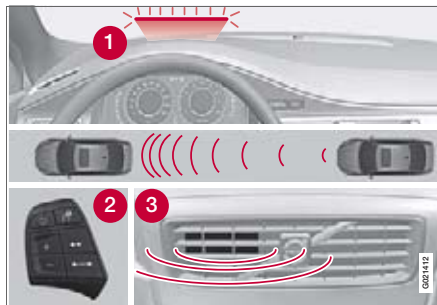

Functions overview

- ❶ Warning lamp, braking by driver required
- ❷ Controls
- ❸ Radar sensor

Adaptive cruise control consists of the cruise control system and coordinated spacing system.

WARNING

Adaptive cruise control is not a collision avoidance system. The driver must intervene if the system does not detect a vehicle in front.

Adaptive cruise control does not brake for slow or stationary vehicles.

Do not use the adaptive cruise control, for example, in city traffic, in dense traffic, at junctions, on slippery surfaces, with a lot of water or slush on the road, in heavy rain/snow, in poor visibility, on winding roads or on slip roads.

The distance to the vehicle ahead is measured by a radar sensor. The speed is regulated by acceleration and braking. It is normal for the brakes to emit a low sound when they are being used by cruise control.

WARNING

The brake pedal moves when the cruise control brakes. Do not rest your foot under the brake pedal as it could become trapped.

The cruise control objective is to follow the vehicle ahead but in the same lane and at a set distance. If the radar sensor has not detected a vehicle ahead then the only objec-



Adaptive cruise control*

tive is the set speed. This is also the case if the speed of the vehicle ahead exceeds the cruise control set speed.

The adaptive cruise control aims to control the speed in a smooth way. In situations that demand sudden braking you must brake yourself. This applies with large differences in speed, or if the vehicle in front brakes heavily. Due to limitations in the radar sensor, braking may come unexpectedly or not at all, see page 140.

Adaptive cruise control can only be activated above 30 km/h. If speed falls below 30 km/h or if engine speed becomes too slow then the adaptive cruise control disengages and stops braking. In which case the driver must immediately take over and maintain the distance to vehicles in front. The highest speed setting is 200 km/h. In some situations when the system cannot be activated **Cruise Unavailable** is shown in the display, see page 139.

Warning lamp, braking by driver required

Adaptive cruise control has a braking capacity that is equivalent to approximately 30% of the car's braking capacity. If the car needs to brake more heavily than cruise control capacity and the driver does not brake then a signal sounds and the red warning lamp illu-

minates the windscreen. The red warning lamp may be difficult to notice in strong sunlight or when sunglasses are being worn.

WARNING

Cruise control only warns of vehicles detected by the radar sensor. Consequently there may be no warning or it may be subject to a delay. Do not wait for a warning but brake when it is necessary.

Automatic deactivation

Adaptive cruise control is dependent on other systems e.g. stability and traction control system (DSTC). If any of these systems stop working then cruise control is automatically deactivated.

In the event of automatic deactivation a signal will sound and the message **Cruise Cancelled** is shown in the display. You must then intervene and adapt your driving and speed to vehicles in front.

An automatic deactivation can be due to:

- speed falls below 30 km/h
- wheels lose traction
- brake temperature is high
- engine speed is too low
- the radar sensor is blocked e.g. by wet snow or rain

Operation

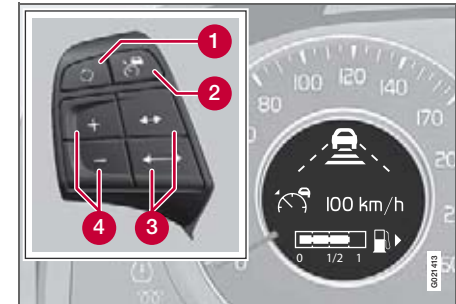

Display and controls

- 1 Activate and resume settings, increase speed
- 2 Standby mode, on/off
- 3 Set distance
- 4 Activating and setting the speed

Driver operation

Cruise control is deactivated when the brakes are used, the gear selector is moved to neutral position, or if the accelerator pedal is depressed for a longer period. Cruise control then changes over to standby mode and the driver has full control of the car. If the accelerator pedal is kept depressed for a shorter period, for example during overtaking, cruise control is temporarily disengaged and









04 Comfort and driving pleasure

Adaptive cruise control*

then re-engaged when the accelerator pedal is released.

Activating and setting the speed

To enable cruise control activation it must first be engaged in standby mode with . The set time interval is briefly shown in the display. Cruise control is activated with  or , after which the current speed is stored and used as the set speed. The set speed is shown in the display. In active mode the speed is adjusted with long or short presses on ,  or . The button  has the same function as +, but results in a lower increase in speed.



NOTE

If cruise control does not seem to react to activation the reason may be that the time interval to the closest vehicle prevents an increase in speed.

NOTE

In some situations cruise control cannot be activated. In which case **Cruise Unavailable** is shown in the display, see page 139.

Set time interval



The set time interval to vehicles in front is increased with  and decreased with .

The current time interval is shown briefly in the display following adjustment. Five different time intervals can be chosen from. A longer time interval means smoother speed control. The recommended time interval is three to five. Time intervals one and two are primarily intended for driving in queues in heavy traffic, in which case you must intervene more often.

NOTE

Only use the time interval that is allowed in accordance with local traffic regulations.

Deactivating and resuming settings

Cruise control is deactivated, either with a short press on , or by means of driver intervention, e.g. braking. The set speed is then shown in brackets. Speed and time interval are resumed with one press on .

NOTE

A significant increase in speed may arise after the speed has been resumed with .

A short press on  in standby mode or a long press in active mode deactivates cruise control. The set speed is cleared and cannot be resumed.

The radar sensor and its limitations

The radar sensor is used both by the adaptive cruise control and the collision warning system. It is designed to detect cars or larger vehicles driving in the same direction. The radar sensor does not detect pedestrians, or oncoming, slow or stationary vehicles, objects and obstacles. Warnings are not given and braking is not applied in such cases.

Modification of the radar sensor could result in it being illegal to use.

WARNING

Accessories or other objects must not be installed in front of the grille.

The capacity of the radar sensor to detect vehicles in front is reduced significantly:

- if the radar sensor becomes blocked and cannot detect other vehicles e.g. in heavy rain or slush, or if other objects have collected in front of the radar sensor.

NOTE

Keep the surface in front of the radar sensor clean.

- if the speed of vehicles in front is significantly different from your own speed.



Adaptive cruise control*

The radar sensor has a limited field of vision. In some situations it may detect a vehicle other than the one expected or not detect any vehicle at all.

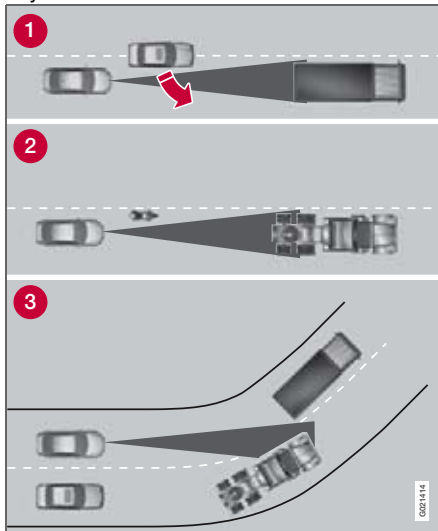



Radar sensor field of vision (grey)

- 1 Sometimes the radar sensor cannot detect vehicles at close quarters, for example a vehicle that drives in between your car and vehicles in front.

- 2 Small vehicles, such as motorcycles, or vehicles not driving in the centre of the lane can remain undetected.
- 3 In bends the radar sensor may detect the wrong vehicle or lose a detected vehicle from view.

Symbols on the display

Symbol	Specification
	Standby mode or active mode without detected vehicle.
	Active mode with detected vehicle to which cruise control adapts the speed.
	Distance information.

Messages on the display

Message	Specification
Radar blocked See manual	Cruise control temporarily disengaged. This message is shown if the radar sensor is blocked and cannot detect other vehicles e.g. in heavy rain or if slush has collected in front of the radar sensor.

Message	Specification
Cruise Cancelled	The cruise control has been shut down. The driver must regulate the speed.
Cruise Service required	Cruise control not working. Contact an authorised Volvo workshop.
Cruise Unavailable	Cruise control cannot be activated. This could be due to: <ul style="list-style-type: none"> • traction control and stability function (DSTC) has been reduced, see page 133 • brake temperature is high • the radar sensor is blocked e.g. by wet snow or rain.



Collision warning system with brake support*

General

The collision warning system (Collision Warning with Brake Support) is an aid designed to warn the driver who is at risk from driving into a vehicle in front that is driving in the same direction.

The brake support reduces the collision speed.

Maintenance of collision warning system components must only be performed by an authorised Volvo workshop.



WARNING

The collision warning system does not work in all driving situations and traffic, weather and road conditions. The collision warning system does not react to slow vehicles, stationary vehicles or vehicles travelling in another direction to the host vehicle.

Warnings are given at the earliest in the event of high collision risk. The *Function* section and after informs about limitations that the driver must be aware of before use.

The collision warning system has brake support that only reduces collision speed if the driver brakes.

Never wait for a collision warning. When driving you are responsible for maintaining the correct distance and speed, even when the collision warning system is used.

Function

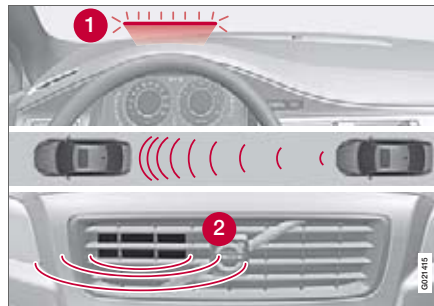

Functions overview

- ❶ Visual warning signal, collision risk
- ❷ Sensor

The radar sensor detects vehicles in front that are driving in the same direction as you. In the event of there being a risk of collision with such a vehicle your attention is drawn with a red warning lamp and a warning sound.

If the risk of collision still increases after the warning then the brake support is activated. The brake support prepares the brake system for rapid braking and the brakes are applied gently, which may be noticed as a slight jerk. If the brake pedal is depressed sufficiently quickly then braking is implemented with full brake function, even if the force on

the pedal is light. The collision warning system is active between 7 km/h and 180 km/h.



Collision warning system with brake support*

Operation

Some settings are controlled from the centre console via a menu system. For information on how the menu system is used, see page 104.

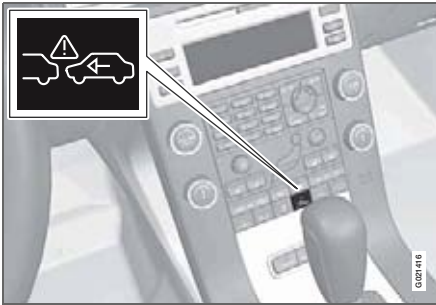

Button for activating/deactivating the warning signals.

i NOTE

The brake support is not affected by the settings described here.

Activating/deactivating warning signals

The collision warning system's audio and visual signals can be activated/deactivated using . The light in the button indicates that the warning signals are activated.

The warning sound and warning lamp are activated automatically when the car is started. The automatic activation can be deselected under **Car settings** → **Collision warn. settings** → **On at start up**.

The warning sound can be activated/deactivated separately under **Car settings** → **Collision warn. settings** → **Warning sound**.

i NOTE

When adaptive cruise control is used the warning lamp and warning sound are used by the cruise control even if it has been deactivated by the driver.

Set warning distance

The sensitivity states how early the visual and any audible warning is triggered. Select one of the options under **Car settings** → **Collision warn. settings** → **Warning distance**.

i NOTE

In some situations warnings may seem to be late, even though the warning distance has been set to **Long**.

Checking settings

The current settings are most easily checked by pressing twice on in quick succession. The settings are shown in the display.

Messages on the display

Radar blocked See manual – The collision warning system is temporarily disengaged. The message is shown e.g. in heavy rain or if slush has collected in front of the radar sensor. See the section on radar sensor limitations, page 140

Collision warn. Service required – The collision warning system is disengaged. Contact an authorised Volvo workshop if the message remains.



Collision warning system with brake support*

Limitations

The visual warning signal may be difficult to notice in strong sunlight or when sunglasses are being worn. For this reason always activate the warning sound during such conditions.

NOTE

The visual warning signal can be temporarily disengaged in the event of high passenger compartment temperature caused by strong sunlight for example. If this occurs then the warning sound is activated even if it is deactivated in the menu system.

Warnings may not appear if the distance to the vehicle in front is very small or if steering wheel and pedal movements are large, e.g. a very active driving style.

Warnings may be triggered late, be absent or triggered unnecessarily if the traffic situation means that the radar sensor cannot accurately detect a vehicle in front. The collision warning system uses the same radar sensors as adaptive cruise control. For more information on the radar sensor and its limitations, see page 140.

An absent or late warning means that there is no brake support or it comes late.

The incorrect warnings may be in the form of both audio and visual signals. One way of reducing the number of incorrect warnings is to reduce the warning distance.



Parking assistance*

General¹

Parking assistance is used as an aid to parking. A signal indicates the distance to the detected obstacle.

Parking assistance is available in two variants:

- Rear only
- Both front and rear.

WARNING

Parking assistance does not relinquish the driver's own responsibility during parking. The sensors have blind spots where obstacles cannot be detected. Be aware of children and animals near the car.

Function



The system is automatically activated when the car is started and the lamp in the switch for Off/On is illuminated. If parking assistance is deactivated with the button, then the lamp goes out.

The shorter the distance to the obstacle in front or behind, the faster the acoustic signal. If the volume of another audio source from the audio system is high, then this is automatically lowered.

The tone becomes constant at a distance of about 30 cm. If there are objects within this distance both behind and in front of the car, then the signal alternates between the front and rear loudspeakers.

Rear parking assistance

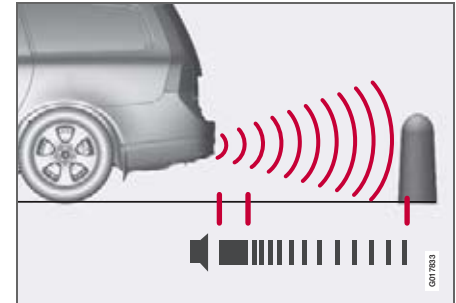

The distance covered to the rear of the car is about 1.5 metres. The audio signal for obstacles behind comes from the rear loudspeakers.

Rear parking assistance is activated when reverse gear is engaged.

The system must be deactivated when reversing with a trailer, or bike carrier on the towbar or similar. Otherwise they would trigger the sensors.

NOTE

Rear parking assistance is deactivated automatically when towing a trailer if Volvo genuine trailer wiring is used.

¹ Depending on the market, the Parking assistance system may be either standard, option or accessory.



Parking assistance*

Front parking assistance

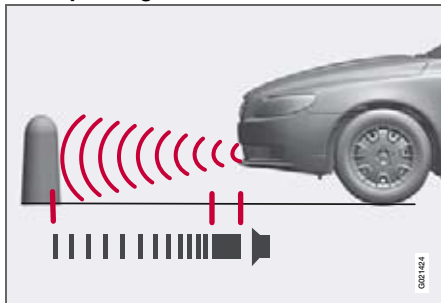

The distance covered to the front of the car is about 0.8 metres. The audio signal for obstacles in front comes from the front loud-speaker.

The front parking assistance is active at speeds of below 15 km/h, even during reversing. The system is deactivated at a higher speed. However, the lamp in the button remains illuminated in order to indicate that the system is activated for the next time the driver shall park. When the speed is below 10 km/h the system is reactivated.

i NOTE

Front parking assistance is deactivated when the parking brake is applied.

i NOTE

When fitting auxiliary lamps: Remember that they must not obscure the sensors – the auxiliary lamps could then be detected as obstacles.

Fault indicator

i If the information symbol illuminates with constant glow and the information display shows **Park assist syst Service required** then parking assistance is disengaged.

i IMPORTANT

In certain conditions the parking assistance system may produce incorrect warning signals that are caused by external audio sources that emit the same ultrasonic frequencies that the system works with.

Examples of such sources include horns, wet tyres on asphalt, pneumatic brakes and exhaust noises from motorcycles etc.

**Parking assistance*****Cleaning the sensors***Sensor location, front*

The sensors must be cleaned regularly to ensure that they work properly. Clean them with water and car shampoo.

 NOTE

Dirt, ice and snow covering the sensors may cause incorrect warning signals.

*Sensor location, rear*



BLIS* – Blind Spot Information System

General information on BLIS

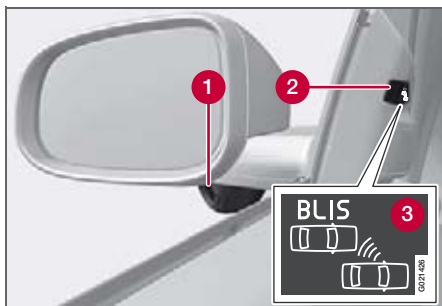

- ① BLIS camera
- ② Indicator lamp
- ③ BLIS symbol

BLIS is an information system based on digital camera technology that under certain conditions can help the driver to notice vehicles moving in the same direction as the host vehicle in the so-called "blind spot".

! IMPORTANT

Repair of the BLIS system components must only be performed by an authorised Volvo workshop.

⚠ WARNING

The system is a supplement to, not a replacement for, a safe driving style and use of the rearview mirrors. It can never replace the driver's attention and responsibility. The responsibility for changing lanes safely always rests with the driver.

The system is designed to work most effectively when driving in dense traffic on multi-lane highways.

When a camera ① has detected a vehicle inside the blind spot zone the indicator lamp ② illuminates with a constant glow.

i NOTE

The lamp illuminates on the side of the car where the system has detected the vehicle. If the car is overtaken on both sides at the same time then both lamps illuminate.

BLIS advises the driver with a message if a fault arises in the system. If for example the system's cameras are obscured then the BLIS indicator lamp flashes and a message is shown on the information display. In such cases, check and clean the lenses. If necessary, the system can be switched off temporarily by pressing the BLIS button, see page 147.

Blind spots

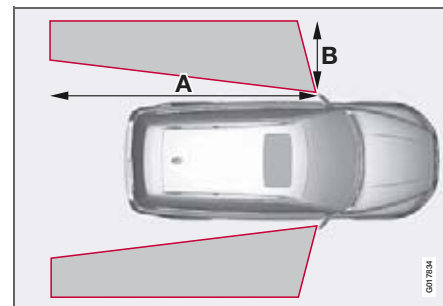

A = approx. 9.5 m and B = approx. 3 m



BLIS* – Blind Spot Information System

Activating/deactivating



Button for activating/deactivating

BLIS is activated when the engine is started. The indicator lamps in the door panels flash three times when BLIS is activated.

The system can be deactivated/activated when the engine is started by pressing **BLIS**.

When BLIS is deactivated the light in the button goes out and a text message is shown on the dashboard display.

When BLIS is activated the light in the button illuminates, a new text message is shown on the display and the indicator lamps in the door panels flash three times. Press the **READ** button to clear the text message. For more information on messages, see page 107.

When BLIS operates

The system operates when the car is driven at a speed above 10 km/h.

Overtaking

The system is designed to react if:

- you overtake another vehicle at a speed of up to 10 km/h faster than the other vehicle
- you are overtaken by a vehicle travelling up to 70 km/h faster than you are travelling.

WARNING

BLIS does not work in sharp bends.
BLIS does not work when the car is reversing.
A wide trailer coupled to the car can conceal other vehicles in adjacent lanes. It can prevent the vehicle in the screened area from being detected by BLIS.

Daylight and darkness

In daylight the system reacts to the shape of the surrounding vehicles. The system is designed to detect motor vehicles such as cars, trucks, buses and motorcycles.

In darkness the system reacts to the headlamps of surrounding vehicles. If the headlamps of surrounding vehicles are not switched on then the system does not detect

the vehicles. This means for example that the system does not react to a trailer without headlamps which is towed behind a car or truck.

WARNING

The system does not react to bicycles or mopeds.
The BLIS cameras can be disrupted by intensive light or when driving in the dark when there are no light sources (e.g. street lighting or other vehicles). The system may then interpret the lack of light as if the cameras have been blocked.
In both cases a message is shown in the information display.
When driving in such conditions system performance may be temporarily deteriorate and a text message is shown, see page 148. If the message disappears automatically then BLIS has returned to normal functionality.

The BLIS cameras have limitations similar to the human eye, i.e. they "see" worse in heavy snowfall or thick fog for example.



BLIS* – Blind Spot Information System

Cleaning

In order to work most effectively the BLIS camera lenses must be clean. The lenses can be cleaned with a soft cloth or damp sponge. Clean the lenses carefully so that they are not scratched.

! IMPORTANT

The lenses are electrically heated to melt ice or snow. If necessary, brush snow away from the lenses.

Messages on the display

Message	Specification
Blind-spot info system ON	BLIS system on
Blind spot syst. Service required	BLIS not functioning. Contact an authorised Volvo workshop.
Blind spot syst. Camera blocked	The BLIS camera is blocked by dirt, snow or ice. Clean the lenses.
Blind spot syst. Reduced function	The BLIS camera is disrupted by fog or strong sunlight shining directly into the camera. The camera resets itself when the environment has returned to normal.
Blind-spot info system OFF	BLIS system off

Limitations

In some situations the BLIS indicator lamp may illuminate despite there being no other vehicle within the blind spot.

i NOTE

If the BLIS indicator lamp illuminates on isolated occasions despite there being no other vehicle within the blind spot then this does not mean that a fault has arisen in the system.

In the event of a fault in the BLIS system the display shows the text **BLIS Serv. required.**

Here are several examples of situations where the BLIS indicator lamp may illuminate even if there is no other vehicle within the blind spot.

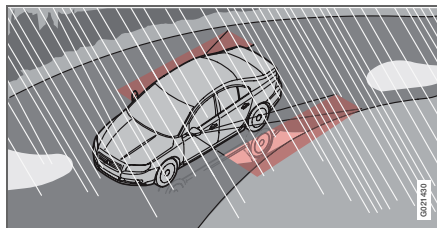

Reflection from shiny wet road surface.

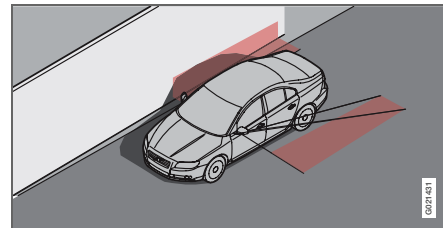

Own shadow on large light smooth surface, e.g. noise barrier or concrete road surface.

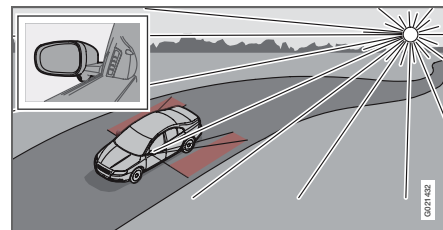

Low stationary sunlight shining into the camera.



Comfort inside the passenger compartment

Storage spaces

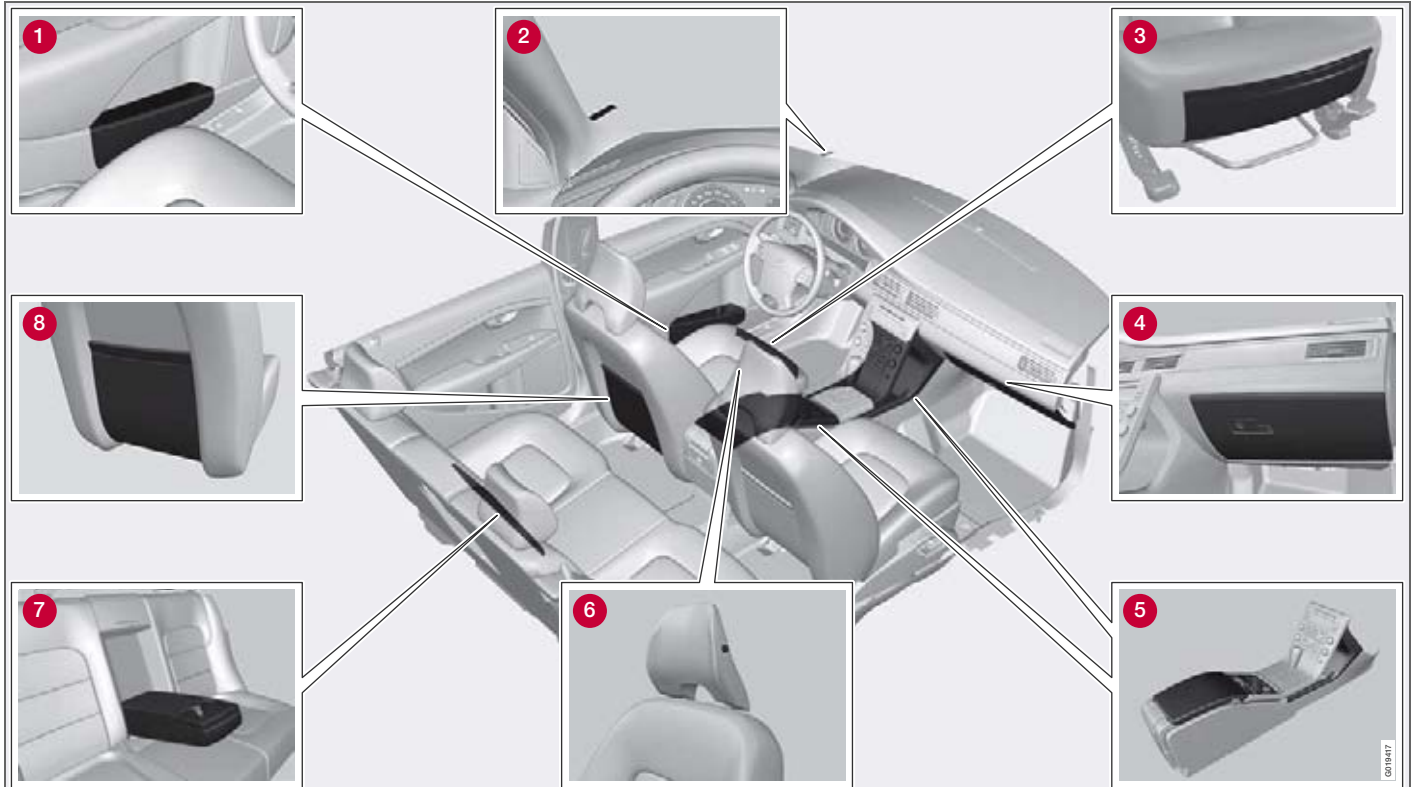



Comfort inside the passenger compartment

- 1 Storage compartment in door panel
- 2 Storage pocket on front edge of front seat cushions*
- 3 Ticket clip
- 4 Glovebox
- 5 Storage compartment, cup holder
- 6 Jacket holder
- 7 Cup holder in armrest, rear seat*
- 8 Storage pocket

Jacket holder

The jacket holder is only designed for light clothing.

Tunnel console



- 1 Storage compartment (e.g. for CD discs and AUX input under the armrest (and storage tray)*).
- 2 Includes cup holder for driver and passenger, and 12 V socket and small compartment. (If ashtray and cigarette lighter are specified then the 12 V socket is replaced by a cigarette lighter and the small compartment by a detachable ashtray.)

Cigarette lighter and ashtray*

The ashtray in the tunnel console is emptied by lifting it straight up.

Activate the lighter by pushing in the button. The button pops out when the lighter is hot. Pull out the lighter and light a cigarette on the heated coils.

Glovebox

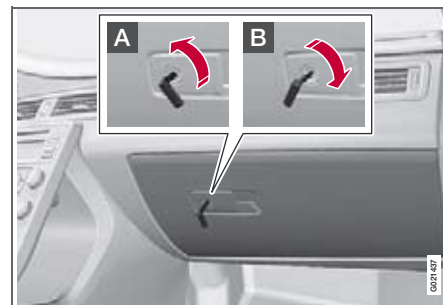

The owner's manual and maps can be kept here. There are also holders for pens and fuel cards. The glovebox can be locked manually with the key blade, see page 42.



Comfort inside the passenger compartment

Floor mats*

Volvo supplies specially manufactured floor mats.

WARNING

The floor mat at the driver's seat must be firmly fitted and secured in the attachment clips to prevent it from being trapped around and under the pedals.

Vanity mirror



Vanity mirror with lighting.

The light illuminates automatically when the cover is lifted.

12 V socket



12 V socket in tunnel console, front seat.



12 V socket in tunnel console, rear seat.

The electrical socket can be used for 12 V accessories, such as mobile phone chargers and coolers. The maximum current is 10 A.



Comfort inside the passenger compartment

For the socket to supply current, the ignition must be in at least position I, see page 65.



WARNING

Always leave the plug in the socket when the socket is not in use.

Electrical socket in cargo area*

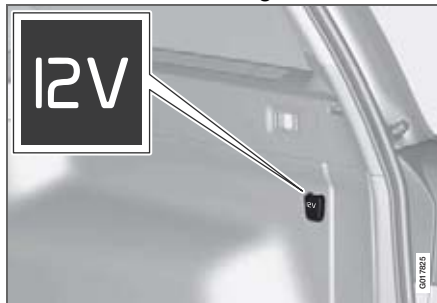

Fold down the cover to access the electrical socket. It works irrespective of whether or not the ignition is switched on. Use the electrical socket with the engine running to avoid discharging the battery.

First aid equipment*

The equipment is located in the cargo area. The bag has a Velcro strap so that it can be attached to the cargo area wall.



Built-in phone*

General

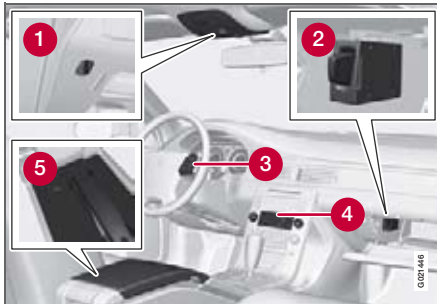

System overview

- 1 Microphone
- 2 SIM card reader
- 3 Keypad, see page 120.
- 4 Control panel
- 5 Privacy handset

Safety

Only entrust phone servicing to an authorised Volvo workshop. The built-in phone must be switched off during refuelling or in the vicinity of blasting work. IDIS limits the menu system depending on the speed of the car, see page 156.

Remember

SIM card

The phone can only be used with a valid SIM card (Subscriber Identity Module). For installation, see page 157. Emergency calls to emergency numbers can be made without a SIM card.

i NOTE

The built-in phone cannot read 3G type SIM cards. Combined 3G/GSM cards work. Contact the network operator if the SIM card needs to be changed.

Menus and controls

The menus are navigated using the control panel 4 and the steering wheel 3 keypad. For general information on menus, see page 104. For information on the phone's controls, see previous page.

On/Off

Switch on the phone with a short press on **PHONE**. Enter the PIN code if necessary. The  symbol shows that the phone is switched on. When this symbol is shown calls can be received even if the CD menu for example is shown in the display. Briefly press **PHONE** to use the phone menus and to dial

out. The text **PHONE** shows that the phone menu is active.

Switch off the phone with one long press on **PHONE**.



Built-in phone*

Making and receiving calls

Making calls

1. Switch on the phone.
2. If **PHONE** is not shown in the display, briefly press **PHONE**.
3. Dial the number or use the phone book, see page 155.
4. Press **ENTER** for handsfree calls or pick up the privacy handset. Release the handset by pulling it down.

Ending a call

End a call by pressing **EXIT** or by hanging up the privacy handset.

Incoming calls

Press **ENTER** for handsfree calls or pick up the privacy handset. If the privacy handset is off the hook when the phone rings then calls must be received using **ENTER**.

End a call by pressing **EXIT** or by hanging up the privacy handset. Refuse calls using **EXIT**.

Automatic answer

The automatic answer function means that calls are accepted automatically. Activate/deactivate under **Phone settings** → **Call options** → **Automatic answer**.

Call waiting

The function enables a new call to be answered during an ongoing call. The new call is answered as usual and the previous call is put on hold. Activate/deactivate under **Phone settings** → **Call options** → **Call waiting**.

Automatic diversions

Incoming calls can be diverted automatically depending on the type of call and situation. Activate/deactivate under **Call options** → **Diversions**.

During a call

Press **MENU** or **ENTER** during a call to access the In-call menu.

To call

1. Put the call on hold under **Hold**.
2. Dial the number of the third party or use the **Phonebook** menu option.

Switch between calls using the **Change** menu option.

Conference calls

A conference call consists of several parties. It can be initiated when a call is underway and another is on hold. The **Connect** menu option starts the conference call.

All ongoing calls are disconnected if the conference call is terminated.

Switching between the privacy handset and handsfree

Switch from handsfree to the privacy handset by picking up the privacy handset or selecting **Handset** in the menu.

Switch from the privacy handset to handsfree using the **Handsfree** menu option.



Mute mode

Mute mode involves deactivating the microphone, see page 153. Activate/deactivate the microphone using the **Microphone On/Off** menu option.

Audio settings

Call volume

The phone uses the front door speakers. Call volume can be controlled when the text **PHONE** is shown at the top of the display. Use the steering wheel keypad or **VOLUME**.

Audio system volume

Providing there is no ongoing call taking place, the audio system volume is controlled as usual with **VOLUME**. In order to control audio system volume during an ongoing call you have to switch to one of the audio sources.

The audio source can be automatically muted for incoming calls under **Phone settings** → **Sounds and volume** → **Mute radio**.

Signals and volume

Change the ring signal under **Phone settings** → **Sounds and volume** → **Ring signals**.

Activate/deactivate the message beep under **Phone settings** → **Sounds and volume** → **Message beep**.

Control the ring volume under **Phone settings** → **Sounds and volume** → **Ring volume**. Adjust using / on the navigation button.

Phone book

Contact information can be stored on the SIM card or in the phone.

Storing contacts in the phone book

1. Press **MENU** and scroll to **Phonebook** → **New contact**.
2. Enter a name and press **ENTER**. For information on text input.
3. Enter a number and press **ENTER**.
4. Scroll to **SIM card** or **Phone memory** and press **ENTER**.

Searching for contacts

The easiest way to search in the phone book is with long presses on the keys **2** to **9**. This starts a search in the phone book based on the key's first letter.

The phone book can also be reached with / on the navigation button or with / on the steering wheel keypad.

The search can also be performed from the phone book's Search menu under **Phone book** → **Search**:

1. Enter the first few letters of the contact and press **ENTER**, or simply press **ENTER**.
2. Scroll to a contact and press **ENTER** to call.



Built-in phone*

Erasing contacts

Erase a contact in the phone book by selecting it and pressing **ENTER**. Then scroll to **Erase** and press **ENTER**.

Erase all contacts under **Phonebook** → **Erase SIM** or **Erase phone**.

Copying entries between the SIM card and the phone book

Scroll to **Phonebook** → **Copy all** → **SIM to phone** or **Phone to SIM** and press **ENTER**.

Voice mail number

Voice mail number can be changed under **Phone settings** → **Call options** → **Voice mail number**. If there is no number stored then this menu can be reached with one long press on **1**. Press **1** for a long time to use the stored number.

Other functions and settings

IDIS

IDIS (Intelligent Driver Information System) can, in active driving situations, delay or refuse ring signals from incoming calls. This way less attention is distracted from driving. IDIS is deactivated under **Phone settings** → **IDIS**.

Reading messages

1. Scroll to **Messages** → **Read** and press **ENTER**.
2. Scroll to a message and press **ENTER**.
3. The message text is shown in the display. Further options are obtained by pressing **ENTER**.

Writing and sending messages

1. Scroll to **Messages** → **Write new** and press **ENTER**.
2. Enter text and press **ENTER**. For information on text input.
3. Scroll to **Send** and press **ENTER**.
4. Enter a phone number and press **ENTER**.

Message settings

Message settings are not normally changed. The network provider has further information

on these settings. There are three options under **Messages** → **Message settings**:

- **SMSC number** which specifies the message centre which will transfer the messages.
- **Validity time** which specifies how long the message will be stored in the message centre.
- **Message type**.

Call lists

Lists of received, dialled and missed calls are stored in **Call list**. Dialled calls are also shown by pressing **ENTER**. The phone numbers in the lists can be saved in the phone book.

Call duration

Call duration is stored under **Call list** → **Call duration**. Reset the values under **Call list** → **Call duration** → **Reset timers**.

Show/hide number for third party

The phone number can be temporarily hidden under **Call options** → **Send my number**.

IMEI number

In order to block a phone the network provider must be advised of the phone's IMEI number. Dial ***#06#** to show the number in



Built-in phone*

the display. Write it down and keep it in a safe place.

Network selection

The network can be selected either automatically or manually under **Phone settings** → **Network selection**.

SIM code and security

The PIN code can protect the SIM card from unauthorised use. The code can be changed under **Phone settings** → **Edit PIN code**.

Change the security level under **Phone settings** → **SIM security**. Select maximum security with the **On** option. The code will then need to be entered each time the phone is switched on. Select the next highest security level with the **Automatic** option. The phone then stores the code and automatically specifies it when the phone is switched on. When the SIM card is used with another phone the code must be entered manually. Select minimum security with the **Off** option. The SIM card can then be used without the code at all.

Reset to factory settings

The phone settings are fully reset under **Phone settings** → **Reset Phone settings**.

Installing the SIM card

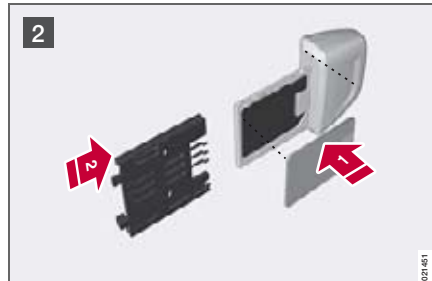
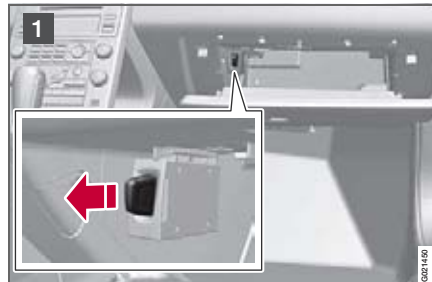

- 1 Make sure that the phone is deactivated. Pull out the SIM card holder which is located in the glovebox.
- 2 Place the SIM card with the metal surface visible **1** and fit the cover on the SIM card holder **2**. Refit the SIM card holder.



Recommendations during driving	160
Refuelling	163
Fuel.....	164
Loading	166
Cargo area.....	170
Warning triangle	173
Driving with a trailer	174
Towing	180

DURING YOUR JOURNEY



05



Recommendations during driving

General

Economical driving

Economical driving and reducing environmental impact result from driving gently with anticipation and adapting your driving style and speed to the current situation (for further advice on how you can reduce environmental impact, see page 9).

- Do not let the engine idle, but drive at light loads as soon as it is possible.
- A cold engine consumes more fuel than a warm one.
- Do not drive with unnecessary loads in the car.
- Do not use winter tyres when the roads are dry.
- Remove the load carrier when it is not in use.
- Use the parking heater* in cold weather so that the engine reaches its normal operating temperature more quickly.

Slippery driving conditions

Practise driving on slippery surfaces under controlled conditions to learn how the car reacts.

Driving in water

The car can be driven through water at a maximum depth of 25 cm at a maximum speed of 10 km/h. Extra caution should be exercised when passing through flowing water.

During driving in water, maintain a low speed and do not stop the car. When the water has been passed, depress the brake pedal lightly and check that full brake function is achieved. Water and mud for example can make the brake linings wet resulting in delayed brake function.

Clean the electric contacts of the electric engine block heater and trailer coupling after driving in water and mud.

Do not let the car stand with water over the sills for any long period of time. This could cause electrical malfunctions.

! IMPORTANT

Engine damage can occur if water enters the air filter.

In greater depths, water can enter the transmission. This reduces the lubricating ability of the oils and shortens the service life of the systems.

In the event of engine stop in water do not try restart. Tow the car from the water.

Engine and cooling system

Under special conditions, for example when driving in hilly terrain, extreme heat or with heavy loads, there is a risk that the engine and cooling system will overheat. Proceed as follows to avoid overheating the engine.

- Maintain a low speed when driving with a trailer up long, steep ascents.
- Do not turn the engine off immediately you stop after a hard drive.



NOTE

It is normal for the engine's cooling fan to operate for a while after the engine has been switched off.

- Remove any auxiliary lamps from in front of the grille when driving in extreme high temperatures.
- Do not exceed engine speeds of 4500 rpm (3500 rpm for diesel engines) if driving with a trailer or caravan in hilly terrain. The oil temperature could become too high.



Recommendations during driving

Open tailgate

Avoid driving with the tailgate open. If it is however necessary, only drive for a short distance. Close all windows, set the air distribution to the windscreen and floor and run the fan at the highest speed.



WARNING

Do not drive with the tailgate open. Toxic exhaust fumes can be drawn into the car through the cargo area.

Do not overload the battery

The electrical functions in the car load the battery to varying degrees. Avoid using the ignition position **II** when the engine is switched off. Use ignition position **I** instead, as less power is consumed.

Also, be aware of different accessories that load the electrical system. Do not use functions which use a lot of power when the engine is switched off. Examples of functions that use a lot of power:

- ventilation fan
- windscreen wipers
- audio system (high volume)
- parking lamps

If the battery voltage is low, a message appears on the information display. The energy-saving function shuts down certain functions or reduces certain functions such as the ventilation fan and audio system. Charge the battery by starting the engine.

Before a long journey

- Check that the engine is working normally and that fuel consumption is normal.
- Make sure that there are no leaks (fuel, oil or other fluid).
- Check all bulbs and tyre tread depths.
- Carrying a warning triangle is a legal requirement in certain countries.



Recommendations during driving

Winter driving

Check the following in particular before the cold season:

- The engine coolant must contain at least 50% glycol. This mixture protects the engine down to approximately -35°C . To achieve optimum antifreeze protection, different types of glycol must not be mixed.
- The fuel tank must be kept filled to prevent condensation.
- Engine oil viscosity is important. Oils with lower viscosity (thinner oils) facilitate starting in cold weather and also reduce fuel consumption while the engine is cold. For more information on suitable oils, see page 227.

IMPORTANT

Low viscosity oil must not be used for hard driving or in hot weather.

- The condition of the battery and charge level must be inspected. Cold weather places great demands on the battery and its capacity is reduced by the cold.
- Use washer fluid to avoid ice forming in the washer fluid reservoir.

To achieve optimum roadholding Volvo recommends using winter tyres on all four wheels if there is a risk of snow or ice.

NOTE

The use of winter tyres is a legal requirement in certain countries. Studded tyres are not permitted in certain countries.

Slippery driving conditions

Practise driving on slippery surfaces under controlled conditions to learn how the car reacts.



Refuelling

Opening/closing the fuel filler flap



The engine must be switched off before the fuel filler flap can be opened. Open using the button on the lighting panel. The fuel filler flap is located on the right-hand rear wing, as indicated by the symbol's  arrow in the information display.

Close the fuel filler flap by pressing it in until a click confirms that it is closed.

Opening/closing the fuel cap

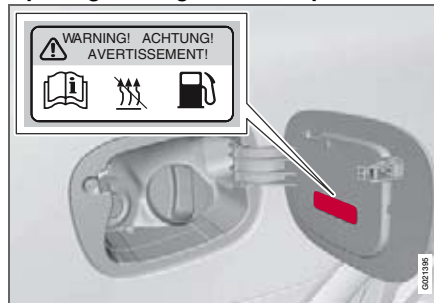

A certain overpressure may arise in the tank in the event of high outside temperatures. Open the cap slowly.

After refuelling, refit the cap and turn it until one or more "clicks" are heard.

Filling up with fuel

Do not overfill the tank but fill until the pump nozzle cuts out.

NOTE

Excess fuel in the tank can overflow in hot weather.



Fuel

General

Fuel of a lower quality than that recommended by Volvo must not be used as engine power and fuel consumption is negatively affected.

WARNING

Fuel which spills onto the ground can be ignited.

Switch off the fuel-driven heater before starting to refuel.

Never carry an activated mobile phone when refuelling. The ring signal could cause spark build-up and ignite petrol fumes, leading to fire and injury.

NOTE

Extreme weather conditions, driving with a trailer or driving at high altitudes in combination with fuel grade are factors that could affect the car's performance.

Diesel

Diesel must fulfil the EN 590 or JIS K2204 standards. Diesel engines are sensitive to contaminants, such as excessively high volumes of sulphur particles for example. Only use diesel fuel from well-known producers. Never use diesel of dubious quality.

At low temperatures ($-40\text{ }^{\circ}\text{C}$ to $-6\text{ }^{\circ}\text{C}$), a paraffin precipitate may form in the diesel fuel, which can lead to ignition problems. Special diesel fuel designed for low temperatures around freezing point is available from the major oil companies. This fuel is less viscous at low temperatures and reduces the risk of paraffin precipitate.

The risk of condensation in the fuel tank is reduced if the tank is kept well filled. When refuelling, check that the area around the fuel filler pipe is clean. Avoid spilling fuel onto the paintwork. Wash off any spillage with detergent and water.

IMPORTANT

Only ever use fuel that fulfils the European diesel standard.

IMPORTANT

Diesel type fuels which must not be used: special additives, Marine Diesel Fuel, fuel oil, RME¹ (Rape Methyl Ester) and vegetable oil. These fuels do not fulfil the requirements in accordance with Volvo recommendations and generate increased wear and engine damage that is not covered by the Volvo warranty.

¹Diesel fuel may contain a certain amount of RME, but further amounts must not be added.

IMPORTANT

For model year 2006 or later the sulphur content must be a maximum of 50 ppm.

Empty tank

No special procedures are required if the tank runs dry. The fuel system is bled automatically if the ignition switch is kept in position II for approx. 60 seconds before the start attempt.

Draining condensation from the fuel filter

The fuel filter separates condensation from the fuel. Condensation can disrupt engine operation.



The fuel filter must be drained at the intervals specified in the Service and Warranty Booklet or if you suspect that the car has been filled with contaminated fuel.

IMPORTANT

Certain special additives remove the water separation in the fuel filter.

Petrol

Petrol must meet the EN 228 standard. Most engines can be run with octane ratings of 95 and 98 RON. 91 RON should only be used in exceptional cases.

- 95 RON can be used for normal driving.
- 98 RON is recommended for optimum performance and minimum fuel consumption.

When driving in temperatures above +38 °C, fuel with the highest possible octane rating is recommended for optimum performance and fuel economy.

IMPORTANT

Always refuel with unleaded petrol so as not to damage the catalytic converter. In order that Volvo's warranty shall remain valid, never mix alcohol with petrol, as the fuel system could be damaged. Do not use additives not recommended by Volvo.

Catalytic converters

The catalytic converters are designed to purify exhaust gases. They are located close to the engine in order to quickly reach operating temperature.

The catalytic converters consist of a monolith (ceramic or metal) with channels. The chan-

nel walls are lined with a thin layer of platinum, rhodium and palladium. These metals act as catalysts, i.e. they participate in and accelerate a chemical reaction without being used up themselves.

Lambda-sond™ oxygen sensor

The Lambda-sond is part of a control system intended to reduce emissions and improve fuel economy.

An oxygen sensor monitors the oxygen content of the exhaust gases leaving the engine. This value is fed into an electronic system that continuously controls the injectors. The ratio of fuel to air directed to the engine is continuously adjusted. These adjustments create optimal conditions for efficient combustion, and together with the three-way catalytic converter reduce harmful emissions (hydrocarbons, carbon monoxide and nitrous oxides).



Loading

General

The load capacity is affected by what is mounted on the car, such as a towbar, load carriers and roof box. The load capacity of the car is also reduced by the number of passengers and their weight.

WARNING

The car's driving characteristics change depending on the weight and distribution of the load.

Loading the cargo area

Stop the engine and apply the parking brake when loading or unloading long objects. The gear lever/selector can be knocked out of position by long loads, which could set the car in motion.

- Position the load firmly against the backrest in front.
- Put wide loads in the centre.
- Heavy objects should be placed as low as possible. Avoid placing heavy loads on a lowered backrest.
- Cover sharp edges with something soft to avoid damaging the upholstery.
- Secure all loads to the load retaining eyelets with straps or web lashings.

Lowering the rear seat backrest

To simplify loading in the cargo area, the rear seats of the car can be folded down, see page 69.

WARNING

A loose object weighing 20 kg can, in a frontal collision at a speed of 50 km/h, carry the impact of an item weighing 1000 kg. Always secure the load.

WARNING

The protection provided by the inflatable curtain in the headlining may be compromised or eliminated if the load is too high. Never load cargo above the backrest. During heavy braking the load may otherwise shift, causing injury to the car's occupants.

WARNING

Always secure the load. During heavy braking the load may otherwise shift, causing injury to the car's occupants.

Protect sharp edges with something soft.

Turn off the engine and apply the parking brake when loading or unloading long objects. Otherwise you may accidentally knock the gear lever or gear selector with the load and cause a gear to engage and the car to move off.



Power operated tailgate*

WARNING

Pay attention to the risk of crushing when opening/closing. Before starting to open/close, make sure that there is nobody close to the tailgate as a crushing injury could have serious consequences. Always operate the tailgate with caution.

IMPORTANT

Pay attention to the height of the roof when using power operation. Do not use power tailgate operation with low roof heights or be ready to stop the opening, see the chapter "Stopping tailgate opening".

NOTE

When power operation is activated the rear lamp clusters are lit.

To open

Opening can be carried out in three ways:

- The  button on the lighting panel, hold it depressed for a short time.
- The remote control key, hold the button depressed for a short time.
- Tailgate handle – pull the handle and the tailgate opens.

To close

Close using the close button on the tailgate or manually.

- Press the button  – to close the tailgate automatically.

Interrupt tailgate opening



- Tailgate button : Press the button again – opening is interrupted. (Press a third time to resume closing).
- Tailgate outside handle: Press the handle's button again – opening is interrupted.

Securing loads

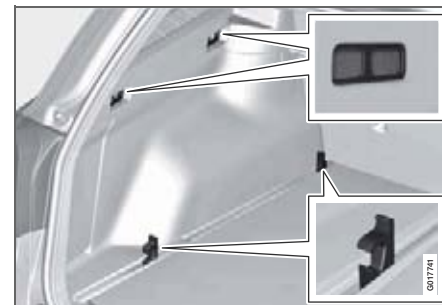

On both sides of the cargo area there are several mounting points designed for securing loads. They are located in the floor and in the top edge of both sides of the cargo area.

WARNING

Hard, sharp and/or heavy objects that are loose or protrude could cause injury during heavy braking.

Always secure large and heavy objects with a seatbelt or cargo retaining straps.

Loading

Floor rails

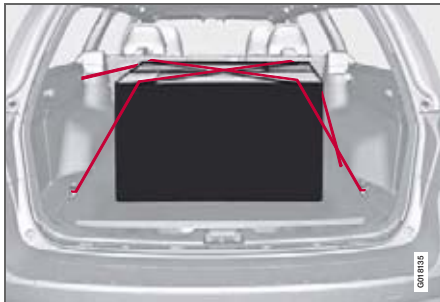

Load secured in both upper and lower mounting points

In the floor of the cargo area there are two rails with movable cargo retaining hooks for securing items in the cargo area using cargo retaining straps.

IMPORTANT

Do not use other adjustable straps as these could pull and break the mounting points.

Cargo retaining straps

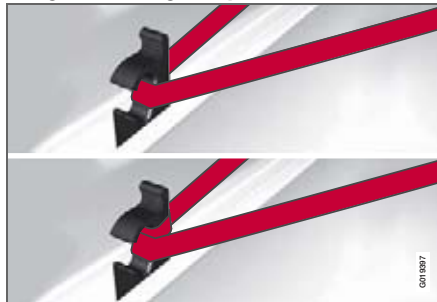

Strap retention

One loop of the cargo retaining strap around one of the cargo retaining hooks secures the strap and prevents it from sliding around the hook.

NOTE

A suitable width for a cargo retaining strap is approx. 25 mm.

Moving a cargo retaining hook

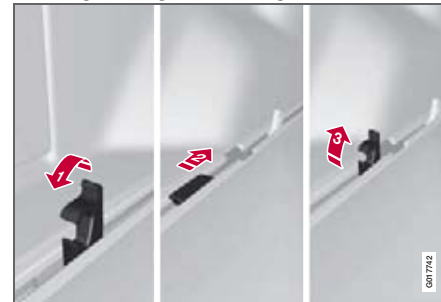

- 1 Fold the cargo retaining hook down in the direction to which its opening points.
- 2 Slide the hook to the required position.
- 3 Fold the hook up – it is self-locking.

NOTE

There must be at least 50 cm between the cargo retaining hooks in the rail.

Removing a cargo retaining hook

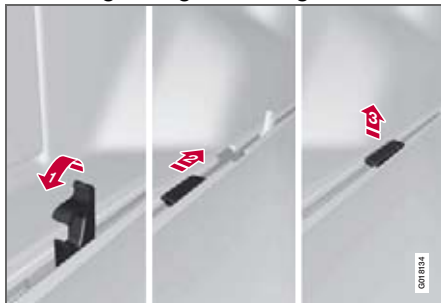

The cargo retaining hooks can be easily removed from the rail, e.g. for cleaning the bottom of the rail.

1. Fold the cargo retaining hook down in the direction to which its opening points.
2. Slide the hook to the cut-out opening.
3. Lift the hook straight up.

Cargo retaining hook correctly fitted/ incorrectly fitted

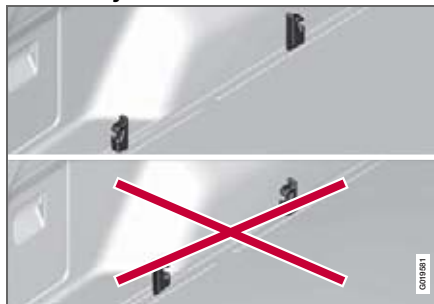

Fit the cargo retaining hooks correctly!

It is important that the cargo retaining hooks are fitted correctly. The hooks' openings must point away from each other.

WARNING

Fit the cargo retaining hooks correctly. Otherwise the cargo retaining strap will move the cargo retaining hook down so that it loosens and the strap slides off.

Bag holder*



Bag holder under folding hatch in the floor.

The bag holder keeps carrier bags in place and prevents them from overturning and spreading their contents across the cargo area.

1. Fold up the hatch in the cargo area.
2. Tension and secure the carrier bags using the strap.

Cargo area

Safety grille*

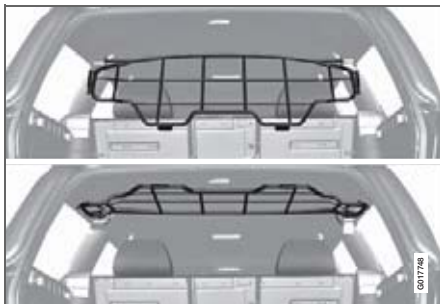

A protective grille prevents cargo from being thrown forward in the passenger compartment in the event of heavy braking. For safety reasons, the grille must always be mounted and secured correctly.

Folding up

Take hold of the bottom of the safety grille and pull back/up.

! IMPORTANT

The safety grille cannot be folded up or down when the cargo cover is fitted.



Installation



i NOTE

The safety grille is most easily fitted and removed by two people via the rear doors. When fitting, the handle, see illustration 1 – 3, must be on the front of the grille.

The backrests must be lowered to allow the safety grille to be fitted, see page 69.

- 1** Position the handle in fitting position, see illustration. Press gently on the handle to enable it to be turned into position, see arrow.
- 2** Press the strut in towards the grille and align the grille in the roof mounting.
- 3** Turn the handle 90° . Press gently as illustrated **1** if necessary. Secure the grille by angling the handle 90° .

Removal

Removal of the grille takes place in reverse order to the description in the previous section entitled Installation.



Cargo area

Cargo cover

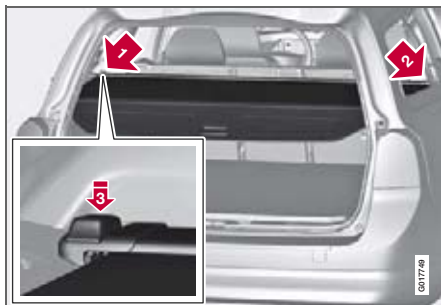

Cargo cover

Application

Pull the cargo cover over the load and hook it into the holes in the cargo area's rear pillars.

! IMPORTANT

The safety grille cannot be folded up or down when the cargo cover is fitted.

Fitting the cargo cover

1. Move one end piece of the cover into the recess on the side panel.
2. Move the other end piece of the cover into the corresponding recess.
3. Press both sides in. A "click" should be audible and the red marking should disappear.

4. Check that both end pieces are locked.

Removing the cargo cover

1. Press in one end piece button and lift it out.
2. Carefully angle the cover up/out and the other end piece loosens automatically.

Lowering the cargo cover's rear sealing disc

In its rolled-in position, the cargo cover's rear sealing disc protrudes horizontally into the cargo area when it is fitted.

1. Pull the sealing disc back gently, free from its support shelves, and lower.

Safety net*

The safety net's cassette is mounted on the rear of the backrest. The net is produced from strong nylon fabric and is in two pieces. The two pieces have different widths and the widest one is fitted to the right (seen from behind the car). It is folded up from the back of the backrest and locks itself after approx. 1 minute if the rear seat backrests are raised. The net can also be used when the rear seat is folded forward.

Using with raised backrests

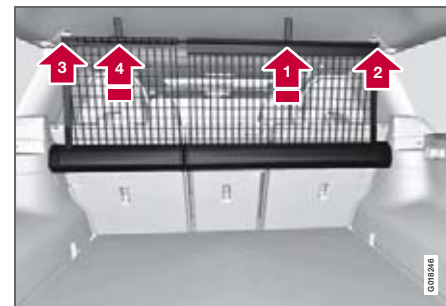

1. Pull the right-hand piece of the net up by pulling the strap.
2. Hook the rod into the mounting on the right-hand side.

Cargo area

- 3 Then pull out the rod and hook it into the left-hand side.
- 4 Pull up the left-hand cargo net in the same way as the right-hand one and secure it to the rod.

Removal takes place in reverse order.

Removing the safety net cassettes.

1. Pull back one of the net's mountings to the larger hole and pull it out.
2. Remove the other mounting in the same way.

Removing the safety net's storage cassette.

1. Lower the whole of the backrest.
2. Slide the cassette outwards until it has released from the mounting brackets.

WARNING

Cargo area loads must be well secured even if the safety net is correctly fitted.

Using the safety net in combination with the cargo cover



The straps for raising are located by the arrows. Follow the same procedure as described in the previous chapter, "Using the cargo net with raised backrests".

Front seat

The passenger seat backrest can also be folded for an extra long load, see page 66.

Roof load

Using load carriers

To avoid damaging the car and for maximum possible safety while driving, the load carriers designed by Volvo are recommended.

Carefully follow the installation instructions supplied with the carriers.

- Check periodically that the load carriers and load are properly secured. Lash the load securely with retaining straps.
- Distribute the load evenly over the load carriers. Put the heaviest objects at the bottom.
- The size of the area exposed to the wind, and therefore fuel consumption, increase with the size of the load.
- Drive gently. Avoid quick acceleration, heavy braking and hard cornering.

WARNING

The car's centre of gravity and driving characteristics are altered by roof loads.

For information on maximum permitted roof load, including load carriers and any space box, see page 224.



Warning triangle

Warning triangle

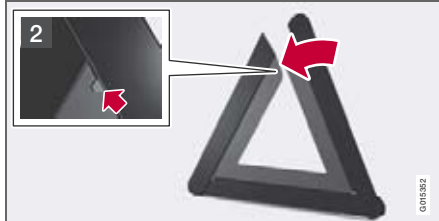
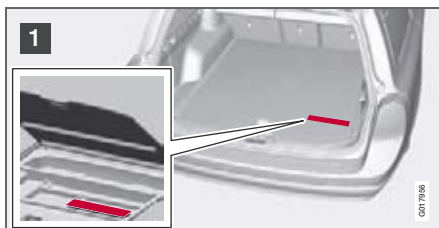

- 1 Lift the floor mat and take out the warning triangle.
- 2 Take the warning triangle from the case, fold out and assemble the two loose sides.
- 3 Fold out the warning triangle's support legs.

Follow the regulations for the use of a warning triangle. Position the warning triangle in a suitable place with regard to traffic.

Ensure the warning triangle and its case are properly secured in the cargo area after use.

NOTE

If the floor hatch is not closed then privacy locking does not work, see page 43.

First aid

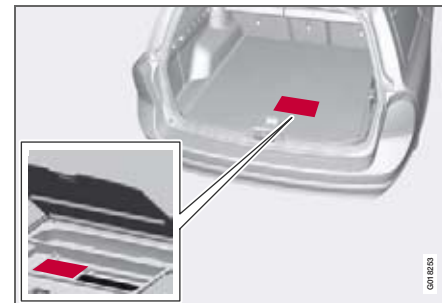

A case with first aid equipment is located under the floor in the cargo area



Driving with a trailer

General

If the towing bracket is mounted by Volvo, then the car is delivered with the necessary equipment for driving with a trailer.

- The car's towing bracket must be of an approved type.
- If the towbar is retrofitted, check with your Volvo dealer that the car is fully equipped for driving with a trailer.
- Distribute the load on the trailer so that the weight on the towing bracket complies with the specified maximum towball load.
- Increase the tyre pressure to the recommended pressure for a full load. For tyre pressure label location, see page 214.
- Clean the towing bracket regularly and grease the towball.
- Do not tow a heavy trailer when the car is brand new. Wait until it has been driven at least 1000 km.
- The brakes are loaded much more than usual on long and steep downhill slopes. Downshift to a lower gear and adjust your speed.
- The engine is loaded more heavily than usual when driving with a trailer.
- If the car is driven with a heavy load in a hot climate, the engine may overheat. If the temperature in the engine's cooling system is too high the warning symbol is

illuminated and the information display shows **High engine temp Stop safely**. Stop the car in a safe way and allow the engine to run at idling speed for several minutes and cool down.

If **High engine temp Stop engine** or **Coolant level low, Stop engine** then the engine must be switched off after stopping the car.

- The automatic gearbox has a built-in protection system that engages in the event of overheating. If the temperature in the gearbox is too high then the warning symbol illuminates and the information display shows **Transmission hot Reduce speed** or **Transmission hot Stop safely**. Follow the instructions and reduce speed or stop the car in a safe way and allow the engine to run at idling speed for several minutes to enable the gearbox to cool down. In the event of overheating the car's air conditioning may be temporarily switched off.
- In the interests of safety, you should restrict speed to 80 km/h, even if the laws of certain countries allow for higher speeds.
- Move the gear selector to position **P** when parking an automatic car with a hitched trailer. Always use the parking brake. Block the wheels with chocks when parking a car with hitched trailer on a hill.

Trailer cable

An adapter is required if the car's towing bracket has 13 pin electrics and the trailer has 7 pin electrics. Use an adapter cable approved by Volvo. Make sure the cable does not drag on the ground.

Direction indicators on trailer

A symbol in the combined instrument panel flashes when the direction indicators are used and the trailer is connected. If the symbol flashes more quickly than one of the lamps on the car or the trailer is broken, see page 61.

Automatic gearbox

Parking on a hill

1. Activate the parking brake.
2. Move the gear selector to position **P**.

Starting on a hill

1. Move the gear selector to position **D**.
2. Release the parking brake.

Steep gradients

- Do not use a higher manual gear than the engine can "handle". It is not always economical to drive in high gears.
- Avoid driving with a trailer on inclines of more than 15%.



Level control*

The rear shock absorbers maintain a constant height irrespective of the car's load (up to the maximum permissible weight). When the car is stationary the rear of the car lowers slightly, which is normal.

Trailer weights

National vehicle regulations can limit trailer weights and speeds. Towbars can be certified for higher towing weights than the car can actually tow. For Volvo's permitted trailer weights, see page 223.

WARNING

Follow the stated recommendations for trailer weights. Otherwise, the car and trailer may be difficult to control in the event of sudden movement and braking.

Towing bracket

If the car is equipped with a detachable towbar, the towball mounting instructions must be followed carefully, see page 177.

WARNING

Be sure to attach the trailer's safety cable to the correct place.

WARNING

If the car is fitted with a Volvo detachable towbar: Follow the assembly instructions for the towball section carefully. The towball section must be locked with the key before setting off. Check that the indicator window shows green.

NOTE

Always detach the towball section after use. Keep it in the cargo area.



Driving with a trailer

Specifications

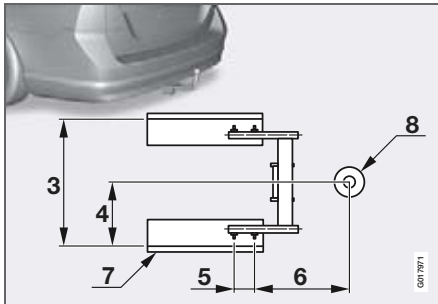
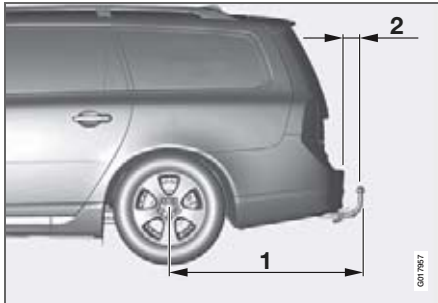

Dimensions, mounting points (mm)

1 (V70)	1129
1 (XC70)	1113
2 (V70)	93
2 (XC70)	77
3	855
4	428
5	112
6	346
7	Side member
8	Ball centre

Important checks

- The towball must be cleaned and greased regularly.



NOTE

If a towball hitch with vibration damper is used, it is not necessary to grease the towball.

05



Driving with a trailer

Installing the towball



- 1 Remove the protective cover by pressing up the catch **1** and pulling the cover straight back **2**.



- 2 Ensure that the mechanism is in the unlocked position by turning the key clockwise.



- 3 The indicator window must show red.



- 4 Insert the towball section until you hear a click.



- 5 The indicator window must show green.



- 6 Turn the key anticlockwise to locked position. Remove the key from the lock.

Driving with a trailer



- 7 Check that the towball section is secure by pulling it up, down and back. If the towball section is not fitted correctly then it must be removed and refitted in accordance with the previous instructions.

! **IMPORTANT**

Only grease in the towball for the towing hitch, the remainder of the towball section should be clean and dry.



- 8 The trailer's safety cable must be secured in the towing bracket's mounting eye.



Removing the towball



- 1 Insert the key and turn it clockwise to the unlocked position.

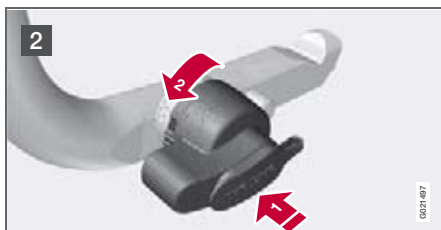

- 2 Push in the locking wheel **1** and turn it anticlockwise **2** until you hear a click.



- 3 Turn the locking wheel down fully, until it comes to a stop. Hold it in this position while pulling the towball rearward and upward.



- 4 Push the protective cover until it snaps tight.

WARNING

Firmly secure the towbar's loose towball if it is stored in the car's cargo area.



Towing

General

Never tow the car to bump start it. Use a donor battery if the battery is discharged and the engine does not start.

IMPORTANT

Bump starting the car can damage the catalytic converter.

Automatic gearbox

Move the gear selector to position **N**.

IMPORTANT

A car with an automatic gearbox must not be towed at speeds above 80 km/h or further than 80 km.

Note that the car must always be towed with the wheels rolling forward.

- A car with an automatic gearbox and raised front suspension (2WD), must not be towed at speeds above 80 km/h.

Note that the car must always be towed with the wheels rolling forward.

- A car with an automatic gearbox, All Wheel Drive (AWD) and raised front suspension, must not be towed at speeds above 80 km/h. It should not be towed further than 80 km. Note that the car must always be towed with the wheels rolling forward.

Manual gearbox

Move gear lever into neutral. The tow rope must always be taut in order to avoid violent jerks. Be prepared to depress the brake pedal.

WARNING

The steering lock stays in the position it was in when the power was cut off. The steering lock must be unlocked before towing. The ignition must be in position **II**. Never remove the remote control key from the ignition switch while driving or when the car is being towed.

WARNING

The brake servo and power steering do not work when the engine is switched off. The brake pedal must be pressed about five times harder than normal, and the steering will be considerably heavier than normal.

Towing eye

Use the towing eye if the car needs to be towed on the road. The towing eye is attached in the recess on the right-hand side of the front or rear bumper.

After use, unscrew the towing eye and return it into the cargo area.

WARNING

The towing eye is only designed for towing on roads, not for recovering the car. Call a recovery service for recovery assistance.

Find out the highest legal speed before towing the car.

WARNING

Insert the remote control key in the ignition switch to unlock the steering lock (so that the car can be steered) before towing.



Fitting the towing eye



- 1** Take out the towing eye that is located under the floor hatch in the cargo area.

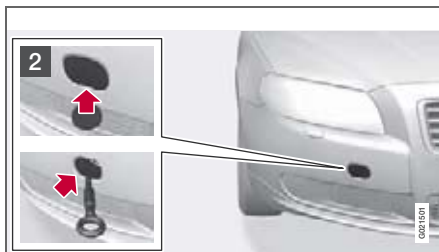

- 2** For the V70: Press the marked edge of the cover into the bumper and release. Fold aside the cover and screw in the towing eye firmly, right in up to the flange.

For the XC70: Release the bottom edge of the cover on the bumper with a screwdriver or coin. Screw in the towing eye firmly, right in up to the flange.

Use the wheel wrench to tighten the towing eye.

i NOTE

On certain cars with fitted towbar the towing eye cannot be secured in the rear mounting. In which case, secure the tow rope in the towbar. For this reason it is advisable to store the towbar's towball in the car, see page 179.

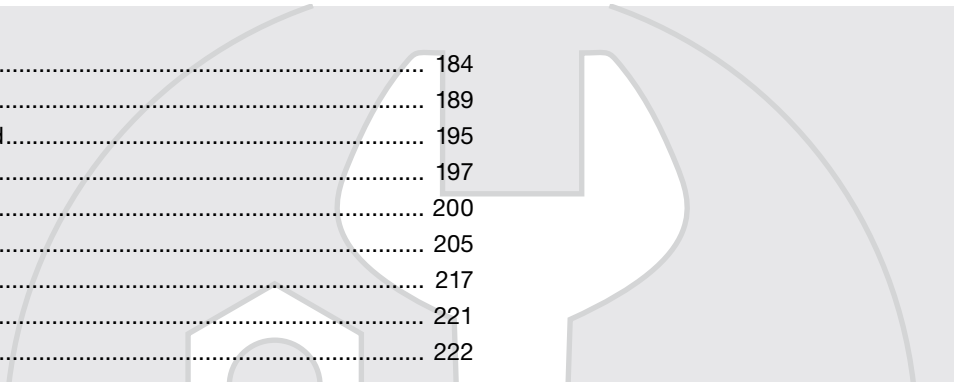

Engine compartment.....	184
Lamps	189
Wiper blades and washer fluid.....	195
Battery.....	197
Fuses.....	200
Wheels and tyres.....	205
Car care.....	217
Type designations	221
Specifications.....	222

MAINTENANCE AND SPECIFICATIONS

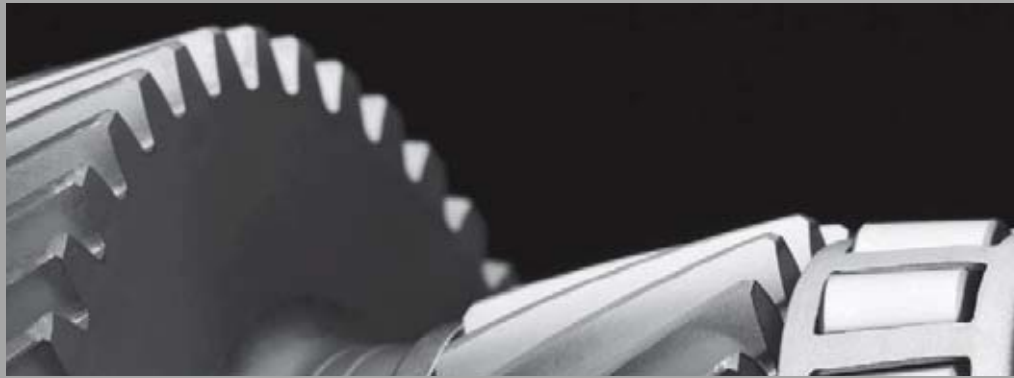

06



Engine compartment

General

Volvo service programme

To keep the car as safe and reliable as possible, follow the Volvo service programme as specified in the Service and Warranty Booklet. Have an authorised Volvo workshop carry out service and maintenance work. Volvo workshops have the personnel, special tools and service literature to guarantee the highest quality of service.

! IMPORTANT

For the Volvo warranty to apply, check and follow the instructions in the Service and Warranty Booklet.

Check regularly

Check the following oils and fluids at regular intervals, e.g. when refuelling:

- Coolant
- Engine oil
- Power steering fluid
- Washer fluid

! WARNING

Bear in mind that the radiator fan may start automatically some time after the engine has been switched off.

Always have the engine cleaned by a workshop. There is a risk of fire if the engine is hot.

Opening and closing the bonnet



- 1 Pull the handle by the pedals. You will hear when the catch releases.
- 2 Move the catch to the left and open the bonnet. (The catch hook is located between the headlamp and grille, see illustration.)

! WARNING

Check that the bonnet locks properly when closed.



Engine compartment

Engine compartment, overview

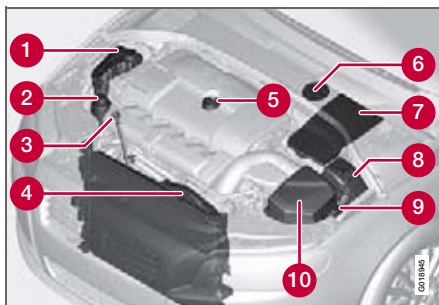

The appearance of the engine compartment may vary depending on engine variant

- 1 Coolant expansion tank
- 2 Power steering fluid reservoir
- 3 Engine oil dipstick
- 4 Radiator
- 5 Filler opening for engine oil
- 6 Brake and clutch fluid reservoir (left-hand drive)
- 7 Battery
- 8 Relay and fuse box
- 9 Filling washer fluid
- 10 Air filter

WARNING

High voltage output from the ignition system. The voltage in the ignition system is highly dangerous. The ignition must therefore always be in position **0** for work in the engine compartment, see page 65.

Do not touch the spark plugs or ignition coils when the ignition is in ignition position **II** or when the engine is hot.

Checking the engine oil



Decal for oil grade

Volvo recommends Castrol oil products. If the car is driven in adverse conditions, see Volvo's recommendations on page 227.



Engine compartment

! IMPORTANT

In order to fulfil the requirements for the engine's service intervals all engines are filled with a specially adapted synthetic engine oil at the factory. The choice of oil has been made very carefully with regard to service life, starting characteristics, fuel consumption and environmental impact. An approved engine oil must be used in order that the recommended service intervals can be applied. Only use a prescribed grade of oil (see the engine compartment decal) for both filling and oil change, otherwise you will risk affecting service life, starting characteristics, fuel consumption and environmental impact. Volvo Car Corporation disclaims all warranty liability if engine oil of the prescribed grade and viscosity is not used.

Volvo uses different systems for warning of low oil level or low oil pressure. Certain variants have an oil pressure sensor, and then the lamp for oil pressure is used. Other variants have an oil level sensor, and then the driver is informed via the warning symbol in the centre of the instrument unit as well as by display texts. Certain models have both variants. Contact a Volvo dealer for more information.

Filling and dipstick

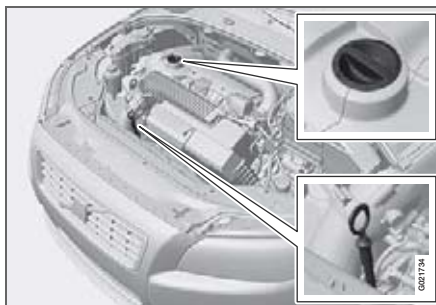

Petrol engine

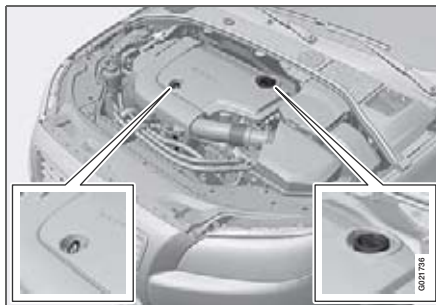

Diesel engine

Change in accordance with the intervals specified in the Service and Warranty Booklet.

! IMPORTANT

When filling oil to top up, the oil being filled must be of the same grade, see page 227.

Checking the oil level in a new car is especially important before the first scheduled oil change.

The most accurate measurements are made on a cold engine before starting. The measurement will be inaccurate if taken immediately after the engine is switched off. The dipstick will indicate that the level is too low because the oil has not had time to flow down into the oil sump.

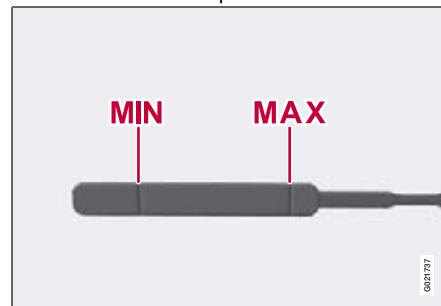

The oil level must be within the area marked on the dipstick.



Engine compartment

Park the car on a level surface, switch off the engine and wait 10-15 minutes to allow the oil time to run back to the sump. For capacities, see page 228.

Checking with a cold engine

1. Wipe the dipstick clean.
2. Check the level using the dipstick. It must be between the **MIN** and **MAX** marks.
3. If the level is close to the **MIN** mark, start by topping up with 0.5 litres of oil. Top up until the level is nearer to **MAX** than **MIN** on the dipstick.

! IMPORTANT

Never fill above the **MAX** mark. Oil consumption may increase if too much oil is poured into the engine.

! WARNING

Do not spill oil onto the hot exhaust manifold due to the risk of fire.

Checking with a warm engine

1. Wipe the dipstick clean.
2. Check the oil level using the dipstick.
3. If the level is close to the **MIN** mark, start by topping up with 0.5 litres of oil. Top up until the level is nearer to **MAX** than **MIN** on the dipstick.

Coolant

Checking and topping up the coolant

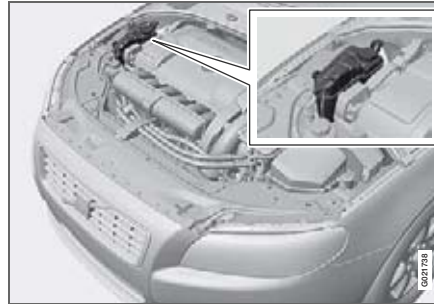

When topping up the coolant, follow the instructions on the packaging. To optimise refrigerant and corrosion protection ensure that the mixture of coolant is always 50% water and 50% coolant. Never top up with water only. The risk of freezing increases with both too little and too much coolant concentrate. For capacities, see page 229.

! IMPORTANT

Always use coolant with anti-corrosion agent as recommended by Volvo. New cars are filled with coolant that can withstand temperatures down to approximately – 35 °C.

Check the coolant regularly

The level must lie between the **MIN** and **MAX** marks on the expansion tank. If the system is not filled sufficiently, high temperatures could occur, causing a risk of damage to the engine.

! WARNING

Coolant can be very hot. If the coolant requires topping up when the engine is at operating temperature, unscrew the expansion tank cap slowly to gently release the overpressure.



Engine compartment

Brake and clutch fluid

Checking the level

Brake and clutch fluid have a common reservoir. The level must be between the **MIN** and **MAX** marks that are visible inside the reservoir. Check the level regularly.

Change the brake fluid every other year or at every other regular service.

For capacities and recommended fluid grade, see page 229. The fluid should be changed annually on cars driven in conditions requiring hard, frequent braking, such as driving in mountains or tropical climates with high humidity.

WARNING

If the brake fluid is under the **MIN** level in the brake fluid reservoir, do not drive further before topping up the brake fluid. The reason for the loss of brake fluid must be investigated by an authorised Volvo workshop.

Filling



The fluid reservoir is located on the driver's side

The fluid reservoir is protected under the cover over the cold section in the engine compartment. The round cover must be removed first before the reservoir cap can be reached.

1. Turn and open the cover located on the covering.
2. Unscrew the reservoir cap and fill the fluid. The level must be between the **MIN** and **MAX** marks, which are located on the inside of the reservoir.

IMPORTANT

Remember to close the cap.

Power steering fluid

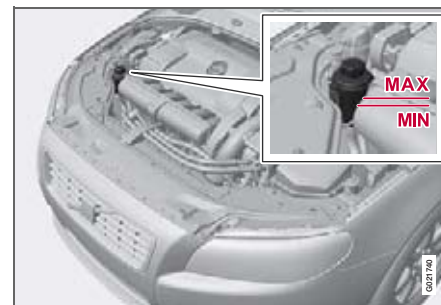

IMPORTANT

Keep the area around the power steering fluid reservoir clean when checking.

Check the level frequently. The fluid does not require changing. The fluid level must be between the **MIN** and **MAX** marks. For capacities and recommended fluid grade, see page 229.

NOTE

If a fault should arise in the power steering system or if the engine is switched off and the car must be towed, it can still be steered.



Lamps

General

All bulb specifications are given on page 194. The following list contains bulbs and point-source lamps that are specialised or unsuitable for replacement except at a workshop:

- General interior lighting in the roof, reading lamps
- Glovebox lighting
- Direction indicators, door mirror
- Approach lighting
- Brake light, fog lamp, reversing lamp
- Rear side position lamps, position lamps
- Active Bi-Xenon, Bi-Xenon lights
- LED lamps, general

WARNING

On cars with Bi-Xenon and Active Bi-Xenon headlamps, Xenon lamp replacement must be carried out at an authorised Volvo workshop. The headlamps must be handled with extreme care due to the Xenon lamp's high-voltage unit.

IMPORTANT

Never touch the glass part of the bulbs with your fingers. Grease and oils from your fingers are vaporised by the heat, coating the reflector and then causing damage.

Front lamp housing

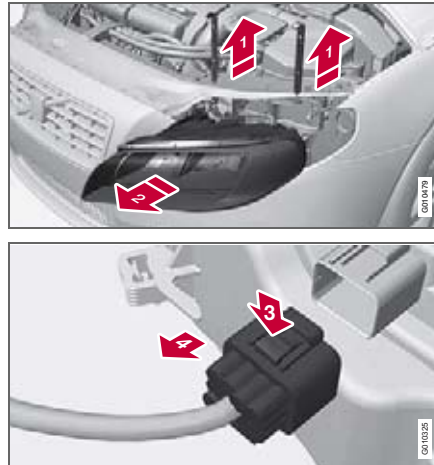

All front bulbs (except those for fog lamps) are replaced by first removing the whole lamp housing from the engine compartment.

WARNING

Always switch off the ignition and remove the remote control key before starting to replace a bulb.

Removing the headlamp

1. Switch off the ignition by pressing quickly on the start/stop button and removing the remote control key.

2. Withdraw the lamp housing's locking pins **1**.
3. Pull the lamp housing straight forward **2**.
4. Detach the lamp housing connector by pressing down the clip with your thumb **3** and at the same time guiding out **4** the connector with your other hand.

IMPORTANT

Do not pull the electrical cable, only the connector

5. Lift out the lamp housing and place it on a soft surface to avoid scratching the lens.
6. Replace the bulb in question, see page 194.

Installing the headlamp

1. Plug in the connector, a "click" should be heard.
2. Reinstall the lamp housing and locking pins. Check that they are correctly inserted.
3. Check the lighting.

The lamp housing must be plugged in and installed before the lighting is switched on or the remote control key is inserted into the ignition switch.



Lamps

Removing the cover

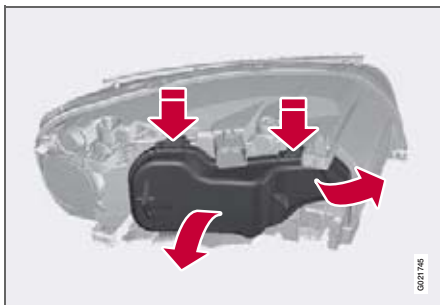

i NOTE

Before starting to replace a bulb, read through page 189.

1. Open the lock clamp by pressing up/out.
2. Press down the clips on the cover and remove it.

Reinstall the cover in reverse order.

Dipped beam, halogen

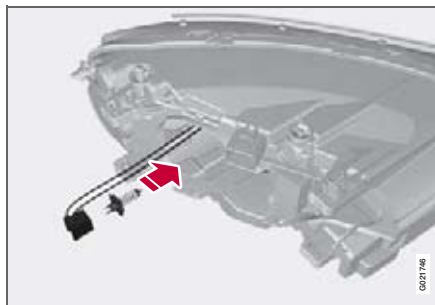

1. Detach the headlamp.
2. Remove the cover.
3. Detach the bulb by pressing the holder downwards.
4. Unplug the connector from the bulb.
5. Fit the new bulb in the socket and snap it in. It can only be secured in one position.

Reinstall the parts in reverse order.

Main beam, Halogen

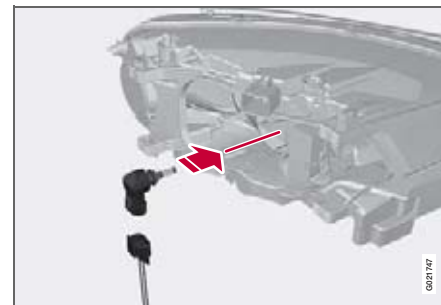

1. Detach the headlamp.
2. Remove the cover.
3. Detach the bulb by turning anticlockwise.
4. Unplug the connector from the bulb.
5. Replace the bulb and align it in the socket & turn clockwise in order to secure it. It can only be secured in one position.

Reinstall the parts in reverse order.



Extra main beam Active Bi-Xenon and Bi-Xenon*

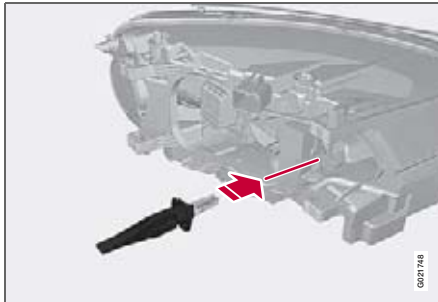

1. Detach the headlamp.
2. Remove the cover, see page 190.
3. Detach the bulb by pressing the holder downwards.
4. Unplug the connector from the bulb.
5. Fit the new bulb in the socket and snap it in. It can only be secured in one position.

Reinstall the parts in reverse order.

Position/parking lamps

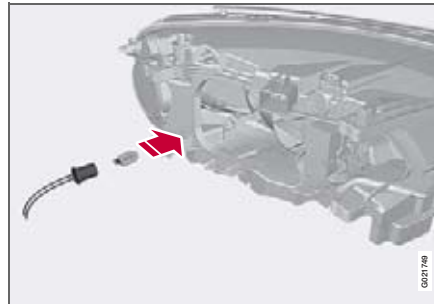

1. Detach the headlamp.
2. Remove the cover, see page 190.
3. For better access, detach the main beam bulb first.
4. Pull the cable in order to withdraw the bulb holder.
5. Remove the blown bulb and fit a new one. It can only be secured in one position.
6. Fit the bulb holder in the socket and press until a "click" is heard.

Reinstall the parts in reverse order.

Direction indicators/flashers

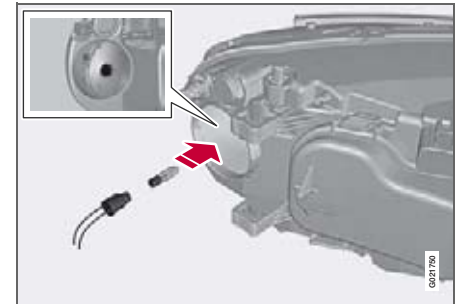

1. Detach the headlamp.
2. Remove the small round cover.
3. Pull the bulb holder in order to extract the bulb.
4. Remove the blown bulb and fit a new one. It can only be installed in one way.
5. Fit the bulb holder in the socket and press until a "click" is heard.
6. Refit the cover. It must be fitted and pressed in until a "click" is heard.

Reinstall the parts in reverse order.



Lamps

Side marker lamps

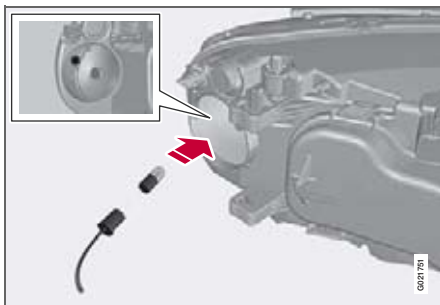

i NOTE

Before starting to replace a bulb, read through page 189.

1. Detach the headlamp.
2. Remove the small round cover.
3. Pull the cable in order to withdraw the bulb holder.
4. Remove the blown bulb and fit a new one. It can only be installed in one way.
5. Fit the bulb holder in the socket and press until a "click" is heard.
6. Refit the cover. It must be fitted and pressed in until a "click" is heard.

Reinstall the parts in reverse order.

Fog lamps

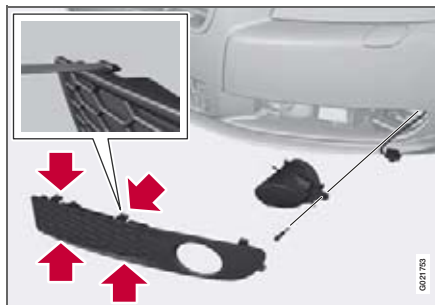

1. Remove the cover by pressing in the clips and pulling straight out.
2. Unscrew the lamp housing screw and pull it out.
3. Turn the bulb anticlockwise and remove it.
4. Fit a new bulb by turning clockwise.
5. Refit the bulb. (The profile of the bulb holder corresponds to the profile of the foot of the bulb.)
6. Refit the bulb holder. The **TOP** mark on the bulb holder must always be upward.

Lamp housing, rear, direction indicators

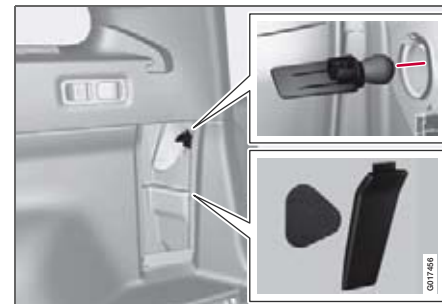

The direction indicator bulb in the rear lamp cluster is replaced from inside the cargo area.

1. Open the panel.
2. Remove the insulation by pulling it straight out.
3. Loosen the whole of the lamp by turning its handle anticlockwise.
4. Detach the bulb by pulling it straight out.

Reinstall the parts in reverse order.

i NOTE

If an error message remains after a faulty bulb has been replaced, contact an authorised Volvo workshop.



Lamps

Location of rear bulbs

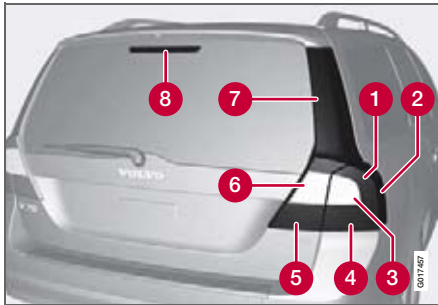

Lamp lens, right-hand side

- 1 Position lamps/brake light (LED)
- 2 Side position lights, SML (LED)
- 3 Direction indicators
- 4 Reflector, rear
- 5 Rear fog lamp (one side)
- 6 Reversing lamp
- 7 Brake light (LED)
- 8 Brake light (LED)

Number plate lighting



1. Remove the screws with a screwdriver.
2. Carefully detach the entire lamp housing and withdraw it.
3. Replace the bulb.
4. Refit the entire lamp housing and screw it into place.

Courtesy lighting

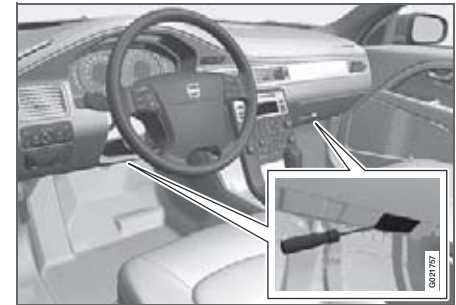
i NOTE

Before starting to replace a bulb, read through page 189.

1. Insert a screwdriver at the short end of the lens closest to the tunnel console and turn gently so that the lens comes loose. (Applies to both lamps).
2. Turn carefully until the lens comes loose.
3. Replace the bulb.
4. Refit the lens.



Lamps

Cargo area lighting



1. Insert a screwdriver and gently prise so that the lamp housing comes loose.
2. Replace the bulb.
3. Check that the bulb illuminates and press back the lamp housing.

Vanity mirror lighting

Removing the mirror glass



1. Insert a screwdriver underneath the lower edge, in the centre. Carefully prise up the lug on the edge.
2. Insert the screwdriver underneath the edge on the left and right-hand sides (by the black rubber sections), and prise carefully so that the glass comes loose in the lower edge.
3. Carefully detach and lift aside the entire mirror glass and cover.
4. Replace the bulb.

Fitting the mirror glass

1. Press the three lugs at top edge of the mirror glass back into position.
2. Then press the three lower lugs back into position.

Specification, bulbs

Lighting	Output W	Type
Extra main beam, Bi Xenon, ABL	55	H7
Dipped beam, halogen	55	H7
Main beam, Halogen	65	H9
Front direction indicators	21	H21W
Direction indicators, rear	21	PY21W
Front fog lamps	35	H8
Courtesy, cargo area, number plate lighting	5	Tubular lamp SV8.5
Vanity mirror	1.2	Tubular lamp SV5.5
Front position and parking lamps	5	W5W
Front side marker lamps	5	W5W
Glovebox lighting	5	Tubular lamp SV8.5



Wiper blades and washer fluid

Wiper blades

Service position

The wiper blades must be in service position to facilitate replacement or washing.

1. Turn the ignition to position **0**, see page 65 and keep the remote control key in the ignition switch.
2. Move the right-hand stalk switch up for about 1 second. The wipers then move to standing straight up.

The wipers return to the starting position when the car is started.

Replacing the wiper blades, windscreen

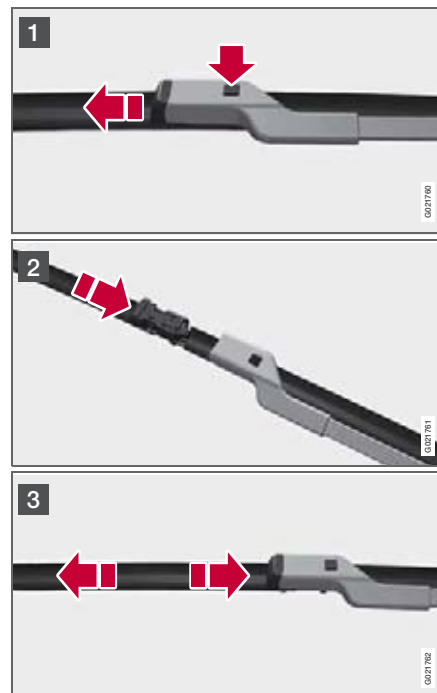

- 1 Turn up the wiper arm. Press the button located on the wiper blade mounting and pull straight out parallel with the wiper arm.
- 2 Slide in the new wiper blade until a "click" is heard.
- 3 Check that the blade is firmly installed.

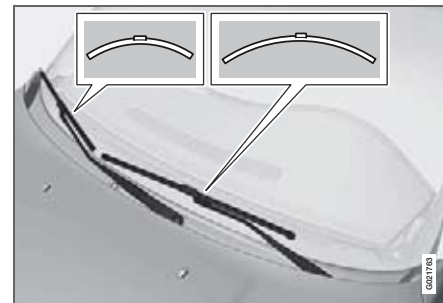

i NOTE

The wiper blades are different lengths. The blade on the driver's side is longer than the blade on the passenger side.



Wiper blades and washer fluid

Replacing the wiper blades, rear window



1. Fold out the wiper arm.
2. Grip the inner section of the blade (by the arrow).
3. Turn anticlockwise to use the blade's end position against the wiper arm as a lever to detach the blade more easily.
4. Press the new wiper blade into position. Check that it is firmly installed.
5. Lower the wiper arm.

Cleaning

Clean the wiper blades with a lukewarm soap solution or car shampoo.

Filling washer fluid

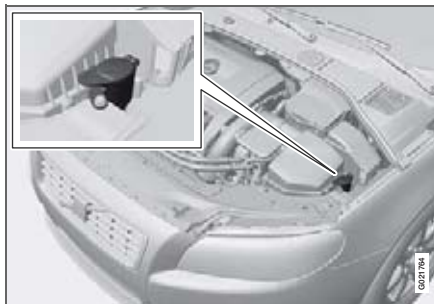

The windscreen and headlamp washers share a common reservoir.

! IMPORTANT

Add washer antifreeze during the winter so that the fluid does not freeze in the pump, reservoir and hoses. For capacities, see page 229.



Warning symbols on the battery



Use protective goggles



Further information in the owner's manual.



Store the battery out of the reach of children.



The battery contains corrosive acid.



Avoid sparks and naked flames.



Risk of explosion.

NOTE

An expended battery must be recycled in an environmentally safe manner, as it contains lead.

Handling

- Check that the battery cables are correctly connected and tightened.
- Never disconnect the battery when the engine is running.

The service life and function of the battery is influenced by factors such as the number of starts, discharging, driving style, driving conditions, climatic conditions etc.

Never use a quick charger to charge the battery.



WARNING

Batteries can generate oxyhydrogen gas, which is highly explosive. One spark, which can be generated if you connect jump leads incorrectly, is sufficient to make the battery explode. The battery contains sulphuric acid, which can cause serious burns. If the acid comes into contact with eyes, skin or clothing, flush with large quantities of water. If acid splashes into the eyes, seek medical attention immediately.



NOTE

The life of the battery is shortened if it becomes discharged repeatedly.



Battery

Changing

Removal

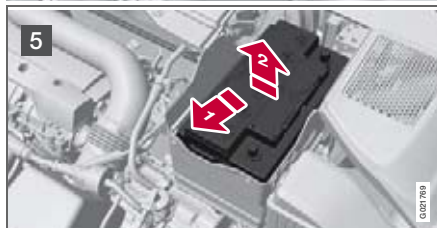
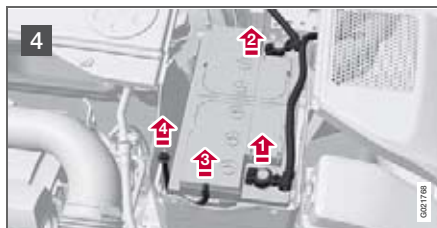
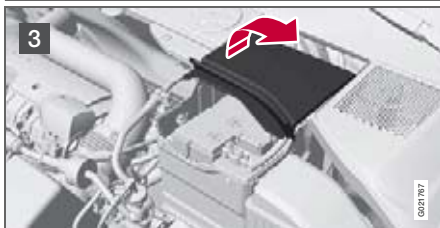
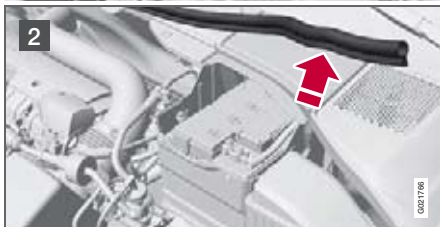
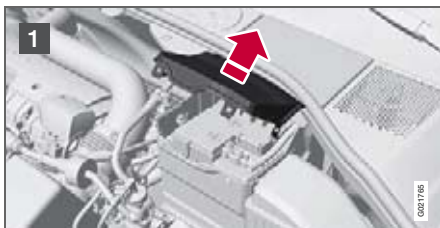

Switch off the ignition and wait for 5 minutes.

- 1 Open the clips on the front cover and remove the cover.
- 2 Release the rubber moulding so that the rear cover is free.
- 3 Remove the rear cover by screwing one quarter turn and lifting it away.

 **WARNING**
 Connect and disconnect the positive and negative cables in the correct sequence.

- 4 Detach the black negative cable **1**.
 Detach the red positive cable **2**, detach the ventilation hose **3** from the battery and loosen the screw holding the battery clamp **4**.
- 5 Move the battery to the side and lift it up.



Installation

1. Lower the battery into the battery box.

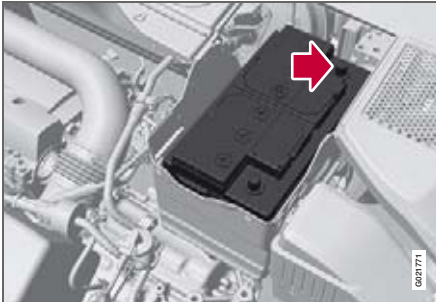

2. Move the battery inward and to the side until it reaches the rear edge of the box.
3. Screw in the battery with the screw in the clamp.
4. Connect the ventilation hose.
5. Connect the red positive cable.
6. Connect the black negative cable.
7. Press in the rear cover. (See Removal).
8. Reinstall the rubber moulding. (See Removal).
9. Reinstall the front cover and secure it with the clips. (See Removal).



Fuses

General

All electrical functions and components are protected by a number of fuses in order to protect the car's electrical system from damage by short circuiting or overloading. If an electrical component or function does not work, it may be because the component's fuse was temporarily overloaded and failed. If the same fuse fails repeatedly then there is a fault in the circuit. In which case, contact an authorised Volvo workshop to have the system checked.

Changing

1. Look in the fuse diagram to locate the fuse.
2. Pull out the fuse and check from the side to see whether the curved wire has blown.
3. If this is the case, replace it with a new fuse of the same colour and amperage.

Location, fuse boxes

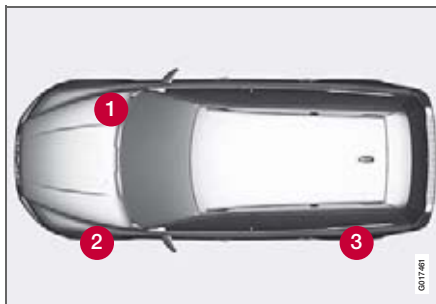

Location of fuse boxes, left-hand drive

If the car is right-hand drive, the fuse box **1** changes side.

- 1** Under the glovebox
- 2** Engine compartment
- 3** Cargo area



Fuses

Engine compartment

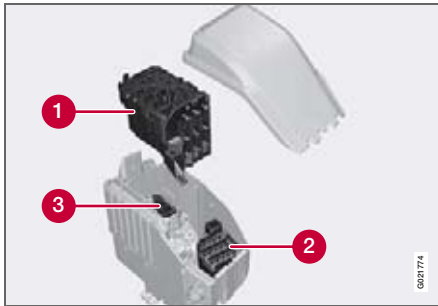

On the inside of the cover are tweezers that facilitate the removal and fitting of fuses.

Positions

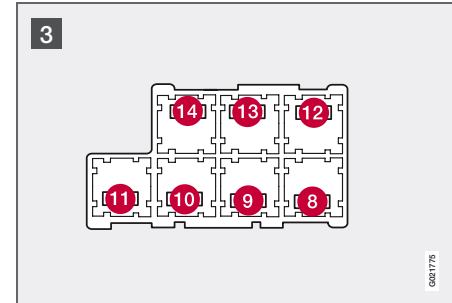
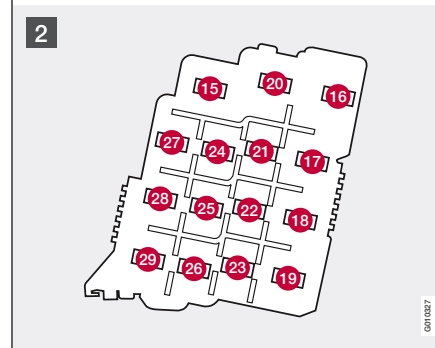
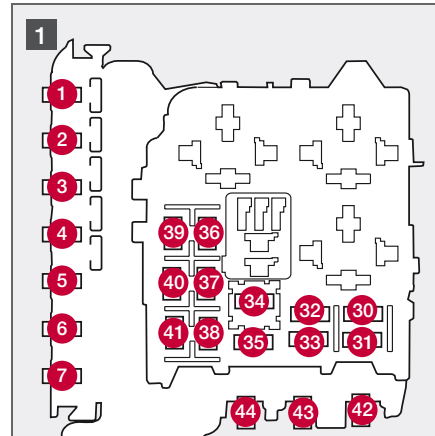

- 1 Engine compartment, upper
- 2 Engine compartment, front
- 3 Engine compartment, lower

These fuses are all located in the engine compartment box. Fuses in **3** are located under **1**.

- 16 – 33 and 35 – 41 are of the "MiniFuse" type.
- Fuses 8 – 15 and 34 are of the "JCASE" type and must only be replaced by an authorised Volvo workshop.
- Fuses 1 – 7 and 42 – 44 are of the "Midi Fuse" type and must only be replaced by an authorised Volvo workshop.



06 Maintenance and specifications

Fuses

	Function	A
1	Primary fuse CEM KL30A	50
2	Primary fuse CEM KL30B	50
3	Primary fuse RJBA KL30	60
4	Primary fuse RJBB KL30	60
5	Primary fuse RJBD KL30	50
6	Reserve	
7	PTC Air preheater*	100
8	Reserve	
9	Windscreen wipers	30
10	Parking heater*	25
11	Ventilation fan	40
12	Reserve	
13	ABS pump	40
14	ABS valves	20
15	Reserve	
16	Headlamp levelling* (Active Bi-Xenon, Bi-Xenon)	10
17	Primary fuse CEM	20
18	Radar, ACC control module*	5
19	Speed related power steering	5
20	Engine Control Module (ECM), transm. SRS	10

	Function	A
21	Heated washer nozzles	10
22	Vacuum pump IST	20
23	Lighting panel	5
24	Headlamp washers	15
25	12 V socket, front and rear seat	15
26	Sunroof*, Roof console/ECC*	10
27	Relay, engine compartment box	5
28	Auxiliary lamps*	20
29	Horn	15
30	Engine Control Module (ECM)	10
31	Control module, automatic gear-box*	15
32	Compressor A/C	15
33	Relay coils	5
34	Starter motor relay	30
35	Ignition coils/Glow system diesel	20/10
36	Engine Control Module (ECM) petrol/diesel	10/15
37	Injection system	15
38	Engine valves	10
39	EVAP, Lambda-sond, Injection (petrol/diesel)	15/10

	Function	A
40	Crankcase ventilation heater (5-cyl petrol)/ Diesel filter heater, crankcase ventilation heater (5-cyl diesel)	20/20
41	Leakage diagnosis*	5
42	Glow plugs diesel	70
43	Cooling fan	50
44	Cooling fan	60



Fuses

Under the glovebox

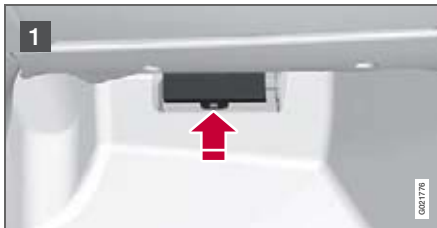

Fold aside the interior trim covering the fuse box.

- 1 Press the cover's lock and fold it up.
- 2 The fuses are accessible.

Positions

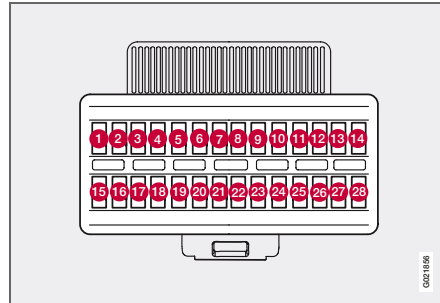

	Function	A
1	Rain sensor	5
2	SRS system	10
3	ABS brakes. Electric parking brake	5
4	Accelerator pedal*, air heater (PTC) Heated seats*	7.5
5	Reserve	
6	ICM display. CD & Radio, RSE system*	15
7	Steering wheel module	7.5
8	Reserve	
9	Main beam	15
10	Sunroof*	20
11	Reversing lamps.	7.5

	Function	A
12	Reserve	
13	Front fog lamp*	15
14	Windscreen washers	15
15	Adaptive cruise control ACC*	10
16	Reserve	
17	Roof lighting. Control panel driver's door/ Power passenger seat*	7.5
18	Information display	5
19	Power driver's seat*	5
20	Reserve	
21	Remote control key receiver. Alarm sensors	5
22	Fuel pump	20
23	Electric steering lock	20
24	Reserve	
25	Lock, tank/tailgate	10
26	Alarm siren. ECC	5
27	Start/stop button	5
28	Brake light switch	5

06



06 Maintenance and specifications

Fuses

Cargo area

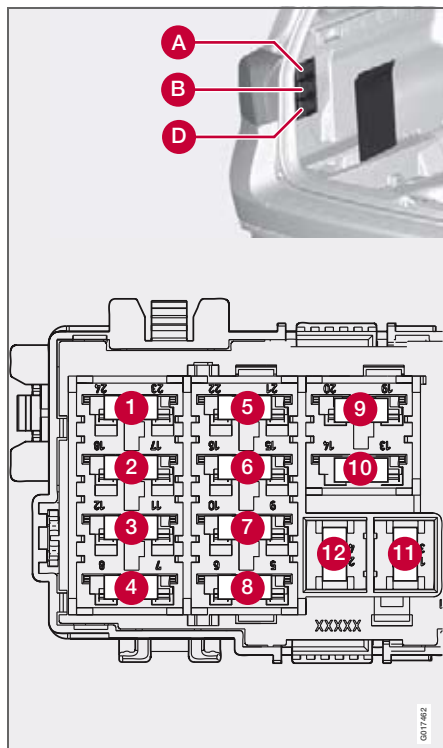

The fuse box is located behind the upholstery on the left-hand side.

Positions

	Module A (black). Function	A
1	Control panel, driver's door	25
2	Control panel, passenger door	25
3	Control panel, rear door, left	25
4	Control panel, rear door, right	25
5	Reserve	
6	12 V socket cargo area, refrigerator*	15
7	Rear window defroster	30
8	Reserve	
9	Trailer socket 2*	15
10	Power seat driver's side	25
11	Trailer socket 1*	40
12	POT (automatic tailgate opening)*	30

	Module B (white). Function	A
1	Reserve	
2	Control module Four C*	15
3	Seat heating, driver's side front*	15
4	Seat heating, passenger side front*	15
5	Seat heating right rear*	15
6	AWD control module	10
7	Seat heating left rear*	15

	Module B (white). Function	A
8	Reserve	
9	Power seat passenger side	25
10	Keyless drive*	20
11	Electric parking brake* left	30
12	Electric parking brake* right	30

	Module D (blue). Function	A
1	Display RTI*, parking camera*	10
2	Reserve	
3	Bass speaker	25
4	Reserve	
5	Audio amplifier	25
6	Audio system	15
7	Phone	5
	Reserve 8 - 12	



Wheels and tyres

General

Tyres greatly affect the car's driving characteristics. The type of tyre, dimensions, tyre pressure and speed rating are important for how the car performs.

Direction of rotation



The arrow shows the tyre's direction of rotation

Tyres with a tread pattern which are designed to only turn in one direction have the direction of rotation marked with an arrow. The tyre must always rotate in the same direction throughout its lifespan. Tyres should only be switched between front and rear positions, never between left and right-hand sides, or vice versa. If the tyre is mounted incorrectly, the car's braking char-

acteristics and capacity to force rain and slush out of the way are adversely affected.

NOTE

Ensure that tyres of the same type and dimensions, and also the same make, are fitted to all four wheels.

Follow the recommended tyre pressures specified on the tyre pressure label, see page 215.

Changing wheels

Removing

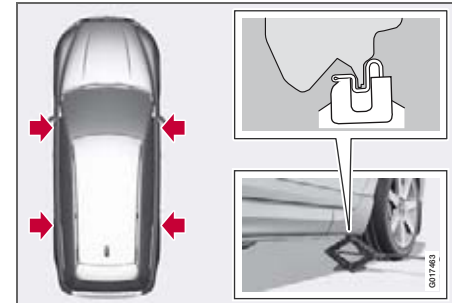

Mounting points

Set up the warning triangle if a wheel must be replaced at a busy location. The car and jack must be on a firm horizontal surface.

1. Apply the parking brake and engage first gear, or position P if the car has an automatic gearbox.
2. Take out the spare wheel, jack and wheel wrench that are located under the carpet in the cargo area.

NOTE

Use the jack belonging to the car.



Wheels and tyres

- Place chocks in front of and behind the wheels which will remain on the ground. Use heavy wooden blocks or large stones.

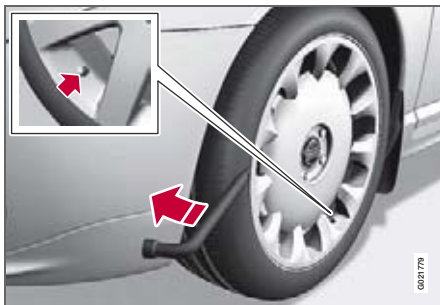

- (For cars with steel rims.) Prise off the wheel cover with the end of the wheel wrench, or pull it off by hand.
- Loosen the wheel nuts $\frac{1}{2}$ –1 turn anti-clockwise with the wheel wrench.
- There are two jacking points on each side of the car. Crank the foot of the jack down so it is pressed squarely on the ground. Check that the jack sits in the anchorage as illustrated and that the foot is positioned vertically under the anchorage.
- Lift the car so that the wheel is free. Remove the wheel bolts and lift off the wheel.

Installation

- Clean the contact surfaces on the wheel and hub.
- Put on the wheel. Screw in the wheel bolts.
- Lower the car so that the wheels cannot rotate.



- Tighten the wheel bolts crosswise. It is important that the wheel bolts are tightened properly. Tighten to 140 Nm. Check the torque with a torque wrench.
- Fit on the wheel cover (for cars with steel rims).



NOTE

The hubcap outlet for the valve must be located over the valve on the rim when fitted.



WARNING

Never crawl under the car when it is raised on the jack.

Passengers must leave the car when it is raised on the jack.

Park the car so that passengers have the car - or preferably a crash barrier - between them and the road.



Wheels and tyres

Tyre care

Tyre age

All tyres older than six years should be checked by an expert even if they seem undamaged. Tyres age and decompose, even if they are hardly ever or never used. The function can therefore be affected. This also applies to spare tyres, winter tyres and tyres saved for future use. Examples of external signs which indicate that the tyre is unsuitable for use are cracks or discoloration.

New tyres



Tyres are perishable. After a few years they begin to harden at the same time as the friction capacity/characteristics gradually deteriorate. For this reason, aim to get as fresh tyres as possible when you replace them.

This is especially important with regard to winter tyres. The week and year of manufacture, the tyre's DOT marking (Department of Transportation), are stated with four digits, for example 1502. The tyre in the illustration was manufactured in week 15 of 2002.

Summer and winter tyres

When summer and winter wheels are changed they should be marked with which side of the car they were mounted on, for example **L** for left and **R** for right.

Wear and maintenance

The correct tyre pressure results in more even wear, see page 215. To achieve the best traction and more even wear on the tyres, the regular switching of the front and rear tyres with each other is recommended. The first change should be after 5 000 km and then at intervals of 10 000 km, this is to avoid differences in tread depth. Tyres with the greatest tread depth should always be fitted to the rear wheels to decrease the risk of skidding. Contact an authorised Volvo workshop if you are uncertain about tread depth.

Wheels should be stored lying down or hanging up, and not standing up.

WARNING

A damaged tyre can lead to loss of control of the car.

Tyres with tread wear indicators

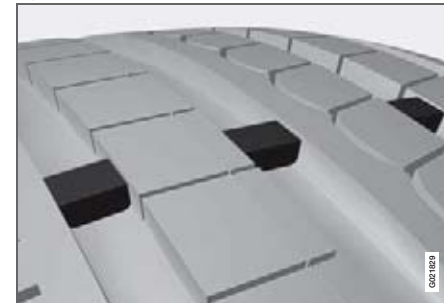

Tread wear indicators are narrow treadless bands across the width of the tread. On the side of the tyre are the letters **TWI** (Tread Wear Indicator). When the tyre's tread depth is down to 1.6 mm, the tread depth will be level in height with the tread wear indicators. Change to new tyres as soon as possible. Remember that tyres with little tread depth provide very poor grip in rain and snow.

Rims and wheel bolts

IMPORTANT

The wheel bolts must be tightened to 140 Nm. Overtightening can damage the nuts and the bolts.

Only use rims that are tested and approved by Volvo and which are Volvo genuine acces-



Wheels and tyres

sories. Check the torque with a torque wrench.

Locking wheel bolts

Locking wheel bolts can be used on both aluminium and steel rims.

Winter tyres

Volvo recommends winter tyres with particular dimensions. These are stated on the tyre pressure label, see page 214. The tyre dimensions are dependent on the engine variant. When driving on winter tyres, the correct tyres must be fitted to all four wheels.

NOTE

Ask a Volvo dealer which rim and tyre types are most suitable.

Studded tyres

Studded winter tyres should be run in gently for 500-1000 km so the studs settle properly into the tyre. This gives the tyre, and especially the studs, a longer service life.

NOTE

The legal provisions for the use of studded tyres vary from country to country.

Tread depth

Road conditions with ice, slush and low temperatures place considerably higher demands on tyres than summer conditions. Volvo therefore recommends not to drive on winter tyres that have a tread depth of less than 4 millimetres.

Using snow chains

Snow chains may only be used on the front wheels (also applies to all-wheel drive cars).

Never drive faster than 50 km/h with snow chains. Avoid driving on bare ground as this wears out both the snow chains and tyres. Never use quick-fit snow chains as the space between the brake discs and the wheels is too small.

IMPORTANT

Use Volvo genuine snow chains or equivalent chains designed for the car model, and tyre and rim dimensions. Consult an authorised Volvo workshop



Wheels and tyres

Tools



A foam block, located in the spare wheel rim, contains all tools. The tools consist of a towing eye, jack and wheel wrench. The foam block is screwed into a bracket in the bottom of the spare wheel well.

Jack

The original jack should only be used for changing wheels. The jack's thread must always be well greased.

Spare wheel*

The spare wheel (Temporary spare) is only intended for temporary use. Replace the spare wheel with a normal wheel as soon as possible. The car's handling may be altered by the use of the spare wheel. The correct tyre pressure for the spare wheel is stated on the tyre pressure table, see page 215.

! IMPORTANT

Never drive faster than 80 km/h with a spare wheel on the car.

! IMPORTANT

The car must never be driven fitted with more than one temporary spare wheel.

The spare wheel is located in the spare wheel well with the outside down. Three foam blocks, two under the spare wheel and one over/inside affix the spare wheel in position. The upper one contains all tools.

The same bolt runs through to secure the spare wheel and the foam blocks.

Taking out the spare wheel

1. Fold the rear edge of the floor mat forward.
2. Undo the retaining screw.
3. Lift out the foam block with its tools.
4. Lift out the spare wheel.

The lower block does not need to be lifted out.

After use

The foam block and spare wheel must be replaced in the reverse order to taking out.

i NOTE

If the floor hatch is not closed then privacy locking does not work, see page 43.



Wheels and tyres

Emergency puncture repair*

General

The emergency puncture repair kit is used to seal a puncture as well as to check and adjust the tyre pressure. It consists of a compressor and a bottle with sealing fluid. The kit works as a temporary repair. The sealing fluid bottle must be replaced before its expiration date and after use.

The sealing fluid effectively seals tyres punctured in the tread.

NOTE

The emergency puncture repair kit is only intended for sealing tyres with a puncture in the tread.

The emergency puncture repair kit has limited capacity to seal tyres which have punctures in the wall. Do not seal tyres with the emergency puncture repair kit if they have larger slits, cracks or similar damage.

12 V sockets for the compressor are located by the centre console in the front, by the rear seat and in the cargo area. Choose the electrical socket that is closest to the punctured tyre.

Taking out the emergency puncture repair kit

Set up the warning triangle adjacent to a trafficked location. The emergency puncture repair kit is located under the floor in the cargo area.

1. Fold the rear edge of the floor mat forward.
2. Unscrew the retaining screw.
3. Lift away the foam block holding the jack and wheel wrench.
4. Lift up the emergency puncture repair kit.

Replace the parts after use.



WARNING

You should not drive faster than 80 km/h after the emergency tyre repair kit has been used. The temporarily sealed tyre must be changed as soon as possible (maximum driving distance: 200 km).



Wheels and tyres

Overview



- 1 Decal, maximum permitted speed
- 2 Switch
- 3 Cable
- 4 Bottle holder (orange cap)
- 5 Protective cap
- 6 Pressure reducing valve
- 7 Air hose

- 8 Sealing fluid bottle
- 9 Pressure gauge
- 10 Gloves

Inflating the tyres

The car's original tyres can be inflated by the compressor.

1. The compressor must be switched off. Make sure that the switch is in position **0** and locate the cable and air hose.
2. Unscrew the wheel's dust cap and screw in the air hose valve connection to the bottom of the thread on the tyre's air valve.
3. Connect the cable to one of the car's 12 V sockets and start the car.

WARNING

Inhaling car exhaust fumes can result in danger to life. Never leave the engine running in sealed areas or areas that lack sufficient ventilation.

4. Start the compressor by flicking the switch to position **I**.
5. Inflate the tyre to the pressure specified on the tyre pressure decal, (release air using the pressure reducing valve if the tyre pressure is too high).

IMPORTANT

Risk of overheating. The compressor must not run for more than 10 minutes.

6. Switch off the compressor. Detach the air hose and cable.
7. Refit the dust cap.



Wheels and tyres

Sealing punctured tyres



For information on the function of the parts, see the illustration on page 211.

1. Open the lid of the emergency puncture repair kit.
2. Detach the decal for maximum permitted speed and affix it to the steering wheel.
3. Check that the switch is in position **0** and locate the cable and the air hose.

4. Put on the gloves.

WARNING

The sealing fluid can irritate the skin. In the case of contact with skin, wash away the fluid with soap and water.

5. Unscrew the orange cap and unscrew the bottle's stopper.

NOTE

Do not break the bottle seal. The seal is broken when the bottle is screwed in.

6. Screw the bottle into its holder.

WARNING

Do not unscrew the bottle, it is equipped with a reverse catch to prevent leakage.

7. Unscrew the wheel's dust cap and screw in the air hose valve connection to the bottom of the thread on the tyre's air valve.
8. Plug the cable into the 12 V socket and start the car.
9. Flick the switch to position **I**.

WARNING

Never stand next to the tyre when the compressor is running. If cracks or unevenness arise then the compressor must be switched off immediately. The journey should not be continued. Contact an authorised tyre centre.

NOTE

When the compressor starts, the pressure can increase up to 6 bar but the pressure drops after approximately 30 seconds.

10. Inflate the tyre for 7 minutes.

IMPORTANT

Risk of overheating. The compressor must not run for more than 10 minutes.

11. Switch off the compressor to check the pressure on the pressure gauge. Minimum pressure is 1.8 bar and maximum is 3.5 bar.

WARNING

If the pressure is below 1.8 bar then the hole in the tyre is too big. The journey should not be continued. Contact an authorised tyre centre.

**Wheels and tyres**

12. Switch off the compressor and unplug the cable from the 12 V socket.
13. Detach the hose from the tyre valve and fit the valve cap.
14. As soon as possible drive approximately 3 km at a maximum speed of 80 km/h so that the sealing fluid can seal the tyre.

Rechecking the repair and pressure

1. Reconnect the equipment.
2. Read the tyre pressure on the pressure gauge.
 - If it is below 1.3 bar then the tyre is insufficiently sealed. The journey should not be continued. Contact a tyre centre.
 - If the tyre pressure is higher than 1.3 bar, the tyre must be inflated to the pressure specified on the tyre pressure decal. Release air using the pressure reducing valve if the tyre pressure is too high.
3. Switch off the compressor. Detach the air hose and cable. Refit the dust cap.

WARNING

Do not unscrew the bottle, it is equipped with a reverse catch to prevent leakage.

4. Return the emergency puncture repair kit to the cargo area.

NOTE

The sealing fluid bottle and hose must be replaced after use. Replacement must be performed by an authorised Volvo workshop.

WARNING

Check the tyre pressure regularly.

Drive to the nearest authorised Volvo workshop for the replacement/repair of the damaged tyre. Advise the workshop that the tyre contains sealing fluid.

WARNING

You should not drive faster than 80 km/h after the emergency tyre repair kit has been used. Contact an authorised Volvo workshop for inspection of the sealed tyre (maximum driving distance is 200 km). The staff there can determine whether or not the tyre can be repaired or if it needs to be replaced.

Replacing the sealing fluid canister

Replace the bottle when the expiration date has passed. Treat the old bottle as environmentally hazardous waste.

IMPORTANT

Read the safety instructions on the bottom of the bottle.



Wheels and tyres

Specifications

Designation of dimensions

The dimensions are stated on all car tyres.

Example of designation:

225/50R17 94 W.

225	Section width (mm)
50	Ratio between section height and width (%)
R	Radial ply
17	Rim diameter in inches (")
94	Tyre load index
W	Speed rating (in this case 270 km/h).

Speed ratings

The car is approved as a whole, which means that dimensions and speed ratings must not differ from those specified on the car's registration document.

The only exception to these conditions is winter tyres (both those with metal studs and those without). If such a tyre is chosen, the car must not be driven faster than the speed

rating of the tyre. (For example, class Q can be driven at a maximum of 160 km/h).

Traffic regulations determine how fast a car can be driven, not the speed rating of the tyres.

Q	160 km/h (used only on winter tyres)
T	190 km/h
H	210 km/h
V	240 km/h
W	270 km/h
Y	300 km/h

NOTE

It is the maximum permitted speed that is stated in the table.

Tyre pressure



The tyre pressure decal on the driver's side door pillar (between frame and rear door) shows which pressures the tyres should have at different loads and speed conditions, this is also specified in the tyre pressure table, see page 215.

- Tyre pressure for the car's recommended wheel dimension
- ECO pressure
- Spare wheel pressure (Temporary Spare)

NOTE

Temperature differences change tyre pressure.



Wheels and tyres

Recommended tyre pressure

Variant V70	Tyre size	Speed (km/h)	Load, 1-3 persons		Max. load	
			Front (kPa) ¹	Rear	Front (kPa)	Rear (kPa)
6-cyl	225/55 R 16, 225/50 R 17 245/45 R 17	0 – 160	230	210	260	260
		160 +	280	280	300	300
	245/40 R 18	0 – 160	230	210	260	260
		160 +	270	270	290	290
5-cyl diesel 185 hp	225/55 R 16 225/50 R 17, 245/45 R 17	0 – 160	220	210	260	260
		160 +	260	260	270	270
	245/40 R 18	0 – 160	230	210	260	260
		160 +	260	260	270	270
5-cyl diesel 163 hp 5-cyl petrol	225/55 R 16 225/50 R 17	0 – 160	220	210	260	260
		160 +	260	260	270	270
	245/40 R 18	0 – 160	230	210	260	260
		160 +	260	260	270	270
	205/60 R 16	0 – 160	230	210	260	260
		160 +	270	270	290	290
All	All ²	0 – 160	260 ²	260 ²	260 ²	260 ²
Spare wheel ³	T 125/80 R 17	max. 80	420	420	420	420

¹In certain countries there is the "bar" unit beside the SI unit "Pascal": 1 bar = 100 kPa

²ECO pressure, economical driving

³Temporary Spare



Wheels and tyres

Variant XC70	Tyre size	Speed (km/h)	Load, 1-3 persons		Max. load Front (kPa)	Rear (kPa)
			Front (kPa) ¹	Rear		
6-cyl, 5-cyl	215/65 R 16, 235/55 R 17 235/50 R 18	0 – 160	230	230	260	260
		160 +	240	240	280	280
All	All ²	0 – 160	260 ²	260 ²	260 ²	260 ²
Spare wheel ³	T 125/80 R 17	max. 80	420	420	420	420

¹In certain countries there is the "bar" unit beside the SI unit "Pascal": 1 bar = 100 kPa

²ECO pressure, economical driving

³Temporary Spare

Fuel economy, ECO pressure

At speeds under 160 km/h, the general tyre pressure for full load is recommended in order to obtain optimum fuel economy.

Checking the tyre pressure

The tyre pressures must be checked every month. This also applies to the car's spare wheel. After several few kilometres of driving, the tyres warm up and the pressure increases. Check tyre pressures on cold tyres. "Cold tyres" means the tyres are the same temperature as the ambient temperature.

Inadequate tyre pressure increases fuel consumption, shortens tyre lifespan and impairs the car's roadholding. Driving on tyres with

tyre pressure that is too low could result in the tyres overheating and being damaged. Tyre pressure affects travelling comfort, road noise and steering characteristics.



NOTE

Tyre pressure decreases over time, this is a natural phenomenon. Tyre pressure also varies depending on ambient temperature.



Washing the car

Wash the car as soon as it becomes dirty.
Wash the car in a car wash with oil separator.
Use car shampoo.

- Remove bird droppings from the paintwork as soon as possible. Bird droppings contain chemicals that affect and discolour paintwork very quickly. An authorised Volvo workshop is recommended for the removal of any discoloration.
- Hose down the underbody. If using a pressure washer, keep the nozzle at least 30 cm from the painted surfaces.
- Rinse the entire car to remove loose dirt. Do not spray directly onto the locks.
- Wash using a sponge, car shampoo and plenty of lukewarm water.
- Clean the wiper blades with a lukewarm soap solution or car shampoo.
- Use cold degreasing agent on very dirty surfaces.
- Dry the car using a clean, soft chamois or a water scraper.

WARNING

Always have the engine cleaned by a workshop. There is a risk of fire if the engine is hot.

NOTE

Outside lighting such as headlamps, fog lamps and rear lamps may temporarily have condensation on the inside of the lens. This is a natural phenomenon, all outside lighting is designed to withstand this. Condensation is normally vented out of the lamp housing when it has been switched on for a time.

Automatic car washes

An automatic car wash is a simple and quick way of washing the car, but it cannot reach everywhere. Handwashing the car is recommended for achieving optimum results.

NOTE

During the first few months a new car must only be handwashed. This is because the paintwork is more sensitive when it is new.

WARNING

Always test the brakes after washing the car, including the parking brake, to ensure that moisture and corrosion do not attack the brake pads and reduce braking performance.

Lightly depress the brake pedal now and then when driving long distances in rain or

slush. The heat from the friction causes the brake linings to warm up and dry. Do the same thing after starting in very damp or cold weather.

Exterior plastic, rubber and trim components

A special cleaning agent available from Volvo dealers is recommended for cleaning coloured plastic parts, rubber and trim components, such as glossy trim mouldings. When using such a cleaning agent the instructions must be followed carefully.

IMPORTANT

Avoid waxing and polishing on plastic and rubber.

Polishing glossy trim mouldings could wear away or damage the glossy surface.

Polishing agent that contains abrasive must not be used.

Rims

Only use cleaning agent recommended by Volvo. Strong rim cleaning agents can damage the surface and cause stains on chrome-plated aluminium rims.



Car care

Polishing and waxing

Polish and wax the car if the paintwork is dull or to give the paintwork extra protection.

The car does not need to be polished until it is at least one year old. However, the car can be waxed during this time. Do not polish or wax the car in direct sunlight.

Wash and dry the car thoroughly before you begin polishing or waxing. Clean off asphalt and tar stains using Volvo tar remover or white spirit. More stubborn stains can be removed using fine rubbing paste designed for car paintwork.

Polish first with a polish and then wax with liquid or solid wax. Follow the instructions on the packaging carefully. Many preparations contain both polish and wax.



IMPORTANT

Paint treatment such as preserving, sealing, protection, lustre sealing or similar could damage the paintwork. Paintwork damage caused by such treatments is not covered by Volvo warranty.

Cleaning front side windows that have a water-repellent surface (option)



Never use products such as car wax, degreaser or similar on glass surfaces as this could ruin their water-repellent properties.

Take care when cleaning so as not to damage the glass surface.

To avoid damaging glass surfaces when removing ice – only use plastic ice scrapers.

There is natural wear of the water-repellent coating.

Treatment with a special finishing agent available from Volvo dealers is recommended in order to maintain the water-repellent properties. This should be used first after three years and then each year.

Rustproofing – inspection and maintenance

The car received a thorough and complete rustproofing at the factory. Parts of the body are made of galvanised sheet metal. The underbody is protected by a wear-resistant anti-corrosion compound. A thin, penetrating rustproofing fluid was sprayed into the exposed members, cavities, closed sections and side doors.

Under normal conditions the rustproofing does not require treatment for approximately 12 years. After this period, it should be treated at three-year intervals. Please contact an authorised Volvo workshop if the car needs further treatment.

Dirt and road salt can lead to corrosion so it is important to keep the car clean. The car's rustproofing needs to be checked regularly and touched-up if necessary in order for it to be maintained.



Cleaning the interior

Only use cleaning agents and car care products recommended by Volvo. Clean regularly and follow the instructions included with the car care product.

Stains on fabric upholstery and roof upholstery

A special fabric cleaning agent, available from authorised Volvo dealers, is recommended to avoid impairing the fire retardant qualities of the upholstery. Use water and a synthetic detergent to clean the seatbelts. Make sure the seatbelt is dry before allowing it to retract.

IMPORTANT

Sharp objects and Velcro may damage the fabric upholstery.

Treating stains on leather upholstery

Volvo leather upholstery is chromium-free and approved in accordance with the Öko-TEX 100 standard.

The leather is refined and processed so that it retains its natural characteristics. It is given a protective coating, but regular cleaning is required in order to maintain both characteristics and appearance. Volvo offers a comprehensive product for the cleaning and treatment of leather upholstery which, when

used in accordance with the instructions, preserves the leather's protective coating. After a period of use the natural appearance of the leather will nevertheless emerge, depending more or less on the surface texture of the leather. This is a natural maturing of the leather and shows that it is a natural product.

To achieve best results Volvo recommends cleaning and application of the protective cream once to four times per year (or more if required). Ask a Volvo dealer about Volvo's Leather care product.

IMPORTANT

Never use strong solvents. Such products may damage fabric, vinyl and leather upholstery.

IMPORTANT

Note that materials with colour that runs when dry (new jeans, suede garments etc.) may discolour the upholstery material.

Washing instructions for leather upholstery

1. Pour the leather cleaner on the dampened sponge and squeeze out a strong foam.
2. Work the dirt away with gentle circular movements.

3. Dab accurately with the sponge on the stains. Allow the sponge to absorb the stain. Do not rub.
4. Wipe off with soft paper or a cloth and allow the leather to dry completely.

Protective treatment of leather upholstery

1. Pour a small amount of the protective cream on the felted cloth and massage in a thin layer of cream with gentle circular movements on the leather.
2. Allow the leather to dry for 20 minutes before use.

The leather has now been given improved protection against stains and improved UV protection.

Treating stains on interior plastic, metal and wood parts

A fibrillated fibre or microfibre cloth, lightly moistened with water, available from Volvo dealers, is recommended for cleaning interior parts and surfaces.

Do not scrape or rub stains. Never use strong stain removers. A special cleaning agent available from Volvo dealers can be used for more difficult cleaning.

Carpets and cargo area

Remove inlaid carpets for separate cleaning of the floor carpet and the inlaid carpets. Use a vacuum cleaner to remove dust and dirt.



Car care

Touching up paintwork

Paint is an important part of the car's rust-proofing and should therefore be checked regularly. To avoid the onset of rust, damaged paintwork should be rectified immediately. The most common types of paintwork damage are stone chips, scratches, and stains on the edges of wings and doors.

Materials

- primer in a can
- paint in a can or touch-up pen
- brush
- masking tape

Colour code

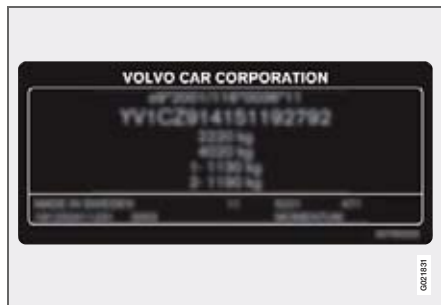

It is important that the exact correct colour is used. The product decal specifies the car's colour code, see page 221.

Repairing stone chips

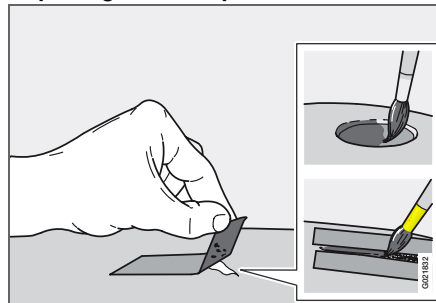

Before work is begun, the car must be clean and dry and at a temperature above 15 °C.

1. Apply a piece of masking tape over the damaged surface. Then remove the tape to remove any loose paint.
2. Stir the primer well and apply using a fine brush or a matchstick. Apply paint using a brush once the primer is dry.
3. For scratches, proceed as above, but mask around the damaged area to protect the undamaged paintwork.
4. After a few days, polish the touched-up areas. Use a soft rag and a small amount of lapping paste.



NOTE

If the stone chip has not penetrated to the bare metal and there is an undamaged colour coat, you can paint straight after cleaning the damaged surface.



Type designations

Decal location

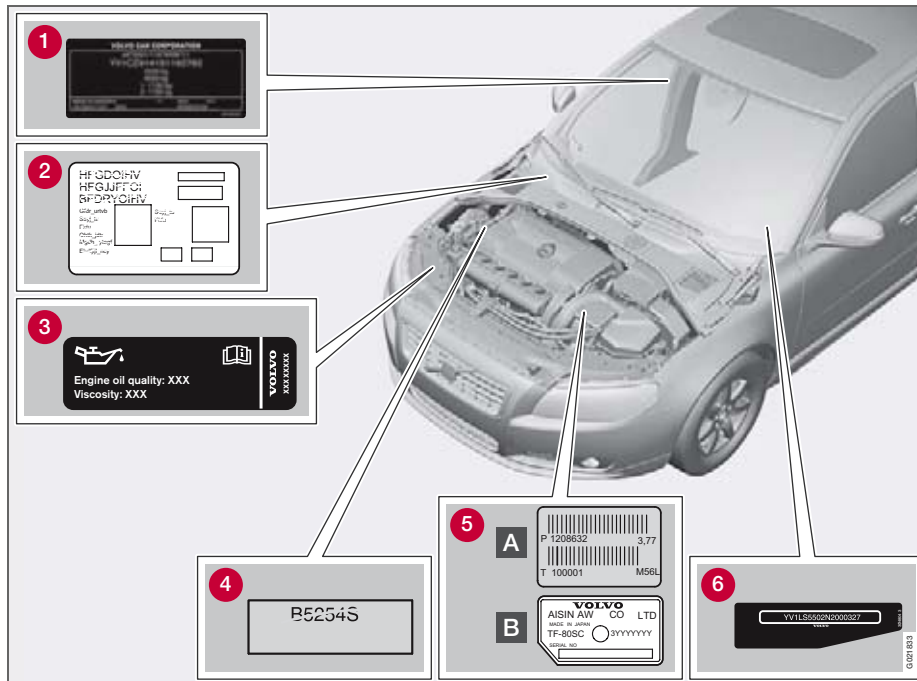

Knowing the car's type designation, vehicle identification and engine numbers can facilitate all contact with an authorised Volvo dealer regarding the car and when ordering spare parts and accessories.

- 1** Type designation, vehicle identification number, maximum permissible weights, codes for colour and upholstery and type approval number.
- 2** Decal for parking heater.
- 3** The engine oil decal specifies oil grade and viscosity.
- 4** Engine type designation, component and serial number.
- 5** Gearbox type designation and serial number.
 - A** Manual gearbox
 - B** Automatic gearbox
- 6** Car's identification number. (VIN Vehicle Identification Number)

Further information on the car is presented in the registration document.



Specifications

Dimensions V70

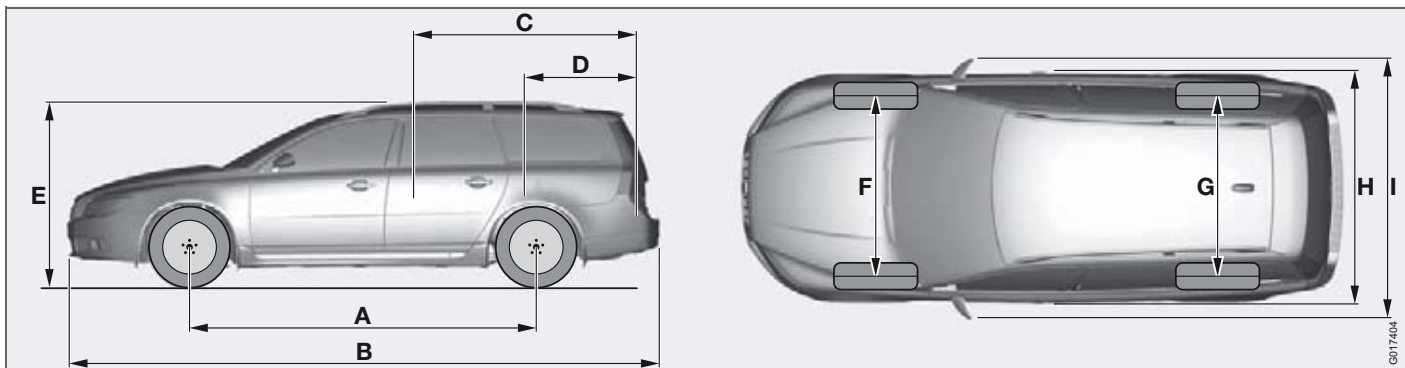

Position in illustration	Dimensions	mm
A	Wheelbase	2816
B	Height	4823
C	Load length, floor, folded seat	1878
D	Load length, floor	1089
E	Height	1547
F	Front track	1578
G	Rear track	1576
H	Width	1861
I	Width including door mirrors	2106



Specifications

Dimensions XC70

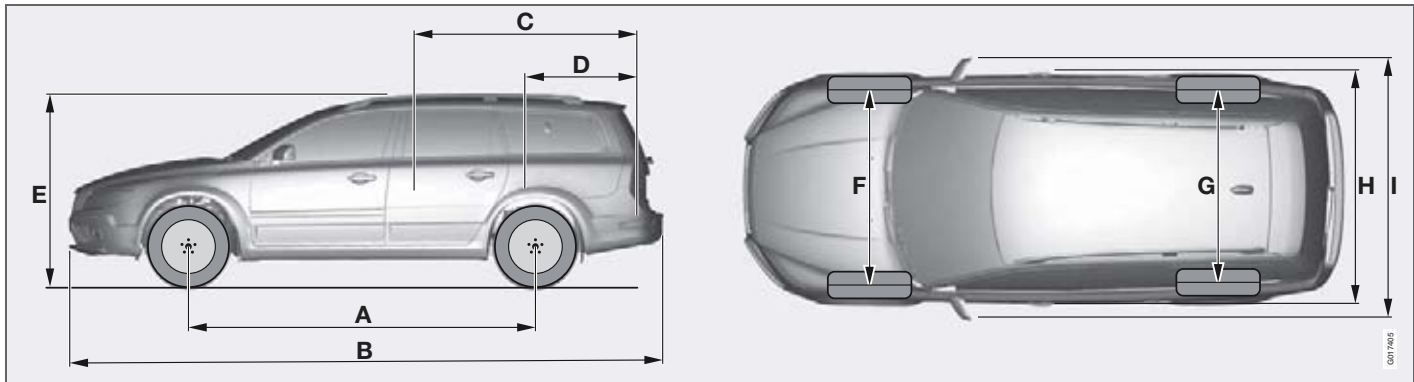

Position in illustration	Dimensions	mm
A	Wheelbase	2815
B	Height	4838
C	Load length, floor, folded seat	1878
D	Load length, floor	1089
E	Height	1604
F	Front track	1604
G	Rear track	1570
H	Width	1861
I	Width including door mirrors	2119



Specifications

Weights

Kerb weight includes the driver, the fuel tank 90% full and all fluids. The weight of passengers and accessories, such as a towbar, load carriers, space box etc. and towball load (when a trailer is hitched, see table), influences the payload and must not be included in the kerb weight. Permitted weight (in addition to driver) = Gross vehicle weight – Kerb weight.

- ❶ Gross vehicle weight
 - ❷ Max. train weight (car+trailer)
 - ❸ Max. front axle load
 - ❹ Max. rear axle load
 - ❺ Equipment level
- Max. load: See registration document.
Max. roof load: 100 kg.

⚠ WARNING

The car's driving characteristics change depending on how heavily it is loaded and how the load is distributed.

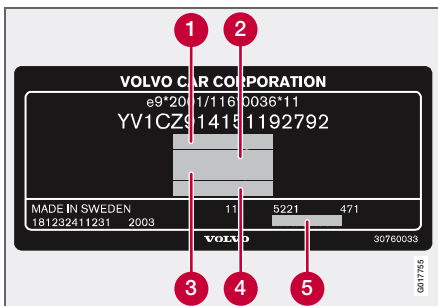

For information on decal location, see page 221.



Specifications

Towing capacity and towball load

Model	Gearbox	Trailer weight with brake (kg)	Towball load (kg)
All	All	0 – 1200	50
2.5T	Manual (M66)	max. 1800	75
	Automatic (TF-80SC)	max. 1800	75
3.2	Automatic (TF-80SC)	max. 1800	75
T6	Automatic (TF-80SC)	max. 2000	90
2.4D	Manual (M66)	max. 1600	75
	Automatic (TF-80SC)	max. 1800	75
D5	Manual (M66)	max. 1600	75
	Automatic (TF-80SC)	max. 2000	90

Trailer weight without brake (kg)	Towball load (kg)
max. 750	50



NOTE

The use of stabilising devices is recommended with trailers heavier than 1800 kg.



06 Maintenance and specifications

Specifications

Engine specifications

Specification/Model	2.5T	3.2	T6	D5	2.4D
Engine designation	B5254T6	B6324S	B6304T2	D5244T4	D5244T5
Output (kW/rpm)	147/4500	175/6200	210/xx	136/4000	120/4000
Output (hp/rpm)	200/4800	238/6200	285/xx	185/4000	163/4000
Torque (Nm/rpm)	300/1500-4500	320/3200	400/1500-xx	400/2000-2750	340/1750-2750
No. of cylinders	5	6	6	5	5
Bore (mm)	83	84	82	81	81
Stroke (mm)	93.2	96	93.2	93.1	93.1
Swept volume (litres)	2,521	3,192	2,953	2,400	2,400
Compression ratio	9.0:1	10.8:1	9.3:1	17.0:1	17.0:1



Engine oil

Adverse driving conditions

Adverse driving conditions can lead to abnormally high oil temperature or oil consumption.

Check the oil level more frequently for long journeys:

- towing a caravan or trailer.
- in mountainous regions.
- at high speeds.
- in temperatures colder than $-30\text{ }^{\circ}\text{C}$ or hotter than $+40\text{ }^{\circ}\text{C}$
- shorter driving distances (shorter than 10 km) at low temperatures (under $5\text{ }^{\circ}\text{C}$).

This can produce abnormally high oil temperature or oil consumption.

Choose a fully synthetic engine oil for adverse driving conditions. It provides extra protection for the engine.

Volvo recommends Castrol oil products.

! IMPORTANT

In order to fulfil the requirements for the engine's service intervals all engines are filled with a specially adapted synthetic engine oil at the factory. The choice of oil has been made very carefully with regard to service life, starting characteristics, fuel consumption and environmental impact. An approved engine oil must be used in order that the recommended service intervals can be applied. Only use a prescribed grade of oil (see the engine compartment decal) for both filling and oil change, otherwise you will risk affecting service life, starting characteristics, fuel consumption and environmental impact. Volvo Car Corporation disclaims all warranty liability if engine oil of the prescribed grade and viscosity is not used.

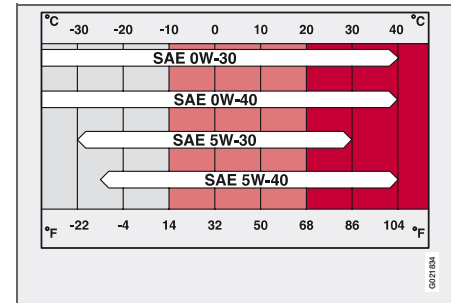

Viscosity chart



06 Maintenance and specifications

Specifications

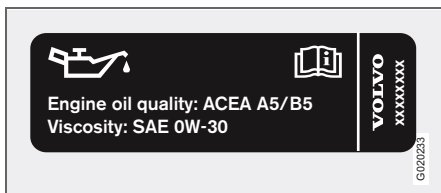

The following applies when the adjacent decal is fitted in the car's engine compartment. For information on decal location, see page 221.

Oil grade: ACEA A5/B5

Viscosity: SAE 0W-30

Engine variant		Volume between MIN and MAX (litres)	Volume (litres)
2.5T	B5254T6	1.3	5.5
3.2	B6324S	1.2	7.4
T6	B6304T2	1.2	7.4
D5	D5244T4	1.5	6.0
2.4D	D5244T5	1.5	6.0



Specifications

Other fluids and lubricants

Fluid	System	Volume (litres)	Prescribed grade
Gearbox oil	Manual (M66)	2.0	Transmission fluid MTF 97309
	Automatic (TF-80SC)	7.0	Transmission fluid JWS 3309
Coolant	Petrol engine 3.2	8.9	Coolant with corrosion inhibitor mixed with water, see packaging.
	Petrol engine 2.5T	9.0	
	Petrol engine T6	8.9	
	Diesel engine	12.5	
Air conditioning ¹	-	-	Oil: PAG Refrigerant: R134a (HFC134a)
Brake fluid		0.6	DOT 4+
Power steering		1.2	Power steering fluid WSS M2C204-A2 or equivalent product.
Washer fluid		6.5 4.5 ²	Use a washer antifreeze recommended by Volvo, mixed with water.

¹Varies depending on the engine variant. Contact an authorised Volvo workshop for the correct information.

²Cars without headlamp washing

i NOTE

Under normal driving conditions the gearbox oil does not need changing during its service life. However, it may be necessary under adverse driving conditions, see page 227.



Specifications

Consumption, emissions and volume

Model	Engine	Gearbox	Consumption litre/100 km	Emissions of carbon dioxide (CO ₂) g/km	Tank volume (litres)
2.5T	B5254T6	Manual (M66)	9.3	222	70
		Automatic (TF-80SC)	10.2	243	
3.2	B6324S	Automatic (TF-80SC)	10.5	251	
AWD		Automatic (TF-80SC)	11.4	272	
T6	B6304T2	Automatic (TF-80SC)	11.3	270	
D5	D5244T4	Manual (M66)	6.5	172	
		Automatic (TF-80SC)	7.4	195	
		Manual (M66) AWD	7.3	193	
		Automatic (TF-80SC) AWD	8.3	219	
2.4D	D5244T5	Manual (M66)	6.5	172	
		Automatic (TF-80SC)	7.4	195	

Fuel consumption and emissions of carbon dioxide

Official fuel consumption figures are based on a standard driving cycle in accordance with EU Directive 80/1268 comb. Fuel consumption is influenced if the car is equipped

with extra equipment that affects the car's weight. The manner in which the car is driven, and other non-technical factors also influence fuel consumption. For more information, see page 9.



Specifications

Electrical system

General

12 volt system with a voltage-regulated alternator. Single pole system in which the chassis and engine block are used as conductors. The negative terminal is connected to the chassis.

Performance, battery

Engine	2.5T	3.0T 3.2	D5 2.4D
Voltage (V)	12	12	12
Cold start capacity (A)	520 – 800	520 – 700	700
Reserve capacity (min)	100 – 150	100 – 135	135



IMPORTANT

If the battery is replaced, replace it with a battery of the same cold start capacity and reserve capacity as the original (see the decal on the battery).

Type approved remote control system

Country

A, B, CY, CZ,
D, DK, E, EST,
F, FIN, GB, GR,
H, I, IRL, L, LT,
LV, M, NL, P,
PL, S, SK, SLO



¹

IS, LI, N, CH

HR

ROK Delphi 2003-07-15, Germany R-LPD1-03-0151

BR

²

RC



CCAB06LP1940T4

¹Delphi hereby certifies that this remote control system conforms to the essential characteristic requirements and other relevant regulations of directive 1999/5/EC.

²Information not available at time of going to press.



06 Maintenance and specifications

06



A

-
- ABL – Active Bi-Xenon Lights 72
 - ABS 96
 - AC 114
 - ACC – Adaptive cruise control 136
 - Adapting driving characteristics 134
 - Adaptive cruise control 136
 - radar sensor 138
 - Additional heater 119
 - Adjusting headlamp pattern 76
 - Active Bi-Xenon headlamps 76
 - Bi-Xenon headlamps 76
 - Halogen headlamps 77
 - Adjusting the steering wheel 70
 - Adverse driving conditions 227
 - AF – automatic frequency update 129
 - Air conditioning 114
 - general 109
 - Air conditioning, AC 114
 - Air distribution 111, 116
 - Air quality system 115
 - Air vents 111
 - Airbag 15
 - deactivation/activation 18
 - AIRBAG system 14
 - Airbags
 - activating/deactivating, PACOS 19
 - Alarm 51
 - alarm indicator 51
 - alarm signals 52
 - arming 51
 - checking the alarm 40
 - deactivating a triggered alarm 51
 - disarming 51
 - other functions 52
 - RDS traffic warning 128
 - reduced alarm level 52
 - temporary disarming of the alarm 52
 - testing the alarm system 53
 - All Wheel Drive (AWD) 95
 - Allergy and asthma inducing substances 110
 - Anti-skid 133
 - Approach lighting 76
 - Audio
 - audio system 120
 - headphones socket 121
 - profile for seats 124
 - settings 123
 - source 123
 - surround 123
 - volume 123
 - volume, auto. volume control 123
 - volume, external audio source 123
 - volume, programme types 129
 - Audio files 124
 - Audio system 120
 - Audio volume
 - phone/media player 155
 - AUTO
 - climate control settings 114
 - preset storage 127
 - Auto. volume control 123
 - Automatic car washes 217
 - Automatic dimming 85
 - Automatic gearbox 92
 - manual gear positions (Geartronic) 93
 - Automatic locking 47
 - Automatic relocking 47
 - AUX 120, 123
 - volume 123

B

-
- Backrest
 - front seat, lowering 66
 - rear seat, lowering 69
 - Bass speaker 123
 - Battery 90, 197
 - handling 197
 - maintenance 197
 - remote control key/PCC 44
 - replacement 198

specifications	231	rear lamps	192	Child seats	26
warning symbols	197	side marker lamps	192	ISOFIX fixture system for child seats	31
Blind spot	146	vanity mirror	194	recommended	28
Blind Spot Information System, BLIS	146	C		size classes for child seats with the	
BLIS	146	Call waiting	154	ISOFIX fixture system	32
Brake and clutch fluid	188	Calls		two stage integrated booster cushion ...	29
Brakes	96	functions during a call	154	upper mounting points for child seats ..	34
anti-lock braking system, ABS	96	making and receiving	154	Cigarette lighter	
brake fluid, volume and grade	230	Car care	217	rear seat	151
brake lights	73	Car care, leather upholstery	219	Cigarette lighter socket	
brake system	96	Car upholstery	219	front seat	150
electric parking brake	98	Car wash	217	Clean Zone Interior	110
emergency brake assistance	96	Cargo area		Cleaning	
emergency brake assistance, EBA	96	cargo cover	171	automatic car washes	217
emergency brake light, EBL	73	safety grille	170	car wash	217
filling brake fluid	188	safety net	171	rims	217
symbols in the combined instrument		Cargo cover	171	seatbelts	219
panel	96	Catalytic converter	165	upholstery	219
Built-in phone	153	CD		Climate control	109
Bulbs, replacement	189	changer	124	general	109
cargo area lighting	194	functions	124	sensors	109
courtesy lighting	193	Chassis settings	134	Climate control system, electronic	112
dipped beam, halogen	190	Child		Clock	64
direction indicators	191	location in the car	26	Collision	25
extra main beam	191	Child safety locks	31, 50	Collision warning system	140
front fog lamps	192	Child safety products	26	radar sensor	138
main beam, halogen	190				
parking lamps	191				
position lamps	191				

Collision warning system with brake support*	140
Colour code, paint	220
Comfort inside the passenger compartment	149
Compass	132
adjusting the zone	132
calibration	132
Condensation	164
Condensation in headlamps	217
Coolant level	187
Cruise control	135

D

Deadlocks	49
deactivation	49
Decal - SIPS bag	21
Deep water	160
Defroster	114
Diesel filter	164
Diesel particle filter	89
Dimensions	222, 223
Dipped beam	190
Direction indicators	74
Disengaging the gear selector inhibitor	94
Display lighting	71

Dolby Surround Pro Logic II	120, 123
Door mirrors	84
Driving	
under adverse driving conditions	227
Driving in water	160
Driving with a trailer	174
towball load	225
towing weight	225
trailer weight	224
DSTC, see also Stability system	
deactivating/activating	133
operation	133

E

ECC –electronic climate control	112
Economical driving	160
Electric parking brake	
low battery voltage	98
releasing automatically	98
releasing manually	98
Electrical socket	
cargo area	152
front seat	151
rear seat	151
Electrical system	231
Electronic immobiliser	38
Emergency calls	157

Emergency equipment	
first aid kit	152
warning triangle	173
Emissions of carbon dioxide	230
Engine	
overheating	174
starting	88
Engine braking, automatic	97
Engine compartment	
bonnet	184
coolant	187
general	184
oil	186
overview	185
power steering fluid	188
Engine specifications	226
Environment	
clean air in the passenger compartment	8
efficient emission control	8
fuel consumption	8
reducing environmental impact	8
textile standard	8
Volvo Cars' environmental philosophy	8
Volvo workshops and the environment	8
EON –Enhanced Other Networks	129
Equalizer	124
External audio source	
AUX output	120

volume 123
 Extra main beam 191

F

Fan 113
 Fast-wind CD 125
 First aid equipment 173
 Floor mats 151
 Fluids
 capacities 229
 Fog lamp
 rear 74
 Fog lamps
 front 73
 Foot brake 96
 Four-C 134
 Frequency update, automatic 129
 Front fog lamps 73
 Fuel 164
 consumption 230
 fuel consumption 8
 fuel economy 216
 fuel filter 164
 Fuse box
 cargo area 204
 engine compartment 201
 glovebox 203

Fuses 200

G

Gear selector inhibitor 94
 Gear selector inhibitor, mechanical
 disengagement 94
 Gearbox 91
 automatic 92
 manual 91
 Geartronic 93
 Glass
 coating 82
 laminated/reinforced 82
 surface treated 82
 Global opening 39, 109
 Glovebox 150
 locking 48

H

Hazard warning flashers 74
 HBS –Heart Beat Sensor 41
 HDC 97
 Head restraint, centre seat 68
 Headlamp levelling 71
 Active Bi-Xenon headlamps 71
 Bi-Xenon headlamps 71
 Headlamp pattern, adjusting 76

Headlamp washing 81
 Headlamps 72, 189
 headlamp washing 81
 Headphones socket 121
 Heated washer nozzles 81
 Heating 114
 rear window 85
 seats 113
 High engine temperature 174
 High-pressure headlamp washing 81
 Hill Descent Control 97
 Home safe lighting 76
 Hoot 70
 Horn 70

I

IAQS –Interior Air Quality System 110
 IC –Inflatable Curtain 21
 IDIS –Intelligent Driver Information
 System 156
 Ignition positions 65
 Ignition switch 65
 IMEI number 156
 Immobiliser 38
 Important information 6
 Incoming calls 154

Indicator lamps, PCC	40	Keypad in the steering wheel	70	fog lamp, rear	74
Indicator symbols	60	right-hand side	120	front fog lamps	73
Indicators	74	L		headlamp levelling	71
Inflatable Curtain	21	<hr/>		home safe lighting	76
Information and warning symbols	60	Laminated glass	82	in the passenger compartment	75
Information button	40	Lamps		instrument lighting	71
Information displays	60	cargo area lighting	194	main/dipped beam	72
Instrument lighting	71	courtesy lighting	193	position/parking lamps	73
Instrument overview	56	dipped beam	190	replacing bulbs, see also Bulbs	189
Instruments and controls	56	direction indicators	191	Loading	166
Interior lighting	75	extra main beam	191	cargo area	166
Interior rearview mirror	85	front fog lamps	192	load retaining eyelets	167
ISOFIX fixture system for child seats	31	general	189	roof load	172
J		headlamps	189	Location of child seats	26
<hr/>		main beam	190	Locks	
Jump starting	90	number plate lighting	193	automatic locking	47
K		parking lamps	191	boot lid	47
<hr/>		position lamps	191	glovebox	47
Key	38	rear lamps	192	lock button on inside	47
keyless lock and ignition system	45	side marker lamps	192	locking	47
PCC	38	specifications	194	unlocking	47
remote control key	38	vanity mirror	194	Low oil level	186
Key blade	42	Leather upholstery, washing instructions	219	Lubricants	229
Keyless drive	45, 88	Light switches	71	M	
Keyless start (keyless drive)	88	Lighting		<hr/>	
Keylock	94	Active Bi-Xenon Lights, ABL	72	Main/dipped beam	72
		approach lighting	76	Maintenance	
		automatic	75	rustproofing	218
		control	75	Making calls	154

Manual gear positions (Geartronic)	93
Manual gearbox	91
Media player	123
Memory function in seats	67
Menus and messages	104
Messages in the combined instrument panel	107
Meters in the combined instrument panel ..	60
Mirror	
heated	85
interior	85
Mirrors	
door	84
Misting	
attending to the windows	109
condensation in headlamps	217
remove with the air vents	116
removing with defroster function	114
timer function	114
MP3 functions	124
MY KEY	121
N	
NEWS	128
News broadcast	128

O

Oil	
adverse driving conditions	227
capacities	228
engine oil	227
filter	186
gearbox oil	229
oil grade	227
power steering fluid	229
Oil level	186
Overheating	174

P

PACOS	19
switch	18
Paint	
colour code	220
Paintwork	
damage and touch-up	220
stone chips and scratches	220
Panel lighting	71
Panic function	40
Parking assistance	143
Parking heater	117
parking on a hill	117
time setting	118
Passenger compartment filter	110

PCC – Personal Car Communicator	
functions	39
range	41
Phone	153
built-in, overview	153
calling from the phone book	155
receiving a call	154
standby mode	153
Phonebook	
using numbers	155
PI seek	129
Polishing	218
Position/parking lamps	73
POT (Power Operated Tailgate)	167
Power steering fluid	188
Power sunroof	86
Power windows	82
Pregnancy	13
Preset storage	127
Programme functions	127
Programme type	128
PTY –Programme type	128
Putting calls on hold	154
R	
Radar sensor	138

Radio		Refrigerant	109	Safety grille	170
AF	129	Refuelling		Safety in the passenger compartment	12
EON	129	fuel cap	163	Safety mode	25
frequency update	129	fuel filler flap, electrical opening	163	Safety net	171
preset storage	127	Refuse calls	154	SCAN	
PTY	128	REG –Regional radio programmes	129	CD and audio files	125
radio text	129	Remote control key	38	radio stations	127
REG	129	battery	39	Seat	
settings	127	detachable key blade	38	power seat	66
stations	127	functions	39	Seatbelt reminder	13
Rain sensor	80	range	40	Seatbelts	12
Random, CD and audio files	125	replacing the battery	44	seatbelt tensioner	14
RDS functions	127	Remote control system, type approved ..	231	Seats	66
resetting	129	Remote control, see Remote control key ..	38	head restraints, rear	68
Reading the Owner's Manual	6	Resetting the door mirrors	84	heating	113
"Important" dialogue boxes	6	Resetting the power windows	83	key memory	67
"Warning" dialogue boxes	6	Retractable door mirrors	84	lowering the front backrest	66
message texts	6	Retractable power door mirrors	84	lowering the rear backrests	69
note dialogue boxes	6	Reverse gear inhibitor	91	manual setting	66
options	6	Rims		memory function	67
point lists	6	cleaning	217	power seats	66
position lists	6	RND –Random	125	ventilated front seats	112
procedure lists	6	Rustproofing	218	Service programme	184
Rear bulbs		S		Side airbags	20
location	193	Safety	12	Signal input, external	120
Recirculation	114			SIM card	157
Recommendations during driving	160			SIPS bags	20
Recovery	181				

Soot filter full	89	opening and closing	86	Track information	126
Spare wheel	209	sunscreen	87	Traction control	133
Specifications	224	ventilation position	86	Traffic information	128
Spin control	133	Surround	120, 123	Trailer	
SRS AIRBAG	15	Symbols	133	driving with a trailer	174
SRS system		indicator symbols	60	Transmission	91
general	16	information symbols	60	Trip computer	130
Stability and traction control system	133	warning symbols	60	Trip meter	64
Stability system	133	T		Type approved, remote control system ...	231
Stains	219	<hr/>		Type designations	221
Standby mode, phone	153	Tailgate		Tyres	
Starting the engine	88	locking	39, 48	direction of rotation	205
Station search	127	Tailgate, power operated opening	167	maintenance	207
Steering force level, speed adapted	134	Tank volume	230	pressure	215
Steering lock	88	Temperature		puncture	209
Steering wheel		actual temperature	109	specifications	214
keypad	153	Temperature control	114	speed ratings	214
keypad, adaptive cruise control	137	Testing the alarm system	53	tread wear indicators	207
keypad, left-hand side	135	Timer	114	winter tyres	208
right-hand keypad	120	Total airing function	39, 109	U	
steering wheel adjustment	70	Towball load	225	<hr/>	
Stone chips and scratches	220	Towbar	175	Unlocking	
Storage spaces in the passenger		Towing	181	from inside	47
compartment	149	towing eye	181	from outside	47
Sunroof		Towing bracket	175	keyless	47
blocking during automatic closing	86, 87	Towing weight	225	tailgate	47
		TP – traffic information	128		

V

Vanity mirror	194
Ventilation	111
Vibration damper	176
Volume, audio	123
Volume, see also Audio volume	123

W

Warning decal - SIPS bag	21
Warning lamp	
adaptive cruise control	136
collision warning system	141
stability and traction control system ..	133
Warning lamps	60
Airbags SRS	62
alternator not charging	62
fault in brake system	62
low oil pressure	62
parking brake applied	62
seatbelt reminder	62
warning	62
Warning sound	
adaptive cruise control	136
collision warning system	141
Warning symbol, AIRBAG system	14
Warning triangle	173

Washer	
headlamps	81
windscreen	81
Washer nozzles, heated	81
Washers	
washer fluid, filling	196
Washing the car	217
Water and dirt-repellent coating	82
Water-repellent surface, cleaning	218
Waxing	218
Weights	
front axle load	224
gross vehicle weight	224
kerb weight	224
maximum train weight	224
rear axle load	224
roof load	224
towball load	224
trailer weight	224
Wheels	
changing	205
fitting	206
rims	207
snow chains	208
spare wheel	209
Wheels and tyres	205
Whiplash injury	22
WHIPS	22

Windows, rearview and door mirrors	82
Windscreen washing	81
Windscreen wiper, rear	81
Windscreen wipers	80
Winter tyres	208
Wiper blades	
cleaning	195, 196
replacement	195
service position	195
Wipers and washing	80

Volvo. for life

VOLVO

Volvo Car Corporation TP 9686 (English), AT 0720, Printed in Sweden, Göteborg 2007, Copyright © 2000-2007 Volvo Car Corporation