

NOW YOU NEVER HAVE TO ASK...

WHO'S THERE?

# EASY SETUP

1



Mount the doorbell camera to an existing doorbell

2



Download the RCA Security App

3



Connect to Wi-Fi

4

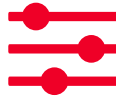

Customize your device settings

# WHAT YOU GET

WiFi doorbell camera with 1 faceplate installed

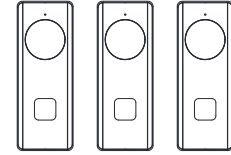
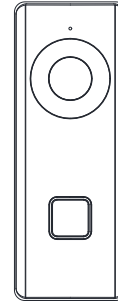

3 extra faceplate options

## Installation kit:

x2 Mounting screws

x2 Mounting anchors

x2 Set screws

x2 Wire nuts

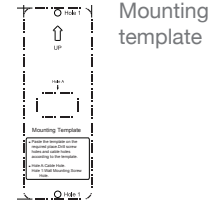

Mounting template

#1 Phillips-Head Screwdriver

Security screwdriver

x2 Wire leads

7/32" Masonry Drill Bit  
1/16" Wood Drill Bit

# TOOLS YOU'LL NEED

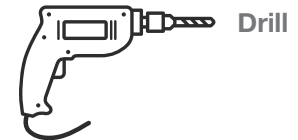

Drill



# MOUNT THE DOORBELL CAMERA

## 1 Turn off power to your doorbell's circuit

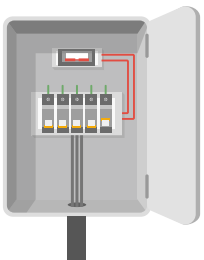

Find the breaker that controls the circuit for your doorbell. Turn it off before you continue installation.

## 2 Remove your existing doorbell

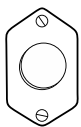

Remove & unhook

Carefully remove your existing doorbell from the wall. Then unhook your home's wiring from the doorbell's terminals.

## 3 Apply the mounting template sticker to the wall

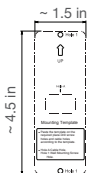

Apply

Align the space marked "Hole A" on the mounting template with the access point for the cables that will power the doorbell camera.

Stick the mounting template sticker to the wall.

## 4 Drill holes for the doorbell camera



Insert one of the drill bits in your drill—for masonry or brick, use the larger drill bit provided. For wood, the smaller.



Drill two holes where indicated by the mounting template.

## 5 Remove the faceplate from the doorbell camera



Before you mount it, take the faceplate off the doorbell camera—you'll need access to several items behind the faceplate during setup.

**To remove the faceplate:** Push down on the top and bottom of the doorbell camera and push the button and just below the camera to remove the doorbell camera from the faceplate. Be careful not to touch the camera lens!

*continues on the next page...*



# MOUNT THE DOORBELL CAMERA (continued)

## 6 Connect the doorbell camera to home power

Check if your home's doorbell power wires are long enough to connect directly to the terminals on the back of the doorbell camera.

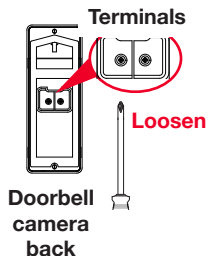

**If your home's doorbell power wires are long enough:**

Use the screwdriver provided in this package to loosen the terminal screws on the back of the doorbell camera.

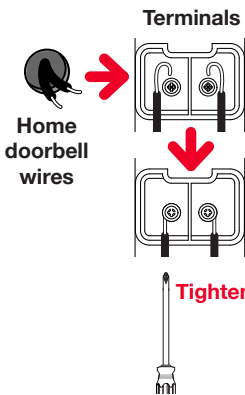

Connect the doorbell power wires directly to the terminals on the back of the doorbell camera. Loop each wire end around each terminal on the back of the doorbell camera. *Note: It doesn't matter which wire you put on which terminal.*

Tighten the screws to hold the wires firmly in place.

**IMPORTANT!** Handle the doorbell camera carefully! Make sure not to scratch its lens.

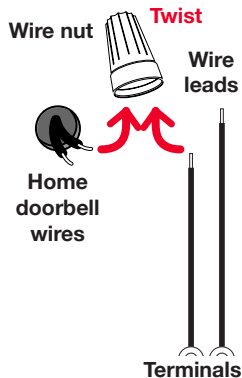

**If your home's doorbell power wires are NOT long enough:**

Use the wire leads and wire nuts included in this package to connect them to the doorbell camera.

First, put the ends of one wire lead and one home doorbell wire together and insert them into a wire nut. Then twist the wire nut until you feel tension. Repeat with the other wire lead, home doorbell wire, and wire nut.

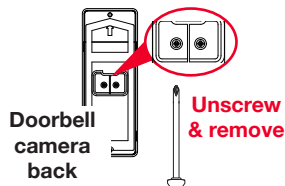

Next, unscrew the terminal screws on the back of the doorbell camera and remove them.

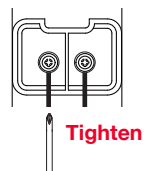

Place each screw through the ring on the other end of each wire lead, then screw the terminal screws back onto the doorbell camera.

## 7 Mount the doorbell camera to the wall

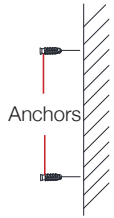

If you're mounting to masonry or brick, insert the provided anchors in the holes you drilled before proceeding.

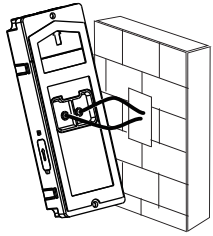

Route the power wires and/or wire leads into the wall.

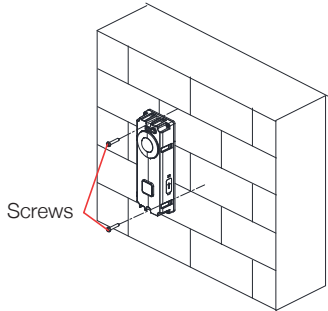

Align the holes on the doorbell camera's body with the holes you drilled.

Mount the doorbell camera to the wall using the screws provided.

## 8 Turn on power to your doorbell's circuit

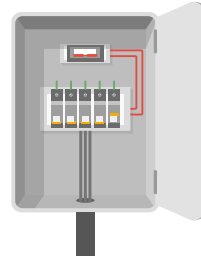

Turn the circuit that powers your doorbell back on. The doorbell camera's blue indicator light turns on.



**DOWNLOAD THE RCA  
SECURITY APP**

In the Google Play or Apple App Stores, search for "RCA DOORBELL CAMERA" and look for the icon shown here. Then download and install the App.



# CONNECT TO WIFI

## 1 Launch the App



Once the RCA Doorbell Camera App has installed on your smartphone or tablet, press the icon to launch the App.

**IMPORTANT:** The first time you launch it, the App will ask if it can send you notifications. Click “Allow” to let the App push notifications to your phone or tablet.

## 2 Create an App user name and password

The first time you launch the RCA Doorbell Camera App, you’ll need to create a user name and password so that you can access your camera securely.

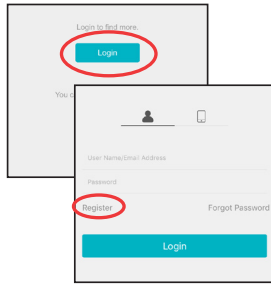

Press the Login button to start, then press Register on the screen that follows.

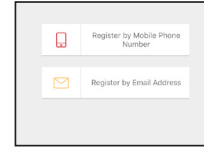

You can register by mobile phone number or by email. The App will send you a verification code to link this number or e-mail address with your account. Follow the steps in the App to proceed.

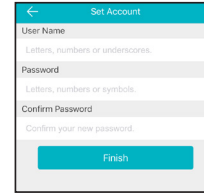

Create a user name and password and press Finish

## 3 Connect the camera with your WiFi network

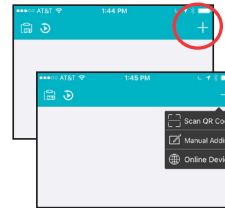

In the RCA Doorbell Camera App, tap the + symbol in the upper-right corner of the screen.

In the menu that pops up, choose “Scan QR Code.”



Find the QR code and serial number on the front of the doorbell camera. Scan the QR code with your phone when prompted by the App (or enter the serial number manually).

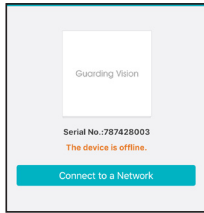

Once the App recognizes your doorbell's serial number, the App asks you to connect to your WiFi network. Tap the Connect to a Network button in the App.



Enter the name and password for the WiFi network your phone is connected to.

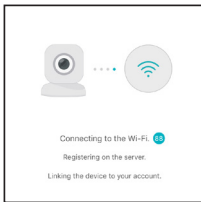

The App will connect the camera with your WiFi network, then register it with the RCA Doorbell Camera server for extra security.

## 4 Activate the camera

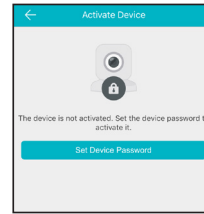

Once the doorbell camera has connected to your WiFi network, the Activation page appears in the App.

Press Set Device Password and create a password for using the doorbell camera.

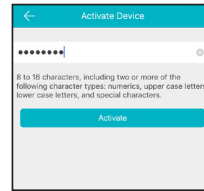

Then press Activate to finish activation.

**NOTE:** If you manually input the serial number for your doorbell camera (instead of scanning the QR code), you'll need to input a verification code as a last step to verification. Enter this code from the doorbell and press OK in the App to finish.

## Connection Troubleshooting

- + Make sure your phone or tablet is connected to the WiFi network you want to use.
- + Make sure the camera is getting a good signal from your WiFi router.
- + Test your WiFi network with other devices to make sure its working.
- + Double check that you've entered the correct password for your WiFi network in the App.
- + Make sure that Wi-Fi signal is 2.4GHz. The RCA Doorbell Camera does not support 5GHz WiFi.
- + Make sure that your WiFi router uses either WPA2-PSK/WPA-PSK or AES as its encryption method.
- + Make sure that there is no MAC filter on router or add MAC address to router whitelist.
- + Reset the camera to set up connection again. Press and hold RESET key for 15 seconds. The camera announces when it is fully reset (rebooting).

For additional assistance, please call 1-800-645-7750.

## CUSTOMIZE AND USE!

### 1 Install a faceplate

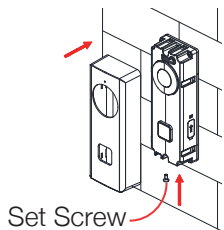

Choose the included faceplate that you want to use and place it over the doorbell camera's body. Insert one of the security screws into the bottom of the doorbell camera and screw it into place with the security screwdriver.

### 2 Choose the camera from the home screen

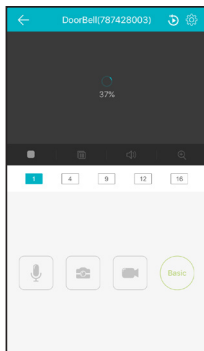
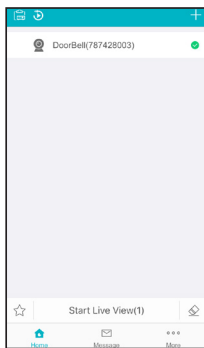

In the home screen for the RCA Doorbell Camera App, choose the camera you just activated, and press Start Live View at the bottom of the screen.

The Live View screen is your gateway to total control of your Doorbell Camera from virtually anywhere.

The next section gives you a tour of the features available from this screen.

## EVERYDAY USE

**Live View** Launch the RCA Doorbell Camera App and press Start Live View.

**Who's There? (Video Intercom)** When a visitor rings the doorbell, you get a push notification on your phone or tablet. Press the notification to go to the App, then press Start Live View get a live view from the doorbell camera. From the live view screen you can...

Talk to the visitor (press )

Take a snapshot of the visitor (press )

Record video (press )

**Set Automatic Motion Alerts** In the Live View screen, press  (**Settings**) to access the Settings menu. Then choose Alarm Notification and set it to Enabled. The doorbell camera will automatically record video on its pre-installed micro-SD card and send you a notification when it detects motion.

To see the video captured from any alarm messages, press the Messages icon at the bottom of the device list screen.

**Playback** In the App, choose a connected device and press  (**Micro-SD Card**) to play back any images or videos stored in that device's memory card.



# TOUR OF THE SYSTEM: LIVE VIEW SCREEN

 **(Back)** goes back to the device list screen.

 **(Micro-SD Card)** accesses any content stored on the camera's Micro-SD Card (pre-installed). Press this icon to start viewing or downloading motion/sound-activated videos or images from the camera's Micro-SD Card. (This is where you'll see auto recordings.)

 **(Settings)** accesses the Settings menu for this camera. Press this icon to adjust the time and date settings, turn motion alarms on or off, adjust camera speaker and microphone volume, check storage status and the version of the device's software, and see a settings overview for the device.

**Camera view** shows you the image from your Doorbell Camera. Turn your phone/tablet sideways to take over the entire screen.

 **(Stop)** and  **(Pause)** stops/starts or pauses the live video.

 **(Sound On/Off)** turns the sound from the camera on and off.

 **(Zoom)** zooms in on the live view.

 **(Talk)** lets you speak through this camera's built-in speaker. Press and hold this icon to start speaking.

 **(Snapshot)** takes a still photo of the camera video. The snapshot file is saved to your smartphone or tablet.

 **(Record)** starts/stops recording video. The video file is saved to your smartphone or tablet.

 **(HD-SD Select)** lets you switch between high- and standard-definition video on the view screen.

**1 / 4 / 9 / 12 / 16 (Multi-Camera View)** lets you see multiple cameras at once on a single screen (if you've set up multiple cameras). Press the number you want to access a multi-camera view screen.

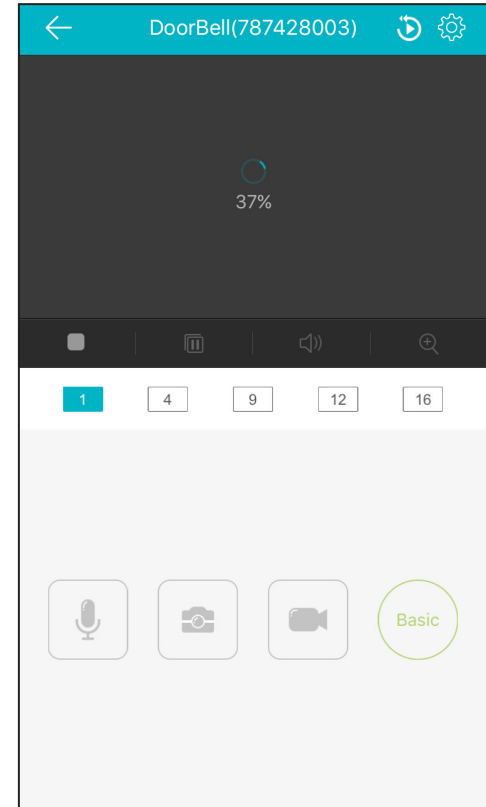

# TOUR OF THE DOORBELL CAMERA

## FRONT AND BOTTOM

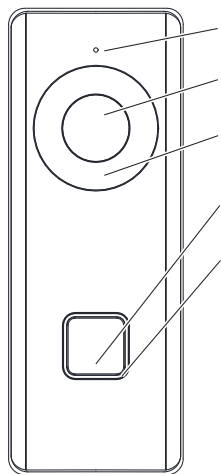

**Mic** captures audio around the doorbell.

**Lens** captures video in front of the doorbell.

**IR light (behind panel)** activates automatically for night vision.

**Call button** sounds the doorbell.

**Indicator light** shows the camera status:

*Solid blue* when starting up and working normally

*Flashing blue and red* when WiFi is not connected

*Flashing red* when the doorbell camera is updating its firmware

*Flashing blue* when the doorbell camera is calling the App

*Off* when the doorbell camera is communicating with the App

**Speaker (bottom, not shown)** broadcasts your voice when talkback is activated.

## BACK

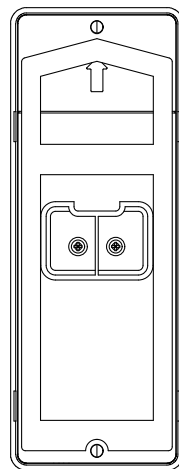

**Screw terminals 1 and 2** connect to the power source from your home.

**RESET button (left side)** restores the doorbell camera to factory settings (hold for 15 seconds).

**Micro SD card slot (right side, not shown)** holds the micro SD card that comes with your doorbell camera.

## Removing/Replacing the SD Card

Your doorbell camera comes with an SD card pre-installed, for recording alerts. To remove or replace this card, you'll first need to remove the doorbell camera's faceplate by unlocking its set screw and pressing on its bottom and top and pulling it off. Then use the included set screw tool to gently pry the bottom of the SD card slot (on the right side) open. Press the installed SD card to unlock it and pull it out. Place the new SD card in and lock it into place. Then place the SD card cover back on and put the doorbell camera's faceplate over the doorbell camera. Finally, insert the set screw and screw it back in place.

## FCC Information

Please take attention that changes or modification not expressly approved by the party responsible for compliance could void the user's authority to operate the equipment.

**FCC compliance:** This equipment has been tested and found to comply with the limits for a Class B digital device, pursuant to part 15 of the FCC Rules. These limits are designed to provide reasonable protection against harmful interference in a residential installation. This equipment generates, uses and can radiate radio frequency energy and, if not installed and used in accordance with the instructions, may cause harmful interference to radio communications. However, there is no guarantee that interference will not occur in a particular installation. If this equipment does cause harmful interference to radio or television reception, which can be determined by turning the equipment off and on, the user is encouraged to try to correct the interference by one or more of the following measures:

- Reorient or relocate the receiving antenna.
- Increase the separation between the equipment and receiver.
- Connect the equipment into an outlet on a circuit different from that to which the receiver is connected.
- Consult the dealer or an experienced radio/TV technician for help.

This equipment should be installed and operated with a minimum distance 20cm between the radiator and your body.

## FCC Conditions

This device complies with part 15 of the FCC Rules. Operation is subject to the following two conditions:

1. This device may not cause harmful interference.
2. This device must accept any interference received, including interference that may cause undesired operation.

## Industry Canada ICES-003 Compliance

This device meets the CAN ICES-3 (B)/NMB-3(B) standards requirements.

This device complies with Industry Canada licence-exempt RSS standard(s). Operation is subject to the following two conditions:

- (1) this device may not cause interference, and
- (2) this device must accept any interference, including interference that may cause undesired operation of the device.

Le présent appareil est conforme aux CNR d'Industrie Canada applicables aux appareils radio exempts de licence. L'exploitation est autorisée aux deux conditions suivantes :

- (1) l'appareil ne doit pas produire de brouillage, et
- (2) l'utilisateur de l'appareil doit accepter tout brouillage radioélectrique subi, même si le brouillage est susceptible d'en compromettre le fonctionnement.

Under Industry Canada regulations, this radio transmitter may only operate using an antenna of a type and maximum (or lesser) gain approved for the transmitter by Industry Canada. To reduce potential radio interference to other users, the antenna type and its gain should be so chosen that the equivalent isotropically radiated power (e.i.r.p.) is not more than that necessary for successful communication.

Conformément à la réglementation d'Industrie Canada, le présent émetteur radio peut fonctionner avec une antenne d'un type et d'un gain maximal (ou inférieur) approuvé pour l'émetteur par Industrie Canada. Dans le but de réduire les risques de brouillage radioélectrique à l'intention des autres utilisateurs, il faut choisir le type d'antenne et son gain de sorte que la puissance isotrope rayonnée équivalente (p.i.r.e.) ne dépasse pas l'intensité nécessaire à l'établissement d'une communication satisfaisante.

This equipment should be installed and operated with a minimum distance 20cm between the radiator and your body.

Cet équipement doit être installé et utilisé à une distance minimale de 20 cm entre le radiateur et votre corps.

## Symbol Conventions

The symbols that may be found in this document are defined as follows.

Provides additional information to emphasize or supplement important points of the main text.

Indicates a potentially hazardous situation, which if not avoided, could result in equipment damage, data loss, performance degradation, or unexpected results.

Indicates a hazard with a high level of risk, which if not avoided, will result in death or serious injury.



## WARNING

- The working temperature of the device is from -30° C to 50° C .
- All the electronic operation should be strictly compliance with the electrical safety regulations, fire prevention regulations and other related regulations in your local region.
- Please use the power adapter, which is provided by normal company. The



## NOTE

power consumption cannot be less than the required value.



## WARNING

- Do not connect several devices to one power adapter as adapter overload may cause over-heat or fire hazard.
- Please make sure that the power has been disconnected before you wire, install or dismantle the device.



## DANGER

- When the product is installed on wall, the device shall

be firmly fixed.

- If smoke, odors or noise rise from the device, turn off the power at once and unplug the power cable, and then please contact the service center.
- If the product does not work properly, please contact your dealer or the nearest service center. Never attempt to disassemble the device yourself. (We shall not assume any responsibility for problems caused by unauthorized repair or maintenance.)
- Do not drop the device or subject it to physical shock, and do not expose it to high electromagnetism radiation. Avoid the equipment installation on vibrations surface or places subject to shock (ignorance can cause equipment damage).
- Do not place the device in extremely hot (refer to the specification of the device for the detailed operating temperature), cold, dusty or damp locations, and do not expose it to high electromagnetic radiation.
- The device cover hall be kept from rain and moisture.
- Exposing the equipment to direct sun light, low ventilation or heat source such as heater or radiator is forbidden (ignorance can cause fire danger).
- Do not aim the device at the sun or extra bright places. A blooming or smear may occur otherwise (which is not a malfunction however), and affecting the endurance of sensor at the same time.
- Please use the provided glove when open up the device cover, avoid direct contact with the device cover, because the acidic sweat of the fingers may erode the surface coating of the device cover.
- Please use a soft and dry cloth when clean inside and outside surfaces of the device cover, do not use alkaline detergents.
- Please keep all wrappers after unpack them for future use. In case of any failure occurred, you need to return the device to the factory with the original wrapper. Transportation without the original wrapper may result in damage on the device and lead to additional costs.
- Please connect a resistor (included in the box content) to the doorbell if no electrical chime or mechanical chime is connected.



## NOTE

Make sure the power voltage across the doorbell should be between 16 VAC and 24 VAC.

- The power supply must conform to LPS. The recommended adaptor models and manufacturers are shown as below. Use the attached adapter, and do not change the adaptor randomly.

Model	Manufacturer
MKAC-57-242500M	MACABLE
MKAC-57-242200M	MACABLE
MKAC-57-241500M	MACABLE

## Legal Disclaimer

TO THE MAXIMUM EXTENT PERMITTED BY APPLICABLE LAW, THE PRODUCT DESCRIBED, WITH ITS HARDWARE, SOFTWARE AND FIRMWARE, IS PROVIDED "AS IS", WITH ALL FAULTS AND ERRORS, AND VOXX MAKES NO WARRANTIES, EXPRESS OR IMPLIED, INCLUDING WITHOUT LIMITATION, MERCHANTABILITY, SATISFACTORY QUALITY, FITNESS FOR A PARTICULAR PURPOSE, AND NON-INFRINGEMENT OF THIRD PARTY. IN NO EVENT WILL VOXX, ITS DIRECTORS, OFFICERS, EMPLOYEES, OR AGENTS BE LIABLE TO YOU FOR ANY SPECIAL, CONSEQUENTIAL, INCIDENTAL, OR INDIRECT DAMAGES, INCLUDING, AMONG OTHERS, DAMAGES FOR LOSS OF BUSINESS PROFITS, BUSINESS INTERRUPTION, OR LOSS OF DATA OR DOCUMENTATION, IN CONNECTION WITH THE USE OF THIS PRODUCT, EVEN IF VOXX HAS BEEN ADVISED OF THE POSSIBILITY OF SUCH DAMAGES. REGARDING TO THE PRODUCT WITH INTERNET ACCESS, THE USE OF PRODUCT SHALL BE WHOLLY AT YOUR OWN RISKS. VOXX SHALL NOT TAKE ANY RESPONSIBILITIES FOR ABNORMAL OPERATION, PRIVACY LEAKAGE OR OTHER DAMAGES RESULTING FROM CYBER ATTACK, HACKER ATTACK, VIRUS INSPECTION, OR OTHER INTERNET SECURITY RISKS; HOWEVER, VOXX WILL PROVIDE TIMELY TECHNICAL SUPPORT IF REQUIRED. SURVEILLANCE LAWS VARY BY JURISDICTION. PLEASE CHECK ALL RELEVANT LAWS IN YOUR JURISDICTION BEFORE USING THIS PRODUCT IN ORDER TO ENSURE THAT YOUR USE CONFORMS THE APPLICABLE LAW. VOXX SHALL NOT BE LIABLE IN THE EVENT THAT THIS PRODUCT IS USED WITH ILLEGITIMATE PURPOSES.

IN THE EVENT OF ANY CONFLICTS BETWEEN THIS MANUAL AND THE APPLICABLE LAW, THE LATER PREVAILS.

## 12-Month Limited Warranty

Voxx Accessories Corporation (the "Company") warrants to the original retail purchaser of this product that should this product or any part thereof, under normal use and conditions, be proven defective in material or workmanship within 12 months from the date of original purchase, such defect(s) will be repaired or replaced with new or reconditioned product (at the Company's option) without charge for parts and repair labor. To obtain repair or replacement within the terms of the warranty, the product is to be delivered with proof of warranty coverage (e.g. dated bill of sale), specification of defect(s), transportation prepaid, to an approved warranty station. For the location of the nearest warranty station to you, call toll-free to our control office: 1-844-393-7338.

This Warranty is not transferable and does not cover product purchased, serviced or used outside the United States or Canada. The warranty does not extend to the elimination of externally generated static, noise, or loss of range or audio/video quality due to external factors, to costs incurred for the installation, removal or reinstallation of the product, or to damage to digital media devices or memory. The warranty does not apply to any product or part thereof which, in the opinion of the company, has suffered or been damaged through alteration, improper installation, mishandling, misuse, neglect, accident or exposure to moisture. This warranty does not apply to damage caused by an AC adapter not provided with the product or by removal or defacement of factory serial number/barcode labels.

THE EXTENT OF THE COMPANY'S LIABILITY UNDER THIS WARRANTY IS LIMITED TO THE REPAIR OR REPLACEMENT PROVIDED ABOVE AND, IN NO EVENT, SHALL THE COMPANY'S LIABILITY EXCEED THE PURCHASE PRICE PAID BY PURCHASER FOR THE PRODUCT.

This Warranty is in lieu of all other express warranties or liabilities. ANY IMPLIED WARRANTIES, INCLUDING ANY IMPLIED WARRANTY OF MERCHANTABILITY OR FITNESS FOR A PARTICULAR PURPOSE, SHALL BE LIMITED TO DURATION OF THIS WARRANTY. ANY ACTION FOR BREACH OF ANY WARRANTY HEREUNDER, INCLUDING ANY IMPLIED WARRANTY, MUST BE BROUGHT WITHIN A PERIOD OF 24 MONTHS FROM THE DATE OF ORIGINAL PURCHASE. IN NO CASE SHALL THE COMPANY BE LIABLE FOR ANY CONSEQUENTIAL OR INCIDENTAL DAMAGES WHATSOEVER. No person or representative is authorized to assume for the Company any liability other than expressed herein in connection with the sale of this product.

Some states/provinces do not allow limitations on how long an implied warranty lasts or the exclusion or limitation of incidental or consequential damage so the above limitations or exclusions may not apply to you. This Warranty gives you specific legal rights and you may also have other rights which vary from state/province to state/province.