

vtech[®]
Innovation Beyond Technology[™]

User's manual

www.vtechphones.com



Models:
mi6885/mi6889

5.8
GHz
DIGITAL

Table of contents

Getting started	5	Redial	19
Parts checklist for mi6885	5	Mute	20
Parts checklist for mi6889	6	Intercom	20
Installation	7	Call forward	21
Choose a location	7	Call transfer	21
Install handset battery	7	Conference call	22
Connect power to telephone base/handset chargers	8	Find handset	22
Connect to phone line	8	Voice mail	22
Check battery indicator	9	Directory	23
Check for dial tone	9	Store a new entry	23
If you subscribe to DSL service	10	Characters by number	24
Belt clip	10	Review and dial entries	24
Wall mounting	11	Edit a directory entry	25
Registration	12	Delete a directory entry	25
Register a handset	12	Caller ID	26
De-register all handsets	13	Caller ID - call waiting ID	26
Handset layout	14	Review caller ID	27
Telephone base layout	15	Store caller ID in your directory	27
Telephone settings	16	Dial from caller ID	29
Handset icons	16	Delete a caller ID record	29
Handset lights	16	Answering system operation	30
Telephone base display	16	Turn your answering system on and off	30
Handset main menu	17	Day and time announcements	30
Handset operation	19	To check day and time	31
Making calls	19	Outgoing announcement	32
Answering calls	19	Record outgoing announcement	32
Flash function	19	Menu features	32
Handset volume	19	Listen to outgoing announcement	33

Table of contents

Delete outgoing announcement	33	Warranty	52
Message playback	33	Important safety instructions	53
Announcements	34	FCC, ACTA and IC regulations	56
Options during playback	34	The RBRC® seal	56
Delete all messages	34	Technical specifications	57
Record and play memos	34	Index	58
Record a memo	35		
Play back a memo	35		
Call screening	35		
Remote access	35		
Set the remote access code	36		
Remote answering system operation	36		
Message alert	38		
Announcement only mode	39		
Turn the announcement only mode on or off	39		
Customize the announcement only message	39		
Base ringer	40		
Number of rings	40		
Message window display	41		
Headset operation	42		
Headset jack	42		
Operating range	42		
Batteries	43		
Battery care and performance	43		
Replace the handset battery	43		
Troubleshooting	44		
Additional information	45		
Maintenance	52		

Congratulations

on purchasing your new VTech product.

Before using this telephone, please read the

Important safety instructions

on page 54 of this manual.

This manual has all the feature operations and troubleshooting necessary to install and operate your new VTech telephone. Please review this manual thoroughly to ensure proper installation and operation of this innovative and feature rich VTech product. For support, shopping, and everything new at VTech, visit our website at www.vtechphones.com. In Canada, please visit www.vtechcanada.com.

Getting started

Parts checklist for mi6885

1. Telephone base
2. Handsets (3)
3. Charger power adapters (2)
4. Chargers (2)
5. Telephone line cord
6. Belt clips (3)
7. Batteries (3)
8. Quick start guide
9. Base power adapter
10. Wall mount bracket
11. User's manual

To purchase replacement batteries, visit us on the web at www.vtechphones.com or call VTech Communications, Inc. at 1-800-595-9511. In Canada, contact VTech Telecommunications Canada Ltd. at www.vtechcanada.com or 1-800-267-7377.

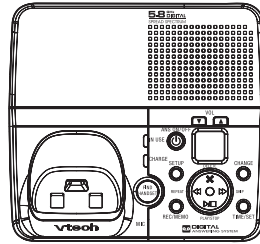

1. Telephone base



2. Handsets (3)

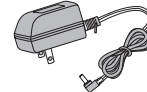

3. Charger power adapters (2)



4. Chargers (2)

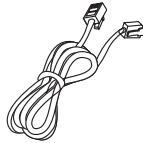

5. Telephone line cord



6. Belt clips (3)



7. Batteries (3)



8. Quick start guide

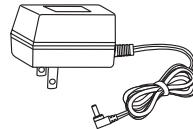

9. Base power adapter



10. Wall mount bracket



11. User's manual

note

- Important! Before using this telephone, Please read **Important safety instructions** on pages 53-54.

note

- Important! Before using this telephone, Please read **Important safety instructions** on pages 53-54.

Getting started

Parts checklist for mi6889

1. Telephone base
2. Handsets (4)
3. Charger power adapters (3)
4. Chargers (3)
5. Telephone line cord
6. Belt clips (4)
7. Batteries (4)
8. Quick start guide
9. Base power adapter
10. Wall mount bracket
11. User's manual

To purchase replacement batteries, visit us on the web at www.vtechphones.com or call VTech Communications, Inc. at 1-800-595-9511. In Canada, contact VTech Telecommunications Canada Ltd. at www.vtechcanada.com or 1-800-267-7377.

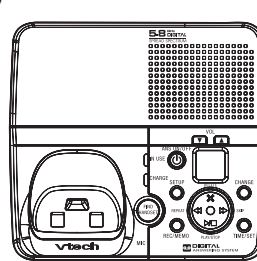

1. Telephone base



2. Handsets (4)

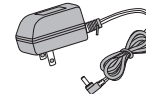

3. Charger power adapters (3)



4. Chargers (3)

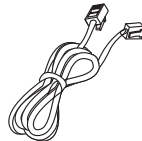

5. Telephone line cord



6. Belt clips (4)

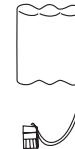

7. Batteries (4)

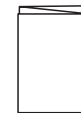

8. Quick start guide

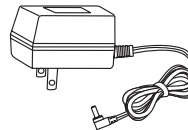

9. Base power adapter

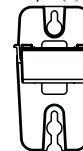

10. Wall mount bracket



11. User's manual

Installation

Choose a location

For optimum performance of your cordless telephone system:

1. Choose a central location for your telephone base.
2. Install your phone(s) as far away as possible from any other cordless (wireless) devices such as cordless telephones, 802.11 wireless routers (for example, WiFi), etc.
3. Install your phone(s) as far away as possible from other electronic equipment such as microwave ovens, televisions, computers, etc.
4. Install your telephone equipment away from heat sources and direct sunlight.
5. Avoid excessive moisture, dust or extreme cold.

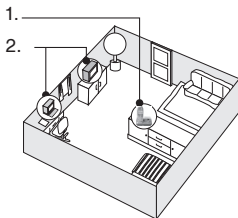

Install handset battery

1. Align the two holes in the plug with the socket pins, then snap the plug into place.
2. Place the battery in the compartment with the wires in the upper left corner.
3. Replace cover by sliding it upwards until it clicks into place.
4. Be sure to charge the battery in the handset for a minimum of 16 hours before using your phone.

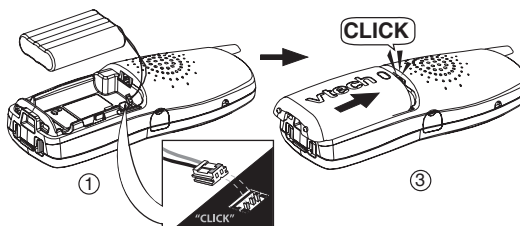

note

- Use only the provided VTech battery, or equivalent. To obtain a replacement battery, visit our website at www.vtechphones.com or call 1 (800) 595-9511.
- Place the handset in its telephone base when not in use to ensure optimum performance.
- If you need to install your phone within the same room as other cordless phones or wireless products, you may need to select a different channel for your router and/or change the channel on your phone's handsets.

note

- If the battery has not been charged, place the handset in the telephone base, and allow it to charge for at least 16 hours.
- Use only the VTech power supply provided with your telephone. To obtain a replacement, visit our website at www.vtechphones.com or call 1 (800) 595-9511.
- This power unit is intended to be correctly orientated in a vertical or floor mount position. The prongs are not designed to hold the plug in place if it is plugged into a ceiling, under-the-table or cabinet outlet.

Installation

Connect power to telephone base/handset chargers

1. Plug the power adapter into an electrical outlet not controlled by a wall switch, and the connector into the power jack on bottom of the telephone base.
2. Choose the location for your charger, and plug its power supply into an electrical outlet.

Telephone outlet



AC power outlet

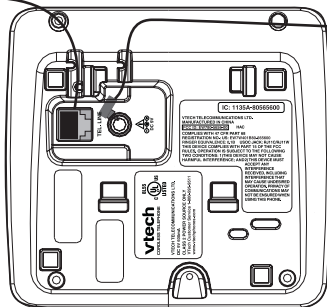

AC power outlet

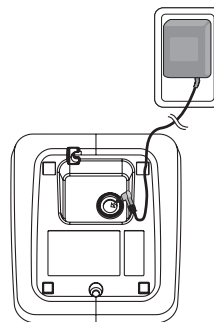

Connect to phone line

Plug one end of the telephone line cord into the telephone line jack at the bottom of the telephone base. Then plug the other end of the cord into the wall telephone outlet.

Installation

Check battery indicator

If you see **WARNING CHECK BATTERY!** on the handset display, it indicates one of the following:

1. There is no battery in your handset. You need to install the supplied battery into your handset (see **Install handset battery**)
2. The battery needs to be replaced.
3. The battery has been installed incorrectly. Please reinstall (see **Install handset battery**) and/or see the diagram in the battery compartment of the handset.

When in **LOW BATTERY** mode, the keypad sounds, backlighting and speakerphone features do not work. When the battery has been charged, these features will return to their normal function.

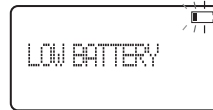

Check for dial tone

After the battery is charged, press **TALK**  on the handset. You should hear a dial tone. If not, see **Troubleshooting**.

note

- If the phone will not be used for a long period of time, remove the battery to prevent possible leakage.
- If you have any trouble installing your phone, please refer to the **Troubleshooting** section near the end of this manual.

Installation

If you subscribe to DSL service (optional)

If you receive high speed internet through your telephone line (commonly referred to as DSL), and you are experiencing interference during conversations, and/or your caller ID features are not functioning properly, and you subscribe to DSL service from your telephone company, install a DSL filter to the telephone line between the telephone base and the telephone line jack. Contact your DSL provider to obtain a DSL filter.

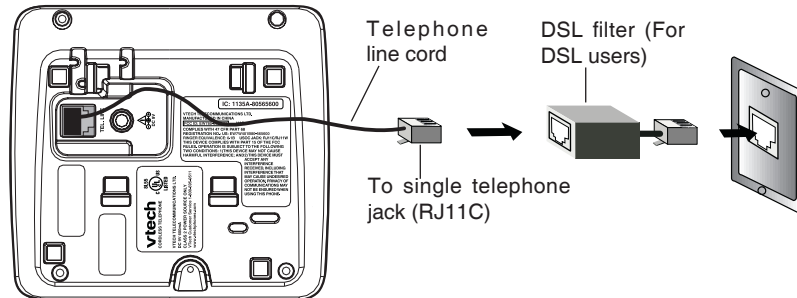

Belt clip (optional)

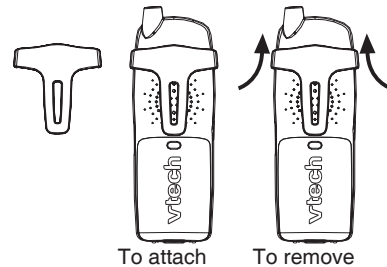

Wall mounting (optional)

The wall mount brackets are designed for use on standard wall mount plates only.

1. Follow the instructions on page 8 to connect the power to telephone base and phone line.
2. Line up the tabs on the wall mount adapter with the holes at the bottom of the telephone base. Snap the wall mount bracket firmly in place.
3. Mount the telephone base on the wall. Position the telephone base so that the mounting studs fit into the holes on the wall mount bracket. Slide telephone base down on the mounting studs until it locks into place.

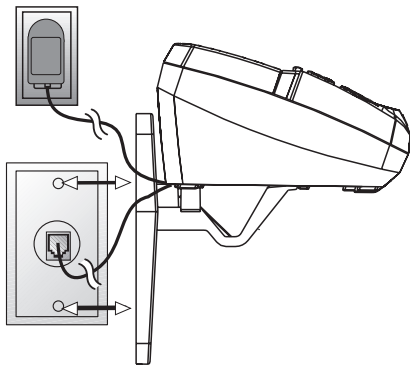

note

- When first purchased you need to charge your handsets for at least five minutes before registering to telephone base.
- The handset number is used as the extension number.
- If the registration is not successful lift all handsets out of the telephone base or charger and place them back in the telephone base or charger. Try the registration process again.

Registration

The **mi6889** comes with four registered handset (named **Handset 1, 2, 3, 4**).

Additional handsets (**mi6807**) are available from your local authorized dealers or from our website at www.vtechphones.com in the US, or www.vtechcanada.com in Canada.

Up to four extension handsets can be registered with the same telephone base, and two can be in operation at the same time. Each additional handset purchased will have to be registered separately following the instruction which comes with the optional handset.

Register a handset

When first purchased, all accessory handsets show **NOT REGISTERED** on the screen. To register a handset:

1. Place the handset in a telephone base or charger that is connected to a power outlet. If **PRESS FIND HNDST 4 SEC ON BASE** does not appear on the screen after a few seconds, lift up handset and place in base or charger again.
2. On the telephone base:
 - **Press and hold FIND HANDSET** for four seconds.
 - Release **FIND HANDSET** once the **IN USE** light comes on.

NOT REGISTERED

PRESS FIND HNDST
4 SEC ON BASE

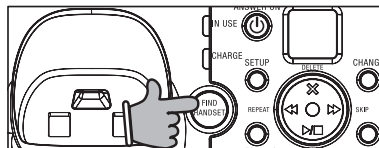

Four
seconds later:

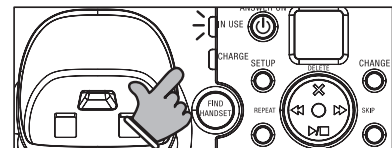

Registration

After a while the handset will emit series of tones, the newly registered handset will be assigned the lowest extension number not previously assigned to another system handset (1-4) when successfully registered. Repeat steps 1 and 2 if handset does not successfully register to the telephone base within two minutes.

If you are replacing a handset on a system that has the maximum number of registered handsets or wish to change the assigned handset number of your registered handsets, you must first de-register the handsets, then re-register all handsets.

De-register all handsets

1. Press and hold **FIND HANDSET** on the main telephone base for 10 seconds.
2. When the **IN USE** light starts to flash, release the **FIND HANDSET** button.
3. Press and release **FIND HANDSET** again. The **IN USE** light will turn off and in a few seconds, all handsets will be de-registered.
4. All handsets will show **NOT REGISTERED**.



NOT REGISTERED

note

- If the de-register process does not work you may need to reset the system and try again. To reset: pick up the handset and press **TALK** . Press the **OFF** button and place the handset back into the telephone base.

Handset layout

1. Earpiece
2. Caller ID/scroll down
3. Headset jack (2.5mm)
4. Talk/flash
5. Dial keys (0-9, *, #)
6. Redial/pause
7. Mute/remove
8. Display
9. Select/menu
10. Phonebook/scroll up
11. Volume control
12. Off/clear
13. Speaker
14. Intercom

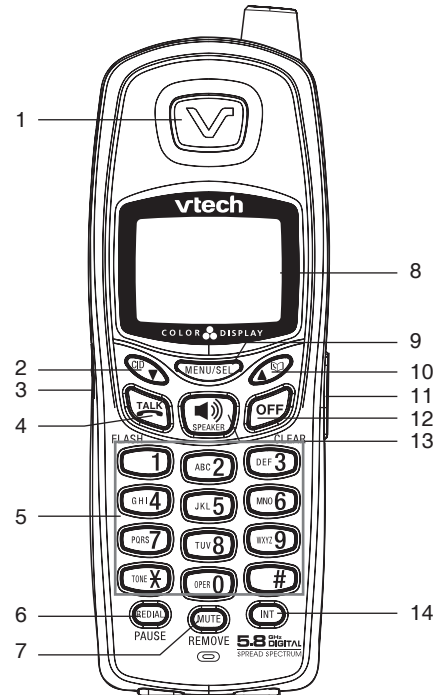



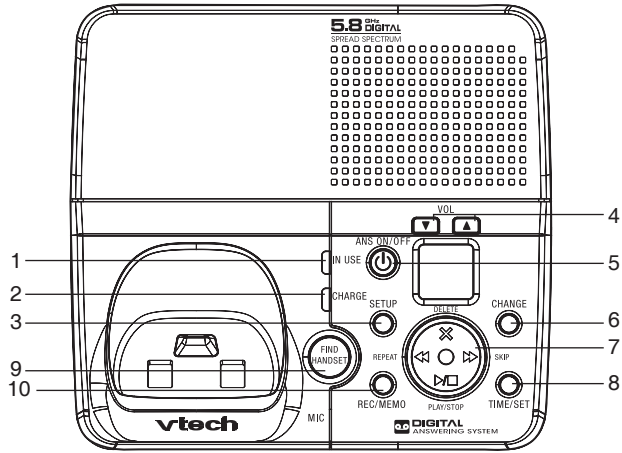

Telephone base layout

- 1. In use indicator
- 2. Charge indicator
- 3. Setup
- 4. Volume control
- 5. Answer on/off
- 6. Change
- 7. Delete/skip/play/stop/repeat
- 8. Time/set
- 9. Find handset
- 10. Record/memo



Telephone settings

Handset icons

Icon	Description
	<ul style="list-style-type: none">The microphone is muted.
NEW	<ul style="list-style-type: none">Displayed when viewing a missed call that has not been reviewed.
	<ul style="list-style-type: none">The handset ringer is off.
	<ul style="list-style-type: none">Low battery indicator or charging indicator.
	<ul style="list-style-type: none">Flashes to indicate that there are new voicemail messages. (Service must be subscribed from your telephone company.)
	<ul style="list-style-type: none">Displayed when using a headset with your handset.

Handset lights

Light	Description
	<ul style="list-style-type: none">On when handset speakerphone is in use.

Telephone base display

Light	Description
IN USE	<ul style="list-style-type: none">On when the phone is being used.Flashes when an extension phone is being used.
CHARGE	<ul style="list-style-type: none">On when the handset is charging in the base.
ANS ON/OFF	<ul style="list-style-type: none">On when the answering system is on.

Telephone settings

Handset main menu



Enter the main menu options on the handset by pressing **MENU**. Press ▼ or ▲ to select from the six menu items described below.

Directory (📄)

Enter and retrieve up to 50 names and telephone numbers.

Call log (📄)

Review caller ID data, select and dial from the caller ID data.

Settings (⚙️)

Change the language of the menu prompts, set dial type and time, clear voicemail.

Sounds (🔊)

Select ringer tone, turn key tone on or off.

Display (🖥️)

Choose from the five preset images used as wallpaper or adjust the screen contrast.

Ringer volume (🔊)

Adjust ringer volume or turn ringer off.

Press ▼ or ▲ to reach the desired menu option, then press **MENU/SEL** to select.

note

- When the telephone is ringing, press **OFF** to temporarily mute the ringer.

Telephone settings

SETTINGS (📞)

With this icon highlighted, press **MENU**, then press ▼ or ▲ to select from the following menu options:

LANGUAGE – This option allows you to change the screen prompts to English, Espanol or Francais.

DIAL TYPE - This option allows you to select tone or pulse dial.

CLOCK SETTING - This option allows you to adjust the time displayed on the idle screen.

CLR VOICE MAIL - This option allows you to turn the voicemail indicator off.

SOUNDS (🔊)

RINGER MELODY - This option allows you to select one of the 10 (0-9) different ringer tones for incoming calls.

KEY TONE - This option allows you to turn the key tone on or off.

DISPLAY (🖼️)

WALLPAPER - This option allows you to set a wallpaper image. Select **WALLPAPER** in the main menu, then press ▼ or ▲ to view the five available images. Once you have selected the image, press **SEL** and you will hear a confirmation tone.

CONTRAST - This option allows you to adjust the handset screen contrast.

RINGER VOLUME (🔊)

This option allows you to adjust the ringer volume or turn the ringer off.

Handset operation

Making calls

- Press **TALK** (or **SPEAKER** to use the handset speakerphone feature), then dial the phone number.
-OR-
Dial the phone number first, then press **TALK** (or **SPEAKER**).
- To end your call, press **OFF** or place the handset in the base or charger.

Answering calls

- Press **TALK**, **SPEAKER** or any dialing keys.
- To end your call, press **OFF** or place the handset in its telephone base or charger.

Flash function

You can use your phone with services such as call waiting.

When you subscribe to call waiting service from your telephone company, press **TALK/FLASH** to switch to the new call when you receive a call waiting signal. Press **TALK/FLASH** again to switch back to the original call.

Handset volume

The volume control is on the right side of the handset. During a call, press the **VOL ▲** or **VOL ▼** keys to adjust the listening volume to a comfortable level. When you reach the maximum or minimum setting, a double beep will sound. (Follow these instructions to change the volume for the handset, speakerphone or headset.)

Redial

- When the handset is idle, press **REDIAL/PAUSE** to display the last five telephone numbers dialed from the handset (up to 32 digits for each number). Use **▲** or **▼** to scroll through the last five numbers dialed. When the beginning or the end of the redial list is reached, a double beep will sound.

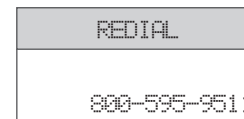
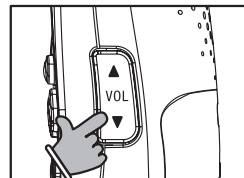
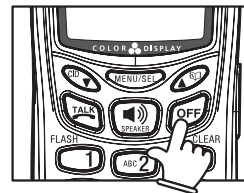
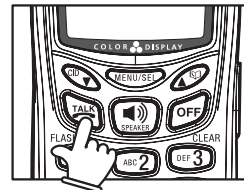

note

- The procedure to change the volume is the same for the handset earpiece, speakerphone and headset.

note

- If the redial memory is empty, and **REDIAL** is pressed, a double beep will sound.
- If the forward call is not answered in about 30 seconds, the external call will be returned to the originating handset.

Handset operation

- Press **TALK** or **SPEAKER** to dial the displayed number.
- Press **REMOVE** to erase the displayed number. You'll hear a confirmation beep.
- Press **OFF** to exit.

Mute

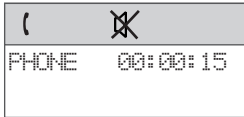
- During a call, press **MUTE** to disable the microphone. You will not be heard but you will be able to hear the other person. The screen will briefly display **MUTED**:

- Press **MUTE** again to return to normal two-way conversation. **MICROPHONE ON** will display briefly.

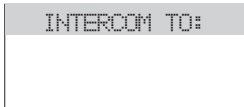
Intercom

- When not on a call, press **INT**. The first handset (HS1) will display:

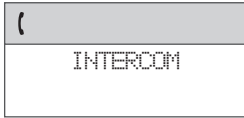
- Press the number of the handset to be called using the dial keys (1-4).

- The second handset (HS2) will ring and the screen will display:

- Press **TALK**, **SPEAKER**, **INT** or any dialing key on HS2 to answer the intercom call. The screen will display:

Handset operation

- To end the call, press **INT** or **OFF** on either handset, or place the handset back in its telephone base.

If the called handset is out of range or on an external call, when paged, the display of the calling handset will show:

Call forward

An external call can be forwarded or transferred from one handset to another.

- If you are on an external call (HS1), you can forward the call to another handset (HS2) by pressing and holding **INT**. HS1 will show **FORWARD TO** and you should input the number of the desired handset.
- HS2 will show **INCOMING CALL** and start ringing
- Press **TALK** on the HS2 to answer.

If the forwarded call is not answered within 30 seconds, the external call will be returned to HS1 and the display will show **CALL BACK**, and ring for 30 seconds. If the returned call is not answered within 30 seconds, the external call will end automatically.

Call transfer

- While on an external call, a handset (HS1) can transfer the call to another system handset (HS2) by pressing **INT**. The external call is put on hold automatically.
- Select the destination handset number (1-4).
- HS1 shows **CALLING HANDSET 2 (HS2)**.
- HS2 can pick up the transferred call when it rings and the screen shows **HANDSET 1 IS CALLING**.



INTERCOM ENDED



UNABLE TO CALL
TRY AGAIN



FORWARD TO:



CALL BACK

Handset operation

- HS2 can pick up the transferred call by pressing **TALK**, **SPEAKER** or **INT**.
- An intercom call is now established (the external call is still on hold) and HS1 and HS2 are able to talk to each other. HS1 or HS2 can hang up, and conversation with the external call can be resumed. **CALL TRANSFERRED** is briefly displayed on HS1.

If the transferred call is not answered within 100 seconds, the intercom attempt will be automatically ended and the external call will return to the original party.

Conference call

It is possible to establish a conference call between two handsets and the external line.

If one handset is already connected to the external line, the other can join the conversation by pressing **TALK**, a conference call will be established immediately. Both handsets will show:

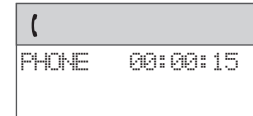

Find handset

At the telephone base, press **FIND HANDSET** to page the handset up to 60 seconds.

- When the handset is not being used, press **FIND HANDSET**.
- To turn off the signal at the handset, press **TALK**, **SPEAKER** or any dial pad key (0-9, *, #) on the handset, or press **FIND HANDSET** at the base. Press **OFF** to turn off the page.

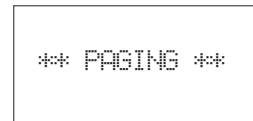

Voice mail

If you subscribe to voice mail service provided by your telephone company, you can receive voice mail messages from callers. When you have a new voice mail, the screen will display **NEW VOICE MAIL**, and the voice mail indicator will flash.

On how to access your voice mail, contact your local telephone company for further instruction.

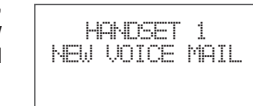

Directory

Your phone can store up to 50 entries (numbers with names) in memory. Each memory location can hold up to 32 digits for the number and 16 characters for the name. Only one handset can access the directory at a time. If a second handset attempts to reach the directory, **NOT AVAILABLE AT THIS TIME** will be displayed on the second handset.

Store a new entry

- Press **MENU/SEL** on the handset.
- With **DIRECTORY** highlighted, press **SEL**.
- Press **▼** to select **STORE**. Press **SEL**.
- You will be prompted to **ENTER NUMBER**. Use the dialing keys to enter the number to be stored in the directory. Press **MUTE/REMOVE** to backspace and make corrections. Press **SEL** when you are done entering the phone number.
- You will then be prompted to **ENTER NAME**. Use the dialing keys to spell the name (see the next page). Press **SEL**.
- A confirmation tone will sound, and the new directory entry will briefly be displayed.

If the directory is full, the handset will display **LIST FULL**.

If you wish to store a number from redial memory into the directory, press **REDIAL/PAUSE** then **▲** or **▼** to scroll to the desired redial number from memory. Press **SEL**.

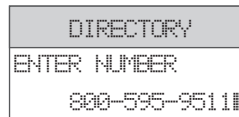

note

- All handsets share a common directory, stored in the base. Entries entered into one handset are available at all handsets, and if a directory entry is deleted, it will disappear from all handsets.
- While entering numbers, press and hold **REDIAL/PAUSE** to add pauses if necessary.
- If there is a duplicated number in the directory, the display will show: **ALREADY SAVED**.

Directory

Characters by number

Pressing any particular key causes different characters to be displayed in the following order:

Key	Characters by number of key presses								
	1	2	3	4	5	6	7	8	9
1	1	#	'	,	-	.	&		
2	A	B	C	2	a	b	c		
3	D	E	F	3	d	e	f		
4	G	H	I	4	g	h	i		
5	J	K	L	5	j	k	l		
6	M	N	O	6	m	n	o		
7	P	Q	R	S	7	p	q	r	s
8	T	U	V	8	t	u	v		
9	W	X	Y	Z	9	w	x	y	z
0	0								
*	*	?	!	/	()	@		
#									

Directory

Review and dial entries

- Press **MENU**, with **DIRECTORY** highlighted, press **SEL**. With **REVIEW** in the first line, press **SEL**.
- OR-

With the handset in idle, press **▲** to enter the directory. The first directory entry will be displayed.

- Scroll through the directory entries using **▲** and **▼** or enter the first character of the name to be searched (using the digit keys). Continue pressing the **▲** or **▼** scroll keys, until you reach the entry to be dialed.
- Press **TALK** or **SPEAKER** to dial the number.



Edit a directory entry

- Follow the steps in **Review and dial entries** (above) to reach the entry you wish to edit.
- Press **SEL** to enter number edit mode.
- Press and release **MUTE/REMOVE** to backspace, then press the digit keys to correct the number. Press and hold **REDIAL/PAUSE** to add pauses if necessary.
- Press **SEL**.
- Press **MUTE/REMOVE** to backspace and use the digit keys to enter the correct name.
- Press **SEL**. A confirmation tone will sound.

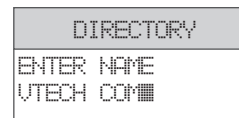
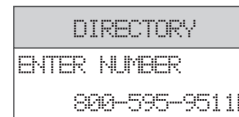

Delete a directory entry

- Follow the steps in **Review and dial entries** (page 24) to reach the entry to be deleted.
- Press **MUTE/REMOVE** to delete the entry. A confirmation tone will sound.
- The handset will then advance to the next entry, if any.

note

- When reviewing the directory, the second line of the display will show the phone number, up to 16 digits. For numbers longer than 16 digits, only the first 13 digits will be shown. Press ***** or **#** to scroll the phone number to see the additional digits.
- If there are no entries in the directory when it is accessed, **DIRECTORY EMPTY** will display.

note

- Due to regional incompatibilities, CID information may not be available for every incoming call. In addition, the calling parties may intentionally block their names and/or phone numbers from being sent.
- These are subscription services provided by most regional telephone service providers. You must subscribe to these services to enjoy the benefits of these features. If you do not subscribe to caller ID services, you can still use your phone and the other features it offers.

Caller ID

Caller ID - call waiting ID

Your phone is capable of displaying the number of the caller before the call is answered (caller ID or CID). If the number is already in the directory, the name of the caller will also be displayed. Your phone can hold up to 50 caller ID entries.

- The handset display informs you when there are calls that have not been answered by a system handset. These are missed calls. If you answer a call before the information appears on the screen, it will not be in the caller ID log.
- After all missed caller ID records are reviewed, the screen will show:
- The **NEW** icon in the lower left corner indicates the call has not yet been reviewed.



HANDSET 1
5 MISSED CALLS



HANDSET 1

Your phone can also display the name and number of the call waiting caller (call waiting caller ID), so you can decide whether to answer the incoming call, or continue with the current conversation.

Caller ID

Review caller ID

You can enter caller ID review mode by pressing ▼ when the handset is idle, the handset will enter caller id review mode. Or:

- With the handset idle (off), press **MENU**.
- Press ▲ to scroll to **CALL LOG**.
- Press **SEL**. Use ▲ and ▼ to scroll through the call log entries. When the beginning or the end of the call log is reached, a double beep will sound.
- If the call log is full, the oldest entry is deleted to make room for the new call. If the call log is empty, the following message is displayed when you try to review caller ID records:

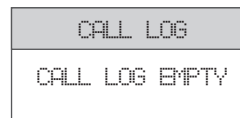

Store caller ID in your directory

- Follow the steps in **Review caller ID** (above) to find the record to be stored.
- The phone number in the caller ID log was sent by the phone company. You may have to dial the number differently. Press the # key repeatedly to see the different dialing options. You can add or remove the initial 1 and/or the area code. The various dialing options are:
- Press **SEL** to store the displayed number.
- If the caller ID record contains both name and number, the name and number will be stored after pressing **SEL**.
- If the record does not contain a name, you will be prompted to **EDIT NAME** and the screen will show:

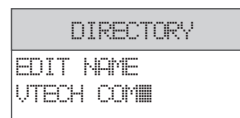

note

- Press **OFF** any time to exit the caller ID log.
- All handsets share a common caller ID log, stored in the base. If a call log entry is deleted, it will disappear from all handsets.

Caller ID

- If the caller ID record does not contain a number, you will be prompted to **EDIT NUMBER**, and the screen will show:
- After the entry has a name and number, press **MENU/SEL** to save. A confirmation beep will sound and the screen will display:
- If both the name and number are missing, for example, as in a private listing, nothing will be stored, and the screen will display:
- If the number already exists in the directory, the entry will not be stored, and the screen will show:
- If the directory is full, the screen will show:

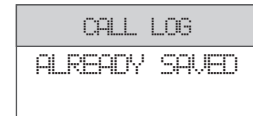
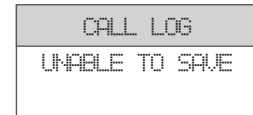

note

- When your answering system is powered off, you can still play your messages and change the answering system settings.

Answering system

Your cordless telephone system provides you with leading edge digital technology with an answering system that can record up to 99 messages, or approximately 15 minutes of recording time. Each message can be up to four minutes.

Turn your answering system on and off

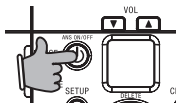

Press **ANS ON/OFF** on the base to turn the answering system on or off. When the system is on, **ANS ON/OFF** will light up, the system will answer calls, and incoming messages can be recorded.

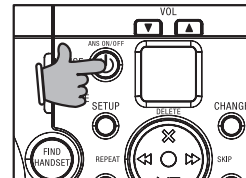

Day and time announcements

To set day and time



Before playing each recorded message, the answering system announces the day and time the message was received. Set the day and time by pressing **TIME/SET** twice. You can change settings by pressing **CHANGE**, and you can advance to the next type of setting by pressing **TIME/SET** again. See the following page for detailed instructions.

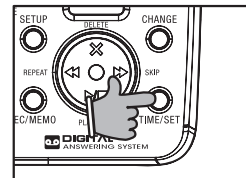

Answering system

Before using the answering system, you should follow the steps below to set the day and time, so messages are dated correctly. Each time you press the **CHANGE** button on the telephone base, the day, hour, minute, or year increases by one. When you hear the correct setting, press **TIME/SET** to move to the next setting. Pressing and holding the **CHANGE** button when setting the day and time will increase the minute or year by increments of 10.

1. Press **TIME/SET**, the system announces the current setting.
2. Press **TIME/SET** again.
3. The answering system will announce the current day setting. Press **CHANGE** on the base until you hear the correct day.
4. Press **TIME/SET**, the system announces the current hour setting.
5. Press **CHANGE** until you hear the correct hour.
6. Press **TIME/SET**, the system announces current minute setting.
7. Press **CHANGE** until you hear the correct minute.
8. Press **TIME/SET**, the system announces the current year setting.
9. Press **CHANGE** until you hear the correct year.
10. Press **TIME/SET** to confirm. The system announces the new time and day setting followed by a confirmation beep.

To check day and time

Press **TIME/SET** at any time and the system will announce the current setting without changing it.

note

- If you have caller ID service, the time will automatically be updated whenever caller ID information is delivered. However, since the date, rather than the day, is delivered, you have to program the year once, so the system can determine the day of the week.

Answering system

Menu features

System announces	Description
Announcements	Outgoing message to tell callers to leave a message.
Remote access code	Set code to access remotely from a touch tone phone.
Message alert	Beeps every 10 seconds when there are new messages.
Announcement only, record no message	Outgoing message only. No recording of incoming messages.
Base ringer	Turn base ringer on or off.
Number of rings	Change the number of times the system rings before it answers a call, (2, 4, 6 or toll saver).

Outgoing announcement

Your answering system is pre-set with an announcements for normal (answer and record) mode and announcement only mode. If the phone is set up to record messages, the phone answers calls with *“Hello. Please leave a message after the tone.”* You can use this announcement, or replace it with your own.

Record outgoing announcement

1. Press **SETUP**, the system announces *“Announcement. Press **PLAY** or press **RECORD**. To continue set up, press **SETUP**.”*
2. Press **REC/MEMO**. After you hear *“Record after the tone. Press **STOP** when you are done,”* speak toward the **MIC** to record an announcement for up to 90 seconds.
3. The elapsed time (in seconds) is shown in the message window when recording.

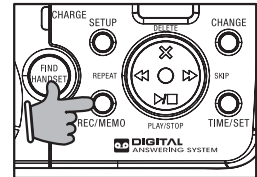

Answering system

4. Press **PLAY/STOP** ►/■ when you have finished recording. The system will play back your recorded message and then save it.

Listen to outgoing announcement

1. Press **SETUP**.
2. Press **PLAY/STOP** ►/■.

Delete outgoing announcement



1. Press **SETUP**.
2. Press **PLAY/STOP** ►/■ to begin playback.
3. During playback, press **DELETE X** to delete your announcement.
4. The system will confirm deletion and announce *“Announcement deleted.”*

When your announcement is deleted, calls will be answered with the programmed announcement *“Hello. Please leave a message after the tone.”*

Message playback

Press **PLAY/STOP** ►/■ to listen to new messages. The system will announce the number of new messages recorded and then play them. If there are no new messages, all old messages will be played.

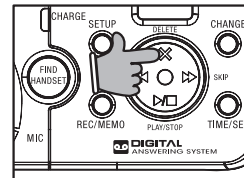
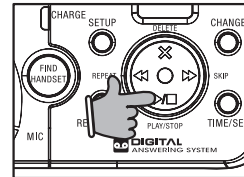

Answering system

Announcements

1. When playback begins, you will hear the total number of messages.
2. Before each message, you will hear the day and time it was received.
3. After the last message, you will hear “*End of messages.*”
4. If the system has less than five minutes of recording time left, the time remaining will also be announced.

Options during playback

1. Press ▲ or ▼ to adjust the speaker volume.
2. Press **SKIP** ►► to skip to the next message, or press and hold to speed up message playback.
3. Press **REPEAT** ◀◀ to repeat the message currently playing. Press twice to listen to the previous message, or press and hold to slow down message playback.
4. Press **DELETE** X to delete the message currently playing.
5. Press **PLAY/STOP** ►/■ to stop playback.

Delete all messages

To delete all old messages, press and hold **DELETE** X while the phone is idle (not during a call or during message playback). New messages (which have not yet been reviewed) will not be deleted.

Record and play memos

Memos are messages recorded by you or other household members intended for yourself or anyone else who uses the answering system. They are saved, played back, and deleted like incoming messages from other callers.

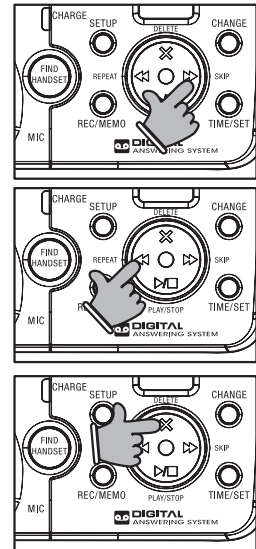

Answering system

Record a memo

1. Press **REC/MEMO**.
2. The system will announce "Record after the tone. Press **STOP** when you are done."
3. Speak toward the **MIC** to record a memo for up to four minutes.
4. The timer shows the elapsed time (in seconds) in the message window when you are recording.
5. When finished recording, press **PLAY/STOP** ►/■ to save the memo. The system announces "Recorded" to confirm.

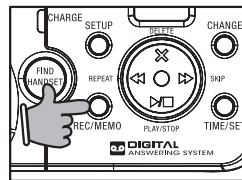

Play back a memo

See **Message playback** (page 35) about retrieving memos.

Call screening

If you wish to listen to caller's leaving their message before choosing to answer a call:

1. Set the playback **VOL** on the base to a level greater than one by pressing ▲ or ▼ to adjust the message playback volume.
2. If you decide to answer a call while the caller is leaving a message, simply press **TALK/FLASH** on the handset. The answering system will stop recording.

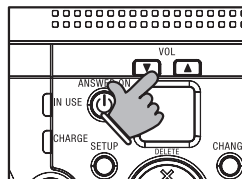

Remote access

To retrieve new messages from any touch tone phone from a remote location, a two digit access code is required. The remote access code can be any two digit number between 10 and 99. The remote access code has been set to **19** at the factory but it can be changed it to any two digit number any time for your convenience.

note

- Memos less than one second will not be recorded. You can record a memo up to four minutes long.

Answering system

Set the remote access code

1. Press **SETUP** twice and you will hear *“Remote access code. To change the setting, press change.”*
2. Because the remote access code was set to **19** at the factory, press **CHANGE** and you will hear the default code *“19.”*
3. Press **CHANGE** to advance the remote access code number by one. Press and hold CHANGE to advance the remote access code by increments of 10.
4. When the desired number is heard. Press **SETUP** to save and advance to the next menu option or press **PLAY/STOP** ▶/■ to save and exit.

Remote answering system operation

1. From any touch tone telephone, dial your telephone number.
2. While the outgoing announcement is playing, enter your two-digit remote access code.
3. Hang up to end the call and save all undeleted messages.

If you pause for more than 10 seconds during remote access, you will hear a help menu listing all features and commands. If no command is entered for the following 20 seconds, the call will end automatically.

Answering system

Purpose	Press	Action
Play all messages in the mailbox	1	Listen to new messages. If there are no new messages, all messages will be played back.
Play new messages in the mailbox	2	Plays all new (not previously listened to) messages.
Delete a message	3	Delete message currently playing.
Delete all old messages	3 3	Press when any message is playing to delete all old (previously reviewed) messages.
Repeat a message	4	Press to repeat current message.
Repeat previous message	4 4	Press to repeat previous message.
Stop	5	Press to stop messages from being played.
Skip a message	6	Press to skip to the next message.

note

- Your phone may not respond to remote access commands if tones produced by the telephone are too short. Hold the buttons down longer if this occurs.
- If accessing from a touch tone telephone, press **#5** to stop recording.

Answering system

Purpose	Press	Action
Review announcement	#7	Listen to current outgoing announcement.
Record announcement	*7	Press after hearing the beep. Record your new announcement. Press 5 to stop recording. The system will play back the announcement for confirmation.
Record memo	8	Press after hearing the beep. Speak after the system announces " <i>Record after the tone. Press STOP when you are done.</i> " Start recording your memo. Press 5 to stop.
Review remote access code	#9	Listen to current remote access code.
Change remote access code	*9	Change remote access code.
Turn system off	0	When the system announces, " <i>Answering machine off,</i> " press 0 again to turn the system back on.
Turn system on	0	When the system is off, it answers after 10 rings and announces, " <i>Please enter your remote access code.</i> " Enter your remote access code.

Message alert

The message alert function produces an audio tone to remind you that there are new messages on the answering system.

1. Press **SETUP** three times, the system announces "*Message alert. To change the setting, press **CHANGE.***"

Answering system

2. Press **CHANGE** to confirm the current status; **On** or **Off** is also displayed on the message window.
3. Press **CHANGE** again to change the setting.
4. Press **SETUP** to save and advance to the next menu option or press **PLAY/STOP** ►/■ to save and exit.

When the message alert function is turned on, the base beeps every 10 seconds, and **PLAY/STOP** ►/■ and the number of messages in the message window flash when there are new messages. If

PLAY/STOP ►/■ and the number in the message window are on steadily, there are no new messages.

Announcement only mode

In announcement only mode, callers hear an announcement but cannot leave messages. When announcement only is turned on, calls are answered with the pre-recorded announcement “*We’re sorry. Messages to this number cannot be accepted*” or the customized message.

Turn the announcement only mode on or off

- Press **SETUP** four times, the system announces “*Announcement only. Record no messages. To change the setting, press CHANGE.*”
- Press **CHANGE** until you hear the desired option (on or off).
- Press **PLAY/STOP** ►/■ to save and exit.

Customize the announcement only message

1. Press **SETUP** four times, the system announces “*Announcement only. Record no messages. To change the setting, press CHANGE.*”

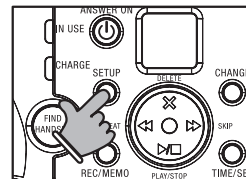

note

- In some areas, tone dial phone from a remote location phone may not function due to telephone line conditions such as line noise, echo, etc.

Answering system

2. Press **CHANGE** until you hear the on option.
3. Press **SETUP** three times, the system announces “*Announcement. Press **PLAY** or press **RECORD**. To continue setup, press **SETUP**.*”
4. Press **REC/MEMO**. The system will announce, “*Record after the tone. Press **STOP** when you are done.*” Speak toward the **MIC** to record an announcement for up to 90 seconds.
5. The elapsed time (in seconds) will be shown in the message window when you record.
6. Press **PLAY/STOP** ►/■ when you have finished recording. The system will play back your recorded message before saving it.

Base ringer

1. Press **SETUP** five times, the system announces “*Base ringer. To change the setting, press **CHANGE**.*”
2. Press **CHANGE** to confirm.
3. Press **CHANGE** again to change the setting.
4. Press **SETUP** to save your selection and advance to the next setup option, or press **PLAY/STOP** ►/■ to save and exit.

Number of rings

This function sets the number of rings before the answering system picks up the call. With toll saver activated, the answering system alerts you to new messages when calling remotely by picking up the incoming call after two rings. When retrieving messages from a location where long distance charges apply, you may disconnect your call after three rings to avoid long distance charges.

1. Press **SETUP** six times, the system announces “*Number of rings. To change the setting, press **CHANGE**.*”
2. Press **CHANGE** to confirm the current status, which is also displayed on the message window.
3. Press **CHANGE** to set the number of rings to 2, 4, 6 or toll saver.
4. Press **SETUP** to save and advance to the next setup option, or press **PLAY/STOP** ►/■ to save and exit.

Answering system

Message window display

Display	Explanation
0	No messages.
1 - 98	Total number of messages and memos, or message number currently playing. Number flashes if there are new messages.
1 - 8	Playback volume level selected when VOL ▲ or ▼ is pressed.
10 - 99	Current remote access code while setting.
1 - 99 (counting)	Elapsed time while recording a memo or announcement up to 90 seconds.
99 (flashing)	Memo or announcement recording exceeds maximum time of 99 seconds.
F (flashing)	Memory is full. Messages must be deleted before new messages can be recorded.
CL (flashing)	Clock needs to be set.
A	Announcement only mode is on.
--	Answering system is answering a call or being accessed from a remote location.
-- (flashing)	System is in programming mode.
On or OFF	Displayed for one second when any answering system setting is turned on or off.
02, 04, 06, tS	Change number of rings until the system answers the call.

note

- To purchase a headset, visit us on the web at www.vtechphones.com or call VTech Customer Service at 1-800-595-9511. In Canada, contact VTech Telecommunications Canada Ltd. at www.vtechcanada.com or 1-800-267-7377.

Headset (optional)

Headset jack

You can use this telephone handsfree when you install any VTech 2.5 mm headset, purchased separately.

Plug the headset into the jack located on the left side of the handset (under the small rubber flap). Do not force the connection, but make sure the plug fits securely.

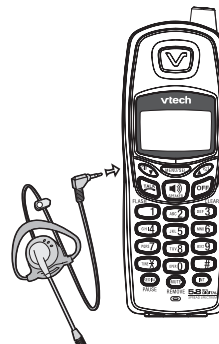

Operating range

This cordless telephone operates within the maximum power allowed by the Federal Communications Commission (FCC). Even so, this handset and telephone base can communicate only over a certain distance - which can vary with the locations of the telephone base and handset, the weather, and the construction of your home or office.

If you receive a call while you are out of range, the handset might not ring or if it does ring, the call might not connect well when you press **TALK**. Move closer to the telephone base, then press **TALK** to answer the call.

If you move out of range during a phone conversation, you might hear noise or interference. To improve reception, move closer to the telephone base.

If you move out of range without pressing **OFF**, the phone will be left off the hook. To hang up properly, walk back into range, periodically pressing **OFF**.

Batteries

Battery care and performance

After the battery is fully charged, you can expect the following performance:

Operation	Operating time
While in use (talking)	up to 7.5 hours
While not in use (standby*)	up to 3.5 days

* Handset is off the telephone base or charger but not in use.

- The battery needs charging when:
 - A new battery is installed in the handset.
 - The phone beeps twice every five seconds.
 - The screen displays **LOW BATTERY** and the low battery icon.
- Place the handset in the telephone base so the **CHARGE** light turns on. The battery is usually fully charged in about 16 hours.
- You can keep the battery fully charged by returning the handset to the telephone base after each use.

Replace the handset battery

1. Remove the battery compartment cover on the handset by pressing on the indentation and sliding the cover downward.
2. Lift out the old battery and disconnect.
3. Align the two holes in the new battery's plug with the socket pins, and snap the plug into place. Snap the battery in the compartment, as described in **Installation**, on page 7.
4. Replace the cover by sliding it up into place.
5. The new battery must be fully charged before installing it into the phone. Place the handset in the telephone base and allow it to charge for at least 16 hours the first charge. The telephone might operate before that, but for best performance, let the battery charge fully.

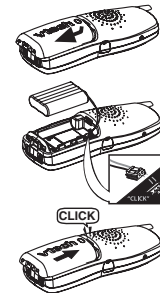

note

- If you repeatedly get a low battery indicator, even after charging overnight, the battery should be replaced.
- To reduce the risk of fire or injury to persons or damage to the telephone, read and follow these instructions carefully: Charge the battery provided with or identified for use with this product only in accordance with the instructions and limitations specified in the user's manual.

Troubleshooting

If you have difficulty operating your phone, the suggestions below should solve the problem. If you still have difficulty after trying these suggestions, call VTech Communications at 1-800-595-9511. In Canada, call VTech Telecommunications Canada Ltd. at 1-800-267-7377.

Problem	Suggestion
My phone doesn't work at all.	<ul style="list-style-type: none">• Make sure the power cord is plugged in.• Make sure the telephone line cord is plugged firmly into the telephone base and the telephone wall jack.• Disconnect the AC adapter for a few minutes, and then reconnect it.• Charge the battery in the handset for 16 hours. For optimum daily performance, return the handset to its telephone base when not in use.• Reset the telephone base. Unplug the unit's electrical power. Wait for 15 seconds then plug it back in. Allow up to one minute for the handset and telephone base to reset.• You may need to purchase a new battery, please refer to the battery sections in this user's manual.
I cannot get a dial tone.	<ul style="list-style-type: none">• Try all the suggestions above.• Move the handset closer to the telephone base. You might have moved out of range.• Your line cord might be malfunctioning. Try installing a new line cord.• If the previous suggestions don't work, disconnect the telephone base from the telephone jack and connect a different phone. If there is no dial tone on that phone either, the problem is in your wiring or local service. Contact your local telephone company.

Troubleshooting

Problem	Suggestion
I cannot dial out.	<ul style="list-style-type: none">• Make sure you have a dial tone before dialing. The handset may take a second or two to find the telephone base and produce a dial tone. This is normal. Wait an extra second before dialing.• Make sure your phone is set to the correct dial mode for the type of service that you have (pulse or touchtone). Refer to the Setup section of this user's manual to set the dial mode.• If the other phones in your home are having the issue, the problem is in your wiring or local service. Contact your local telephone company.• Eliminate any background noise. Noise from a television, radio or other appliance may cause the phone not to dial out properly. If you cannot eliminate the background noise, first try muting the handset before dialing, or dialing from another room in your home with less background noise.

Troubleshooting

Problem	Suggestion
<p>UNABLE TO CALL TRY AGAIN displays on my handset.</p>	<ul style="list-style-type: none"> • Move the handset closer to the telephone base. You might have moved out of range. • If the handset is in its telephone base and the charging light does not light, refer to the charge light is off in this troubleshooting guide. • Reset the telephone base. Unplug the unit's electrical power. Wait for 15 seconds then plug it back in. Allow up to one minute for the handset and telephone base to reset. • Other electronic products can cause interference with your cordless phone. Try installing your phone as far away from these types of electronic devices as possible: wireless routers, radios, radio towers, pager towers, cell phones, intercoms, room monitors, televisions, personal computers, kitchen appliances and other cordless phones.
<p>The battery does not hold a charge.</p>	<ul style="list-style-type: none"> • Charge the battery in the handset for 16 hours. For optimum daily performance, return the handset to its telephone base when not in use. • You may need to purchase a new battery, please refer to the battery sections in this user's manual. • Your phone might be malfunctioning. Please refer to the Warranty section of this user's manual for further instruction.
<p>If you subscribe to DSL service</p>	<ul style="list-style-type: none"> • If you hear noise during conversations and/or your caller ID features aren't functioning properly, install a DSL filter to the telephone line between the telephone base and the telephone line jack. Contact your DSL provider to obtain a DSL filter.
<p>I hear other calls while using my phone.</p>	<ul style="list-style-type: none"> • Disconnect your telephone base from the telephone jack, and plug in a regular telephone. If you still hear other calls, the problem is probably in your wiring or local service. Call your local telephone company.

Troubleshooting

Problem	Suggestion
<p>I get noise, static, or weak signal even when I'm near the telephone base.</p>	<ul style="list-style-type: none">• Other cordless phones and 802.11 wireless routers that are used for home computer networks both use internal radios to communicate. The radios may interfere with one another. You can improve the performance of your cordless phones and your router by:<ol style="list-style-type: none">a. positioning your new phone as far away as possible from any other existing cordless telephone system that is already installed in your home to avoid the two systems interfering with each other.b. positioning your telephone base as far as possible from your router, computer or any other computer devices.c. selecting channels four through 10 for your router (refer to your router's user manual for more information).• Other electronic products can cause interference with your cordless phone. Try installing your phone as far away from these types of electronic devices as possible: wireless routers, radios, radio towers, pager towers, cell phones, intercoms, room monitors, televisions, personal computers, kitchen appliances and other cordless phones.• Microwave oven operates on the same frequency as your phone. It is normal to experience static on your phone while the microwave oven is running. Do not install this phone in the same outlet or near the microwave oven.• If your phone is plugged in with a modem or surge protector, plug the phone (or modem/surge protector) into a different location. If this solves the problem, re-locate your phone or modem farther apart from one another, or use a different surge protector.• Relocate your phone to a higher location. The phone will likely get better reception not installed in a low area.• If the other phones in your home are having the issue, the problem is in your wiring or local service. Contact your local telephone company (charges may apply.)

Troubleshooting

Problem	Suggestion
<p>My handset does not ring when I receive a call.</p>	<ul style="list-style-type: none">• Make sure you have the ringer activated. Refer to the section(s) on ringer selection in this user's manual.• Make sure the telephone line cord is plugged firmly into the telephone base and the telephone jack. Make sure the power cord is plugged in.• You may be too far from the telephone base.• Charge the battery in the handset for 16 hours. For optimum daily performance, return the handset to its telephone base when not in use.• You may have too many extension phones on your telephone line to allow all of them to ring. Try unplugging some of the other phones.• The layout of your home or office might be limiting the operating range. Try moving the telephone base to another location, preferably on an upper floor.• If the other phones in your home are having the issue, the problem is in your wiring or local service. Contact your local telephone company (charges may apply.)• Test a working phone at the phone jack. If another phone has the same problem, the problem is the phone jack. Contact your local telephone company (charges may apply.)• Other electronic products can cause interference with your cordless phone. Try installing your phone as far away from these types of electronic devices as possible: wireless routers, radios, radio towers, pager towers, cell phones, intercoms, room monitors, televisions, personal computers, kitchen appliances and other cordless phones• Your line cord might be malfunctioning. Try installing a new line cord.

Troubleshooting

Problem	Suggestion
<p>My calls fade or cut in and out while I'm using my handset.</p>	<ul style="list-style-type: none"> • Other electronic products can cause interference with your cordless phone. Try installing your phone as far away from these types of electronic devices as possible: wireless routers, radios, radio towers, pager towers, cell phones, intercoms, room monitors, televisions, personal computers, kitchen appliances and other cordless phones. • Microwave oven operates on the same frequency as your phone. It is normal to experience static on your phone while the microwave oven is running. Do not install this phone in the same outlet or near the microwave oven. • If your phone is plugged in with a modem or surge protector, plug the phone (or modem/surge protector) into a different location. If this solves the problem, re-locate your phone or modem farther apart from one another, or use a different surge protector. • Relocate your phone to a higher location. The phone will get better reception not installed in a low area. • If the other phones in your home are having the issue, the problem is in your wiring or local service.
<p>The charge light is off.</p>	<ul style="list-style-type: none"> • Clean the handset and telephone base charging contact each month using a pencil eraser or cloth. • Make sure the power and line cords are plugged in correctly and firmly. • Reset the telephone base. Unplug the unit's electrical power. Wait for 15 seconds then plug it back in. Allow up to one minute for the handset and telephone base to reset. • Your phone might be malfunctioning. Please refer to the Warranty section of this user's manual for further instruction.

Troubleshooting

Problem	Suggestion
My caller ID isn't working.	<ul style="list-style-type: none"> • Caller ID is a subscription service. You must subscribe to this service for this feature to work on your phone. • Your caller must be calling from an area that supports caller ID. • Both you and your caller's telephone companies must use caller ID compatible equipment.
My answering machine is not recording messages.	<ul style="list-style-type: none"> • Make sure system is turned ON (the ANS ON/OFF key is illuminated). • Make sure the announce only feature is set to OFF.
I cannot hear recorded messages.	<ul style="list-style-type: none"> • Using the telephone base volume control, raise the volume to a comfortable listening level.
CL is flashing in the telephone base message display window.	<ul style="list-style-type: none"> • You need to set the day and time. Refer to the section(s) on setting day and time in this user's manual. • Make sure announce only feature is set to OFF.
Common cure for electronic equipment.	<p>If the unit does not seem to be responding normally, then try putting the handset in its telephone base. If it does not seem to respond, do the following (in the order listed):</p> <ol style="list-style-type: none"> 1. Disconnect the power to the telephone base. 2. Disconnect the handset battery, and spare battery, if applicable. 3. Wait a few minutes. 4. Connect power to the telephone base. 5. Re-install the battery(ies). 6. Wait for the handset to re-establish its link with the telephone base. Allow up to one minute for this to take place.

Troubleshooting

Problem	Suggestion
I lost a handset and just bought a new one. How do I register the new one ?	<ul style="list-style-type: none">• <u>Press and hold</u> FIND HANDSET on the main telephone base for 10 seconds.• When the IN USE light starts to flash, release the FIND HANDSET button.• Press and release FIND HANDSET again. The IN USE light will turn off and in a few seconds, all handsets will be de-registered.• All handsets will show NOT REGISTERED.• Place the handset in its charger (connected to a power outlet.) If PRESS FIND HNDST 4 SECS ON BASE does not appear on the screen after a few seconds, lift up handset and place in the charger again.• On the main telephone base,<ul style="list-style-type: none">• <u>Press and hold</u> FIND HANDSET key for four seconds.• Release FIND HANDSET key when IN USE light is on.• The LCD screen on the telephone base will show, HS REGISTERED.• The handset will show HS REGISTERED and beep once. <p>After about 10 seconds the handset will emit a tone and the handset will be assigned the lowest extension number not previously assigned to another system handset (1-4) when successfully registered. Repeat steps 1 and 2 if handset is not registered within two minutes.</p>

Maintenance

Taking care of your telephone

Your cordless telephone contains sophisticated electronic parts, so it must be treated with care.

Avoid rough treatment

Place the handset down gently. Save the original packing materials to protect your telephone if you ever need to ship it.

Avoid water

Your telephone can be damaged if it gets wet. Do not use the handset outdoors in the rain, or handle it with wet hands. Do not install your telephone base near a sink, bathtub or shower.

Electrical storms

Electrical storms can sometimes cause power surges harmful to electronic equipment. For your own safety, use caution when using electric appliances during storms.

Cleaning your telephone

Your telephone has a durable plastic casing that should retain its luster for many years. Clean it only with a soft cloth slightly dampened with water or a mild soap. Do not use excess water or cleaning solvents of any kind.

Warranty

What does this limited warranty cover?

- The manufacturer of this VTech Product warrants to the holder of a valid proof of purchase ("Consumer" or "you") that the Product and all accessories provided in the sales package ("Product") are free from defects in material and workmanship, pursuant to the following terms and conditions, when installed and used normally and in accordance with the Product operating instructions. This limited warranty extends only to the Consumer for Products purchased and used in the United States of America and Canada.

What will VTech do if the Product is not free from defects in materials and workmanship during the limited warranty period ("Materially Defective Product")?

- During the limited warranty period, VTech's authorized service representative will repair or replace at VTech's option, without charge, a Materially Defective Product. If we repair the Product, we may use new or refurbished replacement parts. If we choose to replace the Product, we may replace it with a new or refurbished Product of the same or similar design. We will retain defective parts, modules, or equipment. Repair or replacement of the Product, at VTech's option, is your exclusive remedy. VTech will return repaired or replacement Products to you in working condition. You should expect the repair or replacement to take approximately 30 days.

How long is the limited warranty period?

- The limited warranty period for the product extends for ONE (1) YEAR from the date of purchase if we repair or replace a Materially Defective Product under the terms of this limited warranty. This limited warranty also applies to repaired or replacement Products for a period of either (a) 90 days from the date the repaired or replacement Product is shipped to you or (b) the time remaining on the original one-year warranty; whichever is longer.

What is not covered by this limited warranty?

This limited warranty does not cover

1. Product that has been subjected to misuse, accident, shipping or other physical damage, improper installation, abnormal operation or handling, neglect, inundation, fire, water or other liquid intrusion; or
2. Product that has been damaged due to repair, alteration or modification by anyone other than an authorized service representative of VTech; or
3. Product to the extent that the problem experienced is caused by signal conditions, network reliability, or cable or antenna systems; or
4. Product to the extent that the problem is caused by use with non-VTech electrical accessories; or
5. Product whose warranty/quality stickers, Product serial numbers plates or electronic serial numbers have been removed, altered or rendered illegible; or
6. Product purchased, used, serviced, or shipped for repair from outside the United States of America or Canada, or used for commercial or institutional purposes (including but not limited to Products used for rental purposes); or
7. Product returned without valid proof of purchase (see 2 below); or

Warranty

8. Charges for installation or set up, adjustment of customer controls, and installation or repair of systems outside the unit.

How do you get warranty service?

- To obtain warranty service in the United States of America, call 1-800-595-9511 for instructions regarding where to return the Product. Before calling for service, please check the user's manual. A check of the Product controls and features may save you a service call.
- Except as provided by applicable law, you assume the risk of loss or damage during transit and transportation and are responsible for delivery or handling charges incurred in the transport of Product (s) to the service location. VTech will return repaired or replaced product under this limited warranty to you, transportation, delivery or handling charges prepaid. VTech assumes no risk for damage or loss of the Product in transit.
- If the Product failure is not covered by this limited warranty, or proof of purchase does not meet the terms of this limited warranty, VTech will notify you and will request that you authorize the cost of repair prior to any further repair activity. You must pay for the cost of repair and return shipping costs for the repair of Products that are not covered by this limited warranty.

What must you return with the Product to get warranty service?

1. Return the entire original package and contents including the Product to the VTech service location along with a description of the malfunction or difficulty; and
2. Include "valid proof of purchase" (sales receipt) identifying the Product purchased (Product model) and the date of purchase or receipt; and
3. Provide your name, complete and correct mailing address, and telephone number.

Other Limitations

- This warranty is the complete and exclusive agreement between you and VTech. It supersedes all other written or oral communications related to this Product. VTech provides no other warranties for this product. The warranty exclusively describes all of VTech's responsibilities regarding the product. There are no other express warranties. No one is authorized to make modifications to this limited warranty and you should not rely on any such modification.
- State Law Rights: This warranty gives you specific legal rights, and you may also have other rights which vary from state to state.
- Limitations: Implied warranties, including those of fitness for a particular purpose and merchantability (an unwritten warranty that the Product is fit for ordinary use) are limited to one year from date of purchase. Some states/provinces do not allow limitations on how long an implied warranty lasts, so the above limitation may not apply to you. In no event shall VTech be liable for any indirect, special, incidental, consequential, or similar damages (including, but not limited to lost profits or revenue, inability to use the Product or other associated equipment, the cost of substitute equipment, and claims by third parties) resulting from the use of this Product. Some states/provinces do not allow the exclusion or limitation of incidental or consequential damages, so the above limitation or exclusion may not apply to you.

Please retain your original sales receipt as proof of purchase.

Important safety instructions

When using your telephone equipment, basic safety precautions should always be followed to reduce the risk of fire, electric shock and injury, including the following:

1. Read and understand all instructions.
2. Follow all warnings and instructions marked on the product.
3. Unplug this product from the wall outlet before cleaning. Do not use liquid or aerosol cleaners. Use a damp cloth for cleaning.
4. Do not use this product near water (for example, near a bath tub, kitchen sink or swimming pool).
5. Do not place this product on an unstable surface, such as a table, shelf or stand. The product may fall, causing serious damage.
6. Slots and openings in the back or bottom of the telephone base and handset are provided for ventilation. To protect them from overheating, these openings must not be blocked by placing the product on a soft surface such as a bed, sofa or rug. This product should never be placed near or over a radiator or heat register. This product should not be placed in any area where proper ventilation is not provided.
7. This product should be operated only from the type of power source indicated on the marking label. If you are not sure of the type of power supply in your home, consult your dealer or local power company.
8. Do not allow anything to rest on the power cord. Do not install this product where the cord may have anyone walking on it.
9. Never push objects of any kind into this product through slots in the telephone base or handset as they may touch dangerous voltage points or short out parts that could result in a risk of fire or electric shock. Never spill liquid of any kind on the product.
10. To reduce the risk of electric shock, do not disassemble this product, but take it to an authorized service facility. Opening or removing parts of the telephone base or handset other than specified access doors may expose you to dangerous voltages or other risks. Incorrect reassembling can cause electric shock when the product is subsequently used.
11. Do not overload wall outlets and extension cords as this can result in the risk of fire or electric shock.
12. Unplug this product from the wall outlet and refer servicing to an authorized service facility under the following conditions:
 - A. When the power supply cord or plug is damaged or frayed.
 - B. If liquid has been spilled onto the product.
 - C. If the product has been exposed to rain or water.
 - D. If the product does not operate normally by following the operating instructions. Adjust only those controls that are covered by the operating instructions, as improper adjustment of other controls may result in damage and often requires extensive work by an authorized technician to restore the product to normal operation.
 - E. If the product has been dropped and the telephone base and/or handset has been damaged.
 - F. If the product exhibits a distinct change in performance.
13. Avoid using a telephone (other than cordless) during an electrical storm. There is a remote risk of electric shock from lightning.
14. Do not use the telephone to report a gas leak in the vicinity of the leak.
15. Only put the handset of your telephone next to your ear when it is in normal talk.
16. This power unit is intended to be correctly orientated in a vertical or floor mount position. The prongs are not designed to hold the plug in place if it is plugged into ceiling, under-the-table or cabinet outlet.

SAVE THESE INSTRUCTIONS

FCC, ACTA and IC regulations

FCC Part 15

This equipment has been tested and found to comply with the requirements for a Class B digital device under Part 15 of the Federal Communications Commission (FCC) rules. These requirements are intended to provide reasonable protection against harmful interference in a residential installation. This equipment generates, uses and can radiate radio frequency energy and, if not installed and used in accordance with the instructions, may cause harmful interference to radio communications. However, there is no guarantee that interference will not occur in a particular installation. If this equipment does cause harmful interference to radio or television reception, which can be determined by turning the equipment off and on, the user is encouraged to try to correct the interference by one or more of the following measures:

- * Reorient or relocate the receiving antenna.
- * Increase the separation between the equipment and receiver.
- * Connect the equipment into an outlet on a circuit different from that to which the receiver is connected.
- * Consult the dealer or an experienced radio/TV technician for help.

Changes or modifications to this equipment not expressly approved by the party responsible for compliance could void the user's authority to operate the equipment.

To ensure safety of users, the FCC has established criteria for the amount of radio frequency energy that can be safely absorbed by a user or bystander according to the intended usage of the product. This product has been tested and found to comply with the FCC criteria. The handset may be safely held against the ear of the user. The telephone base shall be installed and used such that parts of the user's body other than the hands are maintained at a distance of approximately 20 cm (8 inches) or more. If you choose to use a clipping device, please make sure to only use the supplied VTech belt clip.

FCC Part 68 and ACTA

This equipment complies with Part 68 of the FCC rules and with technical requirements adopted by the Administrative Council for Terminal Attachments (ACTA). The label on the back or bottom of this equipment contains, among other things, a product identifier in the format US:AAAEQ##TXXXX. This identifier must be provided to your local telephone company upon request.

The plug and jack used to connect this equipment to premises wiring and the telephone network must comply with applicable Part 68 rules and technical requirements adopted by ACTA. A compliant telephone cord and modular plug is provided with this product. It is designed to be connected to a compatible modular jack that is also compliant. An RJ11 jack should normally be used for connecting to a single line and an RJ14 jack for two lines. See Installation Instructions in the user's manual.

The Ringer Equivalence Number (REN) is used to determine how many devices you may connect to your telephone line and still have them ring when you are called. The REN for this product is encoded as the 6th and 7th characters following the US: in the product identifier (e.g., if ## is 03, the REN is 0.3). In most, but not all areas, the sum of all RENs should be five (5.0) or less. For more information, please contact your local telephone company.

This equipment may not be used with Party Lines. If you have specially wired alarm dialing equipment connected to your telephone line, ensure the connection of this equipment does not disable your alarm equipment. If you have questions about what will disable alarm equipment, consult your telephone company or a qualified installer.

If this equipment is malfunctioning, it must be unplugged from the modular jack until the problem has been corrected. Repairs to this telephone equipment can only be made by the manufacturer or its authorized agents. For repair procedures, follow the instructions outlined under the Limited Warranty.

If this equipment is causing harm to the telephone network, the telephone company may temporarily discontinue your telephone service. The telephone company is required to notify you before interrupting service. If advance notice is not practical, you will be notified as soon as possible. You will be given the opportunity to correct the problem and the telephone company is required to inform you of your right to file a complaint with the FCC. Your telephone company may make changes in its facilities, equipment, operation, or procedures that could affect the proper functioning of this product. The telephone company is required to notify you if such changes are planned.

If this product is equipped with a corded or cordless handset, it is hearing aid compatible.

If this product has memory dialing locations, you may choose to store emergency telephone numbers (e.g., police, fire, medical) in these locations. If you do store or test emergency numbers, please:

FCC, ACTA and IC regulations

- * Remain on the line and briefly explain the reason for the call before hanging up.
- * Perform such activities in off-peak hours, such as early morning or late evening.

Industry Canada

This equipment complies with regulations RSS210 and CS-03 of Industry Canada. Operation is subject to the following two conditions: (1) this device may not cause interference, and (2) this device must accept any interference, including interference that may cause undesired operation of the device.

The term "IC: " before the certification/registration number only signifies that the Industry Canada technical specifications were met.

The Ringer Equivalence Number (REN) for this terminal equipment is 0.1. The REN is an indication of the maximum number of devices allowed to be connected to a telephone interface. The termination on an interface may consist of any combination of devices subject only to the requirement that the sum of the RENs of all the devices does not exceed five.

The RBRC® seal



The RBRC® seal on the nickel-metal-hydride battery indicates that VTech Communications, Inc. is voluntarily participating in an industry program to collect and recycle these batteries at the end of their useful lives, when taken out of service within the United States and Canada.

The RBRC® program provides a convenient alternative to placing used nickel-metal-hydride batteries into the trash or municipal waste, which may be illegal in your area.

VTech's participation in RBRC® makes it easy for you to drop off the spent battery at local retailers participating in the RBRC® program or at authorized VTech product service centers. Please call **1-800-8-BATTERY™** for information on Ni-MH battery recycling and disposal bans/restrictions in your area. VTech's involvement in this program is part of its commitment to protecting our environment and conserving natural resources.

RBRC® is a registered trademark of Rechargeable Battery Recycling Corporation.

Technical specifications

Enhanced 5.8GHz technology – your phone operates on a dual band transmission that combines the best of 5.8GHz and 2.4GHz technologies, providing enhanced performance over standard cordless telephones.

Frequency control	Crystal controlled PLL synthesizer
Transmit frequency	Telephone base: 5725-5850 MHz Handset: 2400-2483.5 MHz
Receive frequency	Telephone base: 2400-2483.5 MHz Handset: 5725-5850 MHz
Channels	95
Nominal effective range	Maximum power allowed by the FCC and IC. Actual operating range may vary according to environmental conditions at the time of use.
Size	Handset: 141mm X 49mm X 35mm Telephone base: 130mm X 120mm X 68mm Charger: 89mm X 78mm X 53mm
Weight	Handset: 141 grams Telephone base: 267 grams Charger: 76 grams
Power requirements	Handset: 600mAH Ni-MH battery Telephone base: 9V DC @ 600mA Charger: 9V DC @ 200mA
Memory	Directory: 50 memory locations, up to 32 digits, 16 characters per location Caller ID: 50 memory locations

Index

A

Additional information 45
Announcement only mode 39
Announcements 34
Answering calls 19
Answering system 30

B

Base ringer 40
Base volume 34-35
Batteries 43
Battery care and performance 43
Belt clip 10

C

Caller ID - call waiting ID 26
Call forward 21
Call screening 35
Call transfer 21
Characters by number 24
Check battery indicator 9
Check for dial tone 9
Choose a location 7
Conference call 22
Connect power to telephone base/
handset chargers 8
Connect to phone line 8
Customize the announcement only

58

message 39

D

Day and time announcements 30
De-register all handsets 13
Delete a caller ID record 29
Delete a directory entry 25
Delete all messages 34
Delete outgoing announcement 33
Dial from caller ID 29
Directory 23
DSL 10

E

Edit a directory entry 25

F

FCC, ACTA and IC
regulations 56
Find handset 22
Flash function 19

G

Getting started 5

H

Handset icons 16
Handset layout 14

Handset lights 16
Handset main menu 17
Handset operation 19
Handset volume 19
Headset jack 42
Headset operation 42

I

If you subscribe to DSL service 10
Important safety instructions 53
Index 58
Installation 7
Install handset battery 7
Intercom 20
Internet 10

L

Listen to outgoing announcement 33

M

Maintenance 52
Making calls 19
Menu features 32
Message alert 38
Message playback 33
Message window display 41
Mute 20

N

Number of rings 40

O

Operating range 42

Options during playback 34

Outgoing announcement 32

P

Parts checklist for mi6885 5

Parts checklist for mi6889 6

Play back a memo 35

R

Record a memo 35

Record and play memos 34

Record outgoing announcement 32

Redial 19

Register a handset 12

Registration 12

Remote access 35

Remote answering system
operation 36

Replace the handset battery 43

Review and dial entries 24

Review caller ID 27

S

Set the remote access code 36

Store a new entry 23

Store caller ID in your directory 27

T

Technical specifications 57

Telephone base display 16

Telephone base layout 15

Telephone base volume 34-35

Telephone settings 16

The RBRC® seal 56

To check day and time 31

Troubleshooting 44

Turn the announcement only mode on
or off 39

Turn your answering system on and
off 30

V

Voice mail 22

Volume 19, 34-35

W

Wall mounting 11

Warranty 52

VTECH TELECOMMUNICATIONS LTD.

A member of THE VTECH GROUP OF COMPANIES

Distributed in the U.S.A. by VTech Communications, Inc. Beaverton, Oregon
Distributed in Canada by VTech Telecommunications Canada Ltd., Richmond, B.C.

Copyright ©2007 for VTECH TELECOMMUNICATIONS LTD.
Printed in China.

91-000869-030-100

vtech[®]
Innovation Beyond Technology™