

INSTRUCTION MANUAL and RECIPE BOOKLET

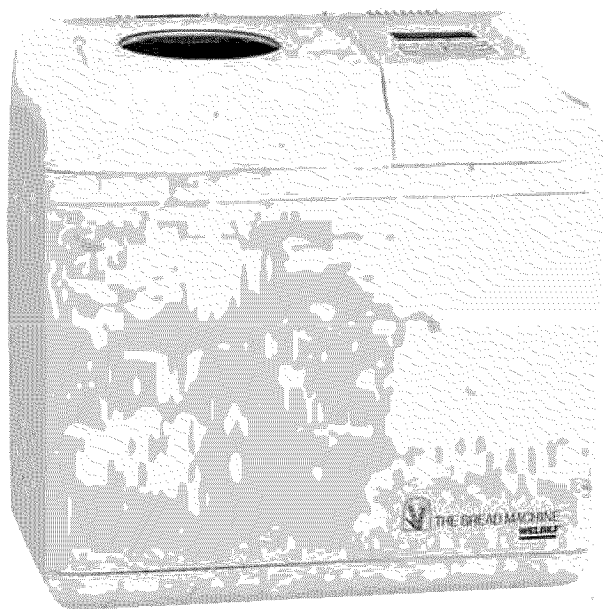

BREAD MACHINE
MODEL ABM4100T

WELBILT®

There never has been as much interest in home bread baking as since the introduction of the first automatic bread machines in 1987. Since then, millions of people have learned to enjoy the pleasure and gratification of making and serving fresh homemade bread to family and friends. And to think that the best part of all is that the bread machine does all of the work and only requires a few minutes of your time and attention.

Before using the Bread Machine for the first time, please read the instructions contained in this manual. Follow the steps carefully and use the ingredients specified in the recipes.

If you should have any questions about your Welbilt Bread Machine, please write to:

DELETED BECAUSE THEY WENT OUT OF BUSINESS

Check with <http://www.tritronicsinc.com/>

IMPORTANT SAFEGUARDS HOUSEHOLD USE ONLY

When using electrical appliances, basic safety precautions should always be followed, including the following:

1. Read all instructions before using the appliance.
2. Do not touch hot surfaces. Use the appliance's handles or knobs.
3. To protect against electrical shock, do not immerse power cord, plugs, or the appliance in water or other liquid.
4. To prevent injuries or burns, do not insert your hand into the appliance when it is operating.
5. Close supervision is necessary when any appliance is used by or near children.
6. Unplug the appliance from the wall outlet after use and before cleaning. Allow the appliance to cool before attaching or removing parts.
7. Do not operate any appliance with a damaged power cord or plug, or after the appliance malfunctions, or after the appliance has been damaged in any manner. Return appliance to the nearest authorized service facility for examination, repair or adjustment.
8. The use of accessory attachments not recommended by the appliance manufacturer may cause injuries.
9. Do not use the appliance outdoors.
10. Do not let cord hang over edge of table or, counter or touch hot surfaces.
11. Do not place the appliance on or near a hot gas or electric burner or in a heated oven.
12. Extreme caution must be used when moving an appliance that contains hot liquids.
13. When using an extension cord, always attach the plug to the appliance first, then plug the extension cord into the wall outlet. To disconnect, first turn any appliance controls to OFF, then disconnect the plug from the wall outlet.

14. Do use any appliance for anything other than its intended use.

This unit has a short power supply cord to reduce the risk resulting from becoming entangled in or tripping over a longer cord. An extension cord may be used if you are careful in its use. If a longer detachable power- supply cord or extension cord is used, (1) the marked electrical rating of the cord set or extension cord should be at least as great as the electrical rating of the appliance, and (2) the cord should be arranged so that it will not drape over the countertop or tabletop where it can be pulled on by children or tripped over accidentally. If the appliance is of the grounded type, the extension cord should be a grounding type 2-wire cord. The power cord must be kept dry and must not be bent or have anything put on top of it.

SAVE THESE INSTRUCTIONS FOR LATER USE

To reduce the hazard of potential shock, this item has a polarized plug(one blade is wider than the other),which will fit only one way in a polarized outlet. If the plug does not fit the outlet properly, turn the plug the other way; if it still does not fit, contact a qualified electrician for assistance. Never use this plug with an extension cord unless it fits properly. **DO NOT ATTEMPT TO DEFEAT THIS SAFETY FEATURE.**

Table of Contents

Your Welbilt Bread Machine	5
Control Panel	6
Using Your Welbilt Bread Machine	7
Tips For Best Baking Results	9
Suggestions For Maximum Enjoyment and Safety	10
Getting Started	11
Inserting and Removing the Bread Pan	12
Kneading, Rising, and Baking Cycles	13
How to Make Bread or Dough	15
Recipes and Baking Guide	17
Cleaning Instructions	44
Consumer Assistance	45
Trouble Shooting Guide	46
Specifications	48
Limited Warranty	49

YOUR WELBILT® BREAD MACHINE

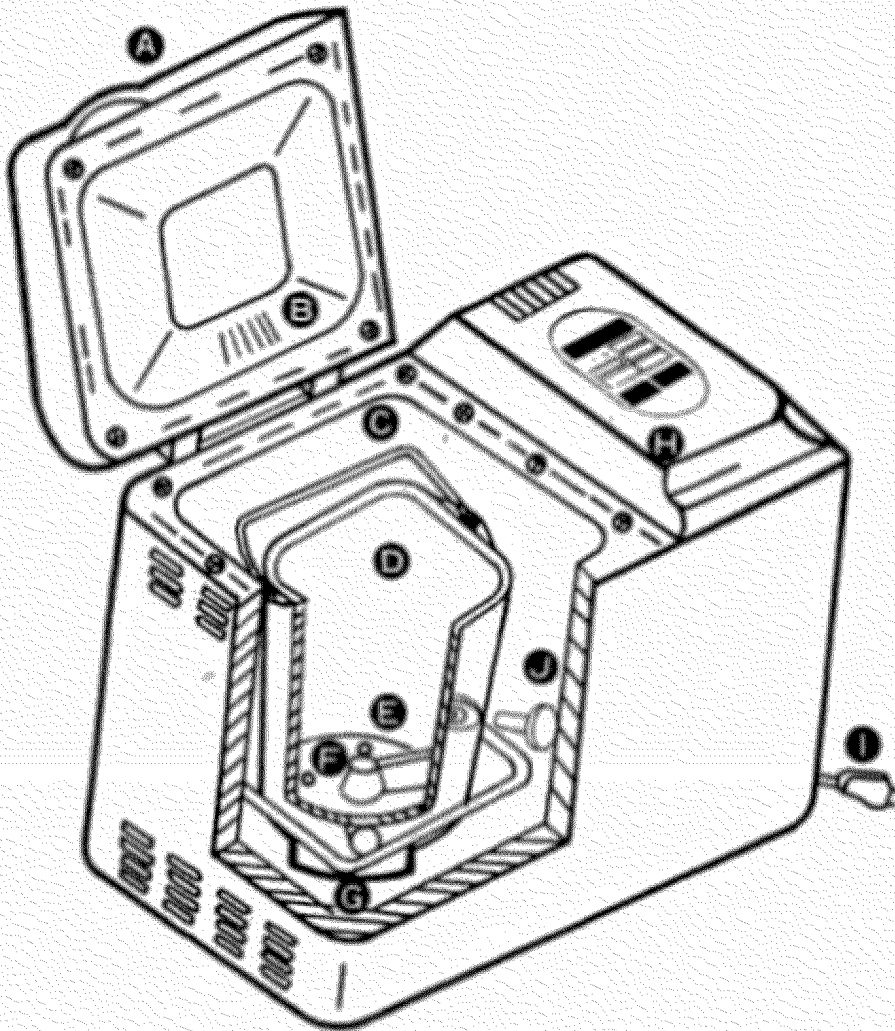

- A. Lid
- B. Steam Vent
- C. Handle
- D. Bread Pan
- E. Kneading Blade
- F. Drive Shaft
- G. Heating Element
- H. Control Panel
- I. Power Cord
- J. Dough Hook

CONTROL PANEL

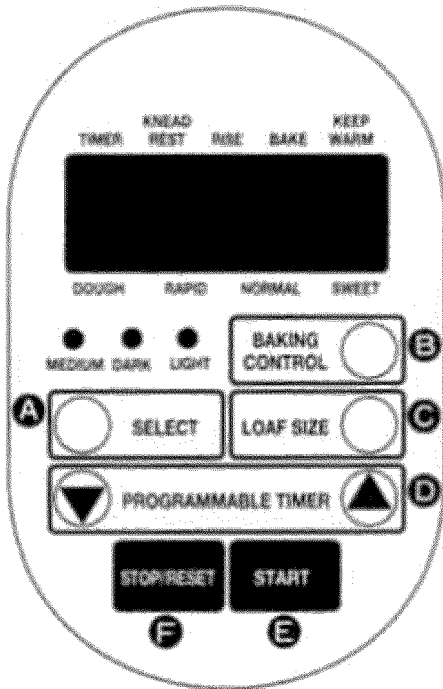

A. SELECT

Press **SELECT** to choose the program you desire for either yeast breads or dough.

B. BAKING CONTROL

Press **BAKING CONTROL** for choosing **MEDIUM**, **DARK** or **LIGHT** bread crust.

C. LOAF SIZE

Press **LOAF SIZE** for **REGULAR** to make 1 lb. loaves of bread and dough and **LARGE** for 1½ to 2 lbs.

D. PROGRAMMABLE TIMER

Allows you to prepare bread up to 13 hours later.

E. START

Push **START** to begin the program chosen.

F. STOP/RESET

Choose **STOP/RESET** either to cancel a program or to reset the Bread Machine.

USING YOUR WELBILT® BREAD MACHINE

Before using your Bread Machine for the first time, be sure to carefully read all of the instructions included in this manual.

1. You can make any of the delicious recipes included with your Bread Machine. You also can use bread machine pre-mixes sold in many specialty stores or through mail order catalogs. Be sure that you never exceed 1-1/2 teaspoons of yeast when baking bread from scratch (unless specified in your Welbilt recipe) or when using any other recipe or pre-mix.
2. You also can use any 2, 3 or 4 cup flour capacity recipe from many of the bread machine cookbooks available from your local bookstore or library. Never exceed teaspoons of yeast if baking bread in the Bread Machine.
3. If you wish to convert a favorite family recipe for use in your bread machine, find a similar one in this booklet to see how to scale it down proportionately. Never exceed 1/2 teaspoons of yeast when baking bread in the Bread Machine.
4. For best results, never exceed the maximum amount of four cups of flour if you plan to bake the bread in the appliance.
5. Before making your bread or dough determine the size loaf or the amount of dough you plan to make. You can use 2, 3, or 4 cups of flour depending on the recipe. Press the LOAF SIZE button to choose either REGULAR for 1 lb. loaf of bread or dough or LARGE for 1 1/2 to 2 lbs.

6. When making basic yeast bread like white, wheat and raisin, set the bread machine on the NORMAL setting by pressing the SELECT button. Determine the type of crust desired by pressing the BAKING CONTROL button for MEDIUM, DARK or LIGHT. To make yeast dough for baked goods that will be hand shaped and baked in your kitchen oven, press the SELECT button for DOUGH NORMAL. The bread machine will knead and rise the dough which will then be removed and hand shaped.

7. If you are making bread or dough which contains a greater quantity of eggs, sugar or butter, set the bread machine on the SWEET bread setting by pressing the SELECT button. If you are baking the bread in the bread machine determine the type of crust desired by pressing the BAKING button for MEDIUM, DARK or LIGHT. To only make sweet bread dough, press the SELECT button until DOUGH SWEET appears on the readout

8. If you wish to make yeast bread using the RAPID setting, the entire bread making process will be shortened by 30 minutes. To use this optional function, press the SELECT button until either RAPID NORMAL, or RAPID SWEET, appears on the readout. Determine how you wish to have your bread baked by selecting MEDIUM, DARK or LIGHT.

9. After selecting the appropriate loaf size, type of program, and baking cycle, press START.

10. You can also set your bread machine to make an endless variety of yeast breads to be ready up to 13 hours later when using the NORMAL or SWEET bread setting only. Press the SELECT button for either NORMAL or SWEET. Choose the appropriate baking setting by pressing the BAKING CONTROL button for MEDIUM, DARK or LIGHT.

Using the PROGRAMMABLE TIMER arrow up or arrow down buttons, you can set your bread machine to have your bread ready, up to 13 hours later. Never use perishable ingredients like eggs. when using the PROGRAMMABLE TIMER. Never use absorbent ingredients like oats or other whole grains, since they will absorb the liquid before the bread making process begins. The PROGRAMMABLE TIMER cannot be used when using the RAPID or DOUGH setting.

TIPS FOR BEST BAKING RESULTS

1. All ingredients must be at room temperature.
2. Yeast is what causes the dough to rise. It is a living single cell organism that is sold dehydrated. When mixed with water, yeast is reactivated. Unfortunately, yeast can be adversely affected by extreme temperatures. If the ingredients being used are not at room temperature, the yeast may not be activated effectively.
3. Yeast also can be adversely affected by temperatures that are too hot. Only use room temperature water (75° – 80°F) even though the yeast package may specify something totally different.
4. Always measure ingredients carefully. Spoon flour into the measuring cup and level off with a blunt knife. Do not pack down.
5. Always use bread flour unless otherwise specified. It is available in most supermarkets.
6. Do not open the lid during operation since this can adversely affect the quality of the bread.
7. Be careful not to unplug the Bread Machine during use. If this should happen, or if there is a power failure, you will not be able to go back to where it left off. However, if the Bread Machine was not in the baking cycle and the dough had been kneaded at least once, you can remove it, hand-shape and bake it in a conventional oven.
8. If you try to use the Bread Machine immediately after baking a loaf of bread, the yeast may be killed since the appliance will be very hot. If you press the START button the Bread Machine will beep and not knead. This is your warning that the pan should be removed and the unit be allowed to cool down.

SUGGESTIONS FOR MAXIMUM ENJOYMENT AND SAFETY

1. The baking portion and lid of the Bread Machine become extremely hot during baking. Always use a kitchen mitt or pot holder when touching these parts.
2. Do not operate this appliance on the same circuit as other high voltage appliances.
3. Position the Bread Machine at least 4 inches from the f of the counter or working surface. Do not place any flammable materials or objects on top of the appliance when plugged in or during operation.
4. Do not use the Bread Machine near any electrical equipment like radios, TVs, or stereos since poor reception or interference may occur.
5. Always use the Bread Machine on a clean, dry work surface away from exposed elements, direct sunlight, or other sources of heat or cold.
6. Only use the Bread Machine on a non-flammable work surface or counter. Never use on floor or on carpeting or on top of any cloth objects like tablecloths or placemats.
7. Never stick your hand or any kitchen utensils into the bread pan during operation.
8. Do not use accessories or attachments not included or recommended by Welbilt.
9. Do not put any components in the dishwasher.
10. Do not attempt to tamper with or make any adjustments to the electrical components or parts.
11. Do not use this appliance other than for its intended use.

GETTING STARTED

Your Welbilt® Bread Machine has twelve separate programs to choose from.

Making Bread Automatically:

Choose the NORMAL, SWEET, RAPID/NORMAL, RAPID/SWEET, REGULAR or LARGE capacity program when making bread automatically, by pressing the SELECT and LOAF SIZE buttons. The Bread Machine will knead and rise the dough twice and then bake it to perfection.

Making Yeast Dough Automatically:

Choose the DOUGH/NORMAL or DOUGH/SWEET, REGULAR or LARGE capacity program, by pressing the SELECT and LOAF SIZE buttons. The Bread Machine will knead and rise the dough twice. At the end of the program you will remove the dough and hand-shape it according to your recipe. Dough will then be baked in a conventional oven.

INSERTING AND REMOVING THE BREAD PAN

1. Before using the Bread Machine for the first time, be certain to wash the bread pan and dough blade with warm water and mild dish-washing liquid. Towel dry. Never put the bread pan and blade in the dishwasher.
2. All mixing, kneading, rising, and baking, when appropriate, take place in the bread pan. The pan is covered with a non-stick fluorine coating which will scratch if not treated and cared for properly. Clean and treat the pan as you would a non-stick frying pan.
3. To reinsert the pan, place over the locking mechanism located on the bottom of the baking compartment. Push down. To remove the pan, pull up.
4. Remember to insert the kneading blade on the shaft located in the bread pan before adding your ingredients. It is not necessary to remove the kneading blade after you make every loaf of bread. Always be certain that the dough hook is securely screwed in the pan..
5. Since the bread pan will be hot after the baking cycle, always use a kitchen mitt or pot holder when removing it;
6. To remove the bread from the pan, remove the dough hook, invert upside down and gently shake up and down until the loaf slides out. If the bread does not come out of the pan easily, use a non-metallic kitchen utensil to pry it out.

KNEADING, RISING, AND BAKING CYCLES

This chart is provided so that you will better understand how your Welbilt® Bread Machine works.

PROGRAM	NORMAL (MINUTES)		RAPID (MINUTES)		DOUGH (MINUTES)	
	Reg	L	Reg	L	Reg	L
	Mixing/First Kneading	10	15	10	15	10
Rest	28	32	8	12	30	30
Second Kneading/ Add Nuts/Fruit	12	23	12	23	12	23
First Rise	20	20	10	10	20	20
Punch Down	2 sec	2 sec	2 sec	2 sec	2 sec	2 sec
Second Rise	60	60	60	60	—	—
Baking	50	50	50	50	—	—
Total Program (hour:min)	3:00	3:20	2:30	2:50	1:12	1:28
Keep Warm (hours)	3	3	3	3	—	—

PROGRAM	SWEET (MINUTES)		RAPID SWEET (MINUTES)		SWEET DOUGH (MINUTES)	
	Reg	L	Reg	L	Reg	L
	Mixing/First Kneading	10	15	10	15	10
Rest	28	32	8	12	30	30
Second Kneading/ Add Nuts/Fruit	12	23	12	23	12	23
First Rise	20	20	10	10	20	20
Punch Down	2 sec	2 sec	2 sec	2 sec	2 sec	2 sec
Second Rise	60	60	60	60	—	—
Baking	50	50	50	50	—	—
Total Program (hour:min)	3:00	3:20	2:30	2:50	1:12	1:28
Keep Warm (hours)	3	3	3	3	—	—

Mixing/First Kneading: The Bread Machine will intermittently mix the ingredients So, 2 minutes at which time it will then begin to knead the dough to (arm a smooth, elastic ball.

Second Kneading: Knead the dough makes the gluten elastic enough to form the structure of the bread.

Add Fruit/Nuts: The Bread Machine will beep B times, 5 minutes before the end of the second kneading. This is the best time to add ingredients like nuts and raisins, etc.

First Rise: When dough has been well-kneaded, the gluten forms thin elastic strands that make up the structure of the bread. As the yeast develops and multiplies, it produces carbon dioxide gas. The gas becomes trapped in the gluten strands, forming bubbles. As these bubbles collect, the dough expands and rises.

Punch Down: The Bread Machine kneads the dough for 30 seconds to deflate it,

Second Rise: The gluten strands are now strong enough to support the loaf. The yeast will once again produce carbon dioxide gas and the dough will rise to its maximum height.

Baking: The bread will be baked to perfection when using any program except DOUGH.

Keep Warm: I you are unable to remove the bread immediately after baking, the Bread Machine will keep the loaf warm to reduce the effects of the condensation that will form between the bat and the pan. Nevertheless, always remove the bread as quickly as possible after the baking cycle.

HOW TO MAKE BREAD OR DOUGH

Always use the freshest ingredients available. By carefully following the simple recipes that come with your Bread Machine, you will be able to make delicious homemade bread and dough every time.

Step 1

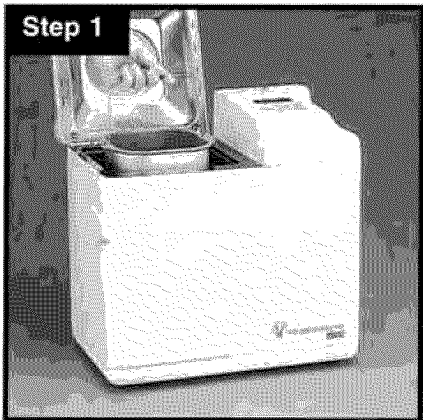

Remove the baking pan from the Bread Machine.

Step 2

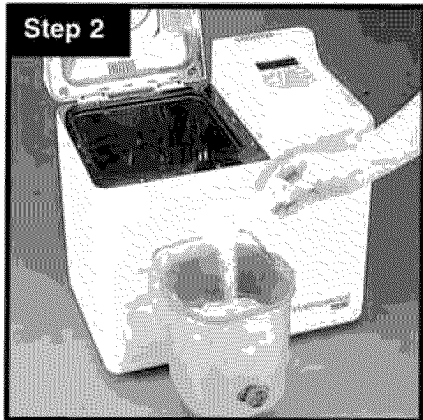

Carefully measure ingredients and place in the pan as specified in the recipe.

Step 3

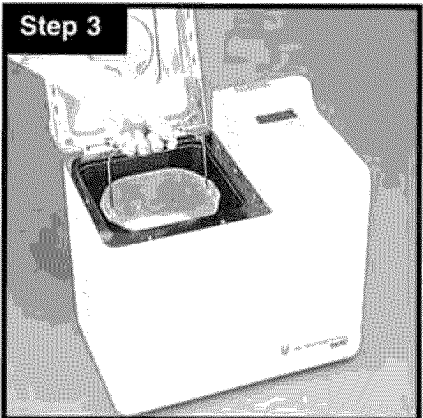

Place the pan in the Bread Machine and lock into position.

Step 4

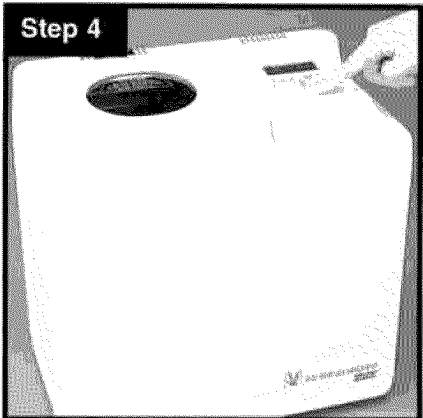

Select the program you plan to use. (See page 11)

Step 5

Press START.

Step 6

If you plan to make a bread or dough with raisins, dried fruits or nuts, add these ingredients when the Bread Machine beeps eight times, five minutes before the end of the second kneading cycle. When making bread automatically, the Bread Machine will beep at the end of the baking cycle indicating that the bread is done. Although the Bread Machine has a 3 hour keep warm cycle, the baked bread is best removed from tilt appliance and the pan immediately after baking. Use a kitchen mitt i pot holder to carefully remove the bread pan by pulling up and out. Unscrew and remove the dough hook from the pan. Invert the pan and remove bread. Let cool for one hour before slicing.

Step 7

Press STOP/RESET to end the bread making program.

Step 8

If you are, only making dough, the Bread Machine will beep at the end of the program. Press STOP/RESET, remove dough and hand-shape according to recipe.

RECIPES AND BAKING GUIDE

PREPARATION FOR GOOD RESULTS

Your Welbilt Bread Machine produces satisfying results if you carefully follow directions and use the indicated ingredients.

1. Bread Flour: When making bread in a bread machine be sure to always use bread flour which is available in 5 lb. bags in your local supermarket. Bread flour is higher in gluten, a natural protein found in wheat that gives bread its chewy texture and high volume.
2. Active Dry Yeast: Yeast is a living organism that when mixed with liquids and starch multiplies producing carbon dioxide gas which causes the dough to rise. We recommend that you use active dry yeast when making bread or dough in the bread machine.
3. Sweetener and Salt: The addition of a sweetener to a recipe is important because it supplies the yeast with food. Without the sweetener the dough will rise slower and may not reach its maximum height prior to baking. Salt helps to stabilize the yeast so that the dough rises evenly.
- 4., Non-fat Dry Milk: We recommend that you use non-fat dry milk when making bread in the bread machine since it will not spoil.
5. Shortening: Always use stick butter or margarine and never whipped or soft.
6. Water and Liquids: All liquid temperatures should be between 75' and 80

HOW TO JUDGE IF THINGS ARE GOING WELL

1. Always measure the ingredients carefully using U.S. standard measuring cups and spoons. Kitchen flatware and coffee cups vary in size and should never be used. All ingredients should be at room temperature unless otherwise noted in recipe. Since you will be using all natural ingredients to make your homemade bread, the quality of the ingredients is important. Since flour is milled from wheat and other grains, the quality and make up of the flour will vary from crop to crop and from year to year even though the mills make every attempt to blend the grains for proper consistency.

Nevertheless, you may see that your bread does not come out the same when using flour from a different brand. If this the case, we suggest that you experiment. (If, for example, the bread made from brand X bread flour does not provide a satisfactory loaf of bread, try another brand. The same applies to yeast.) Some packages of yeast will provide greater rising activity than others. If your bread does not rise well, try another package of yeast or another brand. We have also seen that certain brands of yeast work better with certain brands of flour. (Experiment until you find the combination that works best for you.)

2. Although the quality of the bread should not be affected by the type! source of water used, extremely hard or soft water can determine whether a loaf of bread is good or bad. If your water falls in this category, only make bread using bottled spring water with a low mineral content or try substituting low fat milk for the water.

3 After the first kneading cycle, the ball of kneaded dough should be smooth and elastic. The top of the dot should be slightly sticky and should begin to fill out on the bottom of the pan while rising. If the dough appears stiff and lumpy, it is too dry. You should add an additional one or two tablespoons of water at the inside edge of the pan once the Bread Machine begins the second kneading cycle. Dough that is too dry can result in short loaves of bread which appear overbaked.

4. When measuring flour never scoop it out of the bag or the canister with the measuring cup. Always spoon the flour into the cup. Insert a clean kitchen knife into the flour a couple of times to eliminate clumps or air pockets. Level off the top of the cup with the knife. Never pack the flour down.

5. If the dough appears to be very loose and sticky, it is too moist. You can overcome this problem by making sure you measure the ingredients properly or add less water (approximately one to two tablespoons less) to compensate for a higher than normal moisture content of the flour. (Dough that is too moist can result in over-risen, collapsed, wrinkled loaves of bread.)

6. Always set your Bread Machine on the proper baking setting as specified in the recipe. If the bread bakes too dark, try a lighter setting. If the bread continues to bake too dark the dough may be too dry inhibiting the bread from rising properly. (Try adding one to two tablespoons of additional water for better baking results.)Too much sugar in a recipe may also cause bread to over bake. The same is true with dried fruits. Try cutting down on the amount called for in the recipe by 25 to 50%.

7. Do not use your Bread Machine if the room temperature is lower than 65°F since the dough will not rise well and the loaves will be short. If the ambient temperature is higher than 85°F the dough can over-rise and the bread can possibly collapse or wrinkle during baking and the crumb texture will be course. The ideal temperature for making bread is always 68° to 80°F.

8. For a crisp, crunchy crust, always remove the bread from the Bread Machine after the baking cycle. Remove from the pan and let cool on a wire rack in a draft free. For a softer crust, immediately place the baked loaf of bread in an open plastic bag or loosely wrap in foil.

91 The size of the baked loaf will vary from loaf to loaf due to ingredients and ambient conditions. Nevertheless, the general rule is that the bread size should be near the top of the pan to 1-inch below.

SPECIAL NOTE:

Wheat harvests can vary from crop to crop. This can affect the natural protein level of the flour. Commercial bakers may add a natural dough conditioner to their bread doughs to achieve uniform and consistent results.

If you should experience periodic inconsistencies when making any of the recipes, we suggest that you try adding 1 teaspoon of lemon juice. The lemon juice will help strengthen the dough for better baking results. It will not affect the taste of the bread.

WHITE BREAD

	1 lb. Loaf	1.1/2 lb. Loaf	2 lb. Loaf
active dry yeast	1 tsp	1-1/2 tsp	1-1/2 tsp
breadflour	2 cups	3 cups	4 cups
granulated sugar	1 Tbs	2 Tbs	2 Tbs
salt	1 tsp	1-1/4 tsp	2 tsp
nonfat dry milk	1 Tbs	2 Tbs	2 Tbs
butter/margarine	1 Tbs	1 Tbs	2 Tbs
water	3/4 cup	1 cup plus 2 Tbs	1-1/4 c. plus 1 Tbs

All ingredients should be at room temperature, unless otherwise noted. Add the ingredients in the order listed above.

Choose either the NORMAL or RAPID NORMAL program by pushing the SELECT button. Determine the size of the loaf you plan to make and press the LOAF SIZE button for either REGULAR (1 lb. loaf) or LARGE (1-1/2 or 2 lb. loaf). Press the BAKING CONTROL button for MEDIUM. Press START.

1 pound loaf will be ready in 3 hours (NORMAL); or 2 hours, 30 minutes (RAPID NORMAL). 1-1/2 pound loaf will be ready in 3 hours, 20 minutes (NORMAL); or 2 hours, 50 minutes (RAPID NORMAL). 2 pound loaf will be ready in 3 hours, 20 minutes (NORMAL); or 2 hours, 50 minutes (RAPID NORMAL).

HINT: Due to varying flour conditions, the may appear too dry after kneading the first couple of minutes. If this is the case, press STOP! RESET. Press START and add additional water, a tablespoon at a time, until the dough appears elastic. Do not exceed the following recommendations:

2 Cup Flour Capacity: No more than 2 Tbs additional water.

3 Cup Flour Capacity: No more than 3 Tbs additional water.

4 Cup Flour Capacity: No more than 3 Tbs additional water.

WHOLE WHEAT BREAD

	1 lb. Loaf	1-1/2 lb. Loaf	2 lb. Loaf
active dry yeast	1-1/2 tsp	1-1/2 tsp	1-1/2 tsp
whole wheat flour	1 cup	1-1/2 cups	2 cups
bread flour	1 cup	1-1/2 cups	2 cups
granulated sugar	1 Tbs	2 Tbs	2 Tbs
salt	1 tsp	1-1/4 tsp	1-1/2 tsp
nonfat dry milk	1 Tbs	2 Tbs	2 Tbs
butter/margarine	1 Tbs	1 Tbs	2 Tbs
water	3/4 cup plus 1 Tbs	1-1/4 cup less 1 Tbs	1-1/4 c. plus 2 Tbs

All ingredients should be at room temperature, unless otherwise noted. Add the ingredients in the order listed above.

Choose either the NORMAL or RAPID NORMAL program by pushing the SELECT button. Determine the size of the loaf you plan to make and press the LOAF SIZE button for either REGULAR (1 lb. loaf) or LARGE (1-1/2 or 2 lb. loaf). Press the BAKING CONTROL button for MEDIUM. Press START. 1 pound loaf will be ready in 3 hours (NORMAL); or 2 hours, 30 minutes (RAPID NORMAL). 1-1/2 pound loaf will be ready in 3 hours, 20 minutes (NORMAL); or 2 hours, 50 minutes (RAPID NORMAL). 2 pound loaf will be ready in 3 hours, 20 minutes (NORMAL); or 2 hours, 50 minutes (RAPID NORMAL).

HINT: Due to varying flour conditions, the dough may appear too dry after kneading the first couple of minutes. If this is the case, press STOP/ RESET. Press START and add additional water, a tablespoon at a time, until the dough appears elastic. Do not exceed the following recommendations:

2 Cup Flour Capacity: No more than 2 Tbs additional water.

3 Cup Flour Capacity: No more than 3 Tbs additional water.

4 Cup Flour Capacity: No more than 3 Tbs additional water.

MAPLE WALNUT WHEAT BREAD

	1 lb. Loaf	1-1/2 lb Loaf	2 lb Loaf
active dry yeast	1-1/2 tsp	1-1/2 tsp	1-1/2 tsp
bread flour	1-1/2 cups	2 cups	3 cups
whole wheat flour	1/2 cup	1 cup	1 cup
salt	1 tsp	1-1/4 tsp	2 tsp
buttermilk powder	1 Tbs	2 Tbs	2 Tbs
butter/margarine	1 Tbs	1-1/2 Tbs	2 Tbs
maple syrup	1-1/2 Tbs	1-1/2 Tbs	1-1/2 Tbs
maple flavor	1 tsp	1 tsp	1 tsp
water	3/4 cup	1 cup	1 cup plus 2 Tbs
chopped walnuts	1/3 cup	1/2 cup	2/3 cup

All ingredients should be at room temperature, unless otherwise noted. Add the ingredients in the order listed above.

Choose either the NORMAL or RAPID NORMAL program by pushing the SELECT button. Determine the size of the loaf you plan to make and press the LOAF SIZE button for either REGULAR (1 lb. loaf) or LARGE (1-1/2 or 2 lb. loaf). Press the BAKING CONTROL button for MEDIUM. Press START. Add nuts when the bread machine beeps 8 times, 5 minutes before the end of the second kneading.

1 pound loaf will be ready in 3 hours (NORMAL); or 2 hours, 30 minutes (RAPID NORMAL). 1-1/2 pound loaf will be ready in 3 h 20 minutes (NORMAL); or 2 hours, 50 minutes (RAPID NORMAL). 2 pound loaf will be ready in 3 hours, 20 minutes (NORMAL); or 2 hours, 50 minutes (RAPID NORMAL).

HINT: Due to varying flour conditions, the dough may appear too dry after kneading the first couple of minutes. If this is the case, press STOP/RESET. Press START and add additional water, a tablespoon at a time, until the dough appears elastic. Do not exceed the following recommendations:

2 Cup Flour Capacity: No more than 2 Tbs additional water.

3 Cup Flour Capacity: No more than 3 Tbs additional water.

4 Cup Flour Capacity: No more than 3 Tbs additional water.

RYE BREAD

	1 lb. Loaf	1.1/2 lb. Loaf	2 lb. Loaf
active dry yeast	1-1/2 tsp	1-1/2 tsp	1-1/2 tsp
medium rye flour	1/2 cup	1/2 cup	1 cup
bread flour	1-1/2 cups	2-1/2 cups	3 cups
dark brown sugar	1 Tbs	2 Tbs	2 Tbs
salt	1 tsp	1 tsp	2 tsp
nonfat dry milk	1 Tbs	2 Tbs	2 Tbs
caraway seeds	1-1/2 tsp	1 Tbs	1 Tbs
butter/margarine	1 Tbs	1-1/2 Tbs	2 Tbs
water	3/4 cup	1 cup	1-1/4 cups plus 1 Tbs

All ingredients should be at room temperature, unless otherwise noted. Add the ingredients in the order listed above.

Choose either the NORMAL or RAPID NORMAL program by pushing the SELECT button. Determine the size of the loaf you plan to make and press the LOAF SIZE button for either REGULAR (1 lb. loaf) or LARGE (1-1/2 or 2 lb. loaf). Press the BAKING CONTROL button for MEDIUM. Press START.

1 pound loaf will be ready in 3 hours (NORMAL); or 2 hours, 30 minutes (RAPID NORMAL). 1-1/2 pound loaf will be ready in 3 hours, 20 minutes (NORMAL); or 2 hours, 50 minutes (RAPID NORMAL). 2, pound loaf will be ready in 3 hours, 20 minutes (NORMAL); or 2 hours, 50 minutes (RAPID NORMAL).

HINT: Due to varying flour conditions, the dough may appear too dry after kneading the first couple of minutes. If this is the case, press STOP/RESET. Press START and add additional water, a tablespoon at a time, until the dough appears elastic. Do not exceed the following recommendations:

2 Cup Flour Capacity: No more than 2 Tbs additional water.

3 Cup Flour Capacity: No more than 3 Tbs additional water.

4 Cup Flour Capacity: No more than 3 Tbs additional water.

ONION BREAD

	1lb Loaf	1-1/2 lb. Loaf	2lb. Loaf
active dry yeast	1-1/2 tsp	1-1/2 tsp	1-1/2 tsp
bread flour	2 cups	3 cups	4 cups
granulated sugar	1 Tbs	1 Tbs	2 Tbs
onion soup mix	1/2 packet (1/2 oz)	1 packet (1 oz.)	1 packet (1 oz.)
nonfat dry milk	1 Tbs	1-1/2 Tbs	2 Tbs
sweet butter/margarine	1-1/2 Tbs	1-1/2 Tbs	2 Tbs
water	3/4 cup less 1 Tbs	1 cup plus 1 Tbs	1-1/4 cups

All ingredients should be at room temperature, unless otherwise noted. Add the ingredients in the order listed above. (Please note, salt in this recipe is provided by the dry onion soup mix.)

Choose either the NORMAL or RAPID NORMAL program by pushing the SELECT button. Determine the size of the loaf you plan to make and press the LOAF SIZE button for either REGULAR (1 lb. loaf) or LARGE (1-1/2 or 2 lb. loaf). Press the BAKING CONTROL button for MEDIUM. Press START.

1 pound loaf will be ready in 3 hours (NORMAL); or 2 hours, 30 minutes (RAPID NORMAL). 1-1/2 pound loaf will be ready in 3 hours, 20 minutes (NORMAL); or 2 hours, 50 minutes (RAPID NORMAL). 2 pound loaf will be ready in 3 hours, 20 minutes (NORMAL); or 2 hours, 50 minutes (RAPID NORMAL).

HINT: Due to varying flour conditions, the dough may appear too dry after kneading the first couple of minutes. If this is the case, press STOP/RESET. Press START and add additional water, a tablespoon at a time, until the dough appears elastic. Do not exceed the following recommendations:

2 Cup Flour Capacity: No more than 2 Tbs additional water.

3 Cup Flour Capacity: No more than 3 Tbs additional water.

4 Cup Flour Capacity: No more than 3 Tbs additional water.

CHEVRE CRACKED-PEPPER BREAD

	1 lb. Loaf	1-1/2 lb. Loaf	2 lb. Loaf
active dry yeast	1-1/2 tsp	1-1/2 tsp	1-1/2 tsp
breadflour	2 cups	3 cups	4 cups
granulated sugar	1 Tbs	1-1/2 Tbs	2 Tbs
salt	1/2 tsp	1 tsp	2 tsp
cracked black pepper	1-1/2 tsp	1 Tbs	1-1/2 Tbs
nonfat dry milk	1 Tbs	1-1/2 Tbs	2 Tbs
soft goat cheese	3 Tbs.	4 Tbs	6 Tbs
water	3/4 cup less 2 Tbs	1 cup less 1 Tbs	1 cup plus 1 Tbs

All ingredients should be at room temperature, unless otherwise noted. Add the ingredients in the order listed above.

Choose either the NORMAL or RAPID NORMAL program by pushing the SELECT button. Determine the size of the loaf you plan to make and press the LOAF SIZE button for either REGULAR (1 lb. loaf) or LARGE (1-1/2 or 2 lb. loaf). Press the BAKING CONTROL button for MEDIUM. Press START.

1 pound loaf will be ready in 3 hours (NORMAL); or 2 hours, 30 minutes (RAPID NORMAL). 1-1/2 pound loaf will be ready in 3 hours, 20 minutes (NORMAL); or 2 hours, 50 minutes (RAPID NORMAL). 2 pound loaf will be ready in 3 hours, 20 minutes (NORMAL); or 2 hours, 50 minutes (RAPID NORMAL).

HINT: Due to varying flour conditions, the dough may appear too dry after kneading the first couple of minutes. If this is the case, press STOP/ RESET. Press START and add additional water, a tablespoon at a time, until the dough appears elastic. Do not exceed the following recommendations:

2 Cup Flour Capacity: No more than 2 Tbs additional water.

3 Cup Flour Capacity: No more than 3 Tbs additional water.

4 Cup Flour Capacity: No more than 3 Tbs additional water

CHEDDAR BACON BREAD

	1 lb Loaf	1-1/2 lb Loaf	2 lb Loaf
active dry yeast	1-1/2 tsp	1-1/2 tsp	1-1/2 tsp
bread flour	2 cups	3 cups	4 cups
granulated sugar	1 Tbs	1 Tbs	2 Tbs
salt	1 tsp	1-1/4 tsp	2 tsp
nonfat dry milk	1 Tbs	2 Tbs	2 Tbs
water	3/4 cup less 1 Tbs	1 cup	1 cup plus 2 Tbs
shredded sharp cheddar cheese			
	2/3 cup	1 cup	1-1/3 cup
crisp, fried, crumbled bacon			
	1/4 cup	1/3 cup	1/2 cup

All ingredients should be at room temperature, unless otherwise noted. Add the ingredients in the order listed above.

Choose either the NORMAL or RAPID NORMAL program by pushing the SELECT button. Determine the size of the loaf you plan to make and press the LOAF SIZE button for either REGULAR (1 lb. loaf) or LARGE (1-1/2 or 2 lb. loaf). Press the BAKING CONTROL button for MEDIUM. Press START. Add cheese and bacon when the bread machine beeps 8 times, 5 minutes before the end of the second kneading.

1 pound loaf will be ready in 3 hours (NORMAL); or 2 hours, 30 minutes (RAPID NORMAL). 1-1/2 pound loaf will be ready in 3 hours, 20 minutes (NORMAL); or 2 hours, 50 minutes (RAPID NORMAL). 2 pound loaf will be ready in 3 hours, 20 minutes (NORMAL); or 2 hours, 50 minutes (RAPID NORMAL).

HINT: Due to varying flour conditions, the dough may appear too dry after kneading the first couple of minutes. If this is the case, press STOP/ RESET. Press START and add additional water, a tablespoon at a time, until the dough appears elastic. Do not exceed the following recommendations:

2 Cup Flour Capacity: No more than 2 Tbs additional water.

3 Cup Flour Capacity: No more than 3 Tbs additional water.

4 Cup Flour Capacity: No more than 3 Tbs additional water.

EGG BREAD

	1 lb. Loaf	1-1/2 lb. loaf	2 lb. loaf
active dry yeast	1-1/2 tsp	1-1/2 tsp	1-1/2 tsp
bread flour	2 cups	3 cups	4 cups
granulated sugar	1 Tbs	2 Tbs	2 Tbs
salt	1 tsp	1-1/4 tsp	2 tsp
nonfat dry milk	1 Tbs	2 Tbs	2 Tbs
butter/margarine	1 Tbs	1 Tbs	2 Tbs
water	3/4 cup less 1 Tbs	1 cup plus 1 Tbs	1-1/4 c. less 1 Tbs
large egg yolk	1	1	2

All ingredients should be at room temperature, unless otherwise noted. Add the ingredients in the order listed above.

Choose either the NORMAL or RAPID NORMAL program by pushing the SELECT button. Determine the size of the loaf you plan to make and press the LOAF SIZE button for either REGULAR (1 lb. loaf) or LARGE (1-1/2 or 2 lb. loaf). Press the BAKING CONTROL button for MEDIUM. Press START.

1 pound loaf will be ready in 3 hours (NORMAL); or 2 hours, 30 minutes (RAPID NORMAL). 1-1/2 pound loaf will be ready in 3 hours, 20 minutes (NORMAL); or 2 hours, 50 minutes (RAPID NORMAL). 2 pound loaf will be ready in 3 hours, 20 minutes (NORMAL); or 2 hours, 50 minutes (RAPID NORMAL).

HINT: Due to varying flour conditions, the dough may appear too dry after kneading the first couple of minutes. If this is the case, press STOP/ RESET. Press START and add additional water, a tablespoon at a time, until the dough appears elastic. Do not exceed the following recommendations:

- 2 Cup Flour Capacity: No more than 2 Tbs additional water.
- 3 Cup Flour Capacity: No more than 3 Tbs additional water.
- 4 Cup Flour Capacity: No more than 3 Tbs additional water.

CINNAMON NUT RAISIN BREAD

	1 lb. Loaf	1-1/2 lb. Loaf	2 lb. Loaf
active dry yeast	1-1/2 tsp	1-1/2 tsp	1-1/2 tsp
bread flour	2 cups	3 cups	4 cups
salt	1 tsp	1-1/2 tsp	2 tsp
granulated sugar	1/2 Tbs	1/2 Tbs	1 Tbs
brown sugar	1/2 Tbs	1 Tbs	1 Tbs
cinnamon	1-1/2 tsp	1-1/2 tsp	1-1/2 tsp
nonfat diy milk	1 Tbs	2 Tbs	2 Tbs
butter/margarine	1 Tbs	2 Tbs	2 Tbs
water	3/4 cup	1 cup plus 2 Tbs	1-1/4 c. plus 1 Tbs
raisins	1/4 cup	1/2 cup	1/2 cup
chopped walnuts	1/4 cup	1/2 cup	1/2 cup

All ingredients should be at room temperature, unless otherwise noted. Add the ingredients in the order listed above.

Choose either the NORMAL or RAPID NORMAL program by pushing the SELECT button. Determine the size of the loaf you plan to make and press the LOAF SIZE button for either REGULAR (1 lb. loaf) or LARGE (1-1/2 or 2 lb. loaf). Press the BAKING CONTROL button for MEDIUM. Press START. Add raisins and nuts when the bread machine beeps 8 times, 5 minutes before the end of the second kneading.

1 pound loaf will be ready in 3 hours (NORMAL); or 2 hours, 30 minutes (RAPID NORMAL). 1-1/2 pound loaf will be ready in 3 hours, 20 minutes (NORMAL); or 2 hours, 50 minutes (RAPID NORMAL). 2 pound loaf will be ready in 3 hours, 20 minutes (NORMAL); or 2 hours, 50 minutes (RAPID NORMAL).

HINT: Due to varying flour conditions, the dough may appear too dry after kneading the first couple of minutes. If this is the case, press STOP! RESET. Press START and add additional water, a tablespoon at a time, until the dough appears elastic. Do not exceed the following recommendations:

2 Cup Flour Capacity: No more than 2 Tbs additional water.

3 Cup Flour Capacity: No more than 3 Tbs additional water.

4 Cup Flour Capacity: No more than 3 Tbs additional water.

WHOLE WHEAT ROLLS

active dry yeast 2-1/4 teaspoons whole wheat flour 2 cups salt 1
teaspoon honey 2 tablespoons baking soda 1/4 teaspoon large egg 1
undrained cottage cheese 1 cup

water 2-4 tablespoons (depending on how wet your cottage cheese is)

All ingredients should be at room temperature, unless otherwise noted.
Add the ingredients in the order listed above.

Press the SELECT button for DOUGH NORMAL. Press the LOAF SIZE
button for REGULAR. Press START. The dough will be ready in 1 hour,
12 minutes.

HAND-SHAPING

To shape rolls, place dough on a lightly floured work surface. Cut into
9 equal pieces. Roll each piece into a ball and place in a lightly greased
9- inch square baking pan. Cover with a clean cloth and let rise in a
warm, draft-free spot until doubled in size.

Brush tops of rolls with a lightly beaten egg white. Bake in a 350°F.
pre heated oven for 20 to 25 minutes or until tops are deeply
browned. Re move rolls from pan and let cool on a wire rack.

FRENCH BREAD (BAGUETTES)

active dry yeast 1 teaspoon

bread flour 3 cups

salt 1 teaspoon

granulated sugar 1/2 teaspoon

water 1 cup plus 1 tablespoon

All ingredients should be at room temperature, unless otherwise noted. Add the ingredients in the order listed above.

Press the SELECT button for DOUGH NORMAL. Press The LOAF SIZE button for LARGE. Press START. The dough will be ready in 1 hour, 28 minutes.

HAND-SHAPING

Place dough on a lightly floured work surface. Let dough rest for 5 minutes.

Divide dough into 2 equal portions. Roll each portion into a 1 2-inch long rope and place on a lightly greased baking sheet.

Slash the top of each baguette 3 to 5 times with a very sharp knife or a pair of scissors. Place in a warm, draft-free spot to rise until almost doubled in size, about 45 minutes.

Spritz the unbaked baguettes with cold water from a fine mist atomizer and place in a 450° F preheated oven for 3 minutes. Spritz again, and bake another minutes. Spritz a third time and bake until nicely browned and hollow sounding when tapped, approximately 25 to 30 minutes total. Transfer baked baguettes to a wire rack to cool slightly before serving.

HINT: Due to varying flour conditions, the dough may appear too dry after

kneading the first couple of minutes. If this is the case, press STOP/RE SET. Press START and add additional water, a tablespoon at time, until the dough appears elastic. Do not exceed the following recommendations:

2 Cup Flour Capacity: No more than 2 tablespoons additional water.

3 Cup Flour Capacity: No more than 3 tablespoons additional water.

4 Cup Flour Capacity: No more than 3 tablespoons additional water.

PIZZA DOUGH

	Two 12-inch pizzas	Four 12-inch Pizzas
active dry yeast	1-3/4 tsp	2 tsp
bread flour	2-1/2 cups	4 cups
salt	1 tsp	1-1/2 tsp
granulated sugar	1/2 tsp	3/4 tsp
olive oil	1-1/2 Tbs	2-1/2 Tbs
water	1 cup less 2 Tbs	1-1/4 cups

All ingredients should be at room temperature, unless otherwise noted. Add the ingredients in the order listed above.

Press the SELECT button for DOUGH NORMAL. Press the LOAF SIZE button for either REGULAR (2 pizzas) or LARGE (4 pizzas). Press START. The dough will be ready in 1 hour, 12 minutes (2 pizzas) or 1 hour, 28 minutes (4 pizzas).

HAND-SHAPING

Preheat oven to 400°F.

Place dough on a lightly floured surface. Cover dough with a clean cloth, and let dough rest for 10 minutes. Cut into halves (or quarters for 4 pizzas). Press each evenly into a lightly greased 12-inch pizza pan. Spread! Sprinkle crust with your favorite pizza toppings.

Bake for 10 to 15 minutes, or until toppings are melted and bubbling.

HINT: Due to varying flour conditions, the dough may appear too dry after kneading the first couple of minutes. If this is the case, press STOP/RESET. Press START and add additional water, a tablespoon at a time, until the dough appears elastic. Do not exceed the following recommendations:

2 Cup Flour Capacity: No more than 2 Tbs additional water.

3 Cup Flour Capacity: No more than 3 Tbs additional water.

4 Cup Flour Capacity: No more than 3 Tbs additional water.

BREAD STICKS

One recipe for Pizza dough (see Page 32).

TOPPINGS:

1 large egg beaten with one teaspoon water

2 tablespoons finely grated Parmesan or sharp Cheddar cheese or 1
tablespoon of seeds or herbs/spices

HAND-SHAPING

Place prepared dough onto a lightly floured surface. Cover with a clean kitchen cloth and let rest for 5 minutes. With a lightly floured rolling pin, roll dough into a 1/4 inch rectangle. Square off the edges. Brush the surface with beaten egg. Sprinkle lightly with grated Parmesan or Cheddar cheese, or desired seeds, herbs or spices. Cut into 8-inch long 1/4 inch wide strips. Carefully place on a lightly greased baking sheet, allowing a 1/2 inch between each bread stick. Bake in preheated 375°F oven for 15 to 20 minutes or until golden brown.

CHALLAH

Prepare one 1 lb. recipe for egg bread (see page 26) by using the dough program.

PREPARE AND RESERVE

1 large egg beaten with 1 teaspoon water

OPTIONAL TOPPING

1 teaspoon poppy or sesame seeds

All ingredients should be at room temperature, unless otherwise noted. Add the ingredients in the order listed above.

Press the SELECT button for DOUGH SWEET. Press the LOAF SIZE button for REGULAR. Press START. The dough will be ready in 1 hour, 12 minutes.

HAND-SHAPING

Place the dough on a lightly floured surface. Cover with a clean cloth and let the dough rest for 5 minutes. Divide the dough into three equal pieces. Shape each piece into a 14-inch rope by rolling back and forth with your fingertips. The easiest way to do this is to start in the center and by applying even pressure, roll the dough back and forth from the center to the ends.

Lay the three pieces of shaped dough side by side and pinch top ends together. Braid the dough and pinch bottom ends together. Tuck the ends under and place the braid on a lightly greased baking sheet. Cover with a clean kitchen cloth and let rise until doubled in size in a warm, draft-free spot.

Brush the braid with the beaten egg and sprinkle with seeds, if desired. Bake in a 375°F preheated oven for 25 to 30 minutes, or until deep golden brown.

sheet which has been tightly sprinkled with cornmeal. Sprinkle bagels with optional toppings. Bake in a 375°F preheated oven for 20 to 25 minutes, or until golden brown.

HINT: Due to varying flour conditions, the dough may appear too dry after

kneading the first couple of minutes. If this is the case, press STOP/RESET. Press START and add additional water, a tablespoon at a time, until

the dough appears elastic. Do not exceed the following recommendations:

2 Cup Flour Capacity: No more than 2 tablespoons additional water.

3 Cup Flour Capacity: No more than 3 tablespoons additional water.

4 Cup Flour Capacity: No more than 3 tablespoons additional water.

HINT: Due to varying flour conditions, the dough may appear too dry after kneading the first couple of minutes. If this is the case, press STOP! RESET. Press START and add additional water, a tablespoon at a time, until the dough appears elastic. Do not exceed the following recommendations:

2 Cup Flour Capacity: No more than 2 tablespoons additional water.

3 Cup Flour Capacity: No more than 3 tablespoons additional water.

4 Cup Flour Capacity: No more than 3 tablespoons additional water.

DANISH PASTRIES

Pastry

active dry yeast 2 teaspoons

bread flour 2 cups

salt 1 teaspoon

granulated sugar 2 tablespoons

cold, unsalted butter cut into 24 pieces 5 tablespoons

large egg yolk 1

milk 1/2 cup

water 1/4 cup

Glaze and Fillings

egg white 1

fruit filling, jam or preserves 3/4 cup

All ingredients should be at room temperature, unless otherwise noted. Add the ingredients in the order listed above.

Press the SELECT button for DOUGH SWEET. Press the LOAF SIZE button for REGULAR. Press START. The dough will be ready in 1 hour, 12 minutes.

HAND-SHAPING

Place the dough in a lightly greased 3-quart bowl. Tightly cover with foil or plastic wrap and refrigerate 8 to 24 hours. Remove from the refrigerator and punch down. Place the dough on a lightly floured work surface and divide into 12 equal pieces. Roll the dough in 16-inch long ropes. Coil each rope and tuck the end under the Danish. Place on a lightly greased baking sheet. Cover with a clean kitchen cloth and let rise until doubled in size in a warm, draft-free spot.

Make a deep indentation with your thumb in the center of each Danish and fill with fruit, jam or preserves. Brush the edges with the egg white glaze. Bake in a 375°F preheated oven for 15 to 20 minutes, or until golden brown.

HINT: Due to varying flour conditions, the dough may appear too dry after kneading the first couple of minutes. If this is the case, press STOP/RESET.

Press START and add additional water, a tablespoon at a time, until the dough appears elastic. Do not exceed the following recommendations:

2 Cup Flour Capacity: No more than 2 tablespoons additional water.

3 Cup Flour Capacity: No more than 3 tablespoons additional water.

4 Cup Flour Capacity: No more than 3 tablespoons additional water.

—40—

CINNAMON ROLLS

Prepare one recipe for holiday braid bread (see page 37). Do not add raisins. Use hand-shaping technique given on this page.

	1 lb Loaf	1-1/2 lb Loaf	2 lb Loaf
Brown Sugar Filling			
dark brown sugar	1/4 cup	1/3 cup	1/2 cup
cinnamon	1-1/2 tsp	2-1/2 tsp	3 tsp
softened butter	1-1/2 Tbs	2.1/2 Tbs	3 Tbs

Combine all ingredients to form a smooth paste. Set aside.

Icing

softened butter	2 Tbs	3 Tbs	4 Tbs
all-purpose flour	1-1/2 tsp	2 tsp	3 tsp
confectioner's sugar	1/4 cup	1/3 cup	1/2 cup
vanilla extract	1/2 tsp	1 tsp	1 tsp

Blend all ingredients until smooth. Set aside.

HAND-SHAPING

Place prepared dough on a lightly floured surface. Cover with a clean kitchen cloth and let dough rest for 5 minutes. With a lightly floured rolling P roll dough into a 1/4-inch thick rectangle. Square off edges. Spread evenly with brown sugar-cinnamon filling. Roll up lengthwise, jelly-roll fashion. Pinch the edges together. Slice into 1-inch thick rounds. Place on a lightly greased baking sheet. Cover it with a clean cloth and let rise until doubled in size. Bake in preheated 350°F oven for 15 to 20 minutes, until golden brown: Remove and cool on a rack. When cooled to room temperature, drizzle with icing.

HINT: Due to varying flour conditions, the dough may appear too dry after kneading the first couple of minutes. If this is the case, press STOP/RE SET. Press START and add additional water, a tablespoon at a time, until the dough appears elastic. Do not exceed the following recommendations:

2 Cup Flour Capacity: No more than 2 Tbs additional water.

3 Cup Flour Capacity: No more than 3 Tbs additional water.

4 Cup Flour Capacity: No more than 3 Tbs additional water.

CROISSANTS

Dough

active dry yeast 1-1/2 teaspoons

bread flour 2 cups

salt 1 teaspoon

granulated sugar 1 tablespoon

vegetable shortening 1 teaspoon

water 3/4 cup less 2 tablespoons

PREPARE AND RESERVE

chilled sweet butter, thinly sliced 1 sticks 1 large egg beaten with 1 teaspoon water

All ingredients should be at room temperature, unless otherwise noted. Mix the ingredients in the order listed above.

Press the SELECT button for DOUGH NORMAL. Press the LOAF SIZE button for REGULAR. Press START. The dough will be ready in 1 hour, 12 minutes.

HAND SHAPING

Place the dough on a lightly floured surface. Cover with a clean kitchen cloth and let dough rest for 5 minutes. With a lightly floured rolling pin, roll the dough into a 1 inch thick rectangle. Place the dough on a lightly greased baking sheet. Cover with a clean cloth and place in the freezer for one hour.

Remove the dough from the freezer. Place on a lightly floured surface and roll into a 1/4-inch thick rectangle. Cover the dough with chilled butter slices. Fold the dough in half. Gently roll with rolling pin into a 1/4-inch thick rectangle. Repeat folding process two more times. Place dough on previously greased baking sheet. Cover with clean cloth and place in refrigerator for one hour.

Remove dough from refrigerator and place on tightly floured surface. Fold dough in half and roll into a 1/4 inch rectangle. Repeat folding process two more times.

Place dough on greased baking sheet, cover with cloth and return to refrigerator for two more hours. Remove dough from refrigerator and place on a lightly floured surface. Roll into a 1/8-inch thick rectangle. Square off edges.

Cut dough in half lengthwise. Cut strips on an angle to form triangles. Brush lightly with egg wash.

Roll triangles up from broad end to the point. Form into crescents and place on lightly greased baking sheets. Cover with clean cloth and let rise in draft-free spot until doubled in size approximately one hour.

Bake in 350°F preheated oven approximately 20 minutes or until golden.

HINT: Due to varying flour conditions, the dough may appear too dry after kneading the first couple of minutes. If this is the case, press STOP, RESET. Press START and add additional water, a tablespoon at a time, until the dough appears elastic. Do not exceed the following recommendations:

2 Cup Flour Capacity: No more than 2 tablespoons additional water.

3 Cup Flour Capacity: No more than 3 tablespoons additional water.

4 Cup Flour Capacity: No more than 3 tablespoons additional water

CLEANING INSTRUCTIONS

If taken care of properly, your WelbiIt Bread Machine will provide you with many years of use and hundreds of loaves of delicious bread!

1 After each use, unplug the Bread Machine. Let the unit cool down to room temperature. Wipe out the baking compartment and the inner lid with a clean, damp cloth or sponge.

2. Remove the kneading blade from the pan. It may be necessary to fill the pan with water in order to loosen the blade from the shaft. Clean the pan and blade with warm water and mild dishwashing liquid. Never use abrasive or strong household cleaners since they will damage the non-stick finish. Towel dry.

3. Wipe down the cabinet of the Bread Machine with a clean, damp cloth or sponge. Towel dry.

CONSUMER ASSISTANCE

As with any new small electric appliance, carefully read the instructions and recipes before proceeding.

For mechanical or operational difficulties, refer to the Trouble Shooting Guide on Page 46 of this manual.

If you should encounter any difficulties or require baking assistance, please call our trained customer service assistants Monday • Friday, 9:00 AM to 5:00 PM Eastern time, at (516) 747-959

If a customer service assistant is unable to take your call, please leave a brief message. To enable us to assist you better, please specify your model number and the reason for your call. Every attempt will be made to return your call promptly. Please do not leave more than one message. In the event that we are unable to contact you the first time we return your call, we will make two additional attempts. During periods of peak baking, especially during and after holidays, it may take a couple of days before you hear from us. But, please be assured that every attempt will be made to answer your call in the order that it was received, as soon as possible.

To order a replacement part, or to obtain service on your Bread Machine please refer to the enclosed Parts Order Form. You may also call our Parts and Service Department at (516) 747-9595.

Please do not return your Bread Machine to Welbilt' without prior authorization.

TROUBLE SHOOTING GUIDE

Before calling for assistance, please read the following suggestions in order to achieve maximum satisfaction from your Bread Machine.

Problem: The Bread Machine will not start.

Cause: Appliance not plugged properly into wired outlet.

Solution: Always plug appliance into 120v, 60Hz outlet capable of providing up to 600 watts of electricity.

Cause: Programmable timer was set inadvertently.

Solution: Cancel program by pushing STOP/RESET. Select appropriate program and push START.

Problem: The Bread Machine does not mix the ingredients.

Cause: The dough hook and/or kneading blade were not placed in position.

Solution: Push STOP/RESET. Move the ingredients to the side of the pan and put in the dough hook and kneading blade.

Problem: The Bread Machine beeps when START button is pushed.

Cause: The Bread Machine is too hot to use after making a loaf of bread.

Solution: Remove the pan and let the Bread Machine cool down sufficiently before trying to make bread or dough.

Problem: The Bread Machine does not bake the bread.

Cause: The DOUGH program was selected.

Solution: To bake bread automatically, choose the appropriate program for making bread.

Problem: Baked loaf of bread soggy after removal from Bread Machine

Cause: Hot loaf of bread is not removed from appliance and pan after being baked.

Solution: Remove bread from pan as soon as possible after bread has finished baking.

Problem: Bread burns.

Cause: Baking temperature is too high.

Solution: Set Bread Machine on lower setting.

Cause: Recipe has been modified.

Solution: Reduce amount of sweetener and shortening.

Problem: Dough/Bread did not rise enough.

Cause: Ingredients were not at room temperature. Ingredients were not placed in the Bread Pan in the recipes recommended order.

Solution: Ingredients must be at room temperature unless otherwise noted. Place ingredients in the Bread Pan in the recommended order.

Cause: Yeast did not activate.

Solution: Be certain yeast is fresh, check expiration date on the package. Do not reduce amount of sugar or sweetener called for in the recipe, do not use artificial sweetener.

Cause: Too much salt used inhibiting rising.

Solution: Use amount specified in the recipe.

Cause: High altitude

Solution: For every 1000 feet above 3,000 feet sea level, reduce the water by 1 tablespoon. up to 4 tablespoons maximum.

Problem: Bread collapses when baked.

Cause: Dough rose unevenly.

Solution: Make sure water is no warmer than room temperature (75 to 80F). The flour is very absorbent and absorbs moisture from the air during periods of excessive humidity. If dough is too sticky, the bread can collapse. Reduce the water or liquid in the recipe by up to 4 tablespoons. Let appliance knead for 1 to 2 minutes. If the dough

appears too dry, add additional water 1 tablespoon at a time, up to 3 tablespoons.

SPECIFICATIONS

MODEL: ABM4100T

POWER REQUIREMENT: 120V AC, 60Hz

POWER CONSUMPTION:

HEATER: 600 watts

MOTOR: 100 watts

MAXIMUM FLOUR CAPACITY:

BREAD: 2, 3, 4 cups

DOUGH: 2, 3, 4 cups

PROGRAM TIME RANGE:

BREAD:

NORMAL SETTING: 3 hours to 3 hours, 20 minutes

RAPID SETTING: 2 hours, 30 minutes to 2 hours, 50 minutes

DOUGH: 1 hour, 12 minutes to 1 hour, 28 minutes