

INSTALLATION INSTRUCTIONS

JWF15S

Wireless Home Automation Control Device Interchangeable Face Cover On/Off Switch

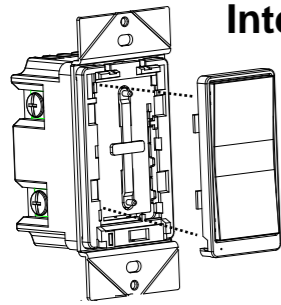

◆ SPECIFICATIONS

Voltage.....	120VAC, 60Hz
Incandescent.....	1000W
Electronic Ballast.....	5A
Standard Ballast.....	1200VA
Resistive.....	1800W(15A)
Motor.....	1/2 HP
Operating Temperature.....	32°F~104°F(0°C~40°C)
Wire Strip Length.....	16mm(5/8 in.)
Supply Connection.....	14 AWG wires, suitable for at least 75°C
Screw Torque.....	.20 lbf-in
Protocol.....	IEEE 802.11b/g/n
Wireless Type.....	2.4GHz

◆ FEATURES

- Perfect Replacement for regular wall switch, 120VAC, 15Amp
- Manual and Remote ON/OFF control of any connected lighting and other electrical load
- You can Turn your devices on or off at any time or anywhere have Internet using the free MyTS App on your smartphone.
- Interchangeable Color Face Plate

◆ DESCRIPTION

The JWF15S ON/OFF Switch is a perfect wireless manual and remote on/off control replacement of regular wall switch, controlling incandescent, LED, fluorescent, ballast and so on.

WARNINGS AND CAUTIONS

Be sure to read the instruction carefully before installation, and the manufacturer will not be responsible for any product damage that does not follow the instruction

1. Wet hands are strictly prohibited.
2. Must work strictly according to the rated load.
3. Do not continue to work after self-disassembly of any nature and damage of external forces.

◆ INSTALLATION

Single Switch Wiring Schematic

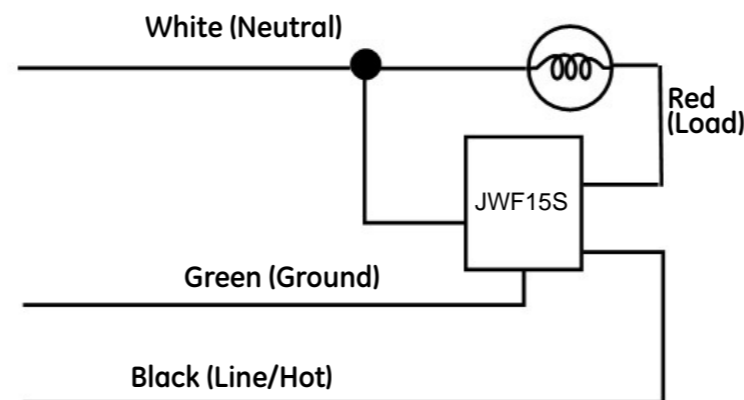

Wiring Diagram:

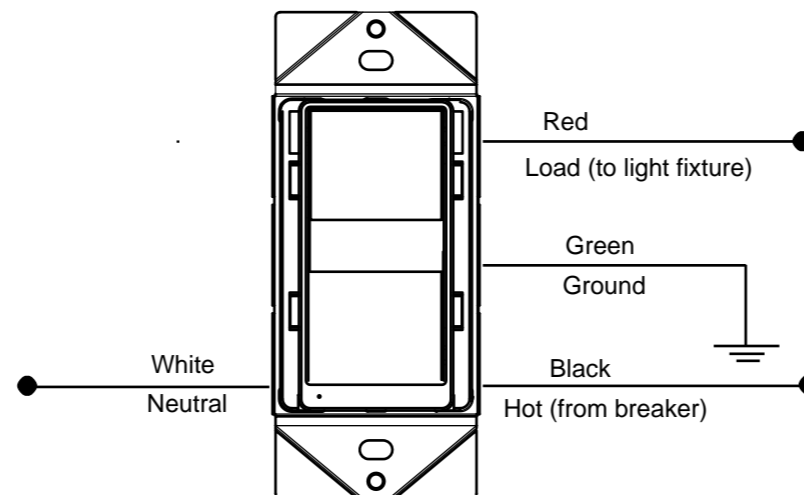

1. WARNING : To avoid fire, shock, or death. High Voltage - Turn off power at circuit breaker or fuse and test that power is off before wiring.
2. Remove wall plate and existing switch mounting screws.
3. Carefully remove the existing switch from the switch box.
4. Disconnect the wiring from the existing switch.
5. Connect this JWF15S switch as shown in the wiring diagram: Black lead to hot wire, white lead to neutral wire, red lead to load wire, green lead to ground wire.
6. Check connections to be sure they are tight and no bare conductors are exposed.
7. Insert the JWF15S switch into the standard outlet box carefully.
8. Make sure the JWF15S switch to the box using the supplied screws.
9. Attach the wall plate.
10. Restore power at the circuit breaker and test the system.

◆ OPERATIONS

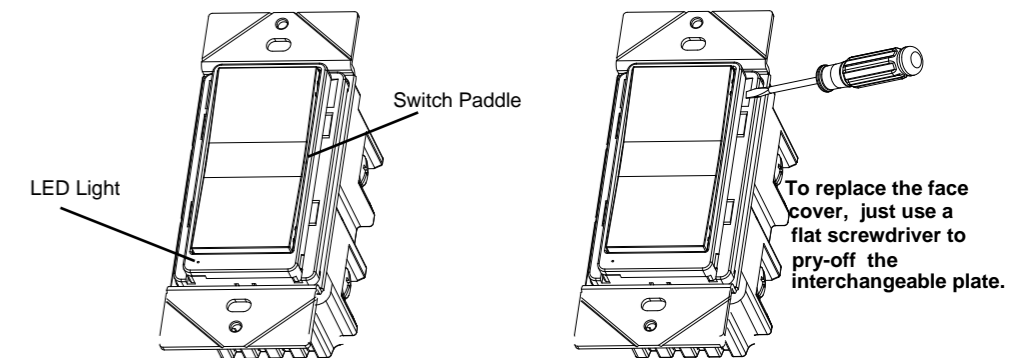

Manual Control

The switch paddle on the JWF15S allows the user to:

- 1, Turn ON/OFF the connected lighting.
- 1, To turn the connected lighting ON: Tap the top of the switch paddle.
- 2, To turn the connected lighting OFF: Tap the bottom of the switch paddle.

Please Note: After a power failure, the WF15S on/off switch returns to OFF state.

MyTS App Control

1. Download MyTS app from the App Store or Google Play.



2. Connect mobile device to your 2.4GHz WIFI network. Please note this switch can only be connected to 2.4GHz network.



3. Launch MyTS and follow the in-app instructions to connect the switch to your network.
 - a. Login the MyTS, you need create a new account then sign in.

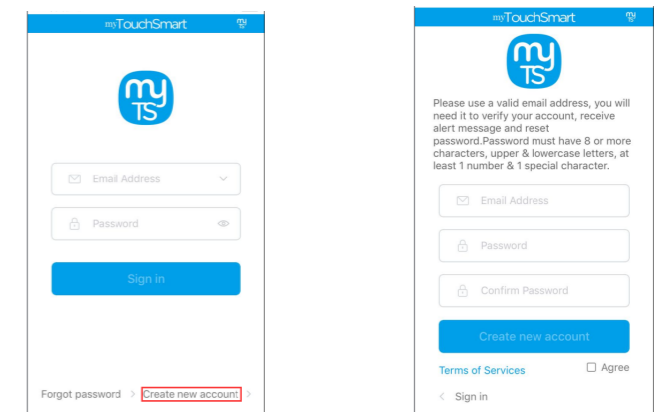

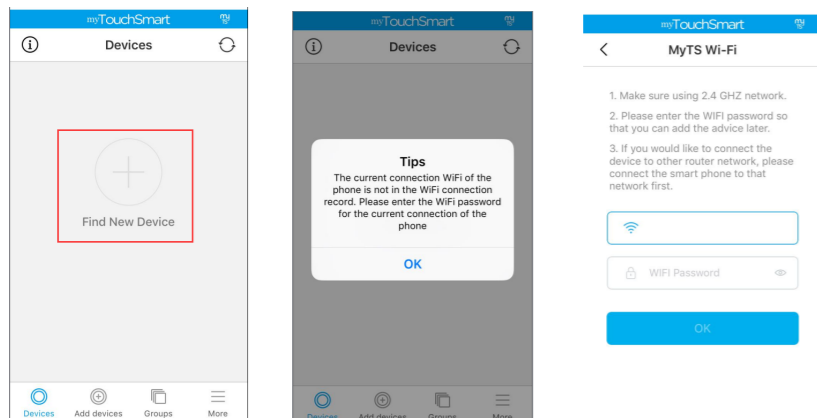

INSTALLATION INSTRUCTIONS

b. Click the button “+” then enter your WIFI password

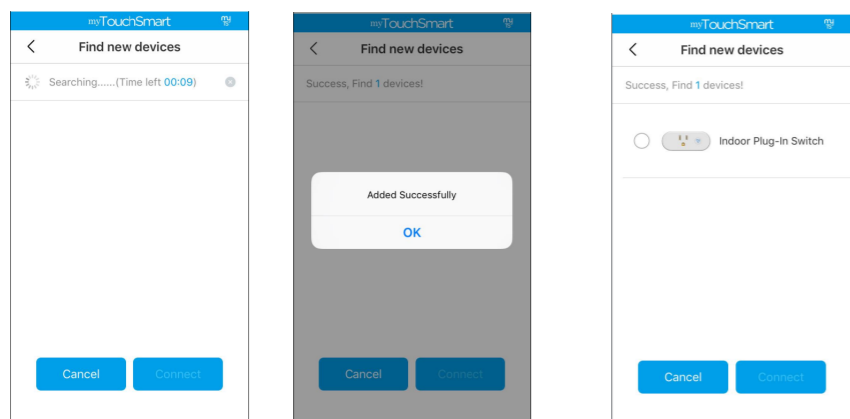

c. Pls tap the JWF15S up paddle above 10 seconds until the blue LED is in a quick flashing state, then this switch can be added successfully.



d. Pls select this switch and then click the "Connect" button then finished . Click the  you can turn on or off the switch.

Click the  you can edit this switch device.

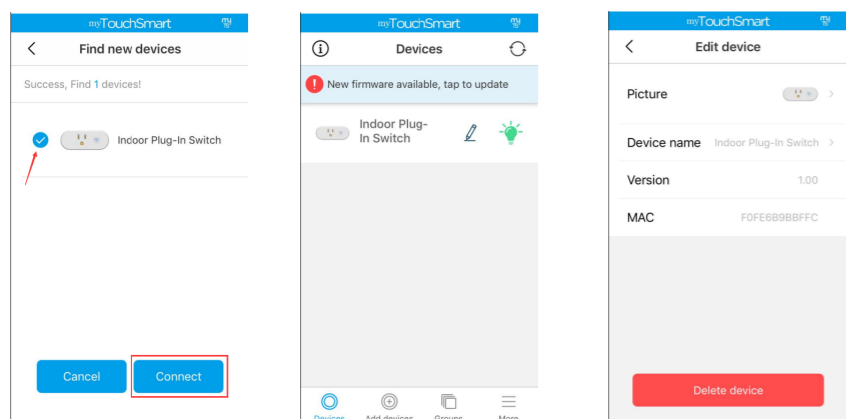

Please Note:

1. During the process of adding device, you must select the correct name of WIFI router and fill in the correct WIFI password, otherwise the device will not be able to add successfully.
2. Now, this WIFI Switch can only be paired with one phone device.

◆ LED INDICATION

Quick Flashing in Blue: Connecting to the network.

Blue LED keep lighting: Connected to the network.

Solid Blue: The WIFI Switch is switched on.

Off: The WIFI Switch is switched off.

◆ FCC COMPLIANCE STATEMENT

Federal Communication Commission Interference Statement

The equipment has been tested and found to comply with the limits for a class B B Digital Device, pursuant to part 15 of the FCC Rules. These limits are designed to provide reasonable protection against harmful interference in a residential installation. This equipment uses, generates and can radiate radio frequency energy and, if not installed and used in accordance with the instruction, may cause harmful interference to radio communication. However, there is no guarantee that interference will not occur in a particular installation. If this equipment does cause harmful interference to radio or television reception, which can be determined by turning the equipment off and on, the user is encouraged to try to correct the interference by one or more of the following measures:

- Reorient or relocate the receiving antenna.
- Increase the separation between the equipment and receiver.
- Connect the equipment into an outlet on a circuit different from that to which the receiver is connected.
- Consult the dealer or an experienced radio/TV technician for help.

FCC Caution:

This device complies with Part 15 of the FCC Rules. Operation is subject to the following two conditions: 1. This device may not cause interference, and 2. This device must accept any interference received, including interference that may cause undesired operation.

FCC Radiation Exposure Statement:

This equipment complies with FCC radiation exposure limits set forth for an uncontrolled environment. This equipment should be installed and operated with minimum distance 20cm between the radiator & your body.

RF Exposure: A distance of 20 cm shall be maintained between the antenna and users, and the transmitter module may not be co-located with any other transmitter or antenna.

Non-modification Statement:

Any changes or modifications not expressly approved by the party responsible for compliance could void the user's authority to operate this equipment.

◆ WARRANTY INFORMATION

Our company warranties its products to be free of defects in materials and workmanship for a period of two (2) years. There are no obligations or liabilities on the part of our company for consequential damages arising out of or in connection with the use or performance of this product or other indirect damages with respect to loss of property, revenue, or profit, or cost of removal, installation or reinstallation.

Jun, 2018

INSTALLATION INSTRUCTIONS

JWF15S-3W

Wireless Home Automation Control Device Interchangeable Face Cover On/Off Switch

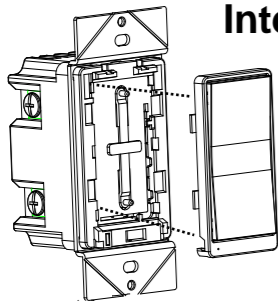

◆ SPECIFICATIONS

Voltage.....	120VAC, 60Hz
Incandescent.....	1000W
Electronic Ballast.....	.5A
Standard Ballast.....	1200VA
Resistive.....	1800W(15A)
Motor.....	1/2 HP
Operating Temperature.....	32°F~104°F(0°C~40°C)
Wire Strip Length.....	16mm(5/8 in.)
Supply Connection.....	14 AWG wires, suitable for at least 75°C
Screw Torque.....	.20 lbf-in
Protocol.....	IEEE 802.11b/g/n
Wireless Type.....	2.4GHz

◆ FEATURES

- Perfect Replacement for regular wall switch, 120VAC, 15Amp
- Manual and Remote ON/OFF control of any connected lighting and other electrical load
- Can be used for signal pole or 3- Way (Multi-location) with Auxiliary Switch (sold separately)
- You can Turn your devices on or off at any time or anywhere have Internet using the free MyTS App on your smartphone.
- Interchangeable Color Face Plate

◆ DESCRIPTION

The JWF15S-3W ON/OFF Switch is a perfect wireless manual and remote on/off control replacement of regular wall switch, controlling incandescent, LED, fluorescent, ballast and so on. This JWF15S-3W ON/OFF Switch works with 3-Way Auxiliary Switch that reducing energy consumption, enhancing the value of technology of your home, condominiums and apartment.

WARNINGS AND CAUTIONS

Be sure to read the instruction carefully before installation, and the manufacturer will not be responsible for any product damage that does not follow the instruction

1. Wet hands are strictly prohibited.
2. Must work strictly according to the rated load.
3. Do not continue to work after self-disassembly of any nature and damage of external forces.

◆ INSTALLATION

Single Switch Wiring Schematic

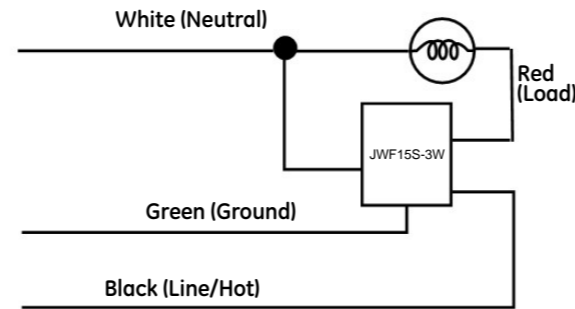

3-Way Wiring Schematic using one JWF15S and one 3-way Auxiliary Switch

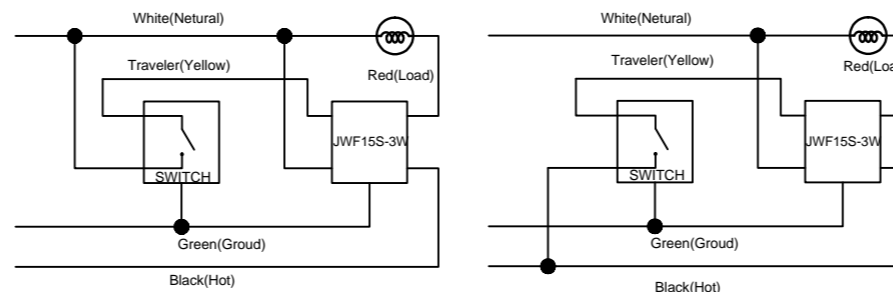

Wiring Method 1

Wiring Method 2

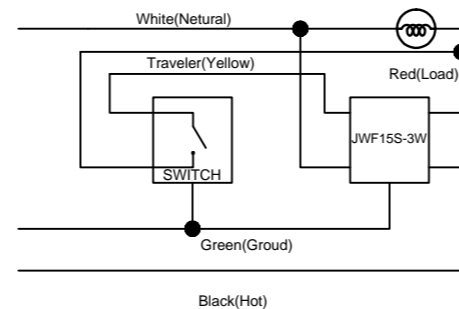

Wiring Method 3

Traveler works with 3-way Auxiliary Switch control(sold separately).

Wiring Diagram:

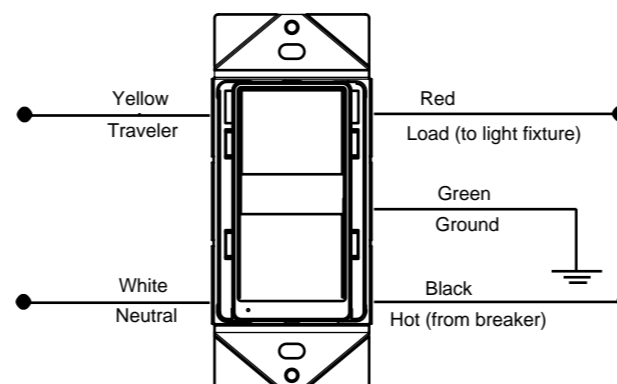

1. WARNING : To avoid fire, shock, or death. High Voltage - Turn off power at circuit breaker or fuse and test that power is off before wiring.
2. Remove wall plate and existing switch mounting screws.
3. Carefully remove the existing switch from the switch box.
4. Disconnect the wiring from the existing switch.
5. Connect this JWF15S-3W switch as shown in the wiring diagram: Black lead to hot wire, white lead to neutral wire, red lead to load wire, green lead to ground wire.
6. Check connections to be sure they are tight and no bare conductors are exposed.
7. Insert the JWF15S-3W switch into the standard outlet box carefully.
8. Make sure the JWF15S-3W switch to the box using the supplied screws.
9. Attach the wall plate.
10. Restore power at the circuit breaker and test the system.

◆ OPERATIONS

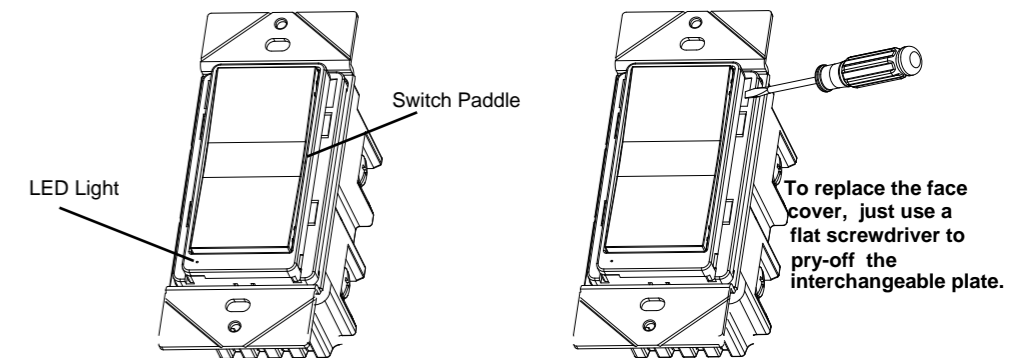

Manual Control

The switch paddle on the JWF15S-3W allows the user to:

- 1, Turn ON/OFF the connected lighting.
 - 1, To turn the connected lighting ON: Tap the top of the switch paddle.
 - 2, To turn the connected lighting OFF: Tap the bottom of the switch paddle.

Please Note: After a power failure, the WF15S-3W on/off switch returns to OFF state.

MyTS App Control

1. Download MyTS app from the App Store or Google Play.



2. Connect mobile device to your 2.4GHz WIFI network. Please note this switch can only be connected to 2.4GHz network.



3. Launch MyTS and follow the in-app instructions to connect the switch to your network.

INSTALLATION INSTRUCTIONS

a. Login the MyTS, you need create a new account then sign in.

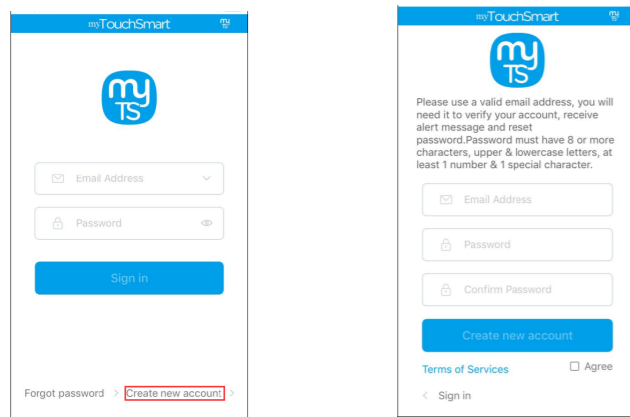

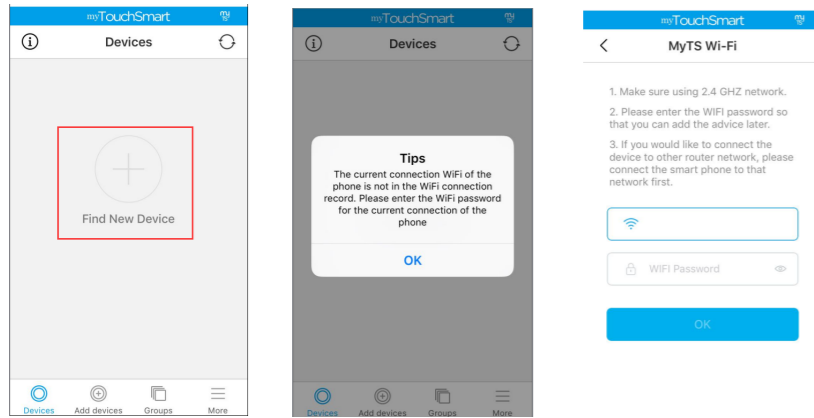

b. Click the button “+” then enter your WIFI password

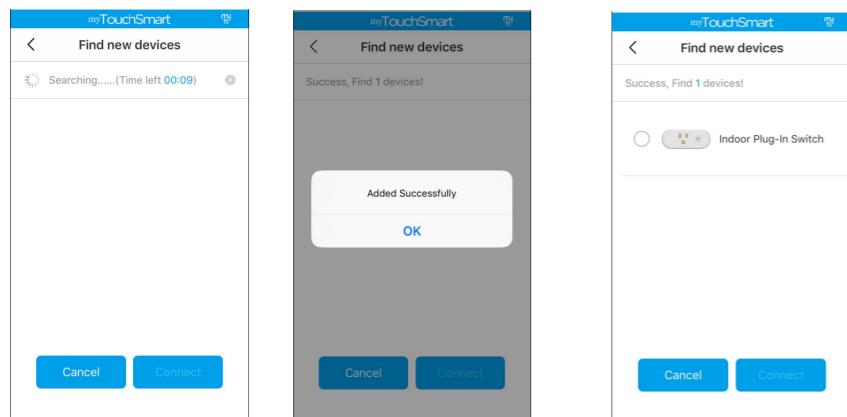

c. Pls tap the JWF15S-3W up paddle above 10 seconds until the blue LED is in a quick flashing state, then this switch can be added successfully.



d. Pls select this switch and then click the "Connect" button then finished .
Click the  you can turn on or off the switch.
Click the  you can edit this switch device.

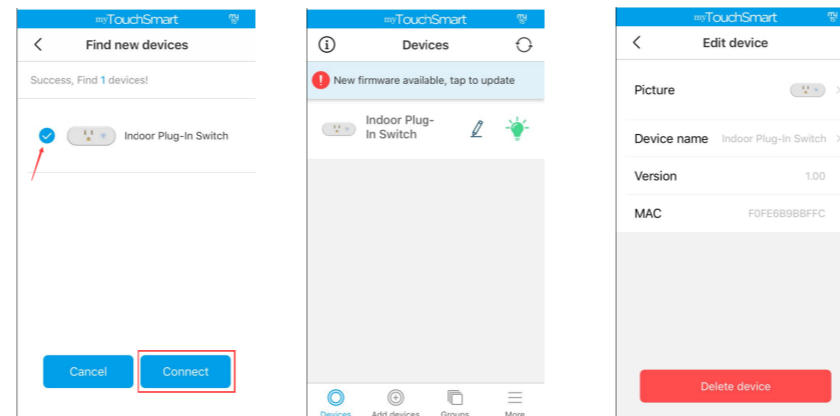

Please Note:

1. During the process of adding device, you must select the correct name of WIFI router and fill in the correct WIFI password, otherwise the device will not be able to add successfully.
2. Now, this WIFI Switch can only be paired with one phone device.

◆ LED INDICATION

Quick Flashing in Blue: Connecting to the network.

Blue LED keep lighting: Connected to the network.

Solid Blue: The WIFI Switch is switched on.

Off: The WIFI Switch is switched off.

◆ FCC COMPLIANCE STATEMENT

Federal Communication Commission Interference Statement

The equipment has been tested and found to comply with the limits for a class B B Digital Device, pursuant to part 15 of the FCC Rules. These limits are designed to provide reasonable protection against harmful interference in a residential installation. This equipment uses, generates and can radiate radio frequency energy and, if not installed and used in accordance with the instruction, may cause harmful interference to radio communication. However, there is no guarantee that interference will not occur in a particular installation. If this equipment does cause harmful interference to radio or television reception, which can be determined by turning the equipment off and on, the user is encouraged to try to correct the interference by one or more of the following measures:

- Reorient or relocate the receiving antenna.
- Increase the separation between the equipment and receiver.
- Connect the equipment into an outlet on a circuit different from that to which the receiver is connected.
- Consult the dealer or an experienced radio/TV technician for help.

FCC Caution:

This device complies with Part 15 of the FCC Rules. Operation is subject to the following two conditions: 1. This device may not cause interference, and 2. This device must accept any interference received, including interference that may cause undesired operation.

FCC Radiation Exposure Statement:

This equipment complies with FCC radiation exposure limits set forth for an uncontrolled environment. This equipment should be installed and operated with minimum distance 20cm between the radiator & your body.

RF Exposure: A distance of 20 cm shall be maintained between the antenna and users, and the transmitter module may not be co-located with any other transmitter or antenna.

Non-modification Statement:

Any changes or modifications not expressly approved by the party responsible for compliance could void the user's authority to operate this equipment.

◆ WARRANTY INFORMATION

Our company warranties its products to be free of defects in materials and workmanship for a period of two (2) years. There are no obligations or liabilities on the part of our company for consequential damages arising out of or in connection with the use or performance of this product or other indirect damages with respect to loss of property, revenue, or profit, or cost of removal, installation or reinstallation.

Jun, 2018