

Infrared Digital Scouting Camera



User's Manual

Model # N6E

Includes

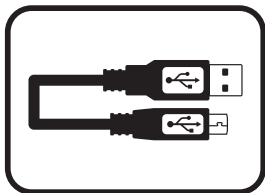

USB Cable



2 - Bungee Cords



User Manual

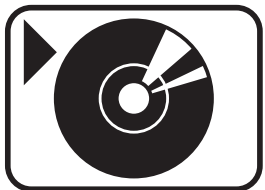

**Flextime Player
Software**

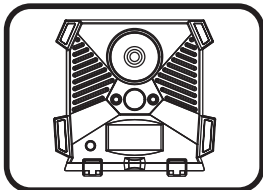

Camera Unit

**NOTE: Flextime Player Software is optional.
Flextime files can be played by using most
media players.**

Features

RESOLUTION	MAX: 6 MP
FLASH	30 High Intensity Infrared LED's
FLASH RANGE	up to 65 feet
SENSOR	Passive Infrared Sensor (PIR) Motion and Heat
SENSOR RANGE	up to 60 feet
IMAGE FORMAT	JPEG - Digital Still / AVI - Digital Video
MEMORY	up to 32GB SD Card (not included)
USB	5-PIN Mini USB style - included
IMAGE RESOLUTION	High (6MP) Medium (4MP) Low (2MP)
POWER SUPPLY	4 C-Cell batteries (not included)
AUXILIARY POWER	External power port
BATTERY LIFE	Estimated up to 3 months (in PIR mode) Battery life may be reduced in Flexitime mode (depending on Flexitime setting)
ONBOARD POWER	Built in battery to retain Time and Settings
HOUSING	Weather resistant with rubber gaskets
MOUNTING	2 Bungee cords - included
REDUX	Technology to reduce motion blur during transition time

Installing Batteries

1. Open the door at the bottom of the camera by unlatching the locking tabs.

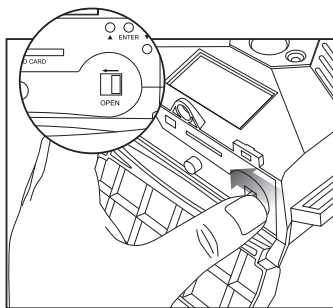
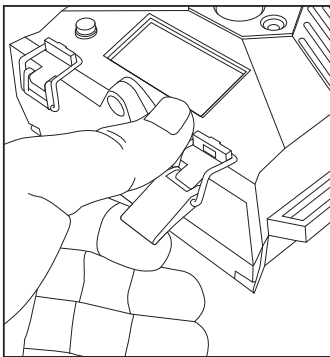

Illustration A

2. With the camera facing open, open the battery compartment cover by sliding the latch to the left. (Illustration A and B)

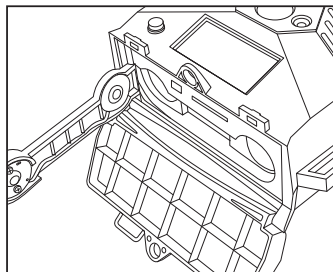
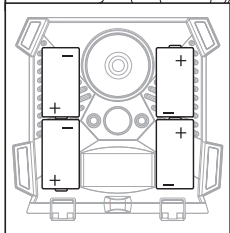
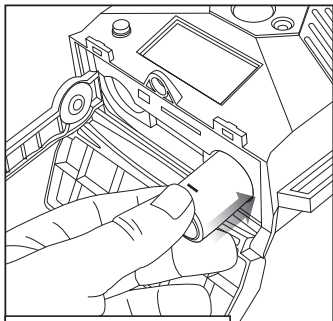
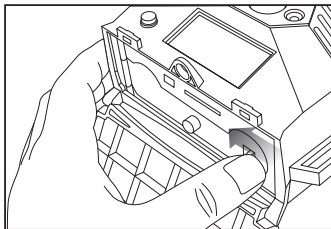

Illustration B

- 3.** With the bottom of the camera towards you, load two C-cell batteries with the positive ends towards you in the left battery chamber and load two C-cell batteries with the negative ends towards you in the right battery chamber.



- 4.** Close battery compartment cover. To latch the cover simply pull the latch slightly to the left as you close the battery compartment cover.



- 5.** Load SD memory card (up to 32GB not included) into the SD card slot with the connectors facing up.

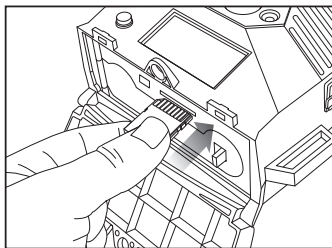

TIPS:

Make sure the SD Card is unlocked (small switch on the side of the SD Card) or the camera LCD will read "LOCK".

Power On

1. To turn the unit ON press and release the power button.

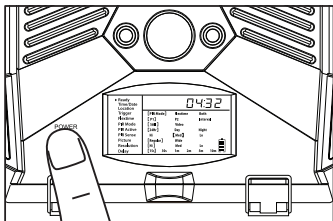

2. Check the battery level icon to ensure the batteries just installed contain the proper charge level. If so, you are ok to proceed with camera use.

► Ready Time/Date	04:32			
Location	[PIR Mode]	Hottime	Both	
Trigger	[P1]	P2	Interval	
Flextime	[S10]	Video		
PIR Mode	[24hr]	Day	Night	
PIR Active	Hi	[Med]	Lo	
PIR Sense	[Regular]	Wide		
Picture	[Hi]	Med	Lo	
Resolution	[15]	30s	1m	2m
Delay			5m	10m

Test Mode

1. LCD Ready Mode: The camera will automatically enter Ready Mode if a button is not pressed for greater than 30 seconds. The status lights will illuminate for a total of 2 minutes.
2. PIR LED Status Light: During the first 2 minutes of Ready Mode, the red light will illuminate when a PIR event is triggered. The red light will blink for 2-3 seconds when photo is taken during this first 2 minutes. After 2 minutes all indicator lights will turn off until a button is pressed.

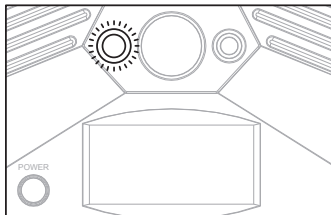

Power Save

1. After 30 seconds without any buttons being pushed, the LCD will turn off and camera enters into Power Save or Ready Mode.
2. The LCD screen can be awakened by pressing the Power button briefly.

Note: The LCD will not “wake up” when camera is writing to memory.

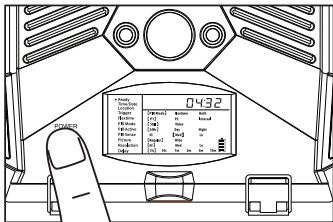

Setting Time

1. To change date and time, start by pressing and release the center navigation button to set the hour.

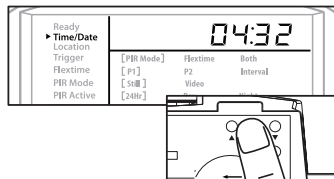

2. Press the left or right navigation button to go up or down in sequence.

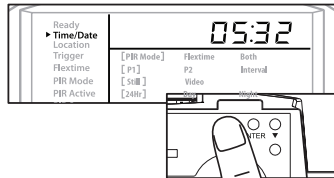

3. When the hour is set, repeat steps 1 and 2 to set the minutes.

Setting Date

1. Press the center navigation button after setting the minute to change the Day.

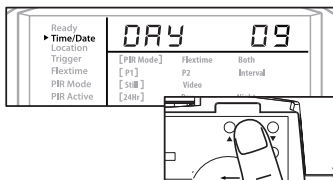

2. Press the left or right navigation button to go up or down in sequence.

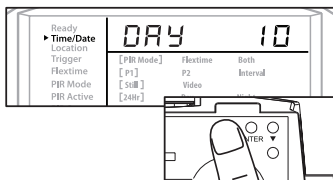

3. When the DAY is set, repeat steps 1 and 2 to set the Month and Year.

Location

1. Press the center navigation button while Location is selected. The first character will be blinking.

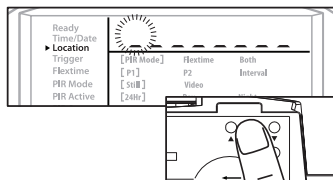

2. Press the left or right navigation button to go up or down in sequence. Press the center navigation button when the character shown is what you want and move to the next character.

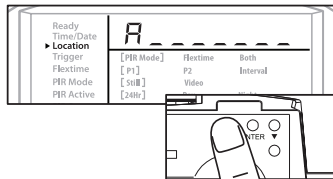

3. Repeat steps 1 and 2 to set the rest of the characters. Press the center navigation button to skip spaces and save the location name.

Trigger

1. Press the center navigation button while Trigger is selected. The highlighted option will be blinking.

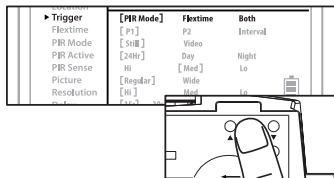

2. Press the left or right navigation button to move to different options. Press the center navigation button to save the setting.

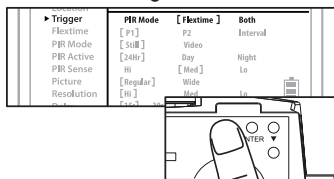

TRIGGER:

PIR MODE: Takes a photo or video only when the PIR sensor is triggered.

FLEXTIME (Time Lapse): Takes time lapse images at set intervals during the key movement periods of the day, depending on your Flextime settings.

BOTH: Both PIR and Flextime are active.

Flextime

1. Press the center navigation button while Flextime is selected. The highlighted option will be blinking.

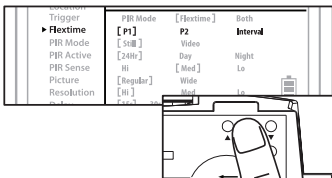

2. Press the left or right navigation button to move to different options. Press the center navigation button to save the setting.

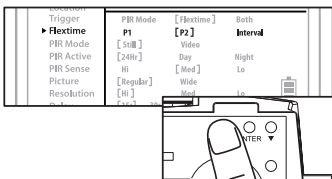

The Interval setting is set by the Delay Setting on the camera with a 1 minute minimum Flextime delay. See chart on the next page for Flextime options.

NOTE: Camera needs at least 48 hours in the field to acclimate to the environment for Flextime to function properly.

FLEXTIME selected

Flextime period:

1. 15 min before Sunrise to 1 hour after Sunrise.
2. 1 hour before Sunset to 15 min after Sunset

P1

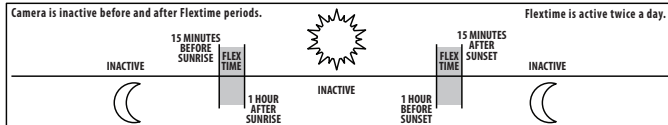

Flextime period:

1. 15 min before Sunrise to 1 hour after Sunrise.
2. 1 hour before Sunset to 15 min after Sunset

P2

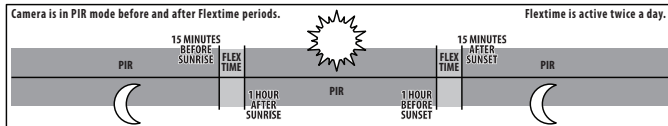

Flextime period:

1. 15 min before Sunrise to 15 min after Sunset

INTERVAL

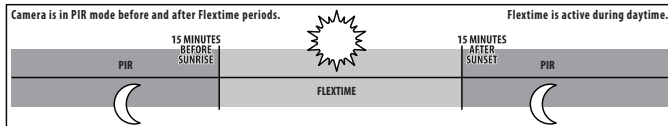

BOTH selected

Flextime + PIR period:

1. 15 min before Sunrise to 1 hour after Sunrise.
2. 1 hour before Sunset to 15 min after Sunset

P1

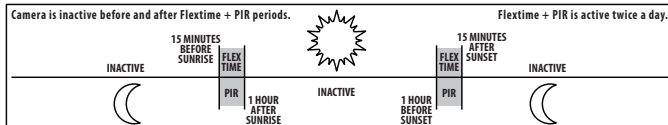

Flextime + PIR period:

1. 15 min before Sunrise to 1 hour after Sunrise.
2. 1 hour before Sunset to 15 min after Sunset

P2

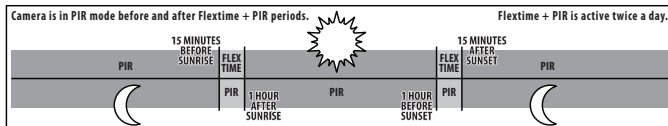

Flextime + PIR period:

1. 15 min before Sunrise to 15 min after Sunset

INTERVAL

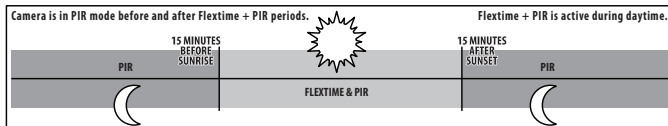

PIR Mode

1. Press the center navigation button while PIR Mode is selected. The highlighted option will be blinking.

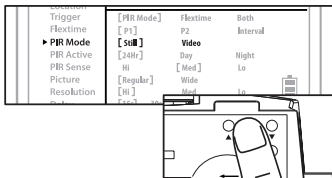

2. Press the left or right navigation button to move to different options. Press the center navigation button to save the setting.

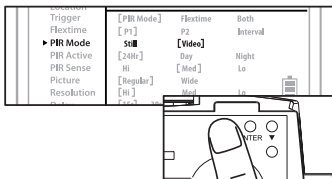

PIR MODE:

STILL: The camera takes still photographs.

VIDEO: The camera takes 30 second videos.

PIR Active

1. Press the center navigation button while PIR Active is selected. The highlighted option will be blinking.

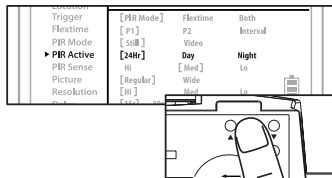

2. Press the left or right navigation button to move to different options. Press the center navigation button to save the setting.

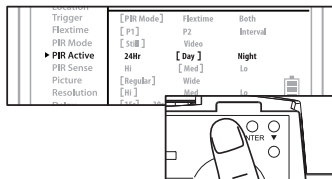

PIR ACTIVE:

24 HR: The PIR can be active at all times.

DAY: The PIR can be active in daylight hours only.

NIGHT: The PIR can be active in nighttime hours only.

PIR Sensitivity

1. Press the center navigation button while PIR Sense is selected. The highlighted option will be blinking.

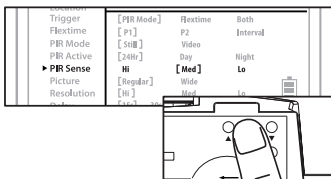

2. Press the left or right navigation button to move to different options. Press the center navigation button to save the setting.

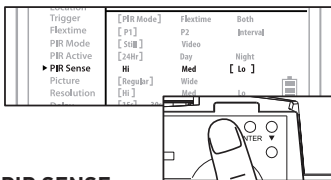

PIR SENSE:

HI: The PIR detects the smallest movement.

MED: (Default) The PIR detects most common size movements.

LO: The PIR detects only larger movements.

Picture

1. Press the center navigation button while Picture is selected. The highlighted option will be blinking.

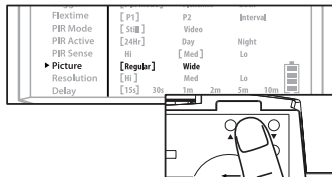

2. Press the left or right navigation button to move to different options. Press the center navigation button to save the setting.

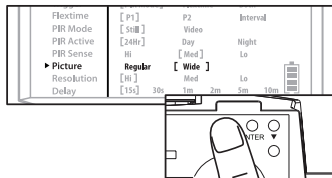

PICTURE:

REGULAR: Images taken will be in regular angle or 4:3 aspect ratio.

WIDE: Images taken will be in wide angle or 16:9 aspect ratio.

Resolution

1. Press the center navigation button while Resolution is selected. The highlighted option will be blinking.

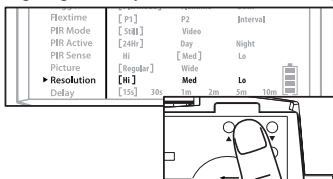

2. Press the left or right navigation button to move to different options. Press the center navigation button to save the setting.

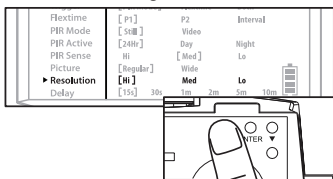

RESOLUTION:

HI: Images will be at the highest resolution but take up the most space.

MED: Images will be at medium resolution and take up average space.

LO: Images will be at the lowest resolution and take up the least space.

Delay

1. Press the center navigation button while Delay is selected. The highlighted option will be blinking.

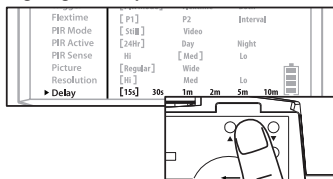

2. Press the left or right navigation button to move to different options. Press the center navigation button to save the setting.

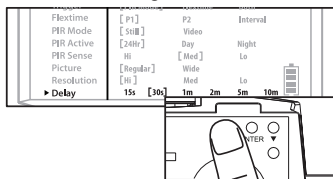

DELAY: The time before the camera is able to take another picture.

PIR Mode: minimum 15s
FLEXTIME Mode: minimum 1 minute

Power Off

1. To turn the unit off, first wake up the LCD screen and then depress and hold the power button until the LCD turns off.

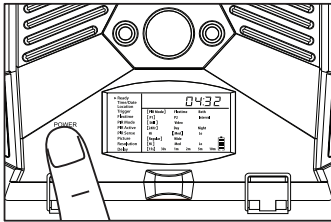

Power Port

1. WGI Cameras come standard with an external power port. You must open the weather resistant cover and use a Wildgame Innovations 6 Volt camera battery accessory.

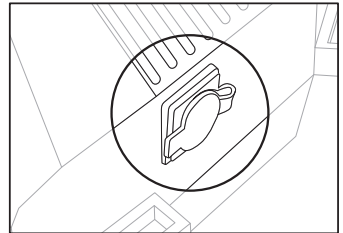
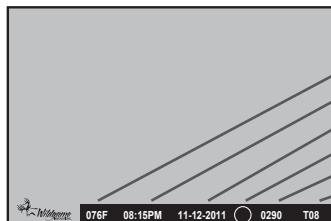

Image Stamp



Pictures Display:

- Temperature
- Time
- Date
- Moon Phase
- Photo Count
- Location

Mounting

1. When mounting to a tree, first latch the 2 bungee cords through the 2 mounting holes on the left or right side of the camera. Then, stretch the cords around the tree and latch the other ends of the bungee cords through the mounting holes on the opposite side of the camera.

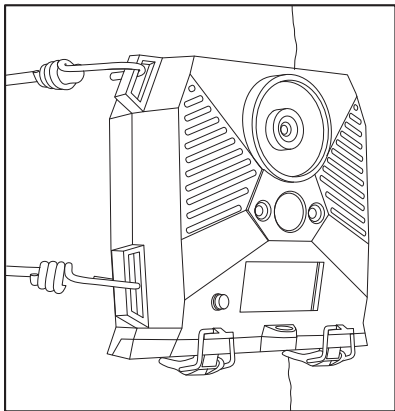

Important

Once you connect the camera to your computer via the USB cable/ports, the camera will then draw power from the computer. When completing the viewing, transferring, copying or deletion of images, please make sure that you **DISCONNECT THE USB CABLE FROM BOTH THE CAMERA AND THE COMPUTER**, as you will not be able to power the camera OFF until you do so.

The directions as contained herein assume that you are using a Microsoft operating system and not Linux or a Mac-based operating system. Even said, there may be slight variations in your process based on the specific version of the operation system that you are using as well as the predefined user preference for each computer. The below listed steps are to serve as a guideline and may have to be slightly modified based on the specific operating system and preference as on your personal computer.

TIPS:

Recommended distance from target area is 25-30 feet for optimal imaging quality.

To improve the quality of your images, try not to mount the unit facing the rising or the setting sun in order to avoid direct sunlight into the camera lens.

If mounting to a feeder unit or dusty environment, be sure to clean the camera lens cover, incandescent flash cover, and the PIR sensor cover on a regular basis.

Periodically check the mounting of the camera to insure it is not loose.

Make sure that you securely latch the door closed each and every time you use the unit, as the moisture seal will not be activated unless closed properly.

Check batteries frequently to insure no corrosive build-up, as this may cause harm to the camera.

Retrieving Images (SD Card in Camera)

Method 1: Leave SD card in camera

A. First, make sure that the camera is powered OFF. Next, plug the USB cable into the camera and then into the USB port on your computer. Once this is complete (in this order only), then power the camera ON.

B. Once complete, your computer may automatically launch "AutoPlay", a window recognizing a new Removable disk (the camera).

C. If so, it should give you three selections:

1. Import pictures
2. View pictures
3. Open folder to view files

D. Select the method from the list provided that best suits your requirements. Once a selection is made, you can then view the images located on the SD Card and manipulate them as needed.

E. If your computer does not automatically launch the AutoPlay window recognizing the Removable Disk (the camera), then you will need to go to the "Start Menu" at the bottom left of your screen and select "Computer". The summary view will then be illustrated on the right hand side of the window where the "Devices with Removable Storage" will

be listed. The computer will recognize the camera as Removable Disk. Please select Removable Disk from this menu (or double click on the graphical icon).

F. This will then direct you into the SD Card file folder. Images are in the MEDIA folder while Flextime files are in the FLEX folder.

G. Once open, you will then see all of the photo files that are located on the SD Card. Select each image individually to view. The default viewing browser for your computer will then automatically launch.

H. Repeat for viewing all or other photos.

I. If you determine that you want to delete the image, select the image by placing your cursor on it and clicking your mouse only once. Right click on your mouse and select delete. This will delete the image permanently, so be absolutely sure you want to do this before selecting delete.

TIP: The software drivers necessary to use and view the camera are automatically downloaded to the computer when you connect your camera to the computer via the included USB cable.

TIP: View Flextime Player Software CD for more information on Flextime.

Retrieving Images (SD Card reader)

Method 2: Remove SD card and use card reader

A. First, remove the SD Card from the camera unit itself by pressing on it to where it automatically ejects.

B. Next, insert the SD card into your SD card reader.

C. Once inserted into your computer it may automatically launch "AutoPlay", a window recognizing a new Secure Digital Storage Device (the SD Card).

D. If so, it should list several options for the next steps (not limited to the following):

1. Picture Options
 - a. Import pictures
 - b. View pictures
 - c. Copy Disc
 - d. Transfer pictures

2. General Options
 - a. Open folder to view files

E. Select the method from the list provided that best suits your requirements. If the selection is made to "View pictures", you can then view the images located on the SD Card and manipulate them as needed.

F. If your computer does not automatically launch the AutoPlay window recognizing the Removable Disk (the SD Card), then you will need to go to the "Start Menu" at the bottom

left of your screen and select "Computer". The summary view will then be illustrated on the right hand side of the window where by the "Devices with Removable Storage" will be listed. The computer will recognize the reader as "Secure Digital Storage Device". Please select "Secure Digital Storage Device" from this menu (or double click on the graphical icon).

G. This will then direct you into the SD Card file folder. Images are in the MEDIA folder while Flextime files are in the FLEX folder.

H. Once open, you will then see all of the photo files that are located on the SD Card. Select each image individually to view. The default viewing browser for your computer will then automatically launch.

I. Repeat for viewing all or other photos.

J. If you determine that you want to delete the image, select the image by placing your cursor on it and clicking your mouse only once. Right click on your mouse and select delete. This will delete the image permanently, so be absolutely sure you want to do this before selecting delete.

Warranty

DISCLAIMERS

WGI Innovations, LTD is not responsible for damage, expense or injury caused by the unauthorized use of, alterations to, improper connection of and abuse or neglect of the WGI Innovations™ products.

WARRANTY

You must register your product warranty online at www.wildgameinnovations.com. Follow the on screen directions to complete the process.

WGI Innovations, LTD will replace any product that may encounter material or workmanship defects free of charge for ONE (1) YEAR after the date of purchase and thereafter the cost will vary per incident.

This warranty DOES NOT COVER damage, expense or injury caused by unauthorized repairs, alterations, improper connection, shipping, abuse, theft, accident, neglect or collateral loss.

When returning product for service you MUST obtain a Return Merchandise Authorization (RMA) number from WGI Innovations, LTD. Please include name, UPS address (no P.O. Box), telephone number, RMA number and a complete description of the problem on all enclosed correspondence. When possible, pack product carefully in original carton. Customers are responsible for any shipping cost to WGI Innovations™. WGI Innovations™ will pay shipping cost of replacement product to the customer. We are not responsible for damage incurred in returning items for repair.

CUSTOMER SERVICE

WGI Innovations, LTD stands behind every product we manufacture for a one year product workmanship warranty and a strong commitment to customer service. If you are in need of customer service for missing parts or need assistance with the operation or assembly of your product, we encourage you to call one of our customer service representatives and let us assist you with your WGI Innovations™ product.

DISCLAIMER

WGI Innovations, LTD reserves the right to make changes to product features, functionality and physical design at its sole discretion. As a result, such changes may not be reflected in this version of the manual.

FCC STATEMENT

Product Name: Game Trail Camera

Trade Name: Wildgame Innovations

Model# N6E

This device complies with Part 15 of the FCC Rules. Operation is subject to the following two criteria: (1) This device may not cause harmful interference, and (2) This device must accept any interference received, including interference that may cause undesired operation.

Warning: Changes or modifications to this unit not expressly approved by the party responsible for compliance could void the user's authority to operate the equipment.

NOTE: This equipment has been tested and found to comply with the limits for a Class B digital device, pursuant to Part 15 of the FCC Rules. These limits are designed to provide reasonable protection against harmful interference in a residential installation. This equipment generates, uses and can radiate radio frequency energy and, if not installed and used in accordance with the instructions, may cause harmful interference to radio communications.

However, there is no guarantee that interference will not occur in a particular installation. If this equipment does cause harmful interference to radio or television reception, which can be determined by turning the equipment off and on, the user is encouraged to try to correct the interference by one or more of the following measures:

- Reorient or relocate the receiving antenna.
- Increase the separation between the equipment and receiver.
- Connect the equipment into an outlet on a circuit different from that to which the receiver is connected.
- Consult the dealer or an experienced radio/TV technician for help.

WGI INNOVATIONS, LTD

602 Fountain Parkway
Grand Prairie, TX 75050
800.847.8269

*Sport
Responsible*



"Wildgame Innovations" and the "Button Logo" are TM trademarks of Wildgame Innovations, LLC.
"Sport Responsible", "Redux" and "Flextime" are TM trademarks of WGI Innovations, LTD.

