



VCR

User's Guide

Changing Entertainment. Again.







Important Information

WARNING
To reduce the risk of fire or electric shock, do not expose this product to rain or moisture.

CAUTION
RISK OF ELECTRIC SHOCK. DO NOT OPEN.

To reduce the risk of electric shock, do not remove cover (or back). No user serviceable parts inside. Refer servicing to qualified service personnel.

 This symbol indicates "dangerous voltage" inside the product that presents a risk of electric shock or personal injury.

 This symbol indicates important instructions accompanying the product.

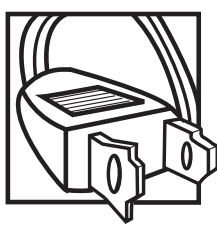

Caution: To prevent electric shock, match wide blade of plug to wide slot, fully insert.

Attention: Pour éviter les chocs électriques, introduire la lame la plus large de la fiche dans la borne correspondante de la prise et pousser jusqu'au fond.

Refer to the identification/rating label located on the back panel of your product for its proper operating voltage.

FCC Regulations state that unauthorized changes or modifications to this equipment may void the user's authority to operate it.

Cable TV Installer: This reminder is provided to call your attention to Article 820-40 of the National Electrical Code (Section 54 of the Canadian Electrical Code, Part 1) which provides guidelines for proper grounding and, in particular, specifies that the cable ground shall be connected to the grounding system of the building as close to the point of cable entry as practical.

Product Registration

Please fill out the product registration card and return it immediately. Returning the card allows us to contact you if needed.

Keep your sales receipt to obtain warranty parts and service and for proof of purchase. Attach it here and record the serial and model numbers in case you need them. The numbers are located on the back of the VCR.

Model No **DV-T7D5N-QJ**

Serial No. _____

Purchase Date: _____

Dealer/Address/Phone: _____



Key Features Overview

Your VCR is equipped with features that will add to your recording and viewing experience. The following information summarizes a few of these features. Chapter 4 provides more information about the rest of the VCR's features and how to use them.



VCR Plus+® SILVER System

The VCR Plus+ system allows for simple timer recording programming by using a single PlusCode® programming number found in most TV program listings. The VCR Plus+ SILVER system simplifies timer recordings by automatically setting up and updating the VCR's clock and channel list for you.

Requirements: Make sure the VCR Plus+ SILVER system is active, and that Auto Channel Search and time set features are correct.

COMMERCIAL ▶▶ ADVANCE®

This feature uses patented technology that detects and marks most commercials on your recordings. The VCR determines where commercials are located, marks the beginnings and ends of detected commercial segments, then easily skips over them during playback. **This feature does not erase commercials from the tape.**

MOVIE ▶▶ ADVANCE®

This feature helps locate the beginning of a purchased or rented movie as well as skip through previews. You can go to the beginning of the movie, or skip from one preview/long commercial to the next.



Universal Back-Lit Remote Control

Description: The VCR's remote control can operate most RCA, GE, and Proscan TVs with no additional steps. It can be programmed to operate many other brands of TVs. Back-lit buttons offer easier control in the dark.

Requirements: Point the remote control at the active component and press the ON•OFF button to see if it can be operated.

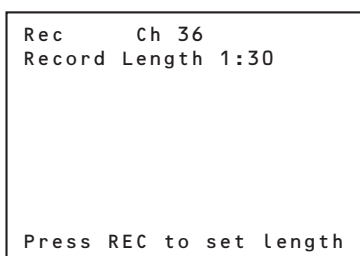

Auto Clock Set

Description: The VCR automatically looks for time and date information after most power outages as well as each time the machine is turned off. Using time information broadcast in TV signals (if available), the VCR's clock sets itself.

Requirements: Start Auto Clock Set using the VCR's on-screen menus.

VCR Plus+ and PlusCode are registered trademarks of the Gemstar Development Corporation.
The VCR Plus+ system is manufactured under the license from Gemstar Development Corporation.
COMMERCIAL ADVANCE and MOVIE ADVANCE are registered trademarks of SRT, Inc.; a Jerry Iggulden invention licensed in association with Arthur D. Little Enterprises.



Introduction

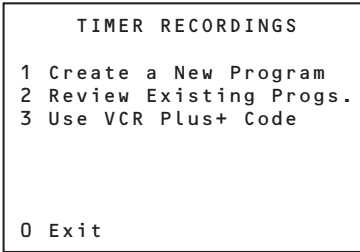

Express Recording (XPR)

Description: XPR quickly records the remaining portion of a program already in progress. XPR is a great way to capture the end of a sporting event that has run into overtime or a live broadcast that runs long.

Requirements: Repeatedly press the Record button on the VCR front panel or remote control to set the desired duration of time to record.

Pro-Tect Plus™ Locking

Description: Locks the VCR so that buttons on the front panel and remote control won't operate the VCR. This feature protects timer programs from frustrating accidents such as being left on at the time of recording.

Requirements: Lock the VCR by pressing and holding the POWER button on the remote control for six seconds. The front panel display will blink for several seconds. The VCR unlocks by pressing and holding the POWER button on the remote control, again for six seconds. The front panel display will blink again and release the lock on the system.

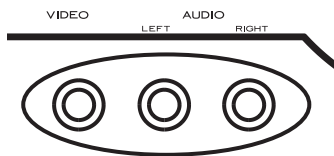

Front Audio/Video Input Jacks

Description: The VCR has Audio/Video (A/V) input jacks on both the front and rear of the unit (there are output jacks on the rear panel only). The front A/V jacks make it easy to plug in an external A/V device, such as a camcorder.

Requirements: Make sure that all A/V connections are snug. To see a connected device's image, turn the VCR to its Video Line Input by pressing the remote control's INPUT button.

Hi-Fi Quality Sound

Description: When using the VCR's A/V jacks, you can feed stereo quality sound from your VCR to your TV or stereo. Stereo quality sound allows for two separate channels of sound (Left and Right) to be heard.

Requirements: Using A/V jacks and cables to connect the VCR to the TV or stereo (see page 58 for an advanced connection setup diagram).

SQPB S-VHS Quasi Playback

Description: Your VCR will be able to play back tapes recorded in S-VHS or S-VHS-ET mode (in VHS quality).

Requirements: Insert a tape recorded in S-VHS or S-VHS-ET mode and pressing the PLAY button on the remote control or PLAY•PAUSE on the VCR.





Table of Contents

Product Registration	i
Introduction	1
Key Features Overview	1
Connections & Setup	5
Things to Consider Before Connecting Components	6
Cable Considerations	6
Choose Your Connection	7
Using the RF Coaxial Cable to Connect the VCR to a TV	7
TV + VCR	8
TV + VCR + Satellite Receiver	9
TV + VCR + Cable Box	10
Set the VCR's CH 3/4 Switch	11
Plug in the VCR	11
Put Batteries in the Remote Control	11
Turn on the TV and VCR	11
Tune the TV	11
Using the Remote Control to Navigate On-Screen Menus	12
Complete the QuickSet Guide	12
Accessing Menus	12
VCR Basics	13
Playing a Tape	13
Automatic Rewind	13
Tape Eject	13
Recording	13
Check the Safety Tab	13
Using the VCR's Menu System	15
Using On-Screen Menus to Set Up Features	16
Language	16
Cable Box Setup	16
VCR Channels List	17
Auto Channel Searching	17
Changing the Signal Type	18
Adding or Removing Channels	18
Time and Date	19
Auto Clock Set Feature	19
To Turn Auto Clock Set ON	19
Setting the Time Zone	19
Setting Daylight-Saving Time	20
Setting Time and Date Manually	20
Additional Set Up Features in the Preferences Menu	21
Remote VCR1/VCR2 Option	21
Auto Play	21
Auto TV/VCR	22
EnergySaver	22
Front Panel Brightness (VCR Display)	22
Tape Speed	23
Set Auto Repeat	23





Table of Contents

Using the Remote Control	25
Remote Control Buttons	26
Component Buttons	26
VCR Function Buttons	26
TV Function Buttons	27
Using the INPUT Button	28
Operating a TV with the VCR's Remote Control	28
Do You Need to Program the Remote?	28
Using the VCR's Features	31
Recording Features	32
Express Recording (XPR)	32
Timer Recording	33
Stopping a Timer Recording	33
Reviewing and Clearing Programs	33
VCR Plus+ SILVER System	34
Turning ON or OFF the Auto VCR Plus+ download	34
Mapping VCR Plus+ Channels Manually	35
Recording Broadcast Stereo TV or SAP (Second Audio Program)	38
Copying and Editing Tapes Using Two VCRs	38
Picture Search Options	39
Forward and Reverse Search	39
Slow Motion	39
Frame Advance	39
Index Search	40
Go-To Search	40
Commercial Advance	41
Movie Advance	43
Pro-Tect Plus™ Locking Feature	44
Tracking	44
Time Counter	44
On-Screen Displays	45
Audio Set-Up Features	46
Tape Playback	46
Other Information	47
Troubleshooting Tips	48
Questions and Answers About COMMERCIAL ADVANCE	51
Front Panel	52
Display Panel	53
Back Panel	54
Specifications	55
Cleaning the VCR	55
RCA VCR Limited Warranty	56
Finding the TV's Video Line Input	57
Advanced Connection	58
TV + VCR + Satellite Receiver	58
Glossary	59
Index	60



Chapter 1

Connections & Setup

Chapter Overview:

- Things to Consider Before Connecting
- Choosing Your Connection
- Making Connections
- Navigating On-Screen Menus
- Completing the QuickSet™ Guide
- Basic Recording

Changing Entertainment. Again.





Connections & Setup

Things to Consider Before Connecting Components

Protect Components From Power Surges

- Connect all components before plugging any power cords into the wall outlet.
- Always turn off the TV and other components before you connect or disconnect any cables.

Position Cables to Avoid Audio Hum or Interference

- Insert all cable plugs firmly into their jacks.
- Place any Audio/Video (A/V) cables to the side(s) of the TV's back panel instead of straight down the back after connecting components.
- Try not to coil any twin-lead cables and keep them away from all A/V cables as much as possible.
- Make sure all antennas and cables are properly grounded. Refer to the *Safety Tips* sheet packed with your unit for detailed information.

Protect Components From Overheating

- Never block ventilation slots in any component. Arrange the components so that air can circulate freely.
- Do not stack components.
- Allow adequate ventilation when placing components in a stand.
- Place an amplifier or satellite receiver on the top shelf of a stand so heated air rising from it will not flow around other components.

Cable Considerations

The RF coaxial cable supplied with your VCR carries both sound and picture information. This is the cable used in all connection diagrams illustrated in this chapter.

If your TV has A/V input jacks, you should use A/V cables (not supplied) to connect the VCR to the TV. A/V cables provide better picture and sound quality than an RF coaxial cable. If you would like to hook up your VCR using A/V cables, refer to the *Advanced Connection* information on page 58 in the *Other Information* chapter of the manual.



Connections & Setup



RF Coaxial Cable

Using the RF Coaxial Cable to Connect the VCR to a TV

This graphic shows the RF coaxial cable supplied with your VCR. This will be the cable used for the basic connections represented in this chapter.







Notes: To hear stereo sound, you will need to purchase Audio/Video (A/V) cables (not provided) and connect the VCR to the TV. A/V jacks and cables also provide a superior image and sound quality. For details about using this advanced setup, see the instructions on page 58.

Using A/V jacks to connect the VCR to the TV requires tuning to the TV's Video Line Input to see the VCR's picture. For more information about finding your TV's Video Line Input, see page 57.

If you prefer, we can provide you with the name of an Authorized Service Representative who will visit your home for a fee to install your electronic entertainment system and to instruct you in its operation. For details about this service, call 1-888-206-3359.

Choose Your Connection

There are several ways to hook up your VCR depending on the components connected. Please use the following chart to determine which connection is best for you and proceed to the appropriate page.

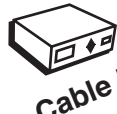
Components	Connection Title	Go To
 	TV + VCR	page 8
  	TV + VCR + Satellite Receiver	page 9
  	TV + VCR + Cable Box	page 10

Connections & Setup

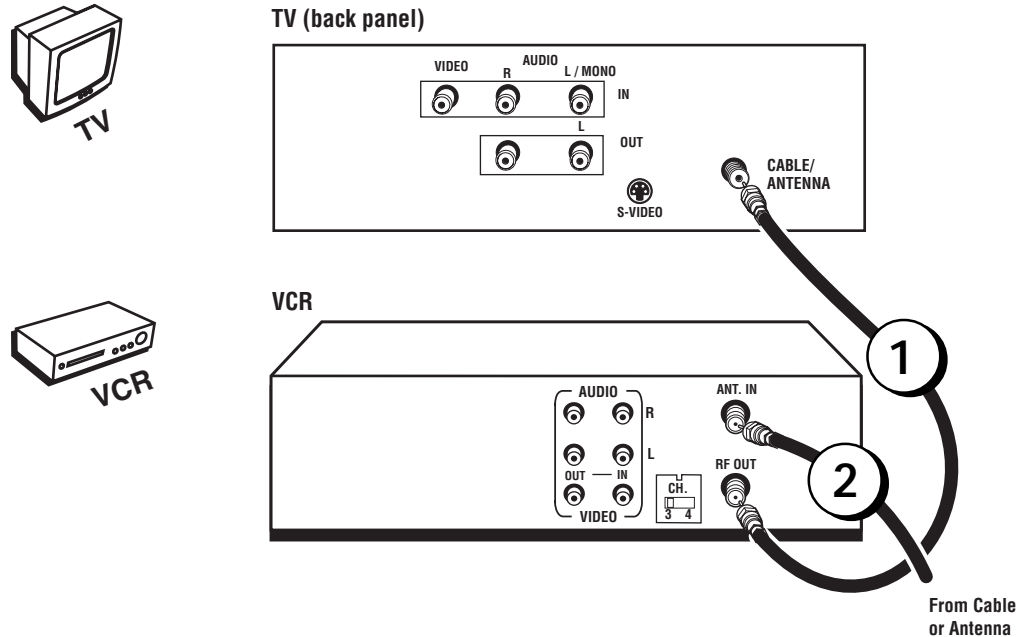

TV + VCR

Need Some Help?

If you prefer, we can provide you with the name of an Authorized Service Representative who will visit your home for a fee to install your electronic entertainment system and to instruct you in its operation. For details about this service, call 1-888-206-3359.

Note: Your television back panel may not look exactly like the model shown here.

1. Connect the VCR to the TV

Connect one end of the supplied RF coaxial cable to the RF OUT jack on the back of the VCR and the other end to the TV's Antenna IN jack.

2. Connect the antenna/cable feed to the VCR

Connect the cable or antenna RF coaxial cable to the ANT. IN jack on your VCR.

Note: Flip the CH 3/4 switch on the back of the VCR to the channel that is *not* used in your area. This will be the channel that the TV must be tuned to in order to see the VCR's picture.

Go To Page 11

Connections & Setup

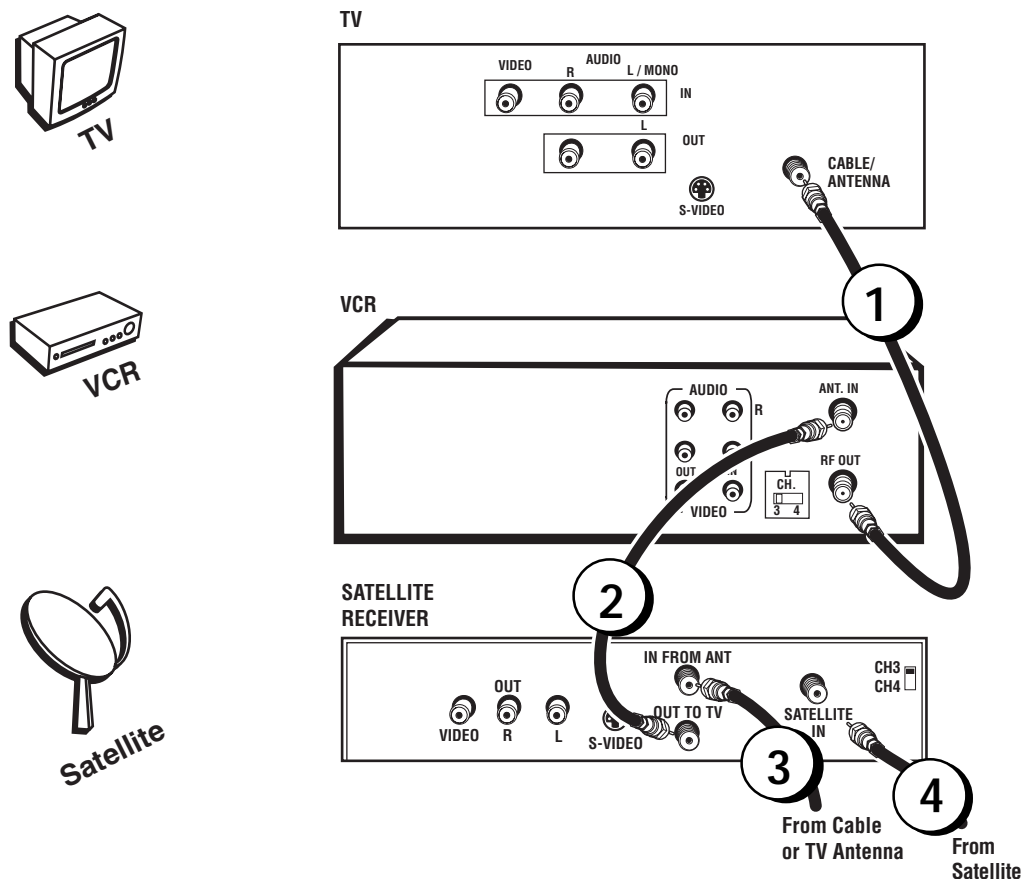

TV + VCR + Satellite Receiver

Note: Your television and/or satellite receiver back panels may not look exactly like the models shown here.

Need Some Help?

If you prefer, we can provide you with the name of an Authorized Service Representative who will visit your home for a fee to install your electronic entertainment system and to instruct you in its operation. For details about this service, call 1-888-206-3359.

1. Connect the VCR to the TV

Connect one end of the supplied RF coaxial cable to the RF OUT jack on the back of the VCR and the other end to the TV's Antenna input jack.

2. Connect satellite receiver to the VCR

Connect a second RF coaxial cable (not included) to the antenna output jack on the satellite receiver and to the ANT. IN jack on the VCR.

3. Connect the antenna to your satellite receiver

If necessary, connect an antenna or cable box RF coaxial cable (not included) to the antenna input jack on the satellite receiver.

4. Connect the satellite feed to the satellite receiver

Connect the satellite receiver's RF coaxial cable feed (not included) to the satellite input jack on the satellite receiver.

Go To Page 11

Connections & Setup

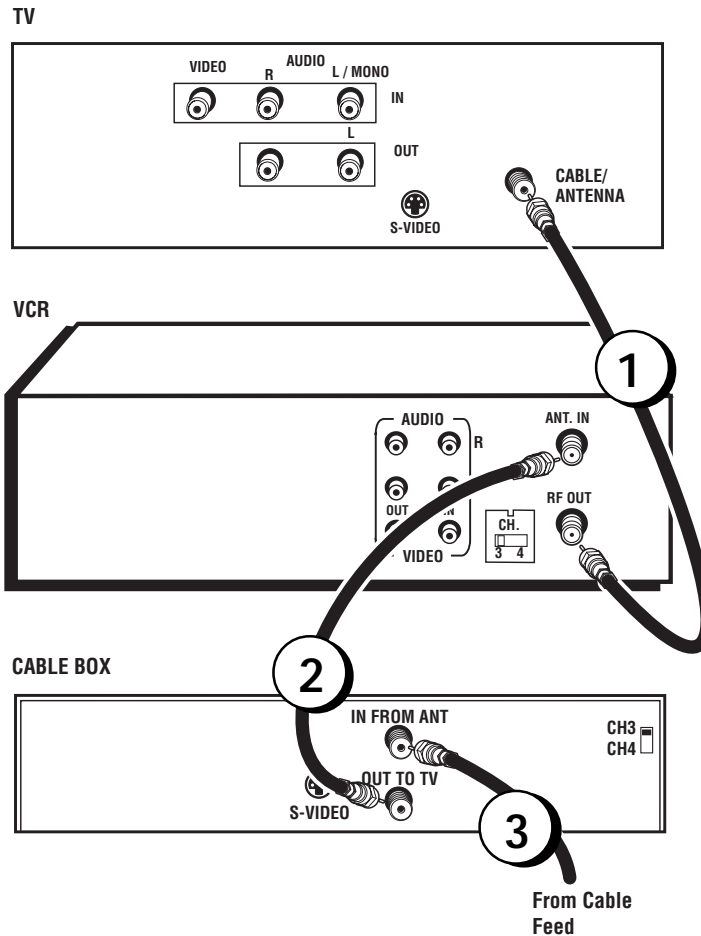
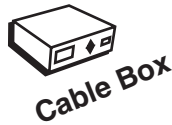

TV + VCR + Cable Box

Need Some Help?

If you prefer, we can provide you with the name of an Authorized Service Representative who will visit your home for a fee to install your electronic entertainment system and to instruct you in its operation. For details about this service, call 1-888-206-3359.

Note: Your television and/or cable box back panels may not look exactly like the models shown here.

- 1. Connect the VCR to the TV**
Connect one end of the supplied RF coaxial cable to the RF OUT jack on the back of the VCR and the other end to the TV's Antenna input jack.
- 2. Connect the cable box to the VCR**
Connect one end of a second RF coaxial cable (not included) to the cable box's antenna output jack and the other end to the ANT. IN jack on the VCR.
- 3. Connect the cable feed to your cable box**
Connect the RF coaxial cable feed (not included) to the antenna input jack on the cable box.

Go To Page 11



Connections & Setup

Set the VCR's CH 3/4 Switch

The CH 3/4 switch on back of the VCR determines what channel the TV must be tuned to see the VCR's image. Choose whichever channel is not used locally in your area.

Note: If you connected components using A/V jacks and cables, the VCR's signal must be viewed using the TV's Video Line Input. To find the Video Line Input, refer to the manual that came with the TV or see *How to Find Your TV's Video Line Input* on page 57 in the *Other Information* section of this manual.

Plug in the VCR

Your VCR's power cord has a plastic band strung through the blades. **Remove the plastic band before plugging the cord into the power outlet.** To remove the band, cut with a pair of scissors and pull it free of the blades. Once the plastic is removed, match the wide blade of the power cord to the wide slot in the AC outlet. Be sure to insert the plug completely.

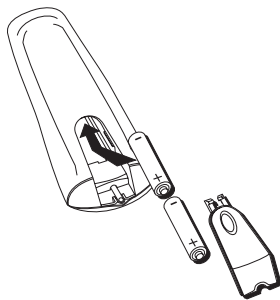

Put Batteries in the Remote Control

1. Remove the battery compartment cover on the remote control.
2. Insert new batteries matching the polarities (+ and -) on the batteries with the diagram in the battery compartment.
3. Put the battery compartment cover back on the remote.

Turn on the TV and VCR

Turn on the TV and press the VCR button on the remote control to turn it on.

Note: If you have an RCA, GE, or Proscan TV, your VCR's remote control may be able to operate it without being programmed. Press the TV button on the remote control and then the ON•OFF button. If neither one turns on the TV, see *Using the Remote Control* starting on page 25 for details about programming the remote control to operate other brands of TVs.

Tune the TV

Tune the TV to the VCR viewing channel. The VCR viewing channel is channel 3, 4, or the TV's video line input.

- If you connect your VCR using RF coaxial cable only, turn the TV to channel 3 or 4 (whichever was set on the CH 3/4 switch).
- If you connected the VCR using A/V jacks and cables, select the TV's video line input. For more information see *How to Find the TV's Video Line Input* on page 57 in the *Other Information* section of this manual.



Connections & Setup

Using the Remote Control to Navigate On-Screen Menus

The technical term is “Navigation” – how you move through the on-screen menus. The theory is the same for all the menu screens; use the corresponding number button on the remote control select it.

To choose an on-screen item, press the remote control’s corresponding number button.

Note: Selecting a menu item can take you to another menu, activate a choice, or activate a data entry field (such as the hour field in the Set Time menu).

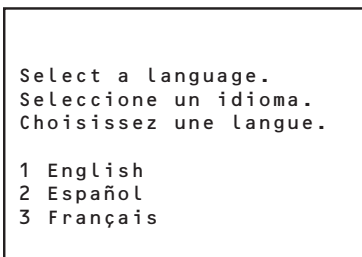

Complete the QuickSet Guide

The menu system in your VCR allows you to customize your preferences as well as use all the VCR’s features. To help you use the VCR as quickly as possible, there is an initial QuickSet Guide that walks you through several important setup steps at one time.

The first time you turn on the VCR, you will be able to set up available channels, time and date information, and more. The first menu you will see asks which language you prefer to have the on-screen menus appear in.

Note: With numbered menu choices, press the corresponding number button on the remote control to automatically select it. In the case of the language menu, press 1 for English, 2 for Español (Spanish), or 3 for Français (French).

The remaining menus throughout the setup will appear in the language chosen. Just follow the step-by-step procedures until the QuickSet Guide is complete.

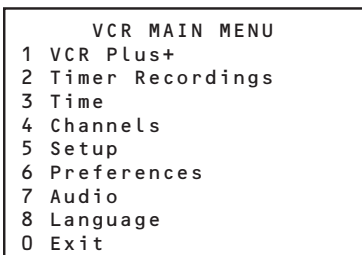

All of the VCR’s menus are accessed through the Main Menu. Press the remote control’s MENU button to start.

Accessing Menus

The series of preferences that are set in the QuickSet Guide can also be handled individually using the VCR’s on-screen menu system. There are other settings not covered in the initial setup that are also handled using the on-screen menus.

For example, if you decide to run the QuickSet Guide again, you can access the *Setup* menu by pressing the remote control’s MENU button. Once the *Main Menu* is displayed, press the 5 button to choose *Setup*. From there, you can start the QuickSet Guide from the beginning.

All on-screen menus are accessed the same way, starting in the *Main Menu* which is displayed by pressing the remote control’s MENU button.

Note: See chapter two, *Using On-Screen Menus*, for details about changing the VCR’s individual settings.



Connections & Setup

VCR Basics

Once your initial settings are complete, you can begin using your VCR. In order to begin, you must first understand some basic concepts.

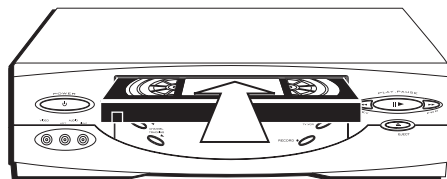

Automatic Tracking

The VCR has automatic tracking which adjusts the picture when playing back a tape recorded on another VCR. To adjust tracking manually, use the TRACKING +/- buttons on the remote control.

Playing a Tape

1. Tune the TV to your VCR viewing channel (03, 04, or the video line input).
2. Insert a tape in the VCR.

If the Auto Play feature is set to ON, the tape automatically begins playback (if the safety tab on the tape is removed).

- Press FWD or REV (FORWARD or REVERSE on the remote control) to cue the tape at the desired starting position.
- Press PLAY (if necessary) to begin tape play.
- Press PAUSE for stop action.
- Press TRACKING up or down (TRACKING + or – on the remote control) to remove any streaks from the picture, if necessary.
- Press STOP to stop playback.

Automatic Rewind

The VCR automatically rewinds the tape if it reaches the end of the tape during playback. While rewinding, you can press the ON•OFF button and the VCR will turn off after finishing. If the tape has no safety tab, it will be ejected.

Tape Eject

Press the EJECT button on the VCR when stopped to eject the tape. You can also press and hold the remote control's STOP button for three seconds.

Recording

To Capture Programming with Basic Recording Methods:

1. Set the tape speed by pressing the SPEED button on the remote control (see Recording Speed on page 23 for information about recording speeds).
2. Press the RECORD button to begin recording.
3. Press the STOP button to halt recording.

If you just want to pause the recording for a short time (like during a commercial), press PAUSE instead of STOP.



Check the Safety Tab

No matter which recording option you use, make sure there is a tape in the VCR with its safety tab in place. You cannot record on a tape with its safety tab removed. If the safety tab is removed and you want to record, simply cover the hole with adhesive tape.





This page left blank intentionally



Using the VCR's Menu System

Chapter Overview:

- Using On-Screen Menus
- Cable Box Setup
- Setting Time and Date
- Setting VCR Preferences

Changing Entertainment. Again.





Using On-Screen Menus

Using On-Screen Menus to Set Up Features

You set up many of the VCR's features by using the menu system as discussed in the previous chapter. Each feature that appears in the QuickSet Guide is explained in this section as well as a few other features you should set up to get the most out of your VCR.

Note: Not all the VCR screens are shown in this manual when explaining how to access features.

Language

Selecting your preferred language determines how the on-screen displays will appear. To change the language:

1. Press MENU to display the *VCR MAIN MENU*.
2. Press the 8 button to select *LANGUAGE*.
3. Select English, Spanish (Español), or French (Français).

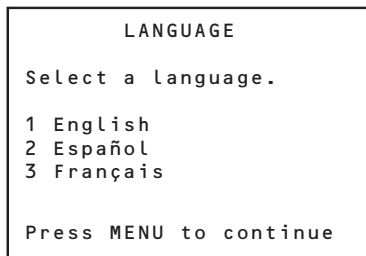

Is Something Missing?

These instructions will not show all of the step-by-step On-Screen Menus. Make sure to follow the instructions completely to get to the menus being discussed.

Cable Box Setup

This setup applies **only** when all channels are received through a cable box. In this case, the VCR will automatically enter the channel used to view cable box programming. Your VCR will use this channel for all future timer recordings.

1. Press MENU to display the *VCR MAIN MENU*.
2. Press 4 to display the *CHANNELS* menu.
3. Press 5 to display the *CABLE BOX SETUP* menu.

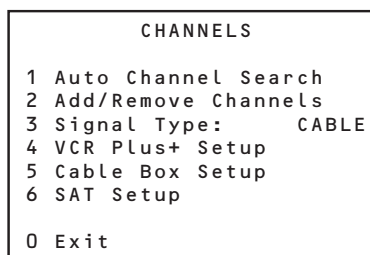



Using On-Screen Menus

CABLE BOX SETUP

Do you use your cable box to receive ALL channels or only SOME channels?

1 ALL channels
2 Only SOME channels
3 Cancel setup

4. Select one of the three choices. If “ALL Channels” is selected, enter the output channel of the cable box (usually 03 or 04), or if A/V jacks connect the VCR to the TV, press the INPUT button on the VCR’s remote control.

CABLE BOX SETUP

The VCR will now receive all signals from the cable box on channel 04.

Press MENU to continue

5. Once you complete the setup, the VCR confirms that it will now receive all signals on the designated channel.

VCR Channels List

Your VCR may come with a list of channels preset at the factory. Even though it may come with such a list, you might want to add or delete certain channels.

Note: If you use a cable box to view *all channels*, this step is not necessary.

Auto Channel Searching

Notes: Use Auto Channel Search to place all available channels in memory.

If you ever change cable or antenna signals, you may need to run the Auto Channel Search feature again.

1. Press the MENU button to display the *VCR MAIN MENU*.
2. Press 4 to select *CHANNELS*.
3. Press 1 to select *AUTO CHANNEL SEARCH*.
4. Select one of the three options:

AUTO CHANNEL SEARCH

What type of signal are you using?

1 Cable TV
2 Antenna
3>Detect Automatically
0 Cancel

Cable TV searches for cable stations.

Antenna searches for local broadcast stations.

Detect Automatically decides which input to use for you.

Note: With *Detect Automatically*, a strong cable or antenna signal in your area may cause channels to be detected inaccurately. If this should happen, manually select the input signal for the system you have.

The VCR begins scanning for channels available in the area (taking about one-to-two minutes). When scanning is complete, the VCR tunes to the lowest channel available. After completing Auto Channel Search, pressing the remote control’s CHAN + or - buttons should only select active channels.





Using On-Screen Menus

Changing the Signal Type

This feature is useful if your cable signal goes out; it allows you to switch to a regular antenna for alternate television reception.

1. Press the MENU button to display the *VCR MAIN MENU*.
2. Press the 4 button to choose *CHANNELS*.
3. Press 3 to choose between *Signal Type: Cable and Antenna*. When finished, press 0 to exit back to the Main Menu and 0 again to exit to normal viewing.

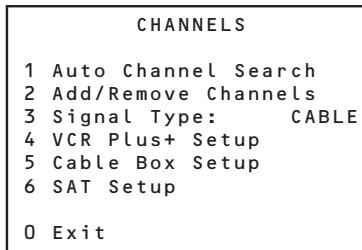

Adding or Removing Channels

You might want to add or remove channels after using Auto Channel Search, especially if there are weak signals or channels with content you don't care for.

1. Press the MENU button to display the *VCR MAIN MENU*.
2. Press 4 to choose *CHANNELS*.
3. Press 2 to choose *ADD/REMOVE CHANNELS*. To go to the channel you want to add or remove, use the remote control's CHANNEL + or - buttons or enter a specific channel number using the number buttons.

Once the desired channel is displayed, the on-screen menu will tell you if the channel is currently in the VCR's viewing list. Press the CLEAR button to remove a channel from the available channels list or press the INFO button to add it.

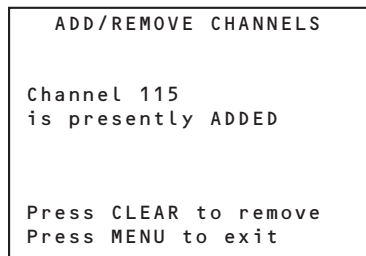

4. Press the MENU button to exit out of the menus.

Note: To view active channels, use the remote control's CHANNEL + and - buttons. You can also access channels not available in the active channel list by using the remote control's number buttons to enter the specific channel number.





Using On-Screen Menus

Time and Date

Your VCR gives you two ways to set the time and date; manually or by using the Auto Clock Set feature. Using Auto Clock Set enables the time to be updated each time the VCR is turned off by using time and date information carried in certain broadcast signals.

Auto Clock Set Feature

The Auto Clock Set feature is set to *ON* by default at the factory. In the *ON* setting, the VCR looks for a channel carrying time data and updates the clock automatically. In order for Auto Clock Set to work properly though, certain steps must first be completed such as Auto Channel Search, setting the time zone, and setting the Daylight-Saving feature.

Notes: Auto Clock Set is available only in limited areas.

You must set available channels, time zone, and Daylight-Saving settings for Auto Clock Set to work.

When using Auto Clock Set with a cable box, the VCR will not reset the clock after a power outage unless the cable box is tuned to the channel carrying time data.

If the time does not automatically set after trying for ten minutes, manually set the time and date information using the *TIME* menu (see the next page for information on manually setting time and date information).

To Turn Auto Clock Set ON

Note: make sure that available channels, time zone, and Daylight-Saving features are set before turning on Auto Clock Set.

1. Press MENU to display the *VCR MAIN MENU*.
2. Press 3 to choose *TIME*.
3. Press the 2 button repeatedly to toggle between *Auto Clock Set ON* and *OFF*.

```

      TIME
1 Set Time and Date
2 Auto Clock Set:  ON
3 Set Time Zone
4 Set DayLight Saving

Time Data was found
on channel 20.

0 Exit

```

Setting the Time Zone

1. Press MENU to display the *VCR MAIN MENU*.
2. Press 3 to choose *TIME*.
3. Press 3 to chose *SET TIME ZONE*.
4. Select your time zone by pressing the corresponding number button.

If you select *Automatic* for your time zone, the VCR sets the clock using the first time information it finds. If the time set is not correct, select another time zone or set the time and date through the menu system.

```

      SET TIME ZONE
What is your Time Zone?
1 Eastern
2 Central
3 Mountain
4 Pacific
5 Alaska
6 Hawaii
7>Automatic
Press MENU to continue

```



Using On-Screen Menus

Setting Daylight-Saving Time

1. Press MENU to display the *VCR MAIN MENU*.
2. Press 3 to choose *TIME*.
3. Press 4 to choose *SET DAYLIGHT SAVING*.

```
TIME
1 Set Time and Date
2 Auto Clock Set:  ON
3 Set Time Zone
4 Set Daylight Saving

Time Data was found
on channel 20.

0 Exit
```

```
SET DAYLIGHT SAVING

Does your area observe
Daylight Saving Time
from April to October?

1 Yes, DST is observed
2 No
3 Automatic
Press MENU to continue
```

4. Select the appropriate option.

Notes: DST stands for Daylight-Saving Time.

If you choose *Automatic* for the time zone, the VCR sets the clock using any DST information broadcast in the channel's signal.

Displaying Time and Date

Pressing the *INFO* button on the remote control or *VCR* displays the time and date on screen temporarily.

Setting Time and Date Manually

If Auto Clock Set was unsuccessful, set the time and date manually in the *TIME* menu. Auto Clock Set is automatically turned off when time and date information is set this way.

1. Press MENU to display the *VCR MAIN MENU*.
2. Press 3 to choose *TIME*.
3. Press 1 to choose *SET TIME AND DATE*.

```
TIME
1 Set Time and Date
2 Auto Clock Set:  ON
3 Set Time Zone
4 Set Daylight Saving

Time Data was found
on channel 20.

0 Exit
```

```
SET TIME AND DATE

Time --:--
      (hh:mm)

Date --/--/--

Press MENU to cancel
```

4. Enter the data using the number buttons. Press 0 before single-digit numbers and follow the on-screen directions to exit the menus.



Using On-Screen Menus

PREFERENCES		
1	Remote Control:	VCR1
2	Auto Play:	ON
3	Auto TV/VCR:	ON
4	EnergySaver:	2:00
5	Front Panel:	AUTO
6	Tape Speed:	SLP
7	Set Auto Repeat	
8	COMMERCIAL ADVANCE	
0	Exit	

The PREFERENCES menu allows changes to be made to a variety of different VCR features.

Additional Set Up Features in the Preferences Menu

Note: The features described on the following pages are all accessed through the *PREFERENCES* menu.

To Access the *PREFERENCES* menu:

1. Press MENU to display the *VCR MAIN MENU*.
2. Press 6 to select *PREFERENCES*.

You are now ready to select an item from the *PREFERENCES* menu to set up.

Remote VCR1/VCR2 Option

Some universal remote controls have buttons labeled VCR1 and VCR2. These remotes can operate up to two VCRs. If you have a universal remote control with this ability, your RCA VCR can be controlled with either the VCR1 or VCR2 button. See the documentation that came with your universal remote control for details about programming it to operate your RCA VCR.

In the *PREFERENCES* menu, press 1 to select the *Remote Control* feature. Then press the VCR2 button on your universal remote control to change the setting.

Then, the VCR will respond to the universal remote control's VCR2 button. To change the remote control setting back to VCR1, display the *PREFERENCES* menu, press 1, and then press the VCR1 button on the universal remote control.

Note: Remember you must press VCR1 or VCR2 on a universal remote control (not included) —whichever is selected in the *PREFERENCES* menu— before the remote control will operate the VCR.

Auto Play

With Auto Play turned ON (the factory default setting), the VCR automatically starts playback when you insert a tape with its safety tab removed.

To Access Auto Play:

1. In the *PREFERENCES* menu, press 2 repeatedly to switch between *Auto Play: ON* and *OFF*.
 - Select *ON* if you want a tape with its safety tab removed to start playing automatically when inserted.
 - Select *OFF* if you *do not* want a tape with its safety tab removed to start playing automatically.





Using On-Screen Menus

PREFERENCES	
1 Remote Control:	VCR1
2 Auto Play:	ON
3 Auto TV/VCR:	ON
4 EnergySaver:	2:00
5 Front Panel:	AUTO
6 Tape Speed:	SLP
7 Set Auto Repeat	
8 COMMERCIAL ADVANCE	
0 Exit	

The PREFERENCES menu allows changes to be made to a variety of different VCR features.

Auto TV/VCR

To control whether the VCR's TV/VCR setting changes automatically to VCR-viewing mode when turned on, use the Auto TV/VCR setting.

To Access Auto TV/VCR:

In the PREFERENCES menu, press 3 repeatedly to toggle between *Auto TV/VCR: ON* and *OFF*.

Note: Pressing the TV•VCR button on the remote control will switch between VCR and TV-viewing modes. When in VCR-viewing mode, VCR is displayed on the front panel. The VCR indicator turns off when in TV-viewing mode.

- Select *ON* to switch VCR-viewing mode on automatically when the power is turned on. The VCR must be connected to the TV using the supplied RF coaxial cable.
- Select *OFF* to remain in the TV-viewing mode when the VCR is initially turned on. Leaving Auto TV/VCR off is useful if you use A/V cables to connect the VCR to the TV and you watch the VCR's picture using the TV's Video Line Input. This way, the antenna/cable signal will not be interrupted by the VCR.

EnergySaver

By default, the VCR automatically turns off after two hours of inactivity. This can be changed in the PREFERENCES menu by pressing the 4 button repeatedly to change the time delay or to disable the feature altogether.

- Select *OFF* and the VCR will stay on until you shut it off.
- Select *1:00*, *2:00*, or *3:00* and the VCR will turn off after one, two, or three hours of inactivity.

Thirty seconds before automatically shutting off, the VCR displays an on-screen message reading, *The VCR will turn off in 30 seconds. Press any key to cancel.* Pressing any remote control or VCR front panel button will halt the countdown.

If you use the VCR's tuner instead of your TV to view channels, you may want to turn off this feature.

Front Panel Brightness (VCR Display)

You can change the brightness level of the VCR's front panel display. In the PREFERENCES menu, press the 5 button repeatedly to toggle between options:

- *AUTO* means the display brightens when the VCR is on and dims when the VCR is off.
- *BRIGHT* keeps the display bright whether the VCR is on or off.
- *DIM* keeps the display at a low brightness level whether the VCR is on or off.





Using On-Screen Menus

Recording Speeds

SP (Standard Play)

Gives the best quality recording, but fewer programs can be recorded on the tape.

SLP (Super Long Play)

Gives three times the recording time of tapes recorded in SP mode.

Recording Times

Cassette	SP	SLP
T-120	2 Hr	6 Hr
T-160	2 Hr/40 Min	8 Hr

Tape Speed

You can choose as the preferred recording tape speed either Standard Play (SP) or Super Long Play (SLP). The speed selected appears in the VCR's front display panel and in timer and VCR Plus+ system recording menus.

To Select a Preferred Tape Speed:

- In the *PREFERENCES* menu, press the 6 button repeatedly to switch between *SP* and *SLP* settings.

Note: For an explanation of recording speeds, see the note to the left.

To Override the Preferred Tape Speed:

- Press the *SPEED* button on the remote control.
- Set the tape speed in the timer or VCR Plus+ system recording menus.

When you turn off the VCR, the tape speed reverts to the one selected as the default.

Set Auto Repeat

A tape can be set to play the same segment over and over in a repeating loop with the Set Auto Repeat feature. Set Auto Repeat uses the VCR's memory counter to determine the duration of the loop.

In the *PREFERENCES* menu, press the 7 button to choose *Set Auto Repeat*. The *SET AUTO REPEAT* menu will ask for an ending time for the loop to be specified:

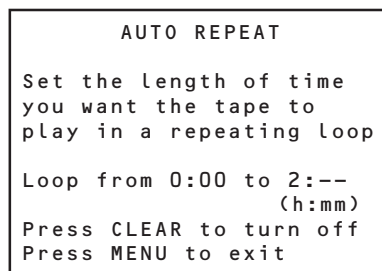

- The *CLEAR* button will erase all three numbers entered and move the cursor back to the first position (hours).
- The *Press CLEAR to turn off* message will appear only after the first number has been entered into the end time.
- Auto Repeat is set back to *---* by resetting the dialog box, ejecting a tape, powering off the VCR, power interruption, or by recording start.

When a duration time has been set:

- The VCR will automatically switch to rewind if the counter meets or goes past the set Auto Repeat duration.
- The VCR will automatically switch to playback during rewind if the counter equals or is less than 0:00.
- The Auto Repeat may be adjusted by setting the counter to 00:00. This can be done by pressing the *CLEAR* button while the tape counter is on screen or on the front panel display.
- The counter will not reset while rewinding in an Auto Repeat loop.





This page left blank intentionally



Using the Remote Control

Chapter Overview:

- Buttons on the Remote Control
- Programming the Remote to Operate Other Components
- How To Use the Remote After You've Programmed It

Changing Entertainment. Again.



Using the Remote Control

Remote Control Buttons

The backlit remote has a light button (☉) that glows in the dark. Press this button to light the buttons on the remote. The remote buttons remain lit when they are pressed within a few seconds of each other. If a button is not pressed within approximately seven seconds, the light turns off to conserve battery power.

The remote control is capable of controlling your VCR and many brands of televisions. If you have an RCA, GE, or Proscan TV, you may be able to control it without having to program the remote.



Component Buttons

ON•OFF Turns off VCR when remote is set to control the VCR. Also turns some compatible components on and off.

TV Turns on a compatible RCA, GE, or PROSCAN TV and sets the remote to control the TV. Also used with the ON•OFF button to turn on a different brand of TV (if programmed) and sets the remote to control the TV.

VCR Turns on a compatible RCA, GE, or PROSCAN VCR and sets the remote to control the VCR.

VCR Function Buttons

CHAN Up or Down Selects next higher or lower channel in the VCR's channel memory.

CLEAR Resets time counter to 0:00:00. Allows you to change entries when setting the clock or a timer recording.

F. ADV Lets you view one frame with each press of the button when tape is in pause.

FORWARD Fast forwards the tape when the VCR is stopped. Searches forward through a tape during playback. Starts slow motion during play-pause and increases slow-motion speed.

GO BACK Switches between two channels. Select one channel and then select another using the number buttons. Press GO BACK to switch between the two channels. In menu mode, press to go back to a previous menu.

INFO Shows the status displays on the TV screen.

INPUT Selects between the VCR's line input or tuner. Line input refers to the signal coming from the component connected to the AUDIO/VIDEO IN jacks on the back (L1) or front (L2) of the VCR.

MENU Brings up VCR MAIN MENU on the TV screen.

Numbers (0 through 9) Select a channel up to 99 by pressing two numbers. Select a cable channel over 99 by pressing and holding 1 until 1 -- appears on the screen. Then press the other two numbers.



Using the Remote Control

PAUSE Pauses playback or recording. Press PAUSE a second time to return to playback or recording.

PLAY Plays a tape.

RECORD Starts VCR recording. Also used for Express recording.

REVERSE Rewinds the tape when the VCR is stopped. Searches backward through a tape during playback. Starts slow motion during play-pause and decreases slow-motion speed.

SEARCH Displays INDEX and GO-TO Search menus on screen when the VCR is stopped. Advances the tape forward through 30 seconds of recorded material during playback. Each press advances the tape an additional 30 seconds (up to five minutes). This button also displays the MOVIE ADVANCE screen for prerecorded movies and starts COMMERCIAL ADVANCE skipping during playback.

SPEED Selects a recording speed (SP or SLP).

STOP Stops the current VCR function such as record, playback, rewind, or fast forward.

TRACKING Up or Down Lets you manually reduce the streaks that may appear on the picture during play, slow motion, or pause. Reduces picture "jitter" during stop-action playback.

TV•VCR Switches the picture signal so that it either comes from the VCR or cable/antenna system.

TV Function Buttons

CHAN Up or Down Selects next higher or lower channel in the TV's channel memory.

CLEAR Removes menus or status displays from the screen.

GO BACK Switches between two channels. Select one channel and then select another using the number buttons. Press GO BACK to switch between the two channels.

INFO Shows the TV's status displays on the TV screen.

INPUT Selects between the TV's input channel or tuner. Press to see the VCR signal if you connected your VCR using the AUDIO/VIDEO jacks.

MUTE Reduces volume to minimum level.

Numbers (0 through 9) Select a channel up to 99 by pressing two numbers. Select a cable channel over 99 by pressing and holding 1 until 1 -- appears on the screen. Then press the other two numbers.

ON•OFF Turns a compatible TV off and on.

VOL Up and Down Raises and lowers sound of TV.





Using the Remote Control

Using the INPUT Button

Use the INPUT button to toggle through the available Video Line Input sources (L1, L2, and regular broadcasting signals) and regular broadcast signals. Video Line Input allows you to view the image from a connected device (like a camcorder) through the VCR.

1. Press the remote control's VCR button to activate VCR-controlling mode. Make sure that the VCR is turned ON.
2. Press the remote control's INPUT button to tune to the Video Line Input source. L1 represents the rear A/V jacks and L2 represents the front A/V jacks.
3. Press the INPUT button again to tune back to the broadcast signal you were previously watching through the VCR.

Operating a TV with the VCR's Remote Control

The remote control that came with your VCR can be programmed to operate most brands of remote-controllable TVs and should already control most RCA, GE, and Proscan models without programming.

Do You Need to Program the Remote?

To determine whether the remote control needs to be programmed to operate your TV, turn the TV on, point the remote control at it, then press the remote control's TV button (this puts the remote control into TV-operating mode and should automatically turn on most RCA, GE, and Proscan TVs). Press the remote control's ON•OFF button to see if the TV responds to the command. If not, the remote control needs to be programmed to control that model TV.

Programming the Remote Control

To program your remote control, you must use the code list on the next page. Look up the brand name of your TV and the code(s) that brand uses.

Notes: This remote control may not operate all models of the brands shown in the code list.

Note the difference between the TV and VCR on-screen displays to know which component the remote control is operating.

1. Turn on the TV.
2. Find your TV brand and code number(s) in the code list.
3. Press and hold the TV button on the remote control.
4. Enter the code from the code list.
5. Release the TV button, then press the CHAN up or down button. If the TV responds to the remote control's command, the remote is programmed.
6. If the TV does not respond, repeat these steps using the next code listed for your TV's brand.



Using the Remote Control

TV Codes

Akai	03	NAD	07
AOC	06,12	NEC	06
Candle	06	Panasonic	04, 08, 11
Citizen	06	Philco	04, 06, 12
Colortyme	06	Philips	03, 04, 06, 12
Concerto	06	Pioneer	06
Curtis Mathes	01,06	Portland	06, 12
Daewoo	06,12	Proscan	01
Daytron	06	Proton	06
Electrohome	06,12	Quasar	11
Emerson	06	Radio Shack	01, 05, 13
Envision	05, 06	RCA	01, 06, 12
Fisher	05, 08	Realistic	05
GE	00, 01, 06, 11	Sampo	06
Goldstar	06,12	Samsung	06, 09, 12
Hallmark	06	Sanyo	05, 08
Hitachi	06,14	Sears	01, 05, 06, 07, 08, 10, 12
Infinity	04	Sharp	06,13
J C Penney	00, 01, 06, 09, 12	Sony	03
JBL	04	Soundesign	06
Jensen	06	Sylvania	04, 06, 12
JVC	10, 11	Technics	11
Kawasho	03, 06	Techwood	06
Kenwood	06, 12	Teknika	06
Loewe	04	TMK	06
Luxman	06	Toshiba	05, 07, 08, 09
LXI	04, 05, 07	Universal	00
Magnavox	04, 06, 12	Victor	10
Marantz	04, 06	Wards	00, 01, 04, 06, 12, 13
MGA	06, 12	Yamaha	12
Mitsubishi	06, 12	Zenith	02
MTC	06		





Using the Remote Control

Operating the TV

After you set up the remote control, see which buttons operate your TV:

1. Point the remote control at the TV, and press the TV button. If the TV does not turn on, press the TV button and then press the ON •OFF button.
2. You may want to experiment to see which buttons operate your TV. Try pressing buttons, such as VOL and MUTE. See the button descriptions in this chapter for details about what each remote control button does.



Chapter 4

Using the VCR's Features

Chapter Overview:

- Recording
- Express Recording (XPR)
- Timer Recordings
- Using the VCR Plus+ System
- Copying and Editing Tapes

Changing Entertainment. Again.





VCR Features

Recording Features

Your VCR provides many ways to capture programming:

1. **Recording** lets you press one button to record a program.
2. **Express Recording (XPR)** allows recording to start while a program is being watched. This feature automatically stops recording after a designated period of time.
3. **Timer Recording** program the VCR for a daily, weekly, or one-time recording which will automatically start and stop at the times you set.
4. **Timer Recording with the VCR Plus+ System** program the VCR by entering a PlusCode programming number found in most TV program listings.

Express Recording (XPR)

Use XPR to quickly record the remaining portion of a program being watched. XPR is a great way to capture the end of a sporting event that has run into overtime or a live broadcast that runs long.

XPR works in 30-minute increments. You can capture the last 30, 60, 90, etc. minutes of programming (depending on tape length), up to four hours total.

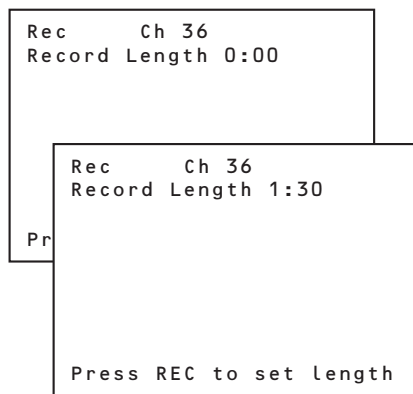

To Activate XPR:

1. If necessary, turn on the VCR and tune it to the channel with the desired programming.
2. If necessary, insert a tape with its safety tab in place into the VCR. Make sure it is cued to record at the proper starting point.

Note: To override the preferred tape speed setting, press the SPEED button on the remote control repeatedly to toggle between SP and SLP choices.
3. Press the RECORD button on the remote control or VCR front panel to start recording.
4. Repeatedly press the RECORD button to set up the recording duration.
 - Each press of the RECORD button adds 30 minutes of recording time.
 - The VCR automatically turns off after recording for the set time.
 - To stop an XPR recording, press and hold the STOP button on the remote control or VCR front panel for several seconds until *STOP* appears on the VCR on-screen display.



Timer Recording

You can program up to eight different broadcasts to be recorded.

Notes– In order for a timer recording to work:

- The VCR's clock must be set correctly.
- Insert a tape with its safety tab in place and enough tape to record the program.
- If you've set up the VCR for a cable box for all channels, the output of your cable box appears in the channel item of the *Timer Recording* menu.
- **PROGRAMS OVERLAP** appears if two programs whose times overlap are entered.
- **TIMER** appears in the display when you turn off the VCR and a timer recording has been set. **TIMER** flashes if there is no tape in the VCR when a timer recording has been set and the unit is turned off.
- For a cable box or satellite receiver, turn it on and tune it to the channel you want to record before the recording is to begin.

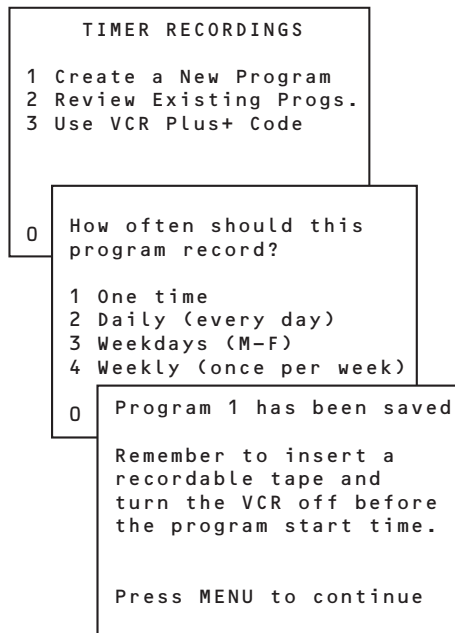

To Set Up to as Many as Eight Timer Recording Programs:

1. Press the MENU button to display the *VCR MAIN MENU*.
2. Press the 2 button to choose *TIMER RECORDINGS*.
3. Press the 1 button to choose *Create a New Program*.
4. Select how often you want the program to record.
5. Enter the data for the program with the number buttons.

The data includes the channel number (press INPUT to select the Video Line Input if using A/V jacks to connect the VCR to the TV), and start and end times (including AM or PM). The start date is automatically entered based on the VCR clock. Both the recording date and speed can be changed.

6. Review the information to make sure it is correct.
7. Press the MENU button to save.

Stopping a Timer Recording

To stop or cancel a timer recording in progress (even an Express Recording):

Press and hold the STOP button for several seconds until *STOP* appears in the on-screen display.

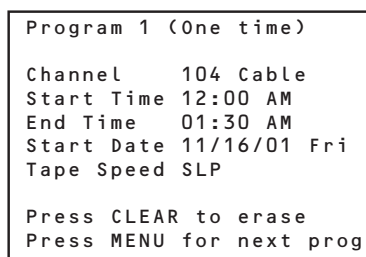

Reviewing and Clearing Programs

To review programs that you have already set up:

1. Press the MENU button to display the *VCR Main Menu*.
2. Press the 2 button to choose *TIMER RECORDINGS*.
3. Press the 2 button to choose *Review Existing Progs.*
4. Press CLEAR to erase or MENU to see the next saved timer recording program.



VCR Features

VCR Plus+ SILVER System

The VCR Plus+ SILVER system makes VCR set up easier by setting and updating the clock and channel list for you automatically. During the first-time QuickSet Guide setup, the VCR prompts you to enter your zip code. Soon after, the VCR clock will set itself and your VCR Plus+ system channel list will be input for you.

Time, date, and VCR Plus+ system information are downloaded from participating TV stations over your antenna or cable system. Time and date information are updated each time the VCR is turned off (and after every power interruption). So, when your TV stations or cable company update their lineups, your VCR will get the most current channel list automatically, freeing you from having to manually change the channel list yourself.

If your VCR Plus+ SILVER system fails to download the proper information for any reason, you can always manually map the channels. You can also turn off AUTO VCR Plus+ if you keep getting prompts about *multiple cable* services by pressing the 2 button in the *VCR Plus+ SETUP* menu.

```

VCR PLUS+ SETUP

Last automatic setup
was unsuccessful.
Would you like to:

1 Try again
2 Finish setup manually
3 Cancel the auto setup

```

Turning ON or OFF the Auto VCR Plus+ download

If the automatic VCR Plus+ download continuously fails for any reason, you will see the prompt to the left.

If you decide to turn off Auto VCR Plus+ all together, you can do this by:

1. Press the MENU button on the remote control to access the VCR's MAIN MENU
2. Press 4 to access the CHANNELS menu.
3. Press 4 to access the VCR Plus+ Setup menu.
4. Pressing 1 will take you to a screen to manually map VCR Plus+ channels. Pressing 2 will toggle between *Auto VCR Plus+*: ON or OFF.

Make sure this feature is turned off if you continually get *fail to download* prompts and map the channels manually.

```

VCR PLUS+ SETUP

1 Set channel lists
2 Auto VCR Plus+:  ON

VCR Plus+ data was not
found.

0 Exit

```

VCR Plus+ and PlusCode are registered trademarks of the Gemstar Development Corporation. The VCR Plus+ system is manufactured under the license from Gemstar Development Corporation.



Mapping VCR Plus+ Channels Manually

Using the VCR Plus+ SILVER system can make taping timer recordings for cable or off-air antenna easier. If your VCR Plus+ SILVER system setup failed during the QuickSet, then you will need to map the channels for your local service manually. A worksheet and abbreviated codes for typical cable services in the U.S. and Canada are provided.

1. Press the MENU button to display the *VCR MAIN MENU*.
2. Press the 4 button to choose *CHANNELS*.
3. Press the 4 button to choose *VCR Plus+ Setup*.
4. Press 1 to display the Set Channel Lists menu.

```
VCR PLUS+ SETUP
1 Set channel lists
2 Auto VCR Plus+:   ON

VCR Plus+ data was not
found.

0 Exit
```

```
VCR+ Channel  My Channel
5             --
4             --
3 -> -> -> --
2             --
1             --

Use CH+/- to select
Press 0-9 to change
Press MENU to save
```

5. Enter the data following the on-screen directions using your worksheet.

```
VCR+ Channel  My Channel
5             46
4             --
3 -> -> -> 23
2             --
1             --

Use CH+/- to select
Press 0-9 to change
Press MENU to save
```

(Screen shown is for an example only.)



VCR Features

Two-Digit VCR Plus+ System Channel Numbers for Cable TV (USA List)

35	American Movie Classics
39	Arts &-Entertainment
57	Black Entertainment
54	Bravo
42	Cable News Network
45	Cinemax
98	Cinemax 2
37	The Discovery Channel
53	The Disney Channel
63	Entertainment Television
34	ESPN Sports Network
47	The Family Channel
33	Home Box Office
95	Home Box Office 2
96	Home Box Office 3
51	The Learning Channel
46	Lifetime
58	The Movie Channel
48	Music Television
49	The Nashville Network
38	Nickelodeon
64	Nostalgia Television
99	Quality Value Cable
41	Showtime
97	Showtime 2
59	Sports Channel
52	Turner Network Television
44	USA-Network
62	Video Hits 1
93	Viewer's Choice 1
94	Viewer's Choice 2
55	WGN Chicago
43	WTBS Atlanta
60	WWOR-New York

Two-Digit VCR Plus+ System Channel Numbers for Cable TV (Canadian List)

67	Allarcom Pay Television/ Superchannel
44	Arts & Entertainment
72	Cable News Network- Headline News
61	Cable News Network
70	Canadian Home Shopping Network
56	Canal Famille
69	Cathay International Television Inc.
68	Chinavision Canada Corp
60	Country Music Television
63	Family Channel
62	First Choice
96	First Choice Two
97	First Choice Three
99	First Choice Four
90	House of Commons
91	La Chaine Francaise
51	The Learning Channel
65	MeteoMedia/The Weather Network
48	MuchMusic Network
55	MusiquePlus
52	Nashville Network
73	Newsworld/CBC
53	Le Reseau des Sports
43	The Sports Network
64	Super Ecran
37	Super Ecran B
98	Super Ecran C
66	Telatino Network
46	TV5 Montreal
92	Viewer's Choice 1
93	Viewer's Choice 2
94	Viewer's Choice 3
95	Viewer's Choice 4
71	Vision TV: Canada's Faith Network
38	Youth TV, Canada Inc.

Note: Refer to your local TV program listings for a complete VCR Plus+ channel list for your viewing area or contact your cable company. Using the list may save you some time.



VCR Features

Recording Broadcast Stereo TV or SAP (Second Audio Program)

Some TV programs are broadcast with stereo audio or SAP (Second Audio Program).

1. Turn on the TV and tune it to the VCR viewing channel (either 03, 04, or the TV's Video Line Input).
2. Insert a tape with its safety tab in place.
3. If your VCR viewing channel is 3 or 4, make sure the VCR indicator appears in the front display. If not, press the TV•VCR button on the remote control to turn it on.
4. Press the SPEED button on the remote control if you want to override the preferred Tape Speed setting. The tape speed indicator appears on the TV screen.
5. Select the channel or Video Line Input to be recorded.
6. Set the *Reception: STEREO/MONO/SAP* feature for the type of audio you want to record.
7. Press RECORD to start recording.
8. Press STOP when finished.

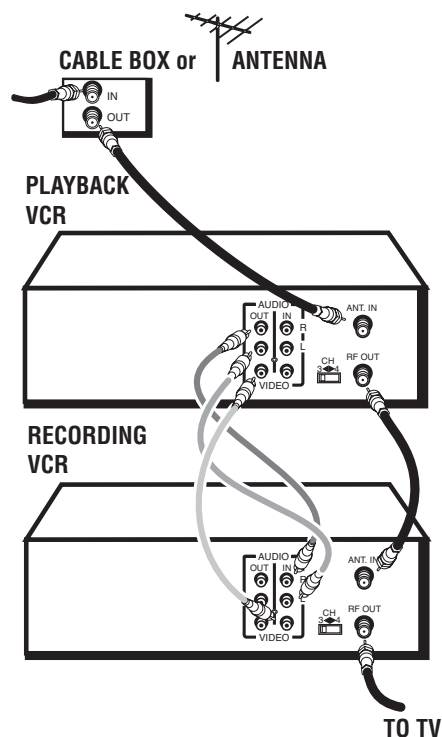

Caution:

The unauthorized recording of satellite broadcasts, television programs, or other copyrighted materials may infringe the rights of others.

Copying and Editing Tapes Using Two VCRs

Use one VCR as the *playback* VCR and the other as the *recording* VCR.

1. Turn on the TV and VCRs.
2. Tune the TV to the VCR viewing channel (either 03, 04, or the TV's Video Line Input).
3. If you connected your VCR using the ANT. IN and RF OUT jacks, tune the *recording* VCR to channel 3 or 4—whichever is selected on the back of the *playback* VCR.

If you have connected your VCR using the A/V jacks, press INPUT on the *recording* VCR's remote control to select the Video Line Input. Select L1 for the jacks on the back of the VCR or L2 for the jacks on the front.
4. Insert the tape you want to copy into the *playback* VCR. Insert a tape with its safety tab in place into the *recording* VCR.
5. Press PLAY on the *playback* VCR to begin playback. When you reach the point on the tape or program where you want to begin copying, press the PAUSE button. You may need to adjust the tracking.
6. Press the RECORD button, then press PAUSE on the *recording* VCR.
7. Press the PAUSE buttons on *both* VCRs at the same time to begin copying the tape.
8. To edit segments that you do not want to copy:
 - Press PAUSE on *recording* VCR to pause copying.
 - Locate the next segment you want to copy on the *playback* VCR by using FWD, REV, and PLAY, and then press PAUSE.
 - Press PAUSE on *both* VCRs at the same time to resume copying.
9. Press STOP on *both* VCRs when finished.

Picture Search Options

The basic way to search during playback is using the remote control's FORWARD or REVERSE buttons (FWD and REV on the VCR). This section contains several other options available for searching a tape.

Insert Tape:

Don't forget to insert a recorded tape when using the search features.

Forward and Reverse Search

You can search a tape during playback either forward or reverse in direction.

Note: Sound is turned off during picture search.

1. Press the FORWARD button to search forward or the REVERSE button to search backwards.
2. Press the FORWARD, REVERSE, or PLAY button to return to normal playback.

Slow Motion

You can view a tape during play or play-pause mode using Slow Motion search.

1. In pause mode, press the FORWARD (FWD) or REVERSE (REV) button to start slow-motion playback.
2. Press the FORWARD button to increase or the REVERSE button to decrease the search speed.
3. Use the TRACKING + or – buttons to remove any streaks from the picture.
4. Press the PLAY button to return to normal playback.

The VCR switches automatically from slow-motion playback to stop after a few uninterrupted minutes.

Frame Advance

Frame Advance lets you view single-frame action during playback.

1. While playback is in progress, press the remote control's PAUSE button (PLAY/PAUSE on the VCR) to freeze the action.
2. Press the F. ADV button on the remote control each time you want to view the next frame of the recording.
3. Press the PAUSE or PLAY button on the remote control (PLAY/PAUSE on the VCR) to return to normal playback.



VCR Features

Index Search

The VCR has a “VHS Index Search System” that automatically records index marks on the tape every time you start a recording. During playback you can locate the program you want to play by the number of index marks or by scanning. The VCR will search forward or reverse from the location you are at on the tape.

```

INDEX SEARCH

Press REV or FWD
to begin scanning
OR
enter a specific
index number
--
Press SEARCH to exit

```

To Activate Index Search:

1. While playing back, press the STOP button to freeze the action.
2. Press the SEARCH button on the remote control to display the *INDEX SEARCH* screen on the TV screen.
3. If you want to search through a certain number of index marks, press two number buttons to enter the number of marks you want to search. Press the CLEAR button on the remote control to correct an entry.
4. Press the FORWARD button to search forward or the REVERSE button to search in reverse. The VCR will locate your index mark and begin playback. If you did not enter a specific index number, the VCR will locate the next index mark and begin playback.
5. Press STOP to stop Index Search.

Notes— Certain index marks may be missed by the VCR including:

- Marks too close to the current location of the tape.
- Those at the beginning of a recording lasting five minutes or less.
- Index marks that start at the beginning of the tape.

```

GO-TO SEARCH

Current tape counter is
2:17:25

Press REV or FWD
to go to --:--:00

Press SEARCH to exit

```

Go-To Search

The Go-To Search feature enables the VCR to quickly locate a counter reading anywhere on the tape. When the VCR locates the counter reading, it will begin playback.

1. Press the STOP button.
2. Repeatedly press the SEARCH button on the remote control until the *GO-TO SEARCH* menu appears on the screen.
3. Use the number buttons to enter the hour and/or minute of the counter reading you want the VCR to go to. If necessary, press the CLEAR button on the remote control to correct an entry.
4. Press the FORWARD button to search ahead or the REVERSE button to search behind.
5. Press the STOP button to end a Go-To search.



COMMERCIAL ▶▶ ADVANCE®

This feature uses patented technology to detect and mark most commercials on your tape for any recording that is more than 15 minutes long. Once recording is finished, the VCR rewinds the tape to the beginning of the recording and determines where the commercials are located. It then marks the beginning and end of the detected commercial segments, and when finished, returns the tape to the end of the recording. **It does not erase commercials from the tape.**

During playback, the VCR automatically skips the detected commercial segments, or you can choose to manually skip them. This feature reduces three minutes of commercials to approximately 8-12 seconds of fast forwarding in the SLP speed. You can select a background display of blue or see the video as the commercials are skipped.

Because television signals do not indicate where commercials are located, this feature finds and marks them through a set of formulas based on how television is broadcast today. Since television stations broadcast differently and insert their own commercials, you may experience some variations in this feature's effectiveness. Station promotions, identifications, and announcements are not considered commercials, but might be skipped. For more information, see "Questions and Answers About COMMERCIAL ADVANCE" in the *Reference* section.

All of the COMMERCIAL ADVANCE features are accessed through the COMMERCIAL ADVANCE menu.

1. Press MENU to display the VCR MAIN MENU.
2. Press 6 to display the PREFERENCES menu.
3. Press 8 to display the COMMERCIAL ADVANCE menu.

```

      PREFERENCES
1 Remote Control: VCR1
2 Auto Play:      ON
3 Auto TV/VCR:   ON
4 EnergySaver:   2:00
5 Front Panel:   AUTO
6 Tape Speed:    SLP
7 Set Auto Repeat
8 COMMERCIAL ADVANCE
0 Exit
    
```

Now you can select one of the COMMERCIAL ADVANCE features.

```

      COMMERCIAL ADVANCE
1 Marking:        ON
2 Playback:       AUTO
3 Display:        Blue
0 Exit
    
```

COMMERCIAL ADVANCE Marking

Press 1 to turn commercial Marking ON or OFF.

- Select ON, and the VCR will mark commercials within approximately 30 seconds for the following types of recording:
 - **Timer, Timer with VCR Plus+, or Express Recording** Sets the VCR to automatically mark commercials after the power is tuned off.
 - **Recording** Allows the VCR to prompt you to mark the commercials when you've stop the recording.
- Select OFF and the VCR will not mark the commercials.

```

The VCR is waiting to
mark commercials in the
program you recorded.

1 Mark them now
2 Mark them later
3 Don't mark commercials

The VCR will begin
marking in 30 seconds...
    
```



VCR Features

COMMERCIAL ADVANCE	
1 Marking:	ON
2 Playback:	AUTO
3 Display:	Blue
0	Exit

COMMERCIAL ADVANCE Playback

Press 2 to switch between Playback: AUTO and MANUAL.

- Select AUTO to have the VCR automatically advance through the blocks of marked commercials.

It works with most 30, 45, and 60-second commercials.

A commercial group starting with the first two minutes or last two minutes of a recording will not automatically be skipped.

A commercial will not be skipped if a recording starts in the middle of a commercial segment, one isolated commercial is shown without others, or a commercial is longer than one minute. Press FWD on the VCR (FORWARD on remote) to scan through the commercial.

Part of a recorded program may be skipped if the program segment is between commercials and less than one minute or there are frequent dark and quiet scenes.

- Select MANUAL and the VCR won't advance through the blocks of marked commercials until you press SEARCH.

To Override Automatic Skipping

If part of the program you've recorded is passed over, you can temporarily override the automatic skipping feature of COMMERCIAL ADVANCE.

1. While the desired portion of the program is being skipped, press the PLAY or STOP button on the remote control or VCR front panel.
2. To view the portion of the tape that was skipped, rewind the tape back to a position before the skipping started using the REVERSE (REV) button.
3. Press the PLAY button to start playback. The portion of the tape will no longer be skipped.

Automatic skipping will be enabled again after the VCR detects the end of the commercial group.

Notes: If you press SEARCH during playback of material other than commercials, the VCR advances to the end of the next "marked" commercial block and resumes playback.

The VCR resumes playback when it reaches the end of the marked commercials.

Timer Recordings and COMMERCIAL ADVANCE

When using Timer Recordings to tape two back-to-back programs on the same channel, you may want to program each show separately so that the beginnings and ends of programs are not automatically skipped by COMMERCIAL ADVANCE.

COMMERCIAL ADVANCE Display

Press 3 to switch between Display: BLUE or VIDEO.

- Select BLUE to display a blue background when the VCR advances through the block of marked commercials.
- Select VIDEO to display the recorded video when the VCR advances through the block of marked commercials.



MOVIE ▶▶ ADVANCE®

MOVIE ADVANCE helps you locate certain parts of prerecorded movies (rented or purchased). This feature works two ways: 1) you can go to the beginning of the movie, or, 2) you can skip from one preview to the next. MOVIE ADVANCE works only on tapes with the safety tab removed recorded in SP speed.

```

MOVIE ADVANCE
What type of tape
is this?

1 Purchased/Rented Movie
2 Home Recording
3 Other

Press CLEAR to cancel
    
```

```

MOVIE ADVANCE

Would you like to go to
the start of the movie
or to the next preview?

1 Go to movie
2 Go to preview

Press CLEAR to cancel
    
```

```

MOVIE ADVANCE

The movie is ready.
Press PLAY to start.

Press STOP to cancel
    
```

```

Searching for preview

Press SEARCH to reverse
Press STOP to cancel
    
```

1. To select MOVIE ADVANCE, insert a tape with its safety tab removed and press the SEARCH button on the remote control.
2. Press 1 if the tape is a purchased or rented movie, press 2 if it's a recording made at home, or press 3 if it's something else, you don't know, or you do not want to select MOVIE ADVANCE.

Pressing 2 or 3 gives the same response and takes you to a different search feature. If you accidentally make a wrong selection, press STOP•EJECT on the VCR (STOP on remote) and reinsert the tape. Press SEARCH.

If you press 1, the MOVIE ADVANCE menu appears.

3. Press 1 to advance directly to the beginning of the movie or press 2 to view the first (next) preview.
 - Press 1 to Go To Movie. The following screen appears with a blue background.

When the movie is found, you will see a message reading *The movie is ready. Press PLAY to start.*

Note: You can press the STOP button to cancel the MOVIE ADVANCE search.

- Press 2 to Go To Preview. The on-screen display will tell you that the VCR is looking for the start of the next preview.

When a preview is detected, the VCR cues it and begins playing.

To Override the Show Previews Mode:

Press the SEARCH button while a tape is being searched.

Pressing the SEARCH button while:

- The tape is reversing will begin searching for the start of the next preview or long commercial.
- The tape is searching forward for the next preview will reverse the tape back to the start current preview.
- The VCR is playing will advance the tape to the start of the next preview, long commercial, or the start of the movie (whichever comes first).

VCR Features

Pro-Tect Plus™ Locking Feature

To protect set timer recordings and to disable the VCR for use, the unit can be locked so that the buttons on the front panel or remote control won't work.

- **To Lock:** Press and hold either the remote control's ON•OFF or VCR button until the front panel display flashes.
- **To Unlock:** Press and hold either the remote control's ON•OFF or VCR button until the front panel display flashes for several seconds. Unlocking is the only way to turn on and use the VCR.

Tracking

Your VCR has automatic tracking which removes streaks and noise from the picture. Automatic tracking is activated when you insert a tape or turn on the VCR. Occasionally you may need to manually adjust tracking, especially if the tape was recorded on a different VCR. Use the TRACKING -/+ buttons on the VCR front panel or remote control to remove streaks and noise. You can also use tracking when pausing a tape to reduce the noise of the stilled picture.

When manually adjusting the picture, automatic tracking is turned off. To turn automatic tracking back on, eject the tape and reinsert it.

Note: Tracking has no effect when recording—only during playback.

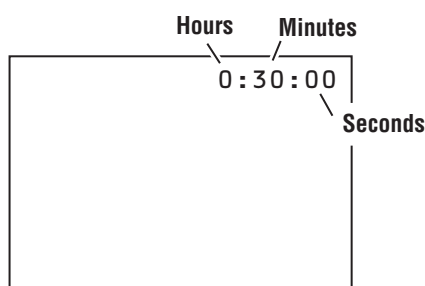

Time Counter

The time counter shows the actual time used when recording or playing back a tape. The time counter helps locate the beginning or end of recorded events. It resets to 0:00:00 whenever a tape is ejected from the VCR.

For example, if you record a 30-minute program at the beginning of a tape, rewind it, and then want to go to the end of the first program to start another recording:

1. Press the INFO button **twice** to display only the time counter.
2. Press the CLEAR button to reset the time counter to 0:00:00.
3. Press the remote control's FORWARD button (FWD on the VCR) to advance a tape until the time counter reads 0:30:00.
4. Press the STOP button. This is the approximate end of a 30-minute program (you may want to press the PLAY button to verify). When the tape is cued correctly, you can begin recording.
5. Press the INFO button to remove the time counter from the screen and return to the normal display mode.

On-Screen Displays

Pressing the INFO button displays the status of the VCR (Stop, Play Record, etc.) as well as the channel number, time counter position, date, time, and tape speed on the TV screen.

Note: The date and time must be set before they can be displayed.

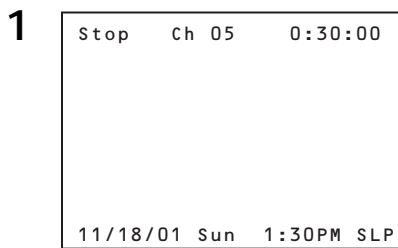

On-screen display (times out)

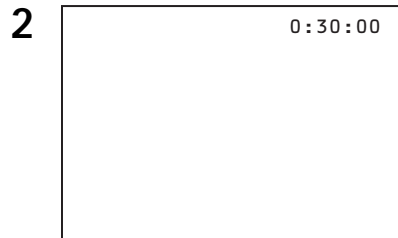

Time counter only (does not time out)



No displays will appear (useful for dubbing)

1. Press the INFO button to show the on-screen displays. The current time is displayed in the VCR's front panel.

2. Press INFO again to have only the time counter remain on the screen. The time counter is also displayed in the VCR's front panel.

3. Press INFO again to have no displays appear on the TV screen. The time counter remains in the VCR's display panel. This is useful for dubbing tapes.

4. Press the INFO button again to return to the normal display. The current time is displayed in the VCR's display panel.

Note: Turning off the VCR also resets the displays.

VCR Features

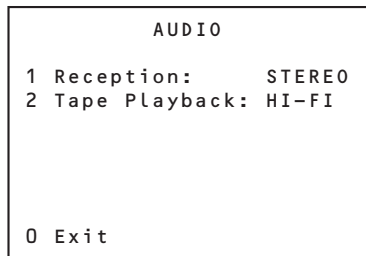

Audio Set-Up Features

Your VCR's audio setup features affect both tape playback and recordings. The features in this section are accessed through the *AUDIO* menu.

To Display the Audio Menu:

1. Press the MENU button to bring up the *VCR MAIN MENU*.
2. Press 7 to choose *AUDIO*.

With the *AUDIO* menu displayed, you are ready to select an item from the menu to set up.

Reception

Some TV programs are broadcast with stereo audio or a Second Audio Program (SAP) which offers a second language. The Reception feature lets you select the type of audio you want to record. Press 1 repeatedly to switch between *Reception: STEREO, MONO, or SAP*.

- **STEREO**– used for normal or stereo broadcast TV recording. The HI-FI indicator lights on the VCR front panel when the VCR's tuned station is broadcasting in stereo.
- **MONO**– used if the stereo signal is weak or the sound is too noisy.
- **SAP**– used to hear/record a Second Audio Program instead of the normal audio on both the Hi-Fi and linear tracks.

Tape Playback

The VCR records the same audio on both the Hi-Fi stereo and linear tracks on the tape. Hi-Fi sound is recorded on separate left and right stereo channels. Monaural sound is recorded on the linear track. In the *AUDIO* menu, press the 2 button repeatedly to switch between *Tape Playback: Hi-Fi, LINEAR, and MIX*.

To enjoy Hi-Fi sound, connect your VCR to a stereo television or amplifier/receiver using the audio jacks. The Tape Playback feature lets you select which audio you play back.

- **Hi-Fi**– use to play back sound recorded on the Hi-Fi tracks and for normal use.
- **LINEAR**– use to play back the sound recorded on the linear monaural track, such as a Second Audio Program, or a dubbed voice-over.
- **MIX**– used to play back the sound recorded on both the linear track and the Hi-Fi track, sound-on-sound. The Hi-Fi indicator lights when MIX is active.

Other Information

Chapter Overview:

- Troubleshooting
- COMMERCIAL ADVANCE Q&A
- Front, Rear, and Display Panel Diagrams
- Specifications
- Care and Cleaning
- Warranty Information
- Finding the TV's Video Line Input
- Advanced Connection Diagram
- Glossary
- Index

Changing Entertainment. Again.





Other Information

Troubleshooting Tips

In this section, you will find answers to common recording, playback, and general VCR questions. Consulting with this section first when there is problem may help you answer common questions.

General VCR Problems

No power

- Check to make sure it is plugged into an operating outlet.
- Check to make sure your connections are correct.

VCR does not respond to the remote control

- Check to make sure there are no objects between the VCR and the remote control.
- The remote control's batteries may need changing.
- You are not in VCR-controlling mode. Press the remote control's VCR button to control it.

There's poor or no picture for normal TV viewing

- Make sure the VCR indicator is off.
- Make sure the TV is switched to an active channel.
- Make sure the antenna connections are secure and correct.

Rewind does not operate

- Check to make sure the tape is not already rewind.

The clock shows an incorrect time or date

- There may have been a power interruption. Reset the VCR's time and date.
- Make sure the clock is set accurately (check AM/PM and date).
- Check the Daylight-Saving setting. The clock may have adjusted for Daylight-Saving Time.
- Time did not adjust for Daylight-Saving time.
- Check to make sure the Daylight-Saving Time feature is set correctly.

The VCR makes noise when stopped

- The VCR is removing the tape from the playheads. This is normal. The head cylinder inside the VCR will continue to rotate for a few minutes after you put the VCR in the stop mode.

Cannot select channels over 69

- Cable channels over 69 can only be selected if *Signal Type: CABLE/ANTENNA* feature is set to CABLE.

TIMER flashes on the VCR front panel display

- The clock is not set.
- Check to make sure there is a cassette in the VCR when a timer recording is set and the power is turned off.

On-screen menus appear in English, French, or Spanish

- Check the LANGUAGE feature for the preferred on-screen language.



Other Information

Recording Problems

Will not record

- Make sure there is a recordable tape in the VCR.
- Eject then reinsert the tape.
- Make sure the tape is not broken.
- Make sure the VCR is not in pause mode. Press PAUSE or PLAY to return to normal playback.
- Make sure the Pro-Tect Plus feature is not active.

A VCR Plus+ system or timer recording was not made or the wrong program recorded

- Make sure the correct PlusCode programming number is entered.
- Make sure the program was entered correctly (the wrong channel or times may be entered).
- Make sure the cable box or satellite receiver was turned on when recording was to begin.
- There may have been a power interruption. Reset the time and date.
- Check to see if time and date are correct – including AM/PM.
- Make sure the program did not exceed the tape's length or that the tape was not rewound beforehand.
- Make sure the VCR was turned off at the time recording started.
- Make sure there was a tape in the VCR with its safety tab intact.
- The VCR ejects tapes when the end is reached during a timer recording.
- Make sure the VCR Plus+ system setup was completed correctly.

Will not record

- Make sure the tape's safety tab is intact.
- Make sure the VCR is not in Video Line Input mode. Press INPUT on the remote control to return to normal viewing.

Playback Problems

Snowy or no picture during playback

- Press the remote control's TV•VCR button to activate VCR-controlling mode. *VCR* appears in the front panel display when active.
- Check the TV channel selected (3 or 4) to make sure it matches the channel selected with CH. 3/4 switch on the back of the VCR.
- Check to make sure the TV's fine tuning is correct for the channel selected.
- If you use A/V cables and jacks to connect the VCR to the TV, check all connections for snug and correct connections.
- Check to make sure the TV monitor is set to Video Line Input (see *How to Find Your TV's Video Line Input* in this section of the manual for detailed information).
- Try another tape.
- Some snow/streaks are normal during search, stop action, frame advance, and slow-motion playback.





Other Information

Streaks in picture during normal playback

- Press one of the TRACKING buttons to move streaks up or down for the best picture.
- Check to make sure the tape is of good quality and not worn out.

Time counter not working or time counter not working in search modes

- The time counter does not advance during unrecorded portions of tape. When an unrecorded segment of tape is encountered, the time counter will hold its count until recorded material is detected again.
- A minus (–) will appear in front of the time if you rewind the tape farther back than a counter reading of 0:00:00.
- The time counter disappears during search; this is normal.

Will not play

- Check to make sure there is a tape in the VCR.
- Try ejecting and reinserting the cassette.
- Check to make sure the tape is not broken.
- Check to make sure the VCR is not in pause mode. Press PAUSE or PLAY to return to normal playback.
- Check the Pro-Tect Plus™ feature.

Will not Auto Channel Search active channels correctly

- Check to make sure the antenna connections are secure and correct.
- Check to make sure the Signal Type: CABLE/ANTENNA feature is set correctly.
- If Detect Automatically was selected for the Signal Type in the AUTO CHANNEL SEARCH menu, try using either CABLE TV or ANTENNA instead.
- May not be necessary if using a cable box for all channels. Contact your local cable company for more information.

Tape plays back in slow motion

- Press PLAY to return to normal playback.

Cassette with safety tab removed does not start to play automatically

- Check to make sure the AUTO PLAY ON/OFF feature is set to ON.

Time counter disappears during searching

- This is normal.

There is no stereo sound during playback

- Make sure the Tape Playback feature is set to *Hi-Fi* to hear stereo sound during playback.
- You must use A/V cables (not provided) and jacks to connect the VCR to the TV (or stereo) to hear true stereo sound during playback.

The stereo Audio is too noisy

- The stereo signal is weak. Set the *Reception: STEREO/SAP/MONO* to *MONO*.
- Press either the TRACKING – or + button to minimize picture noise.



Other Information

Questions and Answers About **COMMERCIAL ▶▶ ADVANCE®**

Will commercials be scanned through only on playback of recordings?

Yes. The VCR rewinds and marks commercial segments after a recording is finished.

How fast does this feature scan through commercial breaks?

In SLP tape speed, a 3-minute commercial break is scanned through in approximately 8-12 seconds. In SP, it takes about 25-35 seconds.

Are commercials still recorded if I want to watch them?

Yes. The recorded program, including commercials, can be viewed by setting the Playback feature to MANUAL.

What if the VCR scans forward through part of my program?

Press PLAY or STOP while the tape is being automatically skipped. rewind the tape back to a position before skipping started, then press PLAY. Automatic skipping will start again after the end of the commercial group is detected by the VCR.

Once a recording has been marked, does COMMERCIAL ADVANCE work each time the tape is played?

Yes. If the Playback feature is set to AUTO, the marked commercials should be skipped each time the tape is played in a COMMERCIAL ADVANCE VCR.

After marking commercials, is the tape left at the beginning or end of the recording?

The tape is left at the end of the recording so it is in position to begin additional programmed recordings.

Does the marking process interfere with other programmed recordings?

No. If two or more recordings are programmed together without sufficient time to mark the first recording, marking will take place after all recordings are completed.

What happens if the marking process is interrupted?

Marking can be interrupted to allow use of the VCR. Marking will resume again when the VCR's power is turned off as long as the tape has not been ejected from the VCR.

Does COMMERCIAL ADVANCE work in all recording speeds?

Yes, COMMERCIAL ADVANCE works in SP and SLP.

Will COMMERCIAL ADVANCE marked recordings work in non-Commercial Advance VCRs?

A COMMERCIAL ADVANCE marked recording will play in a non-Commercial Advance VCR, but commercials will not automatically be skipped.



Other Information

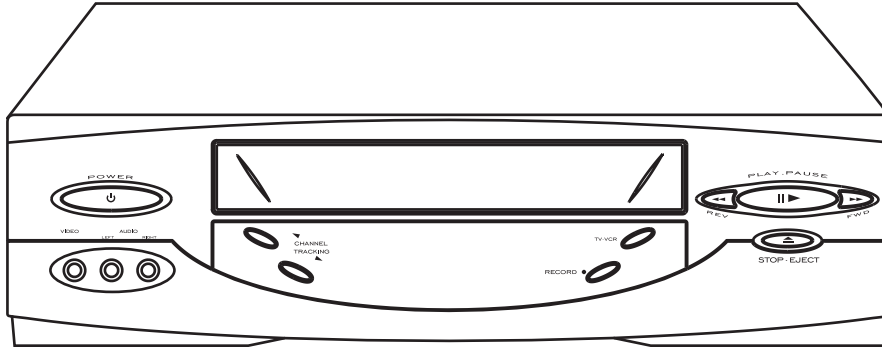

Front Panel

AUDIO (LEFT and RIGHT) and VIDEO In Jacks Receives signals from another component (like another VCR or camcorder) when connected to the VCR using A/V jacks. Use the INPUT button to select L2 to record from these jacks (L1 indicates the rear panel A/V jacks being active).

CHANNEL TRACKING Up and Down Adjusts the image quality by removing picture “noise” and distortion.

FWD Forwards the tape when the VCR is stopped. Searches the picture forward during playback. Starts slow motion during play-pause and increases slow-motion speed.

PLAY•PAUSE Plays a tape. Pauses action for viewing during playback. Pauses recording to prevent recording of unwanted scenes.

POWER Turns the VCR on or off.

RECORD Starts VCR recording. Also used for Express Recording (XPR).

REV Rewinds the tape when the VCR is stopped. Searches the picture in reverse during playback. Starts slow motion during play-pause and decreases slow-motion speed.

STOP/EJECT A single press of this button stops normal VCR functions such as record, playback, rewind, fast-forward, or pause. If pressed a second time, this button ejects an inserted tape.

TV•VCR Switches the picture signal so that it either comes from the VCR or the TV cable/antenna signal.



Other Information



Display Panel

Clock/Counter Displays current time, time counter, tape speed, or channel numbers when switching channels.

FUNCTION DISPLAYS:

dn & Ld (Down and Load) Front panel display alternates between these two words when time data is being downloaded.

REC (Recording indicator) The VCR is recording. REC flashes on the front panel display when a recording is paused.

⌚ (Timer indicator) Displayed when an Express Recording (XPR) or timer recording is under way or when the VCR is set for a timer recording and the power is turned OFF. *TIMER* flashes on the VCR front panel when a timer recording is set and no tape is inserted in the VCR.

VCR indicator Indicates that the VCR is in VCR-display mode. Press the TV•VCR button to toggle between VCR and TV viewing modes.

- VCR indicator is ON when the picture displayed is from the VCR's tuner.
- VCR indicator is OFF when the picture displayed is from the TV's tuner.





Other Information

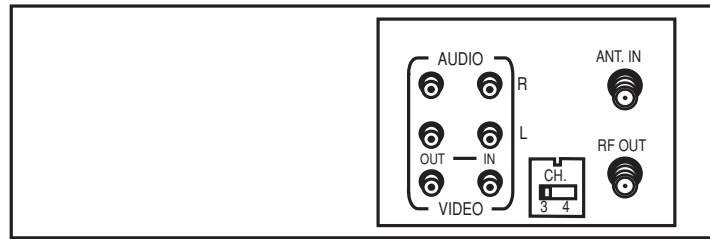

Back Panel

CH. 3/4 switch Determines the channel to which the TV must be tuned in order to see the VCR's picture. Not used when connecting the VCR to the TV using A/V cables.

AUDIO (LEFT and RIGHT) and VIDEO IN jacks Receives signals from another component, such as another VCR or camcorder, when connected to these jacks. Use the INPUT button on the VCR or remote control to select the rear video line input A/V jacks (L1) to record from these jacks.

AUDIO (Right and Left) and VIDEO OUT jacks Sends signals from the VCR to another component, like a TV or another VCR, when the other component is connected to these jacks.

ANT. IN jack Receives a signal from an antenna or cable system when the VCR is attached with RF cables.

RF OUT jack Passes the VCR's signal to a TV using the supplied RF cable.





Other Information

Specifications

Format:	VHS
Record/Playback System:	Video: 4-head Audio: VHS Hi-Fi record/playback system
Video Signal System:	EIA standard: NTSC color
Antenna:	75-ohm external VHF/UHF combined antenna terminal
Tuner:	USA: 181 channels capability* (125 cable channels) Canada: 178 channels capability* (122 cable channels)
Type:	AutoProgramming frequency synthesis
Power Requirement:	120V AC, 60 Hz
Power Consumption:	17 watts (standby < 3 watts)
Dimensions:	3.64 inches high (91 mm) 14.4 inches wide (360 mm) 9.4 inches deep (230 mm)
Weight:	6.4 pounds (2.9 kg)
Other:	Automatic head cleaner
Storage Temperature Range:	- 22°F to +149°F (-30°C to +65°C)
Operating Temperature Range:	+41°F to +104°F (+5°C to +40°C)

*Check your cable company's compatibility requirements.

Cleaning the VCR

Use a soft cloth or dusting attachment of your vacuum cleaner to dust your VCR. Remove dust from the ventilation holes on the top, back, sides, and bottom of the VCR and all connected components.

Plastic surfaces are easily scratched and can be marred by alcohol and various solvents. Avoid excessive use of oil-based furniture polishes since the materials used in the cabinet will accumulate more dust. We recommend using a nonabrasive, antistatic cleaner and polisher. If part of the program is skipped, rewind the tape to the beginning of the skipped program segment and press PLAY.





Other Information

RCA VCR Limited Warranty

What your warranty covers:

- Any defect in materials or workmanship.

For how long after your purchase:

- 90 days for labor charges.
- One year for parts.

The warranty period for rental units begins with the first rental or 45 days from date of shipment to the rental firm, whichever comes first.

What we will do:

- Pay any Authorized RCA VCR Service Center the labor charges to repair your VCR.
- Pay any Authorized RCA VCR Service Center for the new or, at our option, refurbished replacement parts required to repair your VCR.

How you get service:

- Take your VCR to any Authorized RCA VCR Service Center. To identify your nearest Authorized RCA VCR Service Center, ask your dealer, look in the Yellow Pages, or call 1-800-336-1900.
- Show the Authorized Service Center Representative your evidence of purchase date or first rental.
- Pick up your VCR when repairs are completed.

What your warranty *does not* cover:

- Customer instruction. (Your Owner's Manual clearly describes how to install, adjust, and operate your VCR. Any additional information should be obtained from your dealer.)
- Installation and related adjustments.
- Signal reception problems not caused by your VCR.
- Damage from misuse or neglect.
- Cleaning of video/audio heads.
- Batteries.
- A VCR that has been modified or incorporated into other products or is used for institutional or other commercial purposes.
- A VCR purchased or serviced outside the U.S.A.
- Acts of nature, such as but not limited to lightning damage.

Product Registration:

- Please complete and mail the Product Registration Card packed with your VCR. It will make it easier to contact you should it ever be necessary. The return of the card is not required for warranty coverage.

How State Law relates to warranty:

- This warranty gives you specific legal rights and you also may have other rights that vary from state to state.

If you purchased your VCR unit outside the United States:

- This warranty does not apply. Contact your dealer for warranty information.

Service calls which do not involve defective materials or workmanship are not covered by this warranty. Costs of such service calls are the sole responsibility of the purchaser.



Finding the TV's Video Line Input

You need to tune your TV to the video line input if you are using the VCR's Audio/Video (A/V) OUT jacks to connect to the TV's A/V input jacks. You must select the TV's video line input before you can see the VCR's menus, the cable/antenna reception, and the content that's on a tape.

The video line input for TVs varies by brand and model. Below are some steps to try to find your TV's video line input:

- If your TV brand is RCA, GE, or Proscan, press the TV button on the VCR's remote control, then press the INPUT button.
- If you have another brand of TV, see the chapter *Using the Remote Control* to see if the VCR's remote can be programmed to control your TV. If so, once completed, follow the step above.

If those options do not work, try the following ideas. You might access the video line input by:

- Pressing a button on the TV's remote control (see the table below).
- Selecting a specific channel from the TV's on-screen menu system (see the table below).
- Tuning directly to the video line input by selecting a specific channel number (see the table below)
- Going through all available channels by pressing the channel up or down buttons on the TV or its remote control.

Common Video Line Input scenarios:

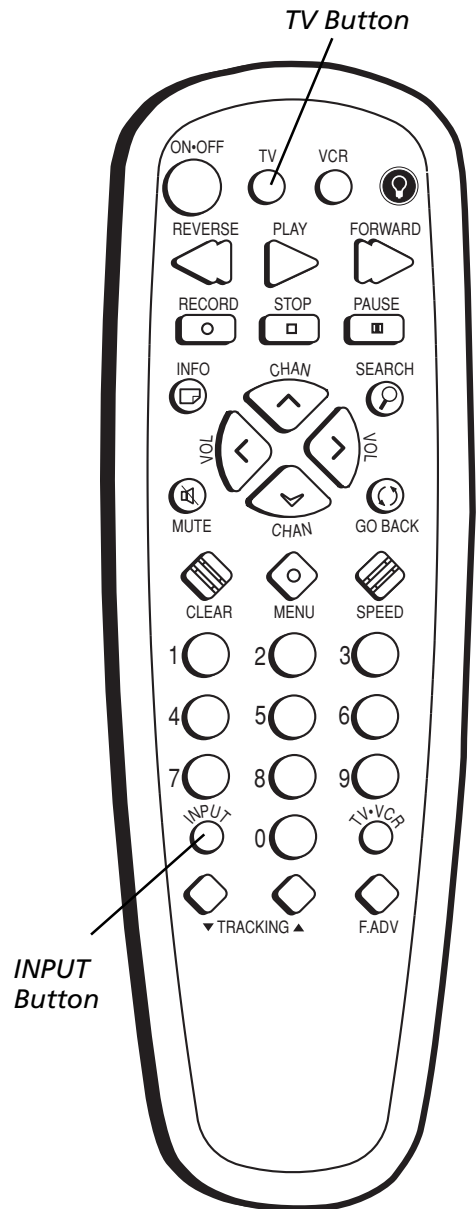

Video Input Channel Variations

Button/Switch on the TV	Button on the TV Remote	Channel Number
VIDEO	VID 1	00
SIGNAL	LINE	90
VID 1	VID	91
VID 2	VIDEO	92
S-VID	S-VID	93
S-VIDEO	INPUT	VID 1
	S-VIDEO	VID 2
	SOURCE	
	AUX	

Other Information

Advanced Connection

TV + VCR + Satellite Receiver

- **Using A/V and RF Coaxial Cables**

Note: Your satellite receiver and television back panels may not look exactly like the models shown here. This connection can also be used for a cable box.

1. Connect the VCR to the TV

- Connect one end of the supplied RF coaxial cable to the RF OUT jack on the back of the VCR and the other end to the TV's antenna input jack.
- Connect the A/V cables. Connect audio cables to the VCR's R and L Audio OUT jacks and the other ends to the TV's corresponding audio input jacks (if your TV only has one audio input jack, use the VCR's L audio jack to connect). Connect one end of the video cable to the VCR's VIDEO OUT jack, and the other end to the TV's video input jack.

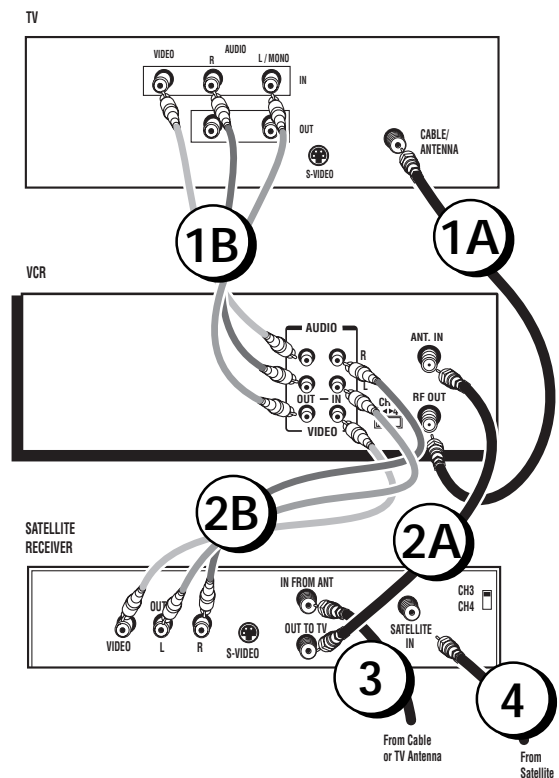

2. Connect the satellite receiver to the VCR

- Connect one end of a second RF coaxial cable (not included) to the VCR's ANT. IN jack. Connect the other end to the satellite receiver's antenna output jack.
- Connect the A/V cables. Connect audio cables to the VCR's R and L audio IN jacks and the other ends to the satellite receiver's audio output jacks. Connect one end of the video cable to the VCR's VIDEO IN jack, and the other end to the satellite receiver's video output jack.

3. Connect a TV antenna or cable feed to the satellite receiver

If you have cable or a standard TV antenna, connect its RF coaxial cable (not included) to the antenna input jack on the satellite receiver.

4. Connect the satellite antenna's cable to the satellite receiver

Connect the satellite antenna's RF coaxial cable feed (not included) to the receiver's satellite input jack.

Note: To hear stereo output from the satellite receiver, you must use the TV's video line input "channel." RF coaxial cable only carries mono sound.



Other Information

Glossary

A/V Jacks & Cables Commonly called “RCA-type” cables. Improves picture and sound quality over RF Coaxial cables. A/V cables are required for stereo audio.

EnergySaver Automatically turns the VCR off after a user-defined period of inactivity.

Express Recording (XPR) A method of timer recording which tapes for a set period of time using 30-minute increments.

Pro-Tect Plus™ Allows the VCR to be disabled so that the front panel and remote control buttons don't work. Useful for protecting timer recordings.

QuickSet Guide An first-time use, interactive, menu-based system that walks you through several setup steps in a series of questions. The QuickSet Guide is also available in the VCR's Main Menu.

SAP (Second Audio Program) A second sound track that may be included with a stereo broadcast. Usually used for foreign language dubs of programs.

VCR Channels List The active list of channels available to the VCR using the CHANNEL +/- buttons.

XPR See *Express Recording* above.



Index

A

ADD/REMOVE CHANNELS screen 18
 Audio features, set up 46
 AUDIO IN jacks 58
 AUDIO menu 46
 Audio/Video (A/V) jacks 17, 52, 54
 AUDIO/VIDEO jacks 26
 Auto channel search 17
 Auto clock feature 19
 Auto play feature 13, 21
 Auto TV/VCR feature 22
 Automatic rewind 13
 Automatic tracking 13, 44

B

Back panel jacks 54
 Basic recording 13
 Batteries (remote control) 11
 Broadcast stereo TV recording 38

C

Cable box setup 16
 Cables
 positioning 6
 CHAN buttons 27
 CHANNEL buttons 17, 26
 Channels, adding/removing 18
 CHANNELS menu 16, 18, 35
 CLEAR button 26, 27, 40
 Clock display 53
 COMMERCIAL ADVANCE 41
 Display 42
 Marking 41
 Playback 42
 questions and answers 51
 Component buttons 26
 Connections 8
 Controls
 back panel 54
 front panel 52
 Copying tapes 38

D

Date and time setting 19
 Design specifications 55
 Display panel 53
 Displays, on screen 45

E

EJECT button 13
 EnergySaver feature 22
 Express Recording (XPR) 2, 32

F

F. ADV button 26, 39
 FORWARD button 13, 39
 Frame advance 39
 Front panel controls 52
 FWD button 38, 39, 44

G

Glossary 59
 GO BACK button 26, 27

I

Index search 40
 Indicators in display panel 53
 INFO button 26, 27, 44
 INPUT button 27
 INPUT button 26, 33, 38, 57

L

L1 indicator 38
 L2 indicator 38
 LANGUAGE menu 16
 Locking feature 44

M

MENU button
 16, 26, 33, 35, 41, 46
 MOVIE ADVANCE
 Overriding 43
 Movie Advance 43
 MUTE button 27

N

Number buttons 20, 26, 27

O

OFF button 26, 27
 ON•OFF button 44
 On-screen displays 45
 Overheating 6

P

PAUSE button 13, 27, 38
 Picture search options 39
 PLAY button 13, 27, 38
 PLAY/PAUSE button 39
 POWER button 13
 Power surges 6
 PREFERENCES menu 21, 41
 Pro-Tect Plus locking feature 44

Q

QuickSet guide 16

R

REC display 53
 Reception: STEREO/MONO/SAP
 feature 38, 46
 RECORD button 13, 27, 32, 38, 52



Index

Recording
 basic 13
 broadcast stereo TV 38
 copying /editing tapes 38
 Express (XPR) 2, 32
 SAP 38
 speeds 23
 timer 33

Remote
 component buttons 26
 TV function buttons 27

Remote, batteries 11

Removing/adding channels 18

REV button 27, 38, 52

REVERSE button 13, 39

Reviewing timer programs 33

Rewind, automatic 13

RF OUT jack 54

S

Safety tab 13, 21

SAP 38

Search

 forward 39

 reverse 39

SEARCH button 27, 40

Set up

 auto play feature 21

 auto TV/VCR feature 22

 cable box 16

 Daylight-Saving 20

 front panel 22

 language feature 16

 PREFERENCES menu 21

 tape speed feature 23

 time and date 19

 time zone 19

 using menu system 16

Signal type

 changing 18

 selecting 18

Slow motion 39

Specifications 55

Speed

 SLP 23

 SP 23

SPEED button 13, 23, 27, 32

Speeds, recording 23

STOP button 13, 27, 32, 38, 52

T

Tab, safety 13

Tape eject 13

Tape playback feature 46

Tape playback: HI-FI/LINEAR/MIX
 46

Tape speeds 23

Time and date 19

Time counter 44

Time counter display 45

Time display on TV 45

TIME menu 19

Time setting

 Daylight-saving 20

 set time zone 19

Timer programs

 clearing 33

 reviewing 33

Timer recording 33

 stopping 33

TRACK buttons 27

Tracking 44

TRACKING buttons 13, 39, 44

Troubleshooting 48

TV button 26, 57

TV function buttons 27

TV•VCR button 22, 27, 38

V

VCR

 connecting 8

VCR button 26

VCR function buttons 26

VCR indicator 38, 53

VCR MAIN MENU 16, 19, 46

VCR Plus+

 channel lists 36

 channel worksheet 37

VCR Plus+ SILVER System 34

VCR Plus+ System Worksheet 37

VCR viewing channel 11, 13

Video Input Channel 57

VOL buttons 27



Please do not send any products to the Indianapolis address listed in this manual or on the carton. This will only add delays in service for your product.

Thomson multimedia Inc.
10330 North Meridian Street
Indianapolis, IN 46290

©2001 Thomson multimedia Inc.
Trademark(s)® Registered
Marca(s) Registrada(s)
Printed in Korea
TOCOM 15708270

